

12-1-2000

BS News

Follow this and additional works at: <https://arrow.tudublin.ie/bsn>

 Part of the [Civil Engineering Commons](#), [Construction Engineering Commons](#), and the [Construction Engineering and Management Commons](#)

Recommended Citation

(2000) "BS News," *Building Services News*: Vol. 39: Iss. 10, Article 1.

doi:10.21427/D7WH73

Available at: <https://arrow.tudublin.ie/bsn/vol39/iss10/1>

This Article is brought to you for free and open access by the Journals at ARROW@TU Dublin. It has been accepted for inclusion in Building Services News by an authorized administrator of ARROW@TU Dublin. For more information, please contact yvonne.desmond@tudublin.ie, arrow.admin@tudublin.ie, brian.widdis@tudublin.ie.



This work is licensed under a [Creative Commons Attribution-NonCommercial-Share Alike 3.0 License](#)

BSNews

DECEMBER 2000

MECHANICAL & ELECTRICAL BUILDING SERVICES

REFRIGERATION INDUSTRY

Protecting the Air
that we Breathe

◆ Refrigeration — 20-page special

◆ Radiators — 13-page special

◆ Underfloor Heating

Innovation in Pumping Technology

Wilco-MVi and MHi range

This range of Stainless Steel Vertical and Horizontal Multistage pumps are suitable for water supply and pressure boosting duties, sprinkling, irrigation, high pressure wash, fire protection and water treatment (de-mineralisation, filtering).

■ Water Supply

■ Boosting

■ Sprinkling

■ Irrigation

■ High Pressure wash

■ Fire Protection

■ Water Treatment

■ Boiler Feed



WILO

WILO ENGINEERING LTD
Enterprise Centre,
Childers Road
Limerick, Ireland

Tel: 061-410963
Fax: 061-414728
E-mail: sales@wilo.ie
Internet: www.wilo.com

BSNews*

MECHANICAL & ELECTRICAL
BUILDING SERVICES

ISSN 0791-0878

Published by:

Pressline Ltd,

Carraig Court,

George's Avenue,

Blackrock, Co Dublin.

Tel: 01-288 5001/2/3 Fax: 01-288 6966

ISDN: 01 - 211 2338/9

eMail: bsnews@pressline.ie

Editor: Pat Lehane

Advertisement Manager: Joe Warren

General Manager: Ediel Burke

Origination and Design:

Pressline Ltd. Tel: 01 - 288 5001

Description: One Year — £30

Printed by: Kilkenny People.

© All editorial contents and all advertisements prepared by the publishers, Pressline Ltd.

* Incorporating Irish Heating & Ventilating News.

Readership Data

Irish Building Services News (formerly Irish H&V News) is Ireland's only Building Services magazine providing coverage of heating, ventilating, air conditioning, refrigeration, sanitaryware, plumbing, maintenance and environmental industries. It is the only publication catering exclusively for these industries and its circulation includes members of the following:-

Chartered Institution of Building Services Engineers (CIBSE); The Mechanical Engineering & Building Services Contractors'

Association (MEBSCA); The Association of Consulting Engineers of Ireland (ACEI); The Mechanical Engineering Contractors' Association; The Institute of Domestic Heating Engineers (IDHE); The Registered Heating Contractors Association; The Maintenance, Energy & Environmental Technology Association (MEETA) which incorporates energy managers and maintenance managers; The Energy Conservation & District Heating Association; The Institute of Plumbing; The Irish Home Builders Association (IHBA); Builders Merchants/Trade Supply Outlets; Irish Property & Facilities Managers Association.

In addition, Irish Building Services News circulates to independent building services contractors and key executives in industry. Government, Semi-State and local authority bodies. Essentially, our circulation is virtually saturation coverage of all those with an interest and/or involvement in the industry.

Ventilation Association — Refrigeration Skillsnet Shows it Can Be Done!

When the idea for the Ventilation Association was first proposed, the primary objective was to raise the standard of knowledge, Regulation compliance, and general awareness within the industry and thereby effect a more professional approach to projects, especially at the installation stage.

Now that the Association has been established, the name registered and a steering Committee elected, the intention is for all paid-up members — there are 50 at present — to meet early in the new year to move forward. Those who have not yet joined are also welcome to attend and should call 01 - 288 5001 so that their names can be included on the letter of notification *vis a vis* time and venue.

In the meantime everyone should read of the progress made in the refrigeration sector (page 18 of this issue) under the aegis of the Refrigeration Technology Skillsnet programme initiated by DIT Applied Technology Services.

Just like refrigeration, the biggest gap in relation to ventilation is training. The Refrigeration Skillsnet programme proves that, with the determination and involvement of the industry, it is a matter which can be addressed. A successful model now exists ... all the ventilation sector has to do is adopt it to suit its particular needs.

We wish all our readers and advertisers a very happy and peaceful Christmas and a prosperous new year.

IN THIS ISSUE

News	2
Underfloor Heating — A Viable Alternative	8
RACGS Golf	12
CIF Cork Supplier of the Year & Trade Person of the Year	14
Plan Expo Award for NCRL	16
Refrigeration — Skillsnet the Way Forward	17
Radiators — Sharp Increase in Sales	37
ISH to feature Bathrooms & Accessories for the Disabled	52

Thermo Systems Appointments

Thermo Systems has made two senior appointments to underpin the successful launch of its partnership with Johnson Controls Systems into the building management systems and energy control market.

Gary Youd is assuming the position of Controls Systems Sales Manager while



Gary Youd



Brendan Meyler

Brendan Meyler takes up the position of Applications Engineer.

Gary and Brendan bring extensive experience of controls systems, engineering, applications validation, and handover from a wide array of projects.

Contact: Gary Youd/Brendan Meyler, Thermo Systems. Tel: 01 - 493 1701.

Subscribe to BSNews if you want to keep abreast of all that is happening in relation to Ireland's building services industry.

Contact: 01 - 288 5001 or email: bsnews@pressline.ie

Flue Dilution Fans

Airflow Developments' flue dilution fans — Series GBDF and SSDF — are high-powered flue dilution fans which allow flexible siting of gas boilers rated between 80 and 650kW input.

The concept of diluting the products of combustion from gas-fired boilers is now well established; by diluting the CO₂ content of the products of combustion down to 1%, they can be safely discharged at low level. The main advantage is the avoidance of unsightly flues.

The 1% CO₂ will be met by selecting the correct fan for the boiler input rating and the recommended flue duct layout. The fans introduce fresh air into the boiler's discharge

flue duct, thus diluting the flue gases.

Airflow Developments' range of flue dilution fans meets the needs of the majority of installations. Five sizes are available for industrial and commercial boilers rated up to 650kW (2,200,00 Btu) input. Each size is available in standard form (GBDF series) for atmospheric boilers and water heaters of around 75% efficiency.

Enhanced corrosion-resistance (SSDF series), with stainless steel fan cases, are also available for installation where regulations or the specification call for stainless steel ducting, and when higher efficiency boilers such as modular designs are likely to produce condensation.

Contact: Jim Bollard, Dan Chambers Ventilation.
Tel: 01 - 830 3222.



Airflow Developments flue dilution fans from Dan Chambers Ventilation

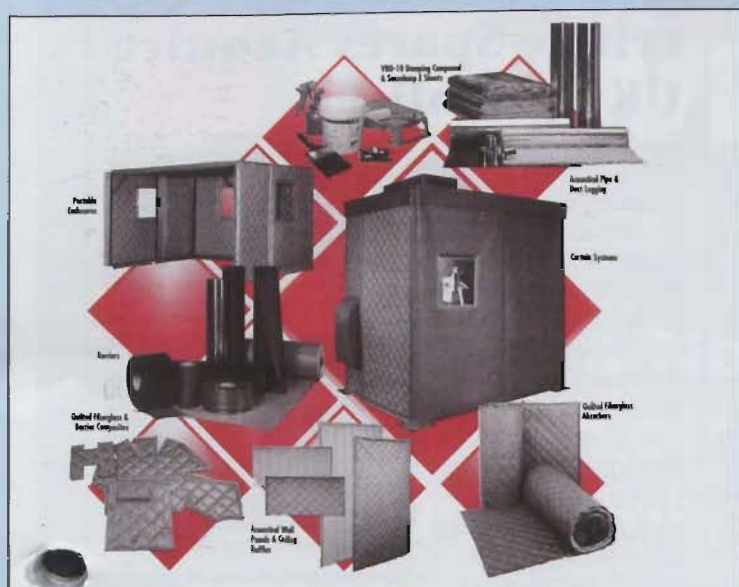

Noise Control Solutions:

- Industry
- OEM Applications
- Construction

All products made to order and tested on site in our laboratory



NCRL Laboratory, Dublin

Architectural Wall Panels

Signature panels are lightweight, colourful, class 'A' fire-rated and are available in a variety of models, sizes and fabric selections. Signature panels can be installed easily with a combination of impaling clip and adhesive.



Signature panels are designed as the solution for areas that require noise reduction or reverberation control. There are more than 4000 different Guildford patterns to choose from. All panels are manufactured to order.

Merriott Makes its Mark on the Web

One of Europe's largest manufacturers of designer radiators has launched a new website which provides heating and interior design professionals with a comprehensive point of reference for its impressive product range.

Specially designed to offer rapid and accurate navigation, the new site — at www.merriottradiators.com — details the complete range of Merriott products including LSTs, towel rails, column radiators, horizontal panels, low line radiators and vertical panels.

High-quality images of the radiators are combined with numerous technical catalogues which provide fully-detailed information to aid both the selection and specification processes. The technical catalogues can also easily be viewed on-line, or downloaded as a zip file.



High-quality product images, free software and downloadable technical catalogues all feature on the newly-launched website from Merriott Radiators

Also available for download is Merriott's own heatloss calculation software which greatly simplifies and speeds up the process of specifying an ideal heating system for any application. Easy to operate and entirely free, this Merriott software saves both time and money.

Background information on Merriott's position as a market leader is also featured on the site, including details of the company's commitment to quality control, state-of-the-art manufacturing facilities, and bespoke design service.

More features — such as profiles of recent successfully-completed projects — will be added to the site in the coming months. Be sure to add www.merriottradiators.com to your list of favourites for a return visit.

Contact:
Frank Donohoe,
Merriott Radiators.
Tel: 01 - 459 6213.

Fridge Spares Acquire UK Specialist

Fridge Spares, Ireland's leading refrigeration wholesaler, has acquired Refrigeration Parts Wholesale (RPW), a well-established multi-outlet refrigeration wholesaler in the UK. This is a significant development for the Dublin-based company and *BSNews* asked if it meant a change in direction for the business.



Dermot Byrne, Managing Director, Fridge Spares

"Absolutely not", says Managing Director Dermot Byrne. "Of course it is a milestone development for us but, having re-structured and consolidated our position on the home market, we're conscious that to continue to serve our Irish customers with the same professionalism and efficiency, we need to be able to compete with the larger market players. So we have to grow.

"We could do this by forming a partnership with like-minded companies, or by acquisition. Fortunately, we're in a position to go the latter route and thereby retain total control. The addition of RPW as a wholly-owned subsidiary adds enormous strength to Fridge Spares. Apart from larger turnover and increased profits, we now enjoy even greater purchasing strength. This will undoubtedly benefit our Irish customer base.

"As for RPW itself, this is a long-established firm with a wealth of experienced staff, numbering 40 in all, and a network of 11 separate branches. It has been trading successfully and profitably since 1984 and our intention is to build on that position. Through Fridge Spares it now has direct access to market-leading brands such as Friga-Bohn, Prestcold and Tecumseh, along with our own-manufactured multi compressor pack systems, specialist condensing units, and electrical panels.

"While a wholly-owned subsidiary, it will continue to function as a stand-alone business. The intention is to broaden the branch penetration throughout the UK while making the product portfolio more comprehensive. It is already very strong in refrigeration parts and we will now establish a similar standing for it in the capital equipment sector."

Contact: Dermot Byrne, Fridge Spares.
Tel: 01 - 830 3466.



**Europe's No1 manufacturer
of warm air heating
equipment**



**Ex-stock availability direct
from the manufacturer**



**Comprehensive
sales, service
and spares
support**

Powrmatic Ireland

45 Broomhill Close · Tallaght · Co Dublin

Tel: 01 452 1553 Fax: 01 452 1764

Web: www.powrmatic.com/uk E mail: uk@powrmatic.com



**WARM AIR CABINET HEATERS
SUSPENDED GAS UNIT HEATERS
CALECON DESTRATIFICATION FANS
SIME COMMERCIAL BOILERS
SYSTEM FLUE & CHIMNEY PRODUCTS
POWERED & NATURAL VENTILATION**

TRADE NEWS

Powrmatic Duct Heater Modules

Powrmatic duct heater modules are slim-line, gas-fired heater units designed specifically for use in air handling equipment.

The unique design in the heat exchanger and burner technology offers a slim-line unit with proportionally high heat output and up to 7:1 turn down ratio.

The finished product is ideally suited to new air handling equipment, but due to its physical dimensions it also offers a real solution for the conversion of hot water, steam, or electric heater units in existing plant to gas.

The DHM, although relatively new, has been successfully installed as part of the air handling package in a number of prestigious projects. The benefits of physical size, control, reduced purchase and manufacturing costs for the air handling equipment OEMs has resulted in many enquiries for new business.

Combustion efficiency and emissions comply with current European guidelines. The 7:1 turn down ratio offers greater control and with it fuel saving.

The DHM offers less restriction to airflow than conventional units allowing the use of smaller main fan motors.

DHM provides air handling equipment OEMs with a real solution to heating in terms of physical size, efficiency, control and cost.

Contact: Patrick Lowry, Powrmatic Ireland.
Tel: 01 - 452 1533.



Features such as digital timeswitch, hinged front cover, the facility to connect to a standard conduit box or wall box, and new speed push-fit electrical connections make Powrmatic's powrtrol a must for any air heating application

Season Control Opens Galway Branch

Season Control has opened a Galway Area Branch on a joint venture basis with Colin Ferguson of Nationwide Installations, together with Donal Leonard. The branch will operate from a 4,000 sq ft premises at Station Road, Ballinrobe, Co Mayo, and will serve all of the West of Ireland. It will operate on a similar basis to the Cork office, with

significant ex-stock availability across the entire range. Season Control's John Kennedy stated: "The opening of this branch shows our continued

commitment to the mechanical services industry in the West of Ireland. We intend to make further announcements in the near future of other expansions similar to the Galway area, and Cork models".

Colin Ferguson stated: "We are very excited at the future

prospects for growth in the West of Ireland and look forward to supplying our customers needs in the mechanical services industry".

Contact: Colin Ferguson/Donal Leonard, Season Control.
Tel: 092 - 41505.



Season Control's Charlie Glass, John Kennedy and Anthony Kelly with Colin Ferguson and Donal Leonard

FÖHN

Oil or gas-fired high output cabinet air heaters 30-415 kW



ECOFAN
Recirculation/ventilation
destratification unit

Mark Éire BV, Coolea, Macroom, Co Cork.
Tel: 026 - 45334; Fax: 026 - 45383

INFRA LINE

Suspended flexible radiant heating system 50-100 kW

INFRA

Suspended radiant heaters 12-32,4 kW

TANNER

Indirect hot water, steam or thermal oil fueled air heater from 7.5-87 kW

ECOFAN

Reduces by recirculation the temperature difference between the roof and the floor

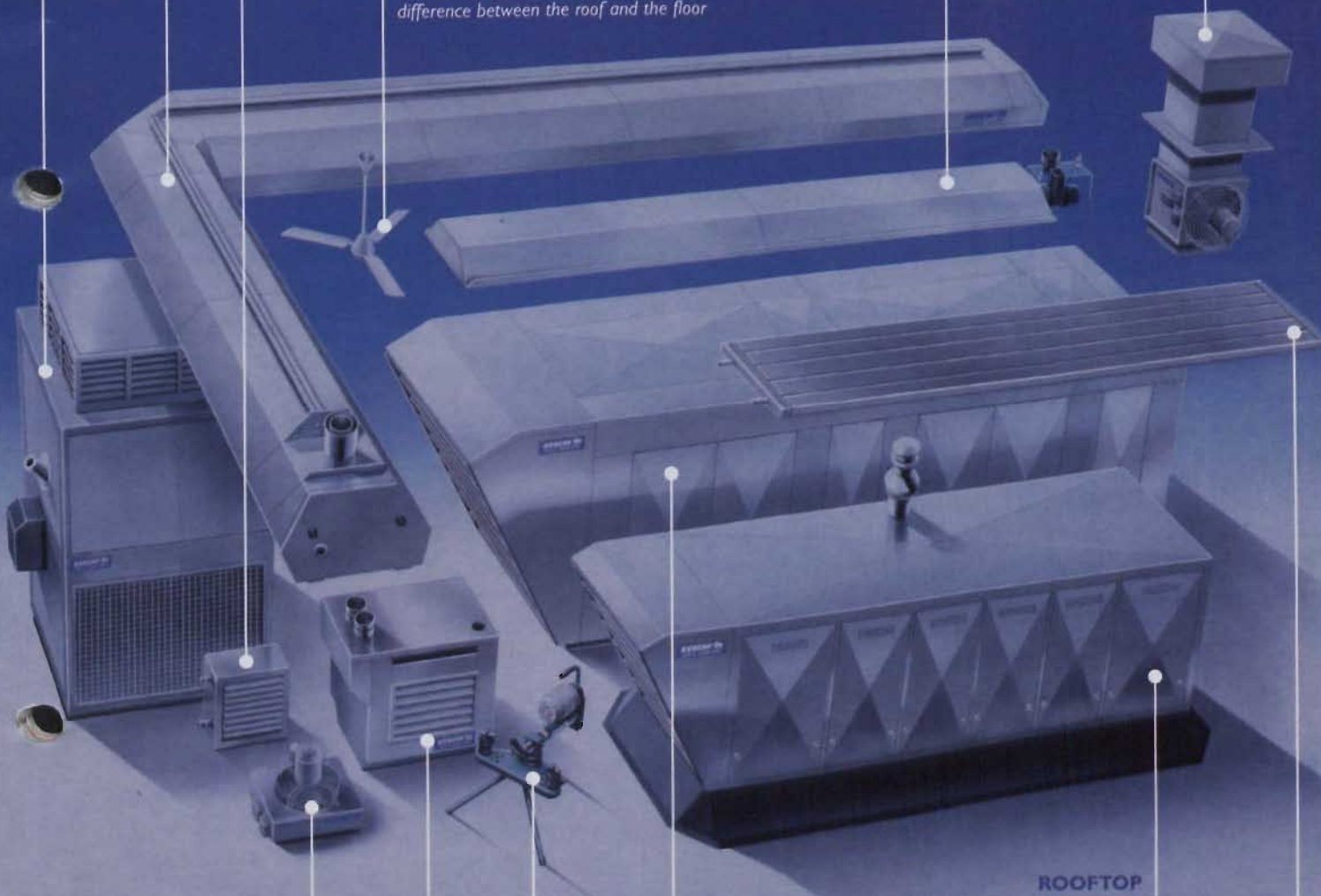

ECOFAN

Reduces by recirculation the temperature difference between the roof and the floor

ROOFTOP

Direct gas-fired air heater, with atmospheric burner and centrifugal fan; 20-370 kW, bigger capacities are available on request

CALFLO

Direct gas-fired make up air heater, with a fully modulating burner with 100% efficiency; 71-996 kW

GS

Direct gas-fired air heater with atmospheric burner and axial fan; 20.4-95.8 kW

GC

Direct gas-fired air heater with atmospheric burner and centrifugal fan; 20.4-95.8 kW

G

Direct gas-fired duct heatexchanger module with atmospheric burner; 20.4-95.8 kW

INFRA AQUA

Flat radiant panels for ceiling suspension; capacities are available on request

PIPE BENDER

The pipe bending machines bends everything up to 4" both manually or electrically operated machines available

Waterproof Differential Pressure Transmitters



Dwyer Instruments' weatherproof differential pressure transmitters from Manotherm

Dwyer Instruments' Series 616W differential pressure transmitters from Manotherm are now available in an expanded line of 34 models, half of them with LCD readouts for on-site troubleshooting, and covering factory-calibrated ranges down to 0 - 2" w.c. and up to 0 - 100 psid. These CE-approved units, which sense the pressure of air or compatible gases with $\pm 0.5\%$ F.S.O.

accuracy, are enclosed in weatherproof, polycarbonate cases, rated IP66/NEMA 4X.

Versatility is inherent in the circuit design for these transmitters, allowing for operation in 2, 3, or 4-wire loops. Their 4-20 mA output signal supports simultaneous operation of a variety of devices, such as an analog panel meter, a chart recorder, or process controlling equipment.

Easy to install, these transmitters have barbed, dual-sized pressure connections to accommodate either 1/8" or 3/16" (3.2mm or 4.8mm) I.D. rubber or vinyl tubing.

Contact: Bob Gilbert/Brian Harris, Manotherm.
Tel: 01 - 452 2355.

Fennelly Appointed MD

Consulting engineering firm Malone O'Regan has appointed Liam Fennelly as Managing Director to head up the development of the firm's 50-strong engineering and development team deployed in Dublin and Waterford. Mr Fennelly is a chartered engineer and joined Malone O'Regan in 1987, since when he has overseen a range of large scale projects in the areas of civil and structural engineering, project management and environmental consultancy.



'Wire Free' Control system for Underfloor Heating

Water-borne floor heating is being used more and more, especially in newly-built homes, offices, hotels and public buildings.

There are several obvious reasons why this is so. Compared to radiators, floor heating gives the following advantages:

- Ideal distribution of heat throughout the room;
- The temperature can be reduced to 1-2° because the feet are warmer;
- The absence of radiators means more flexible furniture arrangements;
- No maintenance;
- No draughts and less dust.

Floor heating is distributed and controlled either locally or through a centrally-placed manifold and control unit. Previously there was a considerable disadvantage, in that wires had to be installed between all room thermostats and the control unit.

With the new Danfoss system of floor heat control, installation is

just as reliable but much simpler. Instead of cables, communication is by radio waves. This also means that the room thermostats can be placed almost anywhere; installation is not just easier, it is less expensive. It also means that the installer can set up advanced floor heating controls without the preconditions associated with conventional systems.

The individual components are housed in enclosures of modern and discreet design that blend into most surroundings.

The system has been approved by the telecommunication authorities and causes no interference with other radio-controlled equipment, and because each room thermostat has its own unique ID code, the new system from Danfoss cannot receive messages from other equipment, irrespective of the transmitting frequencies they use.

Contact:
Brian F Maguire, Ole Thygesen, Danfoss Ireland Ltd.
Tel: 01 - 626 8111;
Fax: 01 - 626 9334;
email: marketing@danfoss.ie

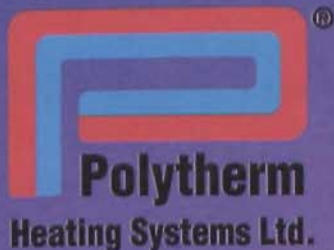

- No Radiators, More Space
- Clean, Healthy Living
- Greater Energy Efficiency
- Silent Running
- No Cold Spots
- Dust-Free Environment
- 10-Year Guarantee

Residential and Commercial Underfloor Heating Systems

UNDERFLOOR HEATING

Polytherm Heating Systems

Polytherm Heating Systems Ltd, one of the leading underfloor heating specialists in Ireland today, was set up to cater for the ever increasing demand for underfloor heating. Polytherm is an associated company of Hevac Ltd, who has over 25 years experience in industrial, commercial and residential heating systems. The Polytherm System is based upon German

comfort. The temperature in each room can be controlled by programmable room thermostats.

Polytherm floor heating systems are becoming increasingly popular. This is not surprising when one considers that these modern low-temperature systems are based on more than 20 years experience. Economic, ecological, aesthetic as well as

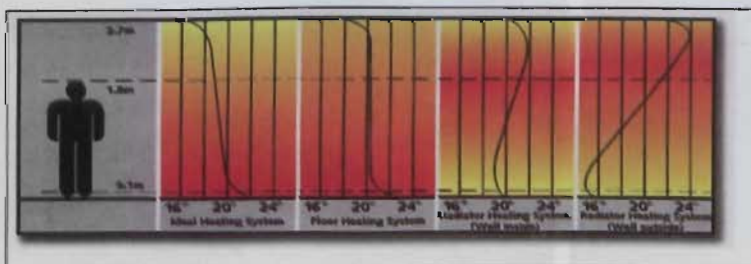

technology and experiences over many years and has achieved every possible accreditation and Standard for Quality.

The principle of underfloor heating is quite simple. It involves circulating warm water through Polytherm cross-linked polyethylene (PEX) pipes with an oxygen barrier. The pipes are installed within the floor in accordance with a pre-designed CAD layout to ensure the maximum heat

health-related aspects strongly favour these long-life, low-maintenance heating systems. In private houses, churches, libraries, offices, factory floors, nursing homes, historic buildings as well as outdoors. They provide heat for exotic animals in the zoo and help vegetables grow more rapidly. There are next to no limits for the application of Polytherm floor heating systems.

Some like it hot

A nearly ideal temperature profile is obtained with a Polytherm floor heating system. Heat is generated exactly where it is required most, being distributed evenly over the height of the room. With no excessive heat in the head or floor area, the healthy, uniform room climate ensures perfect comfort. Whether for old or new buildings – a Polytherm floor heating is the right choice. Regardless of whether you have parquet, carpet, marble or tiles, the Polytherm systems can be installed under any floor covering approved for floor heating systems. If you take into account all the cost-saving advantages, a Polytherm floor heating system compares economically very favourably with the more conventional radiator system of heating.

Building in the heating system
It has to be said that Polytherm underfloor heating is the ideal form of heating to use in low energy buildings. The low temperature demand suits the system and in connection with up-to-date heat generators, for example, an energy-saving,

environmentally-safe condensing boiler, economic and ecological consideration may be combined in an optimal way.

Building a better environment

Polytherm floor heating systems are operated with energy-saving low-temperature technology. Since the entire floor serves as a heating surface the Polytherm System requires a low heating water temperature. On average approximately 40°C instead of 60°C. Because the heat distributes evenly from the floor throughout the room, you feel as comfortable at a room temperature of 20°C as in a room heated with a conventional systems at 22°C. All things considered, this equates to a double saving effect. The personal heat perception also contributes to lowering costs, because a room temperature lowered by 1°C creates up to 10% energy saving. Responsibility for the environment is one of the most important principles set by Polytherm to guide all of its entrepreneurial activities. This starts with the provision of environmentally-sensitive products such as CFC-free system panels.

UNDERFLOOR HEATING

Making environments less allergenic

A healthy climate allows for a healthier life. Polytherm floor heating systems draw off moisture from the floor area (a dry floor is the most inappropriate habitat for all allergens such as household mites, fungus spores and bacteriae). In addition, the system voids dust from being swirled, thus making life considerably easier for those suffering from allergies and/or asthma.

Fuelling architects imaginations

Unobstructed views through the room without any interfering, space-consuming radiators floor heating systems offer design options to interior decorators under optimum utilisation of the space available. This factor is a good reason for incorporating Polytherm into planning activities right from the start, from the individual family dwelling to large scale projects.

Who to talk to

In order to ensure a prompt response to

enquiries, Polytherm Heating Systems Ltd have their own in-house design team who will provide full quotations, CAD designs and technical assistance. They can also recommend competent installers.

Contact: Polytherm Heating Systems.
Tel: 01 - 830 1211;
Fax: 01 - 830 1996.

The great advantage of the Polytherm floor heating system is the simple time-saving installation with the system components of edge insulation strip, panels and PE - Xc pipe. Not more than three working steps are required and the Polytherm floor-heating system is all set and ready for screed laying



“Wire Free” Control System for Under-Floor Heating

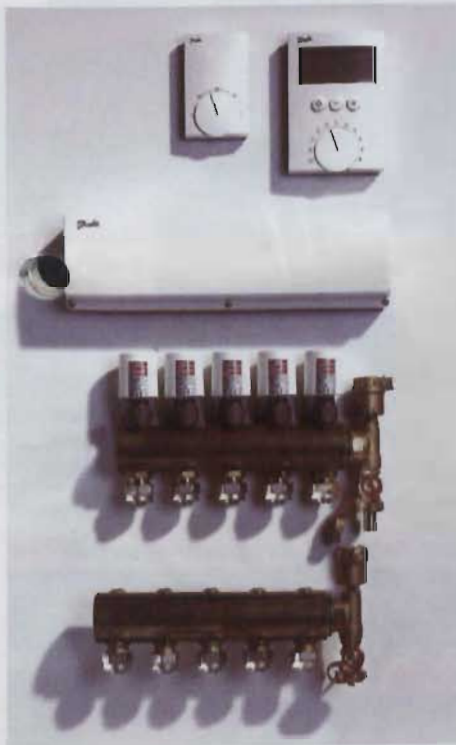

Using the Danfoss CFM Master Controller, the ABN-NC Thermal Motors modulate and control the flow through the manifold based on the CFR radio frequency Room Thermostat.

- ✓ Controls up to 12 circuits at any one time.
- ✓ Simple to install & control
- ✓ Change-over switch for night setback operation.
- ✓ Built-in battery back-up system in the event of power failure.
- ✓ “Wire free” Room Thermostat control is aesthetically pleasing, user friendly, simple to operate and an ideal control solution for heating applications (i.e. offices, domestic home/apartment, guesthouses, schools, nursing homes, etc).

Danfoss Ireland Ltd

Nangor Road Business Park, Dublin 12.
Tel: 01 - 626 8111; Fax: 01 - 626 9334
EMail: sampson@indigo.ie

Danfoss – Insist on them by name!

Christmas in RACGS!

The recent RACGS Christmas outing at Royal Dublin marked the conclusion of a very exciting and competitive few months for members who, despite the appalling weather of late, still managed to get in quite a number of outings. While all undoubtedly enjoyed their golf, Martin O'Conner obviously had the best of all worlds, emerging as the overall RACGS Golfer of the Year, in addition to winning the Danfoss matchplay Trophy. Congratulations Martin. The accompanying picture parade shows Martin receiving both trophies, along with some of the other prize winners.



Pic A

Danfoss Matchplay Trophy — Martin O'Connor, winner, receiving his trophy from John Sampson, managing director, Danfoss Ireland

Pic B

Danfoss Matchplay Runner-up — Eamon Murphy, runner-up, receiving his prize from John Sampson, Managing Director, Danfoss Ireland

Pic C

RACGS Golfer of the Year — That man again, Martin O'Connor, receiving his trophy from John Sampson, Captain, RACGS

PIC D

RACGS Christmas Outing — John Sampson, RACGS Captain, with Tim French

PIC E

RACGS Christmas Outing — John Sampson, RACGS Captain with Michael McLoughlin

PIC F

RACGS Christmas Outing — John Sampson, RACGS Captain with Liam Hoctor

PIC G

RACGS Christmas Outing — John Sampson, RACGS Captain with Michael Nolan

VENTAC

** Air Management Engineers **

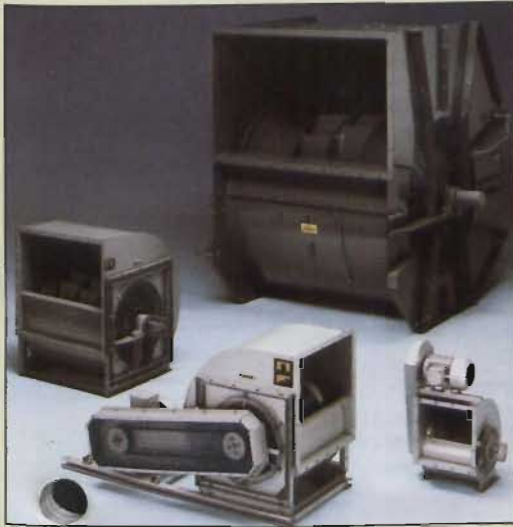

Smoke Exhaust Fan 400° - 2 hours

- ◆ Fans — Axial, In-Line & Centrifugal
- ◆ Gas-fired Air Conditioning Units
- ◆ Grilles, Diffusers, Louvres & Valves
- ◆ Fire Dampers
- ◆ Volume Control Dampers
- ◆ Controls
- ◆ VAV Units
- ◆ Fan Coil Units — Water & Air Side
- ◆ Chilled Ceilings
- ◆ Air Movement Accessories
- ◆ Noise Control Products — HEVAC Industry
- ◆ On site and Laboratory testing facilities

Probably the widest range of stock items in the country.

Tel: 01 - 667 1077

Shop on-line 24-hrs a day from January 2001

ventacdirect.com



Flanged



Smoke Damper



Fire Damper



Cellular Diffuser



Circular Diffuser



Floor Diffuser



Heavy Duty Floor Grille



Eggcrate Grille



Air Transfer Grille



Duct Grille



Variable and Constant Volume Terminal Units



www.ventac.com sales@ventac.com



Acoustic Cabinet Fan



Mixvent Fans



Axial Fans



Special Application Axial Fans

Cork 'Supplier of the Year' and 'Trade Person of the Year' Awards 2000

The Cork Plumbing and Heating Contractors Section, CIF, recently named the latest recipients of its annual "Supplier of the Year" and "Trade Person of the Year" awards.

The "Supplier of the Year" award, which is in its 10th year, went to Irish International Trading, Corp of Rocksavage, Cork. In its sixth year, the "Trade Person of the Year" award was presented to Anthony Clarke of Cork Builders Providers.

Tom O'Brien, Secretary, Cork Plumbing and Heating Contractors believes the awards have been an effective tool in enhancing industry links. "The awards were initiated by the Cork Plumbing and Heating Contractors of the CIF to reward the suppliers who looked after them, and have helped create a greater awareness of services from suppliers. It has been a great success, and it certainly makes suppliers more aware of their customers ... our members".

Contractors were polled to establish the winner of each award. In assessing the candidates for the suppliers' award, they were asked to



Myles McCarthy, Vice-Chairman, Cork Plumbing and Heating Section, CIF with John Lyons, Irish International Trading Corporation

take into account the usual criteria of:-
speed and knowledge of counter staff;
speed and reliability of delivery service;
credit facilities;

price of materials;
level of stock;
back-up service;
showroom presentation.

The criteria for the "Trade Persons" award were:-

knowledge of product;
friendliness and courtesy;
dependability and reliability;
overall approach.

The awards were presented at the recent annual dinner dance of the Cork Plumbing and Heating Section CIF and Alliance of Heating and Plumbing Contractors. This was attended by a capacity crowd including the Lord Mayor of Cork, Cllr P J Hourigan; the Vice-Chairman of the Cork Plumbing and Heating Section CIF, Myles McCarthy; the Chairman of the Alliance of Heating and Plumbing Contractors, Gary Tobin; and Tom O'Brien, CIF.

Also present was Gary O'Sullivan of O'Brien Marketing-Hep20/Acorn, who once again generously sponsored the event.



John Lyons, Irish International Trading Corporation with Myles McCarthy, Vice-Chairman, Cork Plumbing and Heating Section CIF; Tom O'Brien, CIF; Lord Mayor of Cork, Cllr P J Hourigan; Gary Tobin, Chairman, Alliance of Heating and Plumbing Contractors; and Tom O'Brien, O'Brien Marketing/Acorn

- Mercoïd • W.E. Anderson
- Proximity Controls • Love Controls

Pressure

GAUGES: Differential pressures from 60 Pa to 21 bar; pressures from 9 bar to 689 bar. **SWITCHES:** Differential pressures from 25 Pa to 345 bar; pressures from 30" Hg vacuum to 551 bar. **TRANSMITTERS:** Differential pressures from 2.5 Pa to 21 bar; pressures to 413 bar; 2-, 3- or 4-wire operation. **TRANSDUCERS:** I/P 2- or 4-wire. **MANOMETERS:** Liquid and digital.

Flow

FLOWMETERS: 5 cc/min. to 2832 LPM air; 5 cc/min. to 75 LPM water; brass or stainless steel metering valves. **SIGHT FLOW INDICATORS:** 12 mm to 50 mm NPT; 25 mm to 200 mm flange connected; single and double windows; plain, spinner and flapper type; bronze, cast steel or 316 stainless steel bodies; tube type with integral glass cleaning mechanism. **FLOW MONITORS:** Fume hood monitors/alarms. **SWITCHES:** Liquid flows from .1 LPM water; air flows from 4.3 LPM (pipes) and 1.5 MPS (ducts). **TRANSMITTERS:** Air flows from 1 to 60 MPS. **PITOT TUBES:** Self-averaging sensors for air or liquid flows.

Level

INDICATORS: 6 mm to 50 mm NPT. **LIQUID LEVEL SWITCHES:** Float, displacement, diaphragm, radio frequency and torque tube types; pressures to 138 bar, temperatures to 400°C; side, top, suspension and chamber mounted; explosion-proof. **DRY SOLID LEVEL SWITCHES:** Diaphragm type; explosion-proof. **TRANSMITTERS:** Radio Frequency, piezoresistive, submersible and ultrasonic types.

Temperature

INDICATORS: Bi-metal and handheld digital thermometers; -50°C to 500°C. **TEMPERATURE SWITCHES:** Bulb and capillary, bi-metal and immersion types; -51°C to 277°C. **TRANSMITTERS:** -55°C to 400°C, 2-wire operation. **SENSORS:** RTD, thermocouple and thermistor types; -251°C to 482°C. **CONTROLLERS:** Analog and digital indicating; microprocessor based; 1/16, 1/8 and 1/4 DIN; alarm relay, retransmission and PID outputs. **RECORDERS:** Temperature or process inputs, -29°C to 93°C, electric or pneumatic inputs, 0.25VDC to 5VDC or .2 bar to 1 bar.

Valves

GLOBE VALVES: Bronze or 316SS bodies, 2-way or 3-way, 12 mm to 50 mm NPT. **BUTTERFLY VALVES:** Cast iron or aluminum bodies, wafer or lug style, 50 mm to 406 mm, AWWA. **CONTROL VALVES:** 2-way or 3-way, pneumatic or electric operation; self-acting temperature control valves. **VALVE OPERATORS:** Pneumatic actuators and positioners; hand-levers and manual gear operators. **VALVE POSITION:** Indicators, switches and transmitters. **JORDAN** steam pressure regulators and Bestobell steam traps.

If you work in any of these fields, the 2001 Dwyer Catalogue, Applications Handbook and the Mercoïd/Anderson Catalogues are a Must!

- Air Conditioning, Heating, Ventilating, Refrigeration
- Instrument and Control Systems
- OEM Design Engineering
- Chemical/Petroleum Processing
- Pollution Control - Air, Water
- Plastic/Packaging/Boiler
- Laboratory-Research/Development
- Power Generation
- Food Processing/Storage
- Medical/Surgical Equipment
- Environmental Control



MANOTHERM LIMITED

4 Walkinstown Road, Dublin 12.
 Tel: 01 - 452 2355/452 2229; Fax: 01 - 451 6919
 email: manotherm@eircom.net
 U15 Banbridge Enterprise Centre, Scarva Road
 Industrial Estate, Banbridge BT32 3QD, Co Down.
 Tel: 048 406 669936; Fax: 048 406 669990
 email: sales@manotherm.freeserve.co.uk

PLAN EXPO AWARD FOR NCRL

**Plan Expo 2000 Product of the Show Award —
Minister for Science and Technology, Mr Noel
Treacy, TD, with Ciaron King, Ventac & NCRL, and
Dr Willie Crowe, Manager, Irish Agrément Board**



Award Confirms NCRL Status & Ventac's Vision

The foresight of Ventac Ltd in establishing its wholly-owned subsidiary Noise Control Research Laboratories (NCRL) was rewarded recently when the latter won the prestigious Plan Expo Product of the Show Award for the year 2000. Plan Expo is Ireland's leading construction industry showcase and is presented in association with the RIAI and the CIF. Consequently, the Awards are a much sought after accolade, the premier award carrying a great deal of status as it reflects judgement by an assessment panel representing industry peers from all sectors of the construction industry.

"We were totally taken aback with the Award", says Ciaron King of Ventac. "When we embarked on the NCRL project we knew we were

offering a unique noise solution package incorporating problem analysis, product design, manufacture and installation support/advice. However, for a jury of our peers to endorse the concept so positively after such a short space of time is overwhelming."

Not that those who know Ventac and who deal with the company, either directly or through NCRL, are in any way surprised. Ventac is a long-established business with a reputation for thoroughness and attention to detail which results in a quality service and product package which is the benchmark by which consultants, contractors and architects measure other ventilation solution providers.

Over the years Ventac has gained considerable market share in the ventilation sector, through a combination of own-manufactured products and a portfolio of leading brands from some of the world's most reputable manufacturers such as S&P, Waterloo, Actionair and Gebhardt. Comprehensive industry coverage is assured, without any overlap, the various ranges complementing one another.

This in turn is further complemented by an equally-comprehensive range of design, installation and after-sales service support mechanisms.

Just like many other industry sectors, ventilation solutions require an awareness of noise control. This requirement has become quite critical in recent years, fuelled by a demand for greater comfort in work/home environments, along of course with health and safety legislation and related regulatory controls.

Having gained considerable experience in noise control technology in relation to ventilation, Ventac began to apply this experience and wealth of knowledge to the broader concept of noise control. The result was NCRL, a company specifically dedicated to testing, authenticating and certifying the noise performance of various materials which in turn are manufactured to provide tailor-made noise control solutions for all manner of situations.

In a very short space of time NCRL has become a leading market player, not just in Ireland but throughout Europe and, more recently, the US. Moreover, this development has coincided with increased international penetration of the Ventac portfolio.

Not surprisingly, employment at the Ventac Group has risen sharply and now comprises a total of 45 people involved in design, manufacture, software development, research and development, sales, administration and technical support.

This in turn has had an impact on the office, factory, stores and NCRL lab in Ringsend. Consequently, a three-acre site has been purchased in Dublin with construction of a new purpose-designed facility scheduled to commence towards the latter end of 2001. Even at that, indications are that the existing premises will have to be retained. "This will be done for practical as well as commercial reasons", says Ciaron King. "We realise that for many of our long-standing customers Ringsend is the location of their choice and, as in all business, you have to listen to the customer. We certainly do it at Ventac and NCRL and it is in doing so that we have grown, in partnership with our customers and suppliers, to the position of strength that we now enjoy".

Mitsubishi Electric ... Fountain of Knowledge

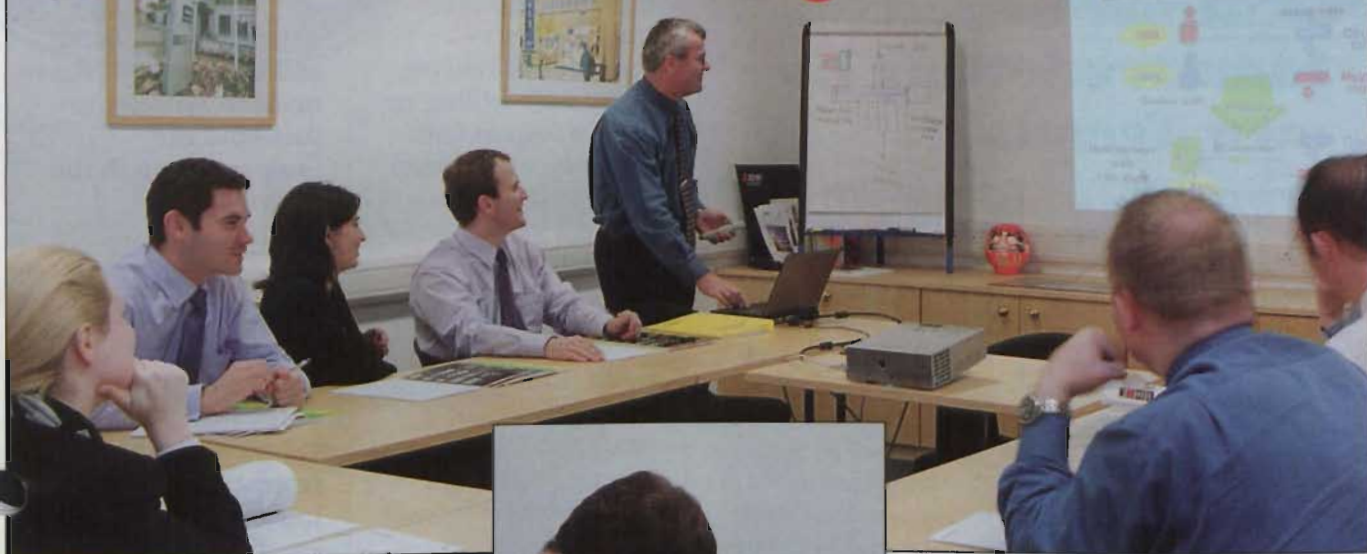

In the current market product quality is a priority for all companies, but of equal importance is the quality of support systems and the level of service offered to the customer", so says Michael Sheehan, Manager, Mitsubishi Electric's Air Conditioning Division. He was speaking to *BSNews* in the company's new air conditioning training centre at its Dublin Headquarters. Here colleagues Paul Sexton and Daragh O'Neill oversee a whole new educational programme aimed at cementing still further the relationship the company has built up with architects, consulting engineers, installers, and its dealer network.

"We have always provided quality support mechanisms at Mitsubishi Electric", says Paul Sexton, "but have now extended the problem-solving solutions we offer to include education and training. The new Training Centre is fitted out with fully operational examples from across our entire AC range, from the smallest of units right up to a full City Multi system."

On the day *BSNews* visited, a full-scale module for service engineers was in progress. Apart from the information presented by the



Paul Sexton (top, standing) conducting a Powerpoint presentation and above (inset) getting hands-on experience

lecturers, it was obvious that the forum for discussion provided by the questions and answers session was regarded by the participants as being of great benefit. The fact that the theory is related to practical hands-on experience is invaluable.

This new state-of-the-art Centre has the capability to simulate all manner of real situations. It also has a computer networked system for City Multi, which allows the engineer to dial directly into an actual remote site location to carry out full diagnostics, conduct trouble-shooting, and log what preventative maintenance is required on the next site visit.

The facility is open to consulting engineers, installers, architects and personnel from the Mitsubishi Electric dealer network. The company has devised different modules for different product areas, and these can be altered to accommodate the individual needs of participants. Additionally, a specific programme can also be devised from scratch for those who have a particular interest or need.

The pre-set modules are of day-long or half-day duration, with both morning and afternoon sessions available. However, Mitsubishi Electric has adopted a flexible approach which includes sessions commencing at 4pm and running into the evening.

Despite being open only a matter of months, the Training Centre is in constant use. The demand for various modules reflects not just an interest in Mitsubishi Electric products, but also the fact that what they are offering is a genuine education and hands-on experience covering all aspects of the air conditioning sector.

To avail of this unique facility contact Paul Sexton or Lorraine Ivers, Mitsubishi Electric. Tel: 419 8800.

REFRIGERATION

Refrigeration Skillsnet Reflects Industry Setting its own Agenda

A little over 12 months ago, a group of managing directors, service managers, and engineers representing over 30 refrigeration enterprises, sat down together in a hotel conference room to discuss training.

They were there at the invitation of Dublin Institute of Technology, Bolton Street, who were hoping to provoke some debate about training needs in the sector, and to suggest a possible way forward.

After some initial apprehension, wide-ranging discussions got underway.

Everyone was in agreement that there was a serious lack of post-apprenticeship training available to the sector. Everyone was in agreement that something had to be done about it, and everyone was in agreement that the people who best knew what was needed by the sector were the trade themselves.

When it was put to those present that they should form a network to look at their collective training needs and implement their own training programme, many felt it was a nice idea but it was unlikely to catch on. The view expressed by

some was that competitors in the trade would never work together. Thankfully however, many were willing to make a leap of faith and they were joined by others as the network gained momentum.

DIT had secured an initial tranche of funds under an EU and government programme (The Training Networks programme, managed by Skillsnet) to act as network promoters and facilitators for the start-up phase of the network.

With DIT's assistance, 26 companies carried out internal training-needs-analysis studies. The results from these studies were gathered and collated and were used to paint a picture of the typical training needs and priorities for the

sector. A draft training programme for the network was drawn up and costed, and a submission was made to Skillsnet to part-fund the programme up to the end of 2001.

At this point DIT handed over full ownership of the network to the constituent members of the network. A voluntary board of representatives from industry was established by open invitation to the sector. They formed a new company — Refrigeration Technology Skillsnet Ltd — to act as a vehicle for the development of the network and the implementation of the training programme.

In May 2000, part funding was finally approved. The training programme kicked off with the training, assessment and certification of 25 engineers in City and Guilds 2078 - Refrigerant Handling. This was followed by courses on General Refrigeration in August 2000, Refrigerant Handling in September, and Air-Conditioning and General Refrigeration (A) in October. General Refrigeration (B) took place in December.



Group of participants on one of the recent Refrigeration Technology Skillsnet training courses

Environmentally Friendly Technology



Chiller Range — Conserving Nature at No Extra Cost



Aquasnap 30RA/RH Chiller & Heat Pump

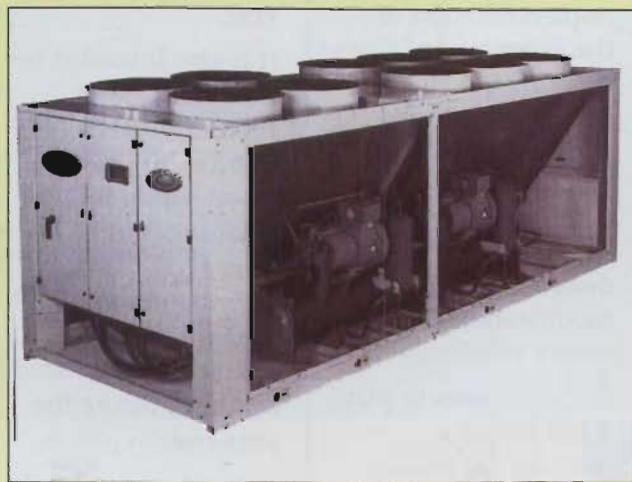

Global Chiller™: Model 30 GX, the air-cooled version

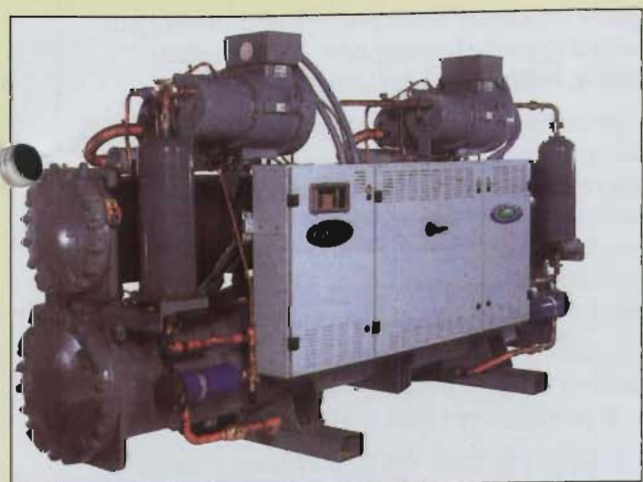

Global Chiller™: Model 30 HX, the water-cooled version



Carrier MultiVRF

For further information contact:



Unit C1, Three Rock Road, Sandyford Industrial Estate, Dublin 18.
Tel: 01 - 294 3110; Fax: 01 - 294 3115
E-Mail: info@coreac.com Website: www.coreac.com

R E F R I G E R A T I O N

All of this is happening due to the willingness of a voluntary board to give up their time to the network. The board meets monthly to discuss and progress the development of the network and implementation of the programme. Individual board members also take on a variety of tasks, ranging from negotiations with training providers to design and modification of course syllabi.

DIT continues to play a role but as a provider to, rather than a promoter of, the network. DIT acts as project managers to the network and is also responsible for some of the training and accreditation. Training rooms are also made available to alternative providers from time to time.

The key point being made is that industry is setting the agenda here, rather than any one training provider. Refrigeration Technology Skillsnet is owned, managed and supported entirely by industry

So what lies ahead for the network? Well the training programme continues apace with courses on General Refrigeration, Air Conditioning,

Refrigerant Handling and Technical Sales lined up for the first four months of 2001. A new course on fault-finding is also under development, and may be offered in the same period. Further topics will be addressed later in the year.

It is also intended to hold an AGM in February/March 2001 in order to gather in the views and feedback of this sector in general. Further information on all of these planned activities will be made available before the year-end.

If you are not already on the mailing list, or would like to speak directly to the project manager, the details are given below. The network is open to all enterprises and individuals engaged in the design, manufacture, distribution, installation, commissioning and maintenance of refrigeration technology for Irish industry.

Contact: Enda Hogan, Project Manager, Refrigeration Technology Skillsnet.
Tel: 01 - 878 3773;
Fax: 01 - 872 9126;
email: enda.hogan@dit.ie
Website: www.dit.ie/ats

Climaveneta & ABB — Quality-Driven Through Research & Innovation

Climaveneta, which recently merged with the De Longhi group of companies, has been a market-leading player in the air conditioning and refrigeration sector for nearly 30 years.

That it has teamed up with ABB — itself a world-leading market player — in Ireland to ensure nationwide distribution and after-sales service support is no surprise.

Extensive investment in research and design has led to the development of the expansive Climaveneta range of innovative, energy-saving, multi-purpose chillers for commercial and residential conditioning, in addition to machines specifically designed for industrial cooling.

Climaveneta's research effort is global and concentrated not just on hardware, but also on the software of the units. For example, the intelligent microprocessing system of the units has the purpose of optimising the functioning of the multi-purpose chillers. Indeed, Climaveneta has developed a complete range of electronic microprocessor controls which can be easily integrated with "the outside world" to allow for communication with every supervisory building control system.

Equally important is the research and investment directed towards devising new, environment-friendly, refrigerants.

In the pursuit of all these objectives Climaveneta is quality driven. A testament to its success in this endeavour is the fact that it has obtained the SQI certificate n 0035 (issued in 1992 as a rev. 0 in compliance with the ISO 9001/UNI-EN 29001 rules), and further updated in 1998 (as rev. 2 in compliance with UNI EN ISO 9001 rules).

Climaveneta has also been actively involved in the Eurovent certification programme since 1995 and all its products are listed in the Eurovent Directory.

As already indicated, the Climaveneta range supplied by ABB is extensive, and includes:- Air cooled liquid chillers; Air/water heat pumps; Water cooled liquid chillers; Water/water heat pumps; Split system units; Single package roof-top units; Air cooled water chillers; Air/air heat pumps; Water cooled water chillers; and air/air roof-top units. Full product details, performance capabilities, technical data and applications are available from ABB.

Contact: Mark Grimes, ABB, Tel: 01 - 405 7300;
Fax: 01 - 405 7312; email: information@ie.abb.com

fridge spares (WHOLESALE) LIMITED



SPECIALIST SUPPLIERS TO THE REFRIGERATION & AIR CONDITIONING TRADE

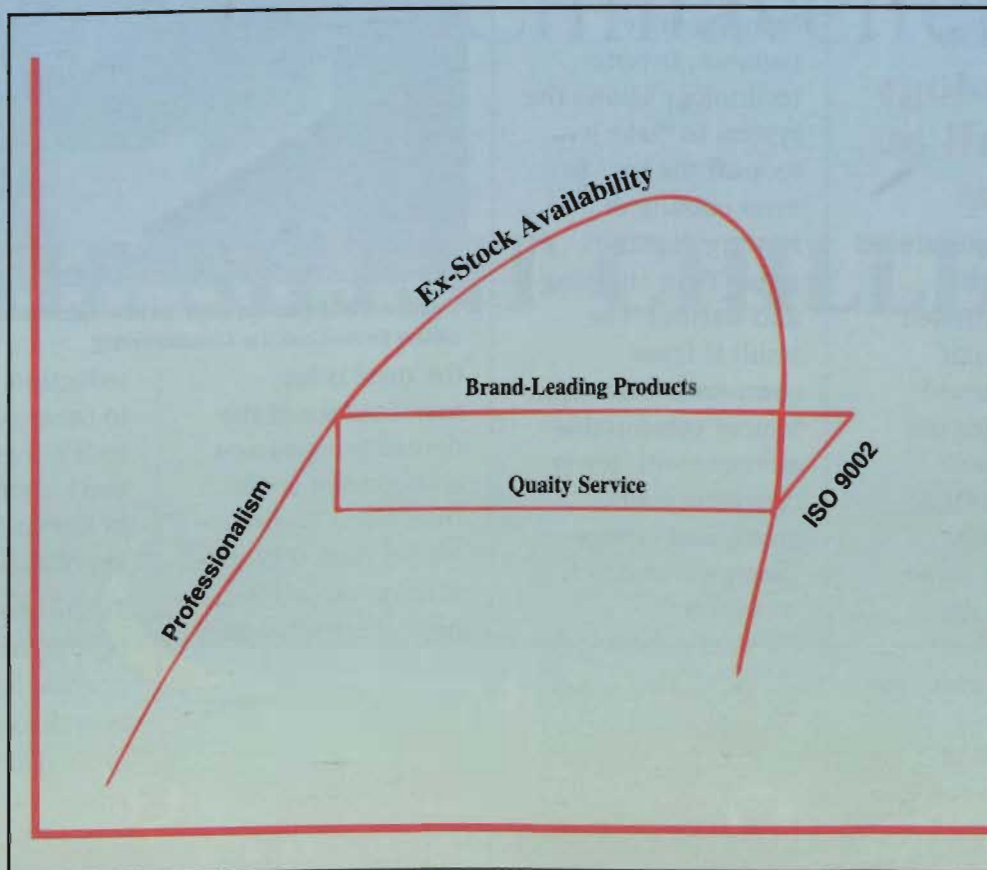

Experienced Personnel + Technical Excellence + Quality Solutions

Total Refrigeration Capability

Fridge Spares (Wholesale) Ltd,

Unit 15, Blackwater Road, Dublin Industrial Estate, Glasnevin, Dublin 11.
Tel: 01 - 830 3466; Fax: 01 - 830 3672; email: fridge@iol.ie

Cork Branch

Unit 15, Southside Industrial Park, Togher, Cork. Tel: 021 - 431 7645; Fax: 021 - 431 7681;
email: fridgeck@fridge.iol.ie

Belfast Branch

Unit 6, Hawthorn Business Park, Boucher Road, Belfast BT12 6HT.
Tel: 048 90 665999; Fax: 048 90 665888

REFRIGERATION

Carrier Brings the Benefits of Inverter Technology to Small ac Systems

Carrier has introduced one of the first inverter-controlled small Multisplit systems designed specifically for use with the green refrigerant R410A. Toshiba Carrier Corporation Japan, from whom the technology has been transferred, leads the world in the development of inverter technology.

greater energy efficiency than was previously achievable.

Energy Savings — In automotive parlance, inverter technology allows the system to “take its foot off the gas” to meet cooling or heating demands, rather than stopping and starting. The result is fewer compressor start ups, a more comfortable environment, lower operating sound levels, and energy savings of as much as 40% over conventional systems.

This is achieved by DC hybrid inverter technology: when



Carrier Multisplit inverter R410A outdoor unit (cut-away) from Core Air Conditioning

the need is for maintenance of the desired temperature and comfort levels, then Pulse Width Modulation (PWM) is activated to achieve high efficiency and energy savings while limiting temperature swings.

Heat pump technology offers heating as well as cooling from the same system up to 5,3kW nominal heating capacity (6,8kW maximum).

The system also uses DC twin rotary compressor technology which delivers very high reliability and longevity. The latest metallurgical technology incorporated here uses highly-innovative compounds. The twin-pole motor design contributes a dramatic vibration

reduction compared to other compressor technologies and is particularly beneficial in the specified applications.

Twin-swing louvres on the indoor units provide improved air distribution and state-of-the-art filters ensure high indoor air quality standards.

Ease of installation

— One outdoor unit can serve two rooms. The outdoor and indoor units are all of compact design and can be installed almost anywhere. The units are also relatively lightweight. Connection is simple since the electric and refrigerant circuits can be run together.

Contact: Austin McDermott, Core Air Conditioning.
Tel: 01 - 294 3110;
Fax: 01 - 294 3115;
email: info@coreac.com



Carrier Multisplit inverter R410A outdoor unit from Core Air Conditioning

For residential applications, small shops and offices, the demands of environmental legislation and controlled comfort can both be met by this new system with

power is needed, for example at start up, then the control activates its Pulse Amplitude Modulation (PAM) to reach the desired comfort levels quickly and smoothly. When

Your Clients & Their
Neighbours will be pleased
you chose Climaveneta

THE SILENT CHILLER

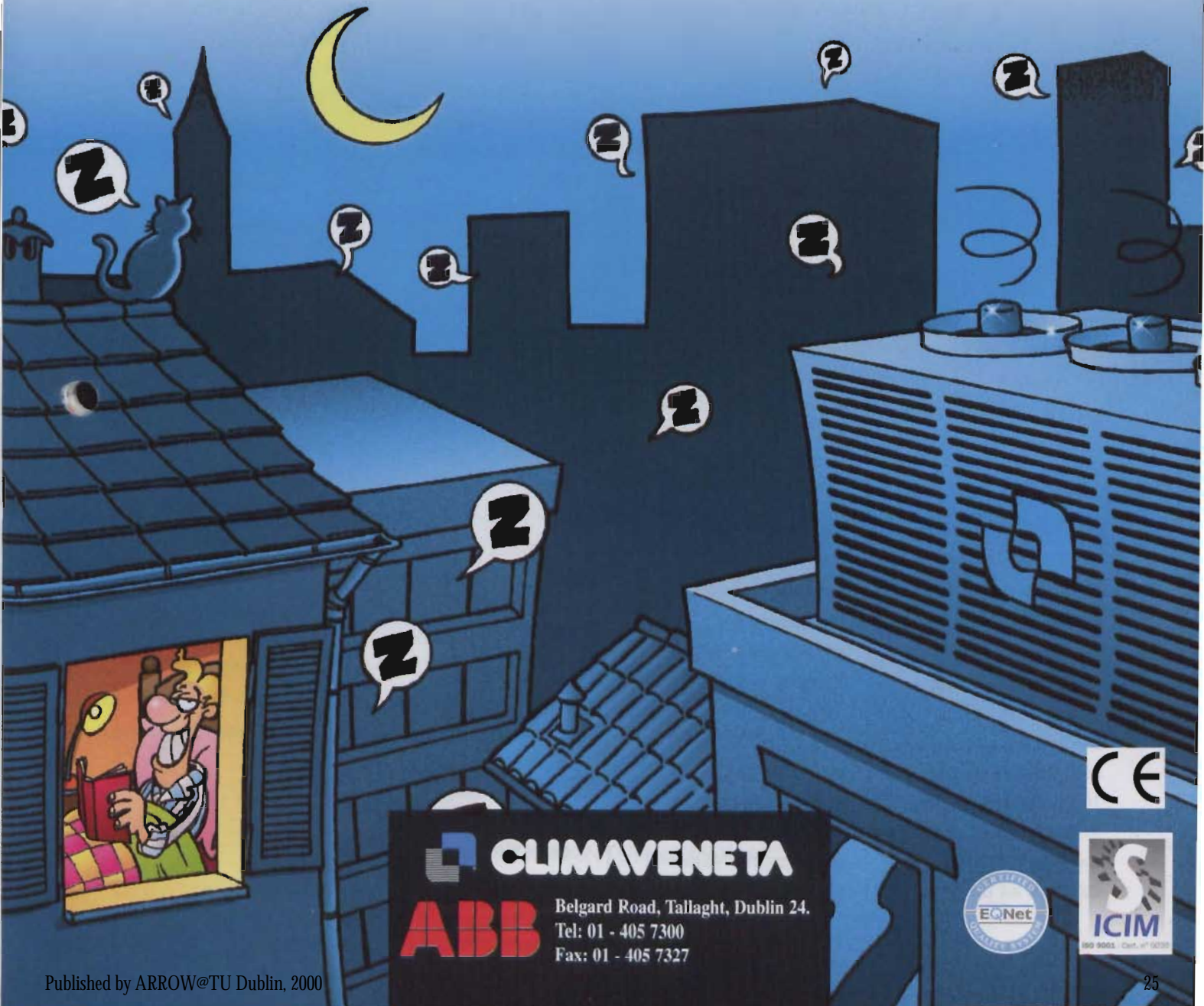

 **CLIMAVENETA**
ABB Belgard Road, Tallaght, Dublin 24.
Tel: 01 - 405 7300
Fax: 01 - 405 7327



REFRIGERATION

Sanyo ECO Multi – Economy & Ecology

“ECO MULTI Series”, the new Sanyo individual air-conditioning system that effectively combines a power control compressor and an electronic refrigerant control valve, is now available from Redbro Ltd.

Newly-developed power control refrigerant circuit operates without an inverter control, thus decreasing electromagnetic disturbance (harmonic current emissions) and complying with EMC Standards.

Power control circuit and newly-designed structural parts contribute to a major reduction in initial and running costs, and the required amount of refrigerant (approx 10% EER increase and 15% reduction of R22, when compared to the current FIT Multi System).

By using electronic control valves for linear control, the capacity of the indoor unit can be controlled from 25% to 100% (during cooling) to provide a more stable room temperature at a constant air flow rate.

Convenient microprocessor control automatically adjusts fan speed to high, medium or low, corresponding to room sensor and maintains comfortable airflow throughout the room.

Even when power failure occurs, preset programmed operation can be reactivated once power is resumed.

Details of past record of warnings are stored and can be verified on the liquid crystal display. This makes it easier to diagnose malfunctions and reduce service labour. A further advantage is that, these indoor units can be connected with a standard single outdoor unit (heat pump type) in case of design changes for air conditioning, thereby allowing more flexible designs than before.

Features & Benefits

New combination system uses Sanyo's large-capacity technology for conventional W-MULTI Systems — A wide range of large capacity systems ranging from 45kW (16HP) to 84kW (30HP) is available, combining a PC unit (power control outdoor unit: 45kW (16HP); 56kW (20HP)

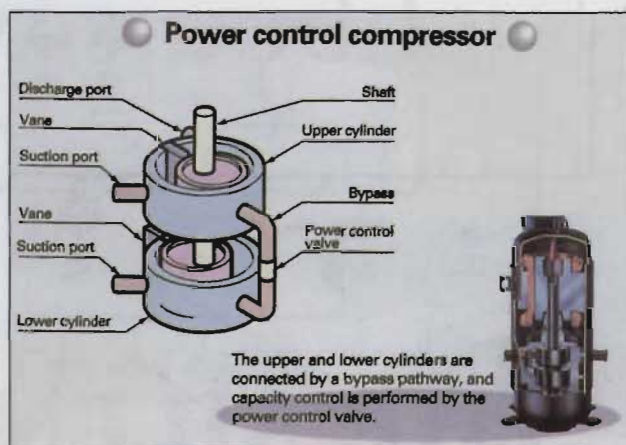

All units incorporate the new Sanyo “Power Control Compressor”, thus eliminating the need for a power inverter

and AD units (additional outdoor unit: 22.4kW (8HP); 28kW (10HP);

The economical, individually-controllable air conditioning system lets you link up to 32 indoor units to a single system;

Environmental-friendly capacity control that limits the creation of harmonic disturbance to a minimum — The W-ECO MULTI System replaces the inverter technology used in conventional air-conditioners with a power control compressor and an electronic control valve, effectively reducing harmonic disturbances to a minimum.

Energy saving design reduces required refrigerant — The economical and ecological multi system reduces the required amount of refrigerant by

15% compared with our conventional multi systems.

Contact: Barry Hennessy, Redbro.
Tel: 01 - 294 0321;
Fax: 01 - 294 0325;
email: bhsanyoac@indigo.ie

Want to be informed? Subscribe to BSNews Now! Call: 01 - 288 5001

The philosophy behind our new range of chillers.



York's chillers are now all designed from scratch to optimise the performance characteristics of the 'new' refrigerants and thereby delight consultants, contractors and end users alike.

Whether your prime criterion is COP, small footprint or low noise, York is bending over backwards to meet your requirements with a

comprehensive range of superb new chillers with intelligent controls able to interface with any BMS system.

And whether your favourite number is 134, 407 or 717, or indeed if you're a natural refrigerant enthusiast, York offers you an unparalleled choice of unequalled quality.

 **York**[®] ACR

YORK INTERNATIONAL

Engineering excellence – naturally.

MITSUBISHI ELECTRIC QUALITY

Mr. Slim. The Unanimous



Mr. Slim is Ireland's leading range of packaged split system air conditioning products, offering a huge choice of components and configurations for a wide range of applications, from restaurants and bars, to shops and offices - typical cooling capacity up to 28.4kW and heating capacity up to 26kW.

**Wide choice -
to fit your application
precisely**

With 14 ceiling cassettes, 6 ceiling suspended units, 10 wall mounted units, and 22 ceiling ducted units, there's a Mr. Slim model to provide the optimum "fit" for all your jobs.

**Environmentally
friendly options**

The Mr. Slim range includes models using R407C ozone friendly refrigerant. It can also incorporate optional fresh air casements to help keep designated non-smoking areas smoke-free.

**Excellent control
features
and options**

Mr. Slim puts you in control with a wide choice of control configuration options, via one or multiple controllers, and all models can be interfaced to Building Management Systems.

Whisper Quiet

Advanced fan design has resulted in class-leading noise levels down to just 31dB(A).

For further information on the Mr. Slim range contact:



Split Decision.

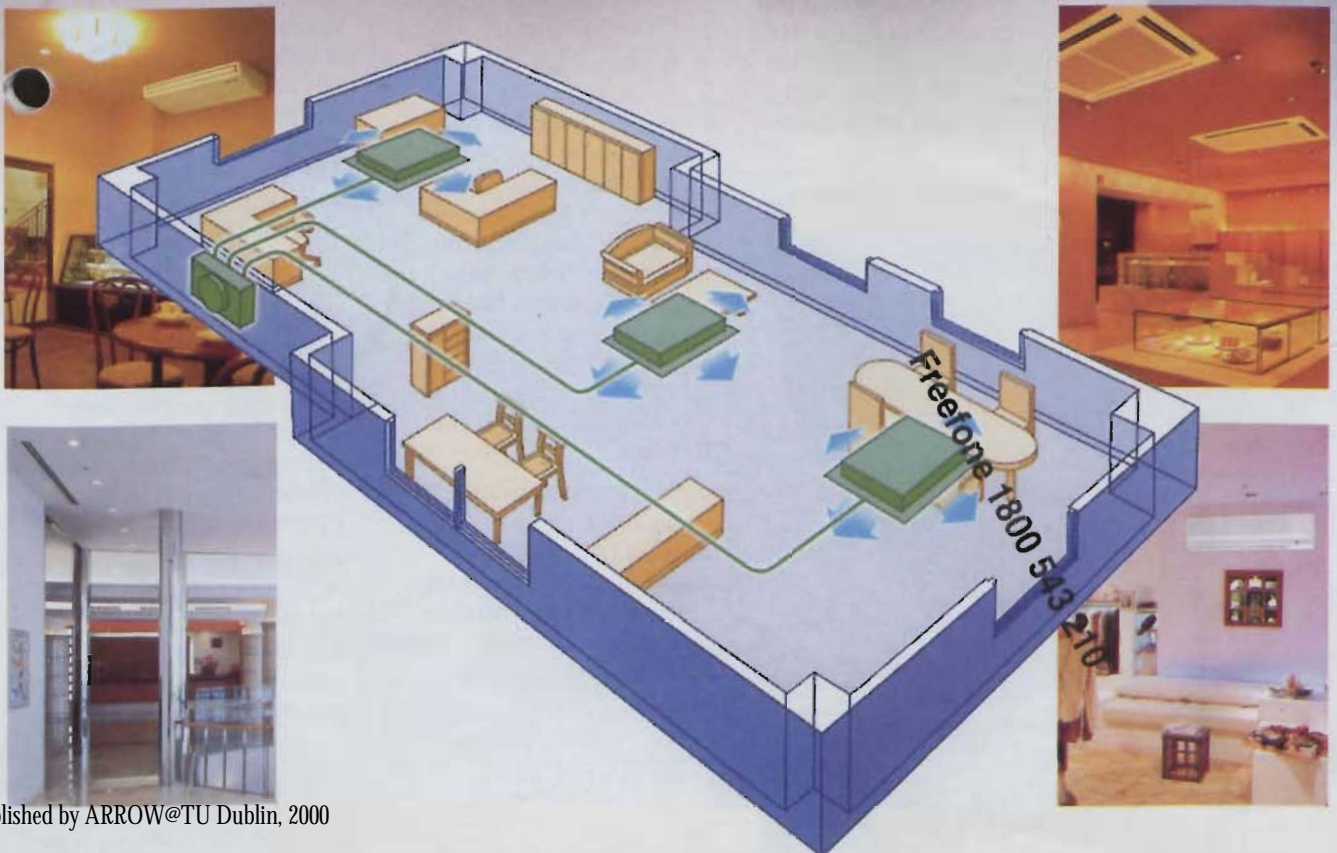

REFRIGERATION

York YCASeco² Air Cooled Screw Chillers Range

The York YCAS eco² range of air cooled screw chillers was developed to achieve optimum performance with HFC-407C refrigerant. This multiple refrigerant circuit air-cooled chiller has been engineered around York's most advanced screw compressor and microprocessor controls technology. Special heat exchangers have been designed to take full advantage of the extra efficiency derived from the glide characteristics of R407C.

eco² Features

- ❑ Sophisticated microprocessor controls;
- ❑ Epoxy-coated condenser coil fins to provide corrosion protection;
- ❑ Each fan is located in a separate compartment to prevent cross-flow during fan cycling;
- ❑ Cooling capacity control from 10% to 100% for smooth exacting operation;

- ❑ Operating ambient conditions from -18°C to +52°C to satisfy global applications;
- ❑ Low starting current – open transition Star Delta starters;
- ❑ Heat recovery and resuperheater options;
- ❑ Optional power factor correction capacitors;
- ❑ Building automation system interface;
- ❑ Acoustic treatment systems.

York has tested all HFC refrigerants and has proved that the special properties of HFC-407C can be optimised to provide the highest operating efficiencies exceeding that of other HFC refrigerant and traditional R22 air cooled chillers.

R407C Temperature Glide — R407C is a blend of three refrigerants, composed by weight of 23% HFC-32, 25% HFC-125 and 52% HFC-134a. This zeotropic mixture does

not act as a single substance. At a given pressure it evaporates over a range of temperatures rather than at a single temperature. "Temperature Glide" is the term used to describe this action.

To take full advantage of the glide characteristics York has developed a state-of-the-art counter-flow evaporator. The refrigerant and water enter at opposite ends. The entering HFC-407C temperature is 3°C and due to glide the leaving temperature is 7.4°C. If R22 were used in the same evaporator the entering and leaving temperature would be 3°C. The higher HFC-407C leaving temperature means the compressor does less work, and therefore consumes less electrical power, to raise the refrigerant to the condensing temperature. The refrigerant leaves the counter-flow evaporator in a saturated vapour state.

Suction Line Heat Exchanger — A shell and tube suction line heat exchanger is incorporated in the system. High-pressure liquid refrigerant from the condenser, typically at 40°C, enters the shell of the heat exchanger and superheats the saturated refrigerant vapour flowing in the tubes.

The low temperature liquid refrigerant, leaving the heat exchanger to the cooler, adds extra sub-cooling to that produced at the air-cooled condenser.

The cooling capacity is

increased without additional electrical power consumption.

New Generation Screw Compressors — York has developed and manufactured screw compressors for more than 25 years. The latest technology has been incorporated in this high efficiency twin helical screw compressor. It operates at low speed and is driven directly from the motor.

Being a gear-less design it has a low sound level and minimum vibration.

An internal muffler optimises gas flow, for maximum performance, and matches refrigerant flow harmonic frequencies to further reduce sound levels.

Microprocessor Controls — The York Millennium microprocessor provides easy data access and accurate control of the chiller.

System operating conditions are monitored and the rate of change of temperatures and pressures are analysed. The compressor slide valve is positioned in anticipation of predicted cooling load change. Unlike step control systems that either under-load or over-load capacity steps, the YCAS fuzzy logic control saves energy by providing an optimum part load efficiency and smooth operation.

Contact: Pat Byrne, York ACR.

Tel: 01 - 466 0177;

Fax: 01 - 466 0198;

email:

pat.byrne@ie.york.com



IRISH AGENT

REDBRO

et al.: BS News

SANYO

Unit 4, 70 Heather Road, Sandyford Industrial Estate, Foxrock Dublin 18.
Tel: 01 - 294 0321; Fax: 01 - 294 0325; email: sanyoac@indigo.ie

DEALER & INSTALLER

SANYO Multi System Air Conditioners "ECO MULTI" Series

ADVANCED AIR
CONDITIONING

"Raising the Standard"

Tel: 01 - 456 8776; Fax: 01 - 460 4538;
email: advair@iol.ie

ECO MULTI
ECONOMY & ECOLOGY

W-ECO MULTI
ECONOMY & ECOLOGY

R22 & R407C



Symbiosis with nature We are the frontier of future clean energy

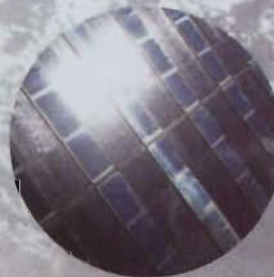

AIR CONDITIONERS



To collectively improve people's living ambience, local surroundings and the global environment, thus creating a more natural and comfortable environment, is our main goal.



REFRIGERATION

Reconair — 'Total Package Maintenance'

Reconair, one of Ireland's longest-established air conditioning companies, enters the 21st century with a clear demonstration of its capacity and technical expertise

under the management of the Cooney brothers, Brian and Mark.

The company has been established for over a quarter of a century. Its founder, Frederick Cooney, handed over

to his sons a well-established and successful business with a client list of the country's top blue chip companies on his retirement three years ago.

Today the company continues to enhance its position and reputation for quality

services and reliability, keeping faith with the founders successful business concept.

The company was one of the first to introduce to the Irish market the concept of "total package maintenance" and was the pioneer in developing a number of the procedural formats which are now also widely used by its competitors.

Reconair's portfolio of blue-chip companies is extensive and covers all industry sectors.

Contact: Mark Cooney, Reconair Services.

Tel: 01 - 842 5200;

Fax: 01 - 842 5880;

email: hvac@reconair.ie

Website:

www.reconair.ie



Irish Life is one of Reconair's many blue-chip clients. Just recently the company completed a massive project in Abbey Street which brought Dublin to a standstill (see *BSNews* October/November)

Lennox Reaches New Heights

As part of its on-going product development programme, Lennox has launched three new ranges of rooftop units through Irish distributors Walkair Ltd.

Developed to meet project specification requirements on a pan-European scale, the Smart, Linea™ and Flexy™ offer improved performance, efficiency, and flexibility, providing comfort control solutions for a wide range of applications. The new series is available from 10kW to 200kW, with JFCFC-22, and from 20kW to 200kW with JFC-407C refrigerants. A total of 192 units are available across the three ranges with cooling only, heat pump, cooling with gas and dual fuel capabilities (heat pump with gas).

Commenting on the most recent additions to Lennox's portfolio Vincent Mahony of Walkair said: "One of the main objectives in designing the new ranges of rooftop units was to introduce products which had Europe-wide applications. The Smart, Linea™ and Flexy™ have not only successfully met that criteria but, with the introduction of Climatic 2, push the boundaries of control technology. A great deal of interest has already been shown in the new ranges, and I have no doubt that Smart, Linea™ and Flexy™ will provide the solutions that our customers are demanding".

Contact: Vincent Mahony, Walkair. Tel: 01 - 456 8070; Fax: 01 - 456 8098; email: sales@walkair.ie

REFRIGERATION

ICI Klea Corporate Website

ICI Klea, one of the world's leading producers of alternatives to CFCs and HCFCs, has significantly re-designed its corporate website:

www.icikle.com to meet the changing needs of its refrigeration customers for greater access to technical information covering non-flammable refrigerants. The site also reflects ICI Klea's breadth of business interests across many speciality markets such as medical propellants and flavours and fragrances, providing easy-to-find, up-to-date information for its customers worldwide, including those of RSL, its Irish distributors.

Following its launch in 1990, ICI Klea's business has become the world's leading manufacturer of HFC 134a and a global supplier of a wide range of HFC refrigerants. More recently, the company has expanded its business into other speciality markets, supplying products and services to the pharmaceutical, food, drink and fragrance industries.

ICI Klea's ZEPHEX range of high-grade HFAs are now used around the world as propellants in metered dose inhalers (such as those used by asthma sufferers) and the business also supplies the technology that enables high-purity flavours and fragrances to be extracted from a wide range of natural products, from vanilla pods to rose petals.

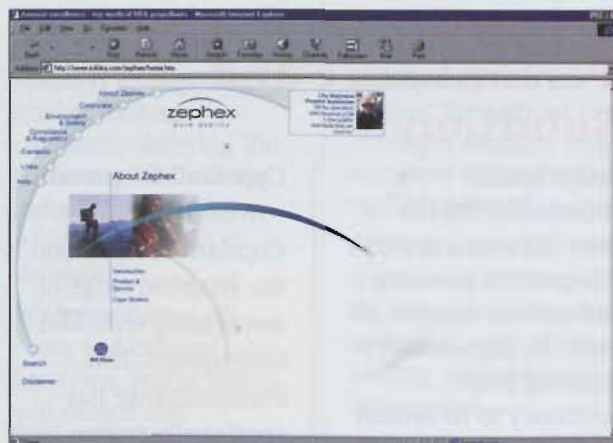

The new-look website reflects this new strategic development and provides extended information on both the Klea range refrigerants and speciality products and services offered by the company. Internet users can access corporate information, product updates, technical refrigerant information, regulatory updates, press releases and briefing and research papers, as well as contact details for ICI Klea and its distributors around the world.

Gerry McDonagh, Managing Director of RSL, said: "ICI Klea has developed significantly in recent years. While it retains its market-leading position in HFC refrigerants – and I see this as the cornerstone of the business for the long term – it has

diversified into new, exciting, speciality areas, which are already reaping significant rewards. The new corporate website reflects the breadth of the business, making it easy for all our customers to access information about the company.

"The new site provides specific information on the business's full range of fluorocarbon products and technologies, and is a rich source of information on other related topics, including science, innovation, environment and quality".

Contact: Gerry McDonagh, RSL.
Tel: 01 - 450 8011;
Fax: 01 - 456 7512;
email: info@rslireland.com
Website: www.rslireland.com



REFRIGERATION

Fridge Spares Quality Performance and Solutions

Fridge Spares (Wholesale) Ltd has been delivering quality refrigeration products and services for over 30 years. Its high industry standing bears testimony to its success in this endeavour, a fact which is underscored by the long-standing relationships it has with its principal suppliers, all of whom are industry market leaders in their own right. Brief details of each of these are as follows:

Tecumseh – Forty years of manufacturing experience has led to the evolution of the most complete and technically-sound range of hermetic compressors and condensing units in Europe.

Copper condensers coated against corrosion, coupled with high electrical specifications and installer-friendly features, are examples of some of the reasons why so many engineers worldwide choose Tecumseh as their number one. The comprehensive range spans from 1/12 HP to 12 HP and covers low, medium or high temperature ranges utilising a sensibly-selected refrigerant composite.

Copeland Corporation – Available from the Copeland Corporation is the Prestcold range of condensing units and compressors. The Prestcold range has continually proven itself worthy of its "Prestigious" reputation while operating in all sectors of the refrigeration and air conditioning markets with great reliability and effectiveness.

The compressors offered range from 1/2 HP single cylinder up to 60HP eight-cylinder machines.

Friga-Bohn – The complementary nature of the Tecumseh and Prestcold ranges with that of Friga-Bohn makes for a formidable combination which runs to the very core of the Fridge Spares product offering.

Friga-Bohn has an established worldwide reputation as the leading manufacturer of heat exchange products. The comprehensive portfolio includes commercial and industrial evaporators and condensers, and steel products, eg, suction accumulators, receivers, etc.

All Friga-Bohn condensers conform to ENV 327 while all evaporators conform to ENV 328, thereby guaranteeing full regulatory compliance.

Union Foam – Union Foam is an environmentally-aware manufacturer of high-quality specialist foams

expertise, the inclusion of the Danfoss range of refrigeration and ac components in the Fridge Spares portfolio guaranteeing a "perfect-fit" solution for every application.

Danfoss is synonymous with in-line components, especially expansion valves, and the combined strength of



Prestcold air-cooled scroll condensing units from Fridge Spares

and a leading manufacturer of high-performance, flexible synthetic pipe insulation systems.

Eurobatex is a specially-formulated system for refrigeration, condensation and air conditioning applications. It is CFC and HCFC-free and has an ozone depletion potential of '0'. It is available in wall thicknesses from 6-25mm Class '0'.

Danfoss – That Danfoss and Fridge Spares have a strong trading relationship is hardly surprising. Both are market leaders in their respective fields of

Danfoss and Fridge Spares ensures trouble-free, efficient operation in every situation.

The Danfoss refrigeration and ac components range is extensive, and comprises state-of-the-art products incorporating international design expertise and technical excellence.

Galco – Galco is part of the Dehon Group and, as such, enjoys all the benefits and strengths being part of a multi-national entails. Its filling plant has the geographical advantages of being based in Antwerp, facilitating fast and efficient distribution to all its distributors.

R E F R I G E R A T I O N

Galco supplies Fridge Spares with a comprehensive range of refrigerants, including drop-ins in a variety of cylinder sizes to meet all usage requirements.

Eliwell – Eliwell is renowned the world over as market leader in electronic controls for the refrigeration industry. Year on year the company continues to bring technologically-advanced and highly-innovative refrigeration and air conditioning controls to the market. In fact, over the last decade Eliwell has changed the whole

complexion of this sector of the business, introducing features to refrigeration and air conditioning controls which have resulted in enormous end-user benefits.

Multi-Compressor Pack Systems – Fridge Spares personnel represent a wealth of experience and technical expertise. This is brought to bear on all aspects of the service provided by the company and is especially evident in the company's own-manufactured range of Multi-Compressor Pack Systems.

When it comes to multi-pack systems, Fridge Spares is undisputed market leader, constantly defining the parameters and setting industry standards which others seek to emulate.

With multiple cold room and cabinet locations, Fridge Spares will design and manufacture a tailor-made solution based on the Prestcold compressor range, which will guarantee optimum performance and energy efficiency, while also complying with all the necessary regulatory requirements.

Ancillaries, Accessories & Tools – The same quality emphasis is evident throughout the extensive ancillary and accessory range stocked by Fridge Spares.

Every conceivable requirement is catered for, from tools through to fittings, with all the leading manufacturers represented.

Contact: Fridge Spares.
Dublin:

Tel: 01 - 830 3466;
Fax: 01 - 830 3672;
email: fridge@iol.ie

Cork:

Tel: 021 - 431 7645;
Fax: 021 - 431 7681;
email: fridgeck@fridge.iol.ie

RSL (Ireland) Ltd

Ireland's Leading Stockists
and Distributors of Refrigeration
and Air Conditioning Equipment



Cork Tel: 021 - 431 7221; Fax: 021 - 431 7222
Dublin Tel: 01 - 450 8011; Fax: 01 - 456 7512
Galway Tel: 091 - 757818; Fax: 091 - 758744

REFRIGERATION

Scroll Technology For Commercial Air Conditioning

Launched in 1997, the Danfoss Performer® scroll compressor represents one of the latest and most advanced scroll technologies on the market.

Performer® has been selected by original equipment manufactures as the best technological choice for their commercial air conditioning applications. This article gives the reasons behind their choice, writes John Sampson of Danfoss Ireland.

Commercial air conditioning manufactures all over the world are designing new ranges of products incorporating hermetic compressor technology. They are faced with new technical challenges ... their products must comply with environmental regulations and must achieve energy efficiency levels never achieved before. The reduction of sound level and vibration is also a high demand from the end users of the products. The importance of supplying a product that results in satisfied customers cannot be overstated and the compressor is a key element in this process.

Performer® compressors yield superior performance, at lower installation and running cost, than comparable technologies. They are demonstrating their durability and reliability in a wide variety of applications from liquid chillers to split air conditioners; from rooftop units to close-control air conditioning and from heat-reclaim to heat-pump units.

Performer® technology unveiled

It was a major event in the compressor world when the Danfoss Performer® scroll compressors entered the market offering many vital advantages for

original equipment manufactures, installers and end users. Benefits include:-

- The highest efficiency in this class of compressors gives reduced power consumption;
- Low sound and vibration characteristics mean quieter systems;
- Built-in safety devices guarantee optimum reliability;
- Can be coupled in parallel to give large cooling capacity coverage;
- Two products series for use with only four refrigerants R 22(SM series), R407C, R134a, R404A (SZ series).

Reductions in power consumption give significant savings of as much as 2500 kWh per year in relation to conventional compressors. This is a highly-significant economic saving for end users. Several developments have made this reduction in power consumption possible.

A sealing technique that makes the difference ... Inter-scroll leakage reduced to a strict minimum (figure 1).



Figure 1

Compressor performance is directly related to internal leakage and other losses. The choice of technology is an essential element in ensuring hermetic sealing and reducing:

- Axial leakage (between scroll vane tip and opposite scroll base);

- Radial leakage (between scroll vane flanks).

The technologies used by competitors seal scroll vane tips by pressing them firmly against each other. However, this technology has two serious drawbacks, as shown in the diagram below:

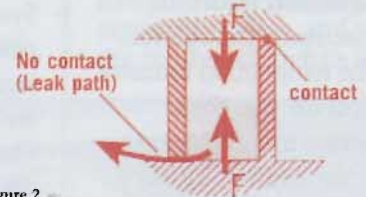

Figure 2

Axial sealing system

Danfoss-Maneurop's technology is totally different from that of most competitors - a unique concept which maintains the two scrolls in dynamic contact via a floating seal to guarantee perfect axial sealing with low contact forces. This reduces energy losses caused by friction.



Figure 3

Radial sealing system

The leading-edge machining technologies developed by Danfoss-Maneurop ensure exceptionally-high geometrical and dimensional accuracy. Radially-matched design (i.e. contact between the flanks of the scrolls) is no longer necessary (figure 4, diagram 1). Sealing is maintained by an oil seal with no mechanical contact between the scrolls (figure 4, diagram 2).



Figure 4

REFRIGERATION

This concept achieves performance levels in energy consumption and acoustics which make this product the new benchmark for the market.

Lower flow losses

Specifically designed to reduce pressure losses (figure 5, pos. 1 and 2).

Low Pressure

Pressure drops in refrigeration equipment waste energy. The design limits refrigerant gas pressure drop inside the compressor. Motor gas path flow dimensions have been increased. Refrigerant passes between the rotor and the stator and into the slots around the stator. This considerably reduces pressure losses. Additionally, this design permits extremely efficient motor cooling and guarantees excellent service life for this fundamental compressor component. Suction pressure losses in general have been reduced.

High pressure

During the discharge phase, pressure losses occur when the refrigerant flows through the check valve and the other gas channels. To obtain a more efficient discharge process, discharge ports have been enlarged and the gas pocket opening process has been optimised. To optimise the path section, the check valve is based on an annular valve design.

Reduced friction losses

Thrust bearing and journal bearings which absorb less energy (figure 5, pos. 5 and 3). The compressors are fitted with radial bearings to counteract compression loads. The axial loads on the orbiting scroll caused by the pressure of the gases between the scrolls are counteracted by a hydrodynamic thrust bearing.

The radial bearings, thrust bearing and lubricant were all selected to optimise compressor efficiency.

This extraordinary accuracy, combined with "high" scroll involutes, reduces inertia forces,

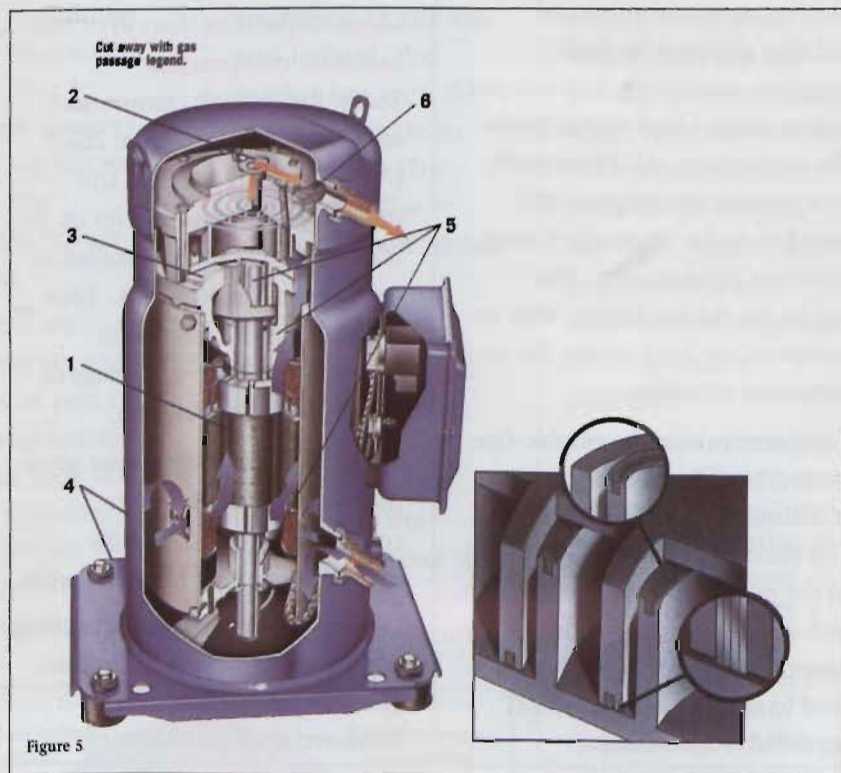

Figure 5

High-efficiency motor

The motor, specifically designed for Performer™ compressors, was developed to increase efficiency by reducing motor slip and magnetic losses.

Less vibration and fewer decibels

The compactness of the new design, the reduction in the number of moving parts and extremely accurate machining, are all new developments which make Danfoss-Maneurop scroll compressors better balanced, and significantly reduce vibration and noise levels.

Leading-edge production technology (figure 5, pos. 6)

Due to major investments in innovative, leading-edge machining technologies, tolerances can be measured in microns (10⁻⁶m).

vibration and noises generated by the compressor, and ensures overall reductions in sound level during compression.

A "quieter" design (figure 5, pos. 4)

The design of the base, an integral part of the lower compressor shell, and new rubber grommets reduce the load transmitted to the structure by a factor of four and also contribute to a general reduction in the level of noise radiated by the unit in which the compressor is installed. The radial bearings used in these compressors also contribute to the exceptional acoustic and vibration characteristics.

The new silent discharge check valve, efficient throughout the whole compressor application range, prevents reverse rotation at shut-down (i.e. no rattling and no shut-down noise).

R E F R I G E R A T I O N

Even greater reliability

The simplified design, the reduction of the number of moving parts and enhanced stability achieved by high-precision machining technologies reduce stresses and strains inside the compressor. All Performer® compressors are designed and tested to make certain they meet customer expectations. The results are market beaters with an exceptionally long service life and enhanced reliability.

Compressors must be trouble-free components for manufacturers, installers and services personnel. The Performer® range scored high in the most stringent qualification and service life tests. In fact it passed the same tests as those used to certify the range of MT hermetic reciprocating

compressors from Danfoss-Maneurop, world-renowned for their reliability.

Larger capacities than ever with hermetic compressors

Today, Performer® compressors are available in sizes from 20kW (7 TR) to 50 kW (15 TR), and cover application capacities up to 200kW (60 TR) when installed in parallel in a single circuit. Four compressors can be used in parallel to give the advantage of easy capacity modulation.

The Performer® compressor gives the reliability of hermetic compressors with capacities equivalent to semi-hermetic units.

Looking ahead, Danfoss-Maneurop is planning to secure its position as a leading supplier to the commercial air conditioning

market by extending the Performer® range of compressors upwards by the addition of new 60 and 75 kW (20 and 25TR) models.

Flexibility is the key issue in today's high demand for short deliveries, and this is exactly what Performer® can offer. By selecting only six models, and using them in multiple combinations, OEMs are able to cover the full range of commercial air conditioning equipment from 20 to 400 kW (7 to 120 TR) of cooling.

Contact: Eric Walsh, Danfoss Ireland.

Tel: 01 - 626 8111;

Fax: 01 - 626 9334;

email: marketing@danfoss.ie



BS News would like to wish all our readers and advertisers a very happy Christmas and prosperous New Year

RADIATORS

Sharp Increase in Demand for Decorative Radiators

The European market for radiators continues its steady climb with sharp increases for decorative radiators and towel rails. The steel panel market is still the dominant product type, with sales of some 18.7 million units across Europe.

In addition, there are a further three million units of flat-fronted products sold in Germany which they regard as part of the steel panel market. (Elsewhere flat-fronted is a niche market). Across both types, 64% of sales are now for compact radiators (prefitted top grille and end panels). Even in the UK they are now over one-third of the market. In Germany, the majority of compact radiators have an integral valve and this market is increasing dramatically.

The "other steel" market is estimated to be two million units split roughly equally between the decorative type (flattened tube and decorative tubular)

and the traditional column type and lamellar. The decorative markets are growing significantly, whereas the traditional type is declining.

Towel rails are considered by some suppliers as part of the tubular radiator sector but they are covered separately. The market for towel rails/bathroom radiators is increasing

at over 7% per annum across the mainland European countries. In the UK and Ireland, the market has seen the biggest increase in value terms. The majority of the market is steel "ladder rail" types.

Around 42 million aluminium sections are sold in Europe (5.2 million radiators), and in value terms the European market is growing at 4% per annum. Aluminium

radiators have achieved significant success, particularly in Italy and Spain, where they are the most popular radiator sold. They are chosen for aesthetic reasons, their lower weight, the high performance per element, and quickness of response to temperature changes.

The cast iron market is also significant in Europe at 16 million sections (1.7 million radiators) but over 70% of sales are in Italy, where consumers still regard them as efficient, durable and reliable. They are losing share in both Italy and Spain to steel and aluminium which are lighter to handle and the costs are lower.

BSRIA's study, "The European Market for Radiators and Other Wet Heat Emitters" was published in September 2000 in five separate volumes, in addition to an overview report. It is over 360 pages long and contains 400 tables.

Contact: Andrew Giles, BSRIA.
 Tel: 0044 1344 426511;
 Fax: 0044 1344 487575;
 email: andrewg@bsria.co.uk
 Website: www.bsria.co.uk

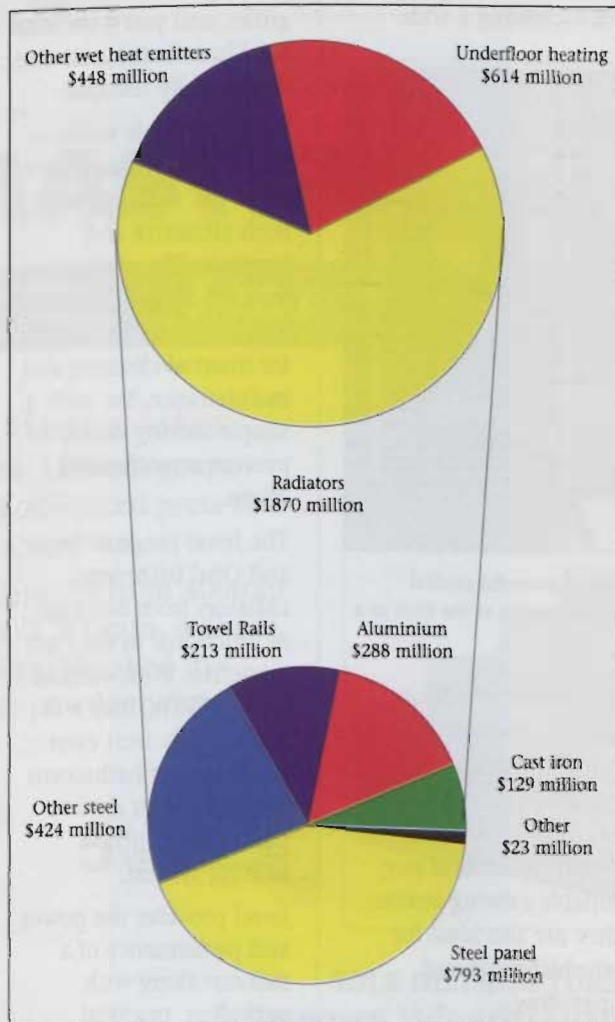

RADIATORS

Barlo - High Performance, Safety & Aesthetics

With its smooth, slim and shapely contours, and with none of the ugly top-tappings so rarely needed on domestic systems, the Barlo Round-Top radiator combines a discreet, modern appearance with high performance and classic good looks for safety, style and high performance.

Compare this to the sharp welded edge of a Seam-Top, and you'll see why it is potentially less hazardous to tumbling toddlers or the elderly.

looking good year after year.

Choose from the standard range of 185 Round-Top radiators, all of which are available ex-stock. With widths from 300mm (11") and six heights down to 220mm (8"), it is the most versatile range available, with size and heat output options to meet the most demanding of specifications.

Turning to the Barlo LST range, with a choice of 46 sizes covering a wide



Barlo dual power towel radiators combine powerful central heating in winter, with warm dry summer towels at the flick of a switch

A Barlo Round-Top radiator is hygienic and easy to keep clean, with none of those awkward top tappings or seams to collect dust, weep, or go rusty. The smooth, easy-to-wipe surface of its durable, powder-coated finish will keep on

range of heat outputs, there is a model to suit just about every application. Because the casings can be easily retrofitted around any suitable existing emitter, they are also ideal for refurbishment and upgrading.



Easy installed or retrofitted, Barlo single-piece LSTs restrict their surface temperature to a safe maximum of 43°C

The Barlo LST features a strong, single-piece casing that is easy to install, so fitting time is kept to an absolute minimum. Compare this to other LST's with their fiddly, bolt-together covers and grilles, and you'll see why total installation costs are dramatically reduced.

With no visible welds or ugly, dust-catching joints, Barlo LST radiators are both attractive and hygienic. The casing is forward-hinged, allowing easy access to the emitter for internal cleaning and maintenance, but with a simple locking device to prevent unauthorised access.

The Jewel range of Pearl and Opal bathroom radiators from Barlo are as functional as they are attractive. With outputs up to 1453W, they will comfortably heat even the largest of bathrooms on cold winter days as part of the central heating system.

Jewel provides the power and performance of a radiator along with appealing, practical

designs to combine all the convenience of a spacious towel rail with the luxury of warm, dry towels at any time of the day.

More and more people are warming to the beauty of a Barlo towel radiator in the bathroom. They are available in a range of sizes and heat outputs to suit all bathrooms and offer a wide choice of flat profiled (Pearl) or rounded (Opal) rails. All carry a 5-year guarantee.

Unmistakably superior in style, appearance and quality, they are available from stockists everywhere and can be easily fitted into new or existing bathrooms.

The luxury of warm towels is also possible when the central heating season ends. With the option of a separate electric heating element, the towel radiator becomes a summer towel warmer at the flick of a switch.

Contact: Barlo Radiators.
Tel: 052 - 27377.
Fax: 056 - 22195;
email: barlosls@indigo.ie

POTTERTON

Number one in
Central Heating

GAS BOILERS

OIL BOILERS

RADIATORS

CIRCULATING PUMPS

VALVES AND CONTROLS

Potterton Myson (Ireland) Ltd
Belgard Road, Tallaght, Dublin 24.
Tel: 01 459 0870; Fax: 01 459 0880

MYSON

HEATMASTER CONVECTOR RADIATORS

THE HOT LINE IN RADIATORS

Manufacturing — Heatmaster

Radiators are produced from 1.25mm gauge cold rolled steel employing advanced press tool technology in state of the art presses.

Radiators are produced in lengths from 400mm to 3000mm and in heights of 300mm, 400mm, 500mm, 600mm and 900mm. Finished in RAL9010 white electrostatic powder paint.



5 ★ ★ ★ ★ ★
YEAR Warranty



MAPLE MARKETING LTD.

SOLE DISTRIBUTORS IN IRELAND

Ballycurreen Industrial Estate, Airport Road, Cork.

Tel: 021 - 496 8388; Fax: 021 - 496 8454; email: maple@indigo.ie

RADIATORS

Veha V40 — First Choice Preference

Since its introduction, the Veha V40 range of angled and curved panel radiators has gained considerable market shares. Its increased outputs, coupled with aesthetic appeal, make it the first-preference choice of many installers and specifiers alike.

Veha Radiators has been producing radiators in Ireland since 1956 and in

markets. The modern warehouse facility houses radiators in five different heights and 13 lengths in single and double convectors, ex-stock. For the specialist market Veha provides angled and curved 3- and 4-panel radiators to order. Veha not only provides excellent choice but also provides an outstanding customer service.

Veha single and double A & C type radiators are manufactured to BS EN 442 under a quality system assessed against BS EN ISO 9002.

The concealed connections are so designed that, when used with the Veha patent mounting bracket pipe, runs do not have to be modified to mate with connections on multi-panel installations. Standard size 1/2" BSP. Sizes 3/8", 3/4", 1" BSP are also available.

The airvent fitted and tested in the factory is designed and located to allow easy access. For radiators with four connections an air vent can be located on the connections.

Each radiator is individually tested to 7-Bar pressure (103psi) in accordance with the requirements of BSEN442 and can be used with indirect systems or closed circuits at a working pressure not exceeding 4.66 bar pressure (67.6psi).

Veha radiators are prepared using a 5-stage cleaning, degreasing and anti-rust process and finished in a durable electrophoretic coating that requires no further painting. Each radiator is packaged with durable cardboard end pieces and a covering of vacuum sealed heavy duty polythene.

All radiators are supplied under warranty for five years in respect of defective materials and manufacture.

Veha Radiators V40 round-top convector radiators now offer increased heat outputs and improved design aesthetics

Veha towel radiators offer the comfort of controlled warmth with the added luxury of readily available heated dry towels.

Functional and attractive, with smooth lines and seamless construction

to complement their ergonomic styling, they protect the distinctive elegance that is synonymous with contemporary interior design.

They are ideal for both private and commercial projects including hotels, recreation centres and prestigious housing. Indeed they can be used anywhere that needs a heating and drying facility such as en-suite bedrooms, kitchens, cloakrooms or utility rooms.

There are three standard heights giving a choice of configurations and heat outputs. Also available is a range of electric towel warmers for applications where full room heating is not required.

All products are manufactured under BS 5750 : Part 2 quality management system, approved by BSI.

As part of the finishing, the radiators are degreased and phosphated before being epoxy polyester powder-coated and oven-baked to give an extremely durable, high-quality finish.

Contact: Veha Radiators.
Tel: 0404 67278;
Fax: 0404 67731.



From the Veha towel radiators and towel warmer range

1994 became part of Barlo Group Plc.

Veha Radiators provide customers with a vast range of products to suit the domestic, industrial and commercial

BTUtiful

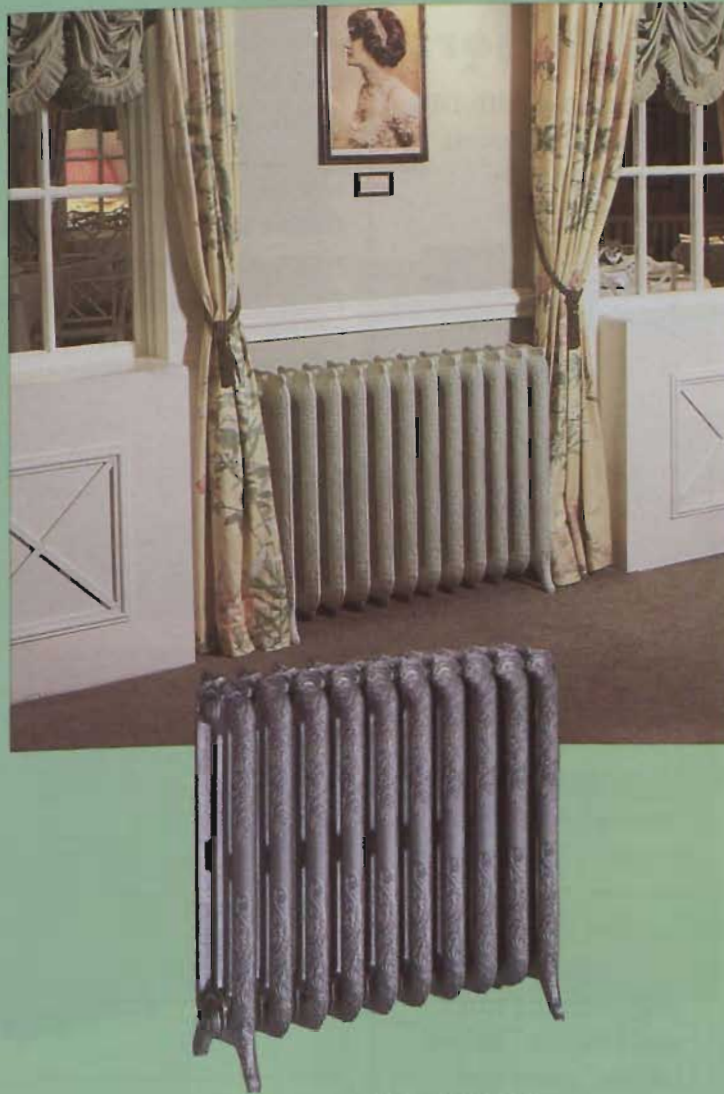

For style and elegance with BTUtiful traditional design and craftsmanship of yesteryear, the Chappee cast iron "Floreal" is the ideal radiator choice for a "classy" finishing touch in period buildings, or a spectacular contrast in contemporary settings. The "Floreal" is supplied in "old grey" natural shade but of course can be painted in any colour of your choice to enhance/complement your particular setting.

Despite its traditional origins, the "Floreal" is a very efficient and effective heating medium and is available in a range of sizes.

To see the full range of BTUtiful cast iron radiators, drop in to the Hevac showroom today.



Hevac Limited

70/72 Lower Dorset Street, Dublin 1. Tel: (353) 01 - 830 1211. Fax: (353) 01 - 830 1990. email: karlc@hevac.ie

Muirfield Drive, Naas Road, Dublin 12. Tel: (353) 01 - 419 1919.

South Ring West Business Park, Cork. Tel: (353) 021 - 432 1066. Fax: (353) 021 - 432 1068.

RADIATORS

HEATmaster — The Hot Line in Radiators

Cork-based company Maple Marketing Ltd expanded its building products portfolio in 1999 with the addition of two new product ranges ... the HEATmaster branded high-output, low water content compact convector radiators, and a stylish towel rail for bathroom and kitchen applications.

Maple Marketing Ltd was established in 1985 and has secured the exclusive Irish distribution rights for "HEATmaster" radiators and towel rails.

Since the launch of the HEATmaster in mid-1999, this product quickly succeeded in establishing a reputation for quality and service to a national network of builders providers and heating and plumbing merchants.

Designed for economical performance, style and efficiency, HEATmaster radiators are manufactured to the ISO9001 Quality System and are certified to DIN EN442. The final finishing process is in

compliance with DIN 55900. The process involves totally submerging all radiators in a primer paint which is oven-baked and finally coated by a series of multi-spray applications of RAL 9010 white epoxy-polyester electrostatic powder paint cured at 200°C.

Product Range & Type — The HEATmaster compact convector range includes factory-fitted top and side covers, at no extra cost, on both the single and double convector types. Chrome air vents, plugs, sealing rings, wall brackets, nylon buffers, screw and wall plugs are all included within the packaging of the radiator.

The range is produced in heights of 300mm, 400mm, 500mm, 600mm and 900mm, and in lengths from 400mm to 3000mm. Top and bottom opposite end 1/2" connectors are standard.

Packaging — The high quality, aesthetically-pleasing HEATmaster product

is carefully packed and protected by the use of carton box end-sleeves; plastic protectors fitted to wall plugs; bubble-wrapped; and finally double shrink-wrapped in a heavy gauge polythene protective film. The HEATmaster radiator is therefore fully-protected from factory despatch to final installation.

Customer Care & Service — Maple Marketing's nationwide delivery service (in partnership with its logistics operators) ensures that delivery will be made anywhere within 48 hours from receipt of order.

The HEATmaster ranges carry a 5-year, no-quibble guarantee against any defects



HEATmaster Towel Rail — This product is manufactured to the same exacting standards as the convector radiators, and also produced in the matching colour RAL 9010 white. The stylish and functional design enhances the utilisation of restricted spaces in bathrooms and kitchens, providing heat while holding and drying towels.

caused by faulty materials or manufacture. Experienced and friendly staff are readily available to assist and advise customers with technical and promotional back-up. Contact: Charles Wheeler, Emmet Martin, David Seaman. Tel: 021 - 496 8388; Fax: 021 - 496 8454; email: maple@indigo.ie



Merriott
DESIGN RADIATORS FROM BARLO



design
DESIGN SCAPES
scapes



RADIATORS

Myson Radiators – the Choice of Discerning Specifiers



Photo shows Myson Premier HE

Myson is one of Europe's leading manufacturers of radiators. For both domestic and commercial use, the Myson range offers a wide choice of models, outputs and sizes. This offers the installer or specifier complete flexibility and the knowledge that there is a Myson radiator to suit almost every possible situation. In addition, all Myson radiators carry at least a 5-year guarantee. The Myson radiator range consists of the Premier, Select, Chorus, LST and Plan radiators.

Premier – Myson Premier HE range offers our customers a range of elegant, stylish and highly-efficient radiators that are backed by the guarantee and experience from one of Europe's largest heating manufacturers.

With the unique high-efficiency convector plate, Myson has created a radiator that is more

compact and less obtrusive than others, while also increasing its efficiency and output.

Only fully-finished steel is used in the production of the Premier HE range and this, coupled with advanced welding techniques ensures the highest quality and durability.

Select – The Select is a seamtop radiator available as a standard, single and double convector, or complete with factory-fitted grilles and end-panels. The innovative design ensures that quality and outputs are of the highest order and these are approved to stringent British and European test procedures.

Chorus – Chorus radiators are elegantly and distinctively designed with a particular focus on aesthetics and performance. The Chorus range consists of four product types – the

Vertical, Horizontal, the Column and the Plinth.

As well as offering a stock range, Chorus radiators can be custom made, offering a wide choice of dimensions and colours. The Chorus range has become a popular choice for both commercial and domestic settings.

LST (Low Surface Temperature) – The low surface temperature of Myson LST radiators makes them ideal in situations where safety is paramount. Increasingly, they are specified and installed by health authorities, local authorities, government departments, leisure centres and public buildings. LST radiators come in a range of 62 sizes and outputs ranging from 325 watts to 3746 watts.

Plan – Myson Plan radiators are intended for use where architects or specifiers demand a flat unobtrusive front surface combined with great strength and durability. Plan radiators are available in 42 sizes and two models, Myson Plan and Myson Plan Plus. Heat outputs range from 562 watts to 2842 watts. Typical applications would include banks, offices, hotels and public buildings.

Elegant and stylish, Myson Towel Warmers are assembled by craftsmen using only the finest quality materials. In addition to enhancing the appearance of your bathroom, they are both economical and efficient to run.

Towel warmers should serve three primary functions – add to the comfort of a bathroom; keep towels warm and dry; and enhance the appearance of a bathroom. Some brands excel in one or more of these attributes but Myson fulfils all these criteria with the Myson Towel Warmer range.

There is a wide range of standard units of different designs to choose from, or one can be manufactured to personal requirements. These modifications include size, shape, colour, changes to tapping size and position, dezinc-proof units and copper panel radiators.

Stringent quality control ensures that the highest standards are maintained with every towel warmer pressure-tested before leaving the factory.

Models available include floor-standing and wall-mounted versions; multi-rails; brass, chrome or paint finishes; radiator towel warmers and electric towel warmers. There is also a full range of complementary accessories including valves, sleeving kits and wall stays.

Potterton Myson (Irl) will be introducing new radiator products to their already extensive range in early 2001.

Contact: Natasha Prendergast, Potterton Myson.
Tel: 01 - 459 0870;
Fax: 01 - 459 0880;
email: post@potterton-myson.ie
Website: www.myson.heating/control.com

Super V40



Veha Radiators' Super V40 range was specifically developed for current and projected market requirements. It represents a unique blend of all the technical expertise, knowledge and experience Veha Radiators has accumulated over the last 40 years, with the latest design and manufacturing techniques.

The result is a radiator that is aesthetically-pleasing, efficient, and highly competitive in the marketplace

FEATURES & BENEFITS

- ◆ Greater heat output due to fin length increase from 35mm to 40mm
- ◆ 5-year warranty in respect of defective materials and manufacture
- ◆ Stock range is manufactured to BS EN 442 under a quality system assessed against BS EN ISO 9002
- ◆ Each radiator is individually tested to 7-bar pressure (103psi)
- ◆ Single and double convector configurations
- ◆ Five heights
- ◆ Fourteen length options
- ◆ Standard tapings on all radiators are 1/2" BOE (bottom-opposite-end)
- ◆ 5-stage cleaning, degreasing and anti-rust process
- ◆ Durable, electrophoretic paint coating
- ◆ Suitable for indirect systems or closed circuits at a working pressure not exceeding 4.66-bar (67.6psi)
- ◆ The built-in air vent is projection welded to the rear of the panel



CONTACT

Sales Office

Veha Radiators Ltd, The Murrough, Co Wicklow

Tel: 0404 - 67278; Fax: 0404 - 67731



RADIATORS

Chappee Elegance by Hevac

When it comes to enhancing any location Chappee cast-iron column radiators are the perfect heat emitter. Its wide range of radiators offers a variety of styles and elegance unrivalled by any other manufacturer.

For period properties and traditional furnishing styles, the "Floreal" cast-iron radiator, with its delicate classic inlaid scrolled detail, offers traditional craftsmanship to complement and provide the perfect finishing touches to any building. The Floreal is the perfect radiator for that period building, restaurants, hospitality suites, hotels, receptions, public houses, conference facilities etc.

It is perfect either for new heating systems or for replacing outdated or antique radiators with the minimum

disruption to existing installations. The free-standing "Floreal" will avoid damage to walls, with its 750mm height it is ideal to fit neatly below standard dado rails. Supplied in an attractive gun-metal primer finish which will complement most colour schemes, although if required the "Floreal" can also be painted to match any decor requirement. Assembled radiators are available from Hevac's stores in Dublin and can be delivered to site in lengths comprising from three to 21 sections. Further sections may be assembled on site for longer finished radiators.

With classic simplicity of design the "Dune" radiator from Chappee



From the Chappee range of cast-iron radiators. Contact: Hevac Ltd

captures all the elegance and traditional quality of a bygone age. With similar dimensions and section widths to traditional and obsolete column radiators, the "Dune" provides the perfect replacement with the minimum disruption to existing installations.

Ideal for modern or traditional settings alike, the "Dune" is supplied from Hevac's Dublin store in a primer finish and can be delivered to site assembled or, where necessary, assembled on site.

To complement and complete the package Hevac offers a range of brass radiator valves which include the much-favoured, traditionally-styled solid brass Floreal Radiator valve available from Hevac in 1/2" and 3/4".

Detailed literature is available on request from Hevac Ltd.

Dublin

Tel: 01 - 830 1211/
01 - 419 1919;
Fax: 01 - 830 1990;
email: karlc@hevac.ie

Cork

Tel: 021 - 432 1066;
Fax: 021 - 432 1068.



*Enjoy safety and style
with a Barlo Low Surface
Temperature radiator*



RADIATORS

Merriott Design Radiators

Merriott Design Radiators are offered in a wide range of sizes and configurations, in both single or double-panel format. They can be floor or wall-mounted and are available with or without convector fins on one or both panels, and with a variety of fin height options. Hot water is evenly distributed via concealed headers, special valves and pipework can be accommodated.

In colours chosen for unobtrusive elegance or a boldly stylish feature, the distinctive smooth lines of Merriott panel radiators will enhance any interior. The

optical top grille is both attractive and practical.

Merriott panel radiators have no visible welds and all sharp corners and edges have been eliminated for maximum safety.

Available in any colour (white is standard) and heights from 70mm to 840mm; lengths from 300mm to 6000mm.

Exceptionally attractive both in their wide, low-height configurations and in narrow, floor-to-ceiling height configurations, the smooth, distinctive, lines of Merriott column radiators will enhance any commercial or domestic interior.

Space-saving Merriott wall or floor-mounted column radiators

combine high heat outputs with minimum wall space usage and allow pipework and connections to be hidden from view. Available in a wide range of size combinations to suit a variety of room heights, they can be made to



The smooth distinctive lines of Merriott column radiators will enhance any commercial or domestic interior

special order in heights from 300mm to 6000mm.

Versatile Merriott column radiators can be specified in single and double-element versions, with optional 35 or 70mm element depths and different element pitches.

Popular with architects for their creative possibilities, Merriott column radiators are ideal for mounting in front of windows or as a barrier/room divider,

where they maximise available light and visibility, while improving security and safety. Open construction gives good access for cleaning and inspection.

Contact: Frank Donohoe, Merriott Radiators.
Tel: 01 - 459 6213;
Fax: 01 - 451 5143;
email: fdonohoe@merriott radiators.com
Website: www.merriottradiators .com



Merriott Design Radiators are available in a wide range of sizes and configurations

MORE CHOICE, EXTRA PERFORMANCE, SUPERB QUALITY & SERVICE.

The new Stelrad Compact Range not only provides one of the largest choices of sizing options for compact radiators in Ireland – 233 models in the range – but excellence in output technology, giving outstanding heating performance and comes with a 10 year warranty.

With elegant top grilles and end panels designed specifically to give a tight, quality fit, together with robust, practical packaging and nationwide availability, the new Stelrad Compact Radiator has to be the right choice.



Caradon 
Plumbing Solutions

For details of stockists: Plumbing Distributors.
Tel: 01 - 837 6076; Fax: 01 - 836 7014

www.stelrad.com

 **Stelrad**
THE RIGHT CHOICE

RADIATORS

The Stelrad Compact

More Choice, Superb Quality, Service and Extra Performance

Not only has one of Ireland's market leaders in radiator technology improved outputs on the Stelrad Elite, a very popular naked radiator in the market, but now it has introduced yet another product of outstanding design and technical excellence.



Stelrad Elite

The new Stelrad Compact range comes complete with all the features expected from a market leader and more. Combining the most sophisticated production resources in Europe, with substantial investment directed towards extra performance, has resulted in the creation of a high-output compact radiator for outstanding heating performance. As you would expect, all Stelrad outputs conform to BS EN 442 — the European Standard for radiators.

Among the extensive range of 233 models on offer, there is a wide

choice of heights, from 300mm through to 2204mm. The options on length begin at 400mm up to the longest in the range at 3000mm, to fit the most challenging of application requirements.

The elegant, integrated top grille and side panels have been specifically designed to eradicate any movement, with a tight, professional, quality fit, which will remain in place, even after storage, transit and installation.

Not content with providing a compact radiator that matches the Elite in choice, quality and performance, there are additional products

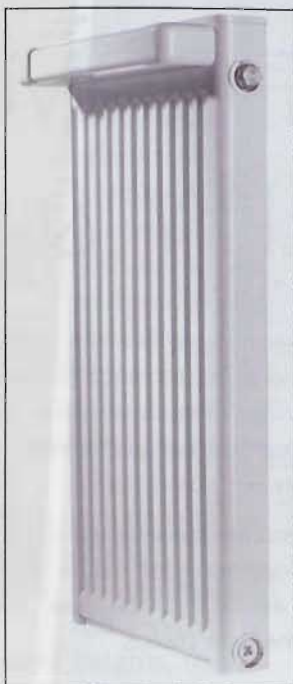

Stelrad Towel Rail

within the range designed for higher specification applications. The Stelrad Compact Towel Rail provides the unique solution for cloakrooms and bathrooms, while the creative design of the Stelrad Compact Vertex is ideal for applications where wall space is at a premium.

Whatever your application needs, you can rest assured that Stelrad has the right choice — naked and compact radiators, with guaranteed output performance, exceptional sizing flexibility, superb quality and nationwide availability, all wrapped up in a new, robust, but practical packaging that will keep the product in pristine condition from the time it leaves the factory right through to completion of installation!

To show the confidence Stelrad has in its products, both the Stelrad Elite and Stelrad Compact are now backed with a new 10-year warranty!

Stockists

Dublin — Davies of Fairview;

Cork — Cork Builders Providers;

Limerick — P J Matthews;



Stelrad Compact

Waterford — Paddy Power & Co;

Galway — Walsh & Co.

Stelrad's Irish distributors are also interested in other potential stockists who wish to join its network providing nationwide coverage.

Contact: Plumbing Distributors.

Tel: 01 - 837 6076;

Fax: 01 - 836 7014.

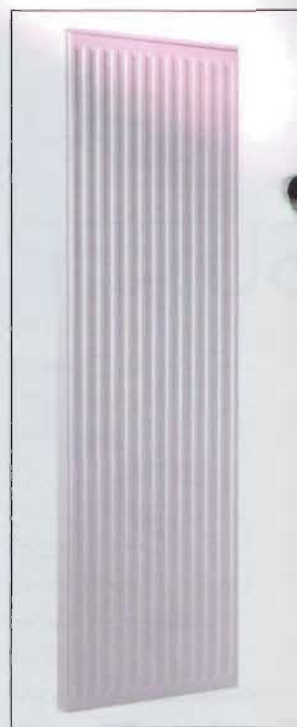

Stelrad Vertex

BSNews

brings you ...



New Business Introductions



An Eye to the Future



Balanced Comment



Food for Thought



Trend Directions



Global Technology Updates



News Bites

Subscriptions

edel@pressline.ie
Tel: 01 - 288 5001

Advertising

joe@pressline.ie
Tel: 01 - 288 5002

Editorial

pat@pressline.ie
Tel: 01 - 288 5003

ISH to Highlight Bathrooms & Accessories for the Disabled

They are called "barrier-free bathrooms", "vital bathrooms" or "safe bathrooms". Essentially, they are sanitary solutions for disabled people; senior and sick citizens; and for short and disproportionately tall people, briefly, for people with physical handicaps. At the ISH, the leading international trade fair for Sanitation and Heating Technology — 27 to 31 March, 2001 in Frankfurt — this subject will receive a lot of new helpful impulses.

Physical restrictions are a part of life. They begin with being too small as a child and with a young generation growing taller than average. They continue with an increasing number of people with back troubles and, of course, with the normal restrictions caused by age or illness. Many manufacturers of bathrooms are therefore concentrating with great intensity on solutions to make everyday life easier for this category.

That "bathrooms to cope with handicaps" can well dispense with the typical hospital character will be demonstrated by exhibitors at the coming ISH in Frankfurt. An astonishing variety of colours, materials, shapes and surfaces is on offer for a helpful and nevertheless attractive bathroom design. Here are some examples from the range of products:

Tap Systems — Ergonomic shapes and grippable surfaces make their use increasingly more comfortable. Lever taps or pull-out shower hoses on the hand washbasin are answers to many daily problems. For cases where there is little strength available: taps, which are easily opened and closed, which are safe and lie not too heavily in the hand, are a real blessing. This applies also to the thermostats on the shower or bath.

Washstands — A front surface curved inwards creates a lot of leg room, for example, for moving a wheelchair under or for sitting close on a stool. The manufacturers also provide washstands with wide storage place.

WC/Bidet — A sitting position for the WC raised by eight or ten centimetres is not only pleasant for especially tall people but also for weakened persons. Wall-suspended toilets with 70cm are available for wheelchair users. For the little ones, there is a special children's series with WC seats which has unfortunately tended to be forgotten, or a combination of WC and bidet.

Showers — The trend to removal of "obstacles" is in full swing. Shower trays are noticeably flatter. Showers at floor level for wheelchair users are an agreeable facility, just as for able-bodied persons. Because water and shower gel can make the floor dangerously slippery, a wide choice of "braking" surfaces supply the necessary stability when standing.

Tubs — Massaging jets and whirlpools are not only a luxury but also a therapy.

Bathroom Furniture — Lengthy sessions at the washbasin are easier to endure on a roller stool with a soft seat and wheels which block when loaded. The integrated laundry basket makes it doubly practical.

Accessories — Handles, which can also be used as towel rails, WC brushes with longer handles, easily-opened hygiene containers, toilet roll holder with an adjustable "brake". It is often the inconspicuous details which are most effective.



Gold Mine

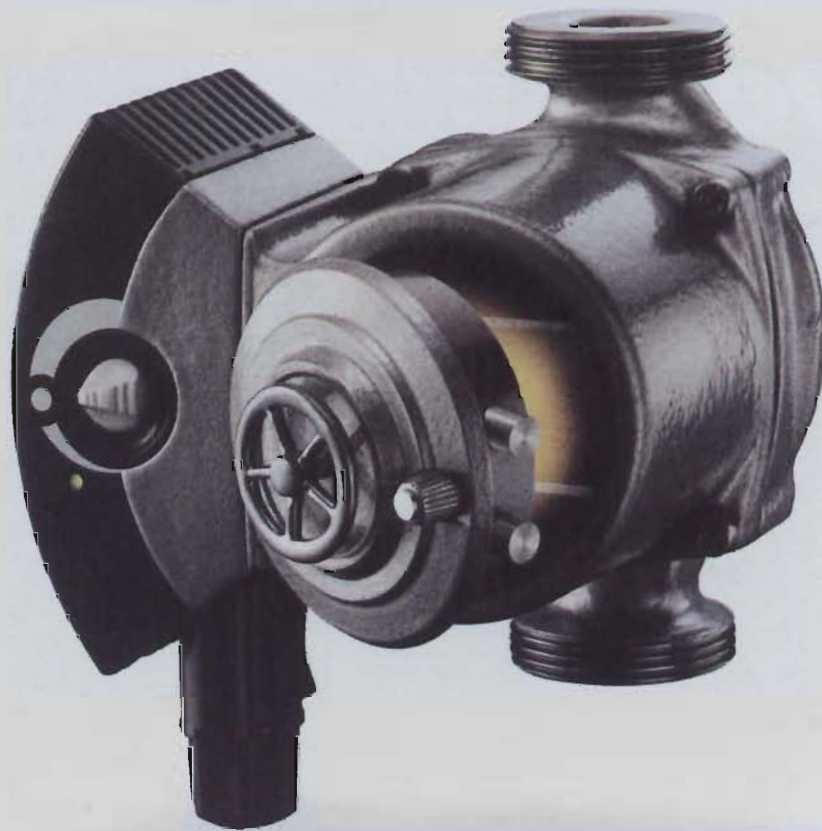

**Changing to Grundfos Alpha means reduced power consumption
— by up to 50% — with lower power bills as a result**

The secret of Grundfos Alpha is its automatic control, which ensures that the pump's pressure and flow is constantly adjusted to meet current needs. To put it another way: Grundfos Alpha automatically adapts itself to summer or winter, night or day.

An old-fashioned circulation pump on the other hand, pumps at the same speed around the clock. And at the same high pressure. Even at night, when the house occupants have turned down the heat, the pump just keeps on pumping.

It's like driving a car with your foot on the accelerator — then regulating the speed with the brake without taking your foot off the accelerator. A complete waste!

GRUNDFOS **alpha**

NOT JUST A PUMP — A NEW STANDARD



MANOTHERM LIMITED
THE CONTROL CENTRES

Building Services News, Vol 39, Iss 10 [2000], Art. 1
Tel: 01 - 452 2355/452 2229 Fax: 01 - 451 6919
E-mail: manotherm@eircom.net
U 15 BANBRIDGE ENTERPRISE CENTRE
SCARVA RD IND. EST., BANBRIDGE BT32 3QD, CO DOWN
Tel: 01820 669936 Fax: 01820 669990
E-mail: sales@manotherm.freeserve.co.uk

Dwyer®

C O N T R O L S
A N D
G A U G E S



PRESSURE



FLOW



LEVEL



TEMPERATURE



DWYER

MERCOID

W.E. ANDERSON

LOVE

PROXIMITY