

Reverse Mode of the Na^+ - Ca^{2+} Exchange After Myocardial Stretch

Underlying Mechanism of the Slow Force Response

Néstor G. Pérez, María C. Camilión de Hurtado, Horacio E. Cingolani

Abstract—This study was designed to gain additional insight into the mechanism of the slow force response (SFR) to stretch of cardiac muscle. SFR and changes in intracellular Na^+ concentration ($[\text{Na}^+]_i$) were assessed in cat papillary muscles stretched from 92% to $\approx 98\%$ of L_{max} . The SFR was $120 \pm 0.6\%$ ($n=5$) of the rapid initial phase and coincided with an increase in $[\text{Na}^+]_i$. The SFR was markedly depressed by Na^+ - H^+ exchanger inhibition, AT_1 receptor blockade, nonselective endothelin-receptor blockade and selective ET_A -receptor blockade, extracellular Na^+ removal, and inhibition of the reverse mode of the Na^+ - Ca^{2+} exchange by KB-R7943. KB-R7943 prevented the SFR but not the increase in $[\text{Na}^+]_i$. Inhibition of endothelin-converting enzyme activity by phosphoramidon suppressed both the SFR and the increase in $[\text{Na}^+]_i$. The SFR and the increase in $[\text{Na}^+]_i$ after stretch were both present in muscles with their endothelium (vascular and endocardial) made functionally inactive by Triton X-100. In these muscles, phosphoramidon also suppressed the SFR and the increase in $[\text{Na}^+]_i$. The data provide evidence that the last step of the autocrine-paracrine mechanism leading to the SFR to stretch is Ca^{2+} entry through the reverse mode of Na^+ - Ca^{2+} exchange. (*Circ Res.* 2001;88:376-382.)

Key Words: myocardial stretch ■ Na^+ - Ca^{2+} exchange ■ Na^+ - H^+ exchange ■ angiotensin II ■ endothelin

In experiments performed on cat papillary muscles, we found that stretch triggered an autocrine/paracrine mechanism that activated the Na^+ - H^+ exchange (NHE) and caused intracellular alkalinization.¹ The increase in intracellular pH (pH_i) seemed to be the result of a chain of events involving endogenous angiotensin II (Ang II) and endothelin (ET) in the muscles and activation of the NHE. Those experiments were performed in the nominal absence of bicarbonate, and the possible effect of the autocrine/paracrine mechanism on cardiac mechanics was not analyzed. In a subsequent study² on rat trabeculae bathed with a $\text{CO}_2/\text{HCO}_3^-$ -buffered medium, we showed the involvement of the above-mentioned autocrine/paracrine mechanism in the generation of the slow force response (SFR) to stretch. It is worth noting that despite the stretch-induced activation of the NHE, changes in pH_i may not be detected in the presence of $\text{CO}_2/\text{HCO}_3^-$ buffer,^{3,4} as in the experiments on rat trabeculae,² because of the simultaneous activation of the Na^+ -independent Cl^- - HCO_3^- exchanger (AE) by Ang II⁵ or ET.⁶

It is well-known that stretch of cardiac muscle generates a biphasic force response, with a rapid increase in force that has been attributed to increased myofilament Ca^{2+} responsiveness and a second slowly-developing phase, the SFR.^{2,7,8} The SFR was described by Parmley and Chuck⁹ in 1973 and constitutes the possible explanation for the Anrep effect.¹⁰⁻¹² Previous

reports showed that neither L-type Ca^{2+} currents¹³ nor the sarcoplasmic reticulum (SR)⁸ contribute to the increase in Ca^{2+} transient during the SFR. What we do know is that blockade of AT_1 or ET_A receptors prevents the increase in Ca^{2+} transient underlying the SFR.²

Considering these data and the fact that the blockade of the AT_1 or the ET_A receptors also prevented the increase in $[\text{Na}^+]_i$, because of the enhanced activity of the NHE,² we tested the notion that the Na^+ - Ca^{2+} exchange (NCX) mediates the increase in contractility. NCX is a sarcolemmal transporter that exchanges 3 Na^+ for each Ca^{2+} . At resting membrane potential, the exchanger functions in a $\text{Na}^+_{\text{in}}\text{-Ca}^{2+}_{\text{out}}$ mode (forward mode); when the membrane is depolarized positive to the exchanger reverse potential, NCX can bring Ca^{2+} into the cytosol and extrude Na^+ (reverse mode). Studies on feline ventricular myocytes provided evidence that NCX contributes to contraction by carrying Ca^{2+} into the cell during the plateau of the action potential.¹⁴ This is particularly important under conditions in which $[\text{Na}^+]_i$ increases. As pointed out by Eisner et al,¹⁵ the dependence of twitch tension on $[\text{Na}^+]_i$ is very steep. Thus, even small changes in $[\text{Na}^+]_i$ can have substantial effects on contraction. However, evidence that the NCX mediates SFR is still lacking. Experiments were designed to answer the following questions: (1) Does the NCX play a role in determining the SFR to stretch? (2) If the NCX

Original received August 17, 2000; revision received December 8, 2000; accepted December 28, 2000.

From the Centro de Investigaciones Cardiovasculares, Facultad de Ciencias Médicas, Universidad Nacional de La Plata, La Plata, Argentina.

Correspondence to Dr Horacio E. Cingolani, Centro de Investigaciones Cardiovasculares, Facultad de Ciencias Médicas, UNLP, 60 y 120 (1900) La Plata, Argentina. E-mail: cicme@atlas.med.unlp.edu.ar

© 2001 American Heart Association, Inc.

Circulation Research is available at <http://www.circresaha.org>

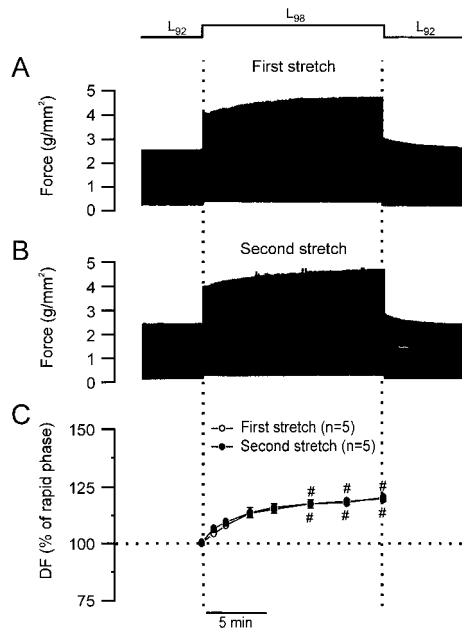

Figure 1. Characteristic force response to the stretch in isolated cat papillary muscle. A, Original record showing the characteristic biphasic force response to stretch. B, Force response to a second stretch on the same muscle (≈ 30 minutes apart). C, Averaged results for DF (in percent of the rapid phase) during the SFRs of 2 consecutive stretches from 5 separate experiments. $\#P < 0.05$ vs initial rapid phase.

mediates the SFR, is this effect attributable to decreased Ca²⁺ efflux or increased Ca²⁺ influx? (3) Do the endothelial cells in our multicellular preparation play a role in the development of the SFR?

Materials and Methods

The SFR to an increase in muscle length from 92% to 98% of L_{max} (termed L_{92} and L_{98} , respectively) was assessed on cat papillary muscles (0.48 ± 0.04 mm² of cross-sectional area), isometrically contracting at a rate of 0.2 Hz. Muscles were superfused with either bicarbonate- or HEPES-buffered solutions; all the experiments were performed at 30°C. Developed force (DF) in control conditions was 2 ± 0.1 g/mm² at L_{92} and 3.9 ± 0.2 at L_{98} . Our preparations were stable over 45 minutes or more, as shown in Figure 3D. Possible participation of catecholamines released by the nerve endings was prevented by prazosin plus atenolol (1 μ mol/L). Changes in $[Na^+]_i$ and pH_i were monitored by epifluorescence of sodium-binding benzofuran isophthallate (SBFI) or BCECF, respectively. The effects of the following experimental maneuvers on SFR development were analyzed: (1) extracellular Na⁺ removal; (2) functional inactivation of vascular and endocardial endothelial cells with Triton X-100 (TX)¹⁶; and (3) inhibition of NHE (1 μ mol/L HOE 642), reverse mode of NCX (5 μ mol/L KB-R7943), and endothelin-converting enzyme (ECE) (100 μ mol/L phosphoramidon) activities as well as AT₁ (1 μ mol/L losartan), ET_A (300 nmol/L BQ 123), or nonselective ET-receptor (0.1 or 1 μ mol/L TAK 044) blockade. The drugs were added to the perfusate 20 minutes before the stretch, and during this period, none of them changed DF by more than 3% to 4%. To avoid cellular Ca²⁺ overload in nominally Na⁺-free solutions, Ca²⁺ concentration was initially reduced to 0.1 mmol/L and then gradually increased until reaching the same DF as in normal extracellular Na⁺ concentration. We allowed DF to reach steady state before stretching the muscles.

An expanded Materials and Methods section can be found in an online data supplement available at <http://www.circresaha.org>.

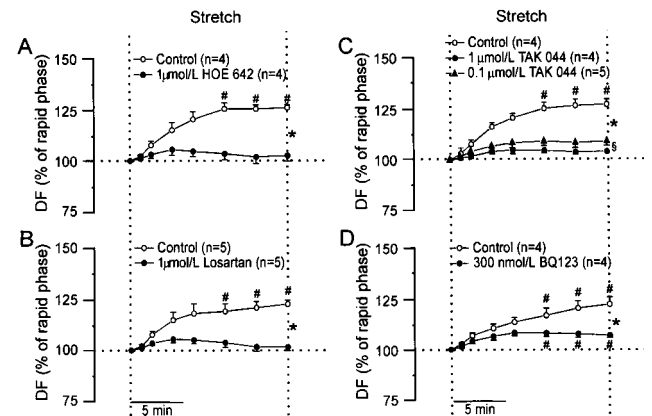

Figure 2. Effect of NHE inhibition and of AT₁ or ET receptor blockade on the SFR in cat myocardium. Averaged values of the SFR under control experimental conditions and after pharmacological interventions. A, NHE inhibition; B, blockade of AT₁ receptors; C, nonselective ET-receptor blockade; D, ET_A-receptor blockade. All of the pharmacological interventions markedly attenuated the SFR, providing evidence that the activation of the NHE as well as the endogenous release of Ang II and ET are prerequisites to generate the SFR in cat myocardium. $\#P < 0.05$ vs initial rapid phase. For the sake of clarity, significance is indicated only for points after 10 minutes of stretch. $*P < 0.05$ between control and pharmacological intervention curves (2-way ANOVA). $\$P < 0.05$ between 0.1 and 1 μ mol/L TAK 044 (2-way ANOVA).

Results

SFR in Cat Myocardium: General Aspects

Figure 1A shows the typical biphasic force response to stretch: a first, rapidly occurring increase and a second, gradually developing phase (the SFR). Figure 1B shows the force response to a second stretch on the same muscle (≈ 30 minutes apart). Figure 1C shows that the overall increase of DF during the SFRs elicited by 2 consecutive stretches reached similar magnitude after 15 minutes ($120 \pm 0.6\%$ first stretch versus $119 \pm 1\%$ second stretch, $n=5$, NS) and validates the comparison of consecutive stretches before and after pharmacological interventions, as later presented.

Experiments were performed to verify that the autocrine/paracrine mechanism (release of Ang II \rightarrow release of ET \rightarrow activation of the NHE) described in the rat as mediating the SFR² is also detected in cat papillary muscles. Figure 2A shows the effect of the NHE inhibition by HOE 642. Although perhaps predictable in light of our previous results in rat,² the SFR decreased after the selective blockade of the NHE. Figure 2B shows that the blockade of AT₁ receptors by losartan diminished the SFR. To investigate the involvement of ET, the effect of ET receptor blockade was tested. Figure 2C shows a concentration-dependent attenuation of the SFR in the presence of TAK 044, a nonselective ET receptor blocker. Figure 2D shows that ET_A receptor blockade with BQ 123 also caused a significant attenuation of the SFR.

These data agree with our results in rat² showing that ET_A-receptor blockade cancelled the SFR as well as the increase in Ca²⁺ after the stretch. The SFR in cat myocardium is then, as in rat,² the result of an autocrine-paracrine activation of the NHE by ET. The confirmation of this chain of events leading to the SFR in cat myocardium is important,

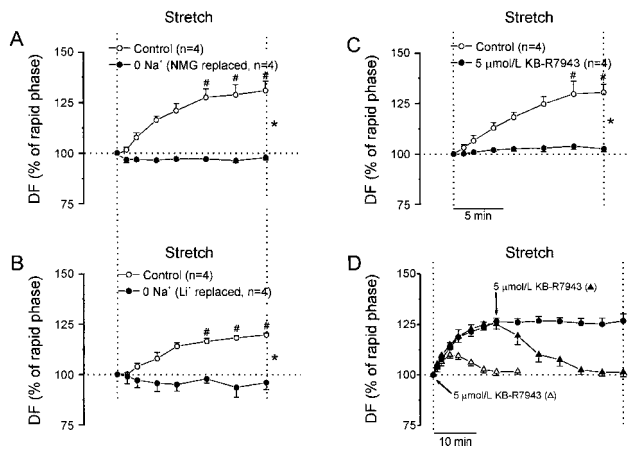

Figure 3. Role of NCX in the generation of the SFR. Results show that extracellular Na⁺ replacement by *N*-methyl-D-glucamine (NMG) (A) or by lithium (Li⁺) (B) abolished the SFR. KB-R7943 (C) also suppressed the SFR, supporting the idea that the reverse mode of the NCX is responsible for this phenomenon. D, KB-R7943 canceled the SFR, even if applied after the stretch. ●, Control stretch sustained for 45 minutes (n=4); ▲, KB-R7943 added 15 minutes after the onset of stretch (n=4); △, KB-R7943 added immediately after stretch (n=4). #*P*<0.05 vs initial rapid phase. **P*<0.05 between control and pharmacological intervention curves (2-way ANOVA).

because the existence of AT₁ receptors or their coupling to regulatory G proteins is controversial in adult rat cardiac myocytes.¹⁷⁻¹⁹

Role Played by the NCX in the Generation of the SFR

To explore the possible contribution of NCX activity, we studied the effect of extracellular Na⁺ deprivation (either replaced by LiCl or *N*-methyl-D-glucamine) on the SFR to stretch (Figures 3A and 3B). DF was maintained under nominally Na⁺-free conditions at the same level as in normal extracellular Na⁺ by adjusting Ca²⁺ concentration in the perfusate. After Na⁺ withdrawal, the SFR was cancelled. These results confirm the NCX involvement in the development of the SFR; however, they do not enable us to define whether this effect is mediated by the forward or the reverse mode of exchange. It may be argued that external Na⁺

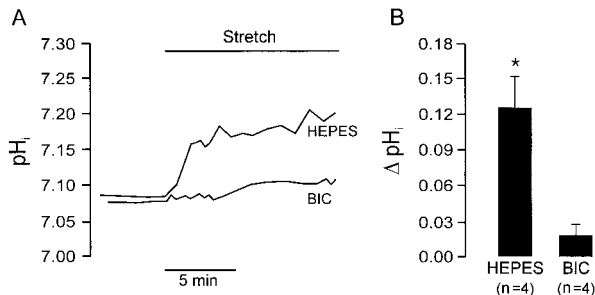

Figure 4. Absence of stretch-induced alkalinization in the presence of CO₂/HCO₃⁻ (BIC)-buffered medium. A, Values of pH_i before and during the stretch in representative experiments in nominally BIC-free (HEPES) or BIC-buffered medium. B, Mean±SEM of maximal changes in pH_i induced by stretch in HEPES- and BIC-buffered medium. N indicates number of experiments; **P*<0.05.

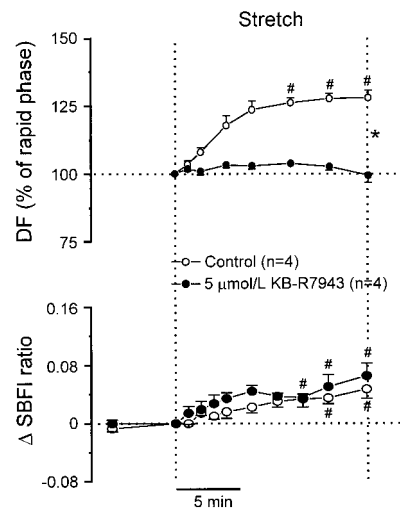

Figure 5. Inhibition of the reverse mode of NCX canceled the SFR but not the rise of [Na⁺]_i. SFR of control muscles (○, top) was accompanied by a significant increase in [Na⁺]_i (bottom). KB-R7943 (●) suppressed the SFR but not the increase in [Na⁺]_i. #*P*<0.05 vs initial rapid phase. **P*<0.05 between control and pharmacological intervention curves (2-way ANOVA). SBFI indicates sodium-binding benzofuran isophthallate.

withdrawal inhibits the NHE, and, in this respect, these results would provide no additional mechanistic insight than that derived from the HOE 642 experiments. However, under Na⁺-free Li⁺-replaced conditions, the NHE is still operative (exchanging Li⁺ for H⁺)²⁰ and the SFR was also abolished, arguing in favor of the NCX as the mechanism responsible for the SFR.

Whether the SFR is caused by the NCX operating in forward mode (decreasing Ca²⁺ efflux) or in reverse mode

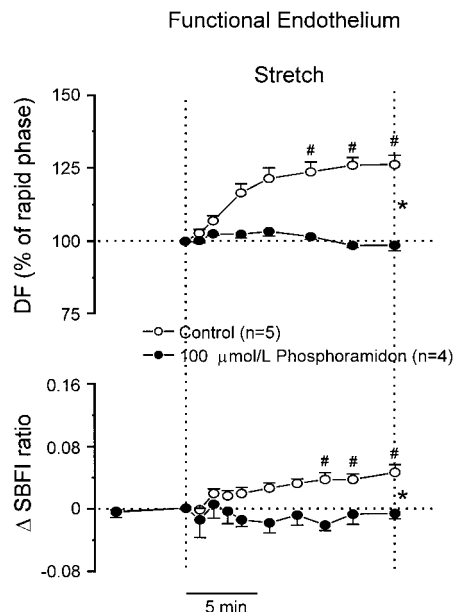

Figure 6. Effect of the specific inhibition of the ECE activity on the SFR. Inhibition of ECE activity by phosphoramidon suppressed both the SFR (top) and the rise in [Na⁺]_i (bottom), indicating that stretch increases conversion rate of big ET to ET and that ET itself is responsible for the increase in [Na⁺]_i and the SFR. #*P*<0.05 vs initial rapid phase. **P*<0.05 between control and pharmacological intervention curves (2-way ANOVA).

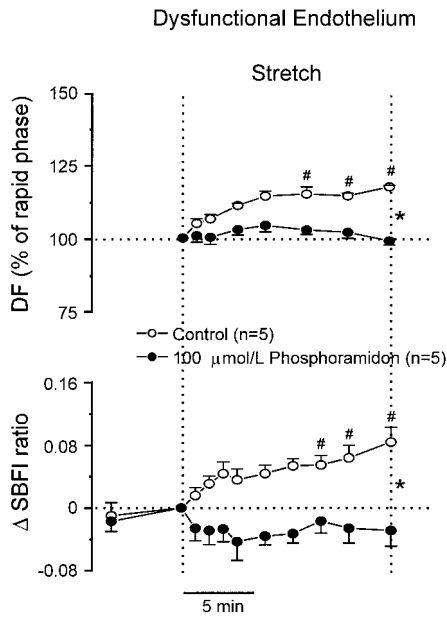

Figure 7. SFR of papillary muscles with dysfunctional endothelium. Both the SFR (top) and the increase in [Na⁺]_i (bottom) are present in papillary muscles with dysfunctional endothelium. On these muscles, phosphoramidon abolished both the SFR and the increase in [Na⁺]_i. #*P*<0.05 vs initial rapid phase. **P*<0.05 between control and pharmacological intervention curves (2-way ANOVA).

(increasing Ca²⁺ influx) was explored next, taking advantage of KB-R7943, a compound described as a selective inhibitor of the reverse mode of the NCX.^{21,22} Figure 3C shows that the SFR is cancelled in the presence of KB-R7943. The compound also abolished the SFR applied either immediately or 15 minutes after the stretch (Figure 3D). When KB-R7943 was added at the beginning of the stretch, the development of the SFR was interrupted after ≈3 to 5 minutes, whereas the SFR gradually decreased to the level of the initial phase with a *t*_{1/2} of 9.1±2.5 minutes (n=4) when it was added 15 minutes after the stretch.

Satoh et al²³ showed that 5 μmol/L of KB-R7943 selectively inhibited the reverse but not the forward mode of NCX in rat cardiomyocytes. It was recently suggested that KB-R7943 inhibition of ET-1-induced positive inotropic effect is attributable to the inhibition of the NCX reverse mode.²⁴ Because other nonspecific actions of KB-R7943 were also reported, such as prolongation of action potential duration (APD) and inhibition of Na⁺, L-type Ca²⁺, and K⁺ currents that could interfere with the SFR development,^{22,23} the effects of KB-R7943 on APD were analyzed in isolated cat ventricular myocytes. In 4 experiments, 5 μmol/L KB-R7943 altered neither the resting membrane potential nor the APD during the first 10 minutes after the pharmacological intervention. After 15 minutes, a slight but insignificant shortening of the APD₅₀ was detected (727±51 versus 629±55 ms, NS), whereas there was no change to the APD₉₀. The lack of effect of KB-R7943 on APD₉₀ compared with the ≈66% increase reported in rat myocardium,²³ possibly reflecting genuine species-dependent differences. Although APD prolongation may be a confounding factor in the rat, it does not seem to

explain the inhibition of the SFR by KB-R7943 in cat myocardium.

Because stretch activates NHE and an increase in pHi would increase DF by increasing myofilament Ca²⁺ responsiveness,²⁵ the effect of stretch on pHi was explored. The pHi response varied with the presence or absence of bicarbonate (Figure 4). In the nominal absence of bicarbonate, pHi increased, in agreement with our previous results.^{1,2} In the presence of bicarbonate there was no significant change in pHi after stretch, which can be explained by simultaneous Ang II-induced or ET-1-induced activation of one acidifying and one alkalinizing mechanism (NHE and AE).^{5,6}

Given the fact that in bicarbonate, the expected alkalinization after NHE activation is blunted, we sought to determine the increase in [Na⁺]_i as a marker of NHE activity and the cause of the Ca²⁺ transient increase during the SFR. Figure 5 shows that the SFR was accompanied by an increase in SBFI fluorescence ratios that would correspond to an estimated increase in [Na⁺]_i of ≈6 mmol/L after 10 minutes of stretch. When muscle length was returned to L₉₂, there was also a return of [Na⁺]_i toward baseline levels, with a *t*_{1/2} of 2±0.5 minutes. In the presence of KB-R7943, the SFR was suppressed, but the increase in [Na⁺]_i was still present (Figure 5). These results are compatible with the idea that the NCX

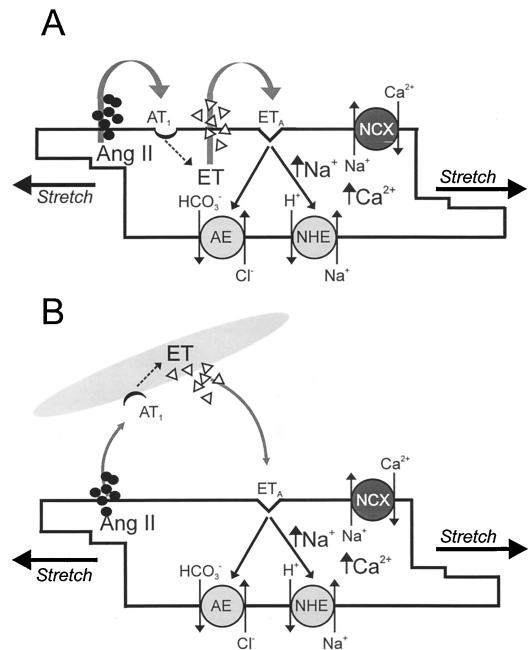

Figure 8. Hypothetical alternative pathways to explain the SFR. Autocrine and paracrine signaling pathways are schematized in A and B, respectively. A, Stretch releases stored Ang II that will bind to the AT₁ receptors of the myocyte. The myocyte forms and releases ET, which, through the ET_A receptors, stimulates NHE activity by a protein kinase C-dependent pathway. The simultaneous activation of the acidifying mechanism (AE) precludes changes in pHi, but [Na⁺]_i rises. The increase in [Na⁺]_i will activate the NCX in its reverse mode (Ca²⁺_{in}-Na⁺_{out}), and this will increase the [Ca²⁺]_i transient. B, Mechanism is similar to panel A, but the source of ET is the fibroblast instead of the myocyte. Ang II released by the myocyte stimulates AT₁ receptors on fibroblasts in a paracrine fashion, inducing the formation and release of ET. ET released by fibroblasts will act on the ET_A receptors of myocytes in a cross-talked paracrine loop.

operating in the reverse mode ($\text{Ca}^{2+}_{\text{in}}\text{-Na}^{+}_{\text{out}}$ mode) is the final step that links the increase in $[\text{Na}^{+}]_{\text{i}}$, caused by the NHE activation, to the increase in the Ca^{2+} transient during the SFR.^{2,7,8}

Possible Role of Endothelial Cells on the SFR

The present results and our previous studies in the rat² provide evidence that the release and formation of ET is a mandatory step between Ang II and the activation of the NHE, causing the increase in $[\text{Na}^{+}]_{\text{i}}$ and the SFR. However, it is not yet clear whether stretch-induced release of ET is attributable to increased cleavage of big ET to ET by its converting enzyme or to augmented release of preformed peptide. Figure 6 shows that ECE inhibition suppressed both the SFR and the rise in $[\text{Na}^{+}]_{\text{i}}$. This finding suggests that Ang II increases the conversion rate of big ET and reinforces the idea that ET itself is the last agonist of the autocrine/paracrine mechanism. Although it was previously demonstrated that Ang II increases prepro ET-1 mRNA levels,²⁶ a direct Ang II stimulatory effect on ECE activity²⁷ should also be considered.

To address whether endothelial cells were the source of ET, the endocardial and vascular endothelial cells were functionally inactivated by a 2-step pretreatment with TX,¹⁶ comprising the injection of TX in the coronaries before dissection of the papillary muscles (vascular endothelium inactivation) and flushing the isolated muscles with TX (endocardial endothelium inactivation). Figure 7 shows that after endothelial inactivation the SFR and the increase in $[\text{Na}^{+}]_{\text{i}}$ after the stretch both persisted and that both were blocked by phosphoramidon. The increase in $[\text{Na}^{+}]_{\text{i}}$ detected after stretch was somewhat higher than in muscles having functional endothelium. We do not have a reasonable explanation for this unexpected finding. Perhaps dysfunctional endothelial cells accumulate Na^{+} or interfere with its measurement or the myocytes accumulate Na^{+} after the TX treatment. In any case, the SFR was present even in muscles with dysfunctional endothelium, and phosphoramidon was able to abolish both the SFR and the increase in $[\text{Na}^{+}]_{\text{i}}$. Therefore, these data suggest that endothelial cells are not the source for ET. However, one should be cautious, because although the efficacy of TX to produce endothelial dysfunction and abolish NO function are well-accepted,¹⁶ the same rationale may not apply for the production and release of ET.

Discussion

The data presented here confirm and extend the previous finding in the rat myocardium that the increase in the Ca^{2+} transient generating the SFR is the result of an autocrine/paracrine mechanism. A major novel contribution of this study is to demonstrate the involvement of the NCX as a mechanism responsible for the SFR. This possibility, although suggested, was not proven previously.² The experiments showing the suppression of the SFR after external Na^{+} withdrawal strongly suggest that the NCX is required for the development of the SFR. The abolition of the SFR by KB-R7943 would support that NCX operating in the reverse mode is responsible for the SFR. The rise in $[\text{Na}^{+}]_{\text{i}}$ consequent to the ET-induced stimulation of NHE activity shifts

the thermodynamic balance of the NCX, promoting the reverse mode of exchange or increasing the time during which the NCX operates in its reverse mode. Whether there is also a contribution of a direct ET stimulatory effect on NCX²⁸ in addition to the increase in $[\text{Na}^{+}]_{\text{i}}$ is not clear. However, we should keep in mind that the increase in $[\text{Na}^{+}]_{\text{i}}$ is a mandatory step for SFR development.

The question of why the elevation of $[\text{Na}^{+}]_{\text{i}}$ is not corrected by the $\text{Na}^{+}\text{-K}^{+}\text{-ATPase}$ activity may be raised. However, we may speculate that, similarly to the Na^{+} pump lag hypothesis for the force-frequency relationship, the greater Na^{+} entry is balanced by increased Na^{+} pump activity but only at the cost of elevated $[\text{Na}^{+}]_{\text{i}}$ and, hence, increased Ca^{2+} entry.

In our experiments, the SFR was diminished by the ET_A blocker BQ123 and practically abolished by the nonselective ET blocker TAK 044. These findings would be consistent with the involvement of both the ET_A and ET_B subtype of receptors in the development of the SFR. However, it has been shown previously in rabbit myocardium that the positive inotropic effect of ET-1 is mediated by an ET_{A2} subtype of receptor that is less sensitive to BQ123 than to TAK 044.²⁹ Besides stimulating NHE activity, ET is known to have other potentially inotropic effects, such as those derived from its action on L-type Ca^{2+} or K^{+} currents. However, studies of the effects of ET-1 on L-type Ca^{2+} or K^{+} currents are conflicting,^{30–33} and in our experiments the development of the SFR was abolished by preventing the rise in $[\text{Na}^{+}]_{\text{i}}$.

Evidence regarding a possible relationship between cAMP levels and SFR was recently presented in ferret papillary muscles.³⁴ An increase in cAMP was detected in the muscles in which the SFR was present, whereas there was no increase in cAMP when the SFR was absent. It is difficult to compare these data with ours. In our study, it was very unusual to have cat papillary muscles that did not develop the SFR after stretch. Furthermore, our previous experiments^{1,2} and those described here were performed in the presence of α - and β -adrenergic receptor blockade to avoid the possible effects of catecholamine release.

In this study, KB-R7943 prevented the SFR despite the increase in $[\text{Na}^{+}]_{\text{i}}$. Although 5 $\mu\text{mol/L}$ KB-R7943 inhibits the reverse mode of NCX but not the forward mode in the rat myocardium,²³ we did not confirm that this is the case in cat myocardium. The possibility that KB-R7943 at the concentration used affected to some extent the forward mode of the NCX cannot be completely denied. The increase in $[\text{Na}^{+}]_{\text{i}}$ would decrease the forward mode of NCX ($\text{Ca}^{2+}_{\text{out}}\text{-Na}^{+}_{\text{in}}$), increasing diastolic Ca^{2+} and leading to greater Ca^{2+} sequestration by the SR, which finally would increase Ca^{2+} transient. Therefore, by inhibiting the forward mode of the NCX, KB-R7943 would be capable of blocking the SFR. This possibility is unlikely, because, first, this compound was previously shown to inhibit mainly the reverse mode of the NCX, acting as a competitive inhibitor with external Ca^{2+} .²² Furthermore, we² and other investigators⁸ have reported the lack of changes in diastolic Ca^{2+} during SFR development, and the possible role played by the SR in the SFR was recently ruled out.⁸ It is interesting that, analyzing the potential contribution of sarcolemmal ion fluxes to SFR development in an ionic model of cardiac myocytes, Bluhm et

al³⁵ found that the SFR could be mimicked by an increase in $[Na^+]_i$ that concurred with an increase in Ca^{2+} entry through the NCX. In any case, the SFR was practically abolished by blocking the NHE and AT₁ or ET_A receptors as well as by pharmacological blockade of the NCX in reverse mode.

No changes in DF were detected when KB-R7943 was added 20 minutes before stretching the muscle from L_{92} to L_{98} , which contrasts with the fade of the SFR when this compound was applied after the onset of the SFR (Figure 3D). One possible explanation could be a lack of SFR to stretches performed at lower muscle lengths, ie, from 86% to 92% of L_{max} . However, stretching between these 2 lengths promoted a SFR of similar magnitude (data not shown) to the ones reported here. Other possibilities to be considered are that the SFR could diminish after a certain time or would not be sustained by an increase in the Ca^{2+} transient because of the reverse mode of the NCX. We do not have a clear explanation for the lack of changes in DF after the addition of KB-R7943 in control conditions.

The fact that the inhibition of the ECE by phosphoramidon prevented the rise in $[Na^+]_i$ and the SFR allows us to conclude that the stretch (through AT₁ receptors) enhances the conversion of big ET to ET instead of promoting the release of previously formed and stored ET. ECE was originally described to be expressed on cell membrane with the catalytic site in the extracellular domain.³⁶ Two ECE isoforms (ECE-1 and ECE-2) can be differentiated by their optimum pH and sensitivity to phosphoramidon (ECE-2 ≈250-fold more sensitive than ECE-1).³⁷ We chose for our study a phosphoramidon concentration that assured complete inhibition of both isoforms³⁸; thus, we cannot distinguish which isoform is involved. Yamazaki et al³⁹ showed that ET-1 was constitutively released by neonatal rat cardiomyocytes and that ET-1 mRNA levels were increased by stretch. In the same study, the authors proposed that ET and Ang II synergistically mediate the hypertrophic response to stretch. Our present results showing the suppression of the SFR with phosphoramidon as well as with TAK 044 strongly favor the idea that ET alone is the final mediator of the autocrine/paracrine mechanism leading to the SFR, at least in adult myocardium.

The presence of SFR in muscles with vascular and endothelial cells functionally inactive indicates, despite the limitations of the method, that Ang II and ET are released by cells other than endothelial ones. Ang II and ET can be produced either by myocytes or fibroblasts. We do not have any evidence of which cell type is the source of the peptides. In this regard, two topics merit consideration. First, the SFR can be detected in isolated rat myocytes.¹³ Although this finding supports the theory of an autocrine mechanism, we should keep in mind that fibroblasts may contaminate isolated myocyte preparations.⁴⁰ Second, the SFR was detected in our previous study on adult rat trabeculae² despite the fact that the presence of AT₁ receptors and their coupling to regulatory G proteins have been disputed in adult rat cardiac myocytes.^{17–20} Because acute stretch can stimulate the release of prestored Ang II from myocytes but not from fibroblasts,⁴¹ the alternative of a paracrine pathway may be proposed. Whereas in an autocrine mechanism the myocyte will be the source and the target of Ang II and ET (as

schematized in Figure 8), in the paracrine mechanism the Ang II released by the myocytes will bind the AT₁ receptors of rat fibroblasts, where they are highly expressed.⁴² The activation of AT₁ receptors on fibroblasts will induce the formation or release of ET by these cells. ET, also in a paracrine fashion, will act on the myocytes, rich in ET_A receptors,¹⁸ and will increase $[Na^+]_i$ through the stimulation of the NHE and $[Ca^{2+}]_i$ through the NCX operating in reverse mode. This hypothesis is consistent with a previous report that ET-1 produced by nonmyocyte cells regulates myocyte growth in a paracrine fashion.⁴³

Acknowledgments

This work was partially supported by grant Proyecto de Investigación Plurianual 4058/96 to M.C.C.H. from Consejo Nacional de Investigaciones Científicas y Técnicas, Argentina. N.G.P., M.C.C.H., and H.E.C. are Established Investigators of Consejo Nacional de Investigaciones Científicas y Técnicas.

References

1. Cingolani HE, Alvarez BV, Ennis IL, Camilión de Hurtado MC. Stretch-induced alkalization of feline papillary muscle: an autocrine-paracrine system. *Circ Res*. 1998;83:775–780.
2. Alvarez BV, Pérez NG, Ennis IL, Camilión de Hurtado MC, Cingolani HE. Mechanisms underlying the increase in force and calcium transient that follows stretch of cardiac muscle: A possible explanation of the Anrep effect. *Circ Res*. 1999;85:716–722.
3. Boron WF, Boyarski G, Ganz M. Regulation of intracellular pH in renal mesangial cells. *Ann NY Acad Sci*. 1989;574:321–332.
4. Mattiazzi AR, Pérez NG, Vila Petroff MG, Alvarez B, Camilión de Hurtado MC, Cingolani HE. Dissociation between positive inotropic and alkalizing effect of angiotensin II in feline myocardium. *Am J Physiol*. 1997;272:H1131–H1136.
5. Camilión de Hurtado MC, Alvarez BV, Pérez NG, Ennis IL, Cingolani HE. Angiotensin II activates Na⁺-independent Cl⁻/HCO₃⁻ exchange in ventricular myocardium. *Circ Res*. 1998;82:473–481.
6. Camilión de Hurtado MC, Alvarez BV, Ennis IL, Cingolani HE. Stimulation of myocardial Na⁺-independent Cl⁻/HCO₃⁻ exchanger by angiotensin II is mediated by endogenous endothelin. *Circ Res*. 2000;86:622–627.
7. Allen DG, Kurihara S. The effects of muscle length on intracellular calcium transients in mammalian cardiac muscle. *J Physiol (Lond)*. 1982;327:79–94.
8. Kentish JC, Wrzosek A. Changes in force and cytosolic Ca²⁺ concentration after length changes in isolated rat ventricular trabeculae. *J Physiol (Lond)*. 1998;506:431–444.
9. Parmley WW, Chuck L. Length-dependent changes in myocardial contractile state. *Am J Physiol*. 1973;224:1195–1199.
10. von Anrep G. On the part played by the suprarenals in the normal vascular reactions on the body. *J Physiol (Lond)*. 1912;45:307–317.
11. Lew WYW. Mechanisms of volume-induced increase in left ventricular contractility. *Am J Physiol*. 1993;265:H1778–H1786.
12. Tucci PJ, Bregagnollo EA, Spadaro J, Cicogna AC, Ribeiro MC. Length dependence of activation studied in the isovolumic blood-perfused dog heart. *Circ Res*. 1984;55:59–66.
13. Hongo K, White E, Le Guennec J-Y, Orchard CH. Changes in $[Ca^{2+}]_i$, $[Na^+]_i$, and Ca^{2+} current in isolated rat ventricular myocytes following an increase in cell length. *J Physiol (Lond)*. 1996;491:609–619.
14. Nuss HB, Houser SR. Sodium-calcium exchange-mediated contractions in feline ventricular myocytes. *Am J Physiol*. 1992;263:H1161–H1169.
15. Eisner DA, Lederer WJ, Vaughan-Jones RD. The quantitative relationship between twitch tension and intracellular sodium activity in sheep cardiac Purkinje fibres. *J Physiol (Lond)*. 1984;355:251–266.
16. Li K, Rouleau JL, Andries LJ, Brutsaert DL. Effect of dysfunctional endothelium on myocardial performance in isolated papillary muscles. *Circ Res*. 1993;72:768–777.
17. Ishihata A, Endoh M. Species-related differences in inotropic effects of angiotensin II in mammalian ventricular muscle: receptors, subtypes and phosphoinositide hydrolysis. *Br J Pharmacol*. 1995;114:447–453.

18. Fareh J, Touyz RM, Schiffrin EL, Thibault G. Endothelin-1 and angiotensin II receptors in cells from rat hypertrophied heart. Receptor regulation and intracellular Ca^{2+} modulation. *Circ Res*. 1996;78:302–311.
19. Meszaros JG, Gonzalez AM, Endo-Mochizuki Y, Villegas S, Villarreal F, Brunton LL. Identification of G protein-coupled signaling pathways in cardiac fibroblasts: cross talk between G_q and G_s . *Am J Physiol*. 2000;278:C154–C162.
20. Frelin C, Vigne P, Ladoux A, Lazdunski M. The regulation of the intracellular pH in cells from vertebrates. *Eur J Biochem*. 1988;174:3–14.
21. Iwamoto T, Watano T, Shigekawa M. A novel isothiourea derivative selectively inhibits the reverse mode of Na^+/Ca^{2+} exchange in cells expressing NCX1. *J Biol Chem*. 1996;271:22391–22397.
22. Watano T, Kimura J, Morita T, Nakanishi H. A novel antagonist, No. 7943, of the Na^+/Ca^{2+} exchange current in guinea-pig cardiac ventricular cells. *Br J Pharmacol*. 1996;119:555–63.
23. Satoh H, Ginsburg KS, Qing K, Terada H, Hayashi H, Bers DM. KB-R7943 block of Ca^{2+} influx via Na^+/Ca^{2+} exchange does not alter twitches or glycoside inotropy but prevents Ca^{2+} overload in rat ventricular myocytes. *Circulation*. 2000;101:1441–1446.
24. Yang HT, Sakurai K, Sugawara H, Watanabe T, Norota I, Endoh M. Role of Na^+/Ca^{2+} exchange in endothelin-1-induced increases in Ca^{2+} transient and contractility in rabbit ventricular myocytes: pharmacological analysis with KB-R7943. *Br J Pharmacol*. 1999;126:1785–1795.
25. Fabiato A, Fabiato F. Effects of pH on the myofilaments and the sarcoplasmic reticulum of skinned cells from cardiac and skeletal muscles. *J Physiol (Lond)*. 1978;276:233–255.
26. Ito H, Hirata Y, Adachi S, Tanaka M, Tsujino M, Koike A, Nogami A, Marumo F, Hiroe M. Endothelin-1 is an autocrine/paracrine factor in the mechanism of angiotensin II-induced hypertrophy in cultured rat cardiomyocytes. *J Clin Invest*. 1993;92:398–403.
27. Barton M, Shaw S, d'Uscio LV, Moreau P, Luscher TF. Angiotensin II increases vascular and renal endothelin-1 and functional endothelin converting enzyme activity in vivo: role of ETA receptors for endothelin regulation. *Biochem Biophys Res Commun*. 1997;238:861–865.
28. Ballard C, Schaffer S. Stimulation of the Na^+/Ca^{2+} exchanger by phenylephrine, angiotensin II and endothelin 1. *J Mol Cell Cardiol*. 1996;28:11–17.
29. Endoh M, Fujita S, Yang HT, Talukder MA, Maruya J, Norota I. Endothelin receptor subtypes, signal transduction, regulation of Ca^{2+} transients and contractility in rabbit ventricular myocardium. *Life Sci*. 1998;62:1485–1489.
30. Cheng TH, Chang CY, Wei J, Lin CI. Effects of endothelin 1 on calcium and sodium currents in isolated human cardiac myocytes. *Can J Physiol Pharmacol*. 1995;73:1774–1783.
31. Vigne P, Breittmayer JP, Marsault R, Frelin C. Endothelin mobilizes Ca^{2+} from a caffeine- and ryanodine-insensitive intracellular pool in rat atrial cells. *J Biol Chem*. 1990;265:6782–6787.
32. He JQ, Pi Y, Walker JW, Kamp TJ. Endothelin-1 and photoreleased diacylglycerol increase L-type Ca^{2+} current by activation of protein kinase C in rat ventricular myocytes. *J Physiol (Lond)*. 2000;524:807–820.
33. Washizuka T, Horie M, Watanuki M, Sasayama S. Endothelin-1 inhibits the slow component of cardiac delayed rectifier K^+ currents via a pertussis toxin-sensitive mechanism. *Circ Res*. 1997;81:211–218.
34. Calaghan SC, Colyer J, White E. Cyclic AMP but not phosphorylation of phospholamban contributes to the slow inotropic response to stretch in ferret papillary muscle. *Pflügers Arch*. 1999;437:780–782.
35. Bluhm WF, Lew WY, Garfinkel A, McCulloch AD. Mechanism of length history-dependent tension in an ionic model of the cardiac myocyte. *Am J Physiol*. 1998;274:H1032–H1040.
36. Wu-Wong JR, Budzik GP, Devine EM, Opgenorth TJ. Characterization of endothelin converting enzyme in rat lung. *Biochem Biophys Res Commun*. 1990;171:1291–1296.
37. Emoto N, Yanagisawa M. Endothelin-converting enzyme-2 is a membrane-bound phosphoramidon-sensitive metalloprotease with acidic pH optimum. *J Biol Chem*. 1995;270:15262–15268.
38. Russell FD, Davenport AP. Evidence for intracellular endothelin-converting enzyme-2 expression in cultured human vascular endothelial cells. *Circ Res*. 1999;84:891–896.
39. Yamazaki T, Komuro I, Kudoh S, Zou Y, Shiojima I, Hiroi Y, Mizuno T, Maemura K, Kurihara H, Aikawa R, Takano H, Yazaki Y. Endothelin-1 is involved in mechanical stress-induced cardiomyocyte hypertrophy. *J Biol Chem*. 1996;271:3221–3228.
40. Sil P, Sen S. Angiotensin II and myocyte growth: role of fibroblasts. *Hypertension*. 1997;30:209–216.
41. Sadoshima J, Xu Y, Slayter HS, Izumo S. Autocrine release of angiotensin II mediates stretch-induced hypertrophy of cardiac myocytes in vitro. *Cell*. 1993;75:977–984.
42. Villarreal FJ, Kim NN, Ungab GD, Printz MP, Dillmann WH. Identification of functional angiotensin II receptors on rat cardiac fibroblasts. *Circulation*. 1993;88:2849–2861.
43. Harada M, Itoh H, Nakagawa O, Ogawa Y, Miyamoto Y, Kuwahara K, Ogawa E, Igaki T, Yamashita J, Masuda I, Yoshimasa T, Tanaka I, Saito Y, Nakao K. Significance of ventricular myocytes and nonmyocytes interaction during cardiocyte hypertrophy: evidence for endothelin-1 as a paracrine hypertrophic factor from cardiac nonmyocytes. *Circulation*. 1997;96:3737–3744.