

# Design and Development of Activity Attendance Monitoring System based on RFID

*by* Okfalisa Okafalisa

---

**Submission date:** 30-Mar-2020 12:15PM (UTC+0700)

**Submission ID:** 1285069526

**File name:** pment\_of\_Activity\_Attendance\_Monitoring\_System\_based\_on\_RFID.pdf (385.16K)

**Word count:** 3787

**Character count:** 20295

## Design and development of activity attendance monitoring system based on RFID

R.A.JM.Gilang<sup>1</sup>, S.S.M.Fauzi<sup>2</sup>, I.M.Ayub<sup>3</sup>, M.N.F.Jamaluddin<sup>4</sup>, I.Puspitasari<sup>5</sup>, Okfalisa<sup>6</sup>  
<sup>1,2,3,4</sup>Faculty of Computer and Mathematical Sciences, Universiti Teknologi MARA, Malaysia  
<sup>5</sup>Faculty of Science and Technology, Universitas Airlangga, Indonesia  
<sup>6</sup>Department of Informatics, Faculty of Science and Technology,  
Sultan Syarif Kasim State Islamic University of Riau, Indonesia

### 2 Article Info

#### Article history:

Received Apr 27, 2019

Revised May 28, 2019

Accepted Jun 11, 2019

#### Keywords:

Functionality evaluation  
Monitoring system  
Online system  
RFID technology  
Smart card

### ABSTRACT

Attending activities organized by the university or institution is one of the important criteria that must be fulfilled by students for multiple purposes. Whether it is by attending classes, or any other activities, the main concern is focused on the process of recording students' attendance. The use of a paper-based manual system to record students' attendance is still being widely used due to the lack of an e-management system. These approaches have a lot of disadvantages due to the nature of the paper which is a fragile material - also an expensive cost to procure and produce. This paper, relying on Radio Frequency Identification (RFID), designed and developed an electronic system known as Activity Attendance Monitoring System (AAMS) that utilizes readily available resource – student card, as the student identification when attending an activity. Results from the validation, execution and continuous test suggest that AAMS can be effectively implemented to monitor and record student's attendance. The main contribution of the study is the design and development model that capable of monitoring students' activity attendance in university activities context. Developers and researcher in the area can adopt the proposed design and development model in formulating a similar system in managing activity attendance.

Copyright © 2020 Institute of Advanced Engineering and Science.  
All rights reserved.

### Corresponding Author:

S.S.M.Fauzi,  
Faculty of Computer and Mathematical Sciences,  
Universiti Teknologi MARA,  
40450 Shah Alam, Selangor, Malaysia.  
Email: shukorsanim@perlis.uitm.edu.my

## 1. INTRODUCTION

University or any institution treats the attendance of the communities, such as the student attending organized activities as important criteria which are utilised for various purposes. These purposes include record storage, student assessments, and as a benefit for the student to apply for limited university facilities such as dormitory. Other than that, attending the activities encourages students to move actively in various fields such as sports and cultural and others, rather than only focuses on academic learning. A few studies suggests stated that postengagement could reflect better attention once a physical activity is cast-off as a timeout from academic learning time and academic performance could also be improved [1-3].

The common recording process of student attendances was in a form of paper document that prepared by the activity organizer, distributed to be filled in or kept as an attendance proof. The paper document is a sign of outdated past [4]. The paper is something that needs to be treated with care. Since the paper has its traits which are easily torn and damaged, the paper quality definitely will become worse. Commonly, a paper document is a quite fragile material where it can be easily damaged for some

circumstances. An organization that still use the old techniques are generally suffering from the same problems as financial problems as the paper is costly and interactional problems with the paper. It is an expensive approach as the organizations need to consider the cost of printing, documents storage and maintenance once the paper documents are produced. Other than that, the paper usually cannot be efficiently accessed, physically occupies space, must be stored appropriately, requires physical delivery, the challenge in revising or integrating into other documents and others are some examples of limitation on the use of paper [4].

The common issue is always associated with a time consumption. The effect can be seen by the process of distribution and filing paper documents it takes time and the effort in order to get information from the documents and a place need to be prepared to keep the files. Storage is one of the paper-based system problems as filing cabinets occupy a lot of space and searching for the old file documents is too time consuming [5-6]. Moreover, paper-based approach is investigated in several studies and it is quantified the problem of missing data from its records [7-10].

Due to this problem, a mechanism that provides the ability to manage student attendance efficiently is needed. Extended list of studies related to attendance has been carried out that implements various technologies with the common ground of conversion to a paperless approach as one of the most effective ways to solve the problem. An implementation of a solution depends on the resources available to an organization. Therefore, the study system proposed a web-based system known as Activity Attendance Management System (AAMS) that focuses on utilizing readily available resources held by students their smart card as identification for attendance with the support of Radio Frequency Identification (RFID) technology. The design and development model proposed in the study is the main contribution of this study. It could be a reference for developers and researcher in their process of creating a similar system.

The next section outlines the literature review. Next, the system design and development and the evaluation of the system prototype is described. The final section concludes the study.

## 2. RELATED STUDIES

This section describes the related studies on attendance systems that reduce paper document consumption that utilizes various technologies. Later, the technologies used in aiding in the development and management of students' attendance system are also addressed.

Bluetooth is a wireless technology that can be swapping the data over a short distance from static and mobile devices, and building personal area networks (PANs). Bluetooth is an integration of hardware and software technology, runs in hardware radio chip and operates software in order to provide the main mechanism and security rules [11]. It is more efficient, flexible and secures wireless communications by using new hardware and software systems [12]. In the Bluetooth Smart System, it has an electronic tag which embedded in student identification cards (student's ID card). The electronic tag able to read during motion also there is no line of view is required for the wireless communication between reader and tag [13]. Figure 1 illustrates the system implementation in Bluetooth Smart System.

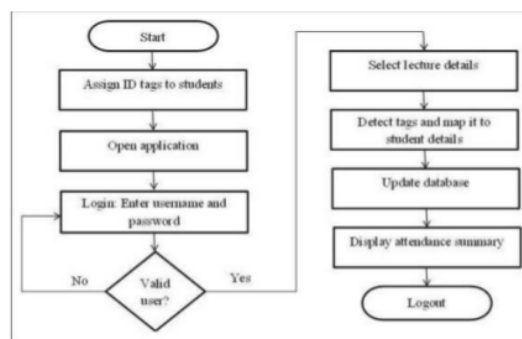

Figure 1. Flowchart of the student attendance management system [13]

Biometric system is being widely adopted as a secure and expensive approach in developing an attendance system. Face recognition technologies is one of the features that is used to monitor attendance as this feature function by analyses the appearances of a person's face image input through a camera [14].

*Design and development of activity attendance monitoring system based on RFID (R.A.JM.Gining)*

Obviously, face recognition measures overall the structure of the person's facial, distances between eyes, mouth, nose and eye, jaw edges where these measurements or dimensions are taken from database [15]. This system involves MATLAB's Image Acquisition Toolbox as a camera is constructed, accessed and bring it into one frame at one time. Figure 2 shows the block diagram of this system.

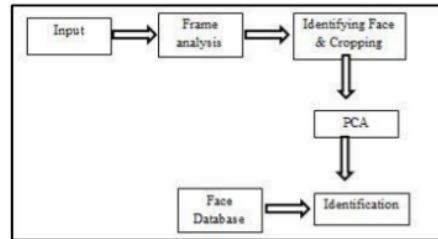

Figure 2. Block diagram [15]

Another study developed a Bar Code Scanner Based Student Attendance System (SAS) to replace the paper-based record system with the barcode scanner technology so that it can record and manage the attendance records in a more efficient and effective way [6]. The technologies such as RFID and biometric based were sometimes quite expensive to apply because it requires purchasing of certain hardware to get the system going. Subsequently, the study uses barcode technology to implement their system and develops it together with a web-based system; which is one of the most common attendance systems that available [16]. Figure 3 illustrates the architecture of SAS.

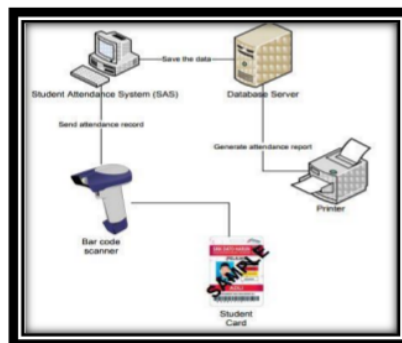

Figure 3. Architecture diagram [16]

Taking consideration from the related studies, this study adopted RFID technology with the support of a web-based system. The decision highlights the adoption of RFID technology because of the intent of using a readily available resource of student smart card which holds RFID tag. The RFID is one of the technologies that ultimately help the speed handling of industrial goods and materials [17]. RFID supports the identification of the information from distance as the RFID tags allows the set of unique IDs superior to barcodes [18]. The use of RFID allows an environment where the information exchange became easier in the results of its capability to identify a product item by only using a single tag - which can be automatically recognised and traced anywhere [19-22].

The devices of RFID technology can be divided into two classes which are active tags and passive tags. Active tags need a power source by connecting to the powered structure or it may use the energy kept in an integrated battery. Meanwhile, the passive tags do not need either battery or maintenance [23-25].

The RFID reader is needed to perceive the data that have been stored on a RFID tag. The information will be passed in a digital form to the computer system the information usually contain id

that is unique to a tag. In this study, the unique id is used as the student identification and the information is stored in the database for further processing.

Nevertheless, RFID technology still has their own limitation on several issues. The limitations include standardization and cost. Depending on the type of tags, it could cost as much as 25 cents per tag - although this is not a concern of the study since RFID tag is already available in the student smart card. Other than that, the signal collision may occur as attempting to read multiple tags at one time which results in data loss but could be prevented by applying anti-collision algorithms [23, 26].

### 3. METHODOLOGY

This section describes the methodology used to design and develop the AAMS. The section is divided into two sub-sections; (i) the description of the design with a flowchart, ERD, system visualization and the design of system interface and (ii) the process of programming for functions used with RFID reader and database setup.

#### 3.1. The Design of AAMS

The design and development phase utilized an RFID reader - HID Omnikey 5X21 Reader, which is a contact and contactless RFID reader that available cheaply in the market. The reader is used as the main device to read the RFID tags in the student cards. The main purpose of the system design phase is determining how the system should work. Figure 4 illustrates the flow of the AAMS.

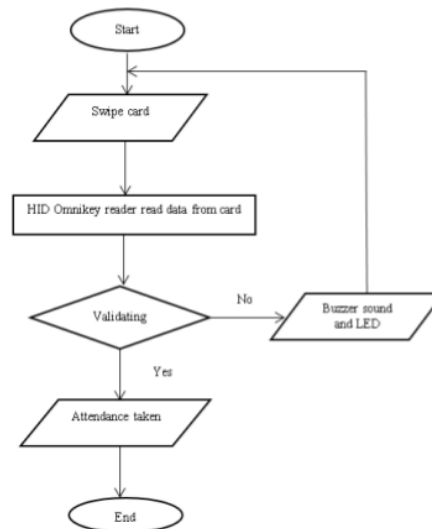

Figure 4. Design flow of AAMS

The process starts when the RFID tag; which is the student card, swiped at the selected RFID reader (HID Omnikey 5X21) as it is designed to read and process the information encrypted on it. The information stored inside the RFID tags is a unique id which belongs to the smart card and can be used as their identification.

Once the student cards are swiped, the reader will be triggered to verify the authorization of the card by checking with the database. The database contains information about student cards together with the student information. These facilitate the implementation of a function that could restrict only selected students to be authorized in attending an activity. This also reduces the occurrence of negative actions such as fraud, injustice and more in attending any activities.

In the process of validating the student card, a built-in feedback is indicated by the reader; blue LED lights and buzzer on when reader successfully read the tags, otherwise, an unsuccessful message will be displayed on the screen. Next, when the RFID tags are authorized, then its unique id will be shown on the

screen, the data or the information was sent to the database. This is to record the attendance of the student in the database for future reference.

To illustrate the details of the entities and attributes for AAMS, Entity Relationship Diagram (ERD) was utilized. Figure 5 illustrates an ERD for AAMS. Four (4) tables created includes 'employee', 'student', 'activity' and 'attendance'. All of these tables are stored in a database named 'activitydb'. Each table has its own assigned attributes.

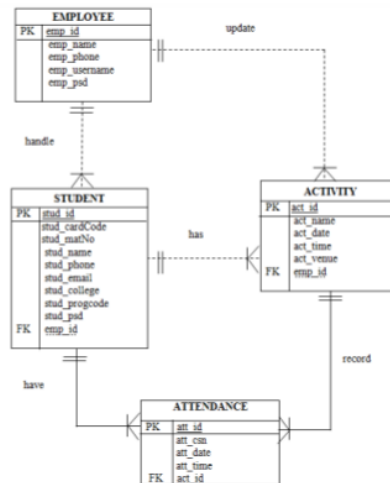

Figure 5. Entity relationship diagram (ERD) for AAMS

Figure 6 illustrates an interface to support the functionalities of the system. The system setup is simple as the RFID reader only needed to be connected to a laptop or personal computer. The RFID reader can read any ID of RFID tags in the student card. The student card ID can be caught in certain distances by a program that later explained in this section. The visualization of the system is shown in the figure below; which could show two outcomes – the card being read in an optimal distance and unable to read outside of the optimal distance

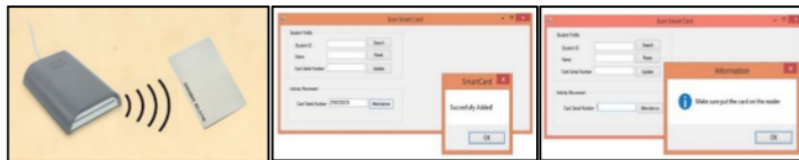

Figure 6. Interface supporting AAMS functionality

The interface of the AAMS is generated by the Visual Basic program that caught the ID in the RFID tag. The AAMS also has a web-based system. Different from the program that caught the ID of the student card, this web-based system is used to display and manage the information of the system. It has four (4) menus that are placed at the top on the left side which are; 'Home', 'Employee', 'Student' and 'Activity'.

### 3.2. The Development of AAMS

Two types of application are separately developed to catch the ID of the student card and to manage the information pertaining to student activities. Both applications are using the same database. A simple application interface is developed to covers the two applications; one by using Visual Basic and the other by using PHP.

The first application is responsible to read the ID number in the student card. In addition, the purpose of this application also to search, reset and update the data of specific student based on ID in their card from the database. A specific library for smart card readers - winscard.dll, needed to be imported in order for the RFID reader to be connected and working properly. With the connection with the RFID reader established, the RFID reader then check the presence of the card and read the unique identifier (UID) of the card.

After the development of the first application was done, then the next process that is web application process took part. This process is being done as the aims to display the information stored in the database. This can help the organization to make the monitoring process of student activities attendance that has been organized by the university.

Both applications are communicating with the same database created from the design of the Entity Relationship Diagram in the previous sub-section. Figure 7 illustrates the four table implementation by using Phpmyadmin.

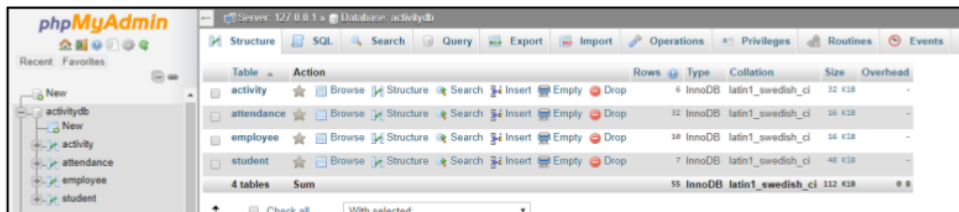

Figure 7. Implementation of ERD as database using phpmyadmin

## 4. RESULT AND DISCUSSION

### 4.1. Validation Testing

The type of RFID tags used in this testing is MiFare 13.56 MHz tags. The RFID reader, HID Omnikey 5X21 reader has a feature that is quite similar to the sensor but the distance tested was closer because the HID Omnikey 5X21 reader can read the tags with close proximity. All the distances were the good distance to be identified except for 3.0 cm which is the furthest distance among others in Table 1. The optimum distance between HID Omnikey 5X21 reader and the RFID tag was below than 2.5 cm.

Table 1. Validation Testing Result

No.	Testing ID	Testing Description	Answer	
			Yes (√)	No (X)
1.	01	Read RFID tag from: 0.5cm	√	
2.	02	Read RFID tag from: 1.0cm	√	
3.	03	Read RFID tag from: 2.0cm	√	
4.	04	Read RFID tag from: 2.5cm	√	
5.	05	Read RFID tag from: 3.0cm		X

### 4.2. Execution Testing

The execution testing was carried out to observe how the component works. In the Figure 8, it begins with the readings through HID Omnikey 5X21 Reader against RFID tags used and then moves to decide whether the buzzer beeps and the green LED on or not. After that, the information was recorded in the database and display on the screen on the website. This test conducted to measure the accuracy of the system to perform as predicted. In the Table 2 illustrates the testing results that all of the components were working well and merged.



Figure 8. Execution testing for components

Table 2. Execution Testing Result

No.	Testing ID	Testing Description	Answer	
			Yes (√)	No (X)
1.	06	'True' RFID card – Authorized user	√	
2.	07	'False' RFID card – Access denied user	√	
3.	08	Data saved in the database	√	

#### 4.3. Continuousness Testing

This is the last part of the testing that is conducted in the functionality testing which is continuousness testing. This testing is conducted because some limitations that had to face. Figure 9 illustrates the flow of the components that were tested. It is needed for this test in order to recognize what limitation or constraint if the certain situation happened. In Table 3 is the list of continuousness testing of every test case for AAMS.

Concerning the limitation discussed is once the tag has been detected, the process would be delayed with the delay time that can be controlled. There are two choices for this process which are delaying or exit the system.



Figure 9. Continuousness testing components

Table 3. Continuousness Testing Result

No.	Testing ID	Testing Description	Answer	
			Yes (√)	No (X)
1.	09	'True' RFID card – Authorised user	√	
2.	10	'False' RFID card – Access denied user	√	
3.	11	Data saved in the database	√	

The outcomes of the evaluation suggested that AAMS functionalities are responding well. All three testing types achieve the expected outcome and it should respond well when used by actual users.

#### 5. CONCLUSION

This paper described a study on the design and development of the activity attendance monitoring system. The evaluation results suggest that the AAMS can be implemented to record and monitor the attendance in any of the university's activities. Apart of that, AAMS is essential to some extent since it can help to reduce the problems occurred while entering, updating, storing and finding data or information.

#### REFERENCES

- [1] Bartholomew, J. B., & Jowers, E. M. (2011). Physically Active Academic Lessons in Elementary Children. *Preventive Medicine*, 52, S51-S54.
- [2] Donnelly, J. E., & Lambourne, K. (2011). Classroom-Based Physical Activity, Cognition, and Academic Achievement. *Preventive Medicine*, 52, S36-S42.
- [3] Grieco, L.A, Jowers, E.M, & Bartholomew, J.B. Physically Active Academic Lessons and Time on Task: The Moderating Effect of Body Mass Index. *Medicine and Science in Sports and Exercise*. 2009;41(10):1921–1926.
- [4] Sellen, A. J, H. R. H. (2003). *The Myth of the Paperless Office*. MIT Press.
- [5] Chao, C. (2015). Implementing a Paperless System for Small and Medium-Sized Businesses (SMBs), 1277 (December).
- [6] Tang, P. C., LaRosa, M. P., & Gorden, S. M. (1999). Use of computer-based records, completeness of documentation, and appropriateness of documented clinical decisions. *Journal of the American Medical Informatics Association*, 6(3), 245-251.
- [7] Tufo, H. M., & Speidel, J. J. (1971). Problems with medical records. *Medical care*, 509-517.
- [8] Dawes, K. S. (1972). General Practice Observed: Survey of General Practice Records. *Br Med J*, 3(5820), 219-223.
- [9] Zuckerman, A. E., Starfield, B., Hochreiter, C., & Kovaszny, B. (1975). Validating the content of pediatric outpatient medical records by means of tape-recording doctor-patient encounters. *Pediatrics*, 56(3), 407-411.
- [10] Romm, F. J., & Putnam, S. M. (1981). The validity of the medical record. *Medical care*, 310-315.



- [11] Chun, N., & Chan, Y. (2005). Software Engineering 4C03 Project Report Bluetooth Technology.
- [12] Minar, N. B. N. I., & Tarique, M. (2012). Bluetooth security threats and solutions: a survey. *International Journal of Distributed and Parallel Systems*, 3(1), 127.
- [13] Lodha, R., Gupta, S., Jain, H., & Narula, H. (2015). Bluetooth Smart Based Attendance Management System. *Procedia Computer Science*, 45(C), 524–527.
- [14] Jain, A. K., Ross, A., & Prabhakar, S. (2004). An introduction to biometric recognition. *IEEE Transactions on circuits and systems for video technology*, 14(1).
- [15] Joseph, J., & Zacharia, K. P. (2013). Automatic Attendance Management System Using Face Recognition. *International Journal of Science and Research*, 2(11), 327–330.
- [16] Sas, S., Subramaniam, H., Hassan, M., & Widyarto, S. (2013). Bar Code Scanner Based Student Attendance System ( SAS ), *Jurnal Tlkom* (13).
- [17] Sarac, A., Absi, N., & Dauzère-Pérès, S. (2010). A literature review on the impact of RFID technologies on supply chain management. *International Journal of Production Economics*, 128(1), 77-95.
- [18] White, G., Gardiner, G., Prabhakar, G. P., & Abd Razak, A. (2007). A comparison of barcoding and RFID technologies in practice. *Journal of information, information technology and organizations*, 2, 119-132.
- [19] Jones, P., Clarke-Hill, C., Shears, P., Comfort, D., & Hillier, D. (2004). Radio frequency identification in the UK: opportunities and challenges. *International Journal of Retail & Distribution Management*, 32(3), 164-171.
- [20] Jones, P., Clarke-Hill, C., Hillier, D., & Comfort, D. (2005). The benefits, challenges and impacts of radio frequency identification technology (RFID) for retailers in the UK. *Marketing Intelligence & Planning*, 23(4), 395-402.
- [21] Morgan, J., & Ranky, P. G. (2006). An introduction to radio frequency identification (RFID) methods and solutions. *Assembly Automation*.
- [22] Sellitto, C., Burgess, S., & Hawking, P. (2007). Information quality attributes associated with RFID-derived benefits in the retail supply chain. *International Journal of Retail & Distribution Management*, 35(1), 69-87.
- [23] Kaur, M., Sandhu, M., Mohan, N., & Sandhu, P. S. (2011). RFID Technology Principles, Advantages, Limitations; Its Applications. *International Journal of Computer and Electrical Engineering*, 3(1), 1793–8163.
- [24] Bastina, A. A. M., & Rama, N. (2017). Biometric Identification and Authentication Providence using Fingerprint for Cloud Data Access. *International Journal of Electrical and Computer Engineering*, 7(1), 408.
- [25] Ennajih, A., Zbitou, J., Latrach, M., Errkik, A., & Mandry, R. (2017). A New Dual Band Printed Metamaterial Antenna for RFID Reader Applications. *International Journal of Electrical and Computer Engineering*, 7(6), 3507.
- [26] Rghioui, A., & Oumnad, A. (2017). Internet of Things: Surveys for Measuring Human Activities from Everywhere. *International Journal of Electrical & Computer Engineering* (2088-8708), 7(5).

# Design and Development of Activity Attendance Monitoring System based on RFID

## ORIGINALITY REPORT

12%

SIMILARITY INDEX

9%

INTERNET SOURCES

8%

PUBLICATIONS

%

STUDENT PAPERS

## PRIMARY SOURCES

- 1 Muhammad Zaki Abd Razak, Shukor Sanim Mohd Fauzi, Ray Adderley JM Gining, Muhammad Nabil Fikri Jamaluddin. "Data visualisation of vehicle crash using interactive map and data dashboard", Indonesian Journal of Electrical Engineering and Computer Science, 2019  
Publication 1%
- 2 Chau Minh Thuyen. "Design of PI-neural controller for hybrid active power filter", Indonesian Journal of Electrical Engineering and Computer Science, 2020  
Publication 1%
- 3 [ijeecs.iaescore.com](http://ijeecs.iaescore.com)  
Internet Source 1%
- 4 M. Amir Abas, T. B. Tuck, M. Dahlui. "Attendance Management System (AMS) with fast track analysis", 2014 International Conference on Computer, Control, Informatics and Its Applications (IC3INA), 2014 1%

---

5	<a href="http://scholarsbank.uoregon.edu">scholarsbank.uoregon.edu</a> Internet Source	1%
6	<a href="http://eprints.utar.edu.my">eprints.utar.edu.my</a> Internet Source	1%
7	Riya Lodha, Suruchi Gupta, Harshil Jain, Harish Narula. "Bluetooth Smart Based Attendance Management System", Procedia Computer Science, 2015 Publication	1%
8	<a href="http://tel.archives-ouvertes.fr">tel.archives-ouvertes.fr</a> Internet Source	<1%
9	<a href="http://www.jmess.org">www.jmess.org</a> Internet Source	<1%
10	<a href="http://www.ti.com">www.ti.com</a> Internet Source	<1%
11	<a href="http://www.i-scholar.in">www.i-scholar.in</a> Internet Source	<1%
12	<a href="http://www.scirp.org">www.scirp.org</a> Internet Source	<1%
13	<a href="http://www.academypublisher.com">www.academypublisher.com</a> Internet Source	<1%
14	Mohammad Pour-Ghaz, Timothy Barrett, Tyler Ley, Nicholas Materer, Allen Apblett, Jason	<1%

---

Weiss. "Wireless Crack Detection in Concrete Elements Using Conductive Surface Sensors and Radio Frequency Identification Technology", Journal of Materials in Civil Engineering, 2014

Publication

15

[nextpdf.site](http://nextpdf.site)

Internet Source

<1%

16

Eleonora Bottani, Massimo Bertolini, Antonio Rizzi, Giovanni Romagnoli. "Monitoring on-shelf availability, out-of-stock and product freshness through RFID in the fresh food supply chain", International Journal of RF Technologies, 2017

Publication

<1%

17

[pdfs.semanticscholar.org](http://pdfs.semanticscholar.org)

Internet Source

<1%

18

Chun-Hung Cheng, Yong-Hong Kuo. "RFID analytics for hospital ward management", Flexible Services and Manufacturing Journal, 2015

Publication

<1%

19

[asianssr.org](http://asianssr.org)

Internet Source

<1%

20

[www.ncbi.nlm.nih.gov](http://www.ncbi.nlm.nih.gov)

Internet Source

<1%

21

[ejournal.uin-suska.ac.id](http://ejournal.uin-suska.ac.id)

Internet Source

<1%

22

[collab.nlm.nih.gov](http://collab.nlm.nih.gov)

Internet Source

<1%

23

Chien-Ho Ko, Nang-Fei Pan, Chuang-Chun Chiou. "Web-based radio frequency identification facility management systems", Structure and Infrastructure Engineering, 2013

Publication

<1%

24

N.A.A. Zahari, R.A.JM. Gining, S.S.M. Fauzi, T.R. Razak, M.N.F. Jamaluddin. "An Identification of Software Requirement for Web Based Judging System", IOP Conference Series: Materials Science and Engineering, 2020

Publication

<1%

Exclude quotes On

Exclude matches Off

Exclude bibliography On