



Proceedings of UMRAN2014

Landscape Seminar

Theme:

FOSTERING ECOSPHERE IN THE BUILT ENVIRONMENT

29 APRIL 2014

Venue:

**Kulliyah of Architecture and Environmental Design,
International Islamic University Malaysia**



Organised by:

**The Department of Landscape Architecture
Kulliyah of Architecture and Environmental Design. IIUM**

Edited by:

Aniza Abu Bakar & Nurhayati Abdul Malek

UMRAN2014 ORGANIZING COMMITTEE

Program Advisor	Asst. Prof. Dr. Nor Zalina Harun	
Chairman UMRAN2014	Asst. Prof. Dr. Aniza Abu Bakar	
Program Director	Aizuddin Iklil Shah Ahmad Shafiee	
Asst. Program Director	Muhammad Ruzaini Roslan	
Secretariat	Haizal Baharuddin Lukman Ramli	Norsyafiqah Abd Kadir Nurkhaleda Mohd Nasir
Treasurer	Annur Jalilah Ramlan (Head) Aimi Zarak Ali	Nur Athirah Kassim
Scientific Review Committee	Nurul 'Ain Mohd Norddin (Head) Nabila Farhah Mohd Noor Noor Aqmal Hakim Noor Azman Norul Hafizah Yusoff	Nur Emira Ahmad Kamaruddin Nur Fatin Rashidah Abdul Ropal Nur Ikma Mohamad Nasir Nurul Hani Muhamad Noh
Scientific Reviewer	Emeritus Prof. LAr. Dr. Ismawi Hj. Zen Asst. Prof. Dr. Aida Kesuma Azmin Asst. Prof. Dr. Aliyah Nur Zafirah Sanusi Asst. Prof. Dr. Aniza Abu Bakar Asst. Prof. Dr. Fadzidah Abdullah Asst. Prof. Dr. Izawati Tukiman Asst. Prof. Dr. Jamilah Othman Asst. Prof. Dr. Lukman Hakim Mahamod Asst. Prof. Dr. Maheran Yaman Asst. Prof. Dr. Mariana Mohamed Osman Asst. Prof. Dr. Mazlina Mansor Asst. Prof. Dr. Nor Zalina Harun Asst. Prof. Dr. Norzailawati Mohd. Noor Asst. Prof. Dr. Nurul Hamiruddin Salleh Asst. Prof. Dr. Nurul Syala Abdul Latip Asst. Prof. Dr. Rashidi Othman Asst. Prof. Dr. Rosniza Othman Asst. Prof. Dr. Rustam Khairi Zahari Asst. Prof. Dr. Sufian Hamat Asst. Prof. Dr. Syafiee Shuid Asst. Prof. Dr. Tan Chin Keng	Asst. Prof. Dr. Zainul Mukrim Baharuddin Asst. Prof. Dr. Zaiton Abdul Rahim Asst. Prof. Dr. Zumahiran Kamarudin Asst. Prof. Dr. Zuraini Denan Asst. Prof. LAr. Dr. Khalilah Zakariya Asst. Prof. LAr. Dr. Mohd Ramzi Mohd Hussain Asst. Prof. LAr. Dr. Nurhayati Abdul Malek Assoc. Prof. Dr. Abdul Razak Sopian Assoc. Prof. Dr. M. Zainora Asmawi Assoc. Prof. Dr. Md. Mizanur Rashid Assoc. Prof. Dr. Mohd Zin Mohamed Assoc. Prof. Dr. Noor Hanita Abdul Majid Jasasikin Bin Ab Sani Mohd. Fairullazi Ayob Putri Haryati Ibrahim Roziha Che Haron
Protocol Committee	Muhammad Ariff Faisal Azhar (Head) Nik Nor Asiah Nik Nor Azman	Norsyahira Ariffin Nurfaezah Ghani
Sponsorship Committee	Muhammad Saddam Husin Daud (Head) Aisyah Mahmood	Nur Syakirah Mohmad Sayuti
Multimedia & Promotion Committee	Muhammad Faiz Adul Malek (Head) Aslina Abdul Kamil Fahmi Ali	Mu'az Mohamed Zainal Abidin Wan Mohamad Saifuddin Wan Hashim

**Preparation & Technical
Committee**

Aiman Yusri (Head)
Ainul Samihah Albahori
Farha Salim
Mohamad Nur Ridhwan Mohd Nordin
Mohd Nasrul Nafizie Mad Nafiah
Muhammad Saufi Daud

Nazliah Hani Mohd Nasir
Noor Fatin Syakilla Zubir
Noor Sharlisa Dawi
Nur Fadhilah Rozali
Siti Nor Ain Nasihah Mustfar

**Food & Beverage
Committee**

Liyana Bakeri (Head)
Nur Yasmin Mohd Adnan

Muhammad Faridzman Samani

**Registration &
Proceeding Committee**

Ainatul Izzah Ishan (Head)
Nor Hidayah Ramlan
Nur Ezzati Adnan

Nur Syahirah Masdar
Nurlaili Firdaus Che Othman

UMRAN2014 ORGANIZING COMMITTEE	i-ii
TABLE OF CONTENT	iii-v
PREFACE	vi-vii
ACKNOWLEDGEMENT	viii

THEME: FOSTERING ECOSPHERE IN THE BUILT ENVIRONMENT

Session A: Exceeding The Norm Of Sustainability In Built Environment

1. Human Dimension On Fish And Amphibian As Indicators For A Healthy Environment In Urban Lakes Of Kuala Lumpur 1
Lukman Ramli, Liyana Bakeri and Zainul Mukrim Baharuddin
2. Assessing The Implication Of Ecology On Scenic Beauty Preferences Of Fraser Hill 16
Nur Emira Ahmad Kamaruddin, Nur Fatin Rashidah Abdul Ropal and Jamilah Othman
3. The Impact Of Landscape Setting And Architectural Element On The Outdoor And Indoor Microclimate: A Case Study Of Masjid Al-Mukarramah, Bandar Sri Damansara 32
Nur Yasmin Mohd Adnan, Nur Fadhilah Rozali, Aniza Abu Bakar, Nurhayati Abdul Malek, Rosniza Othman and Aliyah Nur Zafirah Sanusi
4. The Impact Of The Outdoor Design And Architectural Dimension Of Masjid SHAS Towards Microclimate 49
Aslina Abdul, Nur Ikma Mohamad Nasir, Aniza Abu Bakar, Nurhayati Abdul Malek, Rosniza Othman and Aliyah Nur Zafirah Sanusi
5. Aspect Of Tree For Controlling Outdoor Microclimate: A Case Study In IIUM 58
Mohamad Nur Ridhwan Mohd Nordin, Mohd Nasrul Nafizie Mad Nafiah, Aniza Abu Bakar and Amira Nadhirah Mohamad
6. Study On Wild Birds And Elderly People In Relation To Sustainable Construction 72
Noor Sharlisa Dawi, Nur Syahirah Masdar and Ismawi Hj. Zen
7. Tourists' Perceptions Towards Nature Trail Facilities Management: A Case Study Of Bukit Nanas Forest, Kuala Lumpur 89
Siti Nazirah Kamaruddin and Mohd Zin Mohamed
8. The Effect Of Landscape Design On The Values Of Housing Areas In Klang Valley 106
Fitrynadia Mohd Shahli, Mohd Ramzi Mohd Hussain, Izawati Tukiman and Nurbazliah Zaidin

Session B: Vitalized Built Environment As Catalyst For Heartier Community

9. Examining The Social And Communal Values Of Urban Square Towards Families And Youth 121
Muhammad Ruzaini Roslan, Noor Aqmal Hakim Noor Azman and Khalilah Zakariya

10. Provision Of Spaces And Space Quality In Housing Area Towards Quality Of Life: Case Study Of Taman Melati Mastika, Gombak <i>Muhammad Faiz Abdul Malek, Wan Mohamad Saifuddin Wan Hashim, Aniza Abu Bakar, Nurhayati Abdul Malek, Rosniza Othman, Aliyah Nur Zafirah Sanusi and Mohamad Abdul Mohit</i>	135
11. Emerging Relationship Of Spatial Design And The Activity Form Of Urban Park <i>Nur Ezzati Adnan, Nor Hidayah Ramlan and Izawati Tukiman</i>	151
12. Evaluating Guidelines On Open Space And Its Impact Towards Users Satisfaction In PPR Housing Area <i>Nur Athirah Kassim, Nurlaili Firdaus Che Othman and Mahadi Katang</i>	166
13. The Quality Of Housing Environment And Green Open Space Towards Quality Of Life <i>Ainatul Izzah Ishan, Nurul 'Ain Mohd Norddin and Nurhayati Abdul Malek</i>	183
14. Physical Factors And Social Attributes For The Liveliness Of Urban Plaza At Bintang Walk, Kuala Lumpur <i>Nabila Farhah Mohd Noor, Aimi Zarak Ali and Mazlina Mansor</i>	199
15. A Review On Contribution Of Landscape Settings In Hot-Humid Region Towards Modification Of Outdoor Microclimate <i>Amira Nadhirah Mohamad, Aniza Abu Bakar and Aliyah Nur Zafirah Sanusi</i>	215
16. Urban Green Spaces In Determining The Housing Price: A Theoretical Framework <i>Mohd Nasrul Hanis Manzahari, M.Zainora Asmawi and Noorzailawati Mohd Noor</i>	233
Session C: Green Technology Innovation As An Indicator For Emerging Challenges	
17. A Study On Homestay Concepts Of Tourism Program Development In Malaysia <i>Muhammad Saufi Daud, Muhammad Saddam Husin Daud, Muhammad Faridzman Samani and Rashidi Othman</i>	245
18. Visitor Perceptions Of Water Fountains Towards Space (Indoor , Outdoor) <i>Kamil Fahmi Ali, Siti Nor Ain Nasihah Mustfar and Jasasikin Ab.Sani</i>	259
19. A Study On Urban Morphology Using GIS , Remote Sensing Technique <i>Marina Mohd Nor and Norzailawati Mohd Noor</i>	273
20. Perception Of Campus Community Towards The Application And Practicality Of Campus Farming In International Islamic University Malaysia, Gombak <i>Norul Hafizah Yusoff, Nurfaezah Ghani and Putri Haryati Ibrahim</i>	288
21. A Study On The Importance Of Material Selection For Hardscape Surface Structure <i>Mu'az Mohamed Zainal Abidin, Aiman Yusri and Mohd Ramzi Mohd Hussain</i>	303

22. The Potential Of Water Filtration System For IIUM Gombak <i>Norsyafiqah Abd Kadir, Nurkhaleda Mohd Nasir and Izawati Tukiman</i>	312
23. A Study On The Potential Of Campus Outdoor Classroom In KICT, IIUM, Gombak <i>Nur Syakirah Mohmad Sayuti, Nurul Hani Muhamad Noh and Maheran Yaman</i>	326
24. The Potential Of Outdoor Space Utilization For Learning Interaction <i>Nazliah Hani Mohd Nasir, Farha Salim and Maheran Yaman</i>	343
Session D: Culture And Art Towards Enhancing The Quality Of Life	
25. Landscape Furniture Of Royal Palaces And Malay Traditional Houses <i>Muhammad Ariff Faisal Azhar, Aizuddin Ikil Shah Ahmad Shafiee and Nor Zalina Harun</i>	359
26. A Study On Job Satisfaction And Turnover Intention Among Quantity Surveyors <i>Nik Nur Azirah Mohamed Nor and Tan Chin Keng</i>	375
27. Cultural Landscapes In Built Environment: A New Perspective <i>Nurbazliah Zaidin, Mohd Ramzi Bin Mohd Hussain, Izawati Tukiman and Fitriynadia Mohd Shahli</i>	389
28. Mangrove Forest: Degradation And Rehabilitation <i>Mazni Adibah Abd Rahman and M.Zainora Asmawi</i>	398
29. Assessing The Values And Potentials Of Public Art In Campus Public Space <i>Ainul Samihah Albohari, Annur Jalilah Ramlan and Khalilah Zakariya</i>	411
30. Islamic Landscape: The Interpretation And Viability Of Islamic Courtyard In Malaysia <i>Aisyah Mahmood, Noor Fatin Syakilla Zubir and Jasasikin Ab.Sani</i>	429
31. A Study On The Effectiveness And Utilization Of Courtyard In Kulliyyah Compound <i>Norsyahira Ariffin, Nik Nor Asiah Nik Nor Azman and Putri Haryati Ibrahim</i>	443

Published by Department of Landscape Architecture, Kulliyyah of Architecture and Environmental Design International Islamic University Malaysia Copyright©2014 Kulliyyah of Architecture and Environmental Design

ISBN 978-983-3142-32-3

All rights reserved. The authors are solely responsible for the statement made and opinions expressed in it and its publication does not imply that such statements and/or opinions are/reflect the views or opinions of the Editors and Publisher. While every effort has been made to trace and acknowledge copyright, however if infringement should have occurred, the Editors and Publisher tender our apologies and upon this being pointed out would take steps to make the necessary correction.

PREFACE

In the recent years, ‘going green’ has been trending as a significant move towards handling issues pertaining environmental degradation and the effects of development. In order to create a built environment that meets the needs of the present without compromising the necessities of the future, it is crucial for us to reflect back on our responsibilities as a society, or ‘*ummah*’ while protecting the environment. Hence, UMRAN2014 with the theme ‘Fostering Ecosphere in the Built Environment’ aims to expand this discussion further through disseminating new findings and ideas from multidisciplinary perspectives. The seminar format was four sessions and one keynote speaker, within eight hour time frame (9 a.m. to 5 p.m.).

The first session dealt with the ecological approach involving the characterization on how the environment influences the abundance, availability of a given resource in creating sustainable design. The second session focused on innovation of technology in a way to improve living standards of all people. The third session deliberated on the interrelationship between spaces, inequality, ethnicity and well being to enrich the quality of life regards in their needs in supporting sustainable way. The last session presented the strategies in achieving the value of uniqueness of the character of physical and form of the community by embracing the environment through conserving and preserving the beauty of culture and arts. The speakers included staff, postgraduate students and undergraduate students from related background of the borders. Substantial time was allotted for interaction between the speakers and the audience. A major goal of this event was to raise awareness of ecological living environment as a whole where it is not only to cater the ‘environment’. Indeed, environmental protection focuses more on keeping our air, land and water clean and healthy.

The first session, titled *Exceeding the Norm of Sustainability in Built Environment* upon the dynamic concept in which it is related to the action taken from different fields in the built environment by taking extra cautions when dealing with the environment by understanding the impact of each design idea in lined with the guideline of having environmental-friendly living.

The second session, titled *Green Technology Innovation as an Indicator for Emerging Challenges* focused on the creative approaches based on a new idea that can enriched well-developed built environment. This enables us to meet the ways of solving the needs of society in the manner that can continue indefinitely into the future without damaging or depleting natural resources. Speakers addressed the application of knowledge in science and technology that will bring innovations and changes in daily life and healthy environment.

The third session, titled *Vitalizes Built Environment as Catalyst for Heartier Community* dealt with improving places and spaces, including buildings, parks, and transportation systems for community well-being. Speakers tend to observe, explore

and experiment the needs of the community in supporting their lives through sustainable way. Speakers also discussed on the built environment as valuable aesthetic dimension in the society and encourage critical self-reflection to create public realm throughout society.

The last session, titled *Culture and Art towards Enhancing the Quality of Life* where speakers highlighted on the impact of culture and arts values as the mean to create sense of well-being as well as by outlining the idea of enlivening the community value and enriching culture as strategies towards better quality of life.

In conclusion, as with most environmental issues, built environment can have significant positive and negative effects. It is man-made surroundings that provide the setting for human activities, ranging from large scale of surrounding to the small personal shelters which somehow impacted the natural environment. A good design in the built environment is those that can enhance the development and well-being of future generations and supports healthier and happier communities. Thus, *Fostering Ecosphere in the Built Environments* is an inspirational description of the theme for this seminar and is able to respond effectively on embedding sustainable environmentally design approach towards enriching the quality of life.

ACKNOWLEDGMENT

In the name of Allah, the Most Gracious and the Most Merciful

First of all, we want to express all praise and thankful to Allah because of His Grace, Power and Mercy that this seminar is finally completed.

As a final note and on behalf of the organizing UMRAN2014, we wish to thank all the people involved for their interests and stimulating contributions to the success of this seminar. A special thanks to IIUM Rector, Prof. Dato' Dr. Zaleha Kamarudin and Dean of Kulliyyah of Architecture and Environmental Design, Prof. Sr. Dr. Khairuddin Abdul Rashid for giving us support in conducting UMRAN2014 this year.

We would like to take this opportunity to extend our thanks to all those academicians, organizations and experts who contributed to the deliberations in this seminar either by presenting the papers or attending as a participant. We also acknowledge the efforts put in by the officers and staff of the Department of Landscape Architecture IIUM for putting considerable efforts to make this seminar a success under the supervision and guidance from Asst. Prof. Dr. Aniza Abu Bakar, the Chairman of UMRAN2014, with Asst. Prof Dr. Nor Zalina Harun, the Head, Department of Landscape Architecture, as the advisor.

We are indebted to all seminar paper reviewers for their prompt and devoted professional evaluations that are important in conducting this seminar. The organizers are also grateful to all participants, academicians and students from the department of Landscape Architecture, Architecture, Urban and Regional Planning, Applied Art and Design and Quantity Surveying. Our warm appreciation to researches, consultants from building environment, government officials and others associated with the built environment for their contribution in the organizing of UMRAN2014 seminar. We hope this publication will help to expand broad view towards handling issues pertaining environmental degradation and become the platform for new findings and ideas from a multidisciplinary perspective, organizations and individuals in the field.

UMRAN2014 Organizing Committee

THE IMPACT OF LANDSCAPE SETTING AND ARCHITECTURAL ELEMENT ON THE OUTDOOR AND INDOOR MICROCLIMATE: A CASE STUDY OF MASJID AL-MUKARRAMAH, BANDAR SRI DAMANSARA

Nur YasminMohd Adnan¹, Nur Fadhilah Rozali¹, Aniza Abu Bakar², Nurhayati Abdul Malek², Rosniza Othman³, Aliyah Nur Zafirah Sanusi³

Abstract

Being in the tropical region, Malaysia experience relatively high air temperature and humidity throughout the year. People are trying to avoid the sun. Improper landscape design could contribute further in the increasing outdoor air temperature. This would further affect the indoor microclimate. Nowadays people are turning to the mechanical solution when indoors. Hence, this paper aims to identify the impact of landscape setting and its microclimate, and the architectural dimension on the indoor microclimate of a mosque, by taking the Masjid Al-Mukarramah, Bandar Seri Damansara in Kepong, Kuala Lumpur as a case study. Variables of this study includes environmental data such as relative humidity, solar radiation, wind speed, wind direction, air temperature and surface temperature for the outdoor microclimate, air temperature and relative humidity for the indoor microclimate; landscape setting that involves ground surface material, vegetation, landscape furniture; as well as the orientation of the mosque. Therefore, this paper deals with the understanding of two components which are the architectural dimension and the landscape setting of the mosque that affects its indoor and outdoor environment. For the indoor, the focus is given to the main prayer hall of the mosque. The data were obtained through site inventories and analysis; and the environmental data collection using several equipment. The result shows that the air temperature differ between the west and east area of the indoor prayer hall following the orientation of the mosque.

Keywords: indoor and outdoor microclimate, landscape setting, architectural dimension, mosque.

INTRODUCTION

Most people may have heard the term ‘climate change’ in their daily life. But, are they really express their concern about this matter? How this climate change can cause the particular area to become a threat especially for users and environment? This problem may not effect to the users, as the climate may changes very slow and sometimes difficult to identify due to the climatic conditions. Due to rising temperatures, people seek places or spaces that provide cooling or shaded area. This research is conducted to investigate the impact of landscape setting and architectural dimension to the outdoor and indoor microclimate of the mosque focused to the comfort of users on the main prayer hall. For this research, the scope area that need to be study are the landscape setting and the architectural elements that gives effect to the environmental parameters such as air temperatures, solar radiation, wind speed, relative humidity and surface temperature as these components are related with the indoor and outdoor climate of the building. The study of landscape setting of the

¹ [3rd year Landscape Architecture Students, Dept. of Landscape Architecture, KAED, IIUM]

² [Asst. Prof. at the Dept. of Landscape Architecture, KAED, IIUM]

³ [Asst. Prof. at the Dept. of Architecture, KAED, IIUM]

building is important in order to understand the concept of outdoor setting that may influence the indoor and outdoor climate of building. Besides that, the architectural dimension are also need to be focused, generally on the orientation of the mosque, the openings and the effect of air ventilation inside the building that helps in mitigate the air temperatures to the surrounding. The site study is chose at Masjid Al-Mukarramah, Bandar Sri Damansara in Kepong, Kuala Lumpur where it matches the criteria of research topic.

MICROCLIMATE OF LANDSCAPE SETTING AND ARCHITECTURAL DIMENSION

2.1 The effect of landscape setting on the indoor environment.

Moufida and Djamel^ba (2012) described trees as a source to control the air temperature and surrounding. Plants also give positive solution in environmental issues such as air pollution which leads to the occurrence of climate change in particular area, noise pollution especially in urban development context and so on. In microclimate context, plants can reduce heating and cooling energy needs. Trees save energy by providing shade to the building during warm day, act as a wind break and important for evapotranspiration as well. Apart from that, the used of trees in the outdoor setting are more acceptable in the context of cultivation and maintenance against the excessive use of hardscape in open space. Moreover, trees also as a connector to nature and surroundings by its colour and compositions.

In the context of urban area, trees are crucial elements in modifying the air temperature in urban places. However, the effects of trees towards the air temperature may influence and depend in several aspects. A group of trees can lower the albedo if compared to solid surfaces for example the bare soil or concrete. The reason is sunlight absorbed multiple by the plant leaves when it infiltrates through the tree canopy. 20 to 22 percent of incident light is reflected by the grass while 12 to 15 percent is reflected by the bushes or trees which is as same as asphalt pavement.

Energy loading of trees increased when threes are planted at the paved areas such as at the parking lot. However, it depends on the tree species, the air humidity and how much the tree crown exposed. Thus, broad leaves trees from hot habitat can tolerant the high temperature and has greater effect on the surrounding air temperature compared to the small leaves trees. Trees also contributed in providing shades for buildings and pedestrian. The form of a tree itself is important to decide where the shadow is cast. Trees with broad and low hanging canopy show less variable shadow pattern compared to the tall trees because of the limited horizontal section.

Santamouriset. al., (2011) mentioned that cooling pavement materials in hardscape element representing a high reflectance of solar radiation and significantly contributes to the reduction of several degree temperatures in certain period of time. It is essential to understand the effect of cooling pavements to the surrounding and the conditions of the pavement that requires the less amount of absorption of heat during warm day. Basically, cool pavement can be describe as any reflective pavement materials that can lower the heat temperature and also can reduce the amount of heatabsorbed. There are several types of pavements that need to be considered as a reduce heat indicator. There are several factors that contribute to the heat absorption

to the pavement materials. The reflective pavements for instance increase the albedo of the surface while permeable pavements gives evaporative cooling when pavement in moist conditions. Roughness pavement creates the effective air turbulence over the surfaces, create convection and cooling factors. It is also reduce a surface's net solar reflectance. Other than that, pavement that has low thermal conductivity led to increase the heat on the surface but it will not transfer the heat throughout the other pavement. The thickness of the pavements also important as it can store the heat before released to the atmosphere. Thus, thick pavement will absorb and stored more heat compared to others (Reducing Urban Heat Islands: Compendium of Strategies-online).

2.2 The effect of architectural dimension on the microclimate of masjid

Masjid played role in most of Muslim environments. Masjid becomes a centre of references for Muslims and the centre of society's attentions. The interior architectural of masjid can be said as a reflection of culture and some expresses symbolism by the pattern of floral and geometrical.

Masjids are known as a place for Muslim to worship God and practicing other religious activities. According to (Al-Homoud et. al., 2009) commonly the basic design of the masjid are in rectangular, walled enclosure and roofed prayer hall. The wall niche called Minbar located in the centre of the wall near to the Mihrab. Mihrab is a place for Imam delivers the sermon on every Friday during Jumaat prayer. Figure 1.1 shows the basic layout of the masjid.

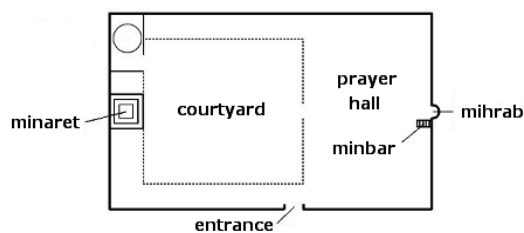

2.2.1 Natural ventilation in the mosque

For hot and humid climate, high natural ventilation is needed to decrease the indoor heat thermal of the mosque especially during noon. The design of the mosque must consider with the direction of the wind to allow the air move freely and create pleasant indoor thermostat temperature (Hanafi, 1999).

Ventilation can be defined as “...the effects of air movement in the building” (Hyde, 2000). It also can be describe as air flows from high pressure zones to the low pressure zones to reduce the heat received by the surface convection. Good natural ventilation allows fresh air freely moved, create pleasant atmosphere and reduce surplus heat.

To add, natural ventilation also can be understood as “the action of air moving from outdoor into the indoor space in a natural way without the use of a fan or other mechanical system such as the air-conditioning (Hong Kong Building Technology Net – online). Basically, there are two types of natural ventilation that can be implemented in a building which is the wind driven ventilation and the stack ventilation. The wind driven ventilation happens when the windward wall of a building is hit naturally by the wind which cause the direct positive pressure as the wind is deflected and produced momentum over the building surface (Hong Kong Building Technology Net – online).

Walker (2010) classified buoyancy-driven ventilation into stack ventilation and cool tower. The stack ventilation is induced by temperature while the cool tower is induced by humidity. Levin(2009) described the stack ventilation as the warm air that is less dense the cold air where it causes the warm air to rise and the cold air falls. It increases the air flow rate at the chimney where it produces huge pressure differences at the top and bottom areas. The example of stack ventilation can be referring in figure below:

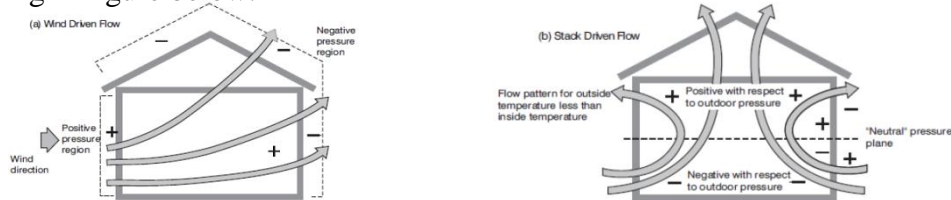
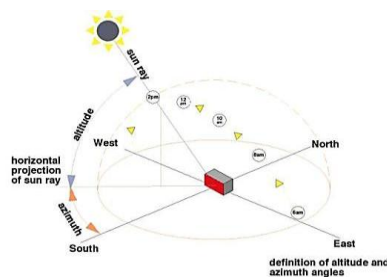

Figure 3 the example of stack or buoyancy driven ventilation. Source: (Levim,2009).

2.2.2 Orientation of the masjid.

To enhance the shading element and create comfort inside the building, an early step before constructing the foundation is to examine the basis layout of the area. As mentioned before, the masjid oriented towards the Qibla wall, which is located at the Makkah. Al-Quran regarded by Muslim as the Word of God, and prescribes the performance of prayer and other ritual acts towards the sacred Kaaba in Makkah.

To decrease the heat absorption to the masjid, one of the strategies that can be applied is the design of wall as a shaded element. The wall in the west received lots of heat compared to the wall in east, because during early day, wall in the west received heat from surrounding surfaces, and it continuously until the late evening. Based on Fry and Drew (see Hyde, 2000) describe that the wall which are less exposed of the sun will not transmit the heat to internal spaces and remains at shade temperature which is the lowest possible temperature. The optimum orientation used to manipulate the building shape and form, and also to minimize the wall surface that exposed to sun.



Another way that can be highlighted to reduce heat thermal inside the mosque is the consideration of roof or dome. Roofs are the main target for collecting heat inside the building as it continuously adapt in daytime. Due to the hot and humid climate, the building can occurred high temperature because when the roof surface temperature increase, the heat reflects to the other parts of the building, thus thermal comfort inside the building increased continuously.

2.2.3 The effect of wind on building

The wind flow towards building may effect on several conditions which are the worker safety, the operation of building and equipment, the protection towards weather and pollution and the ability to control the environmental aspect in relation which temperature, air humidity, air flow and contaminants. Accordingly there are several factors that are caused by wind, among other, surface pressures that fluctuate around buildings, changing intake and exhaust system flow rates, natural ventilation,

infiltration and exfiltration. The recirculation of exhaust gases to air intakes also can happened because of the mean flow patterns and wind turbulence passing over a building (Allard and Alvarez 1998).

METHODOLOGY

This study was conducted at the Masjid Al-Mukarramah, Bandar Sri Damansara in Kepong, Kuala Lumpur. The masjid was selected because it is located at the hilly area which can be considered as one of the factors that might influence the microclimate on the site. The aim of the study is to investigate the impact of landscape setting and the architectural dimension of the masjid on the outdoor and indoor microclimate of the site.

3.1 Flow of Data Collection

The following diagram shows the flow of the data collection process, where it can be divided into four stages (refer figure 1.5).

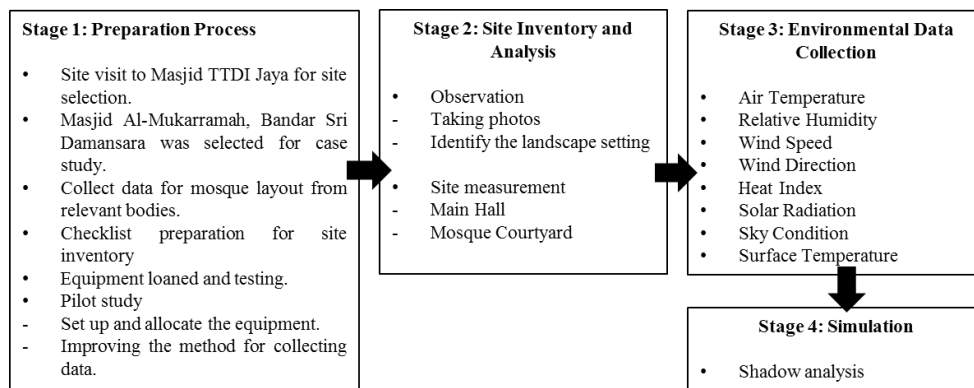







Figure 5 the flow of data collection.

Stage 1: Preparation Process

Preparation process is a crucial stage where it was the beginning before started any data collections. The earlier stage covers the site visit to Masjid Al-Mukarramah as selected site. The mosque layout was asked from relevant bodies such as MajlisPerbandaranPetaling Jaya and Pejabat Daerah dan Tanah but unfortunately, it could not be provided. The checklist for site inventory was also prepared beforehand to ease the data collecting. The equipment were also had been tested and one of the activities during pilot study is to allocate the equipment and to improve the method of collecting data.

No.	Equipment	Image	Reading	Unit	Interval
1.	Outdoor Hobo		<ul style="list-style-type: none"> • Air Temperature • Relative Humidity 	<ul style="list-style-type: none"> • C° • % 	5 Minutes
2.	Indoor Hobo		<ul style="list-style-type: none"> • Air Temperature • Relative Humidity 	<ul style="list-style-type: none"> • C° • % 	5 Minutes
3.	Kestrel		<ul style="list-style-type: none"> • Air Temperature • Relative Humidity • Wind Speed • Wind Direction • Heat Index 	<ul style="list-style-type: none"> • C° • % • m/s • Angle° • C° 	5 Minutes
4.	Solar Meter		<ul style="list-style-type: none"> • Solar radiation 	<ul style="list-style-type: none"> • W/m2 	1 Minute
5.	Infrared Surface Temperature		<ul style="list-style-type: none"> • Surface Temperature 	<ul style="list-style-type: none"> • C° 	30 Minutes

Stage 2: Site Inventory and Analysis

In this stage, site inventory and analysis were done in order to observe the study area by data collection and taking photos on the landscape setting which are softscape and hardscape and the architectural dimension by measuring the indoor and outdoor masjid layout. The landscape setting data were then indicated in the mosque layout.

	Day	Date	Time	Weather condition					
				7.00-9.00	9.00-11.00	11.00-1.00	1.00-3.00	3.00-5.00	5.00-7.00
Day 1	Monday	10 March 2014	0700-1900	Sunny	Sunny	Partially sunny	Partially cloudy	Cloudy	Partially cloudy
Day 2	Tuesday	11 March 2014	0700-1900	Sunny	Sunny	Sunny	Sunny	Sunny	Partially Cloudy
Day 3	Wednesday	12 March 2014	0700-1900	Sunny	Partially sunny	Partially sunny	Partially cloudy	Partially cloudy	Partially cloudy

Stage 3: Environmental Data Collection

The environmental data that were taken includes the air temperature, relative humidity, wind speed, wind direction, solar radiation, heat index, surface temperature and sky condition. These data were gathered to relate and identify what is the implication of landscape setting and architectural dimension towards the outdoor and indoor of the mosque. Table 1.1 shows that, Day 1 experienced mostly partially cloudy, while Day 2 is quite sunny and partially cloudy in Day 3. Figure 1.6 explains the types of equipment were used for certain readings.

Stage 4: Shadow Analysis

Google Sketch Up is a tool for simulating the shadow of the mosque building from 10 March 2014 until 12 March 2014. Therefore, the shadow pattern will be shown on the plan view so that it will indicate which area exposed to the sunlight and area cover with shade of the mosque building for a month.

RESULTS AND ANALYSIS

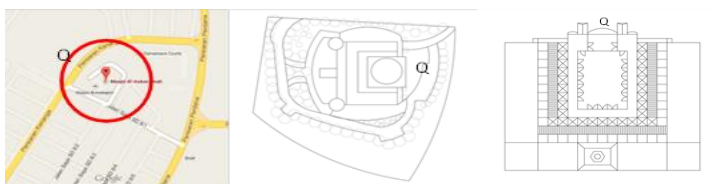

Masjid Al-Mukarramah is located at Bandar Sri Damansara which is at the centre of residential areas and situated at the hilly area. Figure 1.5 shows the site location and masjid layout.

As the masjid is situated at the hilly area, it promotes the views to the residential area and the commercial area where there are several restaurants and services located nearby. The masjid is also well known for a solemnization event and production. The masjid is divided into 2 level of prayer hall and there are also has staff houses and office at masjid. The layout plans of the masjid with the location of environmental data equipment are shown in figure below:

A) Main Prayer Hall level 1.

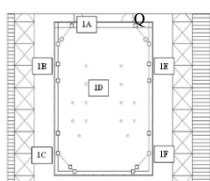

Figure 8: Location of indoor Hobo at level 1.

B) Prayer Hall level 2

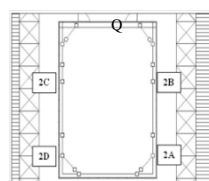

Figure 9 Location of indoor Hobo at level 2

C) Compounds

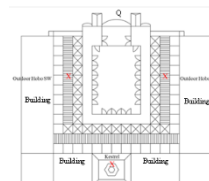

Figure 10 Locations of outdoor Hobo and Kestrel

4.1 Analysis on Softscape

The observation of landscape setting was focusing on the softscape and hardscape at the mosque area. This is to investigate the elements that contributed to the mosque microclimate.

No.	Common Name	Scientific Name	Height (m)	Canopy (d)	Foliage Density	Form
Trees						
1.	Frangipani	<i>Plumeria rubra</i>	3m	4m	Moderate	Picturesque
2.	Weeping Fig	<i>Ficus benjamina</i>	6m	5m	Dense	Round
3.	Rain Tree	<i>Samanea saman</i>	10m	10m	Moderate	Spreading
4.	Brown Heart	<i>Andira inermis</i>	5m	4m	Dense	Round
5.	Papaya	<i>Carica papaya</i>	3m	2m	Moderate	Round
No.	Common Name	Scientific Name	Height (m)	Canopy (d)	Foliage Density	Form
Shrubs						
6.	Javanese Ixora	<i>Ixora javanica</i>	1m	-	Dense	-
7.	Bougainvillea	<i>Bougainvillea glabra</i> 'Magnifica'	1.5m	-	Dense	-
8.	Red Carpet Weed	<i>Altenanthera sessilis</i> 'Red'	0.5m	-	Moderate	-
9.	Snake Plant	<i>Sansevieria trifasciata</i>	0.5m	-	Moderate	-
10.	Cordyline	<i>Cordyline fruticosa</i> 'Firebrand'	2m	-	Moderate	-
11.	Zebra Plant	<i>Eurphobia</i> <i>tithymaloides</i>	1m	-	dense	-
12.	Shrubby Whitevein	<i>Sanchezia speciosa</i>	2m	-	Dense	-
13.	Spider Lily	<i>Hymenocallis</i> <i>speciosa</i>	0.5m	-	Moderate	-
14.	Crinum	<i>Crinum cultivar</i>	0.5m	-	Moderate	-
15.	Heliconia	<i>Heliconia psittacorum</i> <i>x H. spathocircinata</i> 'Golden Torch'	1m	-	Dense	-
16.	Spathiphyllum	<i>Spathiphyllum</i> 'Sensation'	2m	-	Dense	-
17.	Aralia	<i>Polyscias</i> 'Dwarf Variegata'	0.3	-	Moderate	-
18.	Croton	<i>Codiaeum variegatum</i> <i>cultivars</i>	0.5	-	Moderate	-
19.	Barbados Aloe	<i>Aloe vera</i>	1m	-	Moderate	-
20.	Bird's Nest Fern	<i>Asplenium nidus</i>	1m	-	Moderate	-
21.	Chinese Croton	<i>Excoecaria</i> <i>cochinchinensis</i> 'Firestorm'	0.5m	-	Dense	-
22.	Oyster Plant	<i>Tradescantia</i> <i>spathacea</i>	0.2m	-	Dense	-
No.	Common Name	Scientific Name	Height (m)	Canopy (d)	Foliage Density	Form
Cycads/Palms						
23.	Paku Laut	<i>Cycas rumphii</i>	2m	2m	Dense	-
24.	Caribbean Royal Palm	<i>Roystonea oleracea</i>	8m	3m	Moderate	-
25.	Lipstick Palm	<i>Cyrtostachys renda</i>	1.5m	-	Moderate	-

Table 2 The above table of the lists of softscapes based on their types, height, canopy, foliage density and form.

Based on the table above, these were the data of softscape elements that existed at the mosque area such as trees, shrubs and palms to evaluate its functionality towards the outdoor environment microclimate. Softscape evaluations were based on types of plants, plants height and canopy, plant foliage density and form.

4.2 Analysis on Hardscape

Based on the site inventory, there were several hardscape that were found and functional to the user. The outdoor furniture such as benches is provided for user to sit while waiting for other people. The lamp posts are placed along the road to provide efficient lighting. The plant pots were also provided at the mosque compound as the surface was tile and to give more aesthetic value at the compound area.

No.	Structure	Material	Dimension (m)	Colour
1.	Bench	Concrete	0.5mx1m	White
2.	Bench	Concrete	0.5mx1m	Pink
3.	Lamp Post	Metal	3mx1m	Black
4.	Plant Pot	Clay	0.3mx0.5m	Brown

Table 3 The table of the lists of hardscape with the types of material, dimension and colour.

4.1 Sky Conditions during fieldwork

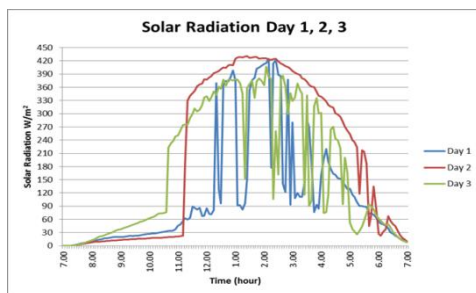

Figure 11 reading for solar radiation for day 1, 2 and 3

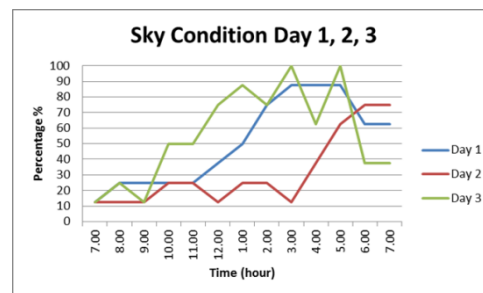
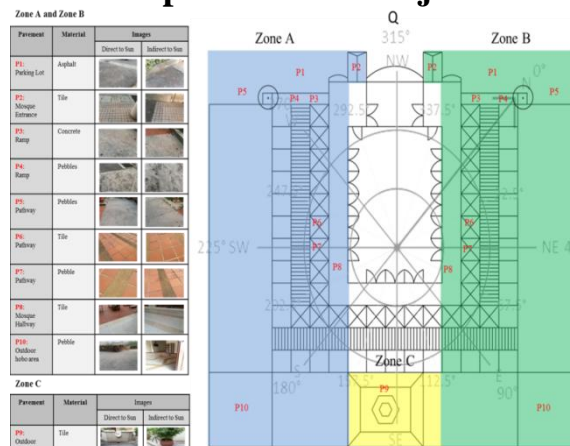

Figure 12 reading for sky condition for day 1, 2 and 3

Figure 1.9 shows the results on sky conditions based on the percentage of cloud cover on Day 1, Day 2, and Day 3. It can be said that Day 2 experiences the lowest cloud cover percentage because of it the weather was sunny during that day (refer Table 1.1). Day 2 seems to be a clear sky from 7.00am until 4.00pm. Sky condition for Day 1 and Day 3 were probably partially sunny and partially cloudy because of the high percentage of cloud covers during these days with oktas 5 to 8. The solar radiation graph (refer Figure 1.11) shows the minimum solar reading is 0W/m² on Day 1, Day 2 and Day 3. For the maximum solar reading on Day 1 is 425.2W/m² at 2.10pm, Day 2 is 430.5W/m² at 1.25pm and Day 3 is 407.5W/m² at 2.05pm. The amount of cloud gives impact to the amount of solar radiation from reaching the ground surfaces.

4.2 External Surface Temperature of Masjid Al-Mukarramah



ZONE A		Day 1				Day 2				Day 3			
Location	Pavement	Direct to Sun		Indirect to Sun		Direct to Sun		Indirect to Sun		Direct to Sun		Indirect to Sun	
		Min °C	Max °C	Min °C	Max °C	Min °C	Max °C	Min °C	Max °C	Min °C	Max °C	Min °C	Max °C
NW	Pave 2	27.4	44.8	28.6	38.6	26.4	50.4	28.2	39.0	28.4	45.2	29.8	37.2
W	Pave 1	27.2	51.8	27.4	43.4	26.8	59.8	27.0	48.2	28.8	52.2	28.6	42.6
	Pave 3	28.8	54.4	28.4	43.0	28.4	63.6	28.8	44.4	30.8	50.6	30.4	41.6
	Pave 4	28.8	53.6	28.6	40.8	29.0	62.8	28.8	43.6	31.2	50.8	30.6	44.6
	Pave 5	28.6	49.6	28.6	39.8	28.6	58.6	28.6	44.4	30.2	48.0	29.4	43.2
SW	Pave 6	29.8	50.8	31.4	41.8	30.2	54.0	31.4	47.4	30.2	50.2	31.4	42.8
	Pave 7	31.0	50.0	31.6	42.8	31.2	54.8	31.8	45.6	30.8	49.6	31.2	44.4
	Pave 8	28.4	51.4	29.6	34.4	28.4	56.2	30.0	35.8	29.6	49.6	30.6	34.6
S	Pave 10	27.4	53.0	27.8	46.2	27.6	63.8	28.2	48.2	28.6	50.8	28.8	43.2
ZONE B		Day 1				Day 2				Day 3			
Location	Pavement	Direct to Sun		Indirect to Sun		Direct to Sun		Indirect to Sun		Direct to Sun		Indirect to Sun	
		Min °C	Max °C	Min °C	Max °C	Min °C	Max °C	Min °C	Max °C	Min °C	Max °C	Min °C	Max °C
NW	Pave 2	28.2	44.2	28.8	38.2	26.8	50.2	28.6	38.2	29.2	48.6	30.8	36.8
N	Pave 1	28.2	51.6	28.0	42.8	27.8	59.6	27.8	48.0	29.4	51.8	28.8	42.2
	Pave 3	29.2	54.0	29.2	42.6	29.4	63.2	29.2	44.2	31.4	50.2	31.4	41.4
	Pave 4	29.2	53.4	28.8	40.2	29.8	62.4	29.0	43.2	31.8	50.6	31.6	44.4
	Pave 5	28.8	49.2	28.8	39.6	28.8	58.0	29.2	44.2	30.6	47.4	29.8	42.6
NE	Pave 6	30.0	50.0	31.8	41.2	30.8	53.6	31.8	47.2	30.6	48.8	31.6	42.2
	Pave 7	31.2	48.8	32.2	42.0	31.6	54.6	32.8	45.4	31.4	49.2	31.8	44.0
	Pave 8	28.8	51.0	29.8	34.2	29.2	56.0	30.8	35.6	30.6	48.8	31.6	34.2
E	Pave 10	27.8	52.6	28.4	46.0	28.6	63.2	28.6	47.8	29.8	49.8	30.0	42.8
ZONE C		Day 1				Day 2				Day 3			
Location	Pavement	Direct to Sun		Indirect to Sun		Direct to Sun		Indirect to Sun		Direct to Sun		Indirect to Sun	
		Min °C	Max °C	Min °C	Max °C	Min °C	Max °C	Min °C	Max °C	Min °C	Max °C	Min °C	Max °C
SE	Pave 9	30.6	41.6	30.8	37.6	28.4	46.6	30.6	41.6	31.2	41.2	31.4	36.4

Table 4 The surface temperature reading divided into Zone A, Zone B, and Zone C according to days, types of pavement and the direct and indirect to the sun. The result shows the minimum and maximum reading of each day.

Zone A and B used the same pavement with same material because to compare the difference of the surface temperature at different location (refer Figure13). The location is somehow gives different reading because of the orientation of the building and also the sun path. It seems that zone B experience s higher surface temperature in the morning compare to Zone A because sun is rising from the E so that Zone B receives the sunlight first. However, Zone A experiences higher surface temperature in the evening because the sun set to the W which gives more sunlight than Zone B. The surface temperature of Zone B seems to be lower than Zone A in the evening. Therefore, the surface temperature is also differs between pavement which is direct to sunlight or indirect to sunlight. The pavements that are indirect to sunlight were covered by trees, awning, and roofed area. These elements are probably the factors of providing good shades and lower the surface temperature.

4.5 Data on Outdoor Microclimate

4.5.1 Relationship between Air Temperature and Relative Humidity

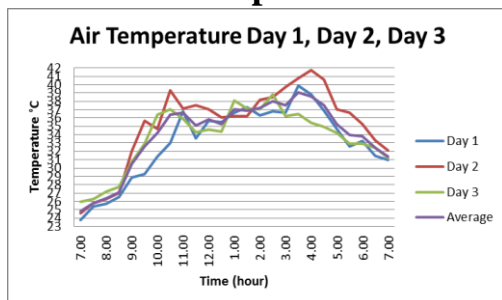

Figure 14 Air temperature graph on Day 1, Day 2 and Day 3 and average reading for three days.

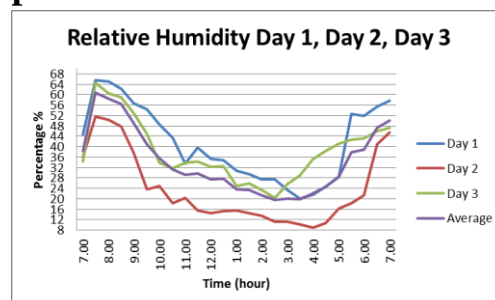

Figure 15 Relative humidity graph on Day 1, Day 2 and Day 3 and average reading for three days.

Both figures above show the results of air temperature and relative humidity in three days from Monday to Wednesday. The air temperature graph shows the reading on Day 1 with the minimum air temperature reading at **23.4°C** at 7.05am and maximum air temperature reading at **40.6°C** at 3.25pm. Meanwhile for Day 2 minimum air temperature reading at **23.9°C** at 7.10am and maximum air temperature at **41.7°C** at 4.00pm. For Day 3, minimum air temperature reading is at **26.0°C** at 7.00am and maximum air temperature reading at **40.4°C** 2.15pm. Based on the air temperature results between Day 1, Day 2 and Day 3, it shows that, the lowest air temperature reading is on Day 1. The reason is Day 1 experiences higher percentage of cloud covers which block the direct sunlight. For the highest air temperature reading on Day 2 is caused by the lowest percentage of sky condition which was a clear sky on that day. Besides, the solar radiation reading was also the highest among the three days (refer Figure 11).

Day	Day 1		Day 2		Day 3	
	Min	Max	Min	Max	Min	Max
Air Temperature C°	23.4	40.6	23.9	41.7	26.0	40.4
Relative Humidity %	45	19.7	37.1	9	34.2	19
Time	7.05am	3.25pm	7.10am	4.00pm	7.00am	2.15pm

Table 5 the maximum reading for air temperature and relative humidity at the same time

Table 5 highlighted the maximum reading of air temperature and the lowest reading of relative humidity at 4:00 p.m. This result can be concluded that the highest the temperature, the lowest the relative humidity.

4.5.2 Wind Speed

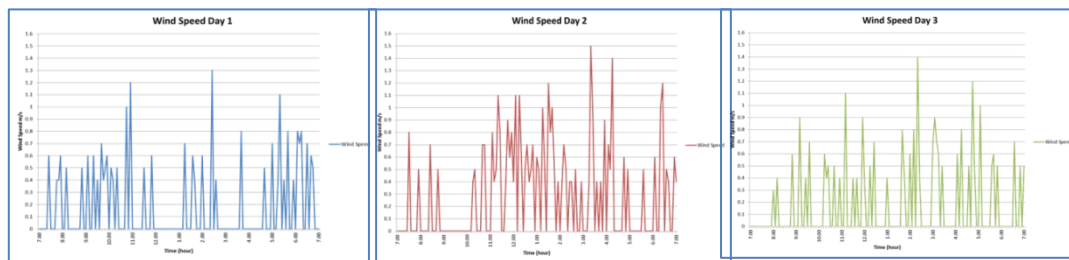

Figure16the graphs of the wind speed on Day 1, Day 2, and Day 3.

The wind speed between three days is quite low which is only achieved at the maximum reading of 1.6m/s on Day 2 even though the location of the mosque is quite high as it was situated at the hilly area. The reading is supposedly to be higher as the higher the location, the higher the wind speed of a place. However, this can be explained by the mosque layout where it has been totally blocked by the building on the right and left side of the mosque (refer Figure 10) Thus, it blocks the wind to go through into the mosque area which result in the lower wind speed by the kestrel that located at the Zone C (refer Figure 13). If the right and left side of the mosque are left open for open space, it may probably be able to induce more wind towards the mosque area from any direction.

4.5.3 Surface Temperature

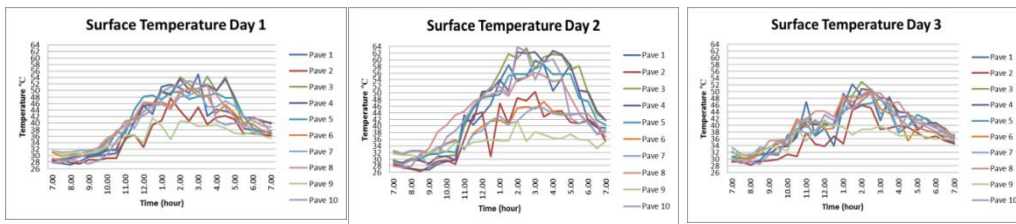

Figure 17 the graphs of surface temperature that is direct to the sunlight between Day 1, 2 and Day 3.

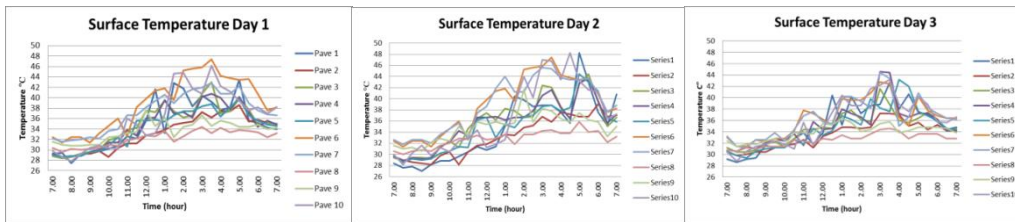

Figure 18 the graphs of surface temperature that is indirect to the sunlight between Day 1, 2 and Day 3.

Referring to the above graph, it shows that air temperature can be related to the surface temperature. The high air temperature effect the higher surface temperature. The highest surface temperature is on Day 2 which is by the Pave 10 at the maximum of 63.8°C at 2.00pm. This is because of the high air temperature and also the low percentage of sky condition during that same day. Both pavements that are direct and indirect to the sunlight are experienced high temperature on Day 2. Besides, it is also because of the fewer trees at the mosque compound and only used the potted plants at pavement areas and also because of the transparent awning which allows the sunlight to direct to the ground surface. Thus, this probably will make the mosque user feel uncomfortable because of the hot surface temperature as they must not wear any shoes at the mosque compound especially on the sunny day.

4.5.4 Relationship between Wind Speed and Wind Direction

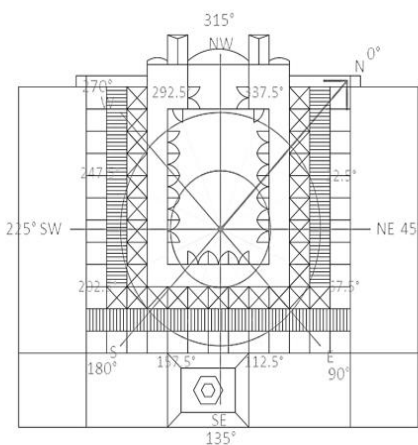

Figure 19 the angle to determine the wind direction.

Time	Day 1			Day 2			Day 3		
	Wind Direction		Wind Speed m/s	Wind Direction		Wind Speed m/s	Wind Direction		Wind Speed m/s
7.00am	NW	312°	0	NW	336°	0	E	103°	0
7.30am	SE	117°	0	E	112°	0.8	SE	113°	0
8.00am	SE	116°	0	E	112°	0	SE	113°	0.8
8.30am	SE	117°	0	E	112°	0	SE	113°	0
9.00am	SE	117°	0	E	112°	0	SE	113°	0
9.30am	SE	115°	0.4	E	112°	0	SE	113°	0
10.00am	SE	116°	0	E	111°	0	SE	113°	0
10.30am	SE	115°	0	E	111°	0	E	112°	0
11.00am	SE	115°	0	E	111°	0	E	112°	0
11.30am	SE	116°	0.5	SE	119°	0	E	112°	0.4
12.00pm	SE	116°	0	SE	118°	0.4	E	111°	0.4
12.30pm	SE	116°	0	SE	119°	0.5	E	112°	0
1.00pm	SE	115°	0	SE	119°	1.6	E	112°	0.4
1.30pm	SE	116°	0	SE	119°	1.2	E	112°	0
2.00pm	SE	115°	0.6	SE	119°	0	E	112°	0.6
2.30pm	SE	115°	0	SE	119°	0.4	E	112°	0
3.00pm	SE	116°	0	SE	119°	0	E	112°	0.7
3.30pm	SE	115°	0	SE	119°	0	E	112°	0
4.00pm	SE	115°	0	SE	118°	0	E	112°	0
4.30pm	SE	115°	0	SE	118°	0	E	112°	0
5.00pm	SE	115°	0.7	SE	119°	0	SE	113°	0
5.30pm	SE	116°	0.4	SE	119°	0	SE	113°	0
6.00pm	SE	116°	0	SE	120°	0	SE	115°	0
6.30pm	SE	116°	0	SE	119°	0.5	SE	115°	0.7
7.00pm	SE	116°	0	SE	119°	0.4	SE	115°	0.5

Table 6 The wind direction and wind speed for every 30 minutes from 7.00am until 7.00pm.

Table 6 shows the wind direction according to the angle (refer Figure19). Most of the wind is come from the SE because of the location of the kestrel at the Zone C. At the kestrel area does not has any roof which it become the source of wind where the other zones have been blocked by buildings.

4.5.5 Shadow Analysis

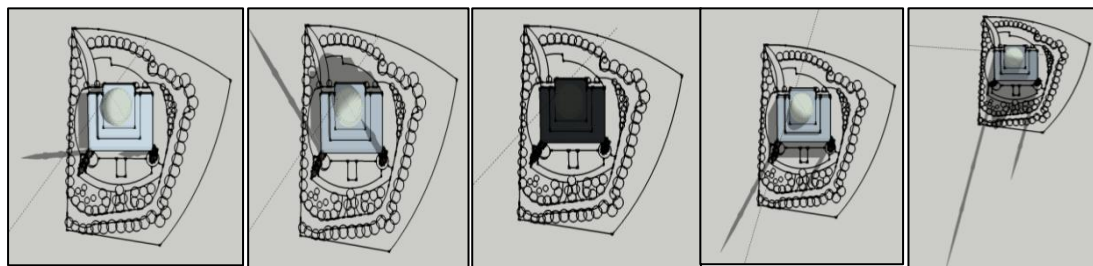

Figure20 shadow analysis from the left is the picture of shadow occurs on Masjid Al-Mukarramah at 7.00am, follows by shadow at 10am, 12.00pm, 3.00pm and 7.00pm from Day 1 until Day 3.

From the shadow analysis above, it shows the sun direction at 7.00am, 10.00am, 12.pm, 3.00pm and 7.00pm which explains the sun movement from East to West. This can be related with the high air temperature at certain place and time and also affected the surface temperature where the right side of the mosque received higher air and surface temperature than the left side of the mosque in the morning while in the evening, the right side of the mosque has lower air and surface temperature than the left side of the mosque.

4.6 Data on Indoor Microclimate

4.6.1 Comparison between 1E and 2B at 1st and 2nd level of prayer hall

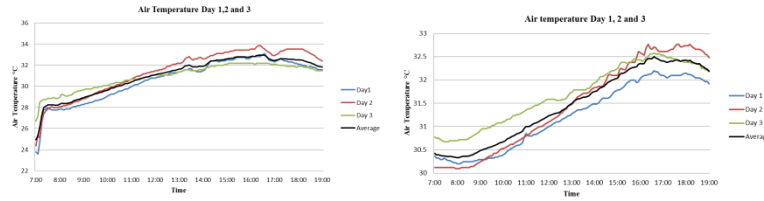

Figure 21 Temperature readings of Hobo 1E and 2B at prayer hall

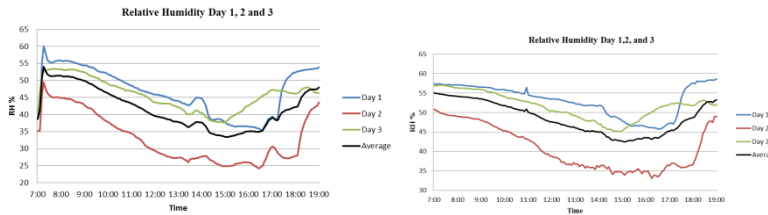

Figure 22 Relative humidity readings of Hobo 1E and 2B at prayer hall

Zone B	Level 1					
	Hobo E					
	Day 1		Day 2		Day 3	
Day	Max	Min	Max	Min	Max	Min
Air Temperature °C	33.3	23.5	33.7	24.3	32.1	26.6
Relative Humidity %	36.5	55.8	25.0	35.1	43.1	39.3
Time	4:40 p.m.	7:25 a.m.	4:15 p.m.	7:00 a.m.	4:05 p.m.	7:00 a.m.

Zone B	Level 2					
	Hobo B					
	Day 1		Day 2		Day 3	
Day	Max	Min	Max	Min	Max	Min
Air Temperature °C	32.2	30.1	32.7	30.0	32.5	30.6
Relative Humidity %	45.7	57.0	39.1	49.1	51.3	56.9
Time	4:35 p.m.	8:00 a.m.	6:10 p.m.	7:55 a.m.	4:35 p.m.	7:25 a.m.

Table 7 the reading temperatures and relative humidity for Hobo 1E and 2B

According to those readings, it can be suggested that, the 1st level of the mosque in east side has the lowest temperatures in the early morning. During the evening, temperatures start to increase at 2nd level. The temperatures at level 2 already restored the heat that been released earlier from the 1st level, as it can be supported by the readings at early morning, where the temperatures at level 2 higher than the air temperatures at level 1. The heat process happens when solar radiation is transmitted through openings and absorbed by the internal surfaces of the buildings before released it to the surroundings. As the area in level 2 does not used for any purposes, the process of heat transfer from the building is not counted. The wind speed and wind direction in 3 days probably does not contribute to the movement of heat, because the mosque is surrounded with walls and it prevents the movement of wind from outside the area into the surrounded mosque.

4.6.2 Comparison between 1B and 2C at 1st and 2nd level of prayer hall

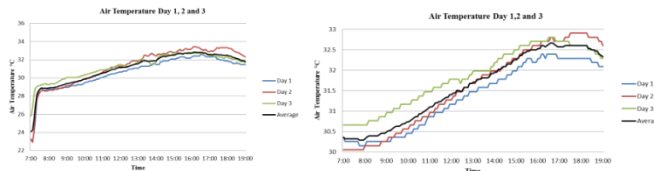

Figure 23 Temperature readings of Hobo 1B and 2C at prayer hall

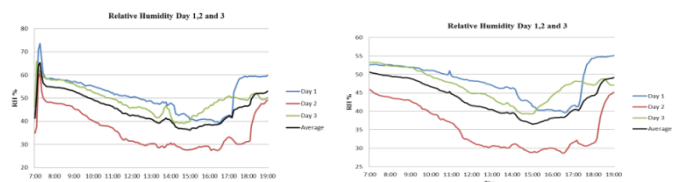

Figure 24 Relative Humidity readings of Hobo 1B and 2C at prayer hall

Zone A	Level 1					
	Hobo B					
	Day 1		Day 2		Day 3	
Day	Max	Min	Max	Min	Max	Min
Air Temperature °C	32.6	23.0	33.4	22.9	32.8	25.8
Relative Humidity %	39.6	42.8	27.4	34.9	41.9	46.2
Time	4:35 p.m.	7:05 a.m.	4:05 p.m.	7:05 a.m.	3:05 p.m.	7:00 a.m.

Zone A	Level 2					
	Hobo C					
	Day 1		Day 2		Day 3	
Day	Max	Min	Max	Min	Max	Min
Air Temperature °C	32.3	30.1	32.9	30.0	32.8	30.6
Relative Humidity %	40.1	52.6	30.6	45.9	46.5	53.2
Time	4:10 p.m.	7:50 a.m.	5:30 p.m.	7:00 a.m.	4:30 p.m.	7:00 a.m.

Table 8 The reading temperatures and relative humidity for Hobo 1B and 2C

In between both level, the 1st level received highest air temperatures probably because there are various possible heat exchange process in between the buildings condition and outdoor environment. Besides the reason of the orientation of the buildings, the west side received heat more than east side of the mosque probably because the heat transfers from the outdoor setting and effects to the indoor setting. Moreover, the space is used by the people for congregation prayer in particular time as well used for religious activities.

In the context of architectural dimension, the openings at level 1 are parallel with level 2. The readings at level 2 in early 7:00 a.m. are increased compared to level 1 most probably because they are experience the excess heat form the building. It might probably during the night, the openings for level 2 are closed which resulted less air movement inside the space and makes the heat stored during the night. The differences of air temperatures in between level are also probably because of wind speed and wind direction. The data recorded that, the first 2 days the wind originates probably from 312° and 336° NW (refer table 6) which probably comes from the openings located at the west side of the mosque that allows the wind through the surrounding environment.

4.6.2 Comparison between 1F and 2A at 1st and 2nd level of prayer hall

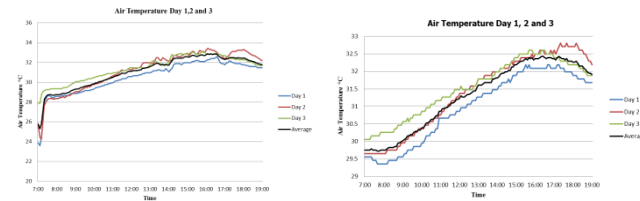

Figure 25 Temperature readings of Hobo 1F and 2A at prayer hall

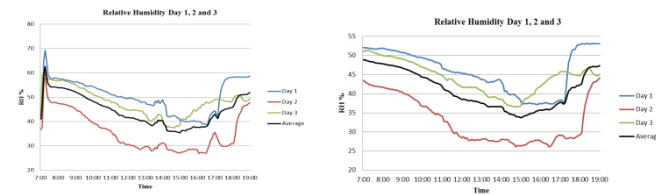

Figure 26 Relative Humidity readings of Hobo 1F and 2A at prayer hall

Zone B	Level 1					
	Hobo F					
	Day 1		Day 2		Day 3	
Day	Max	Min	Max	Min	Max	Min
Air Temperature °C	32.6	23.5	33.4	24.4	33.1	27.8
Relative Humidity %	42.3	44.9	31.0	37.7	44.4	43.8
Time	2:35 p.m.	7:05 a.m.	2:05 p.m.	7:05 a.m.	3:45 p.m.	7:00 a.m.

Zone B	Level 2					
	Hobo A					
	Day 1		Day 2		Day 3	
Day	Max	Min	Max	Min	Max	Min
Air Temperature °C	32.1	29.3	32.8	29.9	32.6	30.0
Relative Humidity %	37.4	51.6	28.2	43.4	39.1	51.0
Time	3:30 p.m.	7:40 a.m.	5:20 p.m.	7:00 a.m.	3:40 p.m.	7:00 a.m.

Table 9 The reading temperatures and relative humidity for Hobo 1F and 2A

Based on the analysis on the graph, it can be said that, the space at the back side of prayer hall experience average temperature in 25.1°C for level 1 and 29.6°C for level 2 at early morning. It can be said that, the heat loss during the early morning for both level. It is probably because the space obtained wind direction from 3 locations which are NW, SE and E (refer table 6). Therefore, it can be assumed that, due to wind direction from NW at early day, the excess heat easily dispersed to the surrounding in addition with the wind from SE and E after half an hour. As the air temperature low, the space turns into high relative humidity. The openings also influence the air movement at the space. Even though the area of the mosque is been constructed with the walls, which probably block the views and air movement around the area, the openings located from every side of the prayer hall allows air to move freely and the absorption of heat from buildings and surrounding also influences the changes of air temperatures throughout the day. It allows the cross air ventilation from outside to inside of the mosque before dispersed to the surrounding.

4.6.3 Comparison between 1C and 2D at 1st and 2nd level of prayer hall

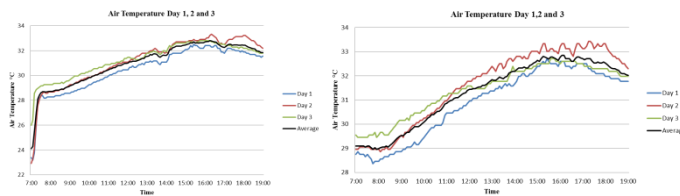

Figure 27 Temperature readings of Hobo 1C and 2D at prayer hall

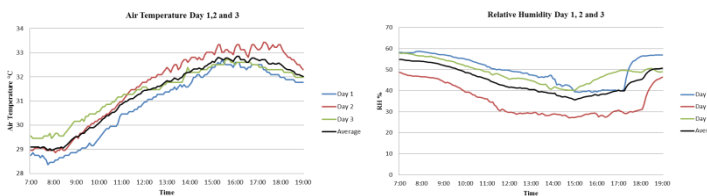

Figure 28 Relative Humidity readings of Hobo 1C and 2D at prayer hall

Zone A	Level 1					
	Hobo C					
	Day 1		Day 2		Day 3	
Day	Max	Min	Max	Min	Max	Min
Air Temperature °C	32.4	23.1	33.2	22.9	32.8	26.0
Relative Humidity %	37.9	45.4	26.2	33.1	42.7	50.0
Time	3:25 p.m.	7:05 a.m.	4:20 p.m.	7:00 a.m.	3:45 p.m.	7:00 a.m.

Zone A	Level 2					
	Hobo D					
	Day 1		Day 2		Day 3	
Day	Max	Min	Max	Min	Max	Min
Air Temperature °C	32.7	28.3	33.4	28.8	32.7	29.4
Relative Humidity %	39.9	58.6	29.2	46.6	43.4	57.8
Time	3:35 p.m.	7:45 a.m.	5:15 p.m.	8:05 a.m.	3:35 p.m.	7:05 a.m.

Table 10 the reading temperatures and relative humidity for Hobo 1C and 2D

Based on the analysis on graph, it can be assumed that the air temperatures in level 2 are the highest temperature compared to level 1. It is because; the space stored excess heat from surrounding includes the heat absorption from the building materials as heat penetrates to walls and reflects the heat to surrounding in long duration of time. The high air temperatures recorded in both levels in evening probably because the 1st level received heat from outdoor environment and surrounding prayer hall and the air ventilation through the openings transfer the heat to the 2nd level and dispersed to the surrounding. In addition, the heats absorb by the building and the outdoor setting effects the indoor temperature in particular time. The surface temperature from the

pavement recorded high readings during evening, resulted the increases of air temperatures inside the mosque.

CONCLUSION

It can concluded that, the outdoor microclimate can influences the indoor microclimate by the outdoor air temperature, relative humidity, wind speed, wind direction, solar radiation, surface temperature and sky condition. Moreover, the landscape setting such as softscape and hardscape elements may affect the mosque microclimate as well as the architectural dimension which is the mosque orientation, forms and building dimension. For the indoors, the amount and the arrangement of the openings might influence the air ventilation of the mosque. The openings can helps in reducing the temperatures and heat reflection from the surface materials to the indoor site. The sun path must takes into consideration when designing the outdoor space because it will determine which area exposed to the sun In a nutshell, by managing the outdoor environment might reduce the microclimate not only at the outdoor area but also indoor and at the same time, achieving the suitable thermal body comfort of masjid users.

DESIGN RECOMMENDATION

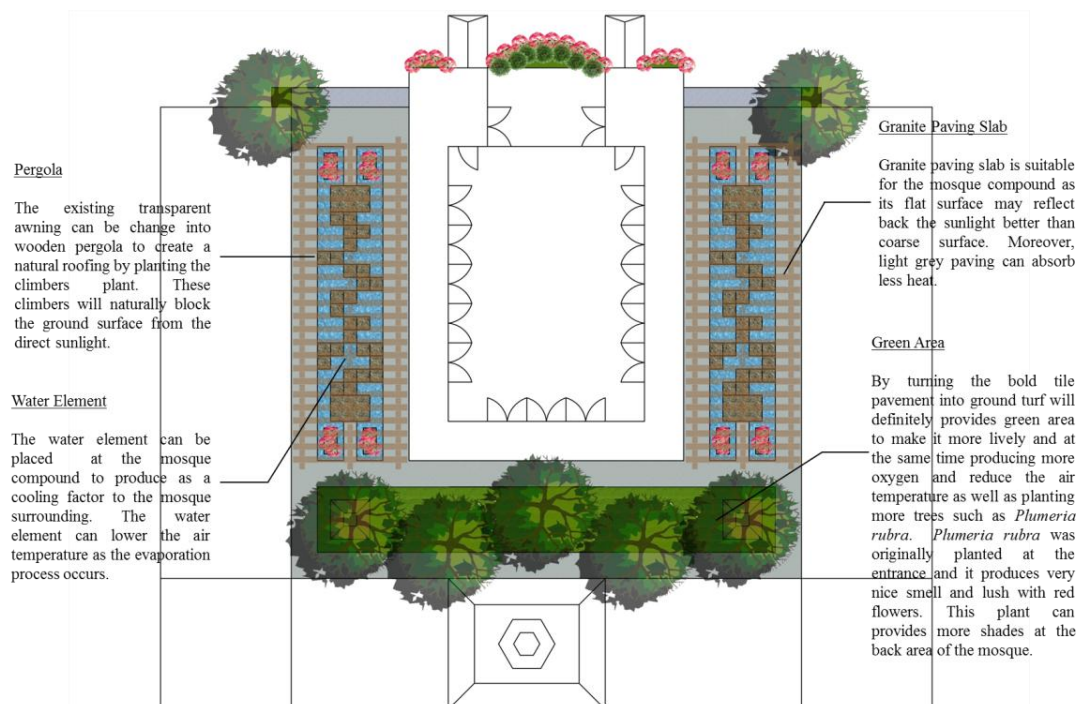

REFERENCE

- Allard, F., (1998), *Fundamentals of Natural Ventilation*, In: *Natural ventilation in buildings: a design handbook*, London, Science Publisher, pp. 9-60.
- Al-Homoud, M., Abdou, A., and Budaiwi, I., (2009), *Assessment of monitored energy use and thermal comfort conditions in mosques in hot-humid climate*, Architectural Engineering Department, Saudi Arabia.
- Hanafi, Z., (1999), *Rekabentuk bangunan dalam iklim panas dan lembap di Malaysia*, Selangor: Percetakan Dewan Bahasa dan Pustaka.
- Hyde, R., (2000), *Climate Responsive Design*, St Edmundsbury Press, Suffolk.
- Moufida, B., and Djamel^a, A., (2012), *Impact of vegetation on thermal comfort conditions outside*, *Thermal modeling of urban microclimate*, Department of Architecture, University Mohamed Khidder, Biskra.
- Santamouris, M., Gaitani, N., Spanou, A., Saliari, M., Giannopoulou, K., Vasilakopoulou, K., and Kardomateas, T., (2012), *Using cool paving materials to improve microclimate of urban areas-Design realization and results of the flisvos project*, University Athens, Greece.
- Hong Kong Building Technology Net, *Natural ventilation*, [online]. Available at: <http://gbtech.emsd.gov.hk/english/utilize/natural.html> >[Accessed 22 February 2014].
- Levin, H., (2009), *Natural ventilation: theory*, [online]. Available at: https://www.ghdonline.org/uploads/2009-08-07_0915_Levin_NatVentTheory.pdf > [Accessed 21 April 2014].
- Walker, A., (2010), *Natural ventilation*, [online]. Available at: <http://www.wbdg.org/resources/naturalventilation.php>> [Accessed 22 February 2014].
- Reducing Urban Heat Islands: Compendium of strategies, Cool Pavements*, [PDF online]. Available at: <http://www.epa.gov/heatisland/resources/pdf/CoolPavesCompendium.pdf>> [Accessed 23 February 2014].