

A User Profile for Information Filtering Using RFID-SIM Card in Pervasive Network

A. A. Osman, Teddy Mantoro
Kulliyyah (Faculty) of Information and Communication Technology,
International Islamic University Malaysia,
Kuala Lumpur, Malaysia
teddy@iium.edu.my

Abstract: The appearance of new technologies allows new data processing techniques. Thus, many new data processing techniques make difficult to user to find pertinent information in suitable time, unless knowing what accurately is in search of, where and how getting it. This paper proposes a pervasive network based information filtering system that integrates user profile such as identity, preference and other important data. User profile is embarked in a RFID-SIM card in order to guarantee its privacy, flexibility, mobility and confidentiality. The overall system objectives are privacy, security and providing pertinent information to the user according to his profile at anytime, anywhere, and in any form. The design and implementation of the system is also presented.

Index Terms—Information filtering, pervasive networks, RFID, smart card and user profile.

I. INTRODUCTION

The recent improvement in networking technology and Internet has lead to rapid development and spread of networks. Processing of data has become in new techniques as a result of the emergence of new information and communication system technologies. The pervasive computing today becomes the rapid and effective communication carrier, and through it services providers deploy new accessible personalized services. But the significant expansion of information has lead to the emergence of another subtle problem. Finding successfully pertinent information on pervasive networks is becoming a difficult duty. Pervasive networks information are changed dynamically and it is difficult for users to find the pertinent information in suitable time, unless knowing what accurately is in search of, where and how getting it. Therefore, although search tools have facilitated access to information, the exploration of Web sites on the pervasive networks is still the main problem. A software agent, which provides information relevant and available at anytime, anywhere, and in any form is actually what the user needs. Achieving such a promise depends on new ideas or methods in areas that affect the creation of information services and communication systems.

Information filtering systems are software systems to help Internet users find the most valuable and interesting

information. This paper proposes an information filtering system that integrates user profile such as identity, user preferences and other related important data in pervasive networks. User profile is embarked in a RFID-SIM card in order to guarantee its privacy, flexibility, mobility and confidentiality. RFID (Radio Frequency Identification) contactless enables the user to be identified by the RFID reader and SIM card stores the information. Using RFID-SIM cards will allow the user to take benefits of information filtering in secure environment and can access his/her profile easily. Also, updating process option will be available in this application.

This study contributes a guaranty privacy and security system, and must provide the available and pertinent information to the user according to his preferences at any time, any where and in any form.

In the next section the related work on information filtering, User profile modeling and RFID and its applications will be described. Followed Section 3, is the design of the proposed system. The User profile on smartcard and RFID in SIM card implementations is presented in section 4. The proposed information filtering scheme is described in section 5. In section 6 the discussion is illustrated. Finally, the conclusion is addressed in section 7.

II. RELATED WORK

A filtering process is critical duty in information delivering to users. The requests of user are represented by his profile. In this section some related works on information filtering and user profile modeling and RFID techniques are presented.

Riordan and Sorensen are provided an overview of the developments that have occurred in the field of information filtering [1]. Callan et. al. proposed a system used Bayesian interface network for representing documents and user profile [2]. Buckley suggested a smart model for retrieval information [3, 16]. Yan and Garcia-Molina are proposed a retrieval system allows users to submitting their profiles via WWW browser [4]. Lahlou and Urien presented a secure and extensible model to represent user profile. Qadeer et. al. they introduce the idea of a RFID-enabled SIM card [5].

C. Riordan and H. Sorensen provide an overview of the major developments and approaches in the fields of Information Filtering and Information Retrieval. The *string matching* approach is the simplest approach for information filtering and retrieval. This simple approach has some advantages such as easy to use and to implement. The

approach is based on the following assumption: it is very easy for users to foresee accurately the word or phrase that will be used in the documents. Such system cannot solve the problems of *homonymy* and *synonymy* [6]. *Use of Thesaurai* [7] is used to solve problems of string matching approach (synonymy and homonymy) by increasing the initial profile. It based on document collection statistics and can be constructed manually or automatically. Applying thesauri has proved valuable tool in Information Retrieval (IR), both in the indexing process and in the searching process, used as a controlled vocabulary and as a means for expanding or altering queries.

The concepts and approaches detailed in the above have been applied to develop a number of filtering systems. Here some of these systems have been adapted and applied to the task of information filtering.

INQUERY system, it is based on language modeling probabilistic within the network, which allows for added flexibility, and used Bayesian inference networks for representing documents and user profiles [2]. SMART system, in this smart system the vector-processing model is used with iterative query modification to focus accuracy and remember Buckley. The filtering process is achieved by SMART system. SIFT system allows users to submit their profiles, which are representing their long-term information need, via a WWW browser [4].

Lahlou and Urien extend the P3P model of identity representation by integrating user preferences [10]. For more robustness and high security, the user profile is embarked in smart card. Also they developed an Internet based filtering system SIM Filter, which benefits from user profile to filter information.

Qadeer et. al. proposed RFID software enabled smart SIM card [10]. The RFID chip embedded in the SIM card will be detected by a RFID reader installed at various places when the chip is within the range. This paper suggests a combination filtering system that combined a SIM card and RFID technologies. The SIM card is used to store the personal information and user preferences, while the RFID is used to achieve contact less connection between the user and the pervasive network. The RFID tag is embedded into SIM card, which mean that the user will be able to update his profile at any time and will offer speed and security with smart features. Pico DBMS (Pico-Data Base Management System) solution is used to implement the user profile into RFID-SIM card, to avoid the limitations of smart cards.

III. PROPOSED APPROACH

The proposed design of the system is shown in Figure 1. It represents the pervasive networks based filtering system “RFID-SIM card”. The user profile contributes to propose a personalized information search and adjustable distribution services to the users. It also helps to propose to users the most appropriate information, in suitable form and minimal attempt. The user introduces his personal profile (identity and preferences data) in an explicit manner via a mobile Interface. He can access to his profile anytime to reach and update its content. The system integrates the user’s profile in his requests before they will be processed.

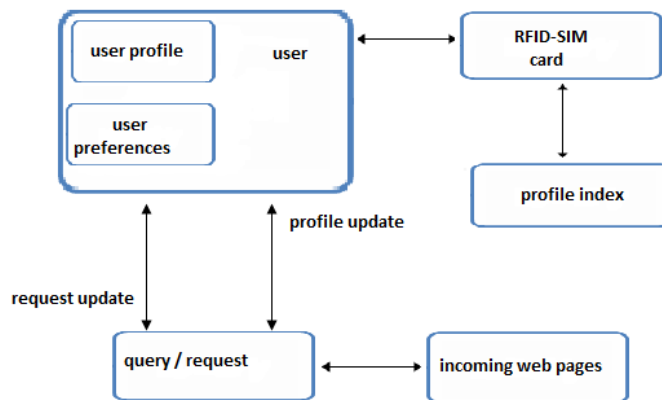

Fig.1. RFID-SIM card filter components

A) User profile modeling

The functionality of user profile modeling system comprises three different functional layers, monitoring layer, modeling and evaluation layer and Adaptation layer. The architecture of the layers is depicted in Figure 2. *Monitoring layer* collects the values of certain key indicators, which will be used for the evaluation and adaptation processes. *Modeling and evaluation layer* retrieves the information collected from the monitoring layer and modeling it by using Bayesian Networks, for encoding, learning and reasoning of probabilistic relationships. *Adaptation layer* updates the estimated profile attributes according to the evidence received through the indicators of the monitoring layer. This evidence serves as feedback in order to acquire knowledge related to the user's behavior.

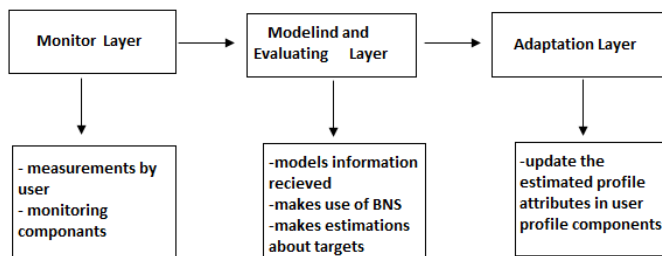

Fig.2. User profile functional layers

B) User profile components

A global architecture to preserve confidentiality on the Web is determined via The Platform for Privacy Preferences Project (P3P), developed by the World Wide Web Consortium. The P3P profile has many advantages, it represent the user’s favorites data, can share personal data with web sites and guarantee privacy and confidentiality. However, the P3P profile holds only inactive information and incomplete to the user's identification without taking in consideration his favorites. P3P restricts itself to the user's identification not including his preferences. It does not also take into account the dynamic feature of the profile; it is restricted to a static profile.

Figure 3 shows the proposed user profile. The user set up his preferences in a clear way. The profile is developing dynamically in an implicit method. The proposed network

based filtering system uses user profile to remove unrelated information and to find relevant one.

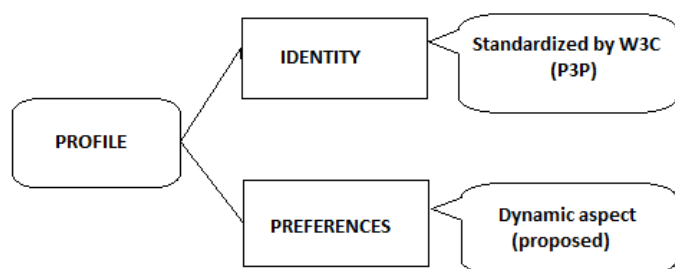

Fig.3. User profile components

C) RFID and its applications

RFID is an object applied to automatically identify or track people or objects using radio waves. The most common method of identification is to store a serial number on a microchip that is attached to an antenna. The serial number is used to identify an entity, and the identification information transmits to a reader via the antenna. The reader function is converting the radio waves into digital information that can then be passed on to various devices that can make use of it [11]. RFID technology is used in numerous applications some of them include: Passport card, timing races, contactless smart card and RFID chips are also being implanted in human and animals for identification and security purposes.

IV. IMPLEMENTATION

A) User profile on smartcard

Today we can consider smartcards as the most secure moveable computing device. They have been covering successfully many applications involving money, proprietary and personal data (such as banking, healthcare, insurance, etc.). The smartcard integration in information filtering process guarantees advanced security but it shows two main limitations, in conditions of computing capacity and storage capabilities. This section, first will discuss the smartcard technology and then the implementation of user profile.

Smartcard Technology

A smartcards are the type of chip implanted within the card and its capabilities, and contains the following components, as illustrated in Figure 4, a CPU, a ROM to store operating system code, a RAM for stack operations, an EEPROM memory to store java byte code or user data, a communication bus, and an Input/output connector to communicate with the outside world. The size of the smart card is becoming smaller as a result of silicon technology to reach 0.18-micron process. The CPU is a 32-bit microprocessor with a processing power of 33 MIPS (Million Instructions per Second) at 33MHz frequency. From 128 to 256KB of ROM is the memory capacities range, from 64 to 128KB of EEPROM and from 4 to 8KB of RAM. The key issue of smart cards in the future is the performance of its components, and considered it to be the most secure communicating object on the Internet.

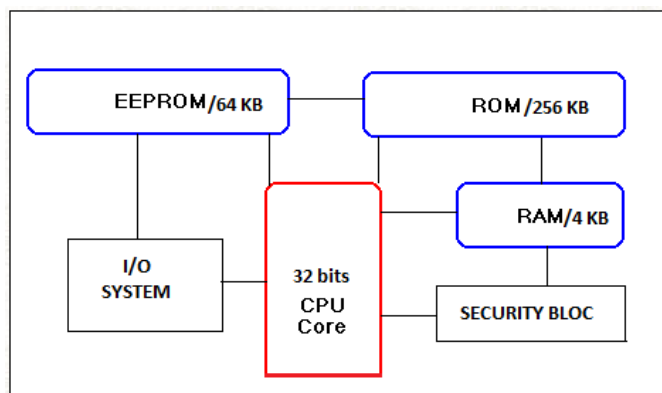

Fig.4. Smartcard architecture

The structure of User Profile

The structure of User Profile based on information personalization approach, which it has two kinds explicit and implicit personalization. Explicit personalization asks users directly on their needs, while the implicit personalization studies the user operations on the network. Both methods collect automatically personal information related to the behavior of the user. This information must be analyzed and classified and then stored in the database. The combination of the explicit and implicit personalization techniques proves to be more capable while integrating training techniques or the intelligent agents. These techniques created or revalue the user profile according to his actions.

User Profile Implementation

The implementation of user profile depends on the database structure and DBMS. However when user profile used the smart card, it has some limitations, which includes slow processing, area of the random-access memory very little, constrained stable memory, no autonomy, etc.. This situation makes traditional database technology irrelevant anymore. To overcome this problem Puchera *et. al.* propose a Pico DBMS (Pico-Data Base Management System) solution based on highly compact data structures, query execution without RAM and specific techniques for robustness [12]. Our study uses this solution in implementing user profile in the RFID-SIM card. The user profile composes of user identity and preferences and it will store on the Pico-Database. Preferences are first stored in explicit manner, and then enriched implicitly.

B) RFID in SIM card

Today significant opportunities exist to develop a strong market for RFID systems using mobile phones. This will require issuing a mobile phone with a RFID chip. Many mobile phone manufacturers like Nokia and Sony Ericsson have introduced mobile phones with built-in read/write RFID capability. For instance the prototype Nokia 3220 NFC contains an RFID reader and writer on the base of the mobile phone. At its most simplest, the Nokia 3220 NFC RFID phone simply reads and writes information contained within an RFID tag [13]. It simply places the bottom of the 3220 over a tag, and it reads the information, flashing and beeping when the information has been successfully received. At first glance,

this seems no different to Bluetooth communication. Figure 5 shows RFID tag embedded on the smart card.

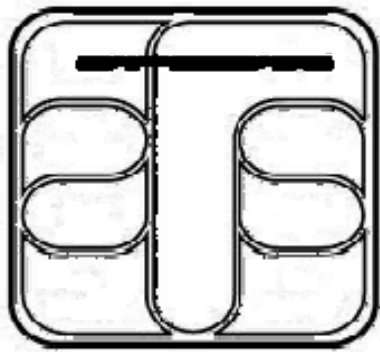

Fig.5. RFID tag embedded on the smart card

RFID technology

RFID is in use all around. RFID is increasingly used with biometric technologies for security. Unlike ubiquitous UPC bar-code technology, RFID technology does not require contact or line of sight for communication [14]. RFID data can be read through the human body, clothing and non-metallic materials. A basic RFID system consists of three components as illustrated in Figure 6, an antenna or coil, a transceiver (with decoder) and transponder (RF tag) electronically programmed with unique information.

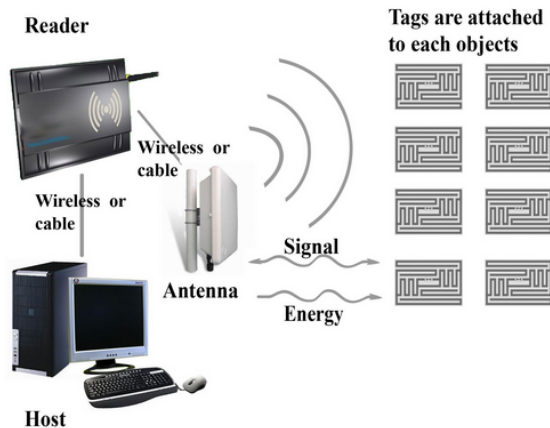

Fig.6. RFID system components

The purpose of an RFID system is to enable data to be transmitted by a portable device, called a tag, which is read by an RFID reader and processed according to the needs of a particular application. The data transmitted by the tag may provide identification or location information, or specifics about the product tagged, such as price, colour, date of purchase, etc. RFID technology has been used by thousands of companies for a decade or more. RFID quickly gained attention because of its ability to track moving objects. As the technology is refined, more pervasive - and invasive - uses for RFID tags are in the works.

A typical RFID tag consists of a microchip attached to a radio antenna mounted on a substrate. The chip can store as much as 2 kilobytes of data.

The reader is needed to retrieve the data stored on an RFID tag. A typical reader is a device that has one or more antennas that emit radio waves and receive signals back from the tag. The reader then passes the information in digital form to a computer system.

RFID impeded in SIM card

The product proposed in this paper is a RFID-SIM card. The RFID chip embedded in the SIM card will be detected by a RFID reader installed at various places when the chip is within the range. The RFID chip will have a read-write memory to store the current information of the SIM card. The user has to hold his RFID-SIM card against a RFID reader which will recognize the SIM card number and check the current information of the SIM card. The RFID enabled smart SIM cards can completely reshape the society because of its anytime, anywhere approach.

V. PERVASIVE NETWORK BASED RFID-SMARTCARD FILTERING SYSTEM

The implementation of this approach is shown in Figure 7. For activating the RFID tag that is attached to the components of the pervasive network, The RFID-SIM card sends a searching wave. The RFID-SIM card will receive information back from RFID tag. The profile management program displays the most possible information the user would need based on the RFID tag information and the profile information that is stored on the RFID-SIM card.

The proposed system will provide the really necessary selected information for user as it accesses the information services like the Internet. A list of information contains the user preferences and the current situation will use in the system to provide the preference and the current situation to provide the necessary information.

The process of collecting profile information from RFID is done by the information filtering system, which compares the received ID information to the ID information in the reference table which the system has created in advance and provides the comparing result to the user. This makes the user possible to get only the necessary information he/she needs at a situation as the ID information that is collectable is limited to the one from the area the radio signal can reach.

The user profile is implemented into SIM card using a Pico DBMS (Pico-Data Base Management System), which is based on highly solid data structures, query execution without RAM and specific techniques for robustness. Thus we can avoid the limitations of smart cards, including slow processing, area of the random-access memory very little, constrained stable memory, no independence, etc, also to achieve more robust and high secure module. The execution mode is that the SIMcard authenticates the user's URL documents if the URL document is acceptable then it allows the browser to connect directly to the network, else it sends a message error indicating that the URL document is not authorized.

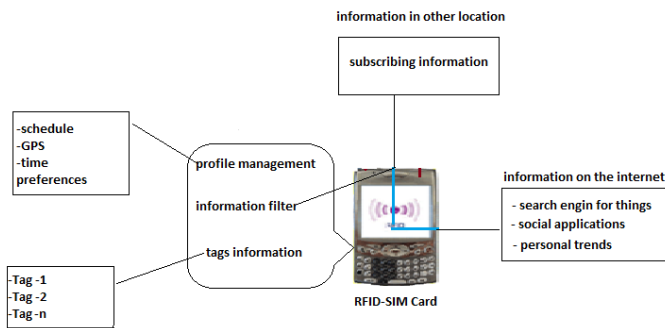

Fig.7. Pervasive network Based RFID-Smartcard Filtering System

To avoid the difficult of distinguishing in the surrounding tags the list of RFIDs should be updated when the user changes his location. The change of location can be recognized by using GPS system. The item will be identifies if is being in the list for a certain time of period.

VI. DISCUSSION

The tag information in pervasive networks is very useful, but also could be a very insecure. It could reveal a person's privacy. To solve the problem of privacy, dual of RFID can be used. One of them is used as original RFID and the second is used to provide a shield to the original one. So no private information can be detected to the public from the original one.

The signal of the RFID transmitted in different distance. The first is in several millimeters, while the second is in several meters. The reading of the signal can be done by attaching the second RFID to the first.

The first RFID can encrypt the ID information; and the second can read the ID signal from the first, no other RFID reader can receive the ID from the first (limited distance). The second will transmit an encrypted ID for RFID readers, and no one can use it without knowing a decryption key.

Another technique of security can be applied by concealment of ID information for the first RFID. The second RFID covers the first RFID, to prevent the scan waves from other RFIDs and let the second RFID works as a transmitter.

For more robustness of the data transmission a secure program application for both RFIDs to execute an access sequence such as three or more handshake can be implemented.

VII. CONCLUSION

To find pertinent information on the pervasive networks become a challenge research work. The dynamic changing of pervasive networks information makes the user facing a difficult to obtain pertinent information in suitable time. The RFID embedded on smart SIM cards could improve the world because it's anytime, anywhere access approach. The benefits of this technology are: flexibility, safety and mobility. This paper proposed a flexible and secret model to implement user profile for information filtering. Embarking user profile in RFID-SIM card makes the model more robust and higher

security. The design of the proposed system and the implementations of User profile on smartcard and RFID in SIM card are described. Pervasive network based RFID-Smartcard Filtering System is presented, which benefits from user profile to filter information.

REFERENCES

- [1] C. Riordan and H. Sorensen. Information Filtering and Retrieval: An Overview. . *Proceedings of the 16th Annual International Conference of the IEEE*, , (pp. A42 - A49 vol.1). Baltimore, MD, Nov 1994.
- [2] J. P. Callan, W. B. Groft and S. M. Harding "The inquiry retrieval system" Technical report, Department of Computer Science, University of Massachusetts, 1993.
- [3] C. Buckley. "Implementation of the smart information retrieval system" . Technical report: TR85-686, Dept. of Computer Science, Cornell University, 1985.
- [4] T.W. Yan, H. Gracia-Molina, "The SIFT Information Dissemination System", *ACM Transactions on Database Systems*, Vol. 24, No. 4, 1999
- [5] A. Lahlou, and P. Urien, "SIM Filter: User Profile based Smart Information Filtering and Personalization in Smartcard" *Ubiquitous Mobile Information and Collaboration Systems*, Klagenfurt / Velden, Austrian, June 2003.
- [6] D. Blair and M. Maron. An evaluation of retrieval effectiveness for a full document retrieval system. *Communications of the ACM* , 28(3), 289 - 299, 1985.
- [7] G. Salton. *Automatic Information Organization and Retrieval*. . McGraw-Hill Book Company, 1968.
- [8] H. Turtle and W. Croft. Evaluation of an inference networkbased retrievalmodel. *Special issue on research and development in information retrieval* , pp. 187 - 222, 1991.
- [9] E. Liddy, W. Paik, and E. Yu. Text categorisation for multiple users based on semantic features from a machine readable dictionary. *ACM Transactions on Information Systems (TOIS)* , 278-295, July 1994.
- [10] M. A Qadeer, N. Akhtar, S. Govil and A. Varshney, "A Novel Scheme for Mobile Payment using RFID-enabled Smart SIM card" *International Conference on Future Computer and Communication*, 2009.
- [11] S. Ahson. M. Ilyas "RFID Handbook Applications, Technology, Security, and Privacy". CRC Press Taylor & Francis Group, 2008.
- [12] P. Pucheral, L. Bouganim, Valduriez P., Bobineau C.: PicoDBMS: Scaling down Database Techniques for the Smartcard. in *VLDB Journal* , 10(2-3), 2001.
- [13] M. C. O'Connor "RFID Phone Payment Systems Good to Go", *RFID Journal - The World's First RFID Authority*, available in: <http://www.rfidjournal.com/article/articleview/1523/1/1/> , access on 18/8/2010.
- [14] K. Bonsor and C. Keener, "How RFID works" available in <http://www.electronics.howstuffworks.com/rfid.htm>, access on 14/8/2010.
- [15] C. Floerkeimeier and S. Sarma, "RFIDSIm—A Physical and Logical Layer Simulation Engine for Passive RFID" *IEEE transactions on automation science and engineering*, VOL. 6, NO. 1, January 2009.
- [16] C. Buckley, G. Salton, J. Allan and A. Singhal. *Automatic query expansion using smart: Trec 3*. Department of computer science, Cornell University, Ithaca, November,1994.