



저작자표시-비영리-변경금지 2.0 대한민국

이용자는 아래의 조건을 따르는 경우에 한하여 자유롭게

- 이 저작물을 복제, 배포, 전송, 전시, 공연 및 방송할 수 있습니다.

다음과 같은 조건을 따라야 합니다:



저작자표시. 귀하는 원저작자를 표시하여야 합니다.



비영리. 귀하는 이 저작물을 영리 목적으로 이용할 수 없습니다.



변경금지. 귀하는 이 저작물을 개작, 변형 또는 가공할 수 없습니다.

- 귀하는, 이 저작물의 재이용이나 배포의 경우, 이 저작물에 적용된 이용허락조건을 명확하게 나타내어야 합니다.
- 저작권자로부터 별도의 허가를 받으면 이러한 조건들은 적용되지 않습니다.

저작권법에 따른 이용자의 권리는 위의 내용에 의하여 영향을 받지 않습니다.

이것은 [이용허락규약\(Legal Code\)](#)을 이해하기 쉽게 요약한 것입니다.

[Disclaimer](#)

공학석사 학위논문

바퀴벌레 모사 소형 등반 플랫폼의 설계 및 제작

Design and Fabrication of a Small Climbing
Platform inspired by a Cockroach

2016년 2월

서울대학교 대학원
기계항공공학부
최 홍 철

Abstract

Design and Fabrication of a Small Climbing Platform inspired by a Cockroach

Hong-Cheol Choi

School of Mechanical and Aerospace engineering

The Graduate School

Seoul National University

Small mobile robots are required in rescue missions and military task. Milli-scale robots can pass a narrow gap within a collapsed building and carry out the reconnaissance mission without being detected by enemies. The issue of a small robot is that it might get stuck in obstacles that are bigger than itself. The ability to overcome obstacles is important to small robot. Climbing can make it overcome tens of times larger than itself. In this research, three principles of cockroach climbing are defined and integrated with planar mechanism.

Small cockroach can rapidly climb vertical walls with a rough surface. First principle inspired by a cockroach is stable walking with an alternating tripod gait. This gait makes stable locomotion possible thanks to the support of at least three feet. Planar transmission using a single actuator is designed for alternating tripod gait. Second principle is reducing the impact during the attachment process. Cockroach use compliant foot called tarsus structure. This can reduce

the amount of normal reaction force during the interaction between spines and surface. Compliant foot are modelled based on Pseudo-rigid-body model (PRBM). Hind leg is designed to reduce the pitch-back moment at the front limb without tail. Third principle is the phase overlap. Phase overlap is an overlapping of the set of feet on the ground. Cockroaches have the phase overlap during climbing at 5body-lengths/sec. Planar quick-return leg is designed to have the phase overlap during alternating tripod gait.

In this research, three key principles are extracted and integrated with planar fabrication for a small climbing robot. A new method using laminating film and fabric is developed for fast prototyping as well as for high structural strength. Fabricated robot is 8.5cm long and 6g in weight. This robot can climb on three different kinds of surfaces at around 0.1body-lengths/sec. The research suggest the possibility that a new approach based on biomimetics and planar design can solve the scale issue of small mobile robots thanks to a novel and simple mechanism.

Keyword: Climbing robot, Bio-inspiration, Biomimetics, Compliant mechanism, Planar fabrication, Smart composite microstructure(SCM)

Student Number: 2014-20661

Contents

Abstract	i
Chapter 1 Introduction	1
Chapter 2 The Principles of Cockroach Climbing	4
2.1 Alternating Tripod Gait.....	4
2.2 Reducing the Impact of Attachment.....	6
2.3 Phase Overlap.....	7
Chapter 3 Bio-inspired Design	8
3.1 Transmission using a Single Actuator.....	8
3.2 Compliant Foot and Hind Leg.....	9
3.3 Quick-return Leg.....	14
Chapter 4 Results	21
4.1 Planar Fabrication.....	21
4.2 Experimental Results.....	24
Chapter 5 Conclusion	26
Bibliography	28
국문 초록	33

List of Figures

Figure 2.1 (a) Cockroach (<i>Eublaberus distanti</i>). (b) Compliant foot called the tarsus. (c) Phase overlap of front leg and middle leg.....	5
Figure 2.2 The concept design of a small climbing robot (Left). Contact phase of alternating tripod gait (Right).....	5
Figure 3.1 Schematic diagram of three legs. Lateral view of four different positions. The orange arrow means contact phase and the green arrow means return phase.....	9
Figure 3.2 Modeling of compliant foot based on PRBM.....	11
Figure 3.3 Compliant foot based on planar design and fabrication (Left). Deflection in normal and tangential direction (Right).....	11
Figure 3.4 Result of tensile test and simulation.....	13
Figure 3.5 Normal force measurement of the foot with rigid spine...13	
Figure 3.6 Normal force measurement of the foot with compliant spine.....	14
Figure 3.7 Conventional quick-return mechanism (Left). Quick-return leg based on planar design and fabrication (Right).....	15
Figure 3.8 Schematic diagram of quick-return leg. The variables of kinematics and dynamics model are plotted.....	16
Figure 3.9 Tangential velocity graph based on kinematics. Red box means the phase overlap.....	18
Figure 3.10 2D tracking result of a quick-return leg.....	18
Figure 3.11 Force measurement set-up.....	19

Figure 3.12	Result of the tangential force and simulation.....	19
Figure 3.13	Resultant tangential force of the hexapedal robot.....	20
Figure 4.1	Fabrication process using laminating film and fabric.....	22
Figure 4.2	Bending test of cardboard and laminating film.....	23
Figure 4.3	Fabrication result of the robot. Size comparison between the robot and a cockroach.....	23
Figure 4.4	(a) 2D tracking results of climbing on the three different surfaces. (b) The robot can pass the narrow gap (Height : 30mm).....	24
Figure 4.5	Y-axis displacement during climbing on the three surfaces.....	24

List of Tables

Table I	Specification and electronics of the robot.....	24
Table II	Comparison of the multi-legged climbing robots using spines.....	27

Chapter 1. Introduction

Small robots can move in a confined space and pass a narrow gap. Therefore, milli-scale robots are required in rescue mission to find people in a collapsed building and reconnaissance mission without being detected by enemies. The issue of a small mobile robot is that it might get stuck in obstacles that are bigger than itself. Wheeled and crawling robots have difficulty overcoming obstacles that are bigger than themselves. Therefore, climbing mechanism could be the solution to scout the uncertain area because it can overcome tens of times larger than itself.

Many climbing robots have been proposed using suction cups [1-2], magnets [3-5], dry adhesive [6], and spines [7-10]. Each attachment mechanism have different advantages and characteristics. Among these methods, the spine-based approach can be applied to a variety of surfaces, including dusty and rough surfaces. Therefore, climbing robots using spines are suitable for outside mission because spines and claw have reusability on rough and dusty surfaces. Previous studies on climbing mechanism that use spines have proposed large-scale robots. These robots employ many actuators and complex controller to keep attachment to the wall during climbing. The RiSE robot lifts a single leg and makes it engage the next asperities while its other five legs exert force in the fore-aft direction to provide adhesive force [8]. Microspine rock-climbing robot is a quadruped robot that always maintains a grip on surfaces using at least three legs [9]. These robots have shown great success in climbing vertical walls, but are difficult to pass the narrow gap

because of their size. Miniaturizing these climbing robots while using conventional mechanical components is difficult with current technology level due to the complexity of their mechanisms, actuators, and control board. Therefore, a different approach is required.

In this research, biomimetics is combined with planar design and fabrication to make a small climbing robot in a simple manner. Cockroaches can rapidly overcome unstructured area and climb the rough walls. Among many characteristics of cockroach climbing, we have extracted three key principles required for the robot climbing. First principle inspired by a cockroach is stable walking with an alternating tripod gait. This gait makes stable locomotion possible thanks to at least three feet for support. Second principle is reducing the impact during the attachment process. Cockroach use compliant foot called the tarsus. This can reduce the amount of normal reaction force during the interaction between spines and the surface. Third principle is the phase overlap. Phase overlap is an overlapping of the set of feet on the ground. Cockroaches have the phase overlap during climbing at 5body-lengths/sec [11]. Conventional mechanical components are difficult to apply these principles to the robot while making in a small size. Therefore, planar mechanisms are redesigned to generate climbing locomotion with three principles. Planar transmission using a single actuator is designed for alternating tripod gait. Compliant foot are designed using two four-bar linkages and modelled based on Pseudo-rigid-body model (PRBM). Hind leg is considered to reduce the pitch-back moment at the front limb without tail. Planar quick-return leg is designed to have the phase overlap during alternating tripod gait.

In the following sections, three key principles that are extracted

and implemented are explained in section II. The necessity of each principles and the effect on climbing locomotion are proposed. In section III, conventional mechanism is converted and novel components are designed to make planar mechanisms based on bio-inspiration. The forementioned mechanisms are integrated and fabricated to implement biological inspirations.

Chapter 2. The Principles of Cockroach Climbing

2.1 Alternating Tripod Gait

Small robot have no enough space to equip actuators and controller to produce the complex locomotion. Instead of control-based approach that use many actuators, sensors, and feedback controller, structural and mechanical solution is required in a small size platform. Therefore, the first principle is stable walking with an alternating tripod gait. Insects have six legs and alternately move two tripods comprised of front, hind leg, and the other side middle leg (Fig. 2.1. (a)). Two tripods have a phase difference of 180 degrees. This gait enables cockroach to make three points of contact with a surface for support. Because three legs are always in contact with ground, walking of insects becomes mechanically stable.

Previous studies about alternating tripod gait of cockroach are proposed. Animals with at least three legs on the ground can be statically stable during locomotion if their center of mass falls within the tripod of support [12-13]. Stability is fundamental to the performance of terrestrial locomotion and hexapods can exploit the advantages of both static and dynamic stability [13]. Alternating tripod gait could be mechanical system which enables self-stabilization against perturbation and can make control simpler [14].

As shown in Fig. 2.1. (a), cockroaches can crawl stably with an

alternating tripod gait. Fig. 2.2 shows the concept design of a small climbing robot which has alternating tripod gait.

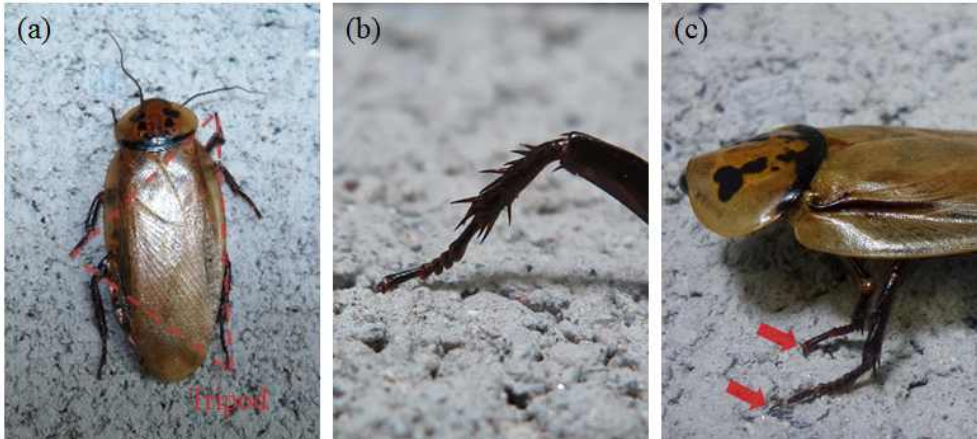

Figure 2.1 (a) Cockroach (*Eublaberus distanti*). (b) Compliant foot called the tarsus. (c) Phase overlap of front leg and middle leg.

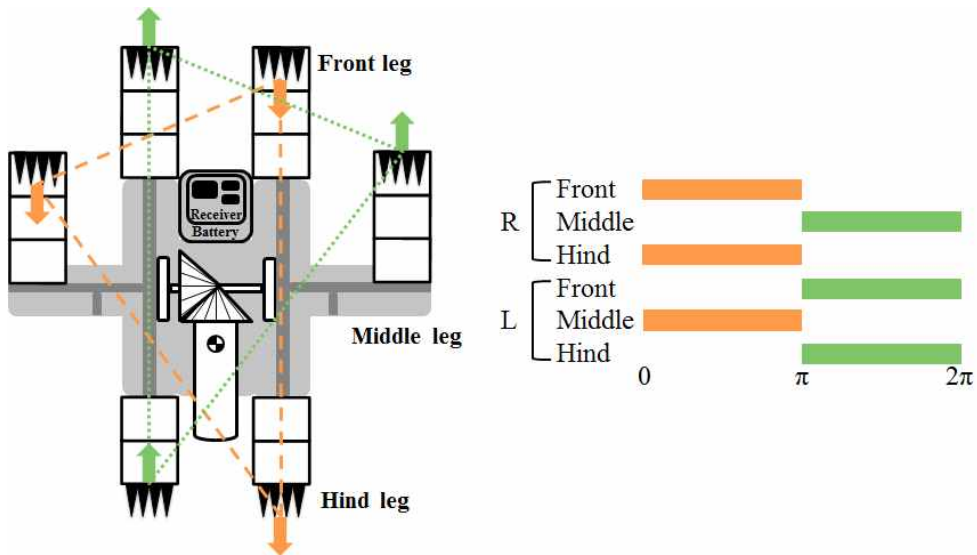

Figure 2.2 The concept design of a small climbing robot (Left). Contact phase of alternating tripod gait (Right).

2.2 Reducing the Impact of Attachment

To engage rough and dusty surfaces, it is difficult to use either a directional adhesion or a structured adhesive repeatedly because of the presence of dust and debris. Thus, friction-based attachment mechanism such as spine and claw is suitable for rugged terrain. When the spines attach dynamically to the wall, the impact occurs due to reaction of the surface. This impact could induces disastrous results that animals and robots are overturned and fallen onto the ground. Therefore, it is important to lower the impact to a level where an adhesive force of the robot withstands.

In a natural world, cockroaches and hornets have compliant foot called the tarsus [15–16]. The forces at impact of feet with the ground can be moderated by compliant foot pads (Fig. 2.1. (b)), which can improve road holding by preventing vibrations [17]. Cockroaches use a single muscle, the retractor unguis, to engage adaptively on uneven substrates. The elastic mechanisms allow selective use of the claws in cockroaches [17]. Therefore, the compliant foot can reduce the impact at the front limb and increase the probability of engagement on a rough surface.

To reduce the pitch-back moment could help to reduce the required adhesive force at the front legs. Legs of cockroaches above the body center of mass mainly pull, whereas legs below it mainly push to balance the force of gravity [15]. Hind legs that push distally during upward-climbing could reduce the pitch-back moment induced by reaction force. Compliant foot and pushing hind legs can prevent from falling off a wall.

2.3 Phase Overlap

Climbers find the next asperity to engage, and then move a hand or foot to it while others keep engagement. Likewise, Lemur IIb robot using motion planning can determine the route through the terrain and hold-to-hold motions that maintain the robot in static equilibrium during climbing [18]. Because tangential force to overcome gravity and negative normal force to attach are continuously necessary for climbing locomotion.

Cockroaches have no flight phase and have phase overlap during dynamic climbing at 5body-lengths/sec. Phase overlap is an overlapping of the set of feet on the surface (Fig. 2.1. (c)). During the phase overlap period, the fore-aft force becomes minimal and the peak negative force pulls the animal back toward the wall [13]. Therefore, phase overlap can allow stable alternation of the tripods on the vertical wall.

As shown in Fig. 2.2, alternating tripod gait have no phase overlap. Therefore, return phase should be shorter than contact phase to have phase overlap in the middle of a gait. In other words, the average velocity when a leg returns should be faster than that when a leg contact with the surface. Thanks to phase overlap that quick-return legs make, a tangential force is always over zero during the whole period and an adhesive force arises from a fore-aft force during alteration of the legs.

Chapter 3. Bio-inspired Design

3.1 Transmission using a Single Actuator

There is a limit on the number of actuators due to the space limitations of a small platform. Therefore, the transmission to actuate six legs should be designed using a limited number of actuators. In addition, the alternating tripod gait is implemented in a simple manner to reduce size and weight, so the transmission is composed of planar design.

The transmission uses one motor and is made by folding a patterned sheet. Two bevel gears are used to transmit power generated by a single motor to both sides. Each side actuates three legs. Lever mechanism is designed to make a phase difference of 180 degrees between the front and hind legs and the middle leg. As shown in Fig. 2.2, three legs on orange and green triangle are coupled and move together.

As shown in Fig. 3.1, schematic diagram shows movement of one side of the platform. In the diagram, black lines and points means hinges playing as a role of revolute joint. Gray lines and plates means links. Green dashed circle represents a radius of rotation generated by a motor. Orange line means contact phase and green line means return phase. Front and hind legs move in similar phase. And the phase of middle leg is opposite to that of front leg due to lever mechanism. Lever mechanism with six hinges can make a phase difference of 180 degrees. One side has a opposite phase to the other side, so six legs can make alternating tripod gait.

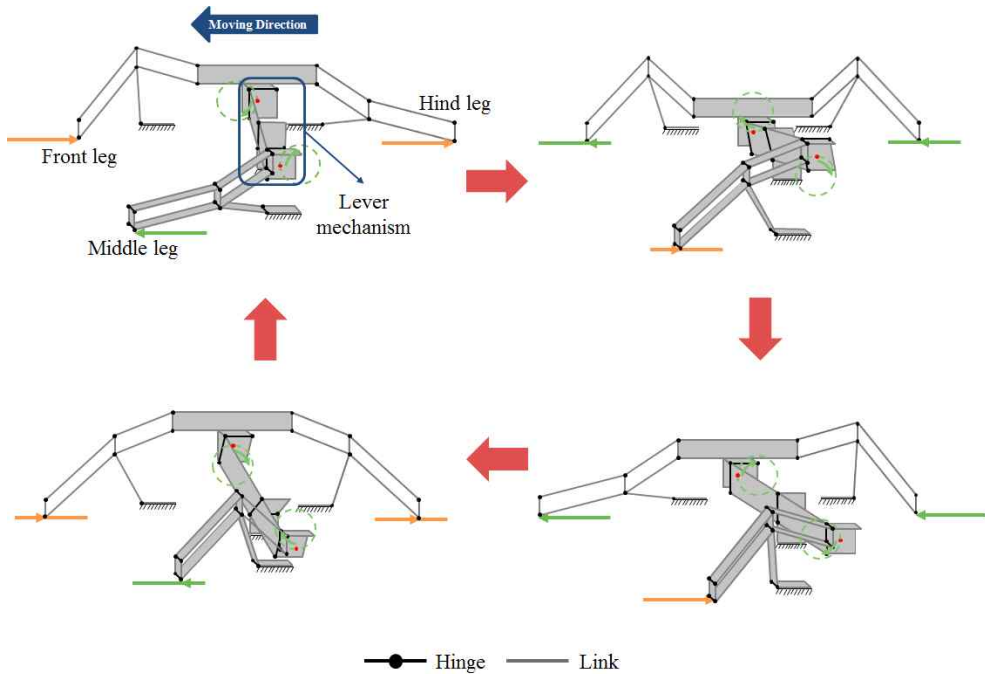

Figure 3.1 Schematic diagram of three legs. Lateral view of four different positions. The orange arrow means contact phase and the green arrow means return phase.

3.2 Compliant Foot and Hind Leg

Unlike carpet or loose cloth, a hard surface returns the impact to the robot by reaction force. Thus, climbers could be ricocheted off a wall and fallen on the ground because of pitch-back moment induced by the impact at the front limb. As mentioned previous section, the compliance in the attachment mechanism play a important role in order to reduce the impact during climbing on a rough surface. Adding compliances to a foot not only slows oscillations of the ground reaction force but also increases the damping ratio to prevent

the overshoot of wall reaction force [19]. Therefore, the attachment can be more guaranteed.

A previous study about the design for a compliant spine proposes the following requirements: Spines should engage on the surface individually, and the load should be distributed evenly. The angle of the spine should be kept constant [20]. Another study suggests that an angle between 45 degrees and 60 degrees is appropriate to make the adequate adhesion [21]. Microspines that satisfy above conditions are manufactured based on shape deposition manufacturing (SDM), thus it is difficult to miniaturize.

In this study, a compliant foot with spines is designed based on planar fabrication. A PET film is selected to make a compliant mechanism. The width of a single foot with four spines should be within 8mm in order to be applied to a small robot. Compliant foot have both normal and tangential compliances to engage individually. As shown in Fig. 3.2, Modeling of the compliant spine is performed according to the PRBM [22]. By putting a torsional spring element at a specific position on the beam, a deflection similar to an actual beam can be simulated.

$$K = \gamma K_{\theta} \frac{EI}{l} \quad (3.1)$$

$$\gamma l F = 2K\theta \quad (3.2)$$

$$F = \frac{2}{l^2} K_{\theta} EI \cdot \sin^{-1}\left(\frac{x}{\gamma l}\right) \quad (3.3)$$

where γ is the characteristic radius factor, K_{θ} is the stiffness coefficient, θ is the deflection angle, E is the modulus of elasticity, I

is the moment of inertia, and F is the force exerted on the middle of compliant foot.

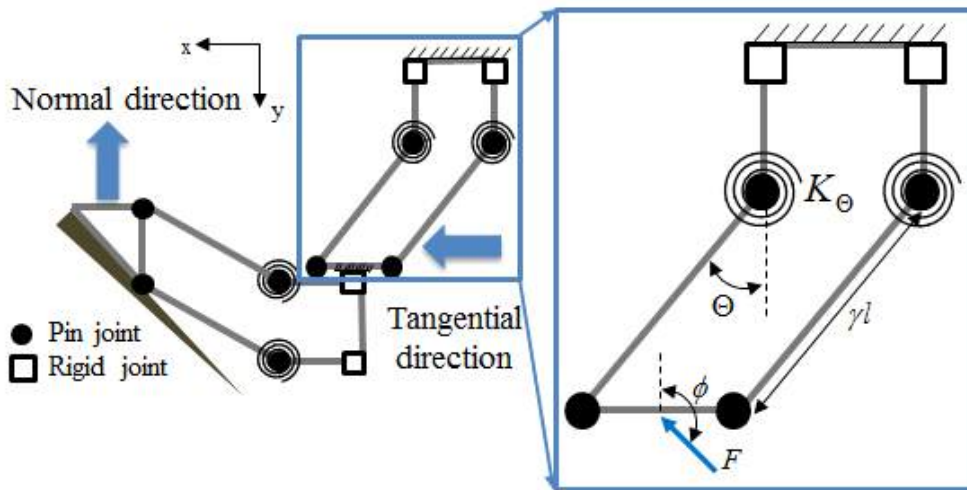

Figure 3.2 Modeling of compliant foot based on PRBM.

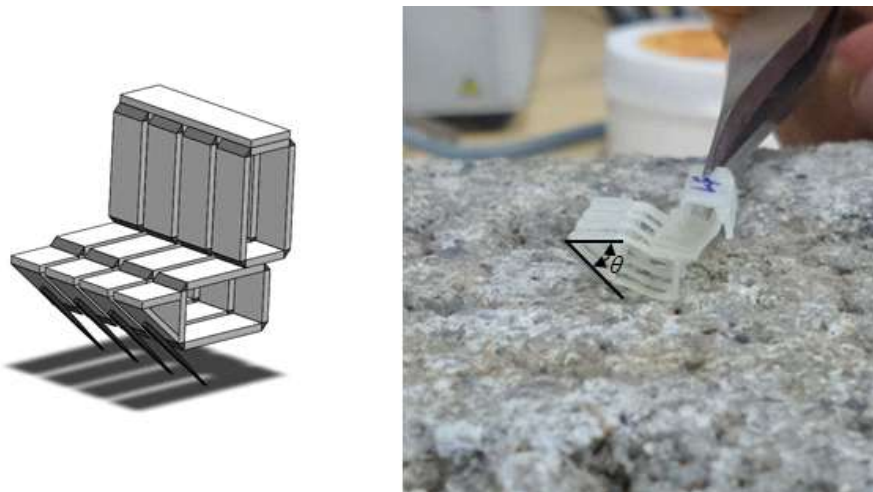

Figure 3.3 Compliant foot based on planar design and fabrication (Left). Deflection in normal and tangential direction (Right).

The equations are arranged in (3.1) - (3.3) to plot the required force with regard to x-axis deflection induced by an engaging force from a single leg. Tensile test prove that the model similarly matches the real deflection (Fig. 3.4). The compliant spines are fabricated to meet the aforementioned requirements. In the feasibility test, compliant foot with spines works on surfaces individually thanks to two types of compliances, and the probability of engagement on a rough surface can be increased. The angle of a spine is kept constant at 45 degrees as shown in Fig. 3.3.

Figure 3.5 and 3.6 show the normal force measured by a load cell. These graphs show the comparison of normal force between a rigid spine and a compliant spine. Peak normal force of rigid spine is higher than that of compliant spine. Therefore, compliant foot can reduce the impact during attachment and help spines to engage on uneven asperities.

Previous robots need the tail to compensate for the pitch-back moment [7-8]. Because the legs of these robots can only pull the wall. In this research, hind legs below the body center of mass are designed to push the wall. Therefore, the hind legs can reduce the pitch-back moment at the front limb without a tail. And it helps to reduce the total length of the robot.

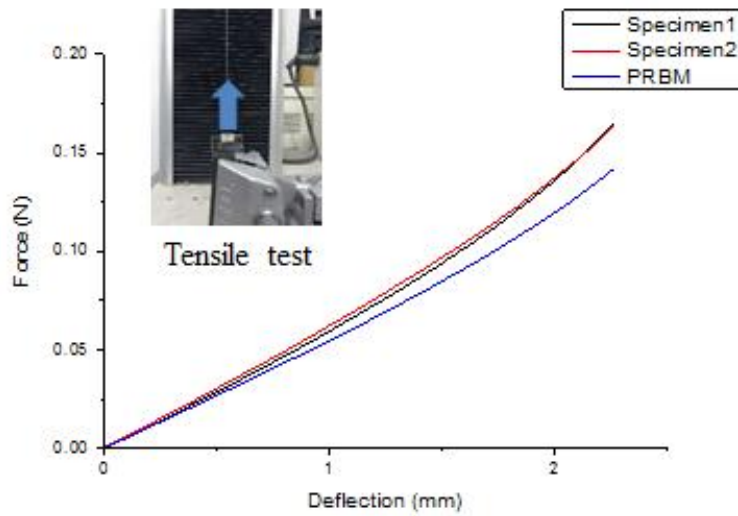

Figure 3.4 Result of tensile test and simulation.

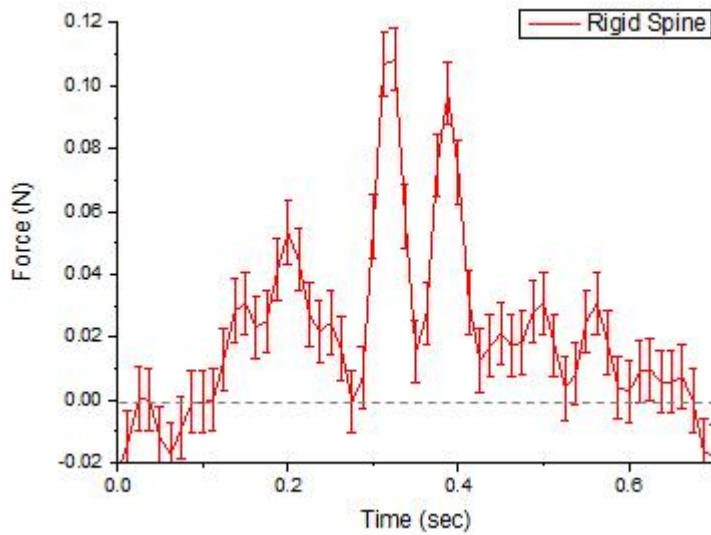

Figure 3.5 Normal force measurement of the foot with rigid spine.

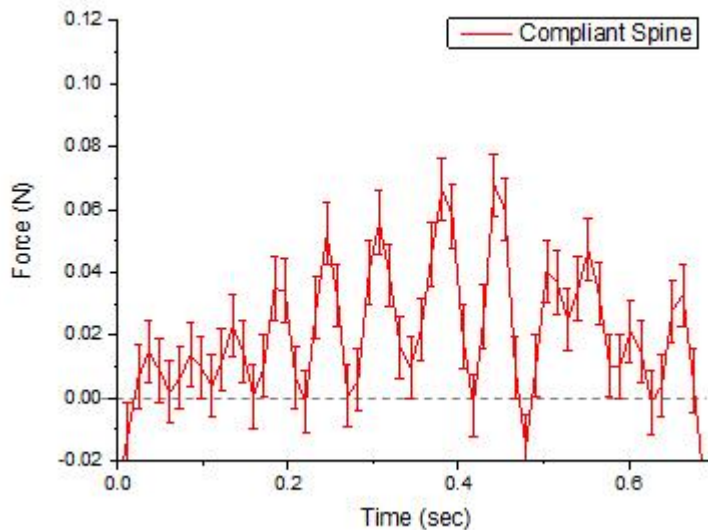

Figure 3.6 Normal force measurement of the foot with compliant spine.

3.3 Quick-return Leg

A conventional quick-return mechanism using a slider was considered for the climbing platform in order to produce the phase overlap (Fig. 3.7). During actuation of the quick-return mechanism, the return phase is shorter than the contact phase. When two mechanisms with a phase difference of 180 degrees move simultaneously, there should be a period when the two mechanisms are in a contact phase at the same time. Therefore, quick-return mechanism can create a phase overlap period. However, it is difficult to miniaturize the conventional components like a slider and a rigid link. This mechanism should be redesigned based on a

two-dimensional (2D) mechanism, and 4-bar linkage and sarrus linkage are combined to generate quick-return motion. The phase overlap are implemented by employing a novel quick-return leg that have one degree of freedom (DOF). Thanks to the planar design and fabrication, it can be smaller and lighter. The trajectory and velocity of this leg are calculated based on kinematics.

$$\psi = \pi - \alpha - \beta \quad (3.4)$$

$$\delta = \cos^{-1}\left(\frac{c \cdot \sin(\psi) + h_2}{d}\right) \quad (3.5)$$

$$\begin{pmatrix} x \\ y \end{pmatrix} = \begin{pmatrix} -c \cdot \cos(\psi) - d \cdot \sin(\delta) - b \\ c \cdot \sin(\psi) - d \cdot \cos(\delta) \end{pmatrix} \quad (3.6)$$

where a , c , and d are the link length, r is the length of the drive link, θ is the phase of the motor, h_1 is the distance between the center of the circle and the fixed point, h_2 is the height between the end-effector and the fixed point, α , β , γ , δ , and ψ are the angles of links in absolute coordinate system (as shown in Fig. 3.8).

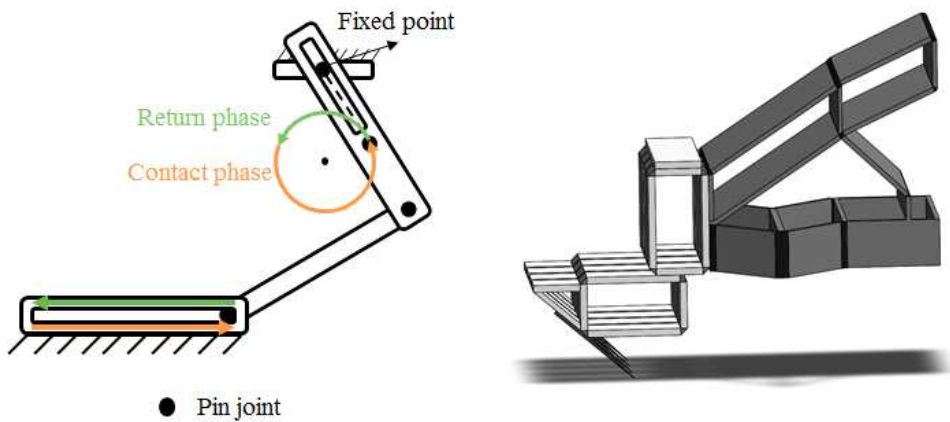

Figure 3.7 Conventional quick-return mechanism (Left). Quick-return leg based on planar design and fabrication (Right).

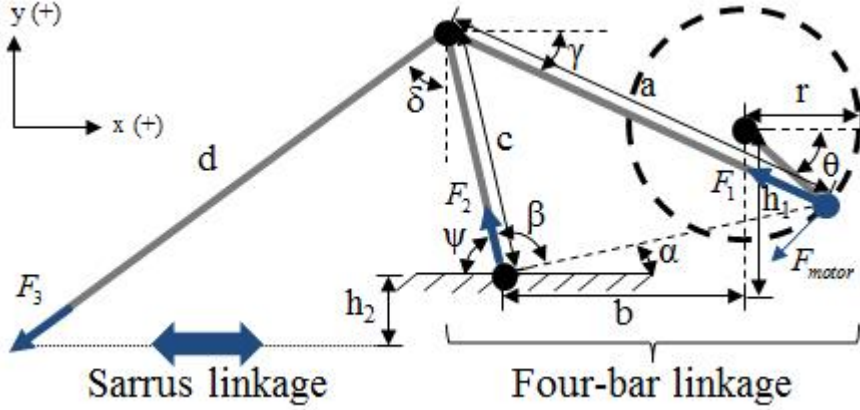

Figure 3.8 Schematic diagram of quick-return leg. The variables of kinematics and dynamics model are plotted.

Y-axis displacement of end-effector is constrained because of sarrus linkage. Figure 3.9 shows the simulation result of quick-return legs based on kinematics. The trajectory of the leg is calculated in (3.4) - (3.6). X-axis velocity of three legs are plotted to verify the period of phase overlap. The phase of a middle leg is different from that of front and hind legs due to alternating tripod gait. Red box means the overlap region in Fig. 3.9. When a middle leg with positive tangential velocity maintains engagement to generate adhesive force, front and hind leg are about to have enough positive tangential velocity to engage on the next asperities. Therefore, the stable alternation of tripods can be possible during the phase overlap. 2D tracking result also prove that return phase is shorter than the contact phase as shown in Fig. 3.10.

$$F_1 \cos(\gamma) + F_2 \cos(\psi) + F_3 \sin(\delta) = 0 \quad (3.7)$$

$$F_1 \sin(\gamma) - F_2 \sin(\psi) + F_3 \cos(\delta) = 0 \quad (3.8)$$

$$F_3 = \frac{-F_1(\sin(\gamma)\cos(\psi) + \cos(\gamma)\sin(\psi))}{\sin(\delta)\sin(\psi) + \cos(\delta)\cos(\psi)} \quad (3.9)$$

where θ is the phase of the motor, α , β , γ , δ , and ψ are the angles of links in absolute coordinate system, and F_{motor} is the force generated by a motor, F_1 , F_2 , and F_3 are the forces of link a , c , and d (as shown in Fig. 3.8).

Tangential force of a single leg is computed based on a force equilibrium in (3.7) - (3.9). Black solid line is the tangential force measured using a load cell (Mini40, ATI Technologies, Inc.), and red line is simulation (Fig. 3.12). Experiment set-up consists of a load cell that is mounted on a box covered with sandpaper and linear guide to attach the robot with a single foot (see Fig. 3.11). Measured forces approach zero in the region that simulation result is under zero in the graph. In other words, this region is the return phase and hardly generates negative force on experiment set-up. Which means, when the spine returns, it slips and detaches from the wall. Because the spine retains the angle of 45 degrees.

$$F_n = \mu_s F_t, \quad 0.57 \leq \mu_s \leq 0.7 \quad (3.10)$$

where μ_s is the coefficient of static friction on the concrete [23].

The resultant force of two tripods is plotted in Fig. 3.13. The adhesive force of the robot can be calculated in (3.10) using the smallest tangential force during the gait cycle. In the microscopic view, the tangential force becomes the normal force because of the rough surface. Therefore, the hexapedal platform can always generate negative normal force to keep attachment thanks to the phase overlap.

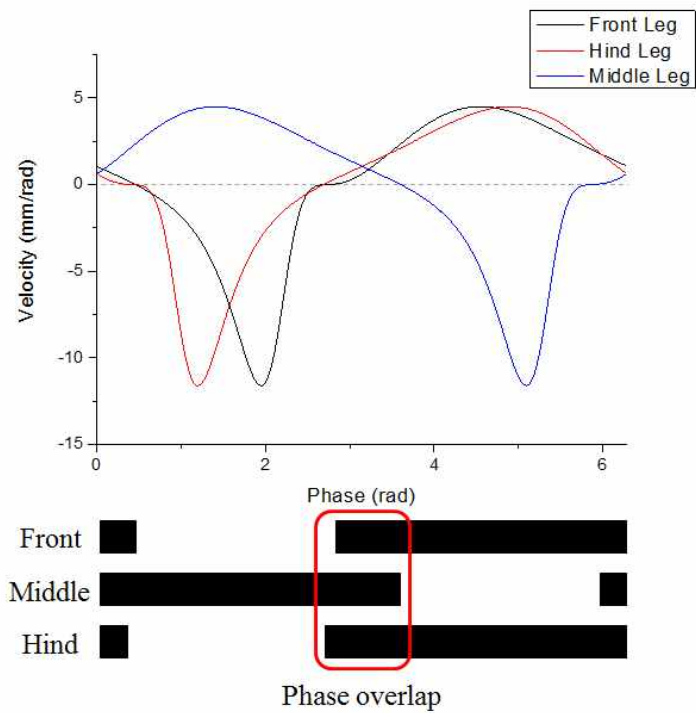

Figure 3.9 Tangential velocity graph based on kinematics. Red box means the phase overlap.

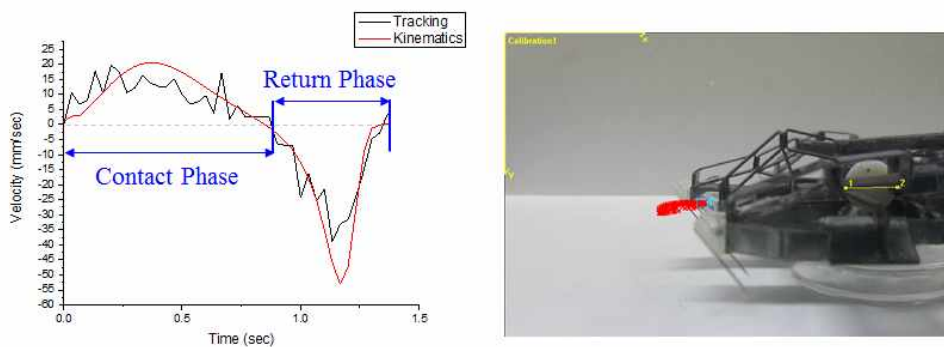

Figure 3.10 2D tracking result of a quick-return leg.

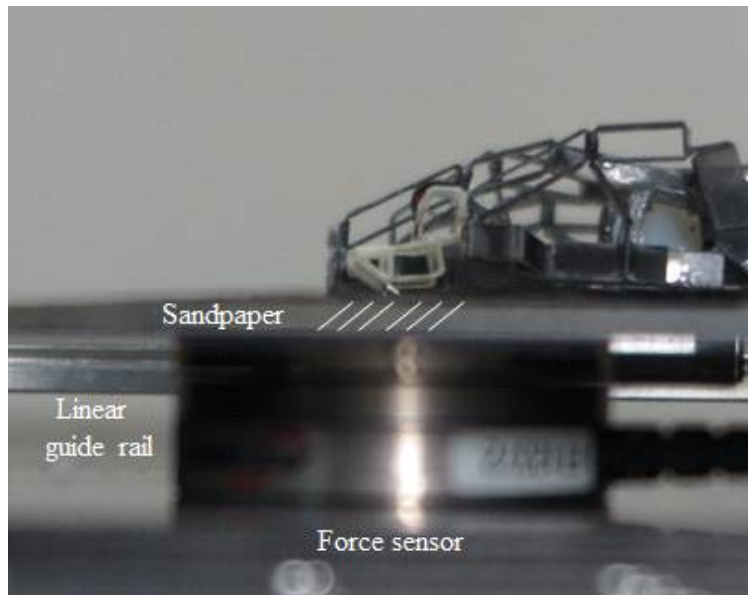

Figure 3.11 Force measurement set-up.

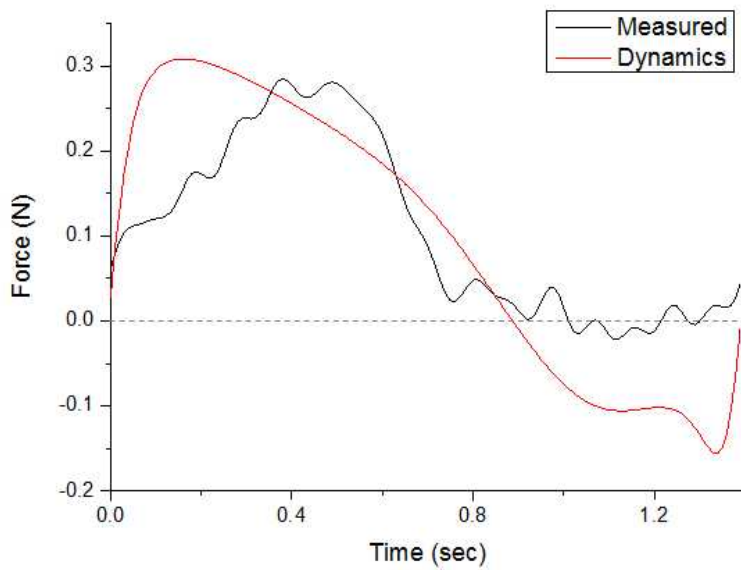

Figure 3.12 Result of the tangential force and simulation.

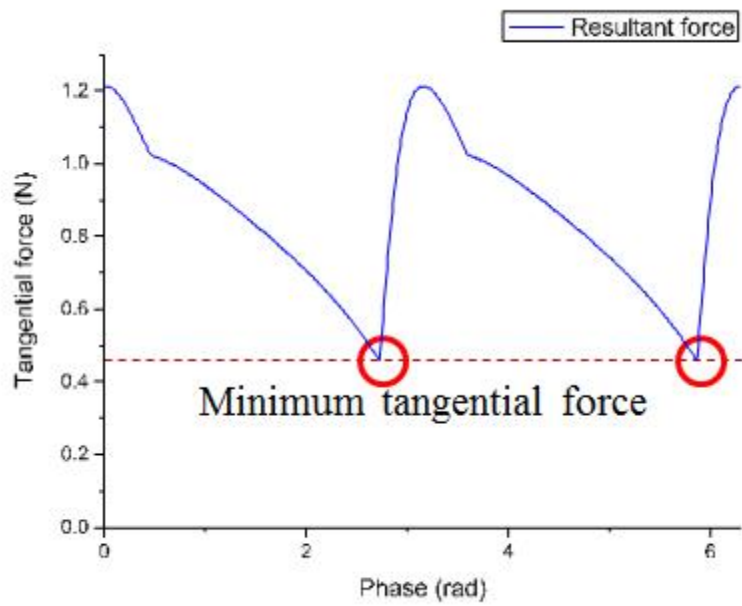

Figure 3.13 Resultant tangential force of the hexapedal robot.

Chapter 4. Results

4.1. Planar Fabrication

Planar fabrication method is fundamentally based on the Smart Composite Microstructure (SCM) process for a small-scale robot. This 2D-based fabrication process uses laser micromachining and laminating. The composite such as CFRP and GFRP is used for the rigid link, and the flexure such as polyimide film is used for the revolute joint [24]. Modification of the process has been proposed using poster-board and polymer films for fast prototyping and fabrication of milli-scale robots [25]. The fabrication process has been simplified and the stiffness of the rigid link has been increased by using laminating film and fabric [26].

Thin fabric can be inserted between sheets of the film without requiring an additional adhesive sheet because the laminating film contains an adhesive. Bending test in Fig. 4.2 shows laminating film is two times stiffer than cardboard with same thickness. Therefore, laminating film is more appropriate to transmit the power without the loss. The four step process is shown in Fig. 4.1: (1) cutting the hinges, (2) laminating, (3) cutting the outline, and (4) assembly the parts. From (1) to (3) process can be completed in 10 minutes on average. And then, the compact platform is completed through an assembly process.

As shown in Fig. 4.3, the size of a fabricated robot is similar to that of a cockroach. Specification and electronics used in the fabrication of the robot is shown in Table I. A mass of the platform

is sub 6 gram without battery and receiver and a length of that is 8.5cm long. And the total fabrication cost is affordable, and this platform can be used as a disposable robot for scouting mission.

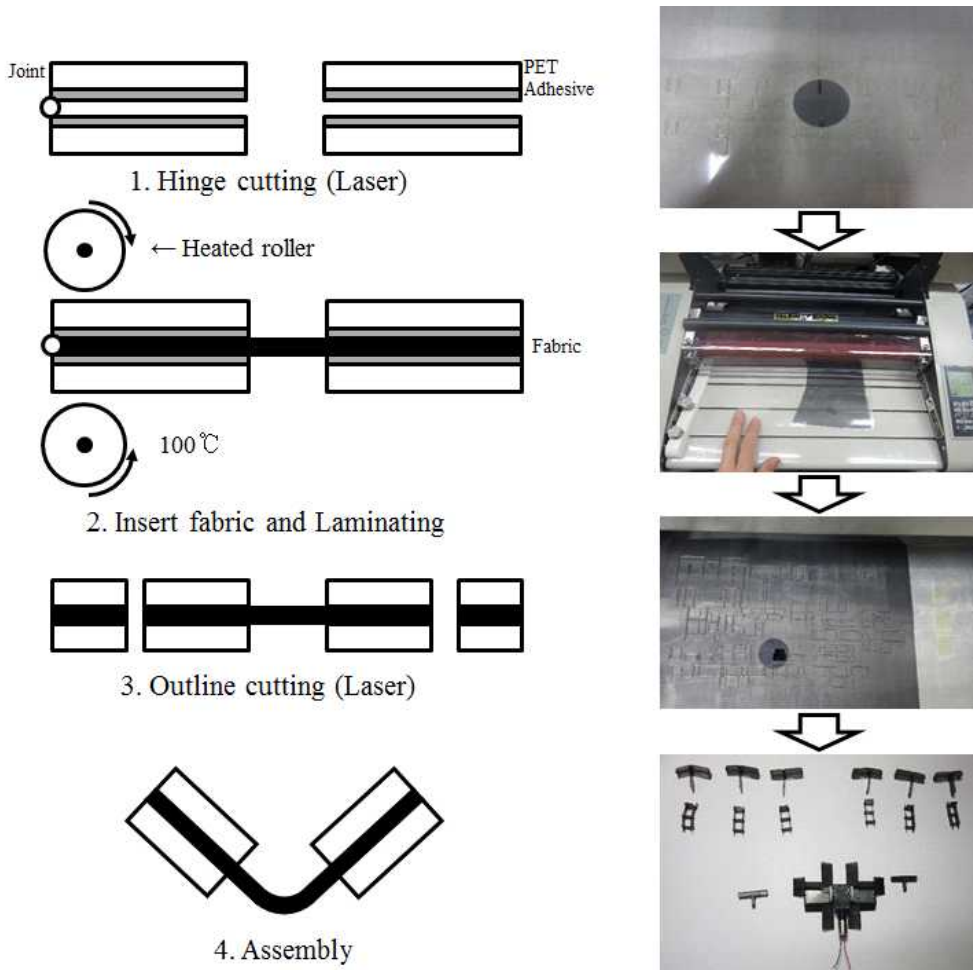

Figure 4.1 Fabrication process using laminating film and fabric.

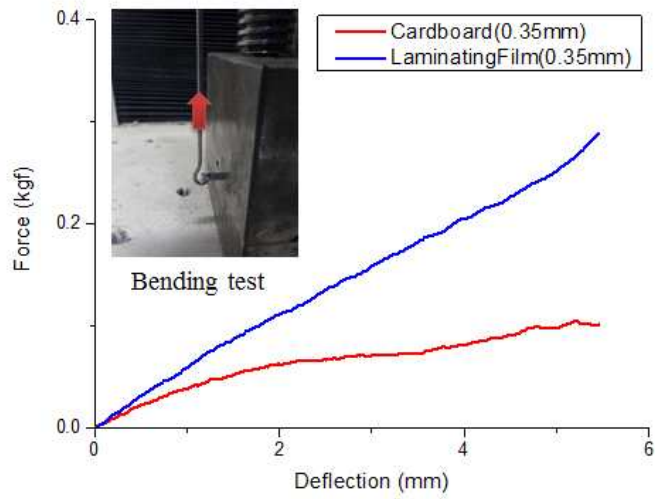

Figure 4.2 Bending test of cardboard and laminating film.



Figure 4.3 Fabrication result of the robot. Size comparison between the robot and a cockroach.

Table I Specification and electronics of the robot

Size	$7 \times 8.5 \times 2.5 \text{ cm}^3$	
Mass (gram)	7.7	3V DC motor (D&J WITH Co., Ltd.) 10mAh battery (HHS Co., Ltd.) RF receiver (drcmall.com)
Velocity (body-length/sec)	0.11 0.1 0.06	On near-vertical brick On vertical fabric On vertical styrofoam

4.2. Experimental Results

The ability to overcome obstacles is important because small robot might get stuck in rugged terrains that are bigger than itself. Passing the narrow gap is also important to find people in a collapsed building. In order to solve this issue, three biological principles are extracted and implemented in a simple manner to make a small robot. Climbing performance could prove whether this approach is appropriate.

A climbing experiment was conducted on the three different surfaces with an incline from 0 degree to 90 degree. 2D tracking was conducted with via videotaping, and the climbing speed was determined as shown in Table I. This platform can climb up near-vertical brick at around 0.11body-length/sec (Fig. 4.4 (a)).

The height and width of a gap that is passable are directly proportional to the size of the robot. As the robot gets smaller, a gap also become smaller. Therefore, a small robot can go where humans and large robots cannot and scout the area. As shown in Fig. 4.4. (b), the robot can pass the narrow gap that is 30mm in height.

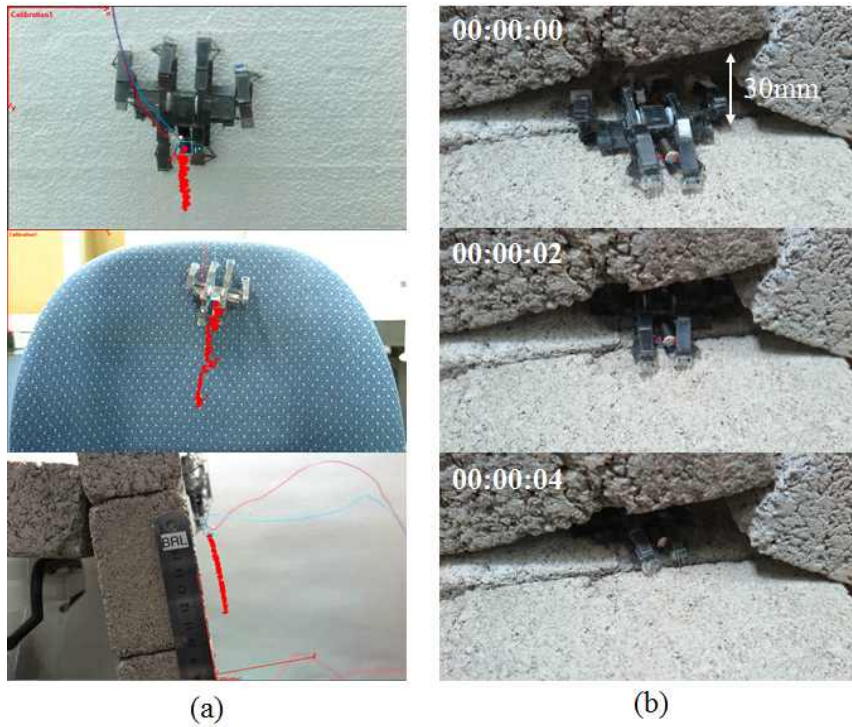

Figure 4.4 (a) 2D tracking results of climbing on the three different surfaces. (b) The robot can pass the narrow gap (Height: 30mm).

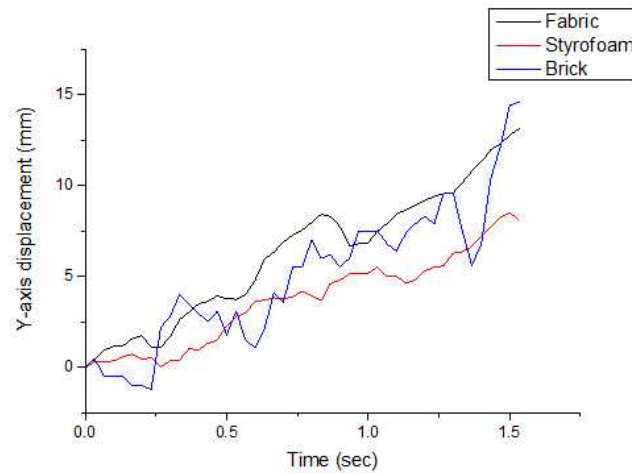

Figure 4.5 Y-displacement graph during climbing on the three surfaces.

Chapter 5. Conclusion

In order to solve the scale issue of a climbing robot, three key principles are extracted from cockroach climbing and integrated with planar fabrication. Planar mechanisms based on three principles are redesigned for climbing locomotion. First, the transmission is designed for alternating tripod gait. And the compliant foot is miniaturized and hind leg is proposed to reduce the impact during attachment. Third, quick-return leg is designed to make the phase overlap during alternation of tripods. These mechanisms are fabricated using laminating film and fabric for fast prototyping as well as for high structural strength.

As a result of different approach, fabricated robot is 8.5cm long and 7.7g in weight. This robot can climb on three different kinds of surfaces at around 0.1body-lengths/sec. Proposed robot is much smaller and lighter than previous climbing robots on rough surface as shown in Table II. Furthermore, climbing performance is similar to that of large climbing robots. Therefore, this research suggest the possibility that a new approach based on biomimetics and planar design can solve the scale issue of small mobile robots thanks to a novel and simple mechanism.

Future work will be dynamical climbing and rapid attachment mechanism. Climbing velocity can be increased based on dynamical climbing and high efficient actuators. Current spine mechanism have a delay in engaging on asperity as shown in Fig. 3.12. Rapid and stable spine mechanism is required for climbing on more than 90 degree slope. In addition, overall mobility will be improved when a

control-based approach is implemented. Robustness of the robot will be increased to be used in practical mission.

Table II Comparison of the multi-legged climbing robots using spines

	Size (cm)	Mass (g)	Actuators	Tested Media	Flight Phase
Spinybot-II [7]	58 × 27	4	7	Brick, stucco	×
RiSE v3 [8]	70 × 51.5	5,400	9	Wooden pole	×
Microspine Rock-climbing robot [9]	89 × 51.4 (Sprawl angle : 30°)	10,000	13	Rock	×
Proposed robot	7 × 8.5	7.7	1	Brick, fabric	×

Bibliography

- [1] Balaguer, C., Gimenez, A., Pastor, J., Padron, V., and Abderrahim, C., "A climbing autonomous robot for inspection applications in 3d complex environments," *Robotica*, 2000, 18(3), pp.287 - 297.
- [2] Xu, Z. and Ma, P., "A wall-climbing robot for labeling scale of oil tank's volume," *Robotica*, 2002, 20(2), pp.203 - 207.
- [3] La Rosa, G., Messina, M., Muscato, G., and Sinatra, R., "A lowcost lightweight climbing robot for the inspection of vertical surfaces," *Mechatronics*, 2002, 12(1), pp.71 - 96.
- [4] Lal Tummala, R., Mukherjee, R., Xi, N., Aslam, D., Dulimarta, H., Xiao, J., Minor, M., and Dang, G., "Development of a tracked climbing robot," *Journal of Intelligent and Robotic Systems*, 2002, 9(4).
- [5] Zhu, J., Sun, D., and Tso, S., "Development of a tracked climbing robot," *Journal of Intelligent and Robotic Systems*, 2002, 35(4), pp.427 - 444.
- [6] Kim, S., Spenko, M., Trujillo, S., Heyneman, B., Santos, D., & Cutkosky, M. R., "Smooth vertical surface climbing with directional adhesion," *Robotics, IEEE Transactions on*, 2008, 24(1), pp.65-74.

- [7] Kim, S., Asbeck, A. T., Cutkosky, M. R., & Provancher, W. R., "SpinybotII: climbing hard walls with compliant microspines," in *Advanced Robotics, 2005. ICAR'05. Proceedings., 12th International Conference, 2005*, pp.601-606.
- [8] Spenko, M. J., Haynes, G. C., Sanders, J. A., Cutkosky, M. R., Rizzi, A. A., Full, R. J., & Koditschek, D. E., "Biologically inspired climbing with a hexapedal robot," *Departmental Papers (ESE)*, 2008, 397.
- [9] Parness, A., Frost, M., Thatte, N., King, J. P., Witkoe, K., Nevarez, M., Garrett, M., Aghazarian, H. & Kennedy, B., "Gravity-independent Rock-climbing Robot and a Sample Acquisition Tool with Microspine Grippers," *Journal of Field Robotics*, 2013, 30(6), pp.897-915.
- [10] Birkmeyer, P., Gillies, A. G., & Fearing, R. S., "CLASH: Climbing vertical loose cloth," in *Proceedings of the IEEE International Conference on Intelligent Robots and Systems (IROS)*, 2011.
- [11] Goldman, D. I., Chen, T. S., Dudek, D. M., & Full, R. J., "Dynamics of rapid vertical climbing in cockroaches reveals a template," *Journal of Experimental Biology*, 2006, 209(15), pp.2990-3000.
- [12] Gray, J. "Studies in the Mechanics of the Tetrapod Skeleton,"

Journal of Experimental Biology, 1944, 20.2, pp.88–116.

- [13] Ting, L. H., Reinhard Blickhan, and Robert J. Full. "Dynamic and static stability in hexapedal runners," *The Journal of experimental biology*, 1944, 197.1, pp.251–269.
- [14] Kubow, T. M., & Full, R. J., "The role of the mechanical system in control: a hypothesis of self-stabilization in hexapedal runners," *Philosophical Transactions of the Royal Society B: Biological Sciences*, 1999, 354(1385), pp.849–861.
- [15] Clemente, Christofer J., and Walter Federle. "Pushing versus pulling: division of labour between tarsal attachment pads in cockroaches," *Proceedings of the Royal Society of London B: Biological Sciences*, 2008, 275.1640, pp.1329–1336.
- [16] Frantsevich, Leonid, and Stanislav Gorb. "Structure and mechanics of the tarsal chain in the hornet, *Vespa crabro* (Hymenoptera: Vespidae): implications on the attachment mechanism," *Arthropod structure & development*, 2004, 33.1, pp.77–89.
- [17] Alexander, R. McN. "Three uses for springs in legged locomotion," *The International Journal of Robotics Research*, 1990, 9.2, pp.53–61.
- [18] Kennedy, Brett, et al. "Lemur IIb: a robotic system for steep terrain access," *Industrial Robot: An International Journal*, 2006,

33.4, pp.265–269.

- [19] Miller, B. D., Rivera, P. R., Dickson, J. D., & Clark, J. E., "Running up a wall: the role and challenges of dynamic climbing in enhancing multi-modal legged systems," *Bioinspiration & biomimetics*, 2015, 10(2), 025005.
- [20] Asbeck, A. T., & Cutkosky, M. R., "Designing compliant spine mechanisms for climbing," *Journal of Mechanisms and Robotics*, 2012, 4(3), 031007.
- [21] Provancher, W. R., Clark, J. E., Geisler, B., & Cutkosky, M. R., "Towards penetration-based clawed climbing," in *Climbing and walking robots*, Springer Berlin Heidelberg, 2005, pp.961–970.
- [22] L.L. Howell, *Compliant Mechanisms*. New York, NY, USA: Wiley-Interscience, 2001.
- [23] Rabbat, B. G., and H. G. Russell. "Friction coefficient of steel on concrete or grout," *Journal of Structural Engineering*, 1985, 111.3, pp.505–515.
- [24] Wood, R. J., Avadhanula, S., Sahai, R., Steltz, E., & Fearing, R. S., "Microrobot design using fiber reinforced composites," *Journal of Mechanical Design*, 2008, 130(5), 052304.
- [25] Hoover, A. M., & Fearing, R. S., "Fast scale prototyping for folded millirobots," in *IEEE International Conference on*

Robotics and Automation (ICRA), 2008, pp.886–892.

- [26] Hong-Cheol Choi, Gwang-pil Jung, and Kyu-Jin Cho, “Design of a Milli-Scale, Biomimetic Platform for Climbing on a Rough Surface,” *Proceedings of the 2015 IEEE International Conference on Robotics and Biomimetics (ROBIO)*, 2015.

국문 초록

바퀴벌레 모사 소형 등반 플랫폼의 설계 및 제작

구조대가 접근할 수 없는 붕괴된 지역이나 적에게 발각되지 않고 정찰을 수행해야 하는 군사지역에서 소형 로봇에 대한 필요성이 대두되었다. 소형 로봇의 이슈 중 하나는 자신보다 큰 장애물 사이에 갇힐 수 있다는 것이다. 따라서 장애물 극복 능력이 중요한데, 그 중에 등반 거동은 자신보다 수십 배 큰 장애물을 극복할 수 있다. 현재 등반 로봇에 대해 많은 연구들이 진행되었지만, 대부분이 크고 무겁다는 한계를 갖는다. 본 연구에서는 바퀴벌레의 등반 거동에서 3가지 핵심 원리를 도출하여 평면기반의 기계요소로 구현하여 통합된 소형 등반 로봇을 제시한다.

바퀴벌레는 거친 표면의 수직 벽을 매우 빠른 속도로 등반할 수 있다. 이를 모사하여 등반하기 위한 첫 번째 원리는 3개의 다리의 교차 보행(Alternating tripod gait)이다. 최소 3개의 다리가 표면과 접촉을 유지하기 때문에 별도의 제어 없이도 안정적인 거동이 가능하다. 이를 하나의 모터로 구동하기 위해 평면 기반의 구동부를 설계하였다. 두 번째 원리는 표면과 접촉 시에 발생하는 충격을 줄이는 것이다. 바퀴벌레는 유연한 다리를 이용하여 표면에 유연하게 접촉할 수 있다. 이는 표면과 접촉 시에 발생하는 수직반력의 크기를 감소시킬 수 있다. 따라서 유연한 다리 구조를 모델링하여 설계를 하였다. 또한 뒷다리의 작용 방향을 앞다리와 반대로 설계하여 별도의 꼬리가 없이도 앞다리에서 발생하는 모멘트를 감소시킬 수 있도록 설계하였다. 마지막 원리는 다리가 교차될 때 다리가 동시에 표면에 접촉하는 구간(Phase overlap)이다. 바퀴벌레가 5 body-length/sec의 빠른 속도로 등반할 때에도 오버랩 구간이 존재하여 다리가 안정적으로 교차될 수 있도록 해준다. 평면기반의 급속귀환 다리(Quick-return leg)를 설계하여 교차 보행(Alternating tripod gait) 중에

오버랩 구간이 생기도록 하였다.

본 연구에서는 소형 로봇이 등반 거동을 가질 수 있도록 핵심 원리를 추출하고 이를 평면기반의 설계 및 제작을 통해 소형 플랫폼에 통합하였다. 복합재 기반의 제조공정(Smart composite microstructure)을 수정하여 코팅필름(Laminating film)과 천(Fabric)을 활용하여 제작하였다. 제작된 로봇의 크기는 $7\text{cm} \times 8.5\text{cm} \times 2\text{cm}$ 이고 무게는 6g이다. 천, 스티로폼 그리고 벽돌 표면을 약 $0.1\text{body-length/sec}$ 의 속도로 등반하였다. 이와 같은 결과는 생체모사와 평면기반 설계를 통합한 접근법이 복잡한 거동을 구현하면서도 로봇의 크기를 줄일 수 있는 해결방법이 될 수 있다는 가능성을 보여준다.

주요어: 등반 로봇, 생체모사, 생체모방기술, 유연한 메커니즘, 평면기반 제조, 복합재기반 제조공정(SCM)

학번: 2014-20661