

## **Copyright Statement**

This copy of the thesis has been supplied on condition that anyone who consults it is understood to recognise that its copyright rests with its author and that no quotation from the thesis and no information derived from it may be published without the author's prior consent.

# Effect of Short Term Stretching on Ankle Stiffness and Range of Motion in People with Multiple Sclerosis

**Jodielin Ofori**

---

A thesis submitted to the University of Plymouth in partial  
fulfilment for the degree of

**DOCTOR OF PHILOSOPHY**

School of Health Professions  
Faculty of Health, Education and Society

**November 2012**

## **Abstract**

**Name: Jodielin Antoinette Ofori**

**Title: Effect of Short Term Stretching on Ankle Stiffness and Range of Motion in People with Multiple Sclerosis**

Hypertonia is seen in 85% of people with Multiple Sclerosis (pwMS) resulting in disability and functional restrictions. Hypertonia can be caused by increases in passive stiffness and enhanced stretch reflexes (spasticity) and is frequently managed clinically using passive stretches. However, the optimal parameters of stretching such as the applied torque and stretch duration remain unclear. During commonly prescribed ankle plantarflexor stretches pwMS produced higher torques when standing in a weight bearing position compared to stretches applied using the upper limbs. Stretches could be held for 120 seconds on average and stretch duration was mainly limited by fatigue. People with higher disability tended to favour more supported stretching positions. The effects of stretching for either 30 or 10 minutes using a customised motor at three torque levels covering the range that MS participants could produce was investigated. Compared to the 10 minute stretch, greater reductions in passive stiffness and greater increases in range of movement (ROM) were seen immediately following the 30 minute stretch with the effects being sustained for the 30 minute post stretch period. Higher levels of applied torque resulted in a greater change in ROM however; there was no effect of applied torque on passive stiffness. Stretch reflex mediated stiffness was unaffected by the stretching intervention and showed transient post stretch increases. Ultrasonography was used to investigate changes in muscle–tendon length and strain in pwMS and controls and following stretching. PwMS showed evidence of stiffer muscles and increased tendon length at baseline compared to controls. Following a 10 minute stretch overall muscle length did not increase in pwMS, although increases in strain in the musculotendinous junction region were observed suggesting that more proximal regions of the muscle was likely to have contributed significantly to overall stiffness. This work highlights that stretch duration and levels of applied torque are critical factors in determining the effectiveness of stretches. The pathological mechanisms underlying hypertonia at a molecular and structural level and the effects of stretching on components of the musculo-tendinous structure and on functional ability should be ascertained.

## **Contents**

Copyright Statement.....	1
Abstract.....	3
List of Figures .....	10
List of Tables.....	15
List of Abbreviations.....	17
Acknowledgements.....	19
Declaration .....	21
Presentation and Conferences Attended.....	22
1. Chapter One: Thesis Introduction and Overview .....	23
1.1 Thesis Justification, Aims and Structure.....	23
1.2 Inter-relationship between studies.....	24
2 Chapter Two: Background .....	27
2.1 Introduction.....	27
2.2 Multiple Sclerosis .....	27
2.2.1 Pathology.....	27
2.2.2 Types of MS .....	28
2.2.3 Signs and Symptoms.....	29
2.2.4 Passive Stiffness .....	29
2.2.5 Extracellular Matrix of Muscle and Tendon.....	30
2.2.6 Intramuscular Proteins.....	32
2.3 Spasticity .....	36
2.3.1 Role of Descending Pathways .....	36
2.3.2 Role of Spinal Cord Inhibition.....	37
<i>Summary</i> .....	40
2.4 Measurement of Hypertonia .....	40
2.4.1 Clinical Measures .....	41
2.4.2 Mechanical .....	44
2.4.3 Physiological .....	45
2.5 Overview of Treatment Regimes for Hypertonia .....	46
2.5.1 Pharmacological.....	46
2.5.2 Physical.....	50
3 Chapter Three: Stretching for the Treatment and Management of Lower Limb Hypertonia in Patients with Neurological Disorders: Review of the Literature.....	55

3.1	Introduction.....	55
3.1.1	Stretching as a Treatment for Hypertonia.....	55
3.2	Methods .....	58
3.2.1	Search Strategy/Data Sources.....	58
3.2.2	Study Selection (Inclusion/Exclusion Criteria) .....	58
3.2.3	Study Evaluation: Experimental Design and Methodological Quality .....	59
3.2.4	Study Evaluation: Assessment of Different Stretching Effects.....	69
3.2.5	Study Evaluation: Calculation of Effect Sizes and Meta-Analysis .....	69
3.3	Results .....	71
3.3.1	Study Selection Process .....	71
3.3.2	Study Samples.....	73
3.3.3	Main Purpose of Studies .....	73
3.3.4	Outcome Measures and Measurement Tools.....	73
3.3.5	Quality of the Evidence.....	74
3.3.6	Types of Intervention Used.....	74
3.3.7	Stretch Dosage .....	75
3.4	Meta-Analysis .....	75
3.4.1	Effects of Stretch on Passive Stiffness .....	75
3.4.2	Effects of Stretch on Spasticity: Biomechanical and Electrophysiological Measures.....	79
3.4.3	Effects of Stretch on Spasticity: Clinical Measures .....	83
3.4.4	Effects of Stretch on Range of Movement.....	84
3.4.5	Effects of Stretch on Functional Mobility.....	87
3.4.6	Comparing Different Stretching Interventions.....	88
3.5	Discussion .....	91
4.	Chapter Four: Methods .....	98
4.1	Sample Size Calculations .....	98
4.2	Study Sample.....	99
4.3	Recruitment Strategy .....	99
4.4	Eligibility Criteria .....	100
4.4.1	Inclusion Criteria:.....	100
4.4.2	Exclusion Criteria: .....	101
4.5	Measures of Participant Characteristics .....	101
4.5.1	Descriptors of Functional Status .....	101
4.5.2	Clinical and Subjective Measures of Stiffness .....	102

4.6	Outcome Method .....	102
4.6.1	Stiffness .....	102
4.6.2	Motor Safety Features .....	103
4.6.3	Strength and Muscle Activity .....	104
4.6.4	Safety and Strength of the Stretch .....	104
4.7	Analyses .....	105
4.7.1	Analysis of Motor Driven Stretches .....	105
4.7.2	Definitions of Stiffness Used in the Thesis .....	107
4.7.3	Analysis of Isometric MVC .....	108
5.	Chapter Five: Factors Influencing the Applied Torque During Manually Applied Plantarflexor Stretches in People with Multiple Sclerosis .....	109
5.1	Introduction.....	109
5.2	Materials and Methods .....	109
5.2.1	Participants and Recruitment .....	109
5.2.2	Demographics and Self-Report Measures of Spasticity and Function ..	109
5.2.3	Measurement of Stiffness, Strength and Muscle Activity .....	110
5.2.4	Manually Applied Stretches .....	110
5.2.5	Measurement of Gastrocnemius Length ,Torque and Muscle activity ...	112
5.2.6	Analyses .....	115
5.3	Results .....	115
5.3.1	Stiffness and Muscle Strength.....	119
5.3.2	Mean Ankle Torque.....	120
5.3.3	Gastrocnemius Length .....	120
5.3.4	Muscle Activation.....	121
5.3.5	Relationship Between Ankle Torque, Ankle Stiffness and Functional Ability.....	122
5.3.6	Self Report Measures of Strength and Safety of Stretches.....	123
5.4	Discussion .....	125
5.4.1	Muscle Stiffness in MS .....	125
5.4.2	Effect of Stretching on Ankle Plantarflexion Torque and Gastrocnemius Length.....	125
6.	Chapter Six: The Effect of Stretching at Different Torques on Plantarflexor Stiffness and Range of Motion in People with Multiple Sclerosis .....	128
6.1	Introduction.....	128
6.2	Materials and Methods .....	129
6.2.1	Participant Recruitment .....	129

6.2.2	Demographics and Baseline Characteristics .....	129
6.2.3	The Stretching Intervention.....	129
6.2.4	Measurement of Stiffness, Strength and Range of Motion .....	131
6.2.5	Subjective Report of Stretch .....	132
6.2.6	Analyses .....	132
6.3	Results .....	133
6.3.1	Demographics and Baseline Characteristics .....	133
6.3.2	Comparison of Baseline Characteristics with Control Participants.....	136
6.3.3	Subjective Report of Stretch in pwMS (n=14).....	138
6.3.4	Change in Stiffness with Applied Torque in pwMS .....	139
6.3.5	Changes in Strength with Applied Torque in pwMS (n=14).....	144
6.3.6	Changes in Range of Movement with Applied Torque in pwMS (n=13) .....	145
	.....	147
6.3.7	Relationship between Applied Torque and Stiffness in pwMS.....	148
6.3.8	Relationship between Baseline Stiffness and Change in Stiffness in pwMS.....	149
6.4	Discussion .....	151
6.4.1	Change in Stiffness with Applied Torque.....	151
6.4.3	Change in Strength with Stretching .....	154
6.4.4	Dorsiflexion Range.....	154
7.	Chapter Seven: The Effect Duration of Stretch and Applied Torque on Plantarflexor Stiffness in People with Multiple Sclerosis.....	157
7.1	Introduction.....	157
7.2	Materials and Methods .....	157
7.2.1	Participant Recruitment .....	157
7.2.2	Demographics and Baseline Characteristics .....	158
7.2.3	Intervention.....	158
7.2.4	Measurement of Stiffness and Strength .....	158
7.2.5	Subjective Report of Stretch .....	159
7.2.6	Measurement of ROM .....	159
7.2.7	Analyses .....	159
7.3	Results .....	160
7.3.1	Patient Demographics and Baseline Characteristics.....	160
7.3.2	Comparison of Baseline Characteristics with Control Participants.....	162
7.3.3	Subjective Report of Stretch in pwMS.....	164
7.3.4	Change in Stiffness with Applied Torque in pwMS (n=13) .....	165

7.3.5	Change in Strength with Applied Torque in pwMS (n=13).....	169
7.3.6	Effect of Applied Torque on End Range Ankle Position in pwMS (n=12).....	172
7.3.7	Range of Movement During the Stretch in pwMS(n=12) .....	172
7.3.8	Comparison of 30 Verses 10 Minutes Duration Stretches on Stiffness and Range of Motion .....	175
7.3.9	Comparison to Previous Work in the Literature.....	181
7.4	Discussion .....	185
8.	Chapter Eight: Changes in Measures of Muscle Stiffness Using Ultrasound in People with Multiple Sclerosis and Following Stretching .....	189
8.1	Introduction.....	189
8.2	Materials and Methods .....	191
8.2.1	Participants and Recruitment .....	191
8.2.2	Experimental Setup.....	192
8.2.3	Application of Ankle Perturbations to Monitor Limb Stiffness.....	192
8.2.4	Ultrasound Setup.....	193
8.2.5	3D Motion Analysis .....	193
8.2.6	Synchronisation .....	195
8.2.7	Signal Processing.....	196
8.3	Calculation of Muscle Fibre Length Changes and Strain with Stretching..	198
8.4	Analyses .....	200
8.5	Results .....	201
8.5.1	Muscle and Tendon Length: MS and Control Comparison.....	201
8.5.2	Relationship Between Passive Stiffness and Muscle / Tendon Length .	204
8.5.3	Displacement of the ROI: MS and Control Comparison.....	205
8.5.4	Absolute Displacement of ROI Following a Stretching Intervention in pwMS.....	206
8.5.5	Strain: MS and Control Comparison.....	207
8.5.6	Strain Following a Stretching Intervention in pwMS .....	208
8.5.7	Relationship between Passive Stiffness and Gastrocnemius Muscle-Tendon Strain .....	209
8.6	Discussion .....	211
8.6.1	Differences in Total Gastrocnemius Muscle-Tendon Complex Length between pwMS and Controls.....	211
8.6.2	Gastrocnemius Muscle Stiffness and Achilles Tendon Compliance in MS.....	212
8.6.3	Potential Site of Increased Passive Stiffness in pwMS .....	212



8.6.4	Effects of Stretching on Passive Stiffness.....	212
8.6.5	Changes in Gastrocnemius Muscle-Tendon Length with Stretching .....	214
8.6.6	Measurement of Gastrocnemius Muscle-Tendon Displacement and Strain.....	214
8.6.7	Gastrocnemius Muscle-Tendon Displacement and Strain: Comparison Between MS and Controls .....	215
8.6.8	Gastrocnemius Muscle-Tendon Displacement and Strain: Effects of Stretching.....	216
8.6.9	Measurement of Passive Stiffness .....	217
9.	Chapter Nine: Summary and Future Directions.....	219
9.1	Introduction:.....	219
9.2	Aim.....	220
<b>9.3</b>	<b>Stretching science and practice .....</b>	<b>221</b>
9.4	Summary of Literature Review Findings.....	230
9.5	Summary of Experimental Findings .....	230
9.6	Study Limitations .....	233
9.7	Future Work.....	239
10.	Bibliography.....	241
11.	Appendix 1.....	256

## **List of Figures**

### **Chapter One: Introduction of Thesis: Justification, Aims and Structure**

1A Flow chart showing overlap of MS subjects across studies 26

### **Chapter Three: Stretching for the treatment and management of lower limb hypertonia in patients with neurological disorders: review of the literature**

3.1 Flow chart of literature selection 72

3.2 Forest plot showing 95% confidence intervals (CI) for the effect of: intelligent stretching; cyclic stretching; tilt table standing and supine ankle dorsiflexion stretch 76

3.3 Forest plot showing 95% CI for the effect of: variable stretching methods on passive stiffness 78

3.4 Forest plot showing change in passive stiffness in Nm/° and the 95% CI for the effect of: intelligent stretching and cyclic stretching interventions 79

3.5 Forest plot showing 95% CI for the effect of: variable stretching interventions on spasticity 80

3.6 Forest plot showing 95% CI for the effect of: variable stretching interventions on spasticity in studies with no control group 82

3.7 Forest plot showing 95% CI for the effects of: constant angle, constant torque stretching and intelligent control stretching on spasticity 83

3.8 Forest plot showing 95% CI for the effect of: variable stretching and standing interventions on spasticity in studies with no control group 84

3.9 Forest plot showing 95% CI for the effects of: ROM exercises and stretching interventions on ROM in studies with a control group 85

3.10 Forest plot showing 95% CI for the effects of: stretching and standing interventions on ROM in studies with no control group 86

3.11 Forest plot showing 95% CI and mean difference in ROM with: ROM exercises and stretching interventions in studies with a control group 87

3.12a Comparing the treatment effect of: constant torque, constant angle and cyclic stretches on ROM 88

3.12b Comparing the treatment effect of: constant angle and cyclic stretches on passive stiffness 89

3.12c Comparing the treatment effect of: constant torque, constant angle and 90

cyclic stretches on spasticity

#### **Chapter Four: Methods**

4.1 Foot position for stiffness assessment: A) starting position 10 ° plantarflexion; B) 5 ° dorsiflexion	103
4.2 Raw data from the fast (A) and slow (B) stretch. The average of 5 stretches for a participant with MS and a control is shown	106
4.3 Position of foot in manipulandum $\theta$ = angle relative to vertical	107

#### **Chapter Five: Factors Influencing the Applied Torque During Manually Applied Plantarflexor Stretches in People with Multiple Sclerosis**

5.1 Stretch conditions: A) Wall stretch, B) Step stretch, C) Pull stretch (showing the ankle move into dorsiflexion from top to bottom), D) Frame stretch	111
5.2 Tibial (TB) and Hindfoot (HF) diagram with marker placement	112
5.3 A) Codamotion analysis sagittal plane stick figure showing the marker placement, B) Free body diagram of the forces acting on the foot when the body is stationary	114
5.4 A) Maximum voluntary contraction recorded in Nm/kg , B) Average plantarflexor stiffness	120
5.5 A) Mean ankle torque normalised to body weight (Nm/kg), B) Gastrocnemius length normalised to body weight (Nm/kg)	121
5.6 A) Mean normalised tibialis anterior activation B) Mean normalised gastrocnemius activation	122
5.7 Self-reported strength and safety of stretch in MS group	124

#### **Chapter Six: The Effect of Stretching at Different Torques on Plantarflexor Stiffness and Range of Motion in People with Multiple Sclerosis**

6.1 Experimental setup: participant in semi-reclined position with the test foot attached to a footplate at 0°	131
6.2 A) Maximum voluntary contraction recorded in Nm/kg, B) Average plantarflexor stiffness in Nm/rad./kg	137
6.3 Initial baseline ankle ROM for MS and control group from a position of 10° plantarflexion (start position) to 15s after application of the low constant torque (end position)	138
6.4 Self-report strength of stretch on a visual analogue scale ranging from 0-10	139
6.5 Change in total stiffness	140

6.6 Change in passive stiffness	142
6.7 The difference in associated stiffness	143
6.8 Change in isometric dorsiflexor strength	144
6.9 Change in isometric plantarflexor strength	145
6.10 End foot position (29 minutes post stretch) with the application of a high, medium or low torque	146
6.11 Position achieved from 30 seconds to 29 minutes of stretch at a constant torque with the application of a high, medium or low torque	147
6.12 Grand average of position data with the application of a constant torque over 25 minutes	148
6.13 Correlation between baseline passive stiffness and stretch reflex associated stiffness and the change in these measures post stretch, across all applied torques	150
<b>Chapter Seven: The Effect of Stretch Durations and Applied Torque on Plantarflexor Stiffness in People with Multiple Sclerosis</b>	
7.1: A) Maximum voluntary contraction recorded in Nm/kg, B) Average plantarflexor stiffness in Nm/kg	163
7.2: Initial baseline ankle ROM for MS and control group from a position of 10° plantarflexion (start position) to 15s after application of the low constant torque	164
7.3: Self-report strength of stretch on a visual analogue scale ranging from 0-10	165
7.4: Change in total stiffness between selected time periods, compared against applied torque	166
7.5: Change in passive stiffness between selected time periods, compared against applied torque	167
7.6: The difference in stretch reflex associated stiffness between selected time periods, compared against applied torque	169
7.7: Change in isometric dorsiflexor strength between selected time periods, compared against applied torque	170
7.8: Change in isometric plantarflexor strength between selected time periods, compared against applied torque	171
7.9: End ankle position (9 minutes post stretch) with the application of a high, medium or low torque	172
7.10: Ankle position achieved from 0 seconds to 9.75 minutes of stretch at a	174

constant torque with the application of a high, medium or low torque	
7.11: Grand average of position data with the application of a constant torque stretch over 9.75 minutes	174
7.12: Percentage change in total stiffness with the application of a stretch over a 10 and 30 minute duration	176
7.13: Percentage change in passive stiffness with the application of a stretch over a 10 and 30 minute duration	177
7.14: Percentage change in stretch reflex associated stiffness with the application of a stretch over a 10 and 30 minute duration	178
7.15: Percentage change in ROM with the application of a low, medium and high force over a 10 and 30 minute duration	179
7.16: Absolute end point ROM achieved with the application of a low, medium and high force over a 10 and 30 minute duration	180
<b>Chapter Eight: Changes in measures of muscle stiffness using ultrasound in people with multiple sclerosis and following stretching</b>	
8.1: A) Ultrasound transducer location at musculotendinous junction (MTJ); B) Diagrammatical representation of total length, proximal and distal length measures of gastrocnemius	194
8.2: A) Location of calcaneus heel device; B) position of markers, EMG and position of ultrasound probe relative to the MTJ; C) Ultrasound probe and coda markers	195
8.3: A) Diagrammatical image of marker calculations of gastrocnemius muscle length; B) DF at end of perturbation	197
8.4: Image of selected region of interest (ROI) displayed using ultrasound imaging	199
8.5: Image of calculation of velocity, hypotenuse, horizontal and vertical displacement of ROI	200
8.6: Total, proximal gastrocnemius and distal tendon length measured with the foot in 10° plantarflexion.	202
8.7: Total, proximal gastrocnemius and distal tendon length measured with the foot in 5° dorsiflexion	203
8.8: Relationship between passive stiffness and absolute tendon length in pwMS	205
8.9: Absolute length displacement of ROI before and after intervention for the	206

second and sixth perturbation	
8.10: Absolute length displacement of ROI before and after intervention for the second and sixth perturbation for the MS group	207
8.11: Percentage strain of ROI before and after intervention for the second and sixth perturbation, between the MS and control group	208
8.12: Percentage strain of ROI before and after intervention for the second and sixth perturbation, for the MS group	209
8.13 Passive stiffness measured post intervention compared with strain measures post intervention	210
<b>Appendix</b>	
A.1: Total stiffness compared with section 3 of the Multiple Sclerosis Spasticity Scale (MSSS88) of the effect of muscle spasm on walking in MS	258

## **List of Tables**

### **Chapter Three: Stretching for the treatment and management of lower limb hypertonia in patients with neurological disorders: review of the literature**

3.1 Details of studies included in literature review	60
3.2 Methodological Quality Assessment	68
3.3 Correction factor applied to studies of different sample size to achieve an estimate of the standard deviation	70
3.4 Experimental data results for control studies investigating the effects of stretching on passive stiffness	77
3.5 Experimental data results for control studies investigating the effects of stretching on spasticity	81

### **Chapter Five: Factors influencing the applied torque during manually applied plantarflexor stretches in people with multiple sclerosis**

5.1 Participant demographics	117
5.2 Clinical descriptors of people with MS: Barthel Index (BI); transformed Multiple Sclerosis Walking Scale (MSWS12); MSSS88; plantarflexor Ashworth scores	119
5.3 Relationship between mean ankle moment and function and ankle stiffness	123

### **Chapter Six: The Effect of Stretching at Different Torques on Plantarflexor Stiffness and Range of Motion in People with Multiple Sclerosis**

6.1 Participant demographics and baseline characteristics	134
6.2 Clinical descriptors of people with MS: BI; transformed MSWS12; MSSS88; plantarflexor Ashworth scores	136
6.3 Average total stiffness during and after stretches with different torques	140
6.4 Average passive stiffness during and after different stretches	141
6.5 Average stretch reflex associated stiffness during and after different stretches	143
6.6 Relationship between applied torque and change in total stiffness	149
6.7 Relationship between baseline passive stiffness and change in passive stiffness; baseline stretch reflex related stiffness and change in stretch reflex associated across all forces	150

## **Chapter Seven: The Effect of Stretch Durations and Applied Torque on Plantarflexor Stiffness in People with Multiple Sclerosis**

7.1 Participant demographics for experiment three	161
7.2 Clinical descriptors of people with MS in experiment three	162
7.3 Average total stiffness taken from baseline, immediate post stretch to 30 minutes post stretch	166
7.4 Average passive stiffness taken from baseline, immediate post stretch to 30 minutes post stretch	167
7.5 Average stretch reflex associated stiffness taken from baseline, immediate post stretch to 30 minutes post stretch	168
7.6 Average isometric dorsiflexor strength taken from baseline, immediate post stretch to 30 minutes post stretch	170
7.7 Average plantarflexor strength taken from baseline, immediate post stretch to 30 minutes post stretch	171
7.8 Average ROM during stretch at 0.5, 3.25, 6.5 and 9.75 minutes post stretch	173
7.9 Mean difference and confidence intervals for passive stiffness	182
7.10 Effect size and confidence intervals for passive stiffness	182
7.11 Mean difference and confidence intervals for stretch reflex associated stiffness	183
7.12 Effect size and confidence intervals for stretch reflex associated stiffness	183
7.13 Mean difference and confidence intervals for range of motion	184
7.14 Effect size and confidence intervals for range of motion	184
7.15 Diagrammatical representation of the effect of stretch duration and applied force on ROM, passive stiffness and stretch reflex associated stiffness	185

## **Chapter Eight: Changes in direct measures of muscle stiffness in people with multiple sclerosis and following stretching**

8.1 Relationship between passive stiffness and tendon and muscle length measured with the ankle in dorsiflexion	204
8.2 Relationship between strain and passive stiffness	210
<b>Appendix A.1</b> Relationship between sections 1-8 of the MSSS88 and biomechanical measures of stiffness	257



## **List of Abbreviations**

AMED	Allied and Complementary Medicine Database
ANOVA	Analysis of Variance
BMP	Bit Map
CNS	Central Nervous System
CONT	Control
CP	Cerebral Palsy
CINAHL	Cumulative Index to Nursing and Allied Health Literature
DARE	Database of Abstracts of Reviews of Effects
DIC	Digital Image Correlation
EMG	Electromyography
EDSS	Expanded Disability Status Scale
ECM	Extra Cellular Matrix
FES	Functional Electrical Stimulation
GABA <sub>a</sub>	Gamma-aminobutyric Acid (a)
GABA <sub>b</sub>	Gamma-aminobutyric Acid (b)
GTO	Golgi Tendon Organ
HTA	Health Technology Assessment Database
HSP	Hereditary Spastic Paraparesis
IG	Immunoglobulin
INT	Intervention
MMPS	Matrix Metalloproteinase
MS	Multiple Sclerosis
MTJ	Musculotendinous Junction
NHS	National Health Service
PWMS	People with Multiple Sclerosis
PEDRO	Physiotherapy Evidence Database
PNF	Proprioceptive Neuromuscular Facilitation
ROI	Region of Interest

SWIMS	South West Impact of Multiple Sclerosis
SCI	Spinal Cord Injury
UK	United Kingdom

## **Acknowledgements**

The process of completing this PhD would have been impossible without the continual support, guidance and encouragement of my academic supervisors, friends and family.

I would like to thank Professor Jonathan Marsden most sincerely for acknowledging my potential and believing in me. He spent countless hours teaching me and developing a novice physiotherapist into a creditable researcher. His faith in me has given me the opportunity to accomplish something significant and gratifying, which would simply not have been possible without him. I am also deeply grateful to Dr Jennifer Freeman for her genuine interest in my wellbeing and for being such a valuable mentor and support. She taught me how to keep my mind focused and to think outside the box.

Additionally, I would like to express my gratitude to the following: the Multiple Sclerosis Society for funding this research project in its entirety; Dr Alan Hough for his continual help and support on this project, the engineering department at Plymouth University, all of whom worked tirelessly to build the Baldor motor system used in the data collection process; and to all those involved in the SWIMS project, especially Dr Wendy Ingram who was instrumental in the recruitment of participants for all three research experiments.

I am indebted to the MS participants, their friends and family members who took part in the research experiments; I thank them for their keen interest in the project and for seeing it through to the end. To all my colleagues, who took time out of their busy work schedules in order to be healthy control participants, I also offer my thanks.

On a personal level I would like to thank my husband, Alexander Ofori, for his unconditional love, continual encouragement and support. He has been with me from the very beginning of this journey, helping me through the difficult times and seeing me through to the end. To my dearest Mum and Dad, thank you for your prayers, reassuring words of comfort and for inspiring me to be the best I can possibly be. I have also been privileged to have many friends who have kept me grounded and

offered distraction when I felt in too deep; they include Siobhan, Rob, Dan, Amber, Lisa, Daniela, Julie and others too many to name. In the same manner, to the Highway of Holiness Church and particularly Pastor Alexander Gyasi and Dorcas Gyasi, thank you for your prayers and words of encouragement.

Finally, my thanks are to God, for through him all things are possible.

(Mathew 7:7)

## **Declaration**

I, Jodielin Antoinette Ofori declare that at no point during the course of registration for the degree of Doctor of Philosophy have I registered for any other university award without prior agreement of the graduate committee. I, confirm that the body of work presented in this thesis is my own and where information has been obtained from other sources, this has been appropriately stipulated. I have undertaken training delivered by the postgraduate research school. This includes training that is directly relevant to research such as writing and presenting skills; statistical analysis and programming skills. In addition, sections of my work have been presented in platform and poster formats at both local and international conferences.

The word count for this document is: 61870

Jodielin Antoinette Ofori

.....

## **Presentation and Conferences Attended**

**Ofori, J et al (2010)** Factors influencing the applied torque during manually applied plantarflexor stretches in people with Multiple Sclerosis (platform presentation) Chartered Society of Physiotherapy conference Liverpool UK

**\*Ofori, J et al (2011)** Factors influencing the applied torque during manually applied plantarflexor stretches in people with Multiple Sclerosis (poster) MS Trust conference Kenilworth UK

**Ofori, J et al (2011)** Factors influencing the applied torque during manually applied plantarflexor stretches in people with Multiple Sclerosis (poster) World Physiotherapy Conference Amsterdam

**\*Ofori, J et al (2012)** Effect of applied torque on range of motion, passive stiffness and spasticity in people with Multiple Sclerosis (poster) Association of Chartered Physiotherapists in Neurology (ACPIN) Annual general Meeting Northampton UK

**Ofori, J et al (2012)** Effect of applied torque on passive stiffness and spasticity in people with Multiple Sclerosis (platform) Association of Chartered Physiotherapists in Neurology (ACPIN) Annual general Meeting London UK

**Ofori, J et al (2012)** Effects of short term stretching on ankle stiffness and range of motion in people with Multiple Sclerosis (Invited speaker) Association of Chartered Physiotherapists in Neurology (ACPIN) Conference London UK

\* Prize awarded for best poster competition

## **1. Chapter One: Thesis Introduction and Overview**

This section of the thesis is intended to provide the reader with a brief outline of the thesis justification, aims and structure; followed by an overview of the interrelationship between the three experimental studies. In addition a timeline of the work presented in this thesis is provided see (Figure 1A) as well as a flow chart indicating the overlap of subjects across the three experimental studies see (Figure 1B).

### **1.1 Thesis Justification, Aims and Structure**

To date there is evidence that a constant torque stretch produces greater improvements in passive stiffness, spasticity and ROM compared to constant angle and cyclic stretches. However, it is unclear, during a constant torque stretch, what the optimal applied torque or duration of stretch actually is. This thesis therefore aims to assess the effects of different torques applied over different durations on passive stiffness, spasticity and ROM. In keeping with past study designs that have compared different types of stretches, a repeated measures design will be used where the same participants are seen over three different sessions and where in each session a different torque is applied for a set duration.

When applying stretches using a motor no justification has been given in previous work as to why a particular torque was chosen. The use of motors to deliver stretches have several advantages in that an exact specified torque can be delivered and the motor can be used to assess ROM and stiffness pre and post intervention. However, the use of motors are expensive and impractical for the majority of clinical stretching regimes (e.g. in the home environment). Therefore, it is important that the torques assessed, in this and future studies, include the range of torques that can be applied by patients for the purpose of self-management programmes. This will allow an assessment of applied torque delivered using motors to be ecologically valid and relevant to clinical practice.

Finally, it is important to ascertain the exact site of passive stiffness changes following a neurological insult and whether stretching specifically targets the sites (e.g. tendon vs. muscle) of increased stiffness. This can be done by imaging muscle motion using ultrasound during standard ankle perturbations.

This thesis therefore aims to:

- a) Define the torques that can be applied by pwMS during commonly prescribed manual stretches (Chapter 5)
- b) Investigate the effects of different levels of applied torque and durations of stretch using a motor on passive stiffness, spasticity and ROM in pwMS (Chapter 6 and 7)
- c) Investigate the effects of constant torque stretching on direct measures of muscle strain using ultrasonography (Chapter 8)

Chapter 2 discusses the pathology and pathophysiology of Multiple Sclerosis, followed by an in-depth review of the causes of limb stiffness, the clinical and scientific measurements tools used to measure stiffness and current management techniques. Chapter 3 presents a review of the literature on the effects of stretching for the treatment of hypertonia in the plantarflexors of people with acute and chronic CNS lesions. Chapter 4 will describe common methods that are used throughout the thesis and chapter 9 will provide an overview of the thesis findings an appraisal of the underlying study assumptions and their limitations, and directions for future work.

## **1.2 Inter-relationship between studies**

It has been reported that as much as 80% of people with MS present with an increase in muscle stiffness, leading to difficulties with functional tasks by making movements slower and more effortful. Clinically, stretching is commonly used to treat muscle stiffness; however, there is little evidence to guide the implementation of stretching programmes. Therefore this project aims to provide initial guidance for stretching in

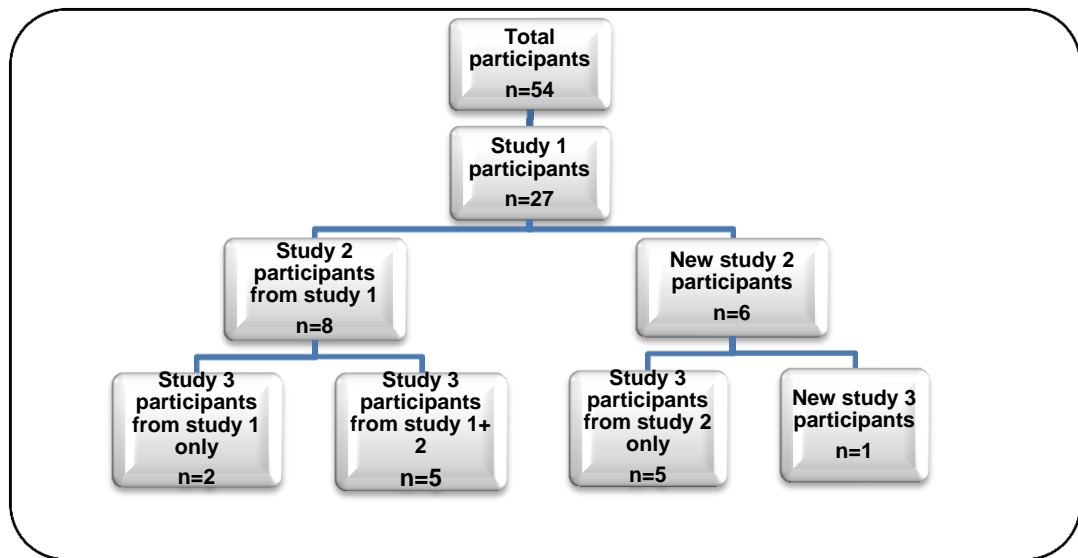


people with increased muscle stiffness, by undertaking three interrelated studies. As mentioned above study 1 (Chapter 5) determined the magnitude of plantarflexor torque people with MS can produce during commonly prescribed manual stretches for the plantarflexors and the duration of stretch that pwMS can achieve while stretching.

The finding(s) from this study directed the subsequent studies. In study 2 (Chapter 6) and study 3 (Chapter 7), a purpose built servomotor delivered stereotyped stretches and measured the size and rate of change of muscle stiffness during and following stretches. Study 2 determined how stiffness varies after a 30 minute constant torque stretch and over a 30 minute post stretch time period when different levels of force, known to be achievable by people with MS were applied. Study 3 determined how stiffness varied following a 10 minute stretch, which is a more clinically feasible time frame, and what area of the muscle tendon complex is targeted with this intervention.

The combined study sample of all three experiments consisted of 54 people clinically diagnosed with MS who were mild to moderately disabled. In study one, 30 participants with MS were recruited, 27 of which completed the study in addition to 15 healthy controls (Figure 1A). The recruitment of study 1 participants occurred over a two month period from January 2010 to February 2010. Data collection occurred between the months of February 2010 to March 2010. The high, medium and low torques generated by PwMS during study 1 was further investigated in study 2 over a 30 minute intervention and 30 minute follow-up period. In study two, 17 participants with MS were recruited, 14 of which completed the study in addition to 13 healthy controls. The recruitment of study 2 participants and experimental setup occurred over a 6 month period, from April 2010 to September 2010. Data collection and analyses occurred between September 2010 and March 2011; it was established that increases in ROM and reductions in stiffness plateau at around 10 minutes. These findings therefore informed study 3 which primarily investigated the effects of a 10 minute constant torque stretch on ROM and stiffness, in addition to investigating the changes that occur in the muscle and tendon with stretch using ultrasound. In study three, 17 participants with

MS were recruited, 13 of which completed the study, the control sample used in study 2 was also used to compare study 3 MS participant data. The recruitment of study 3 participants occurred over a 4 month period from March 2011 to July 2011, followed by the data collection and analysis from July 2011 to October 2011.



**Figure 1A:** Flow chart showing overlap of MS subjects across studies

## **2 Chapter Two: Background**

### **2.1 Introduction**

This thesis investigates how lower limb passive stiffness and spasticity are affected by stretching in people with Multiple Sclerosis (MS). This chapter will briefly look at the pathology and pathophysiology of MS (Section 2.2) before discussing the causes of limb stiffness (Sections 2.2-2.3) and providing an overview of current measurement (Section 2.4) and management techniques (Section 2.5).

### **2.2 Multiple Sclerosis**

MS is a chronic demyelinating disorder of the central nervous system (CNS). It is one of the leading causes of neurological disability in young adults and is estimated to affect 2.5 million individuals worldwide (Roncaroli, 2005). Onset typically occurs between the age of 20 and 40 and affects females at a ratio of 2:1 compared to males. In the United Kingdom (UK) MS is thought to affect around 85,000 individuals with a variable prevalence of 115/100,000 increasing to 224/100,000 in the Orkneys region (Burgess, 2003). The variable incidence of MS indicates a potential geographical gradient effect leading to suggestions of an environmental link to causation.

#### **2.2.1 Pathology**

The aetiology of MS remains unclear, although the autoimmune hypothesis is reasonably well established. It is thought that precursor T cells (partially differentiated), located in the peripheral lymphoid tissue, become myelin-reactive secondary to interactions with antigen presenting cells exposing myelin-cross-reactive antigens. The newly formed myelin-reactive T cells have the potential to express several chemokine receptors and along with the help of unregulated cell adhesion molecules and matrix metalloproteinase (MMPs), aid in the breach of the blood brain barrier and entry into the CNS (Weiner & Seikoe, 2002).

Once in the CNS, T-cells bind with specific antigens on macrophages and microglia, resulting in the secretion of cytokines, leading to an inflammatory response. Cytokines and gamma interferons then begin to break down the blood brain barrier resulting in further escalation of the inflammatory response. Excessive inflammation alongside a severely compromised blood brain barrier leads to the proliferation of B- lymphocytes with antibodies specific to myelin; these enter the CNS and attach themselves to the myelin surface whilst attracting macrophages and killer T-cells which then begin to phagocytise the myelin and damage oligodendrocytes (Matthews et al, 1991; Burgess, 2003).

There are two distinct pathological processes occurring in MS: early inflammation with associated demyelination and progressive axonal damage with irreversible deficits (Brinar, 2003). Both processes are thought to start at disease onset. However, early axonal damage may not produce observable neurological signs, primarily due to: the CNS's ability to compensate; spontaneous remyelination in specific sites; and the level of axonal damage not exceeding a predefined threshold (Burgess, 2003). Demyelination, in association with axonal damage, results in disordered conduction and propagation of action potentials, leading to a wide range of signs and symptoms. Although the inflammatory process often resolves spontaneously and areas of patchy remyelination are observed, repeated insult to the same site results in the formation of plaques and potentially irreversible axonal damage.

### **2.2.2 Types of MS**

MS can be extremely variable and multiple variants have been identified; this is primarily due to differences in the location and severity of damage in the CNS. Current definitions of the variations of MS are based on the prospective pattern of disease development individuals are likely to follow (Burgess, 2003). Relapsing remitting MS is the most commonly diagnosed variant and is characterised by multiple periods of exacerbation and remission. It is documented that approximately 80% of relapsing remitting cases go on to develop a secondary progressive disease pattern. The primary

progressive variant of the disease tends to occur in around 10% of cases and often develops after age 40; it is characterised by a continually degenerative pattern from onset, affecting primarily the spinal cord, and has no observable periods of exacerbation or remission (Herndon, 2003).

### **2.2.3 Signs and Symptoms**

Presenting signs and symptoms can be very unpredictable at disease onset and vary depending on the site and degree of neural compromise. MS can be associated with altered balance and co-ordination, visual disturbances, bladder and bowel dysfunction, pain, fatigue, cognitive dysfunction, weakness, stiffness and spasms (Boyce, 1998). Increased limb stiffness, or hypertonia, is one of the leading causes of disability in MS and is present in up to 85% of cases (Nielsen et al. 2007). Hypertonia is clinically observed as an increased resistance to passive movements of a limb. It is associated with considerable functional limitations, pain, increased energy expenditure to perform activities of daily living which can in turn reduce quality of life (Barber et al. 2011; Gao et al. 2011). Hypertonia can be caused by two main factors: an increase in passive stiffness and spasticity (Dietz & Sinkjaer, 2007). The causes underlying these two factors will be discussed in the next two sections.

### **2.2.4 Passive Stiffness**

It is apparent in the literature that the nature of hypertonia unrelated to stretch reflex activation is not clearly understood. There are varying schools of thought regarding the contributing mechanisms including changes in: the extracellular matrix (ECM) of muscle and tendon, intramuscular proteins, cross bridge attachment and fascicle length and sarcomere length/number. The contributions of these components to passive stiffness in healthy muscle will firstly be described (Section 2.2.5) before describing changes that occur with pathology (Section 2.2.6).

## **2.2.5 Extracellular Matrix of Muscle and Tendon**

The ECM has a variety of functions and plays an important role in force transmission and tissue structure maintenance in tendons, ligaments, bone and muscle. It is composed of a mesh of fibrous proteins and glycosaminoglycans; collagen and elastin are common fibrous proteins and contribute to the structural integrity of cells throughout the body (Harvey & Ferrier, 2011).

### **2.2.5.1 Collagen**

Collagen is synthesised by fibroblasts and the procollagen gene is transcribed into mRNA; intracellularly, the translation of procollagen mRNA occurs in the ribosomes and the assembly of procollagen in the lumen of the rough endoplasmic reticulum (Harvey & Ferrier, 2011). This process involves the hydroxylation of proline and lysine to form hydroxyproline and hydroxylysine; in some instances hydroxylysine residues are adapted through the process of glycosylation with glucose (Kjaer 2004). After hydroxylation and glycosylation, three polypeptide chains assemble with the formation of intrachain and interchain disulphide bonds, bringing chains into an alignment appropriate for the helix formation seen in fibrillar collagen types. Levels of hydroxyproline are often used as a marker for collagen synthesis in animal studies looking at passive stiffness.

The procollagen molecules progress through the golgi apparatus where they are secreted from golgi vesicles into the ECM. Within the ECM, procollagen is converted into collagen and incorporated into stable cross-linked collagen fibrils; these cross links can change with pathology and ageing as discussed later (Harvey & Ferrier, 2011). The triple helical formation of collagen fibrils allows it to demonstrate great tensile strength.

### **2.2.5.2 Proteoglycans**

Proteoglycans are an essential component of connective tissue and muscle ECM; the basic proteoglycan unit comprises a core protein and one or more glycosaminoglycan side chains (Harvey & Ferrier, 2011). Proteoglycans can be categorised by the nature of the attached glycosaminoglycan chain or their size: decorin, biglycan, fibromodulin and lumican all belong to the family of small leucine-rich proteoglycans and versican, perlecan, neurocan and aggrecan are large proteoglycans (Gillies & Lieber, 2011). Chondroitin and dermatan sulphate are common proteoglycans found in skeletal muscle ECM.

Both collagen and proteoglycans have unique interactions that maintain the structure and composition of the ECM. Proteoglycans bind with collagen in specific locations and decorin is thought to regulate type one collagen, the type found in tendons and muscle. Decorin in combination with biglycan, for example, has been associated with altered transforming growth factor signaling and fibrillogenesis (formation of new fibres) in skeletal muscle (Gillies & Lieber, 2011; Blalock et al. 2003). Transforming growth factor is used to describe two classes of polypeptide growth factors, transforming growth factor alpha and beta, the latter of which has many functions in skeletal muscle and is thought to induce fibroblasts to produce collagen and fibronectin (Blalock et al. 2003).

### **2.2.5.3 Role of Muscle and Tendon ECM in Contributing to Passive Stiffness**

The study of muscle ECM is considerably complex and often what is known is based on studies of bovine and feline tissues. The ECM of muscle is considered to be subdivided into three areas: the endomysial (around the muscle cell), perimysial (around muscle fascicle) and epimysial (around the whole muscle). It is thought that, the endomysial and perimysial ECM are, in some instances, intimately related. However, due to difficulties in isolating regions of ECM, it is not clear whether the structural properties of perimysium and endomysium are distinctly dissimilar. Furthermore, work conducted by Passerieux and his team (2006) looking at digested

bovine muscle fibres, suggests that sheets of perimysial collagen are in fact continuous with tendon. This suggestion is further strengthened as both tendon and perimysium are composed of type one collagen and the primary proteoglycan decorin (Passerieux et al. 2006). Recent experimental work has stipulated that the ECM bears the majority of passive load, leading to implications that clinical examinations of ROM and stiffness are potentially a good indication of ECM properties (Gillies & Lieber, 2011).

#### **2.2.5.4 Fibres Vs Whole Muscle**

Work conducted in decellularizing skeletal muscle has shown that the modulus<sup>1</sup> for single fibres is almost identical to grouped fibres that have had the ECM biochemically removed. In contrast, the modulus of fibre bundles with intact ECM was approximately five fold higher than that of single fibres, leading to speculation that the ECM is an extremely stiff structure encompassing relatively compliant muscle fibres (Winters et al. 2009).

#### **2.2.6 Intramuscular Proteins**

##### **2.2.6.1 Titin**

Passive stiffness is often described as a mechanical response secondary to tensile loading of non-contracting muscle (Harlaar et al. 2000). As muscle is stretched beyond its slack length the subsequent passive tension developed within fibres has been attributed in part to titin, a giant protein that extends from the z-line to the a-band in sarcomeres (Granzier 2007). Titin is thought to play a central role as a molecular scaffold within sarcomeres and is reported to contribute an estimated 90% towards passive force in skeletal muscle within the physiological sarcomere length. Beyond this length, work looking at cardiac muscle and animal literature has shown that collagen has a greater contribution to passive force (Wu et al. 2000). Titin can be subdivided into two sections namely IG (immunoglobulin) and PEVK. These constituents vary in composition between muscle groups and both sections have been found to be longer in

---

<sup>1</sup> Modulus is the ratio between stress and strain and gives an indication of the elasticity of a material



slow twitch muscle, thus leading to less resistance to a given stretch compared to fast twitch muscles (Fukuda et al. 2008).

#### **2.2.6.2 Cross Bridge Attachments**

The support for the role of cross bridge formation to tension development relies mainly on work conducted in animals. It is thought that when a muscle fibre is stretched there is an initial marked increase in stiffness, termed short range stiffness, which then decreases (Proske & Morgan, 1999). This initial increase in stiffness is felt to be due to the resistance applied by attached cross bridges that then break, leading to the reduction in stiffness. Huxley, (1957) provided evidence that during an active muscle contraction, active cross bridges form between actin and myosin; this process, which is  $Ca^{2+}$  dependent, requires the action of ATPase and is therefore energy dependent. In contrast low rates of cross bridge formation and detachment (termed low cycling) are felt to be present in resting muscle; their turnover is not dependent on ATPase. Low cycling cross bridges are felt to contribute to short range passive stiffness and to underlie the phenomenon of thixotropy, where the stiffness of a muscle is dependent on its history (Brenner et al. 1982). Muscle stiffness at a set length, for example, will be higher after the muscle has contracted in a shortened position (Williams 1990), which is felt to increase the number of stable attached cross bridges in the passive state. Stretching and perturbations can further decrease stiffness on a trial by trial basis by breaking cross bridge attachments and the number attached at any one time.

#### **2.2.6.3 Changes in Stiffness with Neurological Pathology**

Having an understanding of the structural and biomechanical changes that occur in muscle and tendons secondary to age, pathology and training has important treatment implications. However, the literature in this area is limited and the take home message often inconsistent.

#### **2.2.6.4 Changes in ECM**

Musculo-tendinous changes secondary to CNS pathology are variable (Shortland et al. 2002; Lieber et al. 1996). Nevertheless the general consensus indicates that, following CNS pathology, there may be observable changes. These can include an increase in tendon length and lower tendon stiffness associated with shorter and stiffer muscle fibre length, and variable fibre size and type. Further, increased endomysium and perimysium volume and changes in the quality of the ECM is associated with increased stiffness (Alexakis et al. 2007; Lieber et al. 2004; Zhao et al. 2009; Foran et al. 2005).

#### **2.2.6.5 Titin**

Work by Udaka and colleagues demonstrated a 45% decrease in titin following immobilization of the hind limbs of rats (Udaka et al. 2008). In addition, a 20% loss in actin and myosin was observed resulting in a shortening of the thick and thin filaments; this in association with the reduction in titin is believed to result in a disorganisation of sarcomere structure, thus affecting passive force output (Udaka et al. 2008). Titin can exist in multiple isoforms in both skeletal and cardiac muscle. It has been established in work by Wu and colleagues that titin isoform switching occurs secondary to disuse, leading to an increase in myocardial stiffness as a result of increase up-regulation of collagen (Wu et al. 2002). It has therefore been postulated that titin isoforms may be altered in spastic skeletal muscle (Foran et al. 2005). However, Olsson et al. (2006) and others investigating increases in passive muscle tension in spinal-cord injured subjects with spasticity concluded that the difference found in passive tension between spastic and control subjects was unrelated to changes in titin content but were likely to be due to remodelling within the ECM and the muscle cell. Similarly, direct measurements of fibre length in children with cerebral palsy indicated that there was no evidence of fibre length change secondary to spasticity, suggesting that there was no change in the length of intramuscular proteins like titin (Lieber et al., 2004).

### **2.2.6.6 Cross Bridges**

Carey, (1990) evaluated the control of active movement of the index finger in subjects with hemiparesis. He reported an observable impairment in extension following an initial flexion movement. This history dependence of movement was thought to be due to an increase in cross bridge related stiffness. Furthermore, these findings are reported to be consistent with the cross bridge stiffness theory described by Hagbarth and colleagues, where large amplitude flexion contraction of the muscle is thought to promote the formation of new bonds in a shortened position, resulting in increased flexor stiffness (Hagbarth et al. 1985). It is thought that once myosin engages with actin during an active contraction, it may fail to disengage readily or re-engage spontaneously with a lower detachment rate therefore adding frictional resistance, which weaker extensor muscles may not be able to overcome (Carey & Burghardt, 1993). However, other factors such as abnormal motor programming or perceptual limitations may account for some of the findings observed; further exploration of these findings is warranted.

As demonstrated thus far, there are varying theories regarding the mechanism responsible for the development of passive tension in the musculotendinous complex and it is clear that no single structure is responsible. A combination of structures in both healthy and pathological conditions is thought to contribute to passive stiffness. The current evidence suggests that the main contributing factors to increases in passive stiffness following a neurological insult are changes in the quality and quantity of the ECM.

### **2.2.6.7 Muscle Fascicle Length and Sarcomere Number**

Animal studies highlight that immobilisation of a muscle in a shortened position results in a reduction in sarcomere number (Williams 1990; Williams & Goldspink 1984). More recently human studies have directly measured muscle fascicle length using ultrasound. They have shown that fascicle length post stroke (Gao et al. 2011; Kwah et al. 2012) and in cerebral palsy can be reduced (Barber et al. 2011). This can often be

associated with a longer tendon (Barber et al. 2012). Shorter muscle fascicles will result in a decrease in “slack length”; the length at which the muscle begins to generate tension (Herbert & Balnave 1993). This in turn results in an increase in resistive tension at a specific length thus increasing stiffness.

## **2.3 Spasticity**

The most frequently cited definition of spasticity is that reported by Lance (1980) which states: “Spasticity is a motor disorder characterized by a velocity-dependent increase in tonic stretch reflexes (muscle tone) with exaggerated tendon jerks, resulting from hyperexcitability of the stretch reflex, as one component of the upper motor neurone syndrome”. Throughout this thesis, the term spasticity will be used to describe increases in muscle tone secondary to enhanced stretch reflex size. It is speculated that a number of central and peripheral mechanisms may be involved in the genesis of spasticity. These mechanisms and their potential contribution to the development of spasticity will be discussed below (Sections 2.3.1-2.3.2).

### **2.3.1 Role of Descending Pathways**

Descending pyramidal and parapyramidal tracts originating from the motor areas of the cerebral cortex and brainstem play a central role both in the activation of inhibitory spinal circuits and the modulation of alpha motor neurone activation (Stevenson & Marsden, 2006). Animal studies suggest that two descending systems exist, primarily controlling tone. These are the inhibitory dorsal reticulospinal tract and the facilitatory medial reticulospinal and vestibulospinal tracts. Extensive lesions of the lateral funiculus that include the inhibitory dorsal reticulospinal tract are associated with the development of spasticity and hyperreflexia (Brown 1994). The inhibitory centres in the brainstem are in turn excited by descending inputs from the motor cortex. Therefore, a cortical and capsular lesion results in a loss of excitatory drive to the inhibitory centres in the brainstem and thus a loss of inhibitory input to the spinal cord (Brown, 1994). Additionally, lesions to serotonergic pathways from the raphe nucleus in the brainstem may contribute to the alterations in motor neurone properties of patients with spasticity

(see plateau potentials section 2.3.2.5) (Bennett et al. 2001). The role of specific descending tracts in the development of spasticity remains unclear in humans, in part due to difficulties in stimulating tracts in the brainstem electrically or pharmacologically.

### **2.3.2 Role of Spinal Cord Inhibition**

Numerous inhibitory pathways contribute to the control of spinal motor neurone activity in relation to movement. This is achieved either by affecting the transmission of muscle spindle sensory information through presynaptic inhibition or via direct or indirect reductions in the excitability of the alpha motor neurons (Stevenson & Marsden, 2006). It is thought that some of these pathways may be involved in the subsequent development of spasticity following pathology of the CNS (Nielsen et al. 2007).

#### ***2.3.2.1 Disynaptic Reciprocal Ia Inhibition***

Due to disynaptic inhibitory pathways within the spinal cord, contraction of the agonist leads to relaxation of the antagonist muscle. Reduced reciprocal inhibition is thought to contribute to the clinical manifestation of hyperreflexia and spasticity and has been observed in patients with MS, spinal cord injury and hereditary spastic paraparesis (Crone et al. 2006). It is important to note that this form of inhibition is absent in many healthy subjects (Crone et al. 1994), therefore demonstrating variability within this measure and potential misinterpretation of findings in studies that are not sufficiently controlled.

#### ***2.3.2.2 Presynaptic Inhibition***

Work by Nielsen et al. (2007) looked at the size of monosynaptic facilitation of the soleus H-reflex evoked by stimulation of the femoral nerve. They demonstrated that presynaptic inhibition of Ia afferent terminals decreased in MS and spinal cord injured patients with spasticity. This is in line with the use of diazepam to manage spasticity which is reported to reduce spasticity by increasing presynaptic inhibition (Nielsen et al. 2007). Similarly, work by Lamy and colleagues investigating the efficacy of presynaptic mechanisms in stroke patients with spasticity, reported that presynaptic

inhibition was notably depressed on the affected side of stroke patients when compared to healthy controls (Lamy et al. 2009). They observed that changes in presynaptic inhibition were not positively correlated with the severity of spasticity and subsequently speculated that this form of inhibition does not play a major role in the development of spasticity but is a general consequence of an upper motor neurone lesion (Lamy et al. 2009).

### ***2.3.2.3 Autogenic Ib Inhibition***

Autogenic Ib inhibition is caused by activation of Ib afferents from golgi tendon organs (GTO) situated in joint tendons; it is mediated by spinal inhibitory interneurons projecting to the motor neurones of the same muscle. The effect of Ib stimulation on the parent motor neurone is not static and not always inhibitory. Ib stimulation in walking cats, for example, results in excitation of the parent motor neurone (Conway et al. 1987). This is felt to be important for stance phase activity; load is detected by the GTOs resulting in activation of the muscle to maintain extensor activation. There is evidence for these pathways in humans (Stephens & Yang, 1996). In people with spasticity there is less inhibition at rest following stimulation and instead excitation is seen (Delwaide & Olivier, 1988), suggesting that these excitatory pathways may be active at rest and contribute to spasticity.

### ***2.3.2.4 Recurrent Inhibition***

Recurrent inhibition is mediated by renshaw cells which are located in the ventral horn of the spinal cord. They receive excitatory stimuli from motor neurone axon collaterals and in turn synapse onto motor neurones and Ia inhibitory interneurons (Baldissera et al. 1981). Pierrot-Deseilligny & Brussel, (1975) investigated changes in recurrent inhibition using an H-reflex based technique. They demonstrated that recurrent inhibition was relatively normal in patients with spasticity, with some impaired modulation of the inhibition being observed during voluntary movement. It was therefore concluded that changes in recurrent inhibition may not play a major role in the

development of spasticity as assessed at rest but may contribute to the functional limitation observed in these patients.

### **2.3.2.5 Role of Adaptive Changes**

The slow clinical development of spasticity following the onset of neurological pathology indicates it is not a release phenomenon where an abrupt decrease in inhibitory control over the spinal cord leads to the simultaneous onset of spasticity (Stevenson & Marsden, 2006). The literature suggests that motor neurones demonstrate intrinsic changes over time, along with potential morphological changes such as collateral sprouting of partially denervated neurones, that in turn alter how muscle spindle signals are processed at the spinal level (Nielsen et al. 2007).

Hultborn and colleagues postulated that muscle spasms develop secondary to the activation of voltage dependent, persistent inward currents in motor neurones generating continual depolarisation termed plateau potentials (Hultborn et al. 2003). Further, plateau potential activation was found due to calcium and sodium mediated persistent inward currents (Li & Bennett, 2003) in rats with a chronic spinal cord injury and associated spasms and hyperreflexia. These plateau potentials could be caused by non-noxious stimuli and could contribute to spasticity as well as spasms.

In healthy rats, plateau potentials are mediated by descending serotonergic inputs. Importantly, as plateau potentials are voltage dependent they can be turned off by the action of other inhibitory inputs. It seems with a CNS lesion, abnormal motor neurone properties may develop over time, possibly as a result of lesions to serotonergic pathways. As discussed above, the lack of inhibitory activity in the spinal cord in spasticity compounds the development of plateau potentials by allowing them to continue relatively unabated. Similarly, it has been shown that stimulation of lower limb muscles in humans with spinal cord lesions resulted in non-linear increases in force and persistent motor neurone firing after cessation of electrical stimulation (Nickolls et al. 2004). The authors suggested that the potential causative mechanism was related

to “afferent feedback coupled with feedback circuits within the spinal cord, leading to a large synaptic input into neurones driving them into a plateau state that in turn gives rise to motor neuronal firing” (Nickolls et al. 2004 p.669).

Changes in the properties of the Ia – motor neurone synapse may also occur as suggested by changes in the degree of post activation depression in people with spasticity. Post activation depression is seen in healthy participants and is the decrease in motor neurone response size to repeated stimulation of the Ia afferent. This is felt to reflect changes in the Ia-motor neurone synapse. In spasticity a reduction in post activation depression is seen such that motor neurone excitability does not decrease with repetitive activation. Post activation depression is reported to be strongly correlated to hyperreflexia and spasticity (Aymard et al. 2000) and is a strong candidate for mediating spasticity. This is in line with work by Lamy who observed a reduction in post activation depression on the affected side of spastic stroke patients, which was found to be significantly correlated with the severity of spasticity (Lamy et al. 2009).

### **Summary**

In humans, the specific role of different descending tracts in mediating spasticity remains unclear. It is clear, however, that some changes in spinal cord inhibitory circuits develop; some of these may be a marker of CNS pathology and not mediate spasticity *per se*. Changes in motor neurone properties and in Ia – motor neurone synapses may underlie the development of plateau potentials and reduction in post activation depression, both of which may play an important role in mediating spasticity.

## **2.4 Measurement of Hypertonia**

The term hypertonia, as previously mentioned, relates to the resistance felt when a joint is moved passively through its range while the participant is relaxed. The resistance is the product of the physical inertia of the limb, the mechanical and elastic components of muscle and connective tissue, and reflex muscle contraction (stretch



reflex) (Morris, 2002). However, since the properties of inertia are unchanged following a neurological insult, changes within the segmental reflex arc and the musculotendinous unit are thought to be joint contributors to the added resistance felt during clinical examination of a person with an upper motor neurone lesion.

Clinically the term hypertonia and spasticity are often used interchangeably and the lack of a precise clinically relevant definition for spasticity has led to difficulties in the development of a valid measurement tool (Johnson & Pandyan, 2008). Furthermore, the wide variety of measurement tools available for the assessment of spasticity and issues relating to the psychometric properties of some of these measures is an ongoing limiting factor (Bohannon & Smith, 1987; Pandyan et al. 2001; Bakheit et al. 2003). The measurement tools for the assessment of hypertonia range from clinical ordinal scales to more complex electrical and biomechanical equipment, and will be discussed below.

## **2.4.1 Clinical Measures**

### ***2.4.1.1 Ashworth and Modified Ashworth***

The Ashworth and modified Ashworth scales frequent clinical practice as their application is inexpensive and easily implemented. The Ashworth scale is an observer related subjective test based on grading the perceived resistance to passive stretch on a scale of 0 - 4. Its validity has been questioned since it has been argued that the resistance to passive movement could be due to multiple factors including increased passive stiffness and contracture, dystonia, inadvertent voluntary contraction and spasticity and that this scale is not able to accurately differentiate between these constructs (Morris, 2002).

The scale was modified (the modified Ashworth scale) to include an additional level of measurement (1+) with a revised description of grades at the lower portion of the scale (Bohannon & Smith, 1987). It was thought that this additional level would potentially increase the responsiveness of the measure. However, these modifications have

appeared to present an ambiguity in the scale, increasing the potential for error and reducing it to a nominal level of data (Johnson & Pandyan, 2008). A number of studies have now shown that the modified Ashworth scale, when compared with the original, has lower reliability particularly for the assessment of the lower limb (Sloan et al. 1992; Nuyens et al. 1994; Haas et al. 1996).

Numerous studies have been conducted regarding the inter-rater and intra-rater reliability of both the Ashworth and modified Ashworth scales; it is evident that there is clear variability in the research findings ranging from poor to good within and among different muscle groups, pathological conditions and patient populations (Pandyan et al. 1999; Sehgal & McGuire, 1998; Brashear et al. 2002; Nuyens et al. 1994; Haas et al. 1996; Bohannon & Smith, 1987; Price et al. 1991). These variations in reliability are perhaps unsurprising given that the application of this measurement tool is often not standardised and uses a variable stimulus (Engsberg et al. 1996). In addition, some of the inconsistencies found may also be related to flaws in the analysis of findings such as the use of parametric tests and summed scores for ordinal level data (Johnson & Pandyan, 2008). In recognition of these issues the current consensus among researchers regarding the use of this tool indicates that application should involve: a single trained assessor; notation of the passive available ROM, resting limb posture and pain experienced throughout testing; repeated movements being kept to a minimum; and the following of a standardised measurement protocol (Johnson & Pandyan, 2008). In addition it is recommended that individual scores are taken for joints or muscles assessed as opposed to the use of summated scores.

#### **2.4.1.2 Tardieu Scale**

The Tardieu scale, is an observer rated measure which attempts to quantify muscle tone by subjectively measuring the perceived resistance to passive movement and, additionally, the intensity and timing of any stretch-evoked muscle response. It is rated on a 5 point scale and measured at three predefined velocities. The addition of a quantifiable component to the scale (the point at which there is a muscle contraction

leading to a catch in the movement) potentially increases its objectivity compared to the Ashworth scale. It's validity is potentially further enhanced by taking into account the velocity dependency of the stretch reflex (Lance, 1980).

However, this method was reported to be quite complex and time consuming (Scholtes et al. 2006) and a modified version was therefore created. The modified version required simply defining the ROM when there is a catch during the fast passive stretch (Scholtes et al. 2006). It is thought that the relationship between the muscle length and the initial angle and the catch angle found during a fast stretch has a wide application and can be used to estimate the relative contribution of neural mechanisms and the mechanical resistance from the soft tissue (Morris, 2002).

However, it appears that the three applied velocities and the starting position of patients during testing was often variable, potentially affecting the results obtained by this measure (Frerebeau et al. 2003; Filipetti & Decq, 2003). In addition to this clonus is included in the definition of the highest level of spasticity. Clonus, however, is a distinct symptom related to spasticity but not specific for the presence of spasticity. Whereas clonus is specific to certain muscle groups, spasticity can be observed in any muscle group (Scholtes et al. 2006).

#### ***2.4.1.3 Multiple Sclerosis Spasticity Scale -88***

More recently a self-report scale has been developed to assess the subjective impact of spasticity and spasms in pwMS; the 88-item MS Spasticity Scale (Hobart et al, 2006). The items of the scale were initially chosen on the basis of interviews, focus groups, expert opinion and literature review and were developed into questionnaires which were subsequently validated on people with MS and their reliability established. The final scale has 88 items that assess the person's experience of (a) the impact of the symptoms of muscle stiffness, pain and discomfort and spasms (b) the physical impact on activities of daily living, walking and body movements (c) the impact on feelings and social functioning (Hobart et al. 2006). As such this scale is an important

additional outcome that addresses the subjective impact of spasticity that other objective scales omit. However, its relationship with more objective measures of stiffness have not been investigated to date. In addition it is thought that further research is required to understand the meaning of the score achieved and any change in score with treatment (Hoang 2009).

## **2.4.2 Mechanical**

### ***2.4.2.1 Wartenberg Test***

The pendulum test described by Wartenberg involves the knee being released from full extension, the leg is allowed to swing until motion ceases and the number of swings recorded (Wartenberg, 1951). Bajd and Vodovnik examined this measurement tool by attaching a goniometer to the knee and noted the movement at the knee joint following release (Bajd & Vodovnik, 1982). They proposed a relax index based on the rate of decay of oscillations as a measure of spasticity; however this was never clinically validated. Others have used mathematical analyses of changes in gain and threshold of the reflex arc to demonstrate the potentially complex nature of this form of examination (He & Norling, 1997). An investigation of the validity of this measure was undertaken wherein the Ashworth scale and the Wartenberg tests were compared (Leslie et al. 1992); this demonstrated that the two methods appear to measure similar constructs; it was suggested that the Wartenberg appeared to be a more responsive measure (Leslie et al. 1992). Furthermore, Katz and Rymer suggested that it has more face validity and is a more acceptable measure than the Ashworth scale, since it corresponds better to the clinical perception of spasticity (Katz & Rymer, 1989). It is important to note that, while this method is applicable for use in participants with mild spasticity, those with more severe stiffness from a practical point of view could not be accurately assessed with this measure due to lack of oscillatory movement available (Johnson & Pandyan, 2008).

#### **2.4.2.2 Myometer and Motorised Devices**

Various studies have demonstrated the usefulness of motorised devices in the accurate differentiation and objective measurement of spasticity within a laboratory setting (Lorentzen et al. 2010; Katz & Rymer, 1989). Boiteau and colleagues found that a manual dynamometer used to measure spastic hypertonia showed high reproducibility and high intra-rater reliability (Boiteau et al. 1995). Furthermore the validity and responsiveness of dynamometers have been evaluated and is reported to produce highly accurate resistive force values in healthy and neurological person's at both high and low angle velocities (Farrell & Richards 1986). Additionally, the application of powered computerised systems allows the detailed recording of the kinematics and resistance to motion (Johnson & Pandyan, 2008). However, measurement tools which offer a quantifiable method of evaluating spasticity such as motorised myometers and dynamometers are often considered too complex and expensive for use in the clinical setting (Haas et al. 1996) and are thought to be associated with compliance issues in children (Katz & Rymer, 1989).

#### **2.4.3 Physiological**

##### **2.4.3.1 Tendon Jerks**

The tendon jerk is commonly used to elicit a spinal reflex by the delivery of a rapid stretch to a muscle. The response is thought to predominantly involve the monosynaptic pathway although it has been suggested by Rothwell (1994) and Pierrot-Deseilligny and Burke (2005) that the oligosynaptic pathways may be involved. The tendon jerk may be a quantifiable measure of spasticity as it is easily elicited in people with spasticity, with a small stimuli resulting in a higher diffused amplitude response (Rothwell, 1994; Pierrot-Deseilligny & Burke, 2005). However it has been highlighted that increases in the size of the tendon jerk are not exclusive to spasticity and further investigation is required into the relationship between an increase in tendon jerk and its relation to increased gain and decreased threshold of the stretch reflex (Johnson & Pandyan, 2008).

### **2.4.3.2 H Reflexes**

The H reflex is a reflex obtained by electrically stimulating a nerve sub-maximally. This stimulates large Ia afferents that arise from the muscle spindle. Unlike the tendon reflex, the H-reflex response does not require stretch of the muscle spindle. It has been used to study excitability in the Ia afferent pathways and abnormalities in spinal inhibitory pathways (see section 1.7.2) (Katz et al. 1992; Rothwell, 1994; Pierrot-Deseilligny & Burke, 2005). The test can be conducted fairly easily but variable results potentially affecting the reliability of the measure have been reported due to variations in stimulus intensity, resting posture of the limb and body and an inability of the participant to completely relax (Katz, 1994). Additionally responsiveness is thought to vary depending on the age and activity level of the individual (Biering-Sørensen et al. 2006). Therefore, as with other measures, a standardised protocol is required if comparisons are to be made across time and between different groups.

This chapter has critically reviewed a range of measures for the assessment of hypertonia; the use of a motorised dynamometer as previously mentioned is both objective and reliable. Therefore in the studies undertaken for this thesis I will measure spasticity by imposing stereotyped stretches using a motor and measuring the mechanical response and EMG response. This method has the advantage that it can measure stretch-evoked stiffness in the same units (Nm/kg.rad) as passive stiffness and gives a direct indication of the opposing torque that can limit functional movements (Wood et al. 2005). I will also use clinical measures of spasticity to define the participant's baseline level of stiffness from the perspective of both the clinician (Ashworth scale) and the participant (MSSS-88).

## **2.5 Overview of Treatment Regimes for Hypertonia**

### **2.5.1 Pharmacological**

The pharmacological management of hypertonia is primarily focused on the treatment of positive upper motor neurone signs such as spasticity and spasms. It is often implemented when spasticity begins to directly impact on the function of the individual,

such as occurs with abnormal limb posturing, motor impairment and difficulties with nursing or hygiene routines (Ward, 2002). As discussed in section 2.3, an understanding of the pathophysiology of spasticity is not definitive and several mechanisms have been alluded to in relation to its origin. Current pharmacological treatment options are thought to work by either directly or indirectly altering these mechanisms by stimulating inhibitory inputs at the spinal cord level or acting directly on the neuromuscular junction / muscle. These actions result in a reduction of spinal reflex excitability (Abbruzzese, 2002) . Common pharmacological agents include diazepam, baclofen, tizanidine, dantrolene and gabapentin (Stevenson, 2006).

#### **2.5.1.1 Diazepam**

Diazepam is most commonly used for the treatment of spasticity secondary to lesions of the spinal cord; its mechanism of action is thought to involve the stimulation of gamma-aminobutyric acid a (GABA<sub>A</sub>) receptors within the brain stem and spinal cord, resulting in an increase in presynaptic inhibition. Clinically this is manifested in a reduction in the resistance felt too passive movement and a decrease in tendon stretch reflexes and spasms (Verrier et al. 1977). The effectiveness of diazepam for the treatment of spasticity has been demonstrated in cerebral palsy and MS patients (Engle, 1966; Beard et al. 2003). However, this treatment is associated with a variety of side effects including drowsiness or sedation and memory impairment (Abbruzzese, 2002).

#### **2.5.1.2 Baclofen**

Baclofen is used for the treatment of cerebral and spinal spasticity and works by stimulating gamma-aminobutyric acid b (GABA<sub>B</sub>) receptors with the resultant effect of a reduction in calcium influx and excitatory neurotransmitter release, thus facilitating presynaptic inhibition (Stevenson, 2006). It is thought that clinical benefits related to this treatment include reduced flexor-extensor spasms and a reduction in monosynaptic and polysynaptic reflexes (Abbruzzese, 2002). However, clinical trials of this agent have tended to focus on the immediate effects on spasticity; thus very little is

known of its effects on function (Stevenson, 2006). The side effects of this drug are primarily dose related and are consistent with those described in diazepam.

### **2.5.1.3 Tizanidine**

Tizanidine has been described as an alpha2 agonist and is thought to bind at supraspinal and spinal levels leading to a decrease in presynaptic activity of excitatory interneurons (Bes et al. 1988). Additionally, work by Coward (1994) found that tizanidine's inhibitory action may be mediated via coeruleo-spinal pathways (Coward 1994). Tizanidine leads to a reduction in stretch reflex size and co-contraction of agonist and antagonistic muscle groups. Side effects with tizanidine have been reported as minimal and are broadly similar to that of baclofen. However, patients on this therapy should undergo liver function tests due to the possibility of hepatitis (Stevenson, 2006).

### **2.5.1.4 Dantrolene**

Dantrolene, unlike the other treatments previously described, works outside the CNS and is thought to inhibit the release of calcium peripherally, thus affecting excitation-contraction coupling within muscles (Thompson et al. 2005). It leads to a reduction in both muscle tone and spasms (Abbruzzese, 2002). It is also thought to play a role in the modulation of spindle activity via stimulation of intra- and extra-fusal fibres (Gracies et al. 1997). The use of dantrolene is often restricted due to the serious nature of its side effects, which include hepatotoxicity, gastrointestinal abnormalities, nausea, drowsiness and fatigue (Pinder et al. 1977).

### **2.5.1.5 Cannabinoids**

Cannabis sativa contains multiple compounds known as cannabinoids; it is thought that these compounds may have beneficial effects on commonly occurring symptoms related to MS such as spasticity, tremor and bladder dysfunction (Killestein & Hoogervorst, 2002). In addition, it has been estimated that as many as 4% of MS patients in the UK use cannabis illegally for the purpose of symptomatic relief (Zajicek



et al. 2003). It is postulated that cannabinoid receptors, when in the CNS, may potentially play a role in the inhibition of neurotransmitter release, and have a neuroprotective action; they are also found on cells in the immune system (Thompson & Baker 2002; Hinson & Boone 1996).

However, four small studies (Petro & Ellenberger, 1981; Ungerleider et al. 1987; Greenberg et al. 1994; Killestein & Hoogervorst, 2002) and one large randomised control trial (Zajicek et al. 2003) looking at the effects of cannabinoids on spasticity in MS showed no significant treatment effect and reported only subjective improvements in symptoms relating to spasticity and pain. The authors of the RCT noted, however, that improvements in walking speed ranging from 4%-12% were observed with the use of oral cannabis extract and tetrahydrocannabinol (Zajicek et al. 2003).

To summarise, there is some evidence that cannabis may have some functional benefits in the MS population. However, the side effects can be profound at high dosages and it is clear that more work is needed in this area in order to make more definitive claims regarding its effectiveness.

#### ***2.5.1.6 Miscellaneous Treatments***

The use of gabapentin (Cutter et al. 2000) and a variety of other oral agents has been documented as having anti-spasticity effects in people with MS. Most of these agents appear to have similar mechanisms of action, clinical indication and side effects as those mentioned earlier. However, their use is not widely researched and most of what is known is based on participant subjective feedback. More research is warranted into potential benefits for the treatment of spasticity.

#### ***2.5.1.7 Botulinum Toxin***

Botulinum toxin is a very strong neurotoxin that is commonly prescribed for the focal treatment of severe spasticity which is causing serious functional limitations (Ward, 2002). The mechanism by which botulinum toxin works is through inhibiting the release of acetylcholine at the neuromuscular junction (Stevenson, 2006). Intramuscular

administration of botulinum toxin can be painful and although side effects have been reported as transient they may also involve extensive and functionally limiting weakness (Bakheit et al. 1996). The clinical effects of botulinum toxin are reversible and currently only botulinum toxin A and B are used therapeutically. Their effects have been investigated in a variety of neurological conditions including MS, cerebral palsy, and head injury, with significant reductions in muscle tone being reported (Stevenson, 2006). However, there is still a paucity of evidence on the impact on functional improvements with this form of treatment (Bjornson et al. 2007; Corry et al. 1998).

#### **2.5.1.8 Chemical Neurolysis**

Chemical Neurolysis is a well-developed but less common form of focal spasticity management, associated with the injection of phenol or alcohol into problematic areas. This form of therapy predominantly affects alpha motor neurons and induces focal chemodenervation via protein coagulation, muscle death and the non-selective destruction of neural tissue; wallerian degeneration is often precipitated (Stevenson, 2006). Peripheral phenol nerve block is commonly applied to the lower limb musculature of patients with brain or spinal cord injury or cerebral palsy and leads to a complete decrease in tone; clinically this is often used to assist with gait re-education and positioning (Barnes, 1993). However, the benefits of such therapy are thought to be short lived if not combined with a form of stretching regime and its effects on function are yet to be established (Abbruzzese, 2002). The side effects of phenol injections are varied and thought to include sensory damage, neuralgic pain, tissue damage and thrombosis.

#### **2.5.2 Physical**

The therapeutic management of non-neural passive stiffness is predominantly through the use of physical adjuncts with the fundamental focus being to: maintain or improve function; prevent the development of secondary complications; alter patterns of

spasticity and spasm development; minimise pain; and improve comfort (Lockley & Buchanan, 2006).

It is evident within the clinical literature that two distinctly different forms of physical management strategies exist, namely prolonged low load stretching and brief high load stretching (Partridge, 2002). The former includes the use of positioning, splinting/orthotics, serial casting and standing. The latter includes passive physiological movements, and passive manual stretching (with or without the use of an aid) and motor driven continuous passive movement techniques. An overview of these concepts will be discussed below.

#### ***2.5.2.1 Standing and Positioning***

Prolonged passive stretching methods, such as standing and positioning, are an integral part of both acute rehabilitation and the long term management of neurologically impaired patients (Hass & Crow, 1995; Bovend' Eerdt et al. 2008). It is thought that prolonged passive stretching techniques increase joint ROM, decrease spasticity and spasms, prevent the development of contractures, facilitate optimal positioning and comfort, and reduce pain (Odeen & Knutsson, 1981; Bohannon & Larkin 1985; Edwards & Charlton, 2002). Furthermore, prolonged positioning of muscles in a lengthened position is thought to modulate stretch reflex activity and promote antigravity activity in trunk and lower limb muscles (Odeen & Knutsson, 1981; Edwards & Charlton, 2002).

However, as highlighted by recent systematic reviews (Bovend' Eerdt et al. 2008); (Katalinic et al 2011), studies in this area consist of very small sample sizes, and are often carried out in conjunction with anti-spasticity medication (Bovend' Eerdt et al. 2008). Standing and positioning are often used as adjuncts to treatment and it is apparent from the literature that a lack of standardisation of treatment exists due to a lack of knowledge in the timing and length of application of interventions (Lockley &

Buchanan, 2006). Therefore it is difficult to accurately establish the true effect of these prolonged passive techniques on passive stiffness and spasticity.

### **2.5.2.2 Passive Movements**

Passive movement techniques are typically used in situations where patients experience significant difficulty in moving their limbs due to paralysis or severe spasticity or spasms. Although the evidence base to support the use of this intervention is very limited, clinically this form of treatment is administered on the premise that movement is beneficial for the prevention of secondary complications, preservation of skin integrity and reduction in spasticity (Thornton & Kilbride, 2004).

It is also thought that the implementation of a passive movement programme, before activities of daily living tasks are carried out, helps to facilitate care and increase comfort (Lockley & Buchanan, 2006). Work by Schmit et al. (2000) reported reductions in elbow flexor stretch reflexes following repeated passive movements of the elbow, indicating a potential reduction in spastic hypertonia.

Fundamentally, stretching programmes are implemented to maintain or prevent loss of available ROM; reduce hypertonia and to improve ROM. Such techniques include static stretching, cyclic stretching, and stretching at a constant torque or a constant angle, such as when splinting, casting or using orthotics (Bressel & McNair, 2002; Chung et al. 2005). More recently studies in patients with an upper motor neuron lesion (e.g. cerebral palsy) have used a combination of motorised devices and servomotors to implement different stretching techniques (Wu et al. 2011). This includes the use of intelligent control stretching (Gao, et al 2011) which involves adjusting the applied stretching velocity according to the movement and resistance generated by both muscles and soft tissue structures.

### **2.5.2.3 Splinting/Casting/Orthotics**

It is not uncommon within the literature for the terms splinting, casting and orthotics to be used interchangeably. These devices are designed to offer a form of non-invasive

therapy. Their mechanism of action relates to the continuous application of a low load stretch and an alteration in the distribution of forces to or from the body (Lockley & Buchanan, 2006). This form of therapy is normally used as an adjunct to pharmacological treatment and provide a sustained stretch, thus potentially minimising/preventing the development of contractures and spasticity, compensating for deformity and increasing patient comfort (Mortenson & Eng, 2003; Lockley & Buchanan, 2006). The evidence base for these treatments is limited; they are often used in combination with pharmacological treatments so their effect in isolation is unclear and parameters, such as the length of use and the applied force, vary between studies with no consensus/evidence as to their optimal value.

The effects of stretching on the prevention of contracture has attracted great attention in the literature and a recent Cochrane review of stretching in populations with long term neurological conditions has concluded that there is no evidence supporting the role of stretching in improving ROM, either in the immediate, short or long term (Katalinic et al. 2012). In accordance with guidance for Cochrane reviews, only randomized controlled trials were included in the review with the aim of minimizing, as much as possible, potential biases such as order effects and assessor bias. However, this excludes many trials that have explored the effects of different stretching parameters on ROM and stiffness; for example (cyclic stretching vs constant torque stretching in the same group). This, as well as a lack of analytical clarity and disregard for potential muscular changes at a cellular level, suggests that the findings may be inconclusive and limited requiring further investigation (Weppeler, 2011).

The Cochrane review included studies on both the upper and lower limb. This may complicate the meaningful interpretation of the results since upper and lower limb muscles vary in their muscle architecture and neural control and thus may vary in their response to stretch. The Cochrane review further included people with both central and peripheral neurological disorders, including Charcot-Marie-Tooth disease and

Duchenne Muscular Dystrophy, who may differ in their response to stretch due to differences in their underlying pathology; for example, in the degree of muscle fibrosis.

Additionally studies were included where stretching was an adjunct to additional treatment such as Botulinum Toxin injections, making the effects of stretching difficult to ascertain. Finally, the Cochrane review did not investigate the effects of stretching on passive stiffness. Therefore it is evident that a more detailed and in-depth analysis of the literature surrounding the effects of stretching on hypertonia and ROM is required and this will be presented in chapter 3.

### **3 Chapter Three: Stretching for the Treatment and Management of Lower Limb Hypertonia in Patients with Neurological Disorders: Review of the Literature**

#### **3.1 Introduction**

Neurological disorders such as MS, spinal cord injury (SCI), stroke and cerebral palsy are frequently associated with the development of hypertonia. Hypertonia, as mentioned in the previous chapter, refers to the increased resistance apparent in a muscle with passive stretching. The impact of hypertonia for individual patients varies enormously, ranging from relatively minor effects on quality of movement, to more substantial difficulties with activities of daily living (Partridge 2002). This review will focus on the effects of stretching for the treatment of hypertonia in the plantarflexors of people with acute and chronic CNS lesions.

##### **3.1.1 Stretching as a Treatment for Hypertonia**

The implementation of stretching techniques are felt to significantly improve symptoms related to hypertonia and are often an integral part of both acute rehabilitation and the long term management of neurologically impaired patients (Hass & Crow 1995; Bovend' Eerd et al. 2008) . It is thought that stretching techniques are able to reduce muscle stiffness; increase joint ROM; prevent the development of secondary complications such as contractures; facilitate optimal positioning and comfort; and reduce pain (Singer et al. 2008; Odeen & Knutsson 1981; Odeen 1981; Tremblay et al. 1990; Tsai et al. 2001)

More recent studies in patients with stroke or spinal cord injury have used motorised devices and servomotors to implement different stretching techniques. Such techniques include: static stretching; cyclic stretching; continuous passive motion; intelligent control stretching (adjusting the applied stretching velocity according to the movement and resistance generated by both muscles and soft tissue structures); and stretching at a constant torque or a constant angle (Bressel & McNair 2002; Chung et

al. 2005; Gao et al. 2011; Nickolls et al. 2004; Selles et al. 2005; Zhang et al. 2002). Thus, there is a wide variety of different stretching techniques and mechanisms of application available.

The parameters of stretching may also vary in both clinical and research literature. The main area of focus to date has been in terms of stretch duration. A stretching duration of 30 minutes has been most frequently tested in the neurological literature, with reports of significant increases in range of movement as well as a decrease in stiffness (Chung et al. 2005; Bressel & McNair 2002). Others, however, have found that a minimum of six hours of stretching per day is required to prevent progressive soleus contracture (Tardieu et al. 1988). In contrast, the sports-medicine literature reports improvements in muscle length with repeated stretches of as little as 30-60 seconds per day in healthy participants (Bandy et al. 1997; Feland et al. 2001). Other parameters of stretching such as the intensity of forces applied have received minimal attention (Gorter et al. 2007).

It is postulated that provision of a mechanical stimulus such as stretching a muscle-tendon complex is potentially sufficient to induce tissue remodelling and muscle growth and may be able to prevent or reverse the non-neural component of hypertonia (Herbert 1988). Early studies investigating the efficacy of stretching in mice established that daily stretching prevented both the loss of in-series sarcomeres, and the increase in collagen within the connective tissue of an immobilised muscle (Williams & Goldspink 1984). It has been suggested that stretching techniques such as PNF, may further increase ROM by targeting the reflex contribution to stiffness through inhibition of the tonic stretch reflex during stretching (Yuktasir & Kaya 2009; Katalinic et al. 2012). Therefore stretching may potentially influence both the passive and reflexive components of hypertonia as well as improve ROM.

As mentioned in section 2.5.2.3 a recent Cochrane systematic review of the effectiveness of stretching for the treatment and prevention of contractures in people



with neurological conditions, concluded that stretching has no clinically important effect on joint mobility and little or no effect on pain, spasticity and activity limitations in people with neurological conditions at risk of contracture development (Katalinic et al. 2012). This review has been criticised based on the grounds that the conclusions were broad and not supported by sufficient literature (Weppler 2011).

One potential difficulty with recent reviews is the heterogeneity of studies included. Different muscle groups have been assessed in different patient groups using diverse stretching techniques. Further, the methods of evaluation have often varied from study to study. Some measures, such as the Ashworth scale measure both components of hypertonia whilst other biomechanical and electrophysiological measures have attempted to delineate these components.

This review therefore has the following aims:

1. To evaluate the effects of stretching on the ankle plantarflexors in people with acute and chronic CNS lesions
2. To review both randomised controlled clinical trials and also experimental trials
3. To separately evaluate the effects of stretching on:
  - a. Biomechanical measures of passive stiffness
  - b. Biomechanical and electrophysiological measures of spasticity
  - c. Clinical measures of hypertonia
  - d. Measures of range of motion
  - e. Measures of functional mobility
4. To compare the relative effectiveness of different types of stretches and different parameters of stretches.

## **3.2 Methods**

### **3.2.1 Search Strategy/Data Sources**

Electronic searches were conducted in the following computerised databases: Pubmed, Embase, Cumulative Index to Nursing and Allied Health Literature (Cinahl), Cochrane Database of Systematic Reviews, Cochrane Central Register of Controlled Trials, Database of Abstracts of Reviews of Effects (DARE), Health Technology Assessment Database (HTA), The Allied and Complementary Medicine Database (AMED) and Physiotherapy Evidence Database (Pedro) from 1940 to 2012. Reference lists of included articles were also assessed as well as relevant systematic reviews. Potentially relevant articles that were not available for online download were ordered from the British Library. The following search terms were used “(Stretch\*) and (ankle OR leg OR knee OR hip OR lower limb) and (Spinal cord OR multiple sclerosis OR cerebral palsy OR stroke OR head injury OR brain injury)”.

### **3.2.2 Study Selection (Inclusion/Exclusion Criteria)**

Studies were included if they were in English and either published randomised controlled trials, clinical trials or experimental or clinical cohort studies. Only studies involving humans were included, with participants of any age or gender, providing they had a confirmed neurological diagnosis and existing lower limb hypertonia. Additionally, studies were only included if they had applied a stretching intervention and assessed, at least one of the following: ROM, stiffness or spasticity. The variable had to be measured both pre and post intervention in the ankle plantarflexor muscle. Study interventions could include static stretching, positioning such as standing, cyclic stretching or continuous passive motion, or any other form of manual or passive stretching for the treatment of hypertonia. Studies had to involve patients maintaining a stretching position for a minimum of one minute and could compare different stretching interventions.

Studies were excluded if: they used co-interventions such as anti-spasticity medication, active/active assisted ROM therapy, applied electrical stimulation; applied a stretch using casting or splinting methods; were case reports, conference proceedings or protocols with no published data.

### **3.2.3 Study Evaluation: Experimental Design and Methodological Quality**

On completion of a detailed search of the named databases, and filtration of all articles that did not meet the inclusion criteria, key data was then extracted from all included articles. This information is presented in two pre-prepared forms: the experimental data extraction form (Table 3.1) and the methodological quality assessment form (Table 3.2). The experimental data extraction included information on the following: first author; date of publication; number of participants; neurological condition; study design; stretching intervention; groups; outcome measures; study results and a methodological quality score. The methodological quality assessment rated studies on nine criteria for the specific assessment of internal validity bias and confounding selection bias based on the Downs and Black checklist for the assessment of the methodological quality of randomised and non-randomised studies of health care interventions (Downs & Black 1998). The following criteria were included: randomised allocation; allocation concealment; subject blinding; assessor blinding; accurate outcome measures; appropriate statistical tests; sufficient power calculations; free of selective reporting and data dredging.

Study	Participants		Study Characteristics					Score
	No.	Condition	Study Design	Stretch Intervention	Groups	Outcome measures	Results	
<b>STROKE</b>								
<b>Gao et al, 2011</b>	Exp: 10 Con: 10	Stroke	Before and after design	Single session: 5 minutes cyclic stretching x 120 cycles lasting 1hour	N/A	- Ankle joint stiffness (Dynamometer) -Index of hysteresis (Dynamometer) -Achilles tendon length (Ultrasound) -Force output (Dynamometer)	<b>Ankle stiffness</b> pre:0.60(0.13)Nm <sup>0</sup> post: 0.49 (0.14)Nm <sup>0</sup> (p=0.0009) <b>Index of hysteresis</b> Pre: 0.37 (0.07) post: 0.33 (0.06) (p=0.0002) <b>Tendon length</b> No significant change (p=0.39) <b>Force output</b> post: 10% increase (p=0.017)	<b>4/9</b>
<b>Yeh et al, 2007</b>	Exp:47	Stroke	Before and after design	3 x 30 minutes stretching sessions; cyclic, constant angle and constant torque1 week interval between sessions	N/A	-Spasticity (Modified Ashworth Scale) -ROM (Goniometer) -Ankle joint stiffness (Dynamometer)	<b>MAS:-Constant angle</b> Pre:- 2 post 1 <b>ROM:-</b> pre:9.72 post:16:00 <b>MAS:- cyclic stretching</b> Pre:-2 post:1 <b>ROM:-</b> pre:9.56 post:14.81 <b>MAS:-Constant torque</b> Pre:- 3post 1 <b>ROM:-</b> pre:9.19 post:18.29 <b>Stiffness:-</b> reduced post stretch all protocols (p<0.001)	<b>4/9</b>
<b>Tseng et al, 2006</b>	Exp:59	Stroke	Randomized controlled trial	Passive ROM exercises 2x 10-20 minutes per day 6 days per week for 4 weeks	1.Usual care (n=17) 2.Intervention group 1 (n=21) nursing supervision of activity only 3.Intervention group 2 (n=21) nursing assistance to complete activity	-Function (FIM-ADL subscale) -Joint angle (Goniometer) -Self reported pain (VAS) -Geriatric depression scale short form (GDS-15) Motor Function (Brunnstrom stage)	<b>FIM-ADL:</b> usual care: -1.01 Group1: 0.67 Group2: 0.81 <b>ROM :</b> lower extremity usual care: -3.88° Group1: +2.14° Group2: +7.92° <b>Pain:</b> usual care: +5.41 Group1: -7.62 Group2: -10.00 <b>GDS-15:</b> usual care: +2.35 Group1: -4.76 Group2: -4.77	<b>6/9</b>
<b>Wu et al, 2006</b>	Exp: 12	Stroke	Before and after design	15 minutes dynamic repeated ankle ROM exercises in standing	N/A	-Muscle tone- MAS -Achilles tendon reflexes (5 point VAS) -Ankle clonus (6 point VAS) - Gait (TUG) -10-minute walking test -Cadence -Subjective experience influence of ankle spasticity on ambulation (VAS 0-10)	<b>MAS-</b> pre: 1.75 post: 1.08 (p<0.01) <b>Tendon reflexes</b> (p=0.083) <b>Ankle clonus</b> (p=0.081) <b>TUG-</b> pre: 33.7 post:29.1sec (p<0.01) <b>10-min walk test-</b> pre: 29.83 post: 27sec (p<0.01). Cadence increased (p<0.05) VAS-pre: 5.92 post: 4.42 (p<0.01)	<b>4/9</b>
<b>Selles et al, 2005</b>	Exp:10	Stroke	Non-controlled trial	45 minutes stretching 3 x a	N/A	-Ankle ROM (Dynamometer)	<b>Ankle ROM:</b> increase 8.6° (p=0.001)	<b>4/9</b>

Study	Participants		Study Characteristics					Score
	No.	Condition	Study Design	Stretch Intervention	Groups	Outcome measures	Results	
				week for 4 weeks		-MVC (Dynamometer) -Ankle joint stiffness (Dynamometer) -Joint viscosity (Dynamometer) -Achilles reflex (Reflex hammer) -10min walking test -Subjective experience-VAS (0-100)	<b>MVC (PF):</b> pre: 8.2 post:9.6 (p=0.028) <b>Stiffness-</b> pre: 0.22N/m post: 0.15N/m (p=0.025) <b>Joint viscosity:</b> non-significant <b>Achilles reflex:</b> non-significant <b>Walking speed-</b> pre: 0.52m/s post: 0.60m/s <b>VAS-</b> pre: 35.4 post:75.1 (p=0.021)	
<b>Chung et al, 2005</b>	Exp:12 Con:10	Stroke	Before and after design	1x 30 minutes intelligent stretching	N/A	-Achilles tendon reflex (Reflex hammer) -Ankle ROM (Dynamometer) -MVC (Dynamometer) -Stiffness (Dynamometer)	<b>Achilles Reflex:</b> non-significant <b>Ankle ROM-</b> pre: 8.12° post: 10.46° (p=0.002) <b>MVC-</b> pre: 9.87Nm post: 11.58Nm (p=0.041) <b>Stiffness-</b> pre: 0.54 post: 0.43 (Nm/deg) (p=0.007)	<b>4/9</b>
<b>Yeh et al, 2005</b>	Exp:30	Stroke	Before and after design	1x 30 minutes constant torque stretching 1x 30 minutes constant angle stretching	1.Constant torque stretching 2.Constant angle stretching	Spasticity (MAS) Passive ROM (Goniometer) Ankle Stiffness (motor driven stretches)	<b>Constant torque ROM-</b> pre: 8.73° post: 13.5° <b>MAS-</b> pre:2-4 post: 0-1 <b>Ankle stiffness:</b> significant decrease (p<0.05) <b>Constant angle ROM-</b> pre: 8.77° post: 12.57° <b>MAS-</b> pre2-3 post 1-3 (p<0.01) <b>Ankle stiffness:</b> significant decrease (p<0.05)	<b>5/9</b>
<b>Bakheit et al, 2005</b>	Exp:66 Cont:21	Stroke	Before and after design	1 x 20 minutes of either Isotonic stretch (WB), Isotonic stretch(NWM), Isokinetic stretch	1.Isotonic stretch with weight bearing 2.Isotonic stretch without weight bearing 3.Isokinetic stretch	-Spasticity (Hmax:Mmax ratio) -H reflex latency	<b>Hmax:Mmax ratio:</b> non-significant (p=0.4) <b>H reflex latency:</b> non-significant (p=0.9)	<b>5/9</b>
<b>Yeh et al, 2004</b>	Exp:25	Stroke	Before and after design	1 x 30 minutes constant torque stretching	N/A	-Spasticity (MAS) -ROM (Goniometer) -Ankle joint stiffness (motor driven stretches)	<b>MAS-</b> pre: 2-3 post:0-1 (p<0.05) <b>Rom-</b> pre:8.6° post: 12.6° (p<0.05) <b>Ankle joint stiffness-</b> decreased significantly (p<0.05)	<b>4/9</b>
<b>Bressel and McNair,</b>	Exp:10	Stroke	Within subject design	-1x 30 minutes of static stretching -1x 30 minutes of	N/A	-Gait (10 minute walk test) -Ankle stiffness (Dynamometer)	<b>Static stretching 10 minute walk test:</b> non-significant	<b>6/9</b>

Study	Participants		Study Characteristics					
	No.	Condition	Study Design	Stretch Intervention	Groups	Outcome measures	Results	Score
2002				cyclic stretching 1 week interval		-Torque relaxation (Dynamometer)	<b>Stiffness</b> :decreased by 35% <b>Torque relaxation</b> : 35% post intervention <b>Cyclic stretching</b> <b>Stiffness</b> : decreased by 30% <b>10 minute walk test</b> : non- significant <b>Torque relaxation</b> : 23% post intervention	
Zhang et al, 2002	Exp:4 Con:5	Stroke	Before and after design	1x 20 minutes intelligent stretching	N/A	-Passive ROM (Dynamometer) -Active ROM (Dynamometer) -Joint Stiffness (Dynamometer) -Achilles tendon reflex gain (Reflex Hammer) -Viscosity (Dynamometer)	<b>Passive ROM</b> : pre:11.9° post:16.5° <b>Active ROM</b> - pre: 8.8°-21.7° (pf) Post: 2°-26.9° (pf) <b>Joint stiffness</b> : reduced post stretch (significance not reported) <b>Tendon reflex</b> - pre: 11.6 cm post 2.7cm <b>Viscosity</b> : reduced post stretch (significance not reported)	3/9
Tsai et al, 2001	Exp:17	Stroke	Before and after design	1x 30 minutes of prolonged muscle stretching on tilt table	N/A	-Spasticity (MAS) -Passive ROM -(Goniometer) - Spasticity (H/M Ratio (TS) F/M Ratio(TA))	<b>MAS</b> : non-significant <b>Passive ROM</b> - pre: 15.1°: post:20.2°; post 45 mins: 16.0° (p<0.05) <b>H/M Ratio (TS)</b> - pre: 42.8%; post: 29.2%; post 45 minutes: 28.5% Significant decrease between pre and post and pre and post 45 minutes (p<0.05) <b>F/M Ratio(TA)</b> - pre: 5.4%; post: 11.8%; post 45 minutes: significant increase from pre- treatment (p<0.05). Significant increase between pre and post and pre and post 45 minutes (p<0.05)	4/9
Bohannon & Larkin , 1985	Exp:20	Transverse myelitis(n=1) Guillaine-Barre syndrome (n=1) Head injury(n=3)	Before and after	30 minutes of stretching on tilt table (Variable intervention sessions) 5-22 treatments. Average	N/A	Passive ROM (Goniometer)	<b>Passive ROM</b> : average change 3-17° statistical significance not reported	3/9

Study	Participants		Study Characteristics					Score
	No.	Condition	Study Design	Stretch Intervention	Groups	Outcome measures	Results	
		Brain hypoxia(n=1) Stroke(n=14)		of 2.3-6.4 treatments a week.				
<b>HEAD/BRAIN INJURY</b>								
<b>Singer et al, 2008</b>	Exp: 17 Con:10	Brain injury Stroke	Before and after design (Pilot)	3 minutes cyclic stretching at (5°/s and 25°/s)	N/A	Passive plantarflexor resistive torque (PPRT) (Dynamometer)	Affected limb of hemiparetic subjects showed significantly greater resistance to fast stretches compared to slow stretches (p<0.004) Significant reduction in PPRT observed in all limbs post cyclic stretching (p<0.005) (no difference between stretch velocity )	<b>3/9</b>
<b>SPINAL CORD INJURY</b>								
<b>Harvey et al, 2009</b>	Exp:20	Spinal cord injury	Randomised controlled trial	2x 10 minutes (am/pm) of passive movement 5x a week for 6 months	1.Experimental group passive stretching of ankle 2.Control group no stretch applied to opposite ankle	-Passive ankle dorsiflexion range (mechanical device) -Ankle(PF)/knee (Hamstring) spasticity (MAS) -Participant perception of change(15 point Likert scale (-7) very great deal worse (0) no change (+7) very great deal better	<b>ROM</b> Experimental: increased from 88° to 91° post intervention Control: decreased from 89° to 87°. Overall between group mean difference was 4° (p=0.002) <b>MAS</b> Not statistically significant <b>Participant perception of change</b> Experimental: 2-4 Control: 0-0	<b>8/9</b>
<b>Ben et al, 2005</b>	Exp:20	Spinal cord injury	Within subject design	1X 30 minute weight bearing stretch on tilt table/wedge 3x per week for 12 weeks	1.Experimental group weight bearing and stretch 2.Control group non weight bearing and no stretch	-Ankle mobility (ROM mechanical device) -Bone mineral density (Dual energy X-ray absorptiometry)	<b>Ankle mobility</b> Experimental ankles: decrease by 4° Control ankle: decreased by 1° . Mean effect of stretching on ankle mobility 4° (95% CI 2to6 degrees) <b>Bone mineral density</b> Experimental ankles: mean loss of 6.0% Control ankle: mean loss of 6.6%. Mean effect of standing to reduce bone loss was 0.5% (95% CI -1.8% to 2.9%) of initial values.	<b>8/9</b>

Study	Participants		Study Characteristics					Results	Score
	No.	Condition	Study Design	Stretch Intervention	Groups	Outcome measures			
							Overall treatment effect expressed as % of the loss in control leg was 9.2%.		
<b>Harvey et al, 2000</b>	Exp:14	Spinal cord injury	Randomised controlled trial Within-subject design	1x 30 minutes stretch 5-7 days a week for 4 weeks	1.Experimental group stretching randomly allocated ankle 2.Control group no stretching of opposite ankle	Ankle stiffness (slope of torque angle curve) (Mechanical device) Ankle ROM (Mechanical device)	<b>Knee extended</b> Difference between stretch and control leg from baseline to post stretch periods <b>Slope-</b> 2 weeks: -0.01 (p=0.31) 4 weeks:0.01(p=0.50) 5 weeks:0.00(p=0.24) <b>ROM-</b> 2 weeks:1° (p=0.68) 4 weeks: 0° (p=0.99) 5 weeks:0° (p=0.95) <b>Knee flexed</b> <b>Slope-</b> 2weeks: 0.00 (p=0.85) 4 weeks: 0.01 (p=0.17) 5 weeks: 0.01 (p=0.19) <b>ROM-</b> 2 weeks: 2° (p=0.13) 4 weeks: 0°(p=0.92) 5 weeks: 0° (p=0.77)	<b>8/9</b>	
<b>Kunkel et al, 1993</b>	Exp:6	Spinal cord trauma (n=4) Multiple sclerosis (n=2)	Before after design	-Progressive from 3x 10 minutes to 3x 30 minutes for 4 weeks. -Then 2x 45 minutes daily standing for 5 months	N/A	Spasticity: deep tendon reflexes (percussion hammer); muscle tone and clonus (manual testing via therapist on 0-5 VAS) H-reflexes (EMG) Fracture risk (0-4 VAS) Joint ROM (Goniometer) Hip contracture(Thomas test) Bone density (Dual photon absorptiometry)	<b>(Mean + SE)</b> <b>Lumber bone density:</b> pre – 1.26(0.12) post: 1.19(0.10) <b>Femoral neck bone density:</b> pre- 0.51(0.08) post: 0.56(0.06) <b>H-reflex</b> <b>Amplitude(mV)</b> pre: 1.78(0.28) Post: 1.93(0.32) p=0.74 <b>Latency(sec)</b> pre: 34.5(1.05) post: 35.8(0.91) p=0.37 <b>Spasticity</b> <b>Patellar reflex</b> pre:1.90(0.45) post:1.60(0.41) Ankle reflex pre: 1.20(0.32) post:1.00(0.42) <b>Muscle tone knee:</b> pre:3.20(0.36) post: 3.00(0.42) <b>Ankle clonus pre:</b> 1.00(0.57) post:1.40(0.57) Rom knee pre: 110.00(7.40) post: 114.00(9.10) Rom ankle pre: 28(3.10) post: 34(2.90) <b>Hip contracture-</b> pre:7.40(2.10) post: 4.50(0.80)	<b>3/9</b>	



Study	Participants		Study Characteristics					Score
	No.	Condition	Study Design	Stretch Intervention	Groups	Outcome measures	Results	
							<b>Fracture risk</b> Tibia- pre: 1.58(0.33) post: 1.5(0.32) p= 0.59 Fibula- pre: 1.58(0.33) post: 1.58(0.33) p=0.50 Calcaneus- pre: 2.33(0.33) post: 1.6(0.24) p=0.07	
<b>Odeen &amp; Knutsson, 1981</b>	Exp:9	Spinal cord injury	Before after design	-4x 30 minutes weight load on legs in standing with feet in DF -2x 30 minutes weight load on legs in standing with feet in PF -2x 30 minutes calf stretch in supine	N/A	Ankle stiffness (Rotational potentiometer)	% change and range <b>0.25 cycles/s</b> DF standing:-15 (+16 to -33)(p<0.001) PF standing:-11(+14 to -33) (p>0.05) DF supine: -14 (0 to -40) (p<0.01) <b>1.0 cycle/sec</b> DF standing:-32 (+10 to-70) (p<0.001) PF standing:-26(+26 to -65) (p<0.01) DF supine: -17 (+3 to -25) (p<0.001)	<b>4/9</b>
<b>MULTIPLE SCLEROSIS</b>								
<b>Baker et al, 2007</b>	Exp: 6	Multiple sclerosis	Randomised controlled single blind crossover design	1) 30 minutes daily standing for 3 weeks 2) Home exercise program including 8 exercises 5 x repetitions daily for 3 weeks.	Group A: Standing week 1-3, home exercise programme week 4-6 Group B:Home exercise programme week 1-3, Standing week 4-6.	Spasticity (Ashworth scale) Spasm(Self-reported spasm frequency scale) Passive ROM(Goniometer)	<b>Ashworth (Mean(IQR))</b> <b>Hip flexion right –</b> pre:1.5(1.0) Exercise:1.5(1.0) Standing: 1.0(2.25) <b>Hip flexion left-</b> pre: 2.0(1.0) Exercise: 2.0(2.0) Standing: 2.0(2.5) <b>Hip abduction right–</b> pre:1.0(2.0) Exercise:2.0(1.5) Standing: 2.0(1.0) <b>Hip abduction left–</b> pre:2.0(1.0) Exercise:2.0(1.0) Standing: 2.0(1.5)	<b>5/9</b>

Study	Participants		Study Characteristics					
	No.	Condition	Study Design	Stretch Intervention	Groups	Outcome measures	Results	Score
							<b>Knee flexion right–</b> pre:1.5(1.5) Exercise:1.5(1.0) Standing: 1.0(2.25) <b>Knee flexion left–</b> pre:2.0(2.0) Exercise:3.0(2.0) Standing: 1.0(0.5) <b>Ankle dorsiflexion right–</b> pre:2.0(2.0) Exercise:2.0(1.25) Standing: 1.5(1.25) <b>Ankle dorsiflexion left–</b> pre:2.0(0.5) Exercise:1.5(2.0) Standing: 1.0(0.5) <b>Penn spasm</b> <b>Spasm frequency right–</b> pre:2.0(1.7) Exercise:2.5(2.5) Standing: 1.0(3.2) <b>Spasm frequency left–</b> pre:2.0(2.2) Exercise:2.0(2.2) Standing: 2.0(3.2) <b>ROM</b> <b>Hip right–</b> pre:10(2.5IQR) Exercise:10(7.5) Standing: 0.0(5.0) p=0.038 <b>Hip left–</b> pre:20(5.5) Exercise:10(3.7) Standing: 5.0(2.5)p=0.059 <b>Ankle right–</b> pre:10(2.0) Exercise:10(1.2) Standing: 5.0(0.5) p=0.026 <b>Ankle left–</b> pre:13.5(3.5) Exercise:10(1.2) Standing: 2.5(5.5) p=0.027	
<b>CEREBRAL PALSY</b>								
<b>Cadenhead et al, 2002</b>	Exp:6	Cerebral palsy	A single subject design and 2 multiple-baseline design	Passive ROM exercises 5x 20-60 second stretches 3 x per week for hip(extension, abduction, lateral rotation), knee(extension) and ankle(dorsiflexion) joints	Phase A Group 1 n=3: receiving PROM exercises Group 2 n=3: no PROM exercises Phase B Group 1: no PROM exercises Group 2: receiving PROM exercises	Hip joint PROM Knee joint PROM Ankle joint PROM (Goniometer)	<b>Group1:</b> Showed no change in 28 out of 36 joints and a decrease in 8 joints when PROM exercises were discontinued  <b>Group 2:</b> Showed no change in 23 of 36 joints, an increase in 3 joint measurements and a decrease in 10 measurements	<b>3/9</b>

Study	Participants		Study Characteristics					Score
	No.	Condition	Study Design	Stretch Intervention	Groups	Outcome measures	Results	
							when PROM exercises were provided	
<b>Tremblay et al, 1990</b>	Exp:12 Con:10	Cerebral palsy	Before and after design	1 x 30 minutes triceps surae stretch with ankle dorsiflexed on a tilt table	Experimental:30 minutes triceps surae stretch on a tilt table Control: 30 minutes session in a seated position	Stiffness (resistive torque) (Dynamometer) Muscle activity (EMG) MVC (Dynamometer)	<b>Stiffness:</b> reduced post stretch in experimental group (p<0.01) change= -0.51 at 60°/s Significant reductions present 35 minutes later (p<0.05) <b>EMG:</b> reduced (p<0.05) at 60°/s Change =0.66(uv.s) and remained reduced 35minutes post stretch <b>MVC:</b> 7 out of 8 children in experimental group had increased activation (p<0.5) 1.67(uv.s)	<b>4/9</b>
<b>Tardieu et al, 1988</b>	Exp:10 Con:5	Cerebral palsy	Before and after design	Variable stretching times from 1hour 50 minutes to 7 hours 10 minutes per day for 7 months.	Group 1: Non-handicapped: n=5 7hours and 10 minutes of stretch per day for 7 months Group2a: CP: n=4 6 hours of stretching per day for 7 months Group 2b: CP:n=6 1hour and 50 minutes per day for 7 months	Ankle ROM (soleus) (Mechanical Device)	<b>Group1:</b> Mean range of passive muscle stretch 26.4° Pre-post measurements <4° = no contracture <b>Group2a:</b> No mean indicated. Pre-post measurements<4° = no contracture <b>Group2b:</b> No mean indicated. Pre-post measurements>4° = progressive contracture present	<b>2/9</b>

**Table 3.1:** Details of studies included in literature review

Exp- experimental group, Con-control group, PROM-passive range of movement

**Table 3.2: Methodological Quality Assessment**

Study	Randomised allocation?	Allocation concealment?	Blinding (Subjects)?	Blinding (Assessors)?	Accurate Outcome measures?	Appropriate statistical tests?	Sufficient power calculation?	Free of selective reporting?	Data Dredging?
<b>STROKE</b>									
Geo et al. 2011	N	N	N	N	Y	Y	N	Y	Y
Yeh et al. 2007	N	N	N	N	Y	Y	N	Y	Y
Tseng et al. 2006	Y	N	N	Y	Y	Y	N	Y	Y
Wu et al. 2006	N	N	N	N	Y	Y	N	Y	Y
Selles et al. 2005	N	N	N	N	Y	Y	N	Y	Y
Chung et al. 2005	N	N	N	N	Y	Y	N	Y	Y
Yeh et al. 2005	Y	N	N	N	Y	Y	N	Y	Y
Bakheit et al. 2005	Y	N	N	N	Y	Y	Y	N	Y
Yeh et al. 2004	N	N	N	N	Y	Y	N	Y	Y
Bressel and McNair. 2002	Y	N	N	N	Y	Y	Y	Y	Y
Zhang et al. 2002	N	N	N	N	Y	Y	N	N	Y
Tsai et al. 2001	N	N	N	N	Y	Y	N	Y	Y
Bohannon & Larkin . 1985	N	N	N	N	Y	N	N	Y	Y
<b>HEAD INJURY</b>									
Singer et al. 2008	N	N	N	N	Y	Y	N	N	Y
<b>SPINAL CORD INJURY</b>									
Harvey et al. 2009	Y	Y	N	Y	Y	Y	Y	Y	Y
Ben et al. 2005	Y	Y	N	Y	Y	Y	Y	Y	Y
Harvey et al. 2000	Y	Y	N	Y	Y	Y	Y	Y	Y
Kunkel et al 1993	N	N	N	N	Y	Y	N	N	Y
Odeen & Knutsson. 1981	N	N	N	N	Y	Y	N	Y	Y
<b>MULTIPLE SCLEROSIS</b>									
Baker et al, 2007	Y	N	N	Y	Y	Y	N	N	Y
<b>CEREBRAL PALSY</b>									
Cadenhead et a l, 2002	N	N	N	N	Y	N	N	N	Y
Tremblay et al, 1990	N	N	N	N	Y	Y	N	Y	Y
Tardieu et al, 1988	N	N	N	N	Y	Y	N	N	Y

### 3.2.4 Study Evaluation: Assessment of Different Stretching Effects

Studies were separately evaluated for their effects on passive stiffness, spasticity, range of motion and function. Studies that evaluated passive stiffness had to impose a stretch whose peak velocity was <7.5 °/s as past literature has shown that above this velocity stretch reflexes can be elicited in people with spasticity (Lorentzen et al. 2010). When evaluating spasticity, if several different speeds of movement / frequencies of movement were applied then the highest speed / frequency was chosen.

Where possible the data was reported in the units used and then converted into a common unit. This allowed an evaluation of the clinical relevance of any statistically significant changes reported and for comparison with the results of the studies presented in chapters 6 and 7. For range of motion the common unit was degrees; for experimental measures of passive stiffness and spasticity the common unit was Nm/deg. In many cases, due to differences in the type of outcome measures, expression of the results in a common unit could not be reported and effect sizes were evaluated.

### 3.2.5 Study Evaluation: Calculation of Effect Sizes and Meta-Analysis

Effect sizes and their 95% confidence intervals were calculated where sufficient data was presented in the article. Many studies did not have a control group and evaluated the effects of stretching in a single patient group. In these cases effect sizes were calculated as:

$$\text{Effect Size} = \frac{\text{Post stretch} - \text{pre stretch}}{\text{Baseline Standard Deviation}}$$

In studies that had an intervention (int) and a control (cont) group the effect size was calculated as:

$$\text{Effect Size} = \frac{(\text{Post stretch int} - \text{pre stretch int}) - (\text{Post stretch cont} - \text{Pre stretch cont})}{\text{Mean Baseline Standard Deviation (int+cont)}}$$

Mean values were used where possible. Where medians and inter-quartile ranges (IQR) only were reported, the mean was estimated as being half way between the IQR.

If the IQR was symmetrical around the reported median/mean, the standard deviation was estimated as:  $SD = IQR \times 1.35$  (Higgins & Green 2009) (Table 3.3). If only the range was reported then the standard deviation was estimated using the following correction factors that depended on the number of subjects included in the study:

Subject Numbers in Study	Correction Factor
2	0.0886
3	0.5908
4	0.4857
5	0.4299
6	0.3946
7	0.3698
8	0.3512
9	0.3367
10	0.3249
11	0.3152
12	0.3069
>12	0.25

**Table 3.3:** Correction factor applied to studies of different sample size to achieve an estimate of the standard deviation

Where z scores were provided the effect size was calculated as:

$$\text{Effect size} = \frac{z}{\sqrt{n}}$$

Where n= number of participants in the study.

A meta-analysis was performed where comparable data for three or more studies was available. Data were pooled in statistical meta-analysis using a random effects model

using exploratory software for confidence intervals (ESCI) (Cumming 2012). Due to software requirements only studies with sample sizes greater than six were included. Heterogeneity between studies was compared using  $I^2$ , calculated as:

$$I^2 = \frac{Q-df}{Q} \times 100\%.$$

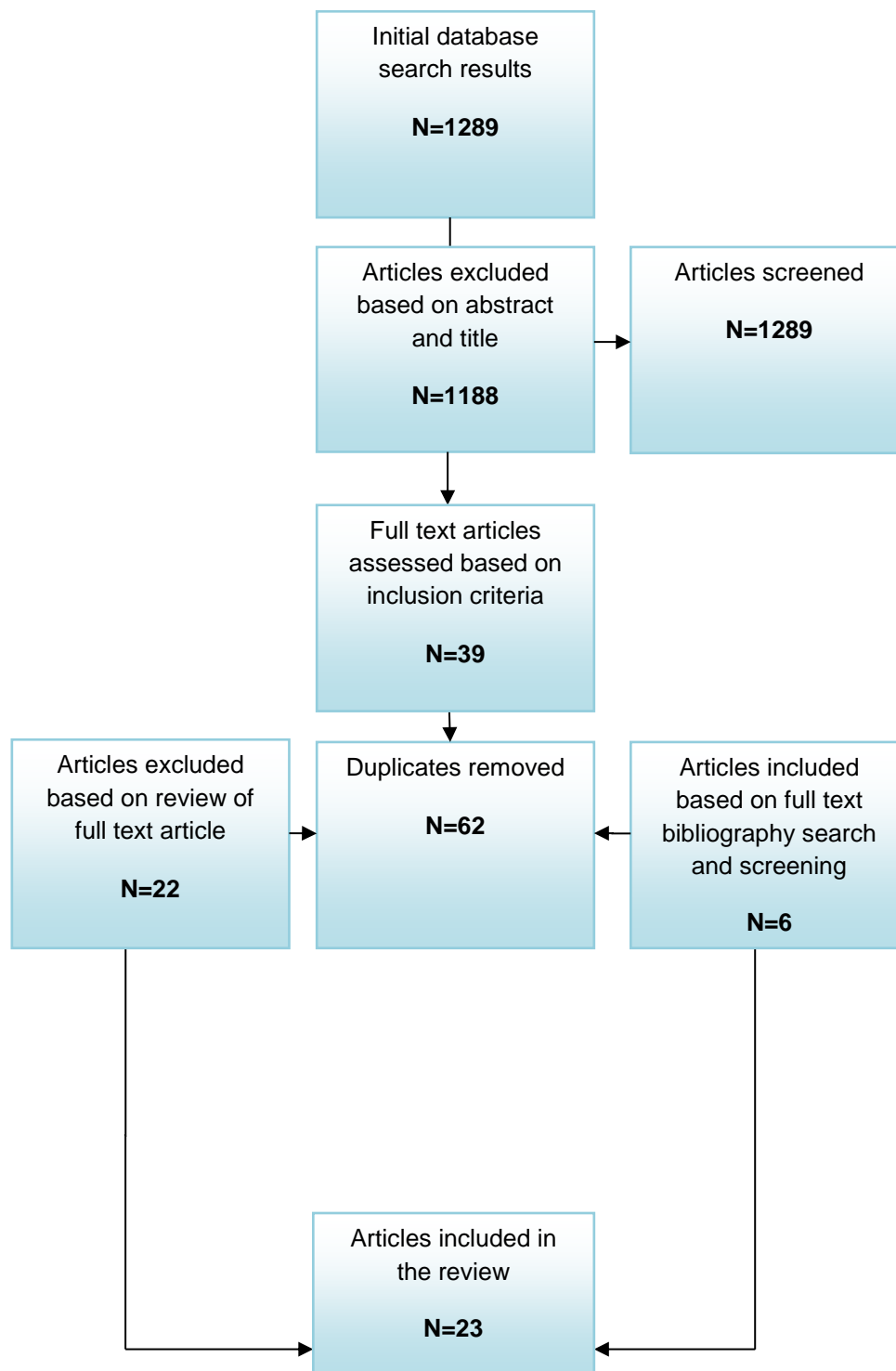
Where Q is the total weighted sum of squares between studies and df is the number of degrees of freedom (study number-1). The higher the percentage the greater the degree of heterogeneity between studies. Studies with a control group were assessed separately from studies without a control group as the use of a control group reduces potential bias. A comparison of the effects of stretching (ie pre-post stretching) was then analysed. These studies included those without control groups and data from the intervention arm of control groups. Where statistical pooling was not possible findings are presented in narrative summary form.

### **3.3 Results**

#### **3.3.1 Study Selection Process**

Based on the pre-defined search criteria a total of 1289 reference articles were initially identified. All 1289 article titles and abstracts were screened and 1188 were excluded as they did not meet the inclusion criteria. Additionally, a further 62 duplicate articles were removed, leaving 39 articles which were potentially eligible for inclusion. The full text articles for all 39 studies were inspected in detail along with the bibliography citations, leading to the exclusion of 22 articles and the inclusion of six new studies. Consequently, the literature review of stretch based interventions for the treatment and management of hypertonia included 23 articles (Figure 3.1).

## Study selection flowchart



*Figure 3.1. Flow chart of literature selection*



### **3.3.2 Study Samples**

The 23 articles included in the literature review reported experimental work in a variety of neurological conditions: 12 studies were conducted with stroke patients, five with SCI, three in cerebral palsy, one in MS, one with head injury and one article with participants of variable pathologies including stroke, head injury, brain hypoxia and transverse myelitis. In total 493 participants were assessed within the 23 studies (Table 3.1).

### **3.3.3 Main Purpose of Studies**

The majority of studies included in the review focused primarily on the effects of varied stretching paradigms on stiffness, spasticity and ROM. Other factors investigated included the effect of stretching on pain (Tseng et al. 2006), activity limitations (Tseng et al. 2006; Bressel & McNair 2002; Wu et al. 2006), depression (Tseng et al. 2006), joint/muscle flexibility (Tseng et al. 2006), stress relaxation (Bressel & P. J. McNair 2002), muscle activity (Godelieve Nuyens et al. 2002; Tremblay et al. 1990) and bone density (Ben et al. 2005; Kunkel et al. 1993).

### **3.3.4 Outcome Measures and Measurement Tools**

A variety of outcome measures were used to assess specific dependent variables. For all studies using a dynamometer, motor or mechanical driven equipment, measures of passive stiffness, spasticity, ROM, and stress relaxation were conducted using these devices. Other assessment methods used to measure spasticity included: Ashworth scale; modified Ashworth scale; Hmax:Mmax ratio; and F wave:M response ratio. Additionally, ROM in some instances was assessed with the use of a goniometer. Other variables assessed included: pain via a visual analogue scale; activity limitations using the Functional Independence Measure Activities of Daily Living sub-scale (FIM-ADL) and Brunnstrom stage; depression using the geriatric depression scale; muscle activity using EMG; bone density using dual energy x-ray absorptiometry; gait with combinations of the 10 meter timed walk test, timed up and go, and cadence; tendon reflexes using a reflex hammer; and muscle tendon length with ultrasound.

### **3.3.5 Quality of the Evidence**

Table 3.2 details the assessments undertaken of methodological quality. The risk of bias was found to be variable, with non-randomised trials scoring lowest indicating a greater risk of bias. Studies fell short, most commonly, in areas associated with subject blinding, assessor blinding, randomised allocation of participants, allocation concealment and the provision of sufficient power calculation.

Studies poor in internal validity included: (Tardieu et al. 1988), scoring two out of nine; and (Bohannon & Larkin, 1985; Cadenhead et al., 2002; Kunkel et al., 1993; Singer et al., 2008; Zhang et al., 2002) all scoring three out of nine. Studies with moderate internal validity included: (Chung et al., 2005; Gao et al., 2011; Odeen & Knutsson, 1981; Selles et al., 2005; Tremblay et al., 1990; Tsai et al., 2001; Wu et al., 2006; Yeh et al., 2004; Yeh et al., 2007) all scoring four out of nine ; (Baker, Cassidy, & Rone-Adams, 2007; Bakheit et al., 2005; Yeh et al., 2005) scoring five out of nine and (Tseng et al. 2006; Bressel & McNair 2002) scoring six out of 9. Studies high in internal validity included: (Ben et al., 2005; Harvey et al., 2000, 2009) all scoring eight out of nine.

### **3.3.6 Types of Intervention Used**

A variety of stretching interventions were implemented in the studies included in this review: it is possible to broadly subdivide these treatment interventions into two categories; static stretching and cyclic stretching. Static stretching methods were carried out in 14 of the 23 studies and applied either at a constant angle with the use of a tilt table (Ben et al., 2005; Bohannon & Larkin, 1985; Kunkel et al., 1993; Odeen & Knutsson, 1981; Tremblay et al., 1990; Tsai et al., 2001; Bakheit et al. 2005); dynamometer or mechanical device (Yeh et al., 2004,2005,2007; Harvey 2000; Tardieu et al. 1988; Bressel & McNair 2002) or with the application of a constant force using a motorised device. Cyclic stretching interventions were implemented in 9 studies and applied either manually by a therapist (Tseng et al. 2006; Cadenhead et al. 2002;

Harvey et al. 2009), via intelligent control using a motor (Gao et al. 2011; Chung et al. 2005; Selles et al. 2005; Zhang et al. 2002) or with a standard dynamometer or mechanical device (Singer et al. 2008; Wu et al. 2006).

### **3.3.7 Stretch Dosage**

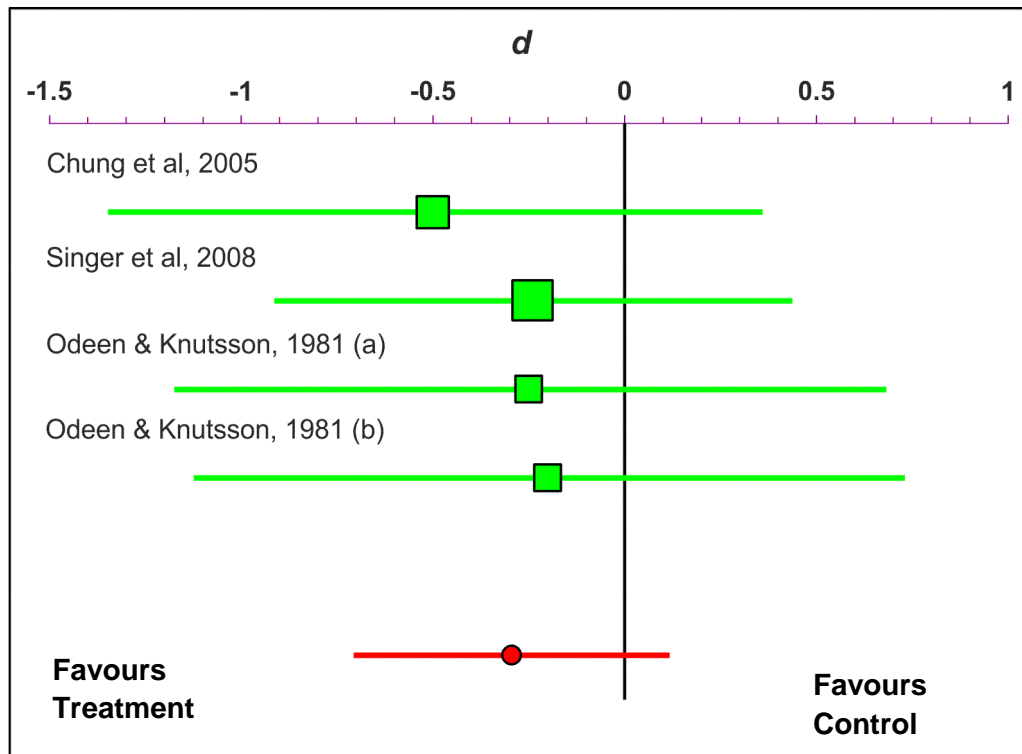
Stretch duration ranged from 60 seconds to 7 hours per day; durations of 30 minutes was used in 13 of the 23 studies. Stretch frequency varied from a single session to between three to seven days per week for a minimum of three weeks to a maximum of seven months. A single session for 30 minutes duration was the most commonly used stretching protocol.

## **3.4 Meta-Analysis**

### **3.4.1 Effects of Stretch on Passive Stiffness**

#### ***3.4.1.1 Studies with a control group:***

The three studies included in this analysis showed minimal variability ( $Q = 0.29$ ;  $I^2 = 0.0\%$ ) (Chung et al. 2005; Singer et al. 2008; Odeen & Knutsson 1981). The forest plot shown in Figure 3.2 indicates that although a decrease in passive stiffness favours treatment (Overall effect size:  $-0.295$ ); (CI  $-0.706$  to  $0.117$ ) overlaps zero in all instances. Differences in the units used to measure passive stiffness prevented mean differences being described except for Chung et al, 2005 (Table 3.4)



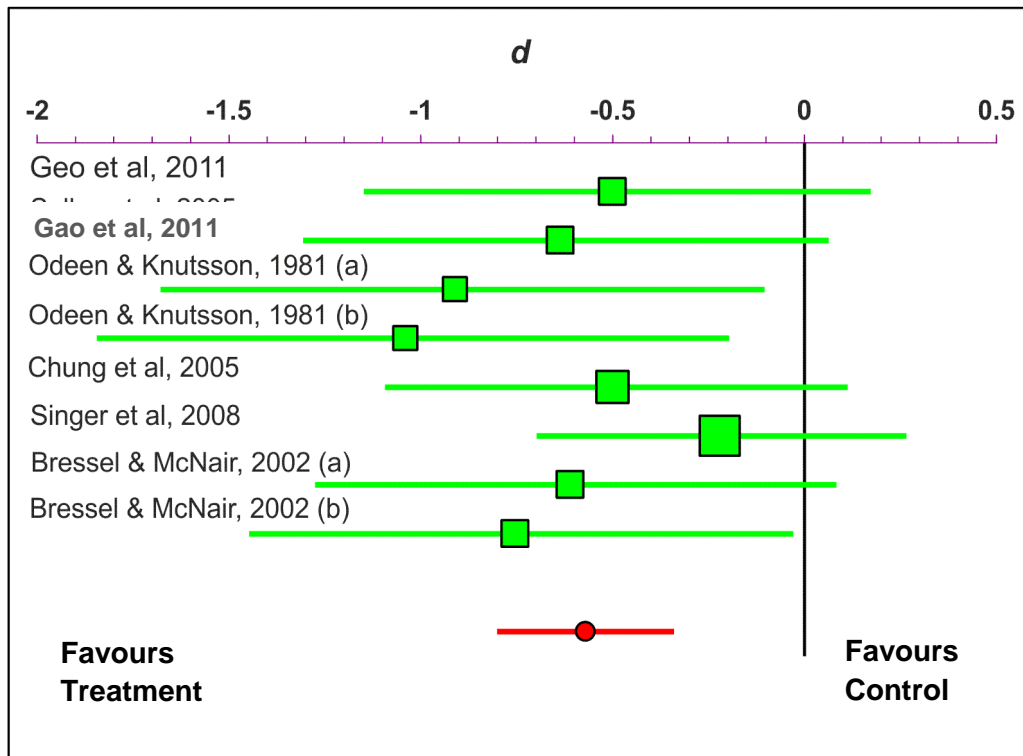
**Figure 3.2.** Forest plot showing 95% confidence intervals (CI) for the effect of: intelligent stretching (Chung et al. 2005); cyclic stretching (Singer et al. 2008); tilt table standing with ankle dorsiflexion versus tilt table standing in ankle plantarflexion (Odeen & Knutsson 1981 (a)); supine ankle dorsiflexion stretch versus tilt table standing with ankle dorsiflexion (Odeen & Knutsson 1981(b)) on passive stiffness; all studies had a control group.

Study	Experimental Group 1		Experimental Group 2		Control	
	Baseline	Post	Baseline	Post	Baseline	Post
Chung et al, 2005 (mean+/-SD) (Nm/deg)	0.54 +/- 0.25	0.43 +/- 0.19	NA		0.37 +/- 0.23	0.38 +/- 0.23
Singer et al, 2008 (mean+/-SD) (Nm)	9 +/- 4.5	8 +/- 4.5	6 +/- 3.0	5.9 +/- 3.0	7.9 +/- 4.5	7 +/- 4.5
Odeen & Knutsson, 1981 (mean % change+/-SD) (Nm)	-15+/- 16.49		-14+/- 13.47		-11+/- 15.8	

**Table 3.4.** Experimental data results for control studies investigating the effects of stretching on passive stiffness.

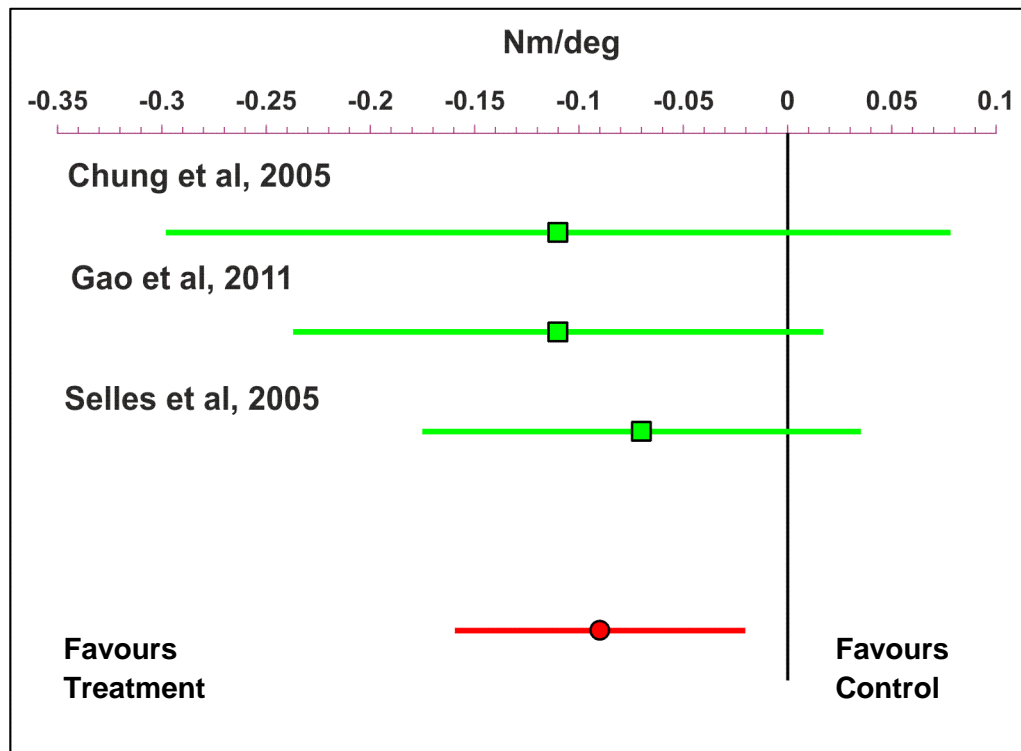
#### 3.4.1.2 Pre-Post Intervention comparison

Six studies including two that compared two different stretching interventions were included in this analysis resulting in eight comparisons. There was minimal variability ( $Q=4.46$   $I^2=0.0\%$ ) among the included studies. The forest plot is shown in Figure 3.3, indicating an effect that favors treatment in reducing passive stiffness (Overall effect size: -0.559); ( CI -0.778 to -0.331).



**Figure 3.3.** Forest plot showing 95% confidence intervals (CI) for the effect of: cyclic stretching (Gao et al. 2011; Singer et al. 2008; Bressel & McNair 2002 (a)); intelligent stretching (Chung et al. 2005; Selles et al. 2005); tilt table standing with ankle dorsiflexion versus tilt table standing in ankle plantarflexion (Odeen & Knutsson 1981 (a)); supine ankle dorsiflexion stretch versus tilt table standing with ankle dorsiflexion (Odeen & Knutsson 1981(b)); stretching at a constant angle (Bressel & McNair 2002 (b)) on passive stiffness.

In three studies passive stiffness was measured in  $\text{Nm}^\circ$  (Chung et al. 2005; Gao et al. 2011; Selles et al. 2005). A combined mean difference of  $-0.09\text{Nm}^\circ$  (CI  $-0.05$  to  $-0.14$ ) was observed with stretching (Figure 3.4).

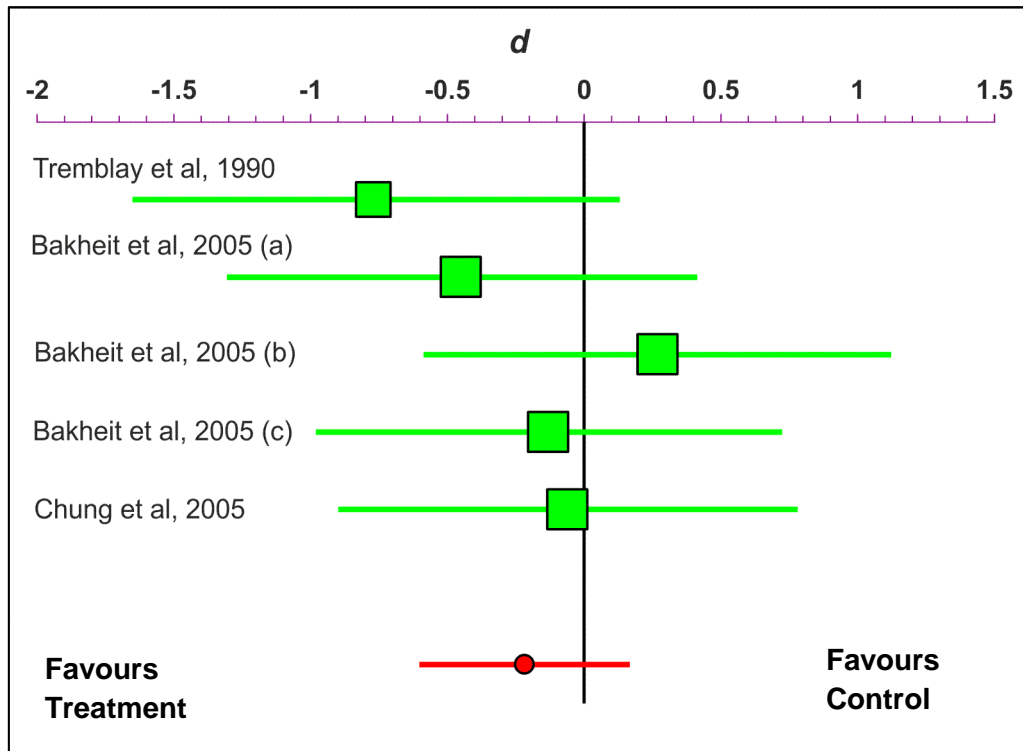


**Figure 3.4.** Forest plot showing change in passive stiffness in  $Nm^{\circ}$  and the 95% confidence intervals (CI) for the effect of: intelligent stretching (Chung et al. 2005; Selles et al. 2005) and cyclic stretching (Gao et al. 2011) interventions.

### 3.4.2 Effects of Stretch on Spasticity: Biomechanical and Electrophysiological Measures

#### 3.4.2.1 Studies with a control group:

Three studies investigated the effects of stretching on spasticity (Tremblay et al. 1990; Bakheit et al. 2005; Chung et al. 2005). One compared three different stretching interventions in both stroke participants and a control group; giving a total of five comparisons. The studies showed minimal variability ( $Q = 3.20$ ;  $I^2 = 0.0\%$ ). The forest plot is shown in Figure 3.5, once again indicating an effect that favours treatment for reducing spasticity (overall effect size:  $-0.218$ ); (CI  $-0.601$  to  $0.166$ ) overlaps zero. Differences in the units used to measure spasticity prevented mean differences being described expect for Chung et al, 2005 (Table 3.5).



**Figure 3.5.** Forest plot showing 95% confidence intervals (CI) for the effect of: constant angle stretch on a tilt table (Tremblay et al. 1990); cyclic stretching (Bakheit et al. 2005 (a)); isotonic non-weight bearing (Bakheit et al. 2005 (b)); isotonic weight bearing (Bakheit et al. 2005 (c)) and intelligent control stretching (Chung et al. 2005); on spasticity. All studies had a control group.

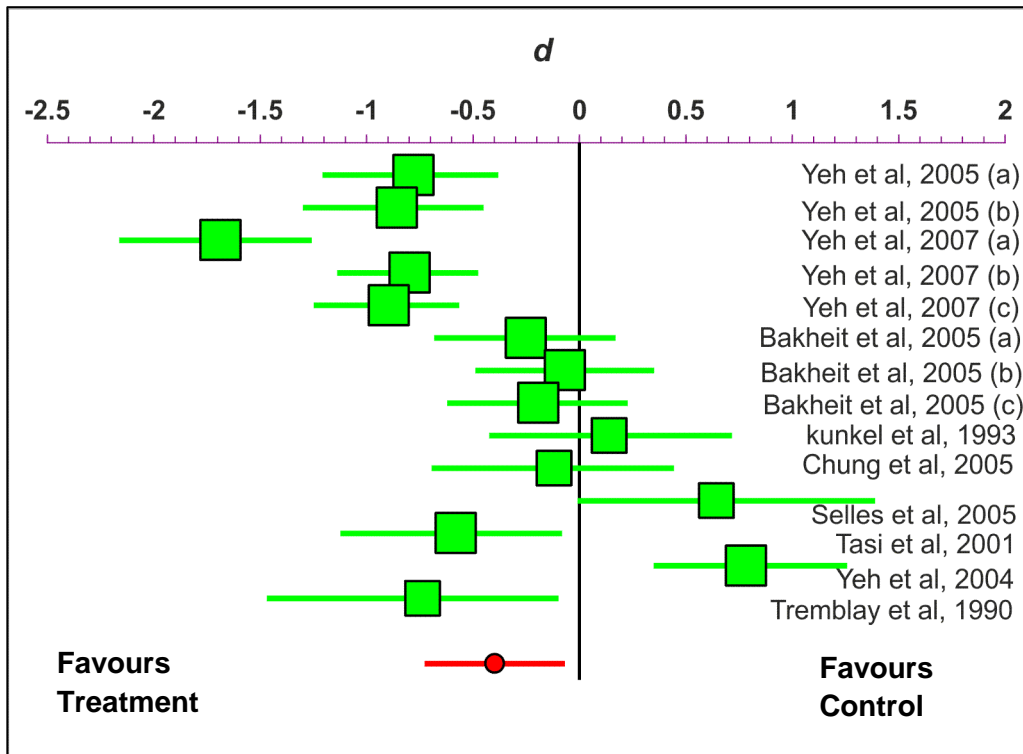


Study	Experimental Group 1		Control	
	Baseline	Post	Baseline	Post
Tremblay et al, 1990 (mean +/- SD)(Nm/rad)	-0.67 (+/- 0.84)		-0.12(+/- 0.58)	
Bakheit et al, 2005 (a) (mean +/- SD) (H:M)	0.66(+/-0.27)	0.59(+/-0.25)	0.37(+/-0.13)	0.39(+/-0.11)
Bakheit et al, 2005 (b) (mean +/- SD)(H:M)	0.46(+/- 0.14)	0.45(+/-0.15)	0.41(+/-0.08)	0.37(+/-0.1)
Bakheit et al, 2005 (c) (mean +/- SD)(H:M)	0.58(+/-0.25)	0.53(+/-0.22)	0.41(+/-0.21)	0.39(+/-0.2)
Chung et al, 2005 (mean+SD) (Nm/deg)	4.41(+/-2.97)	4.03(+/-2.93)	2.93(+/-1.59)	2.69(+/-1.53)

**Table 3.5.** Experimental data results for control studies investigating the effects of stretching on spasticity.

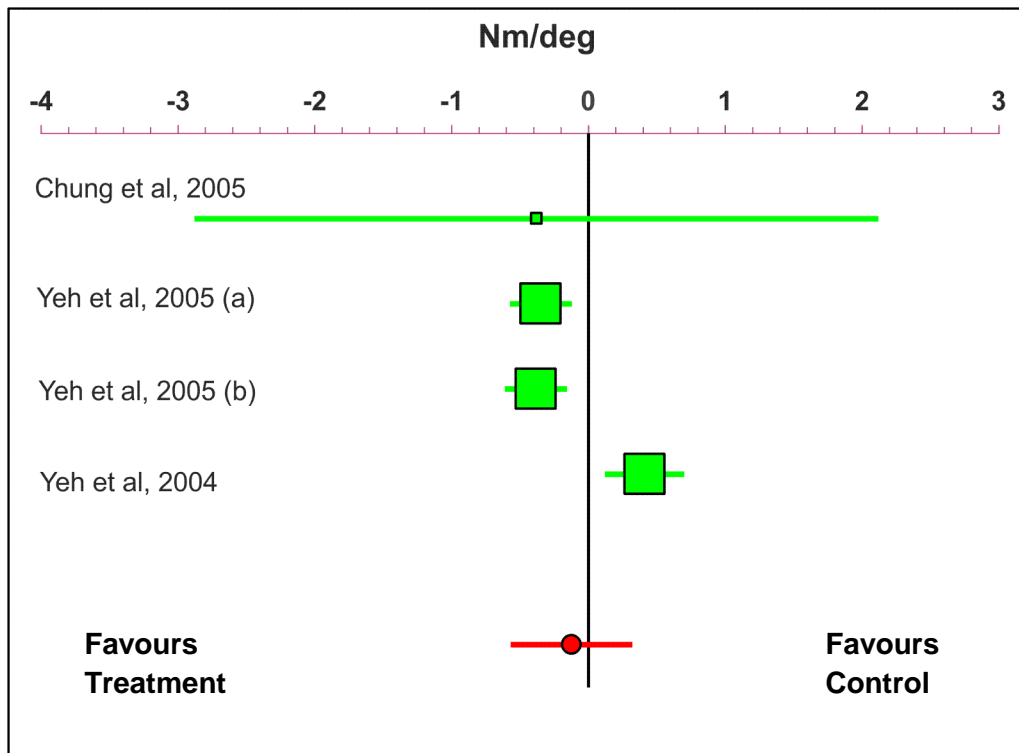
#### 3.4.2.2 Pre-post Intervention Comparison

Nine studies were included in the following analysis, of which two compared three different stretching interventions and one compared two different stretching techniques; giving a total of 14 comparisons. The studies were heterogeneous ( $Q=102.8$   $I^2=87.4\%$ ) in nature. The results of the meta-analysis are displayed on the forest plot in Figure 3.6. This indicates an effect that favours treatment on reducing spasticity (overall effect:  $-0.398$ );( CI  $-0.726$  to  $-0.070$ ).



**Figure 3.6.** Forest plot showing 95% confidence intervals (CI) for the effects of: constant angle and constant torque stretching (Tsai et al, 2001; Yeh et al, 2004; Yeh et al, 2005 (a)/(b); Yeh et al 2007 (a)/(c)); constant angle stretch on a tilt table (Tremblay et al. 1990); cyclic (Yeh et al, 2007 (b)); (Bakheit et al. 2005 (a)); isotonic non-weight bearing stretches (Bakheit et al. 2005 (b)); Isotonic weight bearing stretches (Bakheit et al. 2005 (c)); standing (Kunkel et al, 1993) and intelligent control stretching (Chung et al. 2005; Selles et al, 2005) on spasticity in studies with no control groups.

In three studies spasticity was measured in  $\text{Nm}^\circ$  or  $\text{Nm}/\text{rad}$  and so could be converted to common units. These showed a combined overall effect of  $-0.124\text{Nm}^\circ$ ; CI-0.768 to 0.319 with stretching and a mean difference of  $-0.18 \text{Nm}^\circ$  (CI 0.59 TO -0.94) (Figure 3.7).



**Figure 3.7.** Forest plot showing 95% confidence intervals (CI) for the effects of: constant angle and constant torque stretching (Yeh et al, 2004; Yeh et al, 2005 (a)/(b); and intelligent control stretching (Chung et al. 2005) on spasticity.

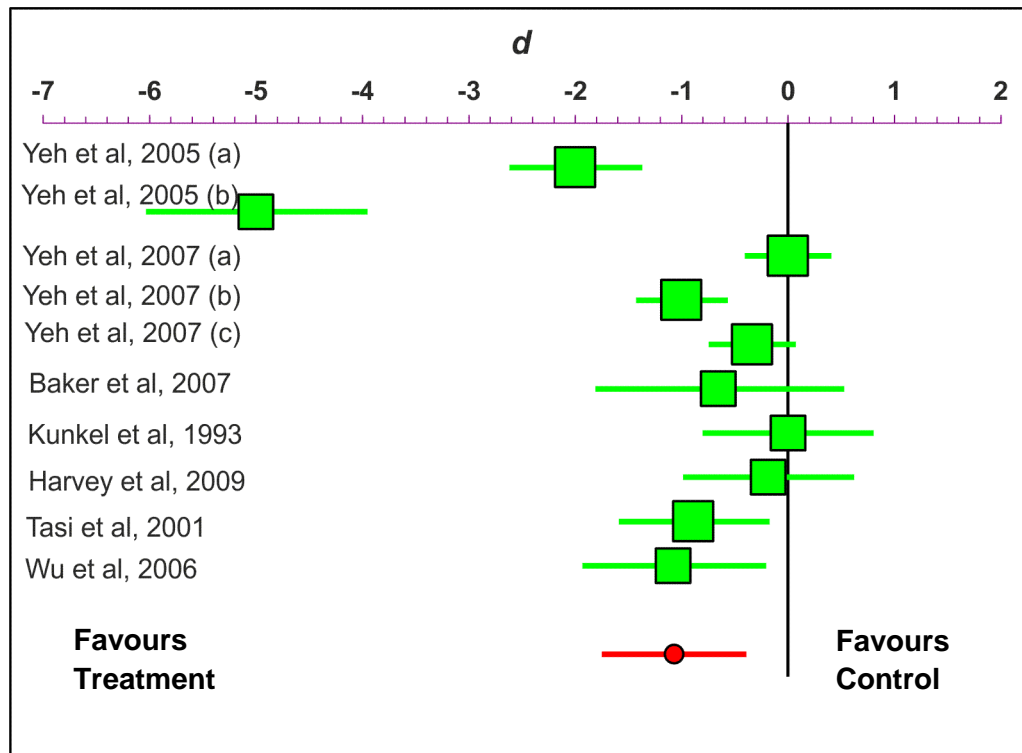
### 3.4.3 Effects of Stretch on Spasticity: Clinical Measures

#### 3.4.3.1 Studies with Control Group:

Two studies compared the effects of stretching on spasticity as measured using the Modified Ashworth scale. Baker et al (2007) had an effect size of -0.656 (CI -1.8 to 0.53) and Harvey et al 2009 had an effects size of -0.19 (CI -0.99 to 0.62), both demonstrating a reduction in spasticity with the stretching intervention.

#### 3.4.3.2 Pre-post Intervention Comparison

Seven studies were included of which one compared three different types of stretches and one compared two types of stretches; giving a total of 10 comparisons. The studies were heterogeneous ( $Q=105.79$   $I^2=91.5\%$ ). The forest plot is shown in Figure 3.8 indicating an effect that favours treatment in reducing spasticity (overall effect size: 1.072; CI -1.748 to -0.395).

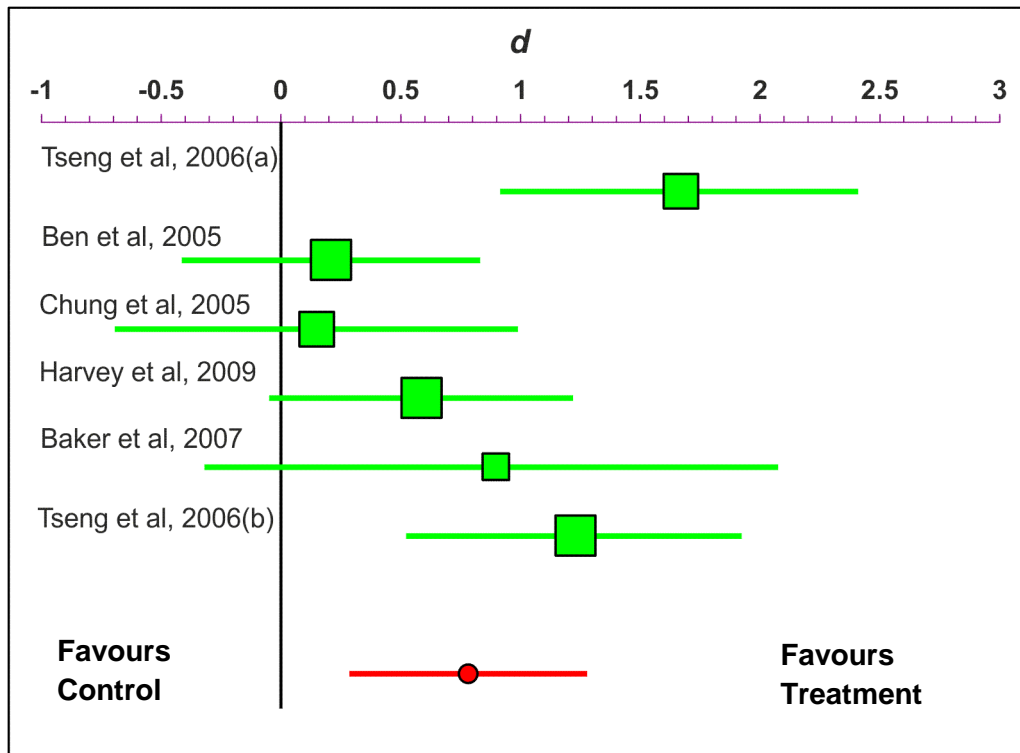


**Figure 3.8.** Forest plot showing 95% confidence intervals (CI) for the effects of: constant angle and constant torque stretching (Tsai et al, 2001; Yeh et al, 2005 (a)/(b); Yeh et al 2007 (a)/(c)); cyclic (Wu et al, 2006; Yeh et al, 2007 (b); Harvey et al, 2009); and standing ( Baker et al, 2007; Kunkel et al, 1993) on spasticity in studies with no control groups.

### 3.4.4 Effects of Stretch on Range of Movement

#### 3.4.4.1 Studies with Control Group:

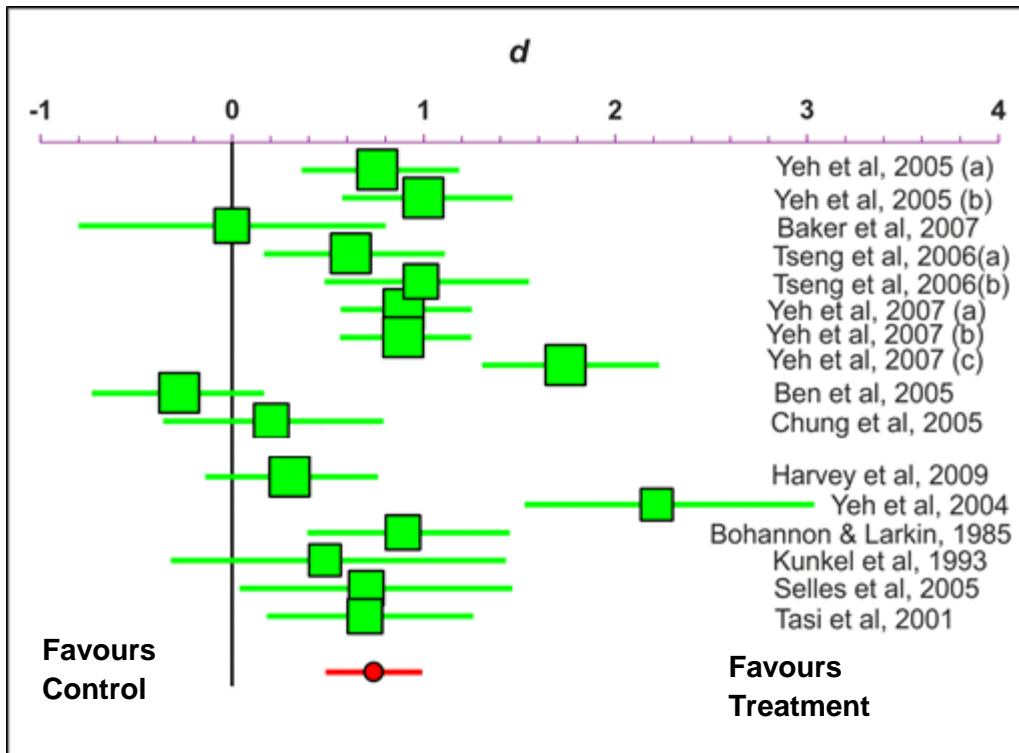
Six studies compared the effects of stretching on range of movement. The studies showed heterogeneity ( $Q = 12.91$ ;  $I^2 = 61.3\%$ ). The forest plot is shown in Figure 3.9. The overall effect size for this group of studies was 0.782 with a 95% CI ranging from (CI 0.286 to 1.277), demonstrating an effect in favour of stretching for increasing ROM.



**Figure 3.9.** Forest plot showing 95% confidence intervals (CI) for the effects of: ROM exercises (Tseng et al 2006 (a)/(b)); cyclic (Harvey et al, 2009); intelligent control stretching (Chung et al. 2005); standing (Ben et al, 2005; Baker et al, 2007); stretching on ROM in studies with a control group.

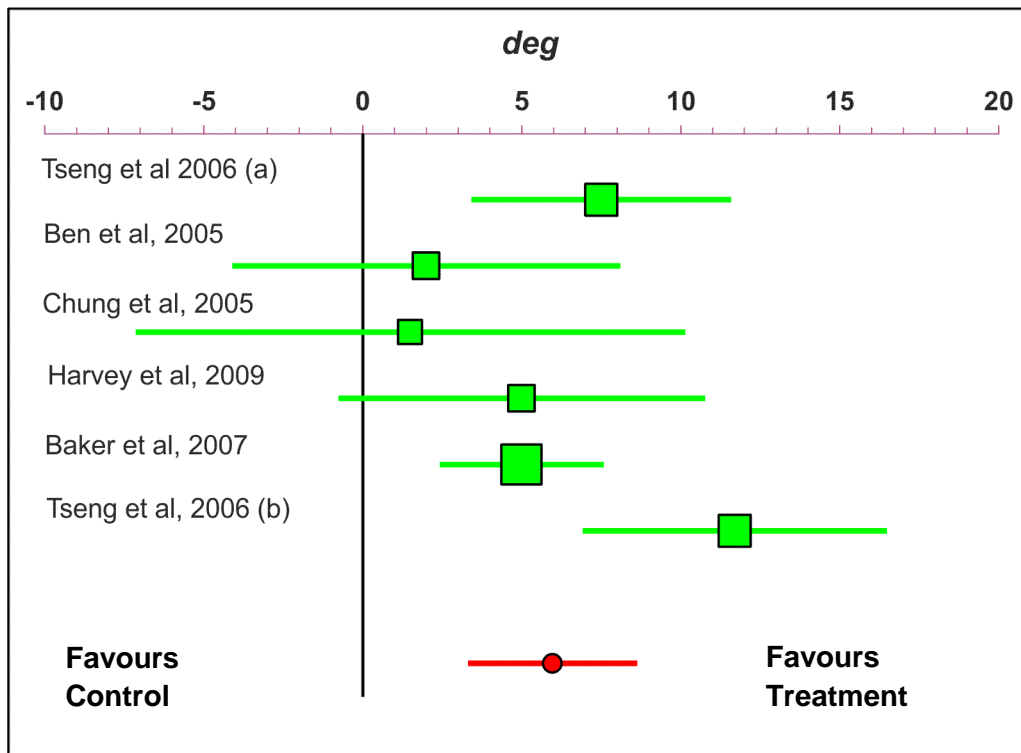
#### 3.4.4.2 Pre-post Intervention Comparison

Twelve studies were included of which one compared three different types of stretches and two compared two types of stretches; giving a total of 16 comparisons. The studies were heterogeneous ( $Q=74.02$   $I^2=79.7\%$ ). The forest plot is shown in Figure 3.10 indicating an effect that favours treatment on increasing ROM (overall effect size: 0.75; CI 0.487, 1.016).



**Figure 3.10.** Forest plot showing 95% confidence intervals (CI) for the effects of: constant angle and constant torque stretching (Tsai et al, 2001; Yeh et al, 2004; Yeh et al, 2005 (a)/(b); Yeh et al 2007 (a)/(c); cyclic stretching (Yeh et al, 2007 (b); Harvey et al, 2009); intelligent control stretching (Chung et al. 2005; Selles et al, 2005); ROM exercises (Tseng et al 2006 (a)/(b)) and standing (Bohannon & Larkin, 1985; Ben et al, 2005; Baker et al, 2007; Kunkel et al, 1993) on ROM in studies with no control group.

All studies measured ROM in degrees. When studies comparing intervention with a control group were compared the overall mean difference was 5.97° (CI 3.3 to 8.62) favouring stretching (Figure 3.11). When studies without a control group were compared the mean difference was 5° (CI 9.65 to 0.28).



**Figure 3.11.** Forest plot showing 95% confidence intervals (CI) and mean difference in ROM in studies with a control group: ROM exercises (Tseng et al 2006 (a)/(b)); cyclic stretching (Harvey et al, 2009); intelligent control stretching (Chung et al. 2005) and standing (Ben et al, 2005; Baker et al, 2007). ROM increase over the control group is indicated.

### 3.4.5 Effects of Stretch on Functional Mobility

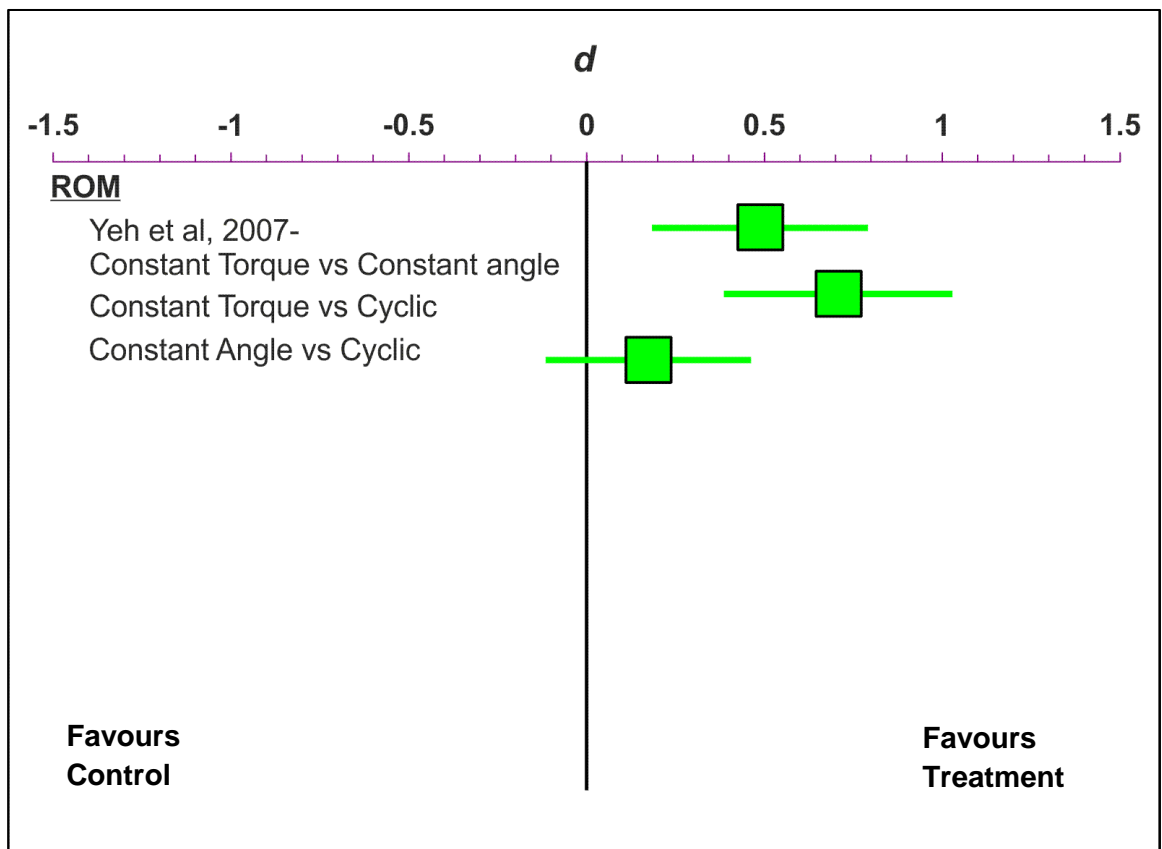
In some of the papers that met the inclusion criteria the effects of stretching on functional ability were also reported. In these papers functional ability was assessed using the FIM ADL scale, TUG, and the cadence and 10 meter timed walk. Bressel & McNair (2002) reported no significant improvements in the 10 meter timed walk test with the application of a single session of 30 minutes static or cyclic stretching. However, Wu et al. (2006) reported a significant increase in the TUG ( $p < 0.01$ ), 10 meter timed walk ( $p < 0.01$ ) and cadence ( $p < 0.05$ ) following 15 minutes of dynamic repeated ankle ROM exercises in a standing position. Similarly, Selles et al (2005) reported a significant increase in comfortable walking speed from 0.52(m/sec) to 0.60(m/sec) after 45 minutes of stretching three times a week for four weeks (Selles et

al. 2005).

### 3.4.6 Comparing Different Stretching Interventions

Two studies compared different stretching interventions. Yeh et al (2007) compared the application of a constant torque, constant angle and cyclic stretching. Bressel and McNair (2002) compared constant angle and cyclic stretching.

The stretching intervention implemented with a constant torque was shown to be more effective at increasing ROM and decreasing spasticity when compared to constant angle and cyclic interventions ( $p < 0.001$ ) (Yeh et al, 2007, Figure 3.12a). No significant difference was found between constant angle and cyclic stretching treatments ( $p = 0.071$ , Figure 3.12a).



**Figure 3.12a.** Comparing the treatment effect of: constant torque, constant angle and cyclic stretches on ROM (Yeh et al, 2007). More positive values indicate a greater increase in ROM with constant torque treatment being the most favourable.



No statistically significant difference in the change in passive stiffness was found between a constant angle and cyclic stretch (Bressel & McNair 2002, Figure 3.12b).



**Figure 3.12b.** Comparing the treatment effect of: constant angle and cyclic stretches on passive stiffness (Bressel & McNair, 2002). More negative values indicate a greater reduction in passive stiffness. Constant angle stretching was the more favourable of the two treatment options.

There was a significant reduction in spasticity that was greater with a constant angle stretch compared to a cyclic stretch. A constant torque stretch produced a greater reduction in spasticity compared to both a constant angle and cyclic stretch (Yeh et al 2007, Figure 3.12c)



### **3.5 Discussion**

There has been recent speculation in clinical practise regarding the on-going implementation of stretching regimes for patients with hypertonia secondary to a neurological insult. It is evident that this uncertainty has, in part, stemmed from a recent systematic review which broadly concludes that stretching interventions are ineffective for the treatment and prevention of contractures and spasticity (Katalinic et al. 2012). As discussed in chapter one section 2.5.2.3 this review has potential flaws and may have overlooked some key issues; therefore the purpose of this literature review was to ascertain the efficacy of stretching interventions for the treatment and or management of ankle plantarflexor hypertonia in people with neurological disorders.

In response to criticisms of previous reviews that only included randomised controlled trials (Weppeler 2011) the current review additionally included experimental trials with no control group. As can be seen from the forest plots and meta-analysis these trials demonstrated larger effects sizes with 95% confidence intervals that tended to favour treatment compared to studies that used a control group. The higher effect size with non-controlled trials has been reported previously and reflects potential bias effects that can affect serial measures, such as fatigue, and an outcome measurement practice effect (Wang & Bakhai 2006). Although fatigue could be a compounding factor in the studies reviewed, many of the outcome measures use perturbations/ passive movements and electrical stimulation to assess passive stiffness, spasticity and ROM. In these cases the participant was essentially passive suggesting that there would be little opportunity for participant-driven practice effects as could be seen, for example, in some measures of gross function such as walking speed or timed up and go.

The lack of a control group does not always reflect poor experimental methodology. Some of the studies were specifically designed to compare the effects of different types of stretching in the same patient population. In these cases there was not a true control group but rather different comparator groups. The findings of the review undertaken for

this thesis are broadly in agreement with previous reviews (Katalinic et al. 2012). It is acknowledged that this thesis review was only conducted by one person and therefore there was potential for bias in the articles chosen compared to one undertaken using Cochrane criteria (Higgins & Green 2009).

### **3.5.1 Effects on ROM:**

When both controlled and uncontrolled trials were assessed there was an effect size that favoured treatment in increasing ROM with 95% confidence intervals that did not overlap zero. Therefore, it can be concluded that stretching can improve ROM. As highlighted by Katalinic's review the question then remains as to whether this statistically significant improvement is clinically useful (Katalinic et al. 2012). Katalinic et al 2009 chose 5° as their cut off for a minimally significant clinical difference. In this current review the size of the effect was 5.97° (95% CI 3.3 ° to 8.62 °) when the controlled trials were assessed and, as the lower 95% CI goes down to 3.3 °, one could argue that the effects of stretching on ROM are inconclusive. However, it remains unclear what does constitute a minimally significant clinical difference. This could potentially vary depending on the part of the range that is gained and the function of the participant. For instance, a 3.3 ° improvement that allows a person to achieve plantargrade with their ankles at 90 ° could be highly clinically significant as this would in turn affect the posture of more proximal joints and potentially aid transfers. Similarly, an improvement from 0-3 ° ankle dorsiflexion in an ambulant participant could significantly reduce the risk of tripping while walking. An important proviso here is that the person would have to either actively control that range or use aids such as functional electrical stimulation to "access" the newly gained range. In summary, this review concludes that ROM can be significantly improved with stretching and that, as well as trying to optimise these effects; future work should be directed towards understanding the clinical utility of these improvements.

### **3.5.2 Passive Stiffness and Spasticity:**

When relying on only controlled trials to assess the effects of stretching on passive stiffness and spasticity (as measured using biomechanical, electrophysiological and clinical measures) the effect size was smaller and overlapped zero compared to non-controlled trials. In light of this the conclusion at present is that the effects of stretching on passive stiffness and spasticity are inconclusive.

One reason for a lack of a conclusive improvement with stretching could be that this intervention is ineffective in reducing stiffness and spasticity. Another reason, however, could be due to the variable stretching parameters used in the studies. For instance, from the studies described to date there is evidence that a constant torque stretch is more effective than stretching at a constant angle or cyclic stretching. For the most promising of these stretches, a constant torque stretch, it is unclear what the optimal torque is or what is the optimal duration of stretching. Variation in the level of torque applied throughout the stretch may also impact on effectiveness. In the study by Yeh et al (2007) stretching force was shown to gradually decrease over the duration of a 30 minute treatment session by 46.57 +/- 4.79% (mean +/- SD) and by 36.82 +/- 2.25% with application of a stretch at a constant angle and cyclic stretching respectively. It is possible that the decrease in the applied force affected the efficiency of both these interventions. Looking into the effect of these parameters will be the main aim of the thesis.

Inconclusive findings about the effectiveness of stretching in reducing passive and stretch reflex mediated stiffness could also reflect variability in the outcome measures used to quantify these parameters. Changes in spasticity were measured using a variety of techniques including clinical and laboratory measurement tools. However, in most instances the modified Ashworth scale was used to characterise changes with an intervention. Significant reductions in spasticity as measured by the modified Ashworth scale were reported in four studies (Wu et al., 2006; Yeh et al., 2004; Yeh et al., 2007, 2005). Contrary, to these findings both Baker et al (2007) and Harvey et al,

(2009) observed no significant changes in spasticity with this measurement tool. Interpretation of these findings is however problematic due to the number of recognised flaws of the modified Ashworth scale with regard to its validity, reliability and responsiveness (refer to Section 2.4.1.1.) Additionally, clinical enhancements of muscle tone in spastic paretic patients have been observed at night (Odeen, 1981) questioning the efficacy of interventions during the day when patients are most active; and it is speculated that degree of activity is correlated to a reduction in hypertonus (Odeen, 1981).

Seven of the studies included in the review reported that stretching had no significant effect on clonus, Achilles and knee tendon reflexes, H-reflex amplitude and latency and spasm frequency (Baker, Cassidy, & Rone-Adams, 2007; Bakheit et al., 2005; Chung et al., 2005; Kunkel et al., 1993; Selles et al., 2005; Wu et al., 2006; Zhang et al., 2002). Contrary to the above, Tasi et al. (2001) observed significant change in Fwave:Mwave response ratio and Hmax:Mmax ratio following their constant angle stretching protocols. Additionally, Trembley et al (1990) demonstrated significant reductions in EMG activity in the plantarflexors following 30 minutes of stretching on a tilt table. Spasticity can be very variable and it is thought that EMG signals from different measurement sessions can often demonstrate inconsistency (Cadenhead et al., 2002; Odeen, 1981; Selles et al., 2005). In addition, it has been postulated that test repetitions may complicate the assessment of hypertonia (Nuyens et al. 2001). This thesis will measure spasticity by imposing stereotyped stretches using a motor and measuring the mechanical response and the EMG response. This method has the advantage that it can measure stretch-evoked stiffness in the same units as passive stiffness and gives a direct indication of the opposing torque that can limit functional movements (Wood et al. 2005).

Passive stiffness can also be difficult to measure and perhaps because of this few studies in MS have investigated this as an outcome measure for stretching interventions. The use of a motor allows the stiffness of the whole muscle-tendon complex to be measured. However, following neurological lesion differential changes in the muscle and tendon can occur. For example, following a stroke the gastrocnemius muscle body has reported to become short and stiff and the tendon longer and more compliant ( Gao & Zhang, 2008; Zhao et al. 2009). Stretching may have differential effects on the muscle and tendon depending on the degree of underlying stiffness (Abellaneda et al. 2009). Therefore, techniques to measure muscle fibre stiffness and tendon stiffness directly may be more sensitive at revealing changes with stretching compared to gross measures of the muscle-tendon stiffness. Recently, ultrasonography has been used to measure muscle and tendon stiffness directly (Zhao et al. 2009; Kubo et al. 2002) and this method will be used to explore differences between healthy controls and pwMS and the effects of stretching in chapter 8.

### **3.5.3 Summary**

Although previous research and reviews show many areas of agreement, disparity and inconsistencies of findings are present. It is evident that there is still a great deal that is unknown and requires further research. Some important questions that have to be addressed include; what is the goal directed aim of stretching? Is the main purpose of stretch to facilitate functional training by temporarily inhibiting restrictive spastic hypertonia? If so the literature lends inconclusive support. Secondly, what is a worthwhile treatment effect? While it has been reported that anything below 5° of increase in range is not considered worthwhile; this is arguable. It is also not yet known if the therapeutic effects of stretching accumulate over time or if they are dose related. Similarly, it is not clear what time of day is most effective for stretching or at what stage of the disease course stretching should be implemented; is it better to stretch early on at disease onset or at a later stage for the purpose of treatment or management? Additionally, research on the long term effects of stretching is minimal and therefore

requires investigating. Although there is still a lot that is unknown, it is clear from the literature reviewed that stretching does have the potential to improve ROM. Further work is required to define the parameters of plantarflexor stretches that will provide the optimal improvements in passive stiffness and spasticity and ultimately functional walking.

#### **3.5.4 Thesis Justification, Aims and Structure**

To date there is evidence that a constant torque stretch produces greater improvements in passive stiffness, spasticity and ROM compared to constant angle and cyclic stretches. However, it is unclear, during a constant torque stretch, what the optimal applied torque or duration of stretch actually is. This thesis therefore aims to assess the effects of different torques applied over different durations on passive stiffness, spasticity and ROM. In keeping with past study designs that have compared different types of stretches, a repeated measures design will be used where the same participants are seen on different sessions and where in each session a different torque is applied for a set duration. This design does not allow for the long term effects of stretching at a particular torque to be assessed. However, monitoring stretch-induced effects over 30 minutes post stretch will provide information about the immediate post-stretch time course. This is important since it is assumed that transient stretch mediated effects may be useful for the immediate clinical situation. For example, a stretch to decrease stiffness that may limit functional movement would be useful prior to performing additional interventions (e.g. strength / task related training) that aim to improve that functional movement. It is further assumed that for more long term improvements in passive stiffness, spasticity and ROM that any stretch-induced effects should last as long as possible following a single stretching session therefore providing a long term signal that could drive tissue remodelling. These assumptions will be revisited in the concluding chapter.



When applying stretches using a motor no justification has been given in previous work as to why a particular torque was chosen. The use of motors to deliver stretches have several advantages in that an exact specified torque can be delivered and the motor can be used to assess ROM and stiffness pre and post intervention. However, the use of motors are expensive and impractical for the majority of clinical stretching regimes (eg in the home environment). Therefore, it is important that the torques assessed, in this and future studies, include the range of torques that can be applied by patients for the purposes of self-management programmes. This will allow an assessment of applied torque delivered using motors to be ecologically valid and relevant to clinical practice.

Finally, it is important to ascertain the exact site of passive stiffness changes following a neurological insult and whether stretching specifically targets the sites (eg tendon vs muscle) of increased stiffness. This can be done by imaging muscle motion using ultrasound during standard ankle perturbations.

This thesis therefore aims to:

- d) Define the torques that can be applied by pwMS during commonly prescribed manual stretches (Chapter 5)
- e) Investigate the effects of different levels of applied torque and durations of stretch using a motor on passive stiffness, spasticity and ROM in pwMS (Chapter 6 and 7)
- f) Investigate the effects of constant torque stretching on direct measures of muscle strain using ultrasonography (Chapter 8)

Chapter 4 will describe common methods that are used throughout the thesis and chapter 9 will provide an overview of the thesis findings an appraisal of the underlying study assumptions and their limitations, and directions for future work.

## **4. Chapter Four: Methods**

This chapter describes the recruitment strategy, subject selection and randomisation criteria, outcome measures, experimental procedures, data collection and analysis methods common to the experimental studies detailed in this thesis. Any specific variations in methodological procedures not mentioned here will be subsequently detailed in the relevant chapters.

### **4.1 Sample Size Calculations**

**Study 1:** The aim of study one was to investigate the applied torques achieved during four commonly applied stretches of the plantarflexors and explore the relationship between the applied torque and the participants' functional ability and level of stiffness (2 predictors). Harvey et al. (2003) previously investigated therapist applied stretches of the hamstrings in people with a spinal cord injury. A mean correlation coefficient of 0.7 ( $R^2=0.49$ ) was found between the applied torque and hamstring extensibility. A similar relationship was assumed for patient applied stretches in study one. Thus, for a multiple regression with two predictors and 90% power at the 0.05% significance, the estimated sample size was 19.2. Therefore the aim was to have a minimal sample size of 20 people undertaking all four stretches. It was anticipated that up to 36 people would need to be targeted to achieve this minimum sample size since people with an Expanded Disability Status Scale (EDSS)  $\geq 6$  may not be able to achieve all the stretch positions requested.

**Studies 2 and 3:** These studies aimed to investigate the effect of different applied torques (study 2) and stretch duration (study 3) on the resulting reduction in stiffness. Although there was no data in the literature on the effects of applied torque on stiffness, previous authors had compared constant angle with constant torque stretches (Yeh et al. 2007). Therefore, sample size calculations were based on an assumption that a similar effect size would be found between the different applied torques as observed between constant angle and constant torque stretches. Yeh et al.

(2007) found that a stretch at a constant angle produced a 29+/-10% change in stiffness whilst a constant torque stretch produced a 39+/- 10% change in stiffness. Thus the effect size was  $(39-29)/10 = 1$ . For 90% power at the 0.05% significance level, the estimated sample size required to find a difference equivalent to one standard deviation between the means of the different stretches is 13 (determined for a paired t test). To account for 15% participant drop out per visit (3 visits) the aim was to recruit a maximum of 19 people to ensure that 13 people were seen for all three visits.

## **4.2 Study Sample**

The combined study sample of the experiments consisted of 54 people clinically diagnosed with MS who were mild to moderately disabled (27 study one, 14 study two, 13 study three) and 15 healthy controls in study one and 13 in study two and three (identical sample). All subjects provided informed written consent prior to participation in keeping with the declaration of Helsinki (Helsinki, 1996); ethical approval was obtained from the National Health Service (NHS) Torbay and Devon Research Ethics Committee and research and development committee approval was granted by the Plymouth Hospitals NHS Trust (Ref-09/H0202/42).

## **4.3 Recruitment Strategy**

People with MS who were registered on the South West Impact of MS Project (SWIMS) database (Zajicek et al. 2010), were invited via letter to volunteer for the studies. SWIMS is a population-based natural history database in which longitudinal self-report questionnaire data is collected to assess the impact of MS on over 1100 people in Devon and Cornwall.

The SWIMS Project Coordinator initially identified SWIMS participants who met the eligibility criteria (see below). These potential participants had stated that they had experienced symptoms of stiffness in the last six months but were not confined to bed (EDSS =7) (Goodin 1998). The SWIMS Project Coordinator withheld the identities of eligible participants from the research team but a record was made on the SWIMS

project database that a participant was eligible to approach for this stretch study. The SWIMS project coordinator then sent a “Stretch Study” information pack directly to eligible participants. The information pack contained a cover letter from the SWIMS coordinator to notify participants about the stretch study and explain why they had been chosen to take part, an invitation letter from the researcher, participant information sheet and stamped addressed reply slip.

All reply slips were returned directly to the research team. Potential participants were then contacted via telephone to ascertain additional information, answer screening questions and book appointments for visits to the Human Movement and Function Laboratory at the Allied Health Centre, Plymouth. In study one, 30 participants with MS were recruited, 27 of which completed the study. In study two, 17 participants with MS were recruited, 14 of which completed the study. In study three, 17 participants with MS were recruited, 13 of which completed the study. In addition age, height and weight matched controls were recruited from friends and spouses of people with MS and local staff. In study one, 15 control participants were recruited and for studies two and three a single control group of 13 participants was recruited.

#### **4.4 Eligibility Criteria**

People with MS had to fulfil the following eligibility criteria:

##### **4.4.1 Inclusion Criteria:**

Participants to:

- (a) Be able to take a minimum of 10 steps with or without the use of a walking aid and transfer independently (EDSS upper limit 7.0).
- (b) Be able to self-report the presence of leg stiffness.
- (c) Passively achieve a neutral alignment of the foot between inversion and eversion with the foot in 10° plantarflexion. This was required as motor driven stretches and measures of stiffness moved the ankle about one axis; any ankle contractures into

inversion or eversion would not move in the parasagittal plane, potentially causing injury.

(d) Have at least 90° passive movement at the knee when the hip is extended.

(e) Live within the Plymouth NHS hospitals catchment area and be willing to travel to the Human Movement and Function Laboratory at the Peninsula Allied Health Centre, Plymouth.

#### **4.4.2 Exclusion Criteria:**

(a) Presence of additional neurological or orthopaedic conditions not associated with MS.

(b) Severe cognitive impairment such that they are unable to provide informed consent.

(c) Upper limb deficits that prevent them from consistently using the manual motor safety cut off switch.

### **4.5 Measures of Participant Characteristics**

#### **4.5.1 Descriptors of Functional Status**

*Barthel Index:* a self-report 10 item ordinal scale measuring daily functioning such as mobility, feeding and bathing (van der Putten et al. 1999). The Barthel Index is one of the most widely used generic disability measures and scores range from 0-100 with a high score indicative of a high level of functioning.

*Multiple Sclerosis Walking Scale:* a 12 item self-report MS walking scale that measures the impact of MS on walking ability (Hobart et al. 2003). Scores range from 12-54, where a high score is indicative of high walking limitation. Scores are transformed to give a range of 0-100.

*Expanded Disability Status Scale (EDSS):* a 10 item ordinal scale ranging from “no disability” to “severe disability” where 4.5 is fully ambulatory without aid and 7.0 is unable to walk 5 meters with an aid (Goodin, 1998). The EDSS is very widely used in MS studies. The self-report version was used in this study (Goodin, 1998).

## 4.5.2 Clinical and Subjective Measures of Stiffness

Plantarflexor stiffness was assessed at baseline using both patient report and clinician rated methods.

*Multiple Sclerosis Spasticity Scale*: an 88 item self-report questionnaire that measures the impact of muscle stiffness, pain and spasticity and the impact of spasticity on function and social interactions (Hobart et al. 2006). Scores range from 88-352 and a high score indicates that the participant is more bothered by the effects of stiffness and spasticity on their daily functioning.

*Ashworth Scale*: a clinician rated measure of stiffness. Scores range from 0-4 where 0=normal muscle tone and 4=limb is rigid in flexion or extension.

## 4.6 Outcome Method

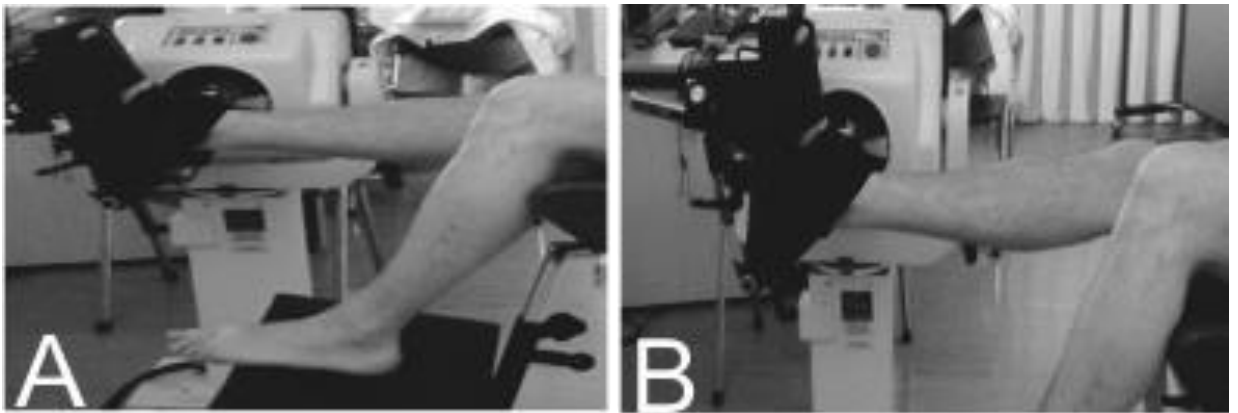
### 4.6.1 Stiffness

*Passive motor driven stretches*: 15 degree amplitude, slow (5 °/s) and fast (175 °/s) ramp stretches delivered by a servo motor.

Here participants were placed in a semi-reclined (25° head tilt) position with the right or left foot supported in a padded footplate (manipulandum) attached to a BSM Servo Motor (8.64 AMPS, 13.3Nm BSM90N,2500 line encoder) in series with a 10:1 low backlash gearbox. The motor was driven by a Motiflex e100 brushless drive with three phase input (Baldor UK Ltd, Bristol, UK). The drive was controlled by software written using the mint workbench programme (Mint programming module OPT-MF-100, Baldor UK Ltd, Bristol, UK). In series with the motor was a torque transducer (TLSF-B; IML, Derby UK). Analog outputs were provided via MINT option cards (e100). The motor had a resolution of  $2.7 \times 10^{-4}$  degrees. Study one participants used the Biodex Systems 3, IPRS Mediquipe UK motor and participants in study two and three the Baldor Motor.

In all cases the ankle axis was aligned to the axis of the motor while the foot was in a plantargrade position and the thigh was held in place with padded straps with the knee

in full extension. Padded stops and seatbelt styled supports prevented the body from moving longitudinally up the bed.



**Figure 4.1:** Foot position for stiffness assessment: A) starting position  $10^{\circ}$  plantarflexion; B)  $5^{\circ}$  dorsiflexion

The degree of ankle passive stiffness, total stiffness and stretch reflex activity were measured by applying a 15-degree amplitude, slow ( $5^{\circ}/s$ ) and fast ( $175^{\circ}/s$ ) stretch which consisted of ramps and variable hold periods repeated sinusodally six times (Yeh et al. 2004; Gajdosik, 2002) (Figure 4.1). A 5 Volt output signal indicated the time of stretch onset. In study two and three, a random two-four second delay was provided between hold positions so that the participants could not anticipate the stretch. Torque, position and velocity (EMG Analogue interface) were analogue to digital (AD) converted at 2KHz (Power 1401, Spike 2, Version 5, CED Electronics Cambridge, UK) and stored for off-line analysis (Matlab version R2009b).

#### **4.6.2 Motor Safety Features**

Extensive safety features were included in the Baldor and Biodex motor design to limit the maximal applied torque, joint position and to enable the user to immediately stop the motor (Yeh et al. 2004). The safety features included:

(a) Mechanical stops that limit movement and shear pins that limit applied force above 150 Nm.

(b) Software features that limit applied force and motion specific to the person being studied.

(c) Hand held immediate cut off safety device for the operator and the participant.

#### **4.6.3 Strength and Muscle Activity**

**Isometric Maximal Voluntary Contraction (iMVC):** a maximum isometric voluntary ankle plantar- and dorsi-flexion contraction was recorded with the ankle in 10° plantarflexion. Participants were instructed to pull their foot up toward their head as hard as possible, relax then push their foot against the foot plate as hard as possible. Participants received visual feedback of the applied torque throughout the study as well as verbal encouragement.

Muscle activity was recorded during the stretches and iMVC measured from the tibialis anterior, medial gastrocnemius and soleus muscles via surface electromyography (EMG 2.5 cm inter-electrode distance, MT8, MIE, UK); signals were sampled at 2KHz and AD converted for off line analysis (Power 1401, Spike 2, Version 5, CED Electronics Cambridge, UK). EMG signals were subsequently processed by removing any DC offset, filtering the data using a 1<sup>st</sup> order 30 Hz low pass butterworth zero phase and rectifying the data filter in MATLAB.

#### **4.6.4 Safety and Strength of the Stretch**

*Visual analogue scale for safety and strength of stretch (study one):*

Participants were asked to score the perceived strength and safety of each stretch using a six point visual analogue scale (VAS) from 0 – 5 (strength: 0= no stretch, 5= very strong stretch; safety: 0= not safe at all, 5= very safe).

*Visual analogue scales from 0-10 for strength of stretch (studies two and three):*



Participants were asked to score their perceived strength of stretch on a VAS from 0 – 10; where 0 = no stretch and 10 = a very strong stretch. It was felt that a scale of 0-5 may not be broad enough for participants to accurately indicate the strength of the constant torque stretch applied using the Biodex motor.

## **4.7 Analyses**

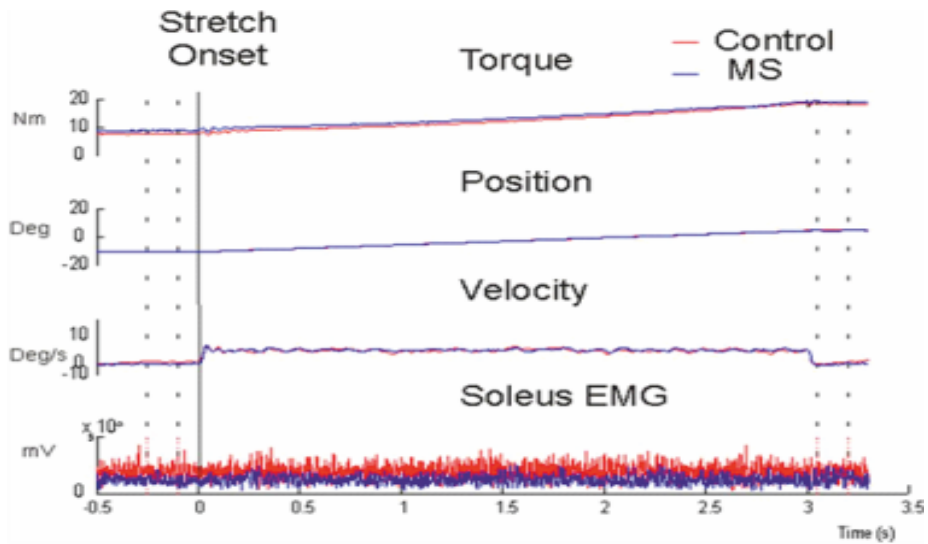
### **4.7.1 Analysis of Motor Driven Stretches**

Data files for the fast and slow stretches collected using Spike2 (CED Electronics Cambridge, UK) were assessed visually to determine that muscles were relaxed prior to the stretch and that there was no muscle activation during the slow stretches. Data was then exported as ascii text files in a standard format at 2000 Hz using a script program. Text files were then imported into MATLAB (Mathworks, UK).

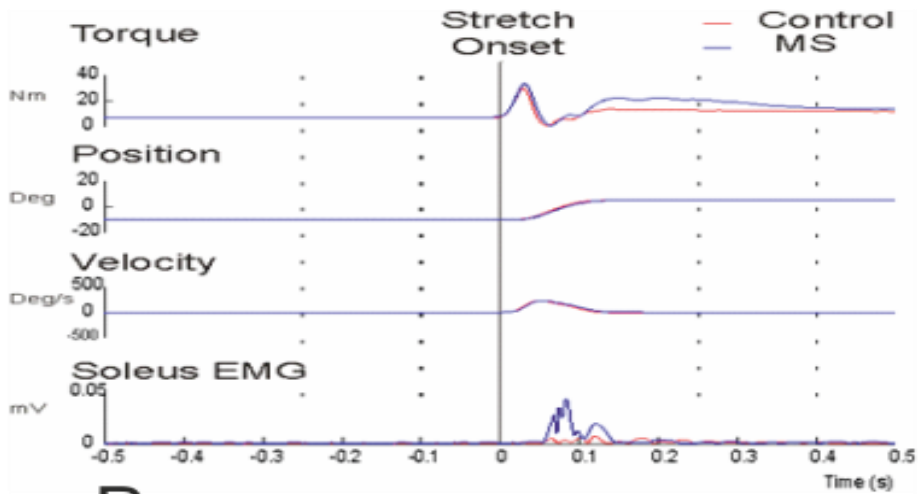
Individual stretches were aligned to stretch onset and then the average of stretch two-six was calculated. In study one stretch onset was defined as the point at which the acceleration/velocity trace rose above the pre-stretch mean baseline + 4SD for at least five milliseconds. In study two and three, stretch onset was aligned around a 5V signal that defined the onset of the stretch.

Stretches were excluded in the slow stretch if the EMG values rose above a level defined as the mean + 4SD of the period prior to stretch onset. This ensured that the slow stretch was measuring the effects of passive limb stiffness rather than any volitional or reflex-related muscle activity.

Stiffness values (slow and fast stretch data) were then calculated by entering the subject's demographic data: mass, length of manipulandum, gender and side assessed. Torque (Torque<sub>total</sub>) and position were measured over a 300-350 ms period prior to stretch onset and immediately following stretch offset (Figure 4.2).



A

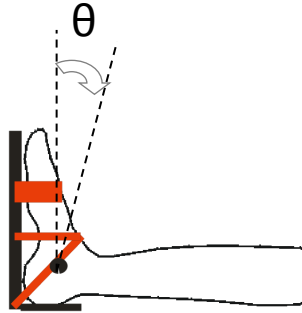


B

**Figure 4.2:** Raw data from the fast (A) and slow (B) stretch. The average of five stretches for a participant with MS and a control is shown. Note the large response in soleus and subsequent resistance to movement in the pwMS in B (blue trace)

The torque due to the weight of the foot ( $Torque_{foot\ weight}$ ) at each time point was estimated as:  $Torque_{foot\ weight} = mg \sin \theta d$

Where  $\theta$  = ankle angle relative to vertical (Figure 4.3),  $g$  = acceleration due to gravity,  $m$  = mass of the foot estimated from anthropometric data based on the subject's mass and gender (De Leva 1996) and  $d$  = the manipulandum length.



**Figure 4.3** Position of foot in manipulandum.  $\theta$ = angle relative to vertical

The change in torque due to the manipulandum ( $Torque_{manipulandum}$ ) was measured directly by re-playing the same computer controlled stretch when only the manipulandum was attached and without the foot inserted. The torque due to stiffness in the ankle-foot complex ( $Torque_{ankle-foot}$ ) was defined as:

$$Torque_{ankle-foot} = Torque_{total} - Torque_{footweight} - Torque_{manipulandum} \quad (2.9)$$

Stiffness was calculated as:

$$\text{Stiffness} = \Delta \text{ Torque} / \Delta \text{ Position (Nm/radians)}$$

Differences in all stiffness measures between groups were compared using a student t-test.

#### 4.7.2 Definitions of Stiffness Used in the Thesis

*Total stiffness:* the fast stretch elicits a stretch reflex and so the resultant stiffness observed is a combination of both the neural and non-neural components (Stevenson 2006). This will be referred to as the total stiffness.

*Passive stiffness:* changes in visco-elastic properties (non-neural) including connective tissues within and surrounding muscles, joints and intramuscular proteins. The slow stretch allows an assessment of the passive component in isolation as it is slow enough not to elicit a stretch reflex (Stevenson, 2006). Pilot work has shown that stretch reflexes can be elicited in patient groups at speeds as low as 8 °/s.

*Spasticity*: a velocity-dependent increase in tonic stretch reflex with exaggerated tendon jerks, resulting from hyperexcitability of the stretch reflex (Lance, 1980). This is represented by the difference between the fast and slow stretches applied.

#### **4.7.3 Analysis of Isometric MVC**

The MVC was defined as the difference between the maximal applied torque and the baseline torque when the participant was resting.

## **5. Chapter Five: Factors Influencing the Applied Torque During Manually Applied Plantarflexor Stretches in People with Multiple Sclerosis**

### **5.1 Introduction**

Previous studies assessing stretching regimes have used motors to apply controlled stretches (Bressel & McNair, 2002; Yeh et al. 2004). Whilst the use of a motor has the advantage of providing consistency of stretching and the ability to monitor changes in stiffness, it is unclear whether the torques applied and the durations of stretching relate to clinically prescribed stretches. Therefore, the applied torques that can be produced with commonly applied manual stretches was investigated and the relationship between the applied torque, the severity of passive stiffness, spasticity and functional ability was explored.

### **5.2 Materials and Methods**

#### **5.2.1 Participants and Recruitment**

Participants with MS (n = 27) were recruited from the SWIMS database. Participants were included if they met the eligibility criteria (see chapter 4 section 4.4 for details). PwMS were compared with 15 age, height and weight matched healthy controls. Written informed consent was obtained from all participants and the study was conducted with approval from the NHS Torbay and Devon Research Ethics Committee (Ref-09/H0202/42).

#### **5.2.2 Demographics and Self-Report Measures of Spasticity and Function**

Demographic information (gender, age, weight, height, type and duration of diagnosis, anti-spastic medication) was collected and self-report EDSS (Goodin, 1998) was recorded at the beginning of the study. During seated rest periods throughout the test session, participants completed self-report questionnaires to evaluate: function, the Barthel Index (BI, Putten et al., 1999); walking ability, the 12-item Multiple Sclerosis Walking Scale (MSWS-12, Hobart et al., 2003); and spasticity, the Multiple Sclerosis

Spasticity Scale (MSSS-88, Hobart et al., 2006) (refer to Chapter 4 , section 4.5 for details).

### **5.2.3 Measurement of Stiffness, Strength and Muscle Activity**

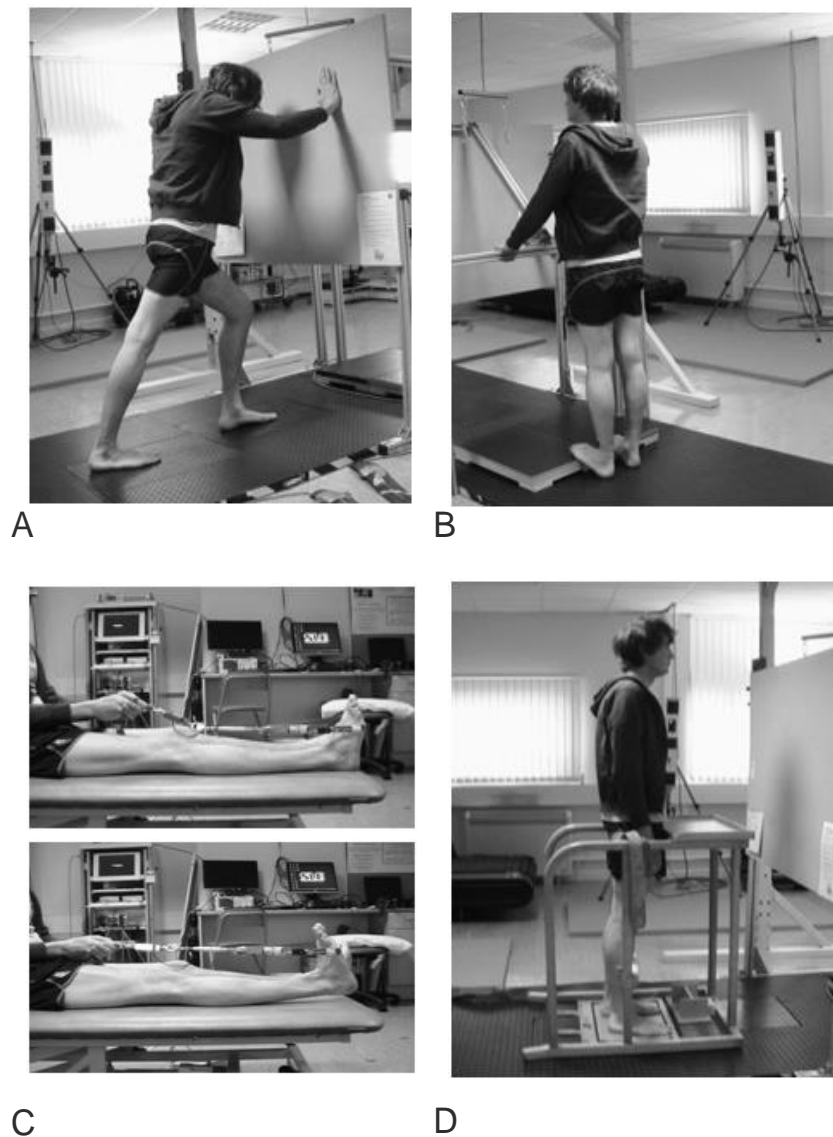
**Ankle stiffness:** Plantarflexor stiffness was measured on the right leg as described in chapter 4 (Biodex Systems 3, IPRS Mediquipe UK).

**Isometric MVC:** A maximum isometric voluntary ankle plantar- and dorsiflexion contraction (iMVC) was recorded with the right ankle in 10<sup>0</sup> plantarflexion; participants received visual feedback of the applied torque throughout.

**Muscle Activity:** Surface EMG was recorded from the tibialis anterior, medial gastrocnemius and soleus muscles via surface electromyography (EMG 2.5 cm inter-electrode distance, MT8, MIE, UK). The position of the surface electrodes was constant throughout the study; that is during measures of stiffness, strength and manually applied stretches.

### **5.2.4 Manually Applied Stretches**

Four stretches of the right plantarflexor muscles were assessed in a consistent order (Figure 5.1): stretching in step standing (WALL); stretching off a step (STEP); pulling the ankle into dorsiflexion (PULL); and standing in an oswestry standing frame (FRAME). All stretches were demonstrated by the researcher using standardised instructions and each condition was practiced prior to measurement. Participants were not required to perform any stretch that could not be safely maintained and they wore a safety harness attached to an overhead gantry if their balance was compromised. The stretch duration for all positions was 15 seconds and each stretch was repeated three times. A five minute rest was given between each group of stretches during which participants were asked to score the perceived strength and safety of the stretch immediately using a visual analogue scale (VAS) from one – five (strength: 1= minimal stretch, 5= strong stretch; safety: 1= feel very unsafe, 5= feel very safe).



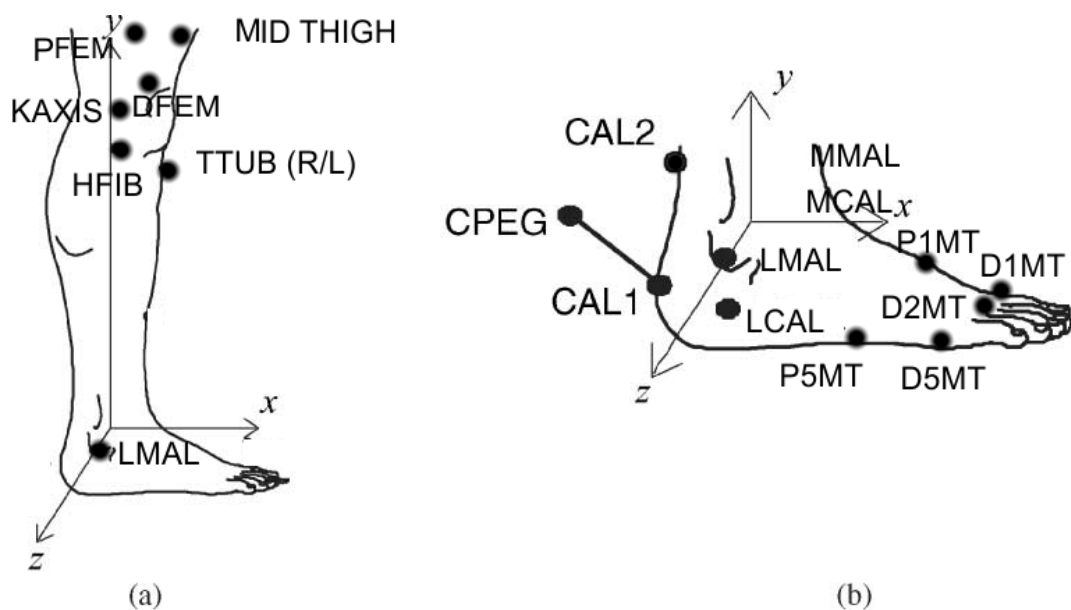
**Figure 5.1:** *Stretch conditions: A) Wall stretch, B) Step stretch, C) Pull stretch (showing the ankle move into dorsiflexion from top to bottom), D) Frame stretch.*

Following the four stretch conditions and a five minute rest period, the MS participants performed a constant sustained stretch in order to determine the length of time that they could hold a stretch (up to a cut off of 10 minutes) and the limiting factors. One stretch position out of the four stretching conditions was selected; the stretch selection was based on the highest VAS score reported for perceived strength of stretch if it had a safety score of three or more. Participants were asked to stretch for as long as they felt comfortable and to apply a force that did not cause discomfort and was similar to

the forces they typically applied while stretching. The duration of this stretch was recorded and the participants were asked to report why they had stopped stretching.

### 5.2.5 Measurement of Gastrocnemius Length ,Torque and Muscle activity

Gastrocnemius length was estimated from the position of Coda markers (Figure 5.2) placed on the muscles' distal attachment (the tubercle of the calcaneus) and proximal attachment (posterior lateral femoral condyle) (Lichtwark et al. 2007).



**Figure 5.2:** Tibial (TB) and Hindfoot (HF) diagram with Coda marker placement:

(a) TB: Frontal plane through the malleoli and fibula head; sagittal plane through the tibial tuberosity and midpoint between the two malleolar markers (MMAL, LMAL); (b) HF: Sagittal plane aligned with markers along the vertical axis of the calcaneus; transverse plane is taken parallel to the floor (Carson et al. 2001). Abbreviation include: proximal femur (PFEM), middle of thigh (MID THIGH), knee axis (KAXIS), distal femur (DFEM), tibial tuberosity (TTUB), head of fibular (HFIB), lateral malleolus (LMAL), medial malleolus (MMAL), medial calcaneus (MCAL), lateral calcaneus (LCAL), posterior calcaneus (CAL1), marker placed on Achilles tendon in line with top of malleolus (CAL2), additional marker placed on external ankle device in line with posterior calcaneus (CPEG), distal first metatarsal (D1MT), proximal first metatarsal (P1MT), distal second metatarsal (D2MT), distal fifth metatarsal (D5MT), proximal fifth metatarsal (P5MT.)



Gastrocnemius length was calculated using pythagoras' theorem:

$$\text{Length}^2 = (\text{proximal } x - \text{distal } x)^2 + (\text{proximal } y - \text{distal } y)^2 + (\text{proximal } z - \text{distal } z)^2$$

Where:

proximal = position of the proximal marker on the posterior lateral femoral condyle

distal = position of the distal attachment on the tubercle of the calcaneus

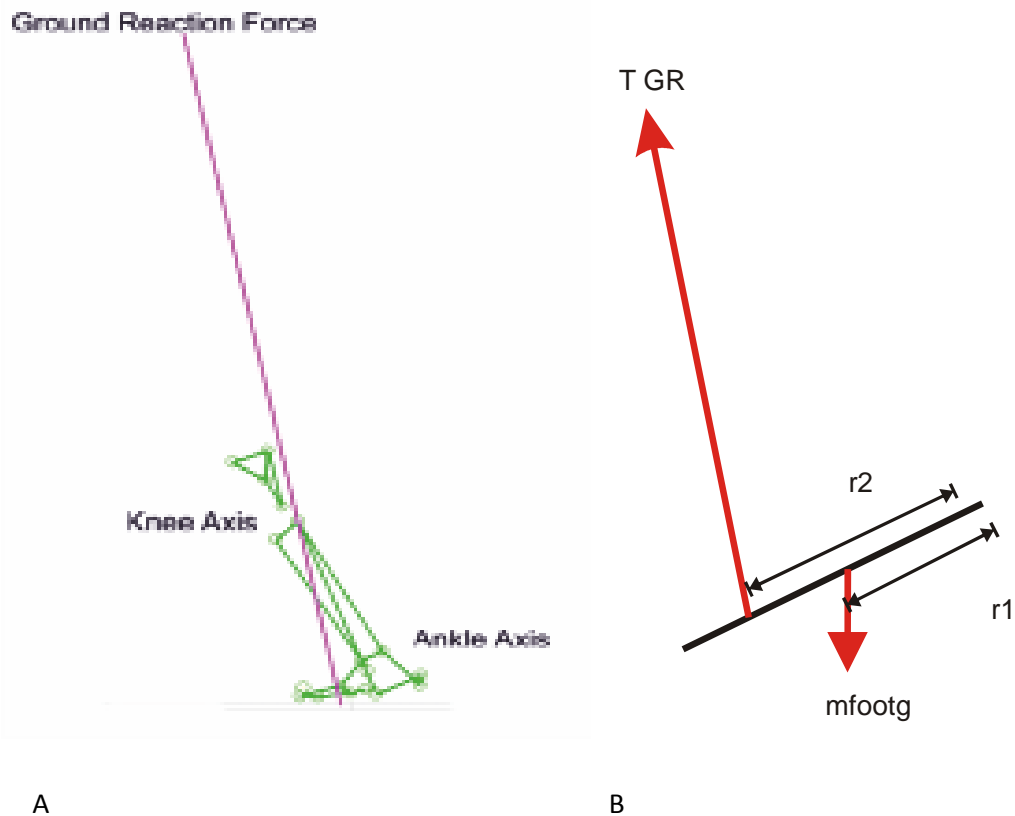
x = marker position in the antero-posterior direction

y = marker position in the medio-lateral direction

z = position in the vertical direction.

Gastrocnemius length was normalised to body height. Additional markers were placed over bony landmarks that defined the longitudinal axis of the foot, shank and thigh and from this the ankle and knee angle in the sagittal plane was calculated. Two calibration trials with the ankle at 90° and knee at 0° were taken at the start to standardise the neutral ankle and knee position between participants.

For stretches in a standing position the direction, magnitude and point of application of the applied torque was measured via force plates (9286AA Kistler, Instruments Ltd, Hampshire, UK) that the participant stood on (WALL, STEP AND FRAME). For the STEP and WALL stretches only the leg of interest was in contact with the force plate. For the FRAME stretch both feet were in contact with the force plate and the load through each foot was measured directly (FMAT, TEKSCAN, Biosense Medical UK). For the PULL stretch applied torque was measured via a torque transducer in series with the strap; markers were positioned along the strap to define the direction of pull and point of application of the torque. Body segment mass and the centre of mass were estimated from anthropometric data. Muscle activity was measured throughout the stretch using surface EMG.



**Figure 5.3:** A) Codamotion analysis sagittal plane stick figure showing the Coda marker placement, B) Free body diagram of the forces acting on the foot when the body is stationary.

As the participant was stationary during the stretch, the net ankle torque produced during the stretches was estimated as the cross product of the following vectors (Figure 5.3) (Robertson et al., 2004):

$$\vec{M}_a = \vec{r}_2 \vec{F}_{GRF} - m_{foot} g \cdot \vec{r}_1$$

Where:

$\vec{M}_a$  = unknown net ankle torque

$\vec{r}_1$  = vector from the ankle joint centre to the centre of mass

$\vec{r}_2$  = vector from the ankle joint centre to the point of application of the ground reaction force vector

$m_{foot} g$  = weight of the foot vector

$\vec{T}_{GR}$  = ground reaction force vector

The net ankle torque was normalised by the participants' body mass. The applied torque in the FRAME condition was adjusted according to the percentage of load through the right leg.

EMG signals from the tibialis anterior and gastrocnemius were processed by removing any DC offset, filtering the data using a 1<sup>st</sup> order 30 Hz low pass butterworth zero phase and rectifying the data filter in MATLAB. The mean EMG activity over the 5-15 period was then calculated. The EMG level was then normalised to the mean EMG level calculated over a 500 ms period centred on the point of maximal torque output.

### **5.2.6 Analyses**

Normalised mean ankle torque and gastrocnemius length and EMG activity over the 5-15 second period of the stretch were compared between the MS and control groups using a between groups repeated measures ANOVA (SPSS 17.0, IBM). Factors were STRETCH CONDITION N=4 (WALL, STEP, PULL, FRAME). A priori contrast compared the difference between the WALL Vs STEP; STEP Vs PULL and PULL Vs FRAME conditions. Differences in plantarflexor and dorsiflexor isometric muscle strength and stiffness between the groups were compared using a paired student t-test. The relationships between i) muscle strength ii) limb stiffness iii) functional ability (as measured by the Barthel Index and the MSWS12) and the applied torque were determined using a Pearson's rank correlation; a Bonferroni correction was made to account for the multiple comparisons (n=16 significance taken  $P < 0.05/16 = 0.003$ ). For all other statistical tests, the level of significance was set at  $P < 0.05$ .

### **5.3 Results**

The study population comprised 27 pwMS (age  $54 \pm 8.08$  yrs) and 15 healthy volunteers ( $53.4 \pm 6.5$  yrs). PwMS had a median EDSS score of 5.5 (IQR 1.8, range 4.5-7.0) and a median Barthel Index of 90 (IQR 20, range 0-100). All participants could

achieve plantargrade (90°) at the ankle. Tables 5.1 and 5.2 provide a summary of the demographic characteristics and self-report questionnaire scores for the sample.

Subject	Group	Gender	Age(years)	Height(cm)	Weight(kg)	MS Type	Duration of MS (years)	Anti-spastic medication	EDSS
1	MS	M	61	180.9	129	PPMS	3	NO	6.0
2	MS	F	48	169.7	64	RRMS	0.50	NO	4.5
3	MS	F	45	151.5	104	RRMS	14	NO	4.5
4	MS	F	49	155.5	95	RRMS	7	NO	4.5
5	MS	M	51	188.0	120	RRMS	1	NO	6.0
6	MS	F	43	175.2	70	RRMS	3	NO	5.5
7	MS	F	76	165.2	65	PPMS	5	NO	6.0
8	MS	F	54	168.0	66	PPMS	1	NO	4.5
9	MS	F	65	154.1	55	PPMS	3	NO	6.0
10	MS	M	51	171.5	90	PPMS	8	NO	7.0
11	MS	M	55	174.6	100	PPMS	5	NO	7.0
12	MS	F	54	164.9	68	RRMS	3	NO	4.5
13	MS	F	57	170.4	66	RRMS	13	NO	6.5
14	MS	F	47	169.0	80	SPMS	14	NO	6.5
15	MS	F	61	165.1	76	SPMS	4	NO	5.0
16	MS	M	45	178.0	80	RRMS	12	NO	4.5
17	MS	F	52	166.8	55	RRMS	4	NO	5.5
18	MS	F	65	168.7	69	RRMS	21	NO	5.5
19	MS	F	52	153.0	70	RRMS	1	NO	4.5
20	MS	F	63	158.5	70	SPMS	20	NO	6.0
21	MS	F	52	154.0	50	RRMS	5	NO	4.5
22	MS	F	63	157.5	65	SPMS	32	Baclofen	7.0
23	MS	F	47	157.5	64	SPMS	20	Baclofen	6.5
24	MS	F	51	169.7	83	SPMS	28	Baclofen	6.0
25	MS	M	60	185.0	85	Unknown	28	Baclofen	7.0
26	MS	M	41	187.4	83	RRMS	1	NO	4.5
27	MS	F	50	163.0	58	RRMS	9	NO	4.5
PwMS	N=27	F=20 M=7	Mean:54 SD ± 8.08	Mean:168 SD ±10.47	Mean:77 SD ± 19.27		Mean:9.83 SD ± 9.34	N=4	Mean:5.50 SD ± 1.88

Subject	Group	Gender	Age(years)	Height(cm)	Weight(kg)	MS Type	Duration of MS (years)	Anti-spastic medication	EDSS
28	CON	F	44	165.0	57	NA	N/A	N/A	N/A
29	CON	F	63	169.0	57	NA	N/A	N/A	N/A
30	CON	M	48	165.0	69	NA	N/A	N/A	N/A
31	CON	F	47	167.0	65	NA	N/A	N/A	N/A
32	CON	M	54	175.5	76	NA	N/A	N/A	N/A
33	CON	F	54	170.0	140	NA	N/A	N/A	N/A
34	CON	m	50	178.5	76	NA	N/A	N/A	N/A
35	CON	F	56	179.0	100	NA	N/A	N/A	N/A
36	CON	M	47	169.0	60	NA	N/A	N/A	N/A
37	CON	M	62	171.5	76	NA	N/A	N/A	N/A
38	CON	F	62	163.9	63	NA	N/A	N/A	N/A
39	CON	M	51	177.5	75	NA	N/A	N/A	N/A
40	CON	M	56	176.8	102	NA	N/A	N/A	N/A
41	CON	M	46	166.5	106	NA	N/A	N/A	N/A
42	CON	M	61	172.0	89	NA	N/A	N/A	N/A
Controls	N=15	F=6 M=9	Mean:53 SD ± 6.46	Mean:171 SD ± 5 .25	Mean:81 SD ± 22.99				

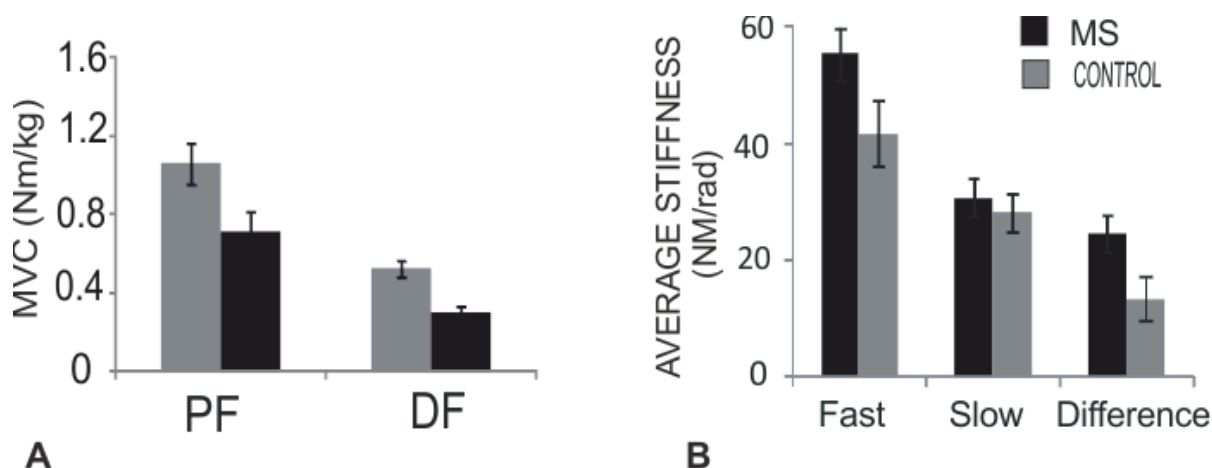
**Table 5.1.** Participant demographics columns 1-6 contain information about each individual belonging to the patient or control groups, gender, age, height and weight. Columns 7-10 contain information regarding MS participants, including MS type: relapsing remitting MS (RRMS), primary progressive (PPMS), secondary progressive MS (SPMS), duration of MS, the use of anti-spastic medication and EDSS.

<b>OUTCOME MEASURES</b>	<b>SCORE</b>
Barthel index (range 0-100)	90.0 (20.0)
MSWS12(t)(range 0-100)	48.42 ± 21.64 (38.89)
MSSS88 (range 0-352)	153.0 (83.5)
Ashworth ankle (range 0-4)	2(1)
Ashworth knee extensors	1( 1)
Ashworth knee flexors	1(1)
Ashworth hip extensors	1(2)
Ashworth hip flexors	1(2)

**Table 5.2** *Clinical descriptors of people with MS: Barthel Index (Median, Inter Quartile Range (IQR)); Transformed MSWS12 (Mean ± Standard deviations, (IQR)); MSSS88 (Median, (IQR)); plantarflexor Ashworth scores (Median, (IQR)).*

### **5.3.1 Stiffness and Muscle Strength**

Plantarflexor ( $t=-2.2$   $P=0.03$ ) and dorsiflexor isometric strength ( $t=-4.0$   $P=0.0002$ , Figure 5.4a) was significantly reduced in pwMS. Slow ( $5^{\circ}/s$ ) stretches did not elicit any EMG activity. The passive stiffness in the plantarflexors measured during the slow stretch was not significantly different between the groups ( $t=0.43$   $P=0.67$ ). Fast ( $175^{\circ}/s$ ) stretches resulted in EMG activation in all pwMS. The difference between the slow and fast stretch, indicative of the size of the stretch reflex, was significantly higher in pwMS ( $t=2.05$   $P=0.04$ , Figure 5.4b).



**Figure 5.4:** A) Maximum voluntary contraction recorded in Nm/kg (PF = Plantarflexor DF= Dorsiflexor strength), B) Average plantarflexor stiffness. Standard error of the mean (SEM) is indicated.

### 5.3.2 Mean Ankle Torque

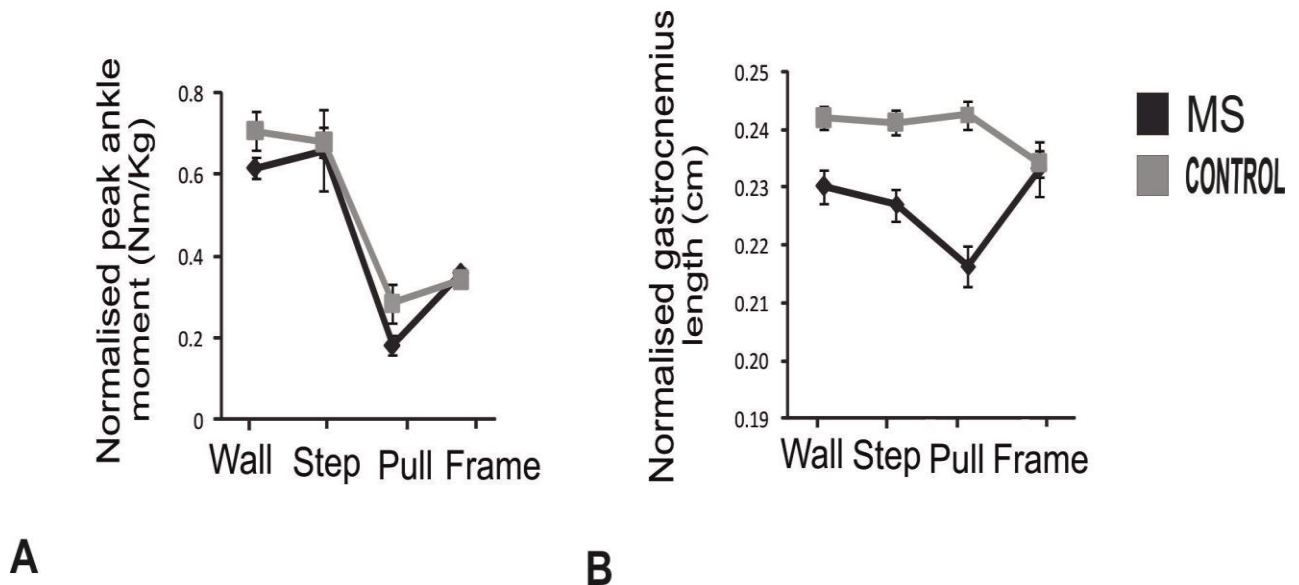
There was a significant difference between the conditions (CONDITION F (3,120) = 33.9 P=0.000); a priori contrasts revealed that the mean torque decreased significantly between the STEP and PULL conditions (F(1,40)=100.8 P<0.001) then increased significantly between the PULL and FRAME conditions (F(1,40)=40.7 P<0.001, Figure 5.5a). There was no significant GROUP X CONDITION interaction (F(3,120)=0.6 P=0.51 ) and no significant effect of group (GROUP F(1,40)= 1.5; P=0.22).

### 5.3.3 Gastrocnemius Length

There was a significant effect of group, with the controls showing a longer gastrocnemius length compared to the pwMS (GROUP F(1,40) = 7.2 P=0.01, Figure 5.5b). There was no significant difference between the conditions (CONDITION F(3,120)= 2.4 P=0.09, Figure 5.5b). There was a significant GROUP X CONDITION interaction (F(3,120)=9.1 P<0.001). Contrasts revealed that there was a large decrease in gastrocnemius length between the STEP and PULL condition in the MS group whilst the muscle length stayed approximately the same in the controls (F(1,40)=7.9 P=0.008, Figure 5.5b). There was greater gastrocnemius lengthening in the MS group during the FRAME condition compared to the PULL condition, in contrast to controls where lengthening was greater in the PULL compared to the FRAME condition (F(1,40)=10.5



P=0.002). In the FRAME condition muscle length was the same between the two groups, in keeping with the fact that all participants stood in a standardised position with their foot and knee position constrained by the frame (Figure 5.5b).



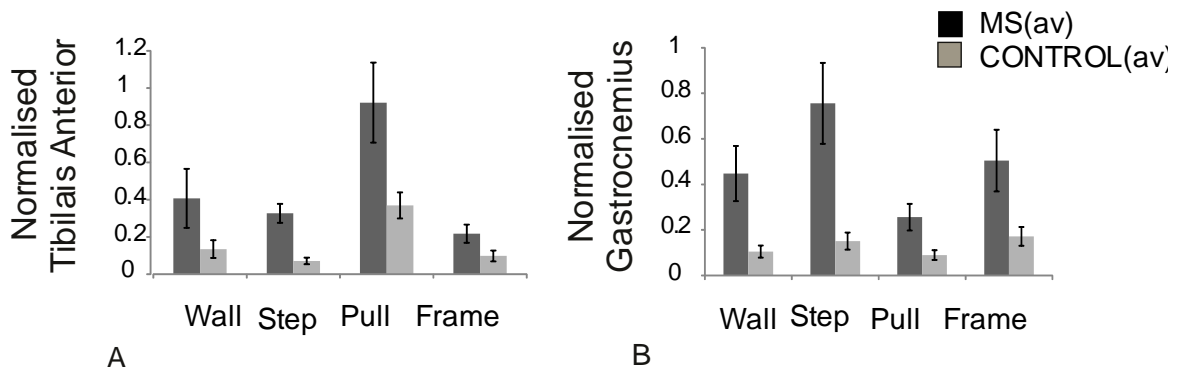
**Figure 5.5:** A) Mean ankle torque normalised to body weight (Nm/kg), B) Gastrocnemius length normalised to body height (cm). Standard error of the mean (SEM) is indicated.

### 5.3.4 Muscle Activation

**Tibialis Anterior:** There was a significant difference in normalised tibialis anterior activation between the conditions (CONDITION  $F(3,117)= 6.0$   $P<0.001$ ). There was higher muscle activation in the PULL condition compared to the STEP ( $F(1,40)=6.4$ ;  $P<0.05$ ) and FRAME ( $F(1,40)=16$ ;  $P<0.001$ ) conditions (Figure 5.6a). There was no significant GROUP X CONDITION interaction ( $F(3,117)=0.99$   $P=0.4$ ). Normalised EMG was higher in the MS group (GROUP  $F(1,40)=6.7$   $P=< 0.05$ ).

**Gastrocnemius and Soleus:** Muscle activation in the two plantarflexor muscles during stretching showed identical trends and therefore only the gastrocnemius activity is reported. There was a significant difference in gastrocnemius activation between the conditions (CONDITION  $F(3,117)=5.0$   $P<0.01$ ) with activation being higher in the STEP compared to the WALL ( $F(3,40)=8.6$   $P=0.005$ ) and PULL ( $F(3,40)=5.1$   $P=0.03$ )

conditions (Figure 5.6b). There was a significant GROUP X CONDITION interaction ( $F(3,117)=3.0$   $P=0.03$ ) with a larger increase in activation in the STEP condition compared to the WALL condition in the MS group ( $F(1,40)=4.8$   $P<0.05$ ) (Figure 5.6b). Normalised EMG was higher in the MS group (GROUP  $F(1,40)=5.1$   $P<0.05$ ).



**Figure 5.6:** A) Mean normalised tibialis anterior activation B) Mean normalised gastrocnemius activation. Standard error of the mean (SEM) is indicated.

### 5.3.5 Relationship Between Ankle Torque, Ankle Stiffness and Functional Ability

In pwMS there were weak and/or insubstantial correlations ( $r<0.3$ , Cohen 1988) between mean ankle torque and functional ability as measured by either the BI or the MSWS-12, or between mean ankle torque and stiffness following either a slow or a fast stretch (Table 5.3).

CONDITION	WALL	STEP	PULL	OSF
Mean ankle moment – Barthel Index	R= 0.19 (p=0.34)	R=0.16 (p=0.44)	R= 0.15 (p=0.47)	R= 0.08 (p=0.71)
Ankle moment – MSWS12	R= 0.23 (p=0.27)	R=0.0002 (p=1.00)	R= 0.02 (p=0.92)	R= 0.07 (p=0.74)
Ankle moment - Stiffness (slow stretch)	R= 0.36 (p=0.06)	R=0.12 (p=0.54)	R= 0.18 (p=0.39)	R= 0.07 (p=0.74)
Ankle Moment - Stiffness (fast stretch)	R= 0.17 (p=0.40)	R= 0.06 (p=0.77)	R= 0.27 (p=0.19)	R= 0.11 (p=0.60)
Man ankle moment-Ankle PF iMVC	R=0.30 (P=0.11)	R=0.07 (P=0.71)	R=0.22 (P=0.26)	R=0.06 (P=0.75)

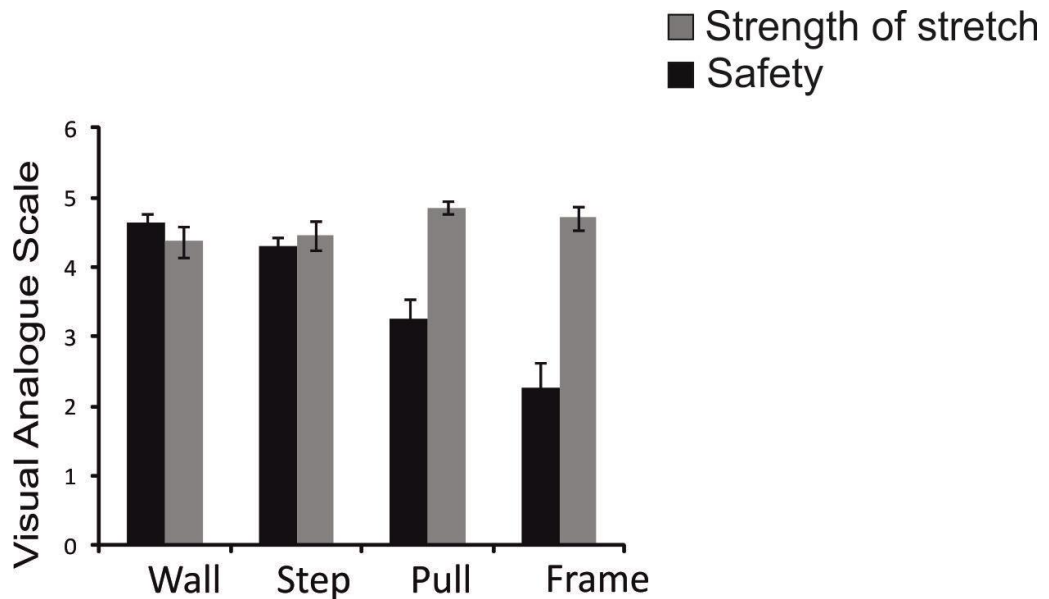
**Table 5.3.** Relationship between mean ankle moment and function, ankle stiffness and iMVC

R = Pearson's rank correlation.

### 5.3.6 Self Report Measures of Strength and Safety of Stretches

The WALL and the STEP stretch were rated by pwMS as the two strongest stretches and were rated equally safe (Figure 5.7). Of the pwMS 61.54% chose the WALL stretch as the stretch that gave them the strongest sensation of stretch, 23.08% chose the STEP, 11.54% the FRAME and 3.85% chose the PULL. One person chose not to perform the long stretch due to fatigue. The pwMS who chose to stretch subsequently using the FRAME or PULL conditions had a higher EDSS and lower BI (n=4 Median

(Interquartile range) EDSS = 6.5 (1.13), BI = 75 (18.75) compared to those that chose the WALL or STEP conditions (n = 22 EDSS= 5.75 (1.5), BI = 95 (15.0).



**Figure 5.7:** Self-reported strength and safety of stretch in MS group (mean +/- Standard error of the mean (SEM) is indicated).

PwMS were able to maintain a stretch for 148.4 seconds (s) ( $\pm 134.7$ ) with longer stretch durations being seen in the FRAME and PULL conditions (mean (SD)  $296 \pm 419$ s) compared to the WALL and STEP conditions ( $118 \pm 86$ s). In the most commonly chosen stretch, the WALL stretch, fatigue in the arms was most frequently given (42.9% of cases) as the reason for cessation of the stretch, with other reasons being fatigue in the stretching leg (28.6%), general fatigue (26.4%) or discomfort in the neck region (7.1%). Healthy controls were not assessed in terms of the length of time with which a stretch could be sustained.

## **5.4 Discussion**

The overall aim of this study was to enhance understanding of the amplitude of the torques that could be achieved using commonly prescribed manual stretches for the plantarflexor muscles and the relationship between the torques achieved and the presenting level of stiffness and functional ability in pwMS.

### **5.4.1 Muscle Stiffness in MS**

The 5 °/s stretch did not elicit a stretch reflex and is therefore felt to measure passive stiffness. The 175 °/s stretch elicited a stretch reflex in all pwMS. The difference between the fast and slow stretch represents the contribution of spasticity to the overall stiffness measure and this was significantly higher in pwMS. In contrast, passive stiffness was not significantly different between the groups in keeping with recent work by Lorentzen et al. (2010) although changes in passive stiffness have been previously reported in this patient population (Sinkjaer et al., 1993). Given that spasticity was the main contributor to stretch mediated stiffness in this study sample it will be important to explore the clinical impact of stretching on spasticity as well as passive stiffness and range of motion in future studies.

### **5.4.2 Effect of Stretching on Ankle Plantarflexion Torque and Gastrocnemius Length**

The ankle plantarflexor torque produced while stretching significantly varied between the different stretching conditions, with both groups producing higher torques in the standing conditions. This is supported by the subjective ratings of the pwMS, the majority of who rated the standing stretches (particularly the WALL stretch) as those which were associated with a strong sensation of stretch. Higher ankle torques in the WALL and STEP stretch were probably due to the use of body weight to apply a constant torque. In both groups less ankle torque was produced when manually using the arms to stretch the ankle. For the pwMS this resulted in less lengthening of the

gastrocnemius when compared to other stretches; this may reflect weakness and fatigue of the upper limb muscles resulting in an inability to generate a significant force to stretch the plantarflexor muscles. Lower net ankle plantarflexor torque in the PULL condition may also reflect the observed increase in activation of the tibialis anterior muscle.

The controls were able to produce a significantly longer gastrocnemius muscle length than the pwMS, suggesting that they were able to produce a more effective stretch in all conditions. However, the applied ankle torque did not differ between the groups. A net plantarflexor ankle torque could be caused by forces associated with passively stretching the plantarflexors or actively contracting the plantarflexors; the inverse dynamics approach used in the current study to calculate the ankle torque is unable to distinguish between these possibilities. While stretching the gastrocnemius and soleus, EMG was found to be higher in the pwMS in the WALL, STEP and PULL stretching conditions, highlighting that the stretch and generation of ankle torque was not totally passive in nature. The increased muscle activation may reflect postural activity resulting from poor standing balance or a stretch-evoked contraction of the muscle.

Correlations between function, stiffness and torque for all stretch conditions were negligible to weak (Cohen, 1988). This suggests that, in this sample of mild to moderately disabled pwMS (EDSS 4.5 – 7.0); neither functional capability nor the level of presenting stiffness had a significant impact on the torque produced. When asked to choose a stretch that was perceived as producing a strong sensation and that was safe to implement, people with lower functional ability tended to choose the FRAME and PULL conditions whilst participants with higher functional ability tended to choose the WALL and STEP stretches. People choosing the FRAME and PULL conditions were able to hold the stretch for longer than the other conditions that required standing balance and antigravity activity. Thus the PULL and FRAME stretch elicit lower ankle torques when measured objectively but can be held for longer. These findings are specific to the sample used and future work should explore the relationship between

stretch duration and applied torque using clinically achievable stretch durations and torques as outlined here in people with MS of varying levels of hypertonia and functional ability. This will allow clinicians to ascertain whether longer duration/lower torque stretches are as effective as shorter duration/higher torque stretches at reducing stiffness in the short and long term and ultimately allow stretch regimes to be tailored to the individual.

## **6. Chapter Six: The Effect of Stretching at Different Torques on Plantarflexor Stiffness and Range of Motion in People with Multiple Sclerosis**

### **6.1 Introduction**

Chapter five highlighted that pwMS produce different levels of torque during standing and seated manual stretches, with standing stretches generating higher torques, which result in greater lengthening of the plantarflexors (Hall et al. 2010). There are currently no studies exploring the relationship between the effects of different clinically achievable torques on muscle stiffness and joint ROM. Previous work investigating sustained muscle stretching interventions have demonstrated that stretching at a constant-torque is more beneficial in improving ROM compared to cyclic stretches or holding the ankle at a constant angle (Yeh et al. 2007). Therefore, this second study aimed to investigate the effects of three constant torque values that were shown in study one to be achievable by pwMS during manual stretches. The torques were applied over a 30 minute stretching period and the differing impact of these on passive stiffness, spasticity and joint ROM over a 30 minute post stretch period were ascertained. The literature review described in chapter one and two highlights that the optimal duration of stretching remains unclear. Although there is still some uncertainty around the duration of stretch that is most effective in treating hypertonia, a number of studies have demonstrated that 30 minutes of stretching daily alongside routine positioning was of significant benefit in improving ROM in the neurologically impaired population (Gorter et al. 2007; Yeh et al. 2004; Yeh et al. 2007; Bressel & McNair, 2002). Based on this, it was anticipated that this stretch duration would be sufficient to show clinical benefits and allow the impact of different applied torques to be investigated.

Determining the change in passive stiffness and spasticity with stretching will provide information about the role of the applied torque amplitude in passive stiffness and spasticity management and the time course of any changes over the pre- and post-



stretch period. This will help to inform clinicians about the importance of these specific parameters. Further, investigating factors such as the impact of baseline levels of stiffness on treatment outcomes will help to tailor interventions to the individual.

## **6.2 Materials and Methods**

### **6.2.1 Participant Recruitment**

Participants with MS (n = 17) were recruited from the SWIMS database (Zajicek et al. 2010); eligibility criteria were described in chapter four section 4.4. Baseline characteristics were compared to an age, height and weight matched control group (n=13) recruited from friends/families of pwMS and via a local advertisement for volunteers. Written informed consent was obtained from all participants and the study was conducted with approval from the NHS Torbay and Devon Research Ethics Committee (Ref-09/H0202/42).

### **6.2.2 Demographics and Baseline Characteristics**

During the post stretch period, participants with MS were asked to complete self-report questionnaires on function (BI and MSWS-12 (Putten et al. 1999; Hobart et al. 2003)) and spasticity (MSSS-88 (Hobart et al. 2006)). Disease severity was rated using the EDSS (Goodin, 1998). For both the control group and pwMS demographic information including age, weight, height, gender, shank length and thigh length was recorded at the beginning of the study. Length of time and type of diagnosis and medication was also recorded for participants with MS.

### **6.2.3 The Stretching Intervention**

The study aimed to determine the effect of a 30 minute constant torque stretch on plantarflexor passive stiffness, stretch reflex-evoked stiffness, ROM, ankle plantar- and dorsi-flexor strength and to determine how this varied over a 30 minute post stretch period. Three torque levels were assessed over three test sessions, presented in random order with each session separated by a minimum of three days. Factors such as bed height, back rest position and motor position relative to the bed were constant

for each participant across the three visits to ensure that the ankle starting position was standardised.

The high (0.42 Nm/kg), medium (0.30 Nm/kg) and low (0.18 Nm/kg) imposed torques calculated from study one (see chapter five) were used to apply a constant stretch; the torque applied was scaled according to body weight. Participants were placed in a semi-reclined (25° head tilt) position with their head supported on a pillow. The leg reported by participants to be the most affected by stiffness was placed in a padded footplate attached to a servomotor (BSM, UK). The ankle axis was then aligned to the axis of the motor and the thigh held in place with padded straps with the knee in extension and supported by the plinth. Seat belt styled supports prevented the body from moving longitudinally up the bed (Figure 6.1).

A custom-designed servomotor controlled by a digital signal processor, was used to measure stiffness and strength and apply a stretch at a constant torque. The servomotor was programmed to administer a low, medium or high constant torque over the 30 minute stretching period. Ankle position started from a standard position of 10° plantarflexion. The required level of torque built up over a 20 second period and allowed the muscle to be gradually stretched slowly and safely (Yeh et al. 2004). Safety features for the motor were used as indicated in chapter four section 4.6.2.



**Figure 6.1:** *Experimental setup: participant in semi-reclined position with the test foot attached to a footplate at 0°.*

#### **6.2.4 Measurement of Stiffness, Strength and Range of Motion**

**Stiffness:** The degree of ankle passive stiffness and stretch reflex activity was measured using a servomotor (BSM, UK) by applying a 15-degree amplitude, slow (5 °/s) and fast (175 °/s) ramp stretch respectively while the participant was relaxed as described previously (chapter four, section 4.6.1). Measurements of stiffness were recorded using the servomotor at the beginning of the test session (baseline), immediately post intervention (post\_0) and again at 10 (post\_10), 20 (post\_20) and 30 (post\_30) minutes post stretch. Surface EMG of the tibialis anterior, medial gastrocnemius and soleus muscles was recorded to ensure the participant was relaxed prior to the assessment and to measure the presence of any stretch-induced muscle activity. Additionally, stiffness was measured by a single rater (JO) in the right and left ankle plantar- and dorsi-flexors, knee and hip flexors and extensors using the Ashworth scale (Ashworth, 1964) at the beginning of the session.

**Muscle strength:** Maximum isometric voluntary ankle contractions (iMVC) were recorded with the ankle in 10° plantarflexion at baseline, immediately post-stretch and 30 minutes post stretch; participants received visual feedback of the iMVC and torque applied using a computer monitor.

**Range of Motion:** The range of motion was recorded directly from the BSM servomotor encoder. This measured the position of the motor shaft that was bolted to the manipulandum to an accuracy of  $2.7 \times 10^{-40}$  degrees. The foot at  $90^\circ$  to the shank was defined as neutral or  $0^\circ$ , with positive values indicating dorsiflexion and negative values indicating plantarflexion. Initial baseline ROM was defined as the ankle range 15 seconds after application of the low constant torque from a position of  $10^\circ$  plantarflexion. ROM was also recorded throughout the stretch and AD converted (200 Hz sampling rate) by the power 1401 (CED Cambridge UK).

### **6.2.5 Subjective Report of Stretch**

At 10 minute intervals during the 30 minute stretch participants were asked to score their perceived strength of stretch on a VAS from 0 –10, where 0 = no stretch and 10 = a very strong stretch. In addition, participants were asked to describe and locate the position of the stretch they were feeling.

### **6.2.6 Analyses**

Plantarflexor stiffness and strength were analysed as described previously (chapter four, section 4.7). Position signals during the 30 min stretch were exported at 10 Hz and low pass filtered (4Hz, 1<sup>st</sup> order Butterworth) in MATLAB. The position was measured every 10 minutes to give an indication of how the ROM changed over time.

**Statistical analysis:** Differences in baseline ankle stiffness, strength and ROM between the pwMS and the control group was compared using an unpaired t-test.

In pwMS the effect of applied force on the change in stiffness, ROM, and isometric strength after a 30 minute stretch and the post stretch time course was compared using a repeated measures analysis of variance (ANOVA). Factors were TIME (five levels: baseline, post\_0, post\_10, post\_20, post\_30) and TORQUE (3 levels: high, medium, low).

The relationship between applied torque and the changes in passive and stretch reflex-mediated stiffness and between the baseline stiffness and the change in stiffness was determined using linear regression analysis.

For all statistical tests, the level of significance was set at  $P < 0.05$ .

## **6.3 Results**

### **6.3.1 Demographics and Baseline Characteristics**

Seventeen pwMS were assessed. Two of the participants recruited were unable to complete the study due to pre-existing recurrent back pain and a reported disc prolapse following the first session. One other participant was unable to tolerate the high constant torque applied and was therefore unable to complete the study in its entirety.

The sample therefore comprised of 14 pwMS and 13 matched healthy controls, further details of the sample can be found in table 6.1 and 6.2 which provides a summary of the demographic characteristics and outcomes of the self-report questionnaires for this sample. All participants could achieve plantigrade ( $90^\circ$ ) at the ankle.

Subject	Group	Gender	Age(years)	Height(cm)	Weight(kg)	MS Type	Duration of MS (years)	Anti-spastic medication	EDSS	Participated in S1
1	MS	F	50	164.7	75	SPMS	17	Baclofen	7.0	N
2	MS	M	42	193.0	86	RRMS	1.5	NO	4.5	Y
3	MS	F	57	162.2	68	RRMS	6	NO	4.5	N
4	MS	F	65	154.1	55	PPMS	3	NO	6.0	Y
5	MS	F	68	157.2	61	SPMS	30	Baclofen	6.0	N
6	MS	M	62	181.0	133	PPMS	2	NO	6.5	Y
7	MS	F	49	170.0	64	RRMS	1.2	NO	4.5	Y
8	MS	F	62	157.5	105	SPMS	35	NO	6.0	N
9	MS	F	54	169.0	67	PPMS	1.1	NO	4.5	Y
10	MS	F	61	164.5	75	SPMS	4	NO	4.5	Y
11	MS	F	48	158.0	62	SPMS	20	Baclofen	6.5	Y
12	MS	F	43	164.4	51	RRMS	4	NO	4.5	N
13	MS	M	63	179.0	101	SPMS	4	NO	6.5	N
14	MS	F	77	175.0	65	PPMS	7	NO	6.0	Y
15	CON	M	56	175.0	73	NA	NA	NA	NA	NA
16	CON	M	52	177.0	71	NA	NA	NA	NA	NA
17	CON	F	49	166.5	66	NA	NA	NA	NA	NA
18	CON	F	45	168.0	69	NA	NA	NA	NA	NA
19	CON	F	56	168.0	134	NA	NA	NA	NA	NA
20	CON	F	64	159.0	60	NA	NA	NA	NA	NA
21	CON	F	59	154.5	57	NA	NA	NA	NA	NA
22	CON	F	54	154.5	70	NA	NA	NA	NA	NA
23	CON	F	55	167.5	65	NA	NA	NA	NA	NA
24	CON	F	56	159.5	63	NA	NA	NA	NA	NA
25	CON	F	55	153.5	62	NA	NA	NA	NA	NA
26	CON	F	50	167.5	78	NA	NA	NA	NA	NA
27	CON	F	67	153.5	66	NA	NA	NA	NA	NA
PwMS	N=14	F=11 M=3	Mean:57.21 SD ± 10.04	Mean:167.12 SD ±10.78	Mean:76.29 SD ± 22.72	SPMS =6 RRMS=4 PPMS=4	Mean :9.70 SD ±11.26	N=3	Mean:5.54 SD ± 0.97	Y=8 N=6
Controls	N=13	F=11 M=2	Mean:55.23 SD ± 6.00	Mean:163.35 SD ± 8.16	Mean:71.85 SD ± 19.51	N/A	N/A	N/A	N/A	

**Table 6.1:** Participant Demographics and baseline characteristics CON = Control Group; N/A = not applicable. Columns 1-6 contain information about: subject number, each individual belonging to the patient or control group, gender, age, height, weight. Columns 7-10

*contain information regarding MS participants including: MS type relapsing remitting MS (RRMS), primary progressive (PPMS), secondary progressive MS (SPMS) and duration, the use of anti-spastic medication and EDSS score. Mean  $\pm$  standard deviations are indicated.*

OUTCOME MEASURES	SCORES
Barthel Index (score range 0-100)	95 (5)
MSWS12(t) (score range 0-100)	45 ± 23 (30)
MSSS88 (score range 0-352)	139 (86)
Ashworth right ankle plantarflexors (score range 0-4)	1 (2)
Ashworth left ankle plantarflexors (score range 0-4)	1 (1)
Ashworth right knee extensors (score range 0-4)	1(1)
Ashworth left knee extensors (score range 0-4)	1 (1)
Ashworth right knee flexors (score range 0-4)	1 (2)
Ashworth left knee flexors (score range 0-4)	1 (2)
Ashworth right hip extensors (score range 0-4)	0 (1)
Ashworth left hip extensors (score range 0-4)	1 (1)
Ashworth right hip flexors (score range 0-4)	0 (1)
Ashworth left hip flexors (score range 0-4)	0 (1)

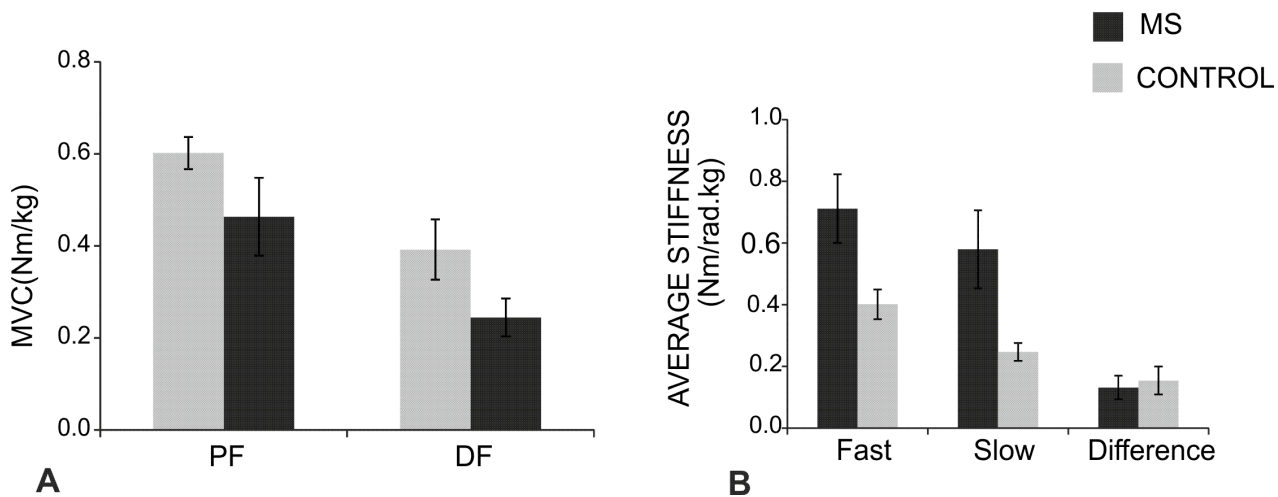
**Table 6.2:** Clinical descriptors of people with MS: Barthel Index (Median (IQR)); Transformed MSWS12(t) (Mean ± Standard deviations, (IQR)); MSSS88 (Median (IQR)); Ashworth scores (Median, (IQR)) are indicated.

### 6.3.2 Comparison of Baseline Characteristics with Control Participants

#### 6.3.2.1 Stiffness and Muscle Strength

Dorsiflexor isometric strength was significantly reduced in pwMS ( $t=-2.70$   $P=0.01$ ) compared to the matched control group. However, although the plantarflexor muscles were weaker in pwMS this was not statistically significant ( $t=-1.28$   $P=0.21$ , Figure 6.2a). Slow ( $5^{\circ}/s$ ) stretches did not elicit any EMG activity. The passive stiffness in the plantarflexors measured during the slow stretch was significantly higher in pwMS ( $t=2.47$   $P=0.02$ ). Fast ( $175^{\circ}/s$ ) stretches resulted in EMG activation in all pwMS. The difference between the slow and fast stretch, indicative of the size of the stretch reflex, was not significantly different between the groups ( $t=-0.39$   $P=0.70$ , Figure 6.2b).

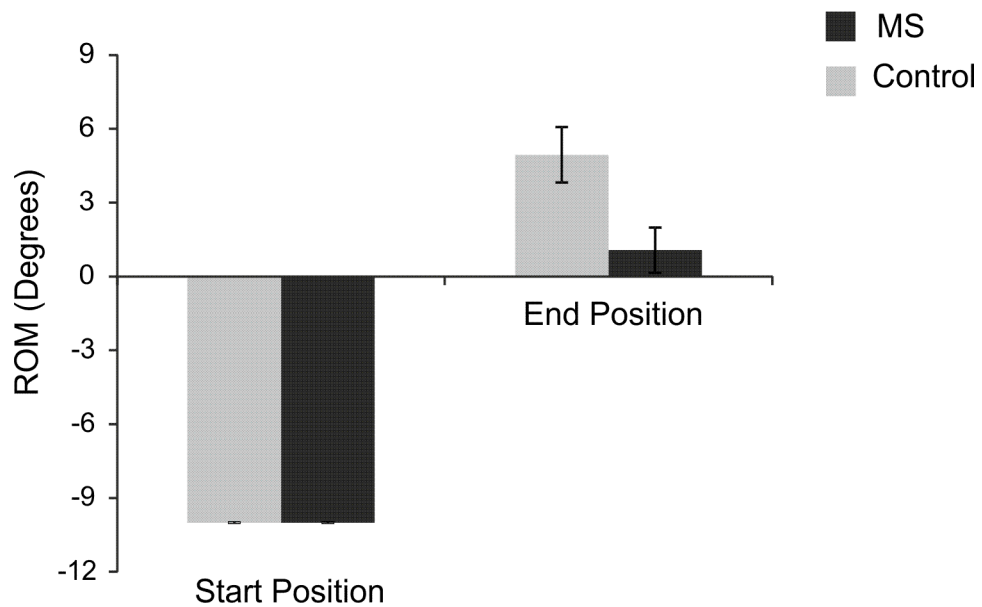




**Figure 6.2:** A) Maximum voluntary contraction (MVC) recorded in Nm/kg (PF = Plantarflexor DF = Dorsiflexor strength), B) Average plantarflexor stiffness in Nm/rad./kg. Standard error of the mean (SEM) is indicated.

### 6.3.2.2 Range of Movement

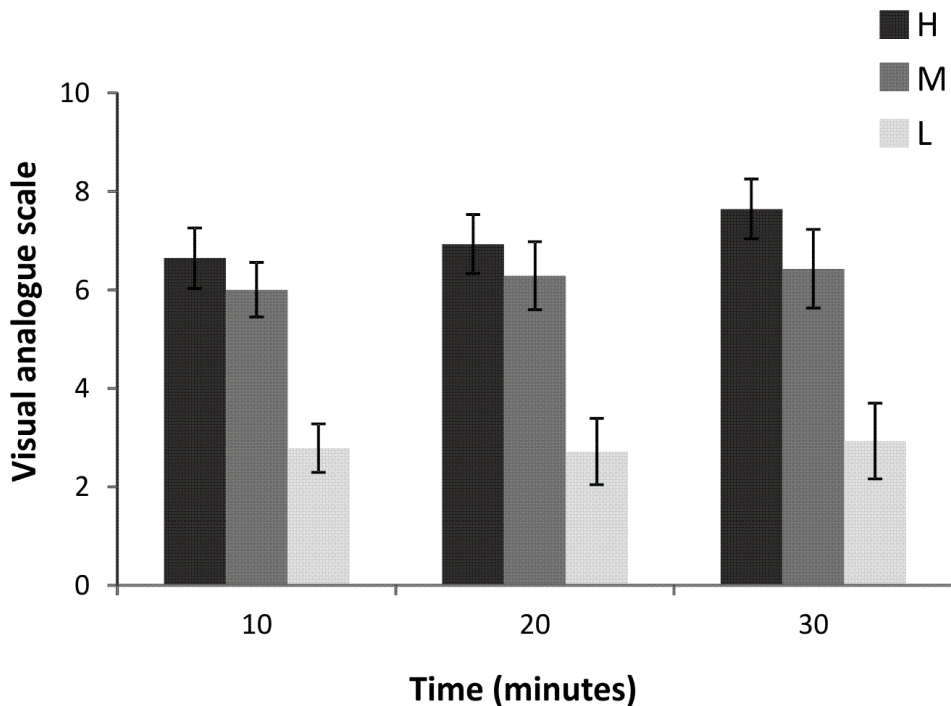
Initial baseline ROM was significantly lower in pwMS compared to the matched control group ( $t=-2.32$   $P = 0.04$ , Figure 6.3). This may be due to the significantly increased level of passive stiffness present in the pwMS at baseline.



**Figure 6.3:** Initial baseline ankle ROM for MS and control group from a position of 10° plantarflexion (start position) to 15s after application of the low constant torque (end position). Standard error of mean (SEM) indicated.

### 6.3.3 Subjective Report of Stretch in pwMS (n=14)

A Kolmogorov-Smirnov test revealed that the VAS data was not normally distributed. The data was therefore analysed using a Friedman non-parametric test after averaging across torque or time. There was a significant difference in perceived strength of stretch with torque ( $P=0.01$ ); with the largest difference occurring between the medium and low torques (Figure 6.4). There was no significant difference in the perceived strength of stretch reported over time ( $P=0.24$ ). Of the participants, 81% reported feeling the stretch sensation in their calf, 9% in the back of the knee, 2% in the hamstring muscle and 8% were unsure. These results are general and not specific to the applied torque.



**Figure 6.4:** Self-reported strength of stretch on a visual analogue scale ranging from 0-10. Mean +/- standard error of the mean (SEM) indicated. H = high torque M = medium torque L = low torque.

### 6.3.4 Change in Stiffness with Applied Torque in pwMS

Stiffness data were obtained at five time intervals; base= baseline; post\_0= immediately post stretch; post\_10= 10 minutes post stretch; post\_20= 20 minutes post stretch; post\_30= 30 minutes post stretch.

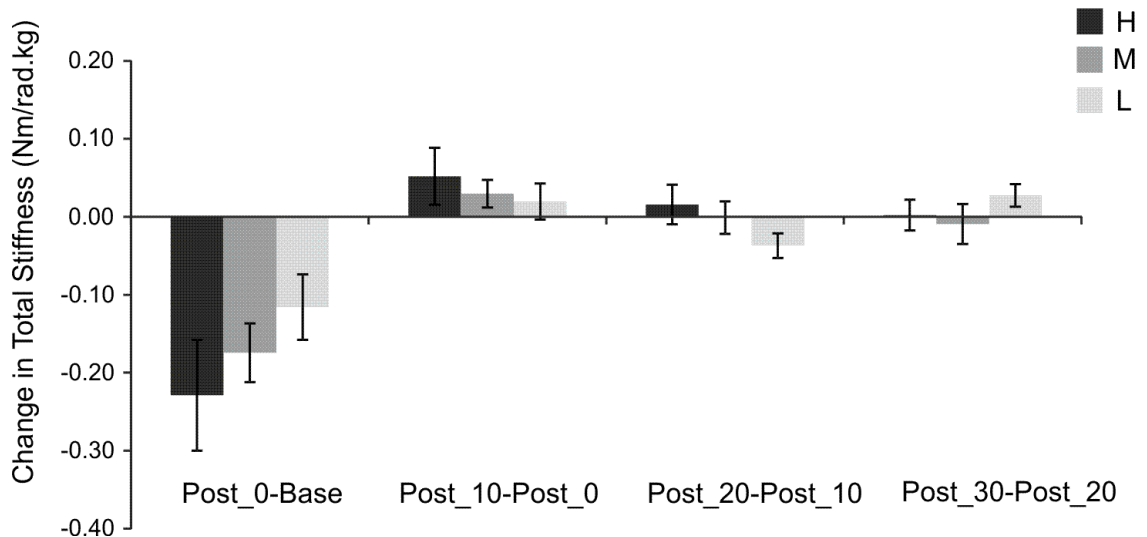
#### 6.3.4.1 Changes with Stretch

**Total Stiffness:** There was no significant difference in total plantarflexor stiffness with torque (TORQUE  $F(2,26)=0.062$   $p=0.940$ ). However, there was a significant difference in total plantarflexor stiffness over time (TIME  $F(4,52)=17.1$   $p=0.001$ ), with a significant reduction in stiffness between baseline and post\_0 (TIME  $F(1,13)=25.7$   $p=0.001$ ); the stiffness then increased between post\_0 and post\_10 (TIME  $F(1,13)=14.6$   $p=0.002$ ) and then it slightly decreased between post\_10 to post\_20 (TIME  $F(1,13)=11.5$   $p=0.005$ ) (Figure 6.5). There was no significant TORQUE X TIME interaction

( $F(8,104)=0.32$   $p=0.80$ ). The overall decrease in stiffness from the start of application of the stretch to the end of monitoring (60 minutes later) is given in table 6.3.

Total Stiffness (Nm/rad.Kg)					
	Base	Post_0	Post_10	Post_20	Post_30
H	0.74±0.49	0.52±0.29	0.57±0.34	0.58±0.32	0.58±0.32
M	0.69±0.49	0.52±0.46	0.55±0.44	0.55±0.45	0.54±0.40
L	0.65±0.32	0.53±0.23	0.55±0.23	0.51±0.22	0.54±0.23

**Table 6.3:** Average total stiffness for pwMS during and after stretches with different torques. Mean (Nm/rad.kg) ± standard deviation is indicated.

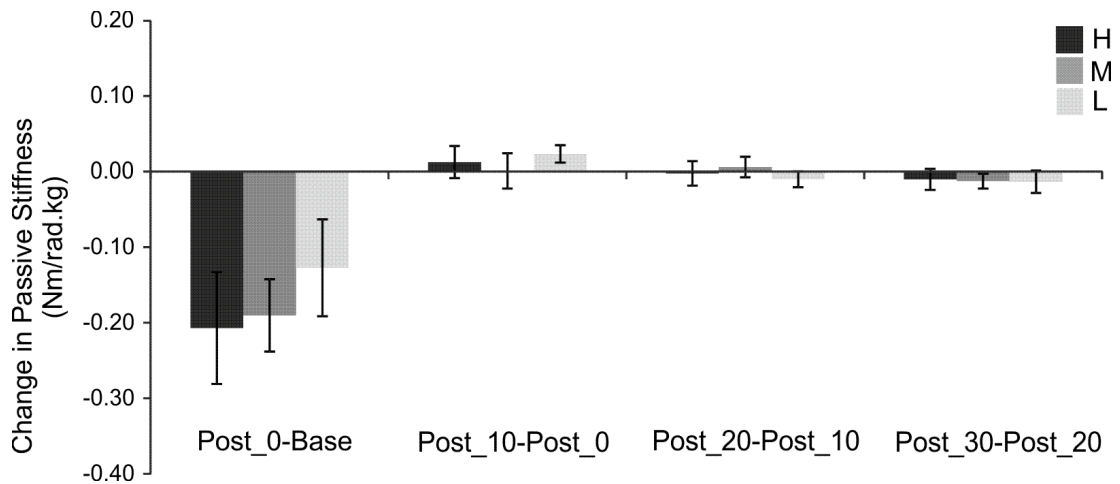


**Figure 6.5:** Change in total stiffness in pwMS between (i) baseline and post stretch (Post\_0 Base), (ii) immediate post stretch and 10 minutes post stretch (Post\_10-Post\_0), (iii) 10 minutes post stretch and 20 minutes post stretch (Post\_20-Post\_10); 20 minutes post stretch and 30 minutes post stretch (Post\_30-Post\_20) time period, were compared against the applied torque. Standard error of mean (SEM) indicated. H = High torque M = Medium torque L = Low torque. Negative values indicate a reduction in stiffness.

**Passive Stiffness:** There was no significant difference in passive stiffness with torque (TORQUE  $F(2,26)=0.16$   $p=0.86$ ). However, there was a significant difference in passive stiffness over time (TIME  $F(4,52)=11.9$   $p=0.003$ ), with a significant reduction in passive stiffness post stretch (post\_0-Base) (TIME  $F(1,13)=14.6$   $p=0.002$ ); stiffness then significantly increased 10 minutes post stretch (post\_10 – post\_0) (TIME  $F(1,13)=9.0$   $p=0.010$ ) were it remains constant 20 minutes post stretch and further drops 30 minutes post stretch. There was no significant TORQUE X TIME interaction ( $F(8,104)=0.24$   $p=0.63$ ) (Figure 6.4). The overall decrease in passive stiffness from the start to the end of monitoring (60 minutes later) is given in table 6.6.

<b>Passive Stiffness (Nm/rad.Kg)</b>					
	<b>Base</b>	<b>Post_0</b>	<b>Post_10</b>	<b>Post_20</b>	<b>Post_30</b>
<b>H</b>	0.60±0.58	0.40±0.42	0.41±0.36	0.41±0.35	0.40±0.34
<b>M</b>	0.60±0.58	0.40±0.42	0.41±0.36	0.41±0.35	0.40±0.34
<b>L</b>	0.50±0.31	0.37±0.18	0.39±0.18	0.38±0.18	0.37±0.17

**Table 6.4:** Average passive stiffness in pwMS during and after different stretches. Mean ± standard deviation is indicated

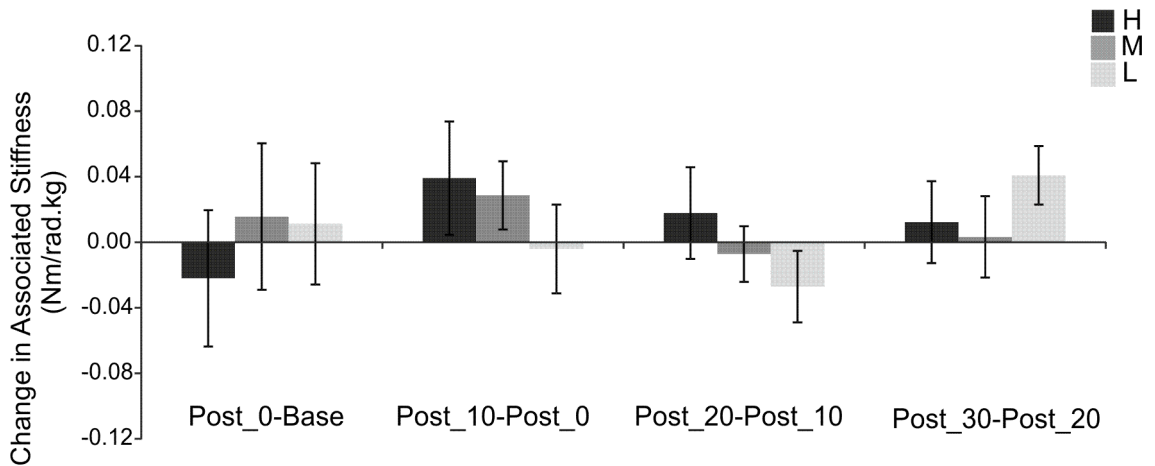


**Figure 6.6:** Change in passive stiffness in pwMS between (i) baseline and post stretch (Post\_0-Base), (ii) immediate post stretch and 10 minutes post stretch (Post\_10-Post\_0), (iii) 10 minutes post stretch and 20 minutes post stretch (Post\_20-Post\_10), 20 minutes post stretch and 30 minutes post stretch (Post\_30-Post\_20) time periods were compared against the applied torque. Standard error of mean (SEM) indicated.

**Stretch Reflex Associated Stiffness:** There was no significant difference in stretch reflex associated stiffness with applied torque (TORQUE  $F(2,26)=2.29$   $p=0.12$ ) and no significant difference seen over the observed time frame (TIME  $F(4,52)=1.70$   $p=0.21$ ). There was no significant TORQUE X TIME interaction ( $F(8,104)= 0.37$   $p=0.81$  ( Figure 6.7 ). The overall decrease in stretch reflex associated stiffness from the start of the stretch application to the end of monitoring (60 minutes later) is given in table 6.5.

Stretch Reflex Associated Stiffness (Nm/rad.Kg)					
	Base	Post_0	Post_10	Post_20	Post_30
H	0.15±0.17	0.13±0.15	0.17±0.15	0.19±0.13	0.20±0.12
M	0.10±0.17	0.11±0.12	0.14±0.11	0.14±0.14	0.14±0.12
L	0.15±0.11	0.16±0.10	0.16±0.10	0.13±0.08	0.17±0.11

**Table 6.5:** Average stretch reflex associated stiffness in pwMS during and after different stretches. Mean ± standard deviation is indicated

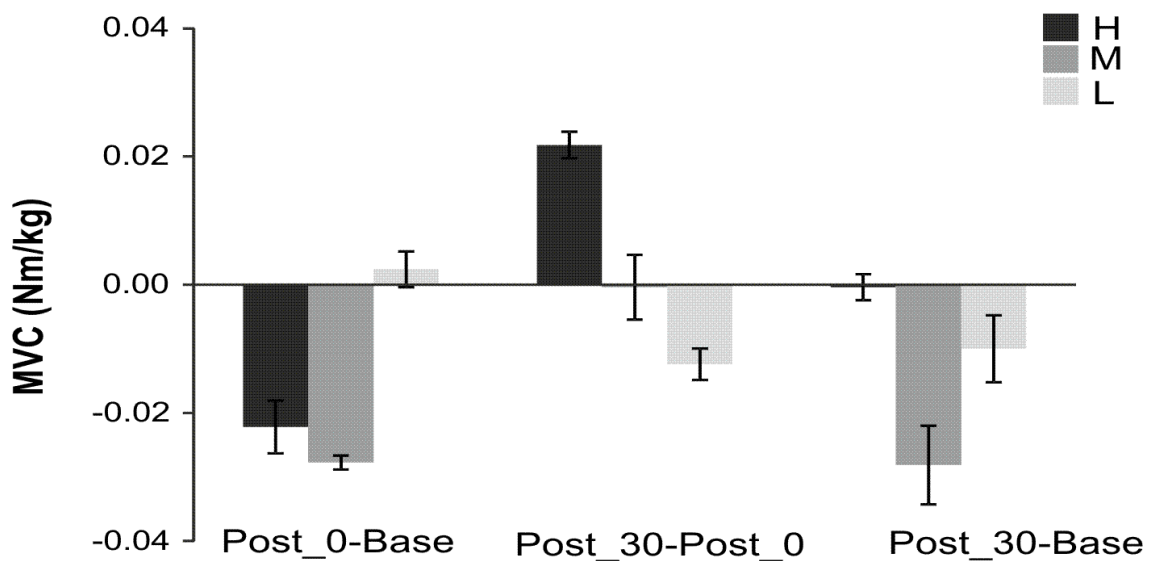


**Figure 6.7:** The difference in associated stretch reflex associated stiffness between baseline and post stretch (Post\_0-Base), immediate post stretch and 10 minutes post stretch (Post\_10-Post\_0), (iii) 10 minutes post stretch and 20 minutes post stretch (Post\_20-Post\_10), 20 minutes post stretch and 30 minutes post stretch (Post\_30-Post\_20) time periods were compared against the applied torque. Standard error of mean (SEM) indicated.

### 6.3.5 Changes in Strength with Applied Torque in pwMS (n=14)

#### 6.3.5.1 Isometric Dorsiflexor Strength

There was no significant difference in isometric strength with torque (TORQUE  $F(2,26)=1.46$   $p=0.25$ ). There was no significant difference over time (TIME  $F(2,26)=0.77$   $p=0.48$ ). There was no significant TORQUE X TIME interaction ( $F(4,52)=0.85$   $p=0.46$ ) (Figure 6.8).

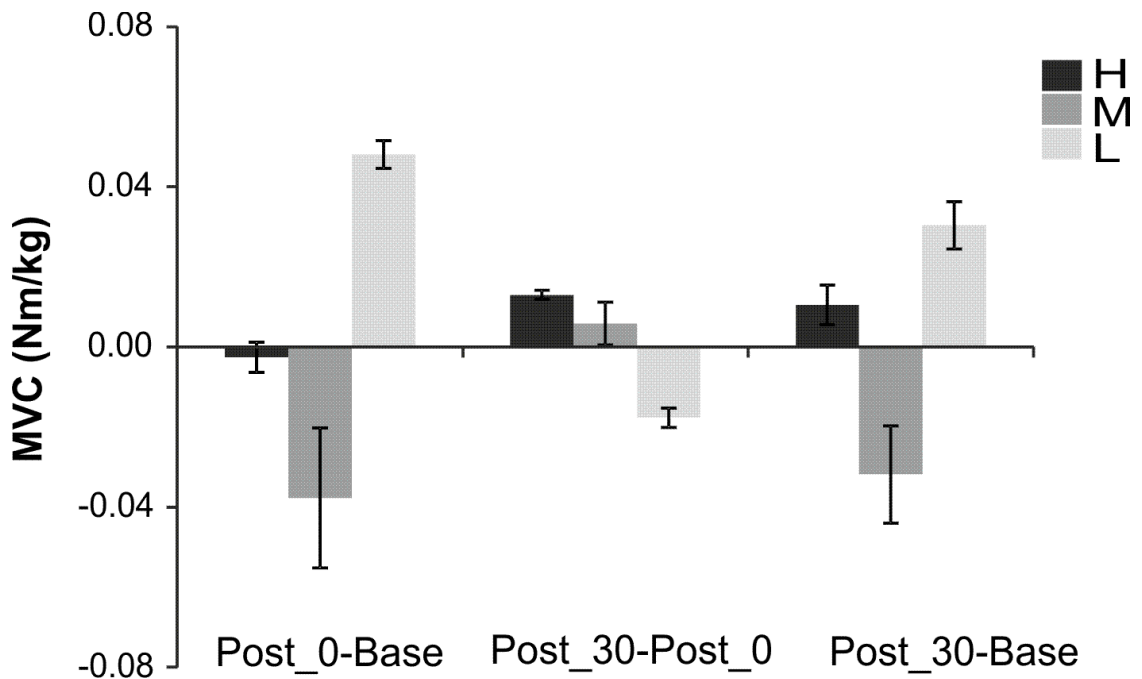


**Figure 6.8:** Change in isometric dorsiflexor strength in pwMS between (i) baseline and post stretch (Post\_0-Base), (ii) immediate post stretch and 30 minutes post stretch (Post\_30-Post\_0), (iii) 30 minute post stretch and baseline (Post\_30-Base) time periods were calculated and compared against the applied torque. Standard error of mean (SEM) indicated.

#### 6.3.5.2 Isometric Plantarflexion Strength

There was no significant difference in isometric plantarflexor strength with torque (TORQUE  $F(2,26)=0.47$   $p=0.63$ ), no significant change in isometric strength over time (TIME  $F(2,26)=0.008$   $P=0.99$ ) and no significant TORQUE X TIME interaction ( $F(4,52)=1.39$   $p=0.25$ ) (Figure 6.9).





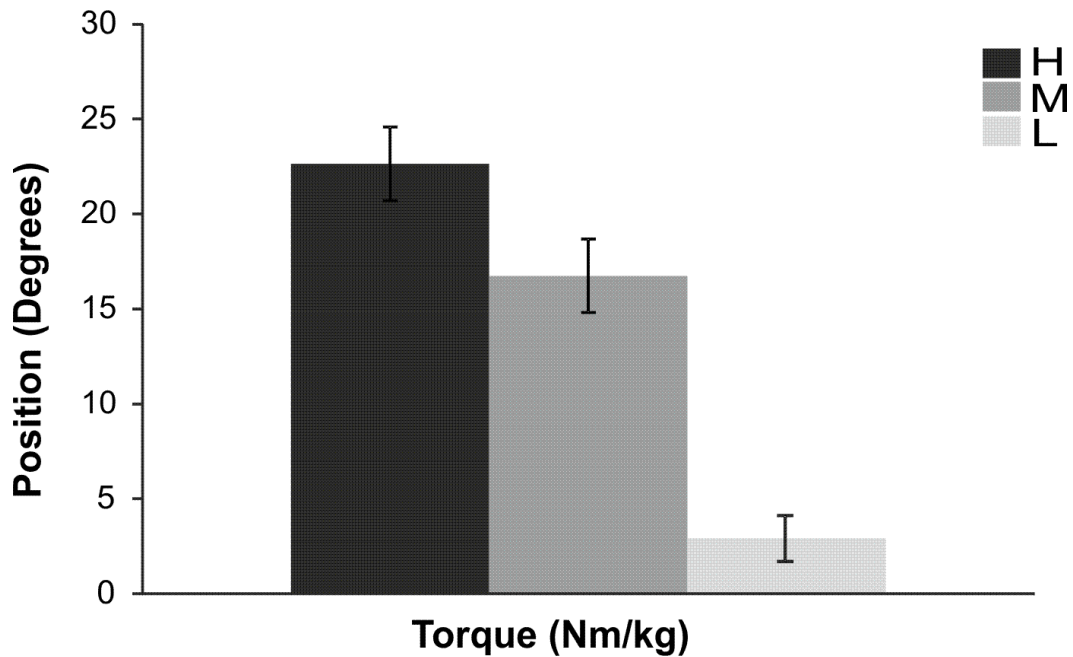
**Figure 6.9:** Change in isometric plantarflexor strength in pwMS between (i) baseline and post stretch (Post\_0-Base), (ii) immediate post stretch and 30 minutes post stretch (Post\_30-Post\_0), (iii) 30 minute post stretch and baseline (Post\_30-Base) time periods were calculated and compared against the applied torque. Standard error of mean (SEM) indicated.

### 6.3.6 Changes in Range of Movement with Applied Torque in pwMS (n=13)

For one participant we were unable to record changes in position in one condition due to technical difficulties. In this participant the changes in ROM for the other two applied torques were similar to the remaining participants.

#### 6.3.6.1 Effect of Applied Torque on End Range Ankle Position

There was a significant effect of torque on end ankle position (29 minutes after stretch onset) (TORQUE  $F(2,24)=34.87$   $p<0.001$ ) with a significant increase in range observed with application of a HIGH torque compared to MEDIUM (TORQUE  $F(1,12)=49.96$   $p<0.001$ ) and MEDIUM compared to LOW (TORQUE  $F(1,12)=27.92$   $p<0.001$ ) (Figure 6.10).

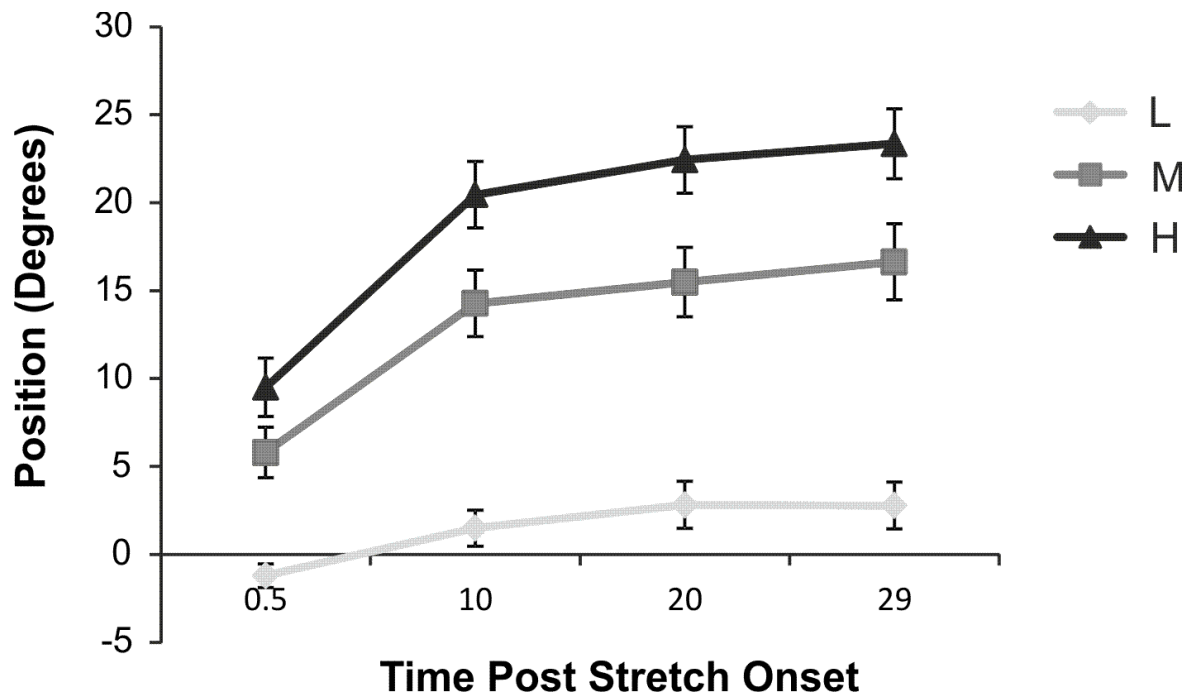


**Figure 6.10:** End foot position (29 minutes post stretch) with the application of a high, medium or low torque in pwMS. Standard error of mean (SEM) indicated.

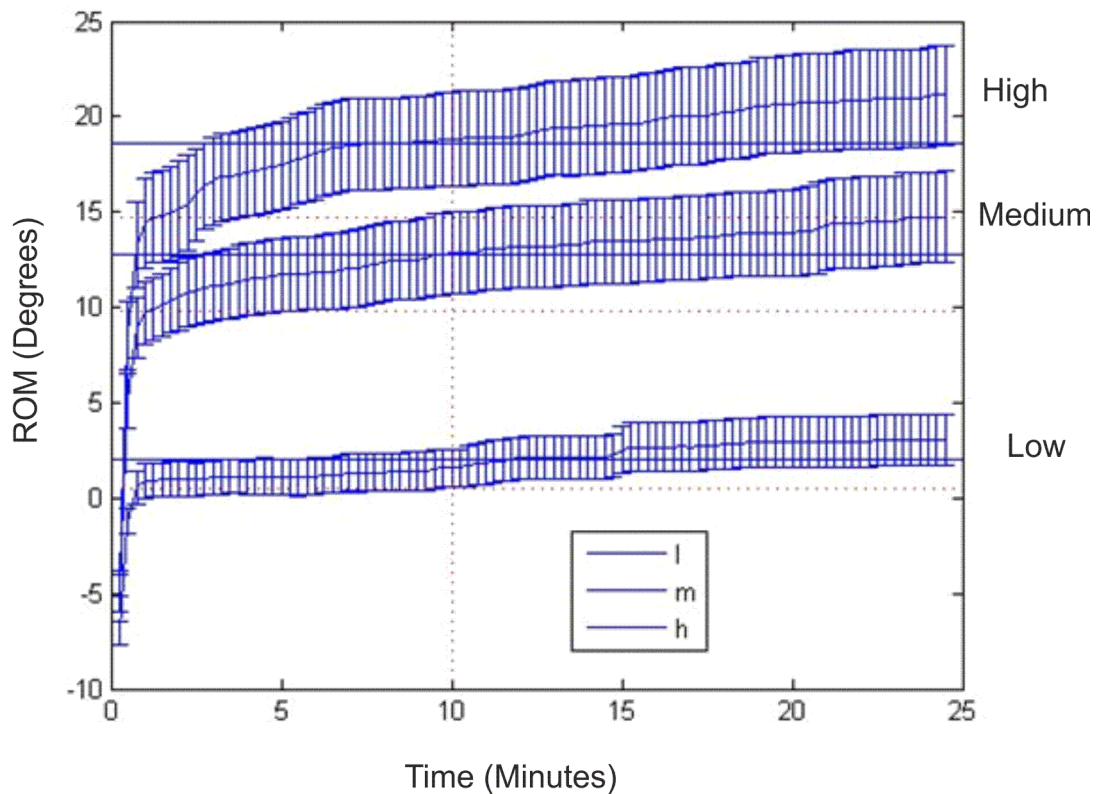
### 6.3.6.2 Changes in Range of Movement during the Stretch

As expected there was a significant effect of time on the position of the ankle (TIME  $F(1,14)= 108.45$   $p=0.001$ ); a priori contrasts revealed a significant increase in position as the duration of the stretch increased ( $p<0.001$ ). There was a significant effect of torque on the position of the ankle at 30 seconds, 10 minutes, 20 minutes and 29 minutes post stretch onset (TORQUE  $F(2,24)= 40.69$   $p=0.001$ ); a priori contrasts revealed a significant increase in ankle position between LOW and MEDIUM ( $F=(1,12)= 49.52$   $p=0.001$ ) and MEDIUM and HIGH ( $F(1,12)= 35.96$   $p=0.001$ ).

There was a significant TORQUE X TIME interaction (TORQUE X TIME  $F(2,22)=13.15$   $p<0.001$ ). This indicated that with a higher applied torque the ROM tended to increase across the whole course of the stretch period whilst with the low torque stretch the ROM tended to plateau after 15-20 minutes ( $p<0.001$ ); this is illustrated in Figure 6.11. Figure 6.12 shows the grand average change in position across time with data being sampled every 0.5 minutes; this and Figure 6.11 highlight that the rate of change of ankle position with applied torque starts to decrease around 7.5-10 minutes.



**Figure 6.11:** Position achieved from 30 seconds to 29 minutes of stretch at a constant torque with the application of a high, medium or low torque in pwMS. Standard error of mean (SEM) indicated.



**Figure 6.12:** Grand average of position data with the application of a constant torque over 25 minutes in pwMS. *l* = low torque; *m* = medium torque; *h* = high torque.

### 6.3.7 Relationship between Applied Torque and Stiffness in pwMS

The application of a 30 minute stretch using the applied low, medium and high constant torques did not produce a statistically significant difference in total stiffness reduction in pwMS (see section 6.3.4.1). However, the relationship between the low absolute applied torque (ie not normalised to body weight) and the change in total stiffness (post stretch-baseline) revealed a significant moderate correlation ( $0.3 \leq r \leq 0.6$ , Cohen, 1988) and a trend towards significance for the high and medium torques (see Table 6.6) potentially suggesting a relationship between absolute applied torques and change in stiffness.

CONDITION	R value	P value
High torque – change in total stiffness	0.49	0.072
Medium torque – change in total stiffness	0.49	0.073
Low torque – change in total stiffness	0.56	0.046

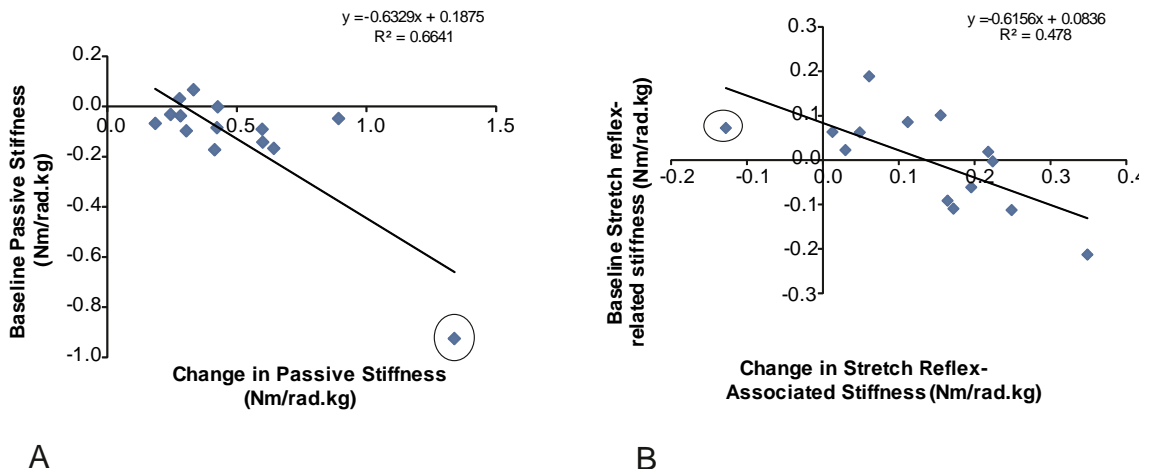
**Table 6.6.** *Relationship between absolute applied torque and change in total stiffness in pwMS. Change in total stiffness = post stretch – baseline. R = Pearson’s rank correlation*

### 6.3.8 Relationship between Baseline Stiffness and Change in Stiffness in pwMS

To explore the relationship between the baseline stiffness and the change in stiffness the grand average stiffness across the three applied torque conditions were calculated. The difference in stiffness with stretching (post-pre) was calculated where negative values indicate a reduction in stiffness. There was a strong ( $r \geq 0.8$ , Cohen 1988) significant relationship between the baseline passive stiffness and the change in passive stiffness (Table 6.7, Figure 6.14A); this is dominated by one participant who had a baseline stiffness that was 1.3Nm/rad.Kg. However without this participant the relationship was still significant ( $R^2=0.48$ ) There was also a moderately strong ( $r \geq 0.6$ , Cohen 1988) significant relationship between the baseline stretch reflex-related stiffness and the change in stretch reflex-related stiffness (Table 6.7, Figure 6.13 B). This suggests that higher levels of baseline stiffness were associated with greater reductions in stiffness with stretching.

CONDITION	R value	P value
Baseline passive stiffness Vs change in passive stiffness	0.74	<0.005
Baseline stretch reflex associated stiffness Vs change in stretch reflex-associated stiffness	0.69	0.006

**Table 6.7** Relationship between baseline passive stiffness and change in passive stiffness in pwMS; baseline stretch reflex related stiffness and change in stretch reflex related stiffness across all torques. **R** = Pearson's rank correlation



**Figure 6.13:** Correlation between baseline passive stiffness and stretch reflex related stiffness and the change in these measures post stretch in pwMS, across all applied torques. There was still a significant relationship in both A and B when the outliers indicated by a circle were omitted.

## **6.4 Discussion**

The overall aim of this second study was to understand the impact of 30 minutes of stretching at three different constant torque levels on stiffness, muscle strength, and ROM, and how this varied in the 30 min period post stretch.

### **6.4.1 Change in Stiffness with Applied Torque**

In this study there was no significant effect of torque on reductions in total stiffness, passive stiffness or stretch-reflex associated stiffness. It is possible that no significant effect of torque was found due to the variability (as indicated by the high SD's and SEM's) among the participants; it is also possible that the sample size may not have been large enough to observe an effect. For example, for the measures of total stiffness with a sample size of 14 and the SD observed in the study (0.19 on average) and power=0.85 there would need to be a 70% difference in the reduction in stiffness with stretching between torque conditions to reach statistical significance. In this study there was a 50% difference in stiffness change following the high and low torque stretch; this would require a sample size of 28 to detect a significant difference. In addition, the torques selected and used in this current study were based on those produced by pwMS when performing commonly prescribed clinical stretches over 15 seconds (Hall et al., 2010). However, the high torque (0.66 Nm/Kg) observed in this study was not tolerated by early participants when applied in the current non-weight bearing position for up to 30 minutes. Therefore, to ensure participation by all subjects a middle value between the original high (0.66 Nm/Kg) and medium (0.30 Nm/Kg) torque found in chapter five was calculated and used as the new high torque (0.42Nm/Kg). It is possible that differences in the change in stiffness may have been detected with a higher applied torque.

There was a moderate statistically significant correlation between the low absolute torque applied and the change in total stiffness and a trend toward significance for the medium and high applied torque (section 6.3.7). This potentially suggests that absolute torque levels may be important. This study applied torques shown to be producible by

people with MS that was scaled to their body weight, on the assumption that this reflects the torques that would be able to be typically applied by pwMS during a home programme, i.e. people use their body weight as the constant torque. However, the body weight range of the participants was large (51-133 Kg). This meant that for the low torque stretch the heaviest participant was stretched with a torque of  $133\text{Kg} \times 0.18\text{Nm/Kg} = 23.94\text{Nm}$ , whilst at the high torque level the lightest participant was stretched with a torque of  $51\text{ Kg} \times 0.42\text{Nm/Kg}=21.42\text{ Nm}$ . This overlap in the absolute levels of applied torque between different conditions may be why no effect of torque was found when it was normalised to body weight, that is it may be the absolute torque level applied that is important. This is however speculative and absolute torque may not have an influence on change in stiffness.

#### **6.4.2 Change of Stiffness over Time**

There was a significant reduction in total stiffness (18-25%) and passive stiffness (30-40%) measures with stretching. This is in keeping with work by Yeh et al. (2005) who looked at the effects of 30 minutes of stretching at a constant torque on ankle hypertonia in stroke patients, where a significant reduction in immediate elastic and viscous component of the hypertonic muscle was found. However, it is not evident from the study how long this benefit was maintained for. This current study found that the gains made in reduced stiffness during the stretch period were generally well maintained, with only a 4% increase in stiffness relative to baseline over the subsequent 30 minute post stretch period.

It was observed that passive stiffness continued to decrease between 20-30 minutes post stretch. The low torque applied in the intervention tended to only achieve a maximum end position of  $3^\circ$  plantarflexion whereas the stiffness assessment procedure undertaken at regular 10 minute intervals post stretch moved the ankle between  $-10^\circ$  of plantarflexion through to  $5^\circ$  of dorsiflexion, therefore achieving a greater ROM and degree of stretch than that seen during the intervention. It is therefore possible that the



administration of this method of assessing stiffness may have resulted in further reductions in stiffness during the rest period. Muscles behave in a thixotropic manner in that their stiffness is dependent on movement (Nuyens et al. 2002). When stretch is applied to a relaxed muscle that has been maintained in a lengthened position the initial resistance is lower (Lakie & Robson, 1988). It is possible that the innate thixotropic properties of muscle may have resulted in a further reduction in stiffness post stretch due to a decrease in viscosity and muscle stiffness.

There was no effect of stretching on stretch-reflex associated stiffness. Both passive stiffness and spasticity are common problems in MS. However, our objective measures suggest that while passive stiffness and spasticity are both evident, in this second study it is the passive element that is particularly high in this sample; ~84% of the total stiffness was explained by the passive stiffness element. This is in contrast to the first study's sample (chapter five) in whom only 53% of the total stiffness was explained by the passive stiffness element. This is not felt to be due to the different motors used to deliver the perturbations; the manipulandum used and the peak velocities achieved and amplitude moved were identical. This is supported by the fact that, in the seven participants who completed both studies, there was no significant difference in passive stiffness measured using the different devices.

MS is a disease in which the clinical presentation of individuals is markedly variable; this discrepancy may have therefore occurred because of the natural heterogeneity of this disease group. It is possible that the reductions in passive stiffness seen in this second study are a direct result of a high baseline level of passive stiffness. Furthermore that the lack of effects of the 30 minute stretch on spasticity may be because this sample was predominately comprised of people with only mild reflex mediated stiffness (spasticity), rather than a lack of effect of stretch on spasticity per se.

### **6.4.3 Change in Strength with Stretching**

There was no significant difference in isometric plantarflexor or dorsiflexor strength in pwMS with applied torque and no effect of time. Compared with pre-stretch, dorsiflexion strength (as determined by maximal isometric contractions) decreased post stretch by 9% and this remained below the baseline value by 2% at 30 minutes post-stretch. In contrast plantarflexor maximum isometric strength was not reduced with the application of a stretch and remained relatively constant throughout the experimental period.

Reductions in maximal muscle strength following stretching have been reported in healthy participants (Fowles et al. 2000). In keeping with the explanations of the previous study it is possible that the sustained shortened position of the dorsiflexors during the stretching of the plantarflexors may have altered the force-length characteristics of the muscle. The assessment of length tension relationships was not carried out in this study. Future work will look at the relationship between isometric strength with the ankle in different positions.

### **6.4.4 Dorsiflexion Range**

Muscle stretching regimes are based on the assumption that stretching increases muscle extensibility and preserves/improves joint ROM for functional movement. It is thought that impaired mobility and prolonged spasticity lead to structural changes in muscle fibers and connective tissue, resulting in a reduction in joint ROM (Zhang et al. 2002). This is reflected by the baseline characteristics of this study sample wherein high levels of passive stiffness were observed, compared to the healthy controls. In addition, the pwMS had an average baseline dorsiflexion range of 1° compared to 5° dorsiflexion in the healthy controls, when measured 15s after the application of a low torque. It is postulated that this reduced range is due, in part, to the enhanced level of passive stiffness observed.

This study indicates that ROM increases with stretching and that this is greater with higher applied torques. This result is similar to work by Yeh in people with stroke who reported that the average ROM of ankle dorsiflexion increased significantly after a single sustained muscle stretching session for 30 minutes at a constant torque (Yeh et al. 2007). This was significantly higher than the improvements in range obtained when stretching at either a constant angle or cyclically (Yeh et al. 2007).

The time taken to achieve a similar percentage of the maximal achieved ROM varied with different levels of applied torque. With higher torques it took longer to achieve the same percentage in ROM due to the fact that the end positions varied and stretching continued throughout the application of the higher torques. This gradual increase in ROM over time is interpreted as being due to tissue creep. When connective tissues are stretched under a constant load there is a time dependent deformation (Bressel and McNair, 2002). The slow deformation is due to the viscosity of the tissue whilst the end range achieved is an indicator of the elasticity (stiffness) of the tissue (Gajdosik 2001). With higher applied loads the rate of deformation is initially high and this decreases the time for the viscous component to dissipate, resulting in a longer time period to achieve maximal ROM. Thus, in tissues that have a large viscous component (e.g. spastic muscle), higher forces applied for a short period of time may not provide the most effective stretch for increasing ROM. However, from Figure 6.10 it is clear that ROM traces for different applied torques diverge after the first minute so this may only apply to a very short duration stretch (i.e. <30s).

Figure 6.11 illustrates that in this study a large majority of the end range achieved was obtained after only 10 minutes of stretching: ~95% of the maximal range with the application of the low torque and ~65% of the maximal range with the application of the medium and high torques. A similar study assessing the time course of musculotendinous stiffness responses following different durations of passive stretching found that, in healthy participants, stretching for eight minutes reduced

musculotendinous stiffness and this remained reduced for 20 minutes post stretch (Ryan et al. 2008). Thus it can be seen that, at least in healthy individuals, similar increases in ROM and reductions in stiffness may be achieved with much shorter duration stretches than those applied in this MS study. Whether this is also the case in people with MS is important to establish since shorter duration stretches are clinically more feasible. Currently it is unclear whether the immediate effects of stretching over this shorter duration would be maintained over the post stretch period or whether this only occurs with longer durations of stretch. Subsequent work in chapter 7 will therefore establish if stretching for 10 minutes at a constant torque is able to reduce passive stiffness and improve ROM in pwMS and for what length of time any reductions are maintained.

## **7. Chapter Seven: The Effect Duration of Stretch and Applied Torque on Plantarflexor Stiffness in People with Multiple Sclerosis.**

### **7.1 Introduction**

The previous study (chapter 6) found that ankle plantarflexor stiffness significantly reduced following a 30 minute constant torque stretch. Three different torque levels were applied: a high, medium and low which were scaled relative to the participants' body weight. While there was no observable effect of applied torque on either measure of plantarflexor stiffness (passive and stretch-reflex mediated), there was an effect of applied torque on the range of motion gained during the stretch. Analysis of the change in ROM during the stretch suggested that increases in range started to plateau after 10 minutes of stretching especially for the low applied torque.

The possibility of short duration stretches achieving similar effects on stiffness and ROM would be clinically more convenient for therapists and patients alike. However, with shorter durations of stretch it is possible that there may be an effect of applied torque on plantarflexor stiffness; this needs to be considered. Therefore, the aim of this third study was to assess the effects of a 10 minute stretch, applied on three separate occasions at the same levels of torque that were applied in study two (chapter six). A description of the effects of a 10 minute stretch on stiffness, strength and ROM is followed by a comparison of the effects of a 30 minute and 10 minute stretch.

### **7.2 Materials and Methods**

#### **7.2.1 Participant Recruitment**

MS participants were recruited through the SWIMS database as outlined previously (section 4.3). Of those recruited, 10 MS participants had also undertaken the 30 minute stretch study described in chapter six. In this third study 13 pwMS were compared to 13 healthy controls recruited from local advertisement at Plymouth University and friends/families of pwMS. Written informed consent was obtained from all participants

and the study was conducted with approval from the NHS Torbay and Devon Research Ethics Committee (Ref-09/H0202/42).

### **7.2.2 Demographics and Baseline Characteristics**

In line with studies one and two, the following baseline characteristics were taken: self-report questionnaires on function (BI and MSWS-12); spasticity (MSSS-88 and Ashworth scale) and disease severity (EDSS). Demographic information including age, weight, height, gender, shank length and thigh length was gathered on all participants. Additionally length of time and type of diagnosis and anti-spasticity medication was recorded at the beginning of the study for pwMS.

### **7.2.3 Intervention**

This third study aimed to identify the effect of a 10 minute constant torque stretch on plantarflexor passive stiffness, stretch reflex excitability, ROM and ankle planter- and dorsi- flexor strength and to determine how this varied over a 30 minute post stretch period. In line with the previous two studies, three torque levels were assessed low (0.18Nm/Kg), medium (0.30 Nm/Kg) and high (0.42 Nm/Kg) over three test sessions with each session separated by a minimum of three days. Constant torque stretches were applied using the apparatus described in chapter 6 (section 6.2.3). The order of the applied torque was randomised between participants using codes generated in MATLAB.

### **7.2.4 Measurement of Stiffness and Strength**

Outcome measures were taken immediately before and after the intervention and at 10 minute intervals for 30 minutes post stretch. The measures used, which are listed below, are described in detail in chapter five:

- 1) Ankle plantarflexor total stiffness
- 2) Ankle plantarflexor passive stiffness

- 3) Ankle plantarflexor stretch reflex-associated stiffness
- 4) Range of motion during the stretch
- 5) Ankle dorsi- and plantar-flexor isometric strength

### **7.2.5 Subjective Report of Stretch**

The subjective rating of the applied stretch was determined using a VAS from 0 –10, where 0 = no stretch and 10 = a very strong stretch; participants were also asked to describe and locate the position of the stretch they were feeling.

### **7.2.6 Measurement of ROM**

The range of motion was recorded directly from the BSM Servomotor Encoder as detailed in chapter six (section 6.2.4). Initial baseline ROM was defined as the ankle range 15 seconds after application of the low constant torque from a position of 10° plantarflexion. ROM was also recorded throughout the stretch at 10 seconds, 3.25 minutes and 7.75 minutes post stretch onset and AD converted (200 Hz sampling rate) by the power 1401 (CED Cambridge UK).

### **7.2.7 Analyses**

Plantarflexor stiffness and strength were analysed as described previously (chapter four, section 4.7); and initial baseline stiffness, strength and ROM between groups were analysed using an unpaired t-test. The effect of applied torque on the change in stiffness, ROM, and isometric strength after a 10 minute stretch and the post stretch time course were analysed using an repeated measures ANOVA with factors being TIME (base,post\_0,post\_10,post\_20,post\_30) and TORQUE (low, medium and high).

The 30 minute (study two) and 10 minute (study three) stretch results were then compared using a between groups repeated measures ANOVA. For all statistical tests, the level of significance was set at  $P < 0.05$ .

## **7.3 Results**

### **7.3.1 Patient Demographics and Baseline Characteristics**

Seventeen pwMS were recruited. Two of the participants recruited were unable to complete the study due to a change in their personal circumstances; two other participants were unable to tolerate the high constant torque applied as they indicated the stretch they were experiencing was beginning to cause pain in the calf and were therefore unable to complete the study in its entirety.

The study sample therefore comprised 13 pwMS, ten of whom had completed both this and the second study described in chapter six. Table 7.1 and 7.2 provides a summary of the demographic characteristics and outcomes of the self-report questionnaires for the sample.



Subject	Group	Gender	Age(years)	Height(cm)	Weight(kg)	MS Type	Duration of MS (years)	Anti-spastic medication	EDSS	Participated in Study 2
1	MS	F	77	165.0	64	PPMS	17	NO	6.0	Y
2	MS	F	55	169.0	71	PPMS	1.5	NO	4.5	Y
3	MS	F	62	164.5	72	SPMS	6	NO	4.5	Y
4	MS	F	67	154.1	55	RRMS	3	NO	6.0	Y
5	MS	F	58	162.2	68	RRMS	30	NO	4.5	Y
6	MS	F	49	170.0	62	RRMS	2	NO	4.5	Y
7	MS	F	55	164.5	71	RRMS	1.2	NO	6.0	N
8	MS	F	43	164.4	52	RRMS	35	NO	4.5	Y
9	MS	F	58	168.0	61	RRMS	1.1	Baclofen	6.0	N
10	MS	F	49	160.3	83	RRMS	4	Baclofen	4.5	N
11	MS	F	51	164.7	72	SPMS	20	Baclofen	7.0	Y
12	MS	M	64	179.0	104	SPMS	4	NO	6.0	Y
13	MS	F	69	157.2	60	SPMS	4	Baclofen	6.0	Y
14	CON	M	56	175.0	73	NA	NA	NA	NA	NA
15	CON	M	52	177.0	71	NA	NA	NA	NA	NA
16	CON	F	49	166.5	66	NA	NA	NA	NA	NA
17	CON	F	45	168.0	69	NA	NA	NA	NA	NA
18	CON	F	56	168.0	134	NA	NA	NA	NA	NA
19	CON	F	64	159.0	60	NA	NA	NA	NA	NA
20	CON	F	59	154.5	57	NA	NA	NA	NA	NA
22	CON	F	54	154.5	70	NA	NA	NA	NA	NA
22	CON	F	55	167.5	65	NA	NA	NA	NA	NA
23	CON	F	56	159.5	63	NA	NA	NA	NA	NA
24	CON	F	55	153.5	62	NA	NA	NA	NA	NA
25	CON	F	50	167.5	78	NA	NA	NA	NA	NA
26	CON	F	67	153.5	66	NA	NA	NA	NA	NA
PwMS	N=13	F=12 M=1	Mean:58 SD ± 9	Mean:165 SD ± 6	Mean:69 SD ± 13	PPMS=2 SPMS=4	Mean:8 SD ± 8	N=4	Mean:5 SD ± 1	N=10
Controls	N=13	F=11 M=2	Mean:55.23 SD ± 6.00	Mean:163.35 SD ± 8.16	Mean:71.85 SD ± 19.51	RRMS=7				

**Table 7.1:** Participant demographics columns 1-6 contain information about: each individual belonging to the patient or control group, gender, age, height, weight and duration of MS. Columns 7-11 contain information regarding MS participants including: MS type relapsing remitting MS (RRMS), primary progressive (PPMS), secondary progressive MS (SPMS) and duration, the use of anti-spastic medication, EDSS score and if the participants were involved in experiment 2. Mean ± standard deviations are indicated.

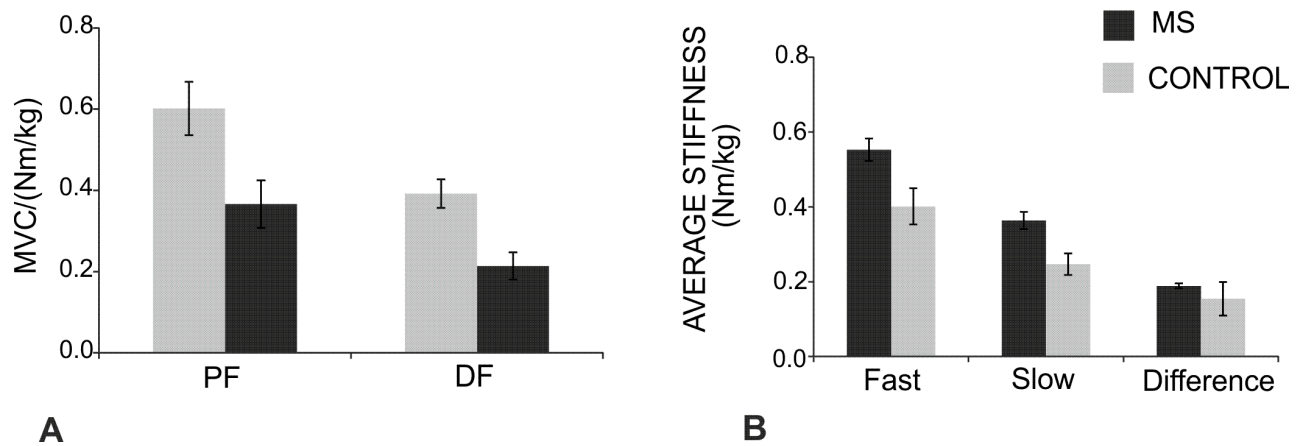
OUTCOME MEASURES	SCORES
Barthel Index (score range 0-100)	90 (10)
MSWS12(t) (score range 0-100)	39 ± 24 (35)
MSSS88 (score range 0-352)	145 (48)
Ashworth right ankle (score range 0-4)	1 (0)
Ashworth left ankle (score range 0-4)	1 (1)
Ashworth right knee extensors (score range 0-4)	1(1)
Ashworth left knee extensors (score range 0-4)	1 (2)
Ashworth right knee flexors (score range 0-4)	1 (2)
Ashworth left knee flexors (score range 0-4)	1 (2)
Ashworth right hip extensors (score range 0-4)	0 (1)
Ashworth left hip extensors (score range 0-4)	0 (1)
Ashworth right hip flexors (score range 0-4)	0 (1)
Ashworth left hip flexors (score range 0-4)	0 (1)

**Table 7.2:** Clinical descriptors of people with MS; Barthel Index (Median (IQR)); Transformed MSWS12 (Mean ± Standard deviations, (IQR)), MSSS88 (Median (IQR)); plantarflexor Ashworth scores (Median, (IQR)).

### 7.3.2 Comparison of Baseline Characteristics with Control Participants

#### 7.3.2.1 Muscle Strength and Stiffness

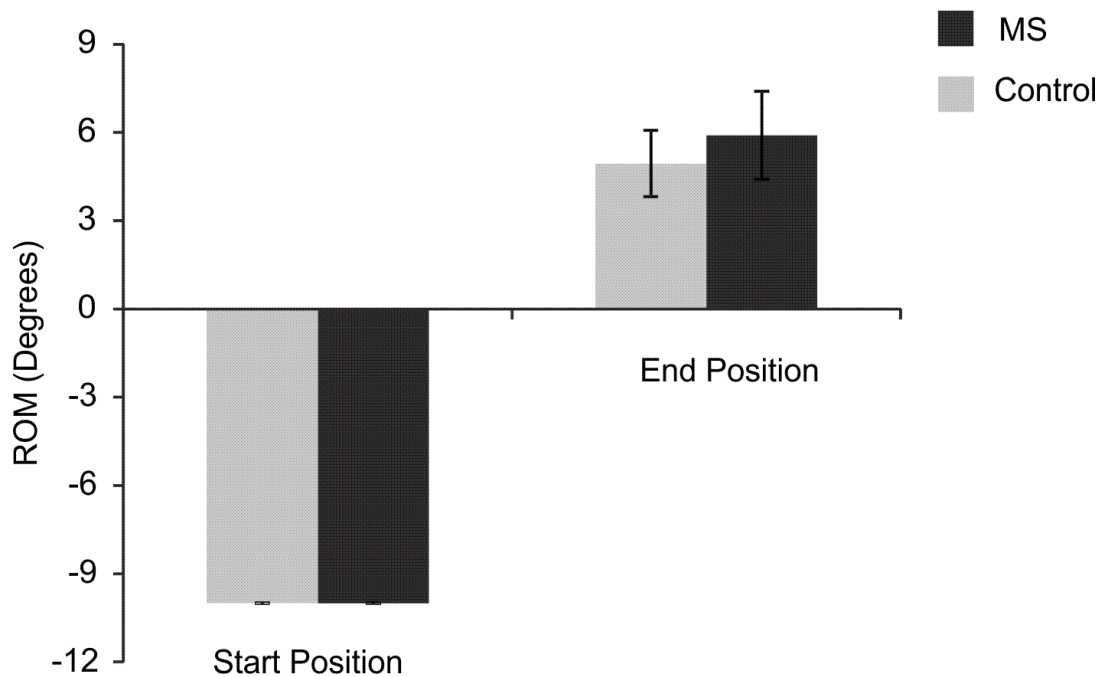
Dorsiflexor and plantarflexor isometric strength was significantly reduced in pwMS (DF t=-3.06 P=0.009); (PF t=-2.52 P=0.03) when compared to the healthy control group (Figure 7.1a). Slow (5°/s) stretches did not elicit any EMG activity in participants of either group. The passive stiffness in the plantarflexors measured during the slow stretch was not significantly different between the pwMS and the control group (t= 1.43 P= 0.18). Fast (175 °/s) stretches resulted in EMG activation in all participants. The difference between the slow and fast stretch, indicative of the size of the stretch reflex, was not significantly different between the two groups (t=1.57 P=0.14, Figure 7.1b).



**Figure 7.1:** A) Maximum voluntary contraction (MVC) recorded in Nm/kg (PF = Plantarflexor; DF = Dorsiflexor strength), B) Average plantarflexor stiffness in Nm/rad.kg. Standard error of the mean (SEM) is indicated.

### 7.3.2.2 Range of Movement (n=11pwMS, n = 13 healthy controls)

Initial baseline ROM was not significantly different between the pwMS and matched control group ( $t=0.54$   $P = 0.60$ ) (Figure 7.2). This may potentially be due to the similarities observed between these groups as indicated in the baseline comparison of passive stiffness and stretch reflex mediated stiffness described above. Two MS participant's data could not be incorporated within this analysis due to an error in the data collection.

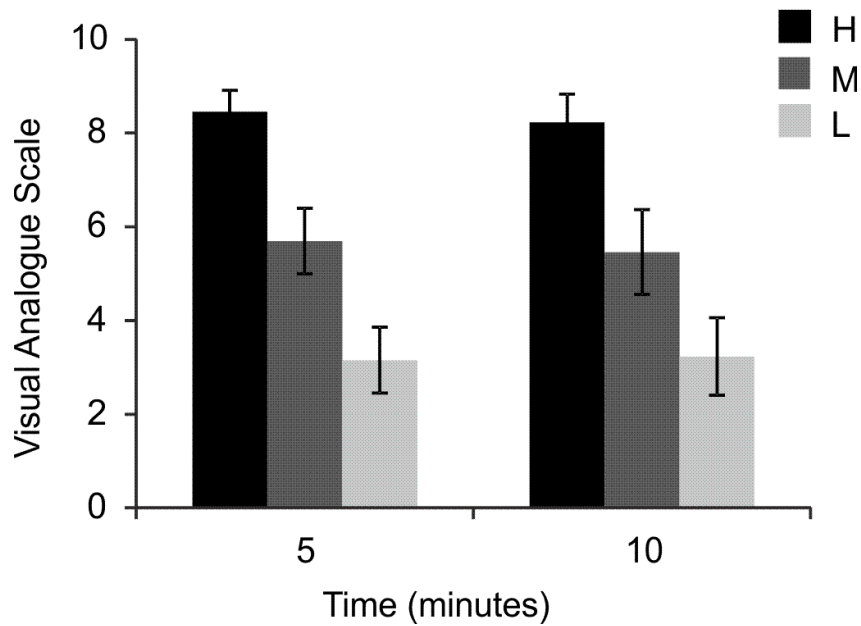


**Figure 7.2:** Initial baseline ankle ROM for pwMS and the control group from a position of 10° plantarflexion (start position) to 15s after application of the low constant torque (end position). Standard error of mean (SEM) indicated.

### 7.3.3 Subjective Report of Stretch in pwMS

A Kolmogorov-Smirnov test revealed that the VAS data was not normally distributed. The data was therefore analysed using a Friedman non-parametric test after averaging across torque or time. There was a significant difference in perceived strength of stretch with torque ( $P=0.01$ ); with the largest difference occurring between the medium and low torques (Figure 7.3). There was no significant difference in the perceived strength of stretch reported over time ( $P=0.56$ ).

Seventy nine per cent of MS participants reported feeling the stretch sensation in their calf; 3% in the back of the knee; 6% in the hamstring muscle and 12% were unable to locate a specific stretch sensation. These results are not specific to an applied torque and encompass results from all three visits.



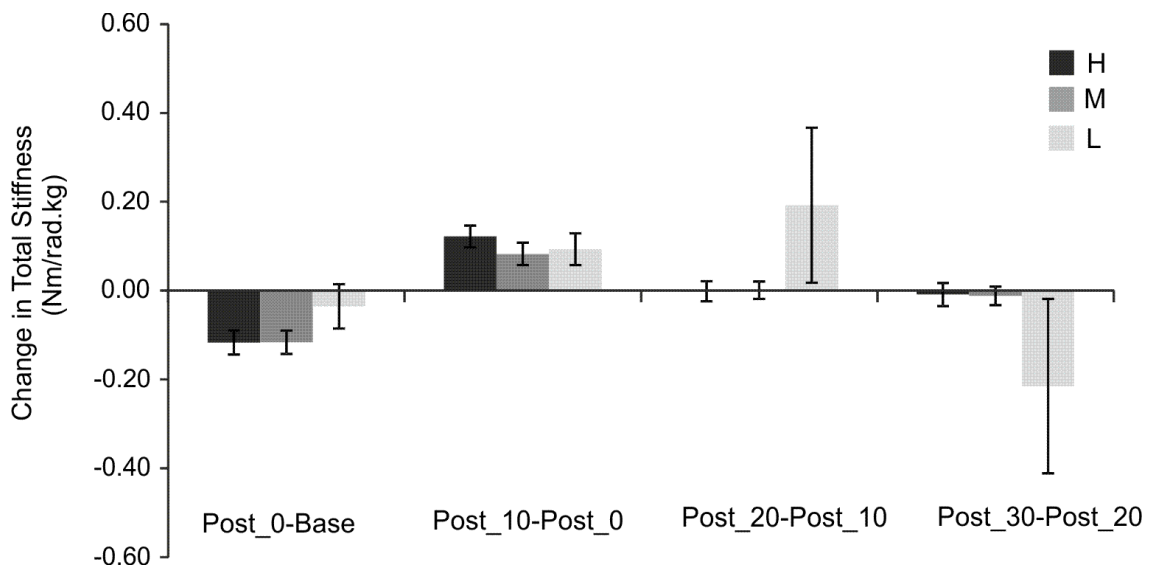
**Figure 7.3:** Self-reported strength of stretch on a visual analogue scale ranging from 0-10 in pwMS. Mean +/- standard error of the mean (SEM) indicated. H = high torque M = Medium torque L = low torque

#### 7.3.4 Change in Stiffness with Applied Torque in pwMS (n=13)

**Total Stiffness:** There was no significant difference in total plantarflexor stiffness with torque (TORQUE  $F(2,24)=0.279$   $p=0.759$ ). Plantarflexor stiffness significantly reduced over the observed time frame ( $F(4,48)=6.222$   $P=0.001$ ). There was no significant TORQUE X TIME interaction ( $F(8,96)=0.918$   $p=0.442$ ) (Figure 7.4). The overall decrease in stiffness from the start of the stretch to the end of monitoring (40 minutes later) is given in Table 7.3. Table 7.3 and Figure 7.4 illustrate that the reduction in total stiffness did not last for more than 10 minutes post stretch. The increase in stiffness 20 minutes post stretch following the low torque stretch is dominated by one participant.

Total Stiffness (Nm/rad.Kg)					
	Base	Post_0	Post_10	Post_20	Post_30
H	0.55±0.33	0.43±0.33	0.55±0.34	0.55±0.33	0.54±0.35
M	0.56±0.32	0.45±0.31	0.53±0.33	0.53±0.32	0.52±0.26
L	0.47±0.24	0.44±0.36	0.53±0.33	0.72±0.94	0.51±0.25

**Table 7.3:** Average total stiffness at baseline, immediate post stretch and then at 10 minute intervals until 30 minutes post stretch in pwMS. Mean (Nm/kg) ± standard deviation is indicated. H = High torque M = Medium torque L = Low torque.



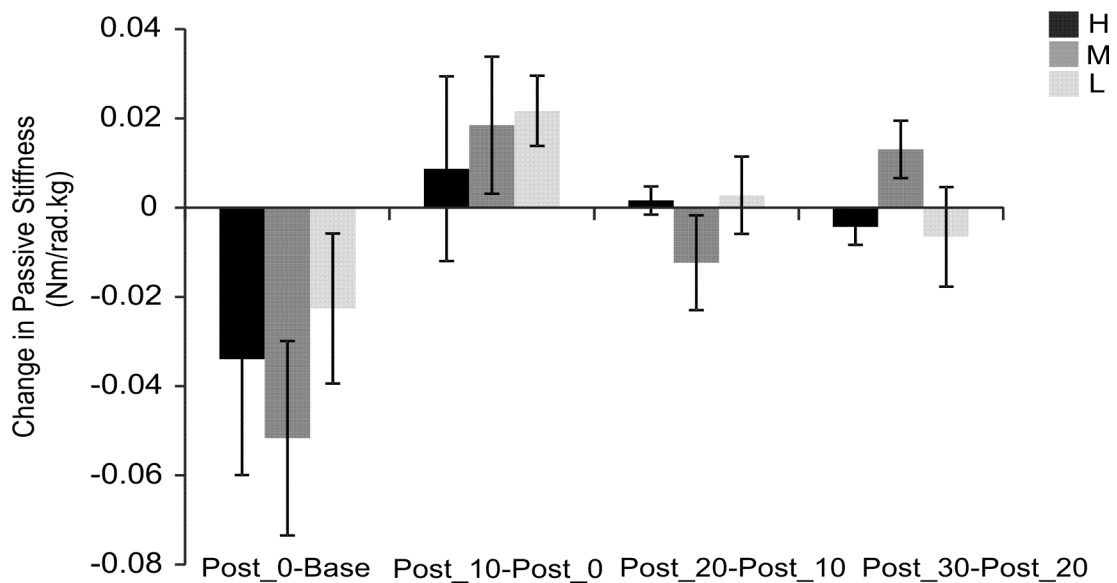
**Figure 7.4:** Change in total stiffness between (i) baseline and post stretch (Post\_0 Base), (ii) immediate post stretch and 10 minutes post stretch (Post\_10-Post\_0), (iii) 10 minutes post stretch and 20 minutes post stretch (Post\_20-Post\_10); 20 minutes post stretch and 30 minutes post stretch (Post\_30-Post\_20) time periods, were compared against the applied torque. Standard error of mean (SEM) indicated. H = High torque M = Medium torque L = Low torque.

**Passive Stiffness:** There was no significant difference in passive stiffness with torque (TORQUE  $F(2,24)=1.331$   $p=0.283$ ). However, there was a significant difference in passive stiffness over time (TIME  $F(4,48)=3.933$   $p=0.026$ ); with a significant reduction in stiffness post stretch (TIME  $F(1,12)=7.693$   $p=0.017$ ). There was no significant TORQUE X TIME interaction ( $F(8,96)=0.662$   $p=0.586$ , Figure 7.5). Changes in

stiffness over time are given in Table 7.4. Reductions in passive stiffness were small and lasted for 10 minutes for the low force but remained lower than baseline values for the medium and high force.

Passive Stiffness (Nm/rad.Kg)					
	Base	Post_0	Post_10	Post_20	Post_30
H	0.34±0.27	0.31±0.27	0.32±0.29	0.32±0.29	0.32±0.28
M	0.37±0.25	0.32±0.26	0.34±0.25	0.33±0.26	0.34±0.26
L	0.31±0.21	0.29±0.23	0.31±0.23	0.31±0.23	0.31±0.21

**Table 7.4:** Average passive stiffness during and after high (H), medium (M) or low (L) torque stretches in pwMS. Mean ± standard deviation is indicated.



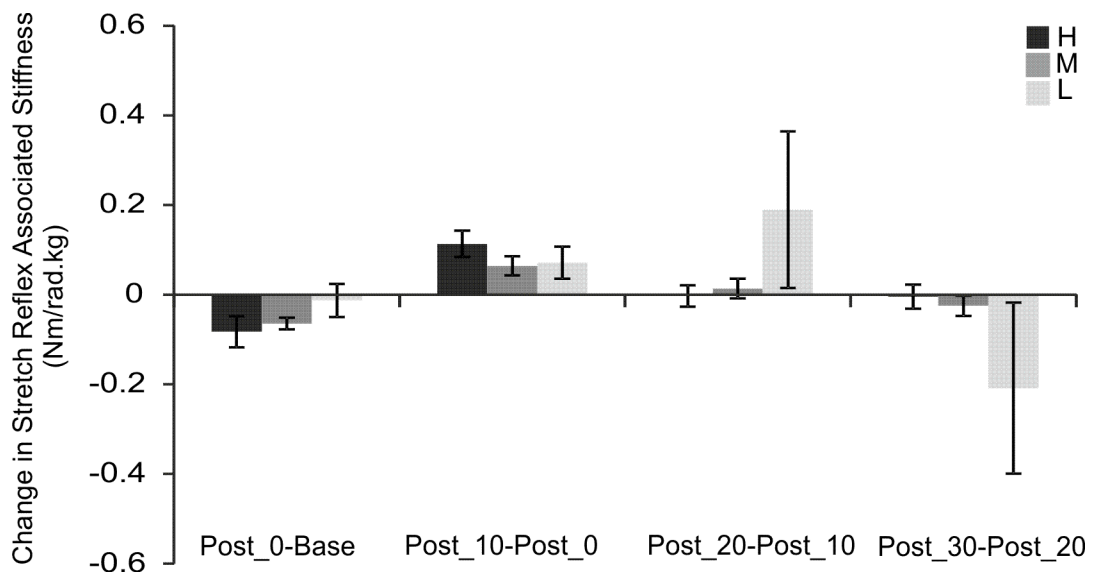
**Figure 7.5:** Change in passive stiffness between (i) baseline and post stretch (Post\_0-Base), (ii) immediate post stretch and 10 minutes post stretch (Post\_10-Post\_0), (iii) 10 minutes post stretch and 20 minutes post stretch (Post\_20-Post\_10), 20 minutes post stretch and 30 minutes post stretch (Post\_30-Post\_20) time periods were compared against the high (H), medium (M) or low (L) applied torque. Standard error of mean (SEM) indicated.

**Stretch Reflex Associated Stiffness:** There was no significant difference in stretch reflex associated stiffness with torque (TORQUE  $F(2,24)=0.880$   $p=0.428$ ) and no significant difference seen over the observed time frame (TIME  $F(4,48)=3.18$   $p=0.08$ ). There was no significant TORQUE X TIME interaction ( $F(8,96)=1.02$   $p=0.35$ , (Figure 7.6 and Table 7.5). It is interesting to note that stretch reflex mediated stiffness increased to above baseline levels between 10-20 minutes post stretch. In the case of both the high and low torque stretches, these higher levels remained for the rest of the 30 minute assessment period (Table 7.5).

<b>Stretch Reflex Associated Stiffness(Nm/rad.Kg)</b>					
	<b>Base</b>	<b>Post_0</b>	<b>Post_10</b>	<b>Post_20</b>	<b>Post_30</b>
<b>H</b>	0.20±0.10	0.12±0.13	0.23±0.10	0.23±0.09	0.23±0.12
<b>M</b>	0.19±0.10	0.13±0.10	0.19±0.13	0.20±0.14	0.18±0.11
<b>L</b>	0.16±0.13	0.15±0.16	0.22±0.16	0.41±0.72	0.20±0.11

**Table 7.5:** Average stretch reflex associated stiffness during and after high (H), medium (M) or low (L) torque stretches in pwMS. Mean ± standard deviation is indicated





**Figure 7.6:** The difference in stretch-reflex associated stiffness between baseline and post stretch (Post\_0-Base), immediate post stretch and 10 minutes post stretch (Post\_10-Post\_0), (iii) 10 minutes post stretch and 20 minutes post stretch (Post\_20-Post\_10), 20 minutes post stretch and 30 minutes post stretch (Post\_30-Post\_20) time periods were compared against the applied torque. Standard error of mean (SEM) indicated.

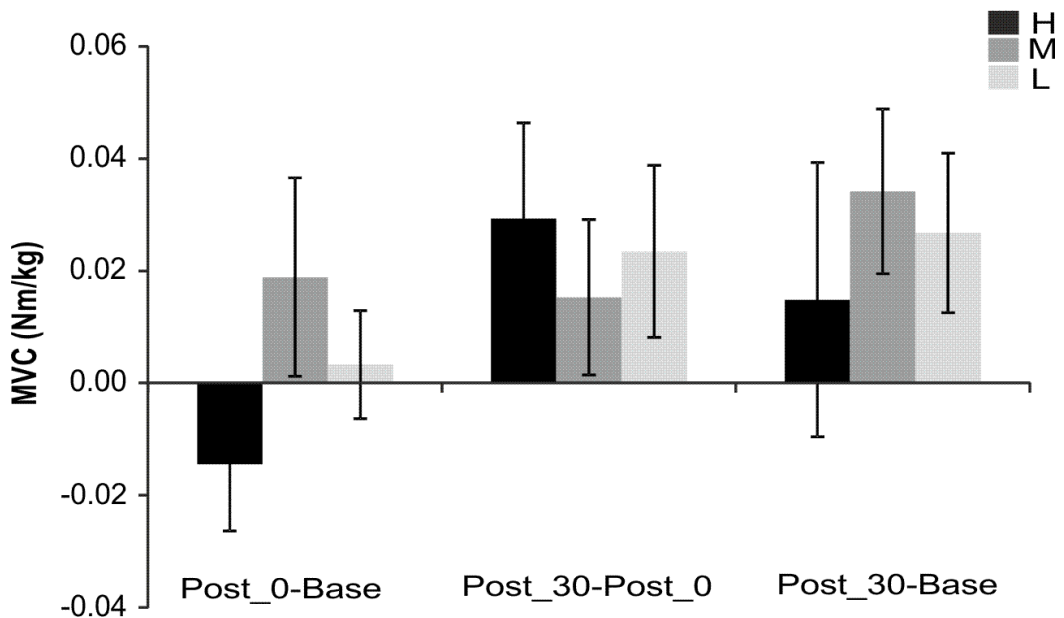
### 7.3.5 Change in Strength with Applied Torque in pwMS (n=13)

#### 7.3.5.1 Isometric Dorsiflexor Strength Normalised to Body Weight

There was no significant difference in isometric dorsiflexor strength with torque (TORQUE  $F(2,24)=1.491$   $p=0.248$ ) ; no significant change in isometric strength over time (TIME  $F(2,24)=3.226$   $P=0.088$ ) and no significant TORQUE X TIME interaction ( $F(4,48)=0.870$   $p=0.442$ ) (Figure 7.7 and Table 7.6).

Isometric Dorsiflexor Strength(Nm/kg)			
	Base	Post_0	Post_30
H	0.25±0.04	0.24±0.04	0.27±0.04
M	0.21±0.03	0.23±0.04	0.25±0.04
L	0.23±0.04	0.23±0.04	0.26±0.04

**Table 7.6:** Average isometric dorsiflexor strength at baseline, immediately post stretch and 30 minutes post high (H), medium (M) or low (L) torque stretches in pwMS. Mean ± standard deviation is indicated.



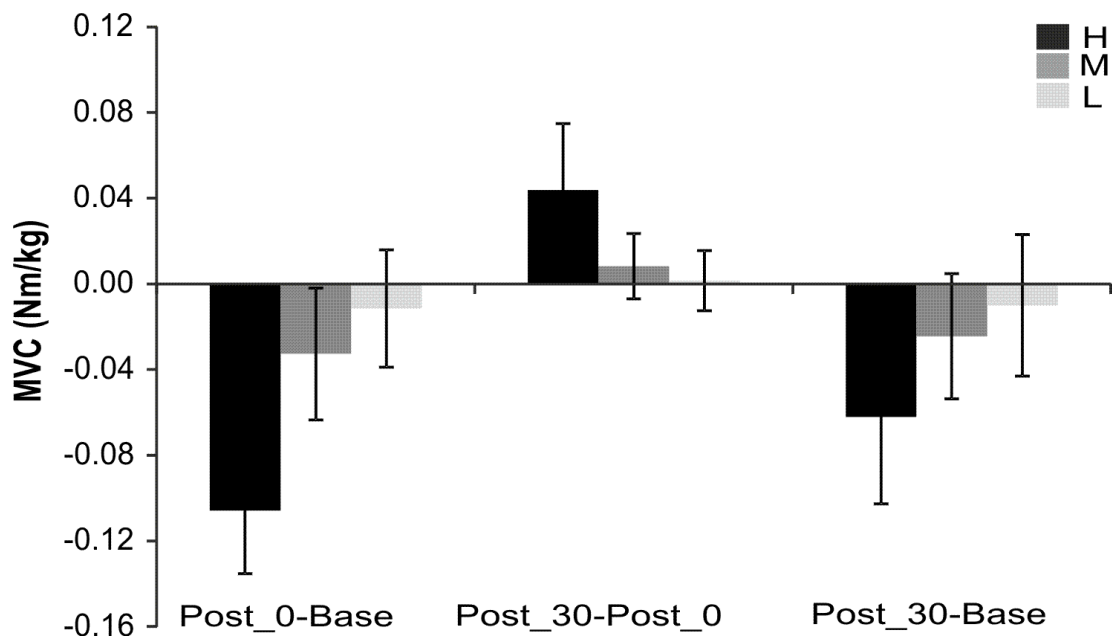
**Figure 7.7:** Change in isometric dorsiflexor strength between (i) baseline and post stretch (Post\_0-Base), (ii) immediate post stretch and 30 minutes post stretch (Post\_30-Post\_0), (iii) 30 minute post stretch and baseline (Post\_30-Base) time periods were calculated and compared against the applied torque. Standard error of mean (SEM) indicated.

### 7.3.5.2 Isometric Plantarflexor Strength Normalized to Body Weight

There was no significant difference in isometric plantarflexor strength with torque (TORQUE  $F(2,24)=0.672$   $p=0.520$ ); no significant change in isometric strength over time (TIME  $F(2,24)=3.235$   $P=0.080$ ) and no significant TORQUE X TIME interaction ( $F(4,48)=2.012$   $p=0.108$ ) (Figure 7.8 and Table 7.7).

Isometric Plantarflexor Strength(Nm/kg)			
	Base	Post_0	Post_30
H	0.41±0.06	0.30±0.05	0.34±0.05
M	0.32±0.04	0.29±0.05	0.30±0.05
L	0.33±0.04	0.32±0.05	0.32±0.04

**Table 7.7:** Average isometric Plantarflexor strength at baseline, immediately post stretch and 30 minutes post high (H), medium (M) or low (L) torque stretches in pwMS. Mean ± standard deviation is indicated.

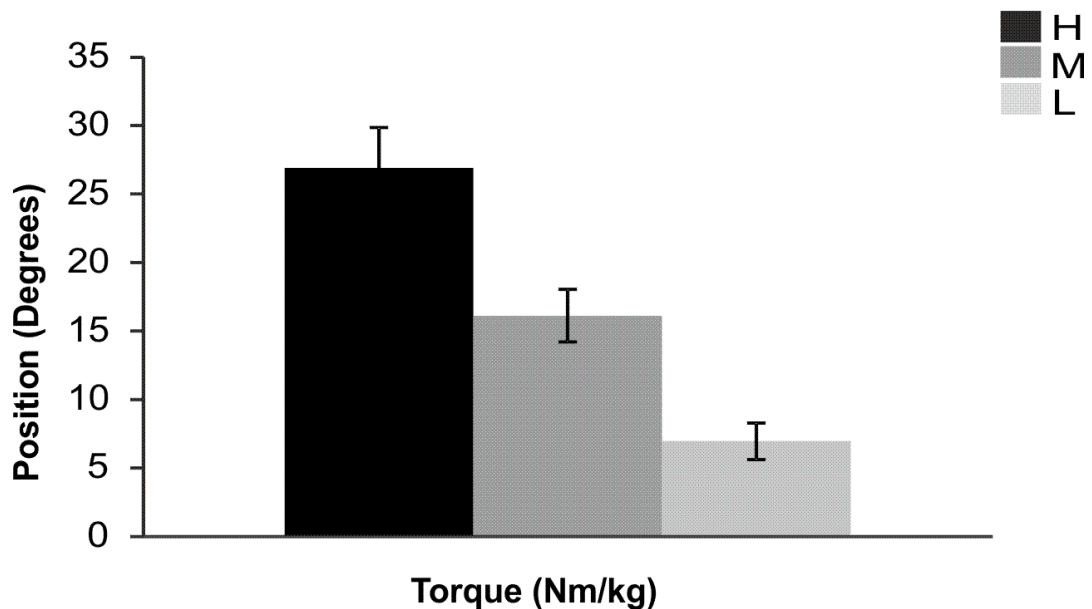


**Figure 7.8:** Change in isometric plantarflexor strength between (i) baseline and post stretch (Post\_0-Base), (ii) immediate post stretch and 30 minutes post stretch (Post\_30-Post\_0), (iii) 30 minute post stretch and baseline (Post\_30-Base) time

periods were calculated and compared against the applied torque. Standard error of mean (SEM) indicated.

### 7.3.6 Effect of Applied Torque on End Range Ankle Position in pwMS (n=12)

There was a significant effect of torque on end ankle position recorded nine minutes after stretch onset (TORQUE  $F(2,20)=33.097$   $p=0.001$ ) with a significant increase in range observed with application of a HIGH torque compared to MEDIUM (TORQUE  $F(1,10)=41.641$   $p=0.001$ ) and MEDIUM compared to LOW (TORQUE  $F(1,10)=19.369$   $p=0.001$ ) (Figure 7.9).



**Figure 7.9:** End ankle position (nine minutes post stretch) with the application of a high, medium or low torque. Standard error of mean (SEM) indicated.

### 7.3.7 Range of Movement During the Stretch in pwMS(n=12)

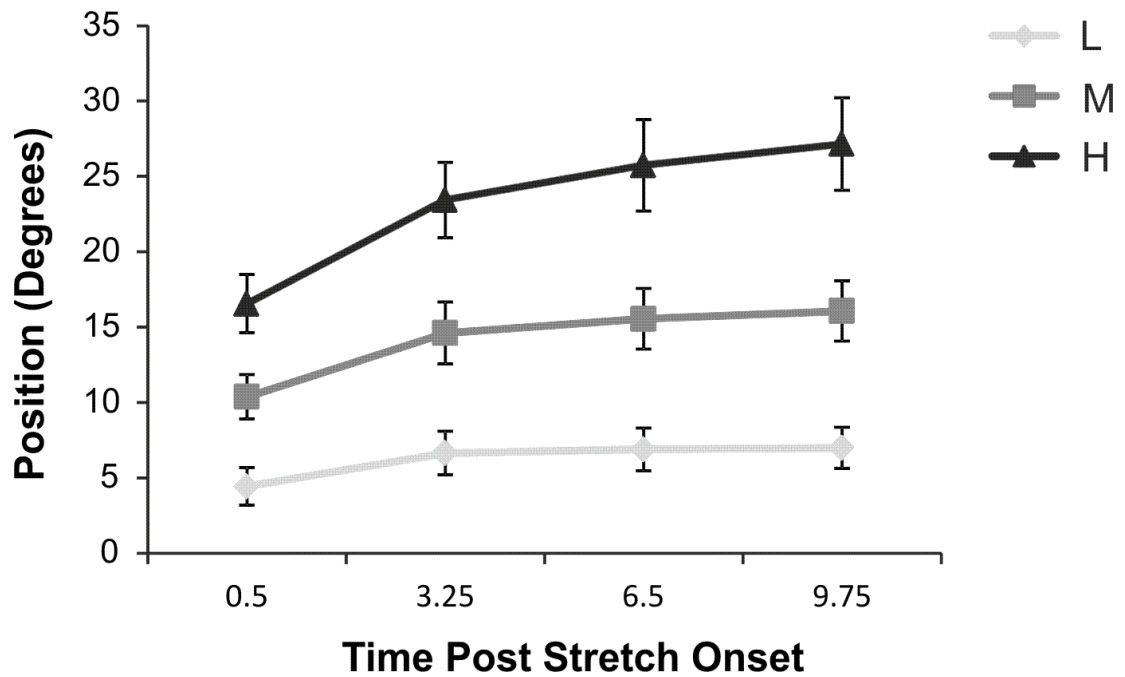
There was a significant effect of torque on the position of the ankle at 10 seconds, 3.25 minutes, 6.50 minutes and 9.75 minutes post stretch onset (TORQUE  $F(2,20)= 34.592$   $p=0.001$ ); a priori contrasts revealed a significant increase in ankle position between LOW and MEDIUM ( $F(1,10) = 19.354$   $p = 0.001$ ) and MEDIUM and HIGH ( $F(1,10) = 45.050$   $p=0.001$ ). There was a significant effect of time on the position of the ankle

(TIME  $F(3,30)= 52.492$   $p=0.001$ ); a priori contrasts revealed a significant increase in position as the duration of the stretch increased ( $p<0.001$ ).

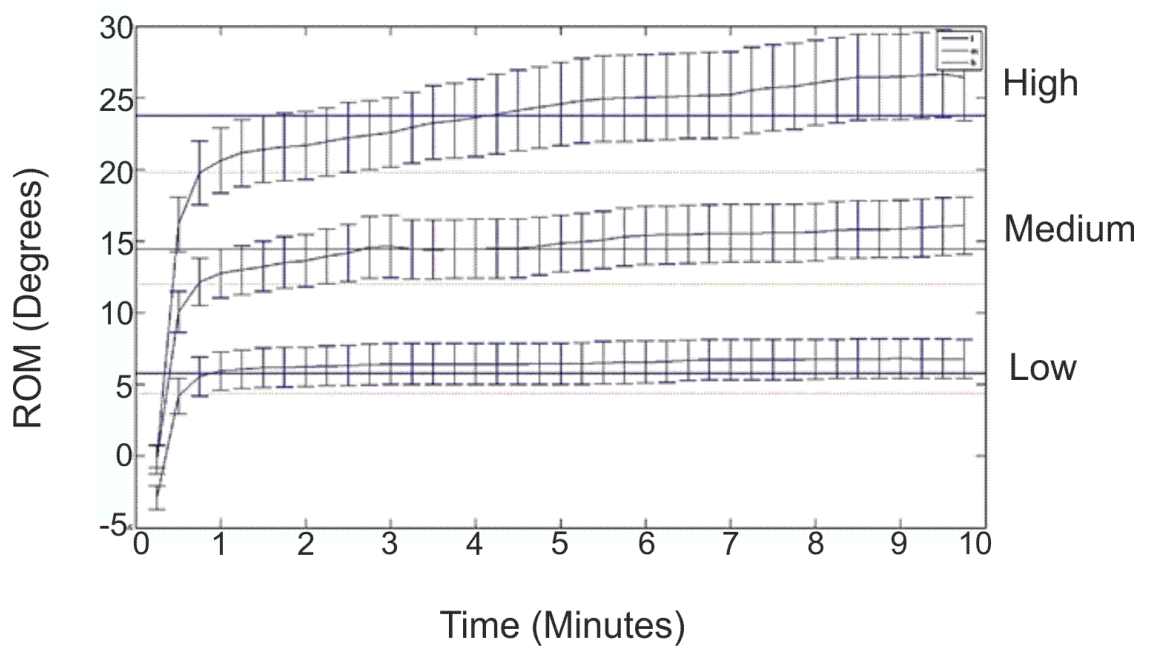
There was a significant TORQUE X TIME interaction (TORQUE X TIME  $F(6,60)=11.816$   $p<0.001$ ). This indicated that with a higher applied torque the ROM tended to increase across the whole course of the stretch whilst with the low torque stretch the ROM tended to plateau after 6.5 minutes ( $p<0.001$ ); this is illustrated in Figure 7.10 and Table 7.8. Figure 7.11 shows the grand average change in position across time with data being sampled every 0.5 minutes, this and Figure 7.10 highlights that the rate of change of torque was initially high and then starts to decrease around 7 minutes.

	<b>0.5 minutes post stretch</b>	<b>3.25 minutes post stretch</b>	<b>6.5 minutes post stretch</b>	<b>9.75 minutes post stretch</b>
<b>L</b>	4.43±1.94	6.64±2.51	6.89±3.03	6.98±3.07
<b>M</b>	10.37±1.47	14.61±2.05	15.55±2.01	16.07±2.01
<b>H</b>	16.56±1.25	23.43±1.44	25.74±1.42	27.16±1.37

**Table 7.8:** Average ROM during stretch at 0.5, 3.25, 6.5 and 9.75 minutes post high (H), medium (M) or low (L) torque stretches in pwMS. Mean ± standard deviation is indicated.



**Figure 7.10:** Position achieved from 0.5 minutes to 9.75 minutes of stretch at a constant torque with the application of a high (H), medium (M) or low (L) torque. Standard error of mean (SEM) indicated.

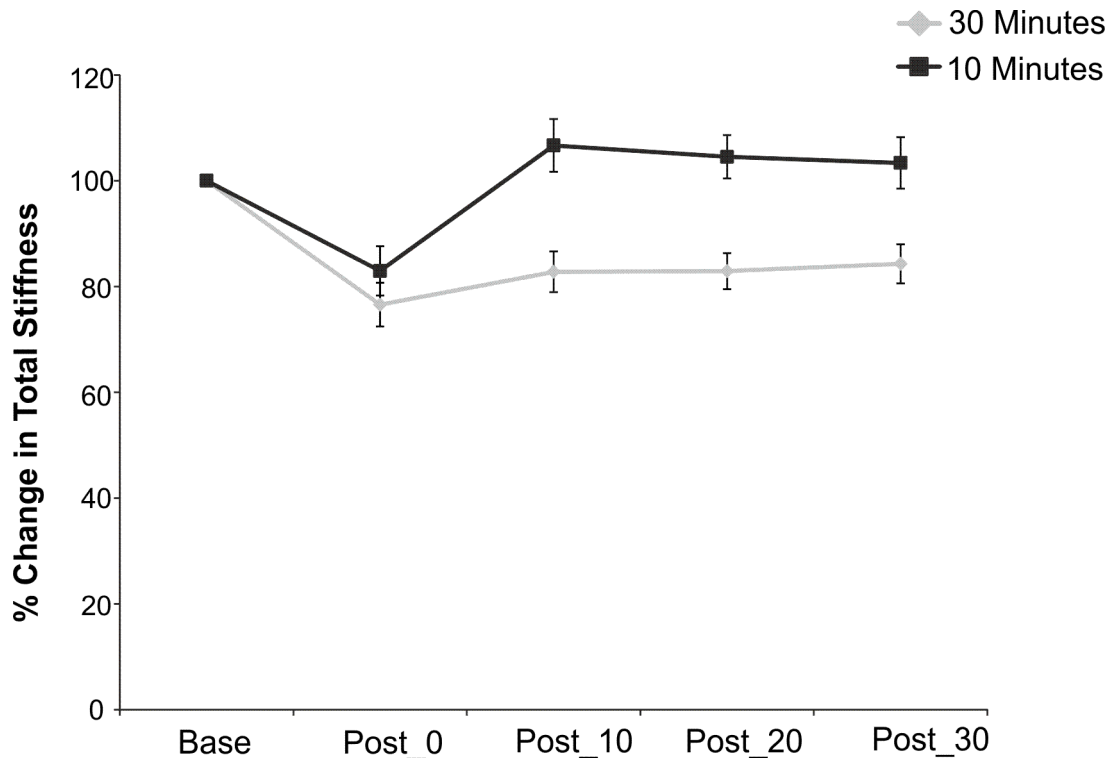


**Figure 7.11:** Grand average of range of motion (ROM) data with the application of a high, medium or low torque over 9.75 minutes. Standard error of mean (SEM) indicated.

### 7.3.8 Comparison of 30 Verses 10 Minutes Duration Stretches on Stiffness and Range of Motion

#### 7.3.8.1 *Effects on Stiffness*

**Total Stiffness:** There was no significant effect of torque on the percentage change in total stiffness (TORQUE  $F(2,50)= 0.196$   $p=0.823$ ) and no significant interaction between TORQUE x DURATION ( $F(2,50) 0.005$   $P=0.99$ ). Additionally, there was no significant effect of stretch duration on change in total stiffness (DURATION  $F(1,25) 1.044$   $P=0.317$ ). However, there was a significant effect of time on change in total stiffness (TIME  $F(4,100)= 15.4$   $p<0.001$ ); a priori contrast revealed a significant decrease in stiffness between baseline and immediately post stretch ( $F(1,25) 33.92$  ( $p<0.001$ )). Furthermore, a significant interaction was observed between stretch duration and time on the reduction in stiffness achieved (TIME x DURATION  $F(4,100) 9.62$   $P<0.001$ ); a priori contrast revealed a significantly greater decrease in stiffness over a 30 minute post stretch period for the 30 minute stretch compared to a 10 minute stretch (Figure 7.13). This was evident between baseline and immediately post stretch (base and post\_0) ( $F(1,25) 7.53$   $P=0.011$ ); immediately post stretch and 10 minutes post stretch (post\_0 and post\_10) ( $F(1,25) 21.20$   $P<0.001$ ); 10 minutes and 20 minutes post stretch (post\_10 and post\_20) ( $F(1,25) 12.29$   $P=0.002$ ) (Figure 7.12). There was no significant TORQUE x TIME interaction ( $F(8,200) 0.685$   $P=0.704$ ) and no significant TORQUE x TIME x DURATION interaction observed ( $F(8,200) 0.310$   $P=0.968$ ).

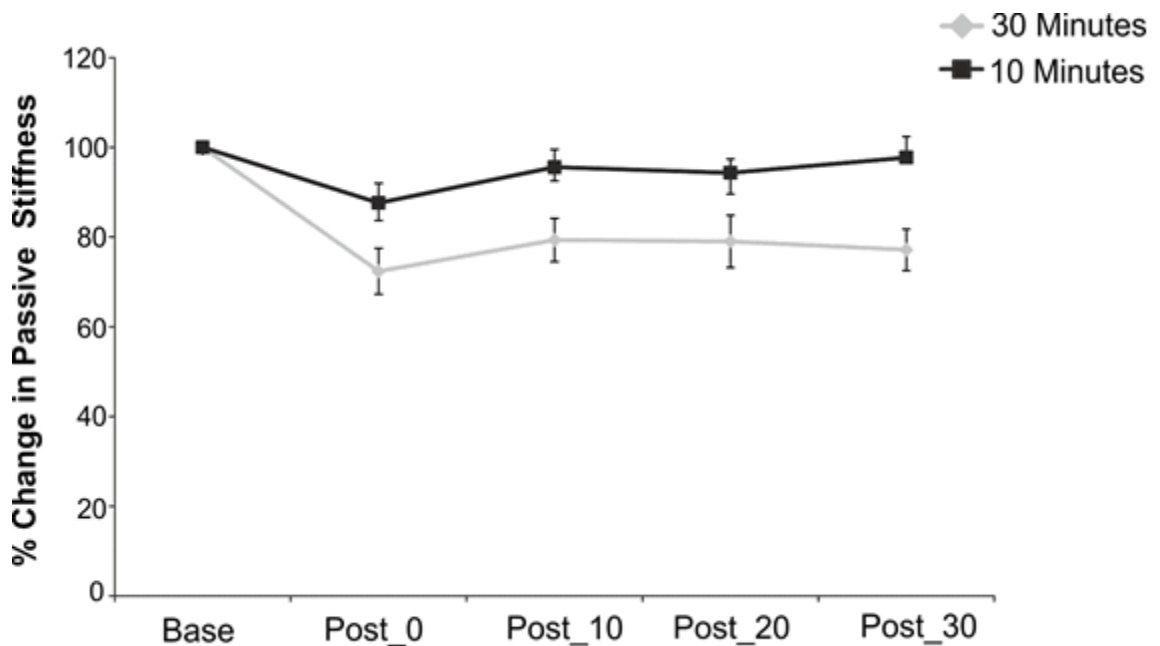


**Figure 7.12:** Percentage change in total stiffness with the application of a stretch between: baseline (Base), immediately post stretch (Post\_0), 10 minutes post stretch (Post\_10), 20 minutes post stretch (Post\_20) and 30 minutes post stretch (Post\_30) collapsed across all applied torques over a 10 and 30 minute duration. Standard Error of Mean (SEM) indicated. As there was no effect of torque an average of the response to the low, medium and high torque stretches is provided.

**Passive Stiffness:** There was no significant effect of torque on the percentage change in passive stiffness (TORQUE  $F(2,50)$  0.422  $p=0.658$ ) and no significant interaction between TORQUE x DURATION ( $F(2,50)$  0.065  $P=0.937$ ). Additionally, there was no significant effect of stretch duration on change in passive stiffness (DURATION  $F(1,25)$  1.590  $P=0.219$ ). However there was a significant effect of time on change in passive stiffness (TIME  $F(4,100)$  12.886  $p<0.001$ ); a priori contrast revealed a significant decrease in stiffness between base and immediately post stretch (base-post\_0) ( $F(1,25)$  17.845 ( $p<0.001$ ); immediately post stretch and 10 minutes post stretch (post\_0 and post\_10) ( $F(1,25)$  6.983  $P=0.014$ ); 10 and 20 minutes post stretch

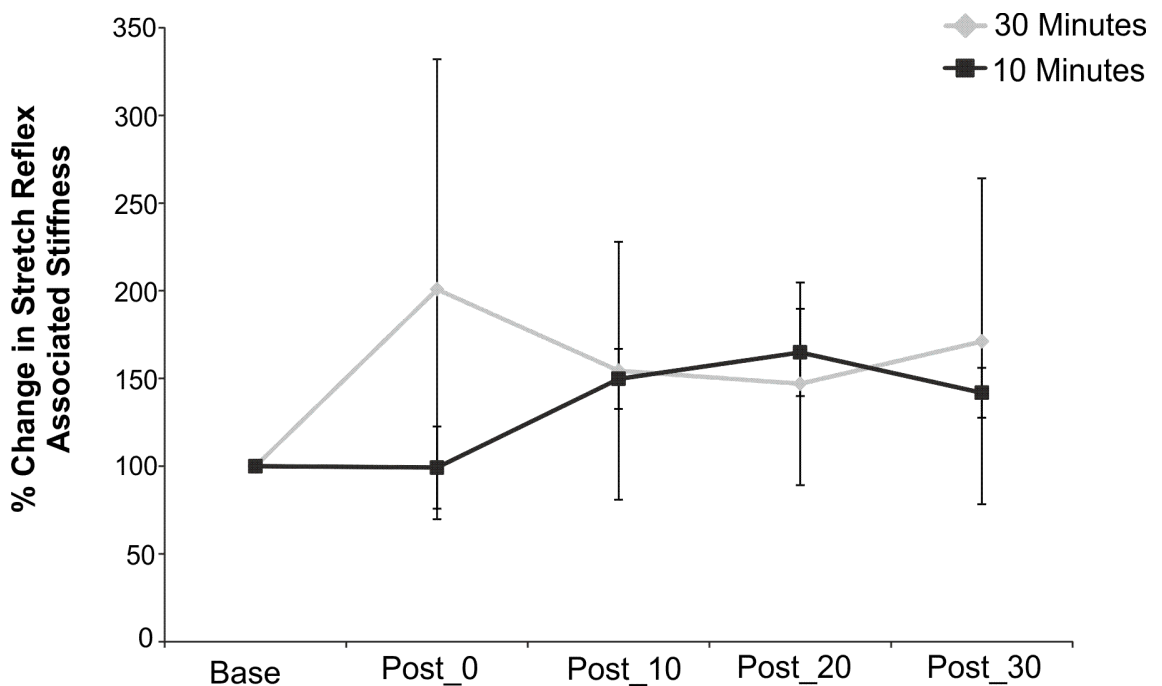


(post\_10 and post\_20) ( $F(1,25) 7.986 P=0.009$ ); 20 and 30 minutes post stretch (post\_20 and post\_30) ( $F(1,25) 8.466 P=0.007$ ) (Figure 7.13). Furthermore, a significant effect of stretch duration on the reduction in stiffness achieved over time was observed (TIME x DURATION  $F(4,100) 8.036 P<0.001$ ); a priori contrast revealed a significantly greater decrease in stiffness over a 30 minute post stretch period for the 30 minute stretch compared to a 10 minute stretch. This was evident between baseline and immediately post stretch (base and post\_0) ( $F(1,25) 9.182 P=0.006$ ); immediately post stretch and 10 minutes post stretch (post\_0 and post\_10) ( $F(1,25) 6.875 P=0.015$ ); 10 and 20 minutes post stretch (post\_10 and post\_20) ( $F(1,25) 6.365 P=0.018$ ); 20 and 30 minutes post stretch (post\_20 and post\_30) ( $F(1,25) 7.183 P=0.013$ ) (Figure 7.14). There was no significant TORQUE x TIME interaction ( $F(8,200) 0.372 P=0.724$ ) and no significant TORQUE x TIME x DURATION interaction observed ( $F(8,200) 0.147 P=0.997$ ).



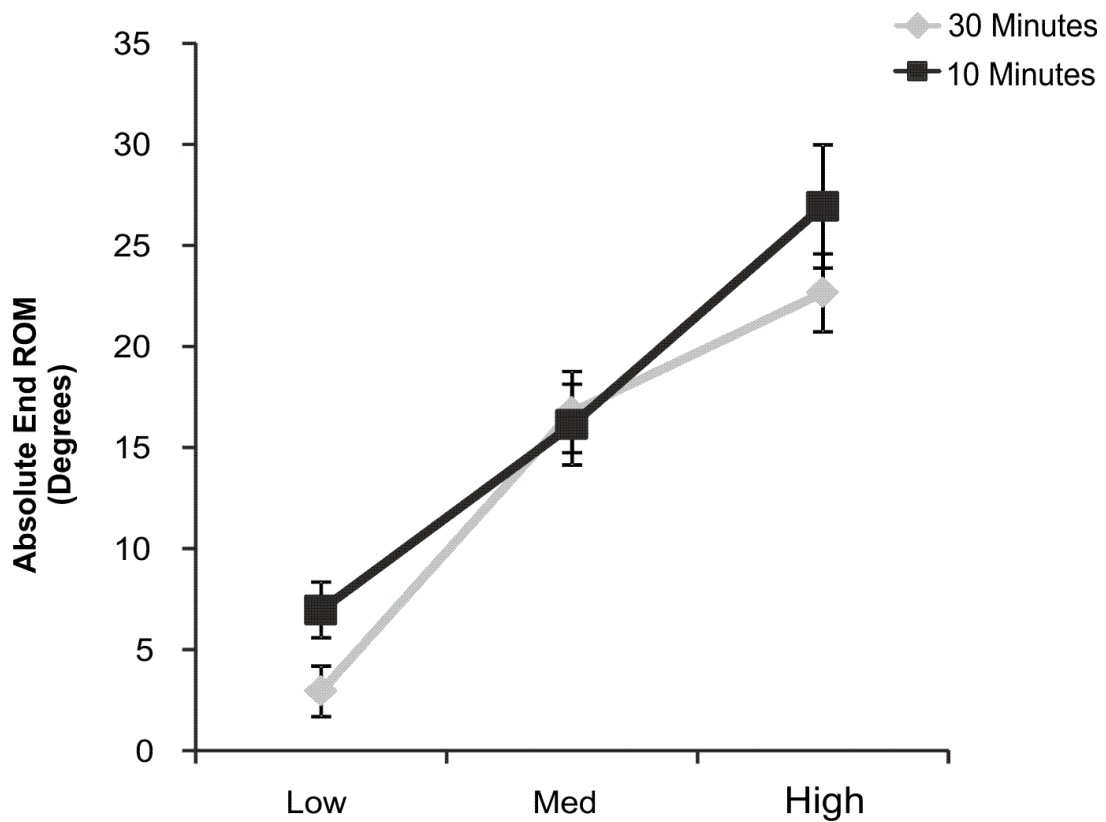
**Figure 7.13:** Percentage change in passive stiffness with the application of a stretch between: baseline (Base), immediately post stretch (Post\_0), 10 minutes post stretch (Post\_10), 20 minutes post stretch (Post\_20) and 30 minutes post stretch (Post\_30) collapsed across all applied torques over a 10 and 30 minute duration. SEM indicated.

**Stretch Reflex Associated Stiffness:** There was no significant effect of torque on the percentage change in stretch reflex associated stiffness (TORQUE  $F(2,50)$  2.853  $p=0.067$ ) and no significant interaction between TORQUE x DURATION ( $F(2,50)$  30.684  $P=0.761$ ) (Figure 7.14). Additionally, there was no significant effect of stretch duration on the reduction in stretch reflex associated stiffness (DURATION  $F(1,25)$  0.033  $P=0.858$ ). However, there was a significant effect of time on the change in stretch reflex associated stiffness (TIME  $F(4,100)$  3.858  $p=0.018$ ); a priori contrast revealed a significant increase in stiffness between post stretch\_0 and post stretch\_10 ( $F(1,25)$  8.098 ( $p=0.009$ ); this increase resulted in a stretch-mediated stiffness that was higher than the initial baseline stiffness. There was no significant TIME x DURATION interactions ( $F(4,100)$  1.243  $P=0.298$ ) (Figure 7.15); no significant TORQUE x TIME interaction ( $F(8,200)$  0.721  $P=0.609$ ) and no significant TORQUE x TIME x DURATION interaction observed ( $F(8,200)$  0.872  $P=0.541$ ).



**Figure 7.14:** Percentage change in stretch reflex associated stiffness with the application of a stretch between: baseline (Base), immediately post stretch (Post\_0), 10 minutes post stretch (Post\_10), 20 minutes post stretch (Post\_20) and 30 minutes post stretch (Post\_30) collapsed across all applied torques over a 10 and 30 minute duration. SEM indicated.

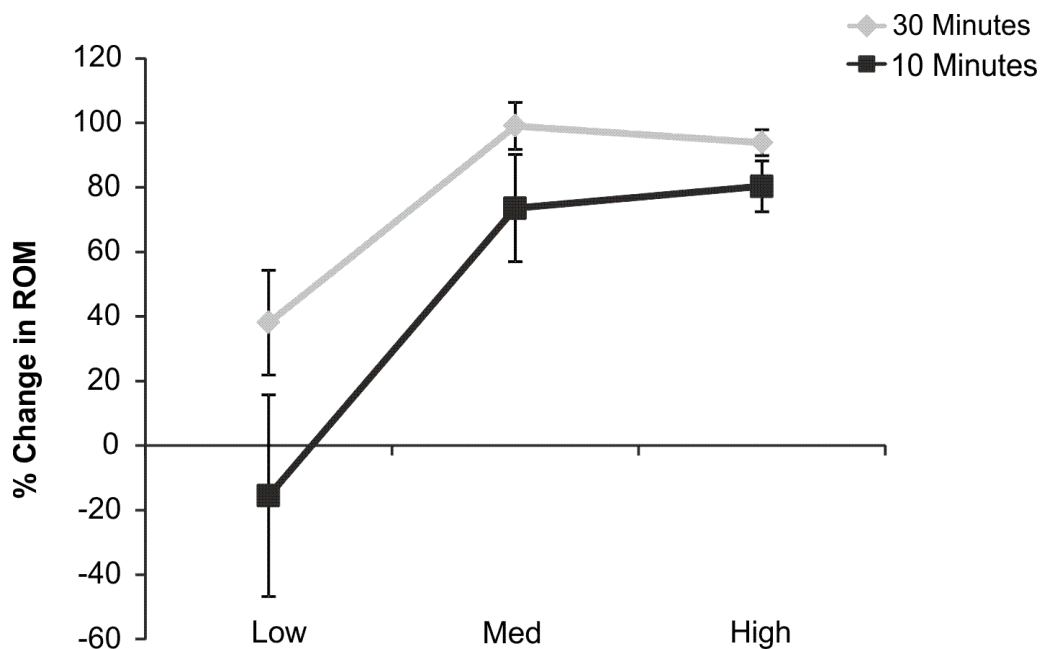
**Absolute End Point ROM:** There was a significant effect of torque on the end ROM achieved with stretch (TORQUE  $F(2,48) 75.430 P<0.001$ ); a priori contrast revealed a significant increase in ankle absolute end point ROM between LOW and MEDIUM ( $F(1,24)= 74.595 P<0.001$ ) and MEDIUM and HIGH ( $F(1,24) 75.852 P<0.001$ ) (Figure 7.16). There was no significant effect of stretch duration on the absolute end point ROM achieved (DUATION  $F(1,24)=1.467 P=0.238$ ) and no significant TORQUE x DURATION interactions ( $F(2,48) 1.447 P=0.245$ ) (Figure 7.15).



**Figure 7.15:** Absolute end point ankle ROM achieved with the application of a low, medium and high force over a 10 and 30 minute duration stretch. Standard Error Mean (SEM) indicated.

**Percentage Change in ROM:** As there was a difference between the groups participating in the 30 minute and 10 minute studies in terms of their baseline ankle ROM, (study two =1.1<sup>0</sup> DF) and (study three =5.7<sup>0</sup> DF ) the percentage change in ROM relative to their initial baseline range was assessed.

There was a significant effect of torque on the percentage change in ROM achieved with stretch (TORQUE  $F(2,46) 10.975 p=0.003$ ); a priori contrast revealed a significant increase in ankle ROM between LOW and MEDIUM ( $F= (1,23) 9.209 p =0.006$ ) and MEDIUM and HIGH ( $F(1,23) 24.471 p<0.001$ ) (Figure 7.16). There was also a significant effect of stretch duration on the percentage change in ankle ROM achieved; with the 30 minute duration achieving a greater change in ROM compared to 10 minute duration (DURATION  $F(1,23) 15.207 p=0.001$ ). However, there was no significant TORQUE x DURATION interactions ( $F (2,46) 0.614 P=0.545$ ).



**Figure 7.16:** Percentage change in ankle ROM with the application of a low, medium and high force over a 10 and 30 minute duration. Standard Error Mean (SEM) indicated.

### **7.3.9 Comparison to Previous Work in the Literature**

The mean differences and effect sizes for passive stiffness (Table 7.9 and 7.10); stretch reflex associated stiffness (Table 7.11 and 7.12) and ROM (Table 7.13 and 7.14) are detailed below using common units of  $\text{Nm}^\circ$ . The results for study two and three detailed in chapters six and seven are compared to the findings from previous work in the area of stretching for the treatment of hypertonia detailed in the literature review (see chapter three). Data from the literature comparing measures pre and post intervention (i.e. not including control group data), were included to allow a more direct comparison with the current studies.

Although there are similarities in the experimental procedure and sample demographics detailed in this thesis and the compared literature it is important to note that the studies detailed in the literature consist of a variety of disease pathologies in addition to MS including: stroke, SCI, head and brain injury. Additionally, the level of disability is variable with some participants being functionally mobile without the use of a walking aid and others being wheelchair users. Further, the degree of passive available ROM ranged from  $-3^\circ$  to  $+10^\circ$  and baseline levels of passive stiffness were variable.

## Passive Stiffness

Mean difference (Nm/°):

Condition	Mean difference	Lower Limit	Upper limit
30 minutes	-0.25	-0.73	0.23
10 minutes	-0.04	-0.15	0.06
Previous studies in literature (n=3) (30-60 minutes)	-0.09	-0.16	-0.02

**Table 7.9:** Mean difference and confidence intervals are indicated for passive stiffness; a negative mean difference indicates a reduction in stiffness.

Effect Size:

Condition	Effect Size	Lower Limit	Upper limit
30 minutes	-1.03	-1.67	-0.36
10 minutes	-0.77	-1.38	-0.14
Previous studies in the literature (n=3) (30-60 minutes)	-0.29	-0.71	0.12

**Table 7.10:** Effect size and confidence intervals for passive stiffness; a negative effect size indicates that stiffness decreases.

### Stretch reflex associated stiffness

**Mean difference (Nm/°):**

Condition	Mean difference	Lower Limit	Upper limit
30 minutes	0.01	-0.26	0.28
10 minutes	-0.05	-0.21	0.12
Previous studies in the literature (n=3) (30 minutes)	-0.18	-0.54	0.59

**Table 7.11:** Mean difference and confidence intervals are indicated for stretch reflex associated stiffness; a negative mean difference indicates a reduction in stiffness.

**Effect Size:**

Condition	Effect Size	Lower limit	Upper Limit
30 minutes	0.08	-0.45	0.60
10 minutes	-0.55	-1.13	0.05
Previous studies in literature(n=3) (30 minutes)	-0.12	-0.77	0.32

**Table 7.12:** Effect size and confidence intervals for stretch reflex associated stiffness; a negative effect size indicates that stiffness decreases.

## Range of Motion (Degrees)

### Mean difference:

Condition	Mean difference	Lower limit	Upper Limit
30 mins High	22.2	5.41	38.94
10 mins High	21.2	3.44	38.93
30 mins Medium	15.4	1.73	29.03
10 mins Medium	10.4	-1.20	21.96
30 mins Low	2.2	-2.48	6.85
10 mins Low	1.2	-2.28	4.71
Previous studies in the literature (n=12) (10-45 minutes)	5.0	0.28	9.65

**Table 7.13:** Mean difference and confidence intervals are indicated for range of motion at high, medium and low torques; positive results demonstrate an increase in range. Mins = minutes.

### Effect Size:

Condition	Effect size	Lower limit	Upper Limit
30 mins High	2.59	1.42	3.74
10 mins High	2.34	1.21	3.45
30 mins Medium	2.20	1.16	3.21
10 mins Medium	1.75	0.82	2.65
30 mins Low	0.91	0.25	1.55
10 mins Low	0.68	0.04	1.30
Previous (N=12) (10- 45 minutes)	0.75	0.49	1.02

**Table 7.14:** Effect size and confidence intervals for range of motion; a positive effect size indicates that the ROM increases and a negative value indicates a decrease.



## 7.4 Discussion

Study two detailed in chapter six indicated a significant effect of time in the changes observed in passive stiffness. In addition a significant effect of torque and time was observed with increases in ROM. It is more clinically feasible to implement a stretching regime for 10 minutes as opposed to 30 minutes; therefore this third study aimed to establish what the effects were of 10 minutes of stretching on change in stiffness (total, passive and stretch reflex associated), strength and ROM. The results demonstrate that the effects were notably reduced after 10 minutes of stretching in comparison to 30 minutes of stretching. Passive stiffness reduced immediately following 10 minutes of stretching but the effects were not maintained over the 30 minute post stretch period. Further, the percentage change in ROM was significantly less after a 10 minute stretch. The effects of stretch duration and applied torque are summarized in Table 7.15.

	Duration of stretch	Level of Torque
ROM	✓	✓
Passive Stiffness	✓	X
Stretch Reflex Associated Stiffness	X	X

**Table 7.15:** Diagrammatical representation of the effect of stretch duration and applied torque on ROM, passive stiffness and stretch reflex associated stiffness. A tick (✓) indicates that this parameter has a significant effect on the variable measured

It has been established in studies two and three that the level of applied torque during the stretch has no significant effect on change in passive stiffness or stretch reflex associated stiffness (spasticity). Similarly the level of applied torque has no effect on plantarflexor or dorsiflexor isometric strength. However, a statistically significant effect of the level of applied torque on end ROM was observed, with higher torques achieving greater ROM. This implies that for participants with reduced ROM, such as those in study two, that both stretch duration and applied torque have to be considered in order

to attain an optimal improvement in ROM immediately post intervention. The data suggests that people with reduced ankle ROM may benefit more from stretches that utilize both gravity and body weight when standing and are applied for a minimum of 30 minutes. Similarly, a significantly greater decrease in passive stiffness was achieved with 30 minutes of stretch compared to 10 minutes, regardless of the level of applied torque, suggesting that patients with enhanced passive stiffness would potentially benefit from longer duration stretches irrespective of the level of applied torque. It is important to note that the participants in study two had significantly higher passive stiffness and a significantly greater reduction in ankle ROM compared to those in study three. It is therefore, possible that the mild baseline presentation of the group in the third study may have potentially contributed to the reduced efficacy of the 10 minute stretching intervention.

The application of a 30 minute stretch at a high torque applied in study two achieved significantly larger increases in ROM of up to 22° post stretch compared to the 5° reported in the literature; this further indicates the relative importance of the level of applied torque in improving ROM. However, the current study did not have an MS group acting as a control (i.e. no stretch). Therefore the treatment effect reported in Table 7.14 may be an over estimation. As highlighted in chapter 3, treatment effects tended to be lower for studies that had a control group.

Overall, the results from both study two and three regarding change in passive stiffness with stretch are in line with the literature in this area. However, the application of 30 minutes of passive stretch at a constant torque (study two) was able to achieve a -0.25 Nm/° decrease in passive stiffness which is higher than what has been previously reported; leading to a higher treatment effect than in other stretching studies. It is possible that this finding may be due to differences in the intervention protocols or the variability in the sample populations such as disease type and severity, however in study one we found no significant correlation between level of passive stiffness and functional ability.

It is not yet completely clear what the clinical relevance of this reduction in stiffness is, work in stroke patients, showing similar levels of ankle stiffness to the MS participants in these studies, found a relationship between ankle stiffness and the degree of dorsiflexion while walking ( $R^2=0.35$ ) (Lamontagne et al. 2002). However, the regression equations were not published and so the effects of the current reduction in stiffness could not be ascertained. Unpublished work by Marsden and colleagues in people with Hereditary Spastic Paraparesis (HSP) also looked at the relationship between ankle stiffness and ROM while walking (Marsden et al. 2012). They found a significant relationship between stiffness measured following a fast stretch (i.e. stretch reflex and passive stiffness combined) and maximal dorsiflexion angle while walking ( $R^2 =0.39$ ) (Marsden et al. 2012). The equation was  $Y=-5.56x +15.56$ , where X is the stiffness in  $Nm/^\circ$  and y is the range in degrees while walking. This means that for a  $-0.25 Nm/^\circ$  change in stiffness there is a  $1.33^\circ$  increase in range while walking. The participants with HSP had much higher levels of stiffness than the MS participants in this study (Total stiffness HSP  $=1.9 (\pm 0.4) Nm/rad$  MS $=0.56 Nm/rad(\pm 0.32)$ ). Further, the increase in range achieved was during a functional activity as opposed to passive ROM therefore the direct applicability is unknown. However, with such a small potential increase in ankle dorsiflexion range it does suggest that functional benefits of the observed reduction in passive stiffness (e.g. on reduction in foot drop and tripping, balance confidence and walking speed) may be small.

Reductions in stretch reflex associated stiffness were a lot smaller than what has previously been reported. It is also interesting to note that all confidence intervals for both the mean difference and effect sizes cross zero. Therefore, it is difficult to state where the true treatment effect lies; it is also possible that stretching has no effect and may even lead in some cases to a transient increase in stretch reflex mediated stiffness. When the two studies (30 minutes and 10 minutes stretch duration were compared) a significant increase in stretch evoked stiffness was seen in the 10 minute

post stretch period indicating that constant torque stretching may lead to temporary increases in spasticity.

The effect of stretching on spasticity is thus inconclusive; increases and decreases have both been seen using both electrophysiological (H/M max) and biomechanical measures in MS and other neurological conditions. Five other studies have also shown an increase in spasticity with stretching (see Figure 3.6); like the studies in this thesis all used a constant torque stretch, either delivered via a motor (Chung et al, 2005; Yeh et al, 2004; Selles et al 2005; Bahkeit et al, 2005) or using body weight (Kunkal et al 1993). It may be that other stretching methods such as hold-relax are either effective at reducing spasticity, or at least do not increase it post stretch. Future work should use combined electrophysiological and biomechanical measures to further assess the effects of different stretching regimes on the time course of spasticity.

In summary, constant torque stretching reduces passive stiffness and improves ROM in people with MS. The duration of the stretching intervention and the level of torque applied are key components to consider when implementing this intervention. The studies conducted in this body of work looked solely at the immediate and short term (up to 30 minutes post stretch) effects of stretching and it is therefore still not known what the long term benefits of these interventions are. It also remains unclear as to the role of viscose deformation in the observed findings. Further, although a change in the overall passive stiffness of the ankle plantarflexors has been seen it is unclear where these changes occur, namely whether this is in the tendon and/or the muscle. Given that differential changes in stiffness in the tendon and muscle have been seen after stroke (Gao & Zhang, 2008; Zhao et al. 2009) it is important to ascertain whether stretching indeed targets the most affected/stiffest structure. This will be explored using ultrasonography in chapter eight.

## **8. Chapter Eight: Changes in Measures of Muscle Stiffness Using Ultrasound in People with Multiple Sclerosis and Following Stretching**

### **8.1 Introduction**

The symptomatic effects of MS are very variable but limb stiffness, or hypertonia, is said to affect 85% of the MS population (Nielsen et al., 2007). Hypertonia, a product of altered levels of passive and stretch reflex mediated stiffness, can lead to marked functional limitations and contributes considerably to the presenting level of disability (Barber et al. 2011; Gao et al. 2011).

It is thought that the predominant contributing factors in the development of the passive stiffness component of hypertonia are changes in the extracellular matrix (ECM) of both tendon and muscle, and reductions in muscle length (Gracies, 2005). Fundamentally, stretching programmes are implemented to maintain or prevent loss of ROM, to prevent or minimise muscle shortening and to reduce hypertonia; these programmes are often an integral part of rehabilitation (Hass & Crow, 1995; Bovend' Eerd et al. 2008).

More recent studies in patients with an upper motor neuron lesion have used a combination of motorised devices and servomotors to implement different stretching techniques and to assess biomechanical measures of passive stiffness and spasticity (Wu et al. 2011; Nakamura et al. 2011; Zhao et al. 2011). However, the disadvantage of these measures is that the passive stiffness measures are all-encompassing, including contributions from muscle, tendon (internal and free tendon) and connective tissue elements. It is important to have an understanding of the mechanical and architectural composition of the structures contributing to the overall stiffness (Lieber & Friden, 2001) and how these may be affected by pathology and interventions such as stretching.

It remains unclear whether ECM changes following a neurological lesion occur in the tissues within and surrounding the muscle and/or the tendon. It has been postulated that in the stroke population the increase in passive ankle stiffness was due to an increase in Achilles tendon stiffness (Thilmann et al. 1991). In contrast, Winters suggested that in the stroke population the ECM surrounding muscle is stiffer than normal and lies in series with a more compliant tendon (Winters et al. 2009; Zhao et al. 2011).

More recently developments in the use of ultrasonography have aided further understanding of the muscle and tendon structure and how they adapt to applied forces. With B-mode ultrasonography, the mechanical properties of human muscle and tendon can be evaluated in vivo and non-invasively (Fukunaga et al. 1996). Two main techniques have been used to assess muscle and tendon properties using ultrasound to date. In one technique the ankle is fixed in a dynamometer. The dynamometer measures the applied torque while the participant isometrically contracts their ankle plantarflexors. The change in length of the Achilles tendon is measured using ultrasound and the resulting stress (torque/length) and strain (elongation / original length) calculated (Sugisaki et al. 2011; Arampatz et al. 2005; Magnaris & Paul 2002; Gao et al. 2011). In the second technique the elongation of the muscle fascicle and / or Achilles tendon is measured using ultrasound during imposed stereotyped mechanical stretches (Morse et al. 2008; Loram et al. 2006; Nordez et al. 2009).

Using these techniques it has been shown that the passive mechanical properties of muscle and tendon are different in people with neurological lesions compared to healthy controls. People with cerebral palsy have significantly shorter muscle fascicles (Mohagheghi et al. 2007) and the muscle fibres of stroke patients are shorter and stiffer than healthy controls, with an associated longer more compliant Achilles tendon (Gao & Zhang, 2008; Zhao et al. 2009). Ultrasonography is thus fast becoming a common addition to experimental studies which measure the biomechanical changes in stiffness (Kubo et al. 2000; Shortland et al. 2002).

As well as investigating whether there are differences with pathology and determining the site of any changes, the use of ultrasonography can help to determine whether stretching targets this site effectively. For example, it has been shown in healthy subjects that the relative change in length of the Achilles tendon following a stretch in subjects with low overall passive stiffness was minimal and that greater elongation was noted in the muscle fascicles compared to participants with a higher level of stiffness (Abellaneda et al. 2009). This suggests that the site and underlying degree of stiffness affects the relative degree of lengthening in the muscle and tendon with stretching.

Therefore, the objectives were to investigate:

- (a) differences in overall muscle and tendon length in pwMS and healthy controls
- (b) differences in muscle fibre lengthening and strain following a stereotyped perturbation in pwMS and healthy controls
- (c) the effect of the application of a constant torque stretch for 10 minutes on muscle fibre properties.

## **8.2 Materials and Methods**

### **8.2.1 Participants and Recruitment**

Thirteen participants with MS were initially assessed for details (see Chapter 7 section 7.3.1). However, in three cases missing data prevented the full analysis of results from these individuals. Therefore 10 people with MS were included in the final data analysis. MS participants were compared to 12 healthy matched controls. Participants with MS were recruited from the SWIMS database, and the controls were work associates and friends and family members of MS participants (for further details regarding recruitment please see Chapter four, section 4.3). All participants met the inclusion criteria (detailed in Chapter four, 4.4.1) and gave written informed consent to participate. The study was conducted with approval from the NHS Torbay and Devon Research Ethics Committee (Ref-09/H0202/42).

### **8.2.2 Experimental Setup**

Participants were placed in a semi-reclined 25° head tilt position, with the leg most affected by stiffness supported in a footplate with an attached non-slip mat and padded Velcro supports. The footplate was attached to a purpose-built dynamometer (Baldor UK) and the ankle axis was aligned to the axis of the motor shaft (Figure 7.1). The knee was in full extension and the thigh supported and restrained using straps. Seatbelt styled supports and a backrest prevented the body from moving longitudinally up the bed.

The participants with MS were then stretched (“the intervention”) on three separate occasions at low, medium and high torques for 10 minutes (see Chapter seven for details). Control participants were seen on one occasion where the low torque was applied over a 10 minute stretching period and baseline and immediate post stretch measures of stiffness, strength and ROM were collected.

### **8.2.3 Application of Ankle Perturbations to Monitor Limb Stiffness**

Limb stiffness was measured by applying a 15° amplitude ramp stretch at 5°/second from -10° plantarflexion to 5° dorsiflexion. This is termed the ankle perturbation. This was repeated six times with a variable one-three second delay between stretches. Participants were instructed to remain relaxed throughout the perturbation periods. Torque, position and velocity data was obtained via the motor and a torque transducer in series with the motor (TLSF transducer, Industrial measurements UK). Muscle activity was recorded from the tibialis anterior, gastrocnemius and soleus muscle, using surface EMG (EMG 2.5 cm inter-electrode distance, MT8, MIE, UK). Signals were sampled at 2kHz and AD converted using a power 1401. Spike 2 software (version 5, CED Electronics Cambridge, UK) was used for initial visual analysis and to export data to MATLAB for further analysis. This data was used to calculate passive stiffness after checks were made to ensure participants were relaxed prior to and during the stretch (see Chapters six and seven).



#### **8.2.4 Ultrasound Setup**

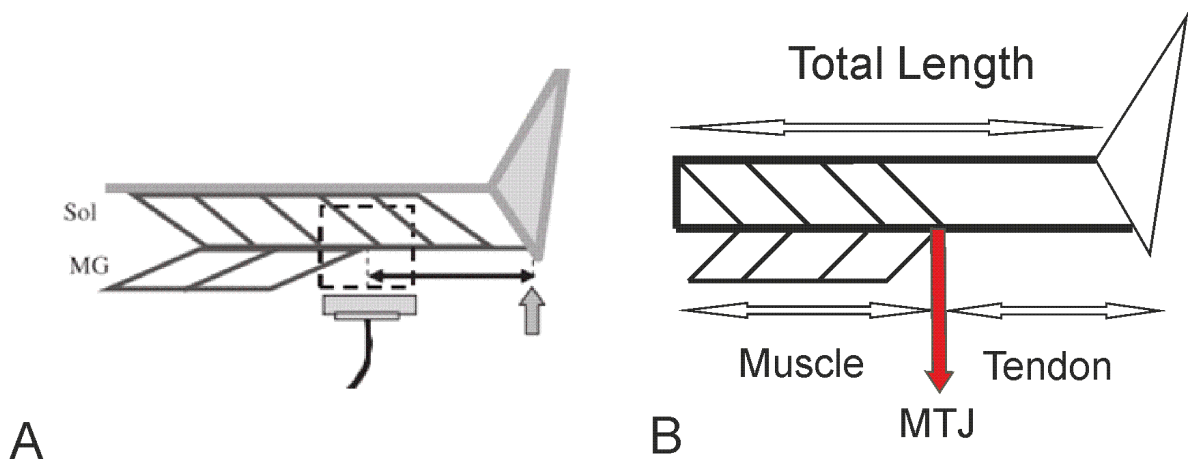
A diagnostic ultrasound machine (Sonoace PICO, Medison Ltd, Korea) with a single 38mm wideband linear array probe and a centre frequency of 7.5 MHz was used to collect ultrasound video footage of the gastrocnemius muscle/aponeurosis, soleus aponeurosis and free tendon movement with the application of the ankle perturbation before and after the intervention (Figure 8.1). The initial ultrasound setup had the following characteristics: depth 3cm, density FPA 49. These parameters were adjusted where necessary to optimise the image quality.

A video and audio capture device (EasyCAP DC60 – USB version 2.0) was used to connect the ultrasound video display to a laptop so that the ultrasound video data could be recorded via Ulead video studio editor (Ulead video studio version 9.0) and stored offline for later analysis. Ultrasound gel was placed on the transducer head and once the location of the musculotendinous junction (MTJ) was established its position was marked on the overlying skin using a marker pen. The ultrasound transducer was kept in a stationary position using a flexible mechanical arm (Manfrotto Magic Arm, Manfrotto UK) with Manfrotto super clamps that were fixed to an extension frame attached to the base of the plinth and locked in place once the desired position was achieved (Figure 8.2 B)

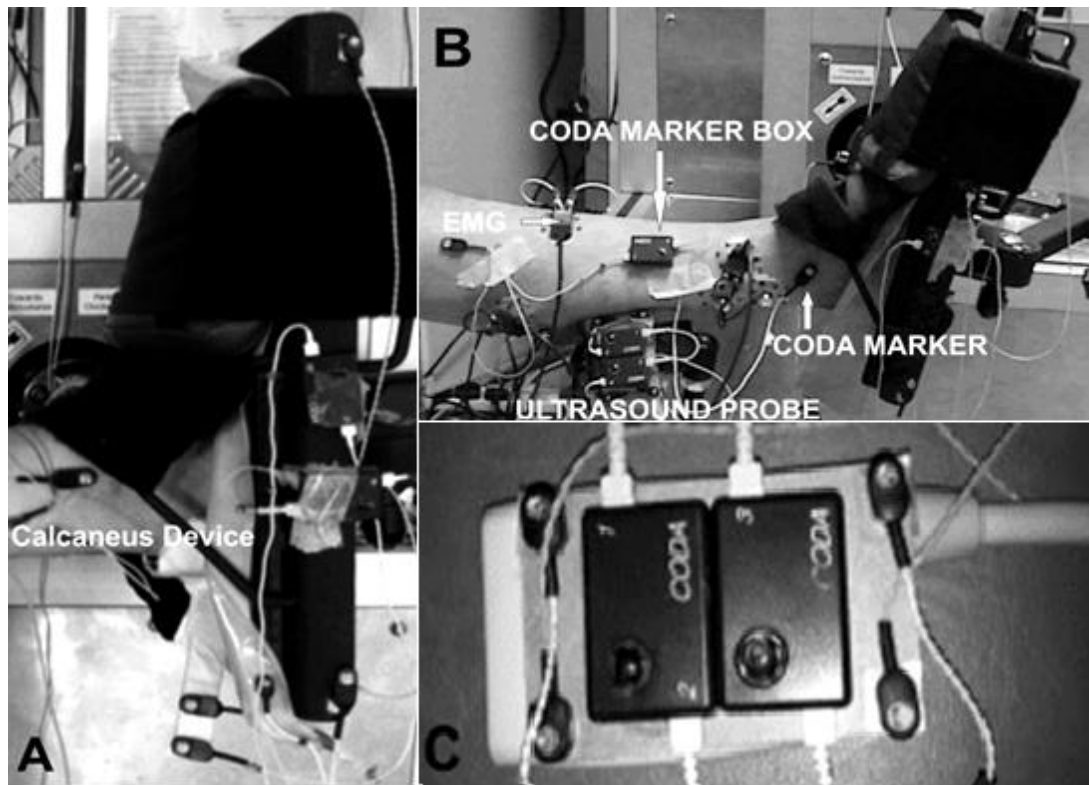
#### **8.2.5 3D Motion Analysis**

Three-dimensional motion analysis was used to estimate the total, proximal and distal length of the gastrocnemius muscle tendon complex before and after the stretching intervention (Figure 8.1). Four light emitting markers (Codamotion, UK) were placed on the motor's vertical shaft and the horizontal axis of the foot plate attachment. With the footplate vertical, the co-ordinate frame for 3D motion data collected was defined so that the longitudinal axis of the shank was defined as the x direction; the antero-posterior axis of the shank was the y axis and the medio-lateral axis of the shank was the z axis.

Further light emitting markers were placed on the proximal gastrocnemius attachment at a position 10 cm distal from the muscle origin on the antero-medial aspect of the tibia shaft (Figure 8.2 B). Two markers were placed on an extension device attached to the calcaneus, the tip of which was aligned to the insertion of the gastrocnemius (Figure 8.2 A). Pilot work showed that these adjustments ensured that the markers indicating the proximal and distal attachment of the gastrocnemius were always in view. Additionally, four markers were placed on the transducer head (located at the position of the MTJ), top left, top right, bottom left and bottom right (Figure 8.2 C).



**Figure 8.1:** A) Ultrasound transducer location at MTJ (image edited from (Sugisaki et al. 2011)); B) Diagrammatical representation of total length, proximal and distal length measures of gastrocnemius.



**Figure 8.2:** A) Location of calcaneus heel device with foot in neutral position; B) position of markers and EMG and diagrammatic representation of position of ultrasound probe relative to the MTJ; C) Ultrasound probe and location of coda markers/marker boxes.

### 8.2.6 Synchronisation

The onset of the ankle perturbation was indicated by a 5V signal elicited by the software that controlled the BSM servomotor. This signal was AD converted by a power 1401 (CED, UK) simultaneously with the torque, position, velocity and EMG signals. The power 1401 in turn elicited a 5V output signal 1ms later that was used to synchronise the 3D motion analysis and ultrasound recordings; this signal was collected via the audio input of the EasyCAP device and via the CODA motion analysis system. In this way it was possible to locate the same position within the ankle perturbation data in the three data collection systems in order to calculate muscle length changes pre and post intervention accurately.

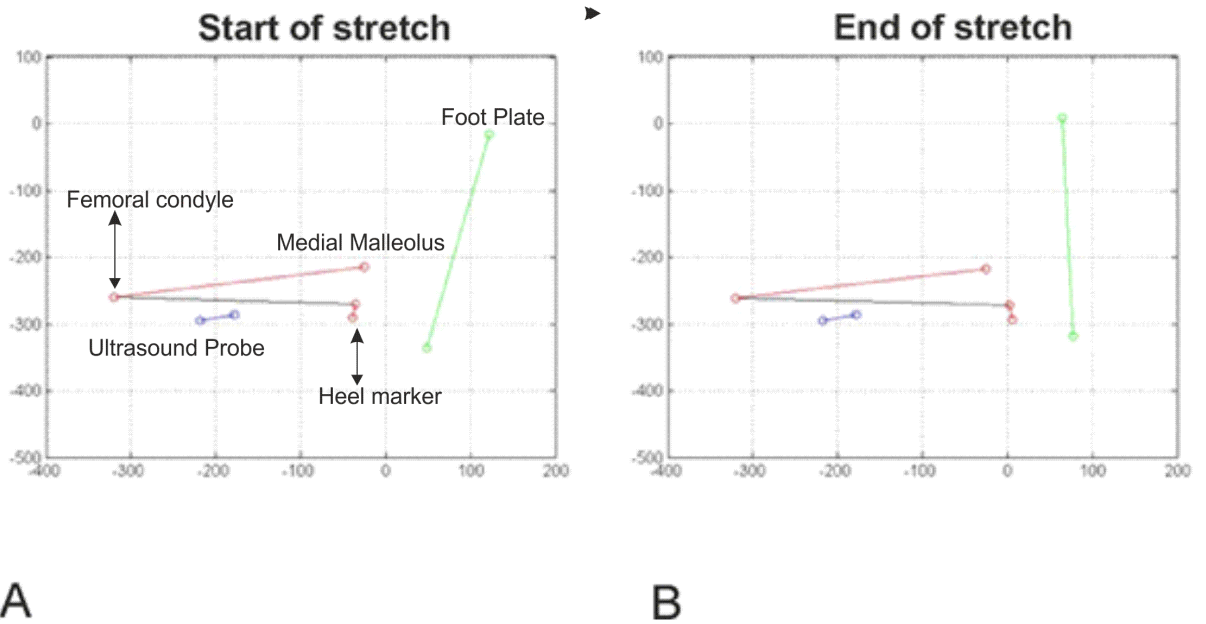
## 8.2.7 Signal Processing

### 8.2.7.1 *Gastrocnemius Muscle and Tendon Length*

The motion analysis data was sampled at 200 Hz for 115 seconds. This data was exported to MATLAB (Mathworks UK) for processing using programmes written in-house.

*Total Gastrocnemius Length:* gastrocnemius length was calculated using the proximal shank markers and the markers on the calcaneal extension. A correction was made for the 10cm distal displacement of the marker indicating the proximal attachment of the gastrocnemius and the offset imposed by the markers on the extension device that aligned with the distal attachment of the gastrocnemius. Marker position longitudinal to the shank (defined as the x direction) and in an antero-posterior direction (defined as the y direction) were used to calculate the total length of the muscle and tendon complex using Pythagoras' theorem (Figure 8.3).

Total Length =  $\sqrt{(\text{proximal marker } x - \text{distal marker } x)^2 + (\text{proximal marker } y - \text{distal marker } y)^2}$



**Figure 8.3:** A) Diagrammatical image of marker calculations of gastrocnemius muscle length in PF at start of perturbation and B) DF at end of perturbation. Note the change in the footplate and heel marker orientation from A to B as the ankle moves into dorsiflexion.

*Gastrocnemius Muscle and Tendon Length:* video imaging software (VirtualDub version 1.9.6) was used to export the first frame of the slow ankle perturbation applied pre and post intervention. This image file was then opened using Image J software and the distance of the MTJ from the centre of the screen (the “correction factor”) was calculated using the equation:

Correction factor = (length of half screen width-X)/pixels per mm,

where X = distance measured from the left side of the screen to the MTJ.

This correction factor meant that images to the left of the screen midline were positive and those to the right of screen midline were negative. This correction factor was later used in the calculation of the gastrocnemius muscle and tendon length (see below).

The position of the MTJ, relative to the markers indicating the distal and proximal gastrocnemius attachment, was then calculated as follows. The mid-position of the ultrasound head was calculated from the attached markers. A correction factor was added to account for the exact position of the MTJ image relative to the middle of the

ultrasound head, as described previously. This made allowances for the fact that the MTJ could be to the left or right of the mid-position of the ultrasound head. The distance from the MTJ, in coda motion co-ordinates and the distal gastrocnemius attachment point was then calculated using Pythagoras' theorem providing an estimate of the tendon length.

$$\text{Tendon Length} = \sqrt{(\text{MTJ marker } x - \text{distal marker } x)^2 + (\text{MTJ } y - \text{distal marker } y)^2}$$

The gastrocnemius muscle length was determined by subtraction of the tendon length from the total length. All length measures were normalised to the participants' height.

### **8.3 Calculation of Muscle Fibre Length Changes and Strain with Stretching**

VirtualDub 1.9.6 was used to open the pre-recorded ultrasound video file. Footage of the dorsiflexion portion of the 2nd and 6th ankle perturbation was selected. These perturbations were selected to assess if there were any thixotropic effects of repeated perturbations. Every second frame of the selected footage was processed as pilot work showed this method increased the accuracy of the tracking. The edited image sequence was then exported as a Windows Bit Map (BMP) file.

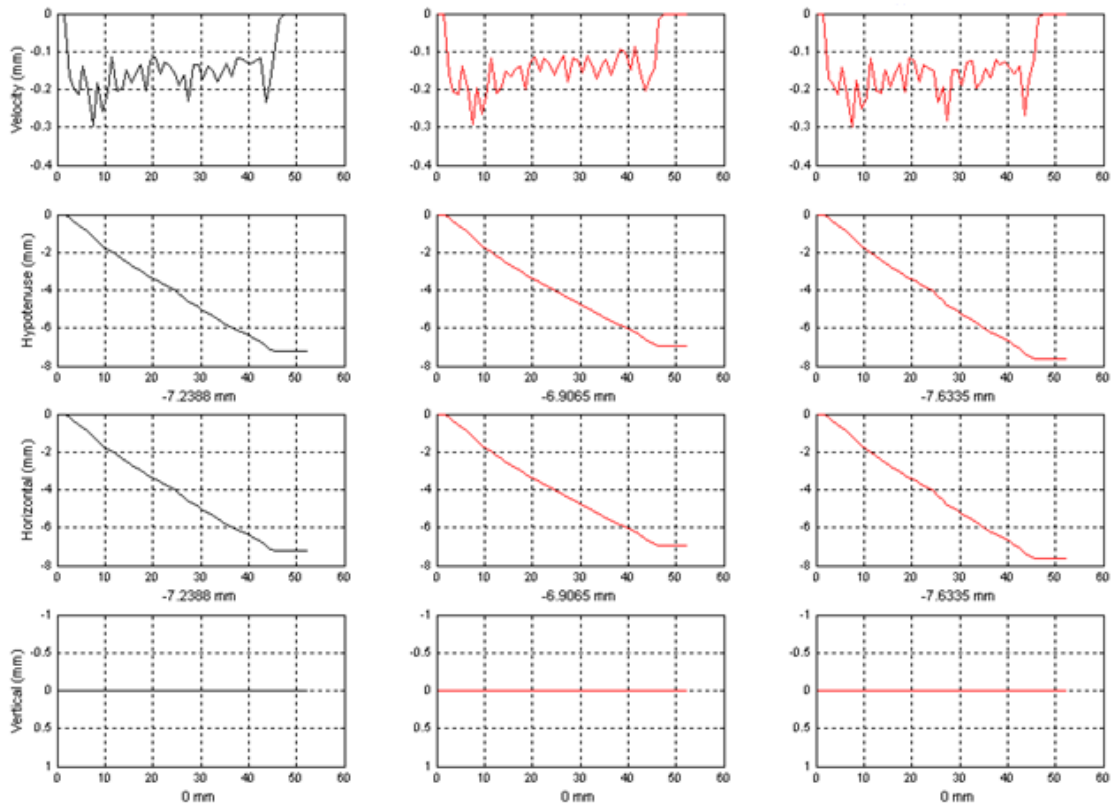
The exported image sequence was processed using a frame-by-frame cross-correlation image analysis program written in MATLAB (Mathworks version 6.0), as described by (Dilley et al. 2001). This software calculates the relative excursion between consecutive frames sequentially in the ultrasound image clips. Specific analysis criteria, such as start and end frame numbers, start and end horizontal pixel shift numbers and pixel/mm values, were adjusted as appropriate.

Three equal-sized regions of interest (ROI) were manually selected on the area of muscle closest to the MTJ and gastrocnemius aponeurosis (Figure 8.4). In the subsequent frame, where the new position of the ROI was sought, the coordinates of the selected ROI were offset along the horizontal plane of the image a pixel at a time within a predefined range. At each position the software programme compared the grey-scale values from the ROIs to that seen in the previous original frame and

calculated the correlation coefficient. The ROI in the second frame that produced the largest correlation with the previous frame was chosen as the new position of the ROI. This process was repeated for subsequent frames. Thus the programme was able to accurately track the displacement of the ROI (Figure 8.4 & 8.5) producing the cumulative longitudinal displacement of the ROI and the mean hypotenuse of the three ROIs (Figure 8.5)



**Figure 8.4:** Image of selected ROI displayed using ultrasound imaging.



**Figure 8.5:** Image of calculation of velocity of displacement of ROI (row 1) in mm, hypotenuse (row 2) mm, horizontal displacement of ROI (row3) and vertical displacement of ROI (row 4) measured in mm. Note the minimal vertical movement.

The displacement of the ROI during the second and sixth slow ankle perturbations at baseline and post intervention, for the high, medium and low applied torques for the MS participants, and low torque for the controls, were recorded and the percentage strain was defined as:

$$\text{Percentage strain} = (\text{ROI displacement} / \text{gastrocnemius muscle length}) \times 100.$$

Where the gastrocnemius length was measured with the ankle in 10° plantarflexion

## 8.4 Analyses

The total, muscle and tendon lengths of the gastrocnemius complex for the pwMS and controls were compared using a between groups repeated measures ANOVA with factors being STRETCH (baseline Vs post).

Percentage strain and the displacement of the medial gastrocnemius muscle and



aponeurosis following the low torque 10 min stretch was compared between the MS participants and the control group using a between groups repeated measures ANOVA (SPSS 17.0, IBM) with factors being TIME (2<sup>nd</sup> vs 6<sup>th</sup> perturbation) and STRETCH (baseline vs post).

In pwMS a repeated measures ANOVA compared the effects of different applied torques on the percentage strain and ROI displacement with factors being FORCE (low, medium and high), TIME (2<sup>nd</sup> vs 6<sup>th</sup> perturbation) and STRETCH (baseline vs post).

A Pearson's rank correlation determined the relationship between the passive stiffness measured using the motor (see Chapters five and six), and percentage strain at baseline and following the application of the high torque. Additionally, the relationship between the change in total passive stiffness and the change in the percentage strain with the application of the high torque were determined. For all statistical tests, the level of significance was set at  $P < 0.05$ .

## **8.5 Results**

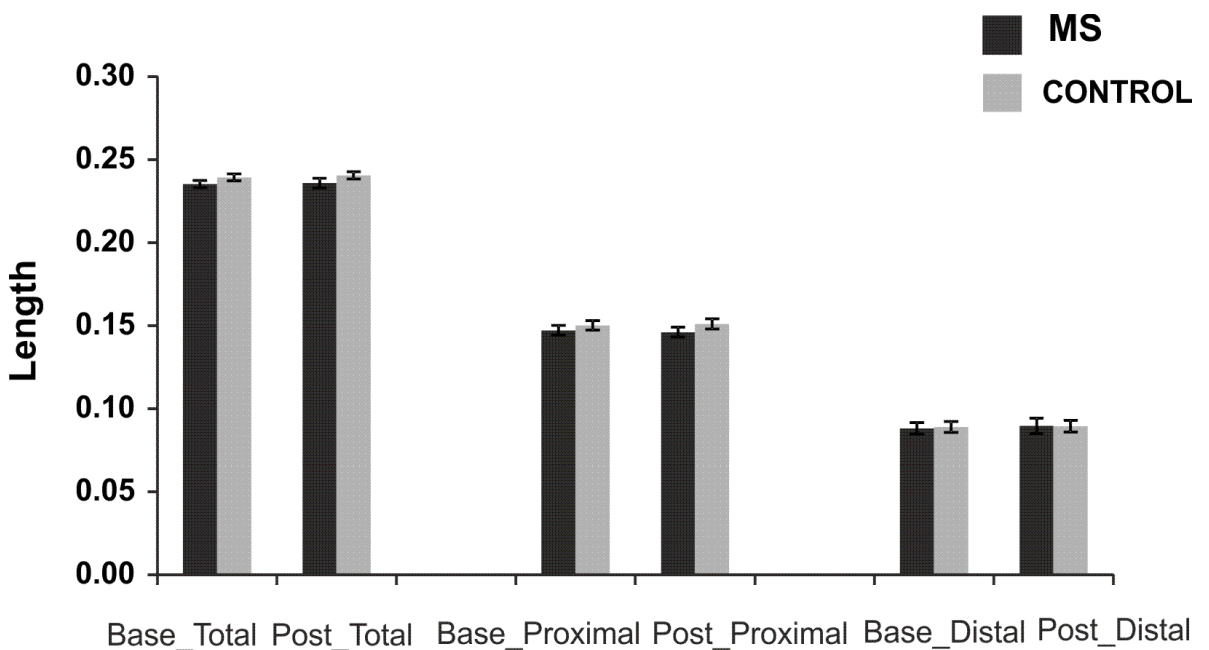
Ten pwMS were assessed with an average age of 58 yrs ( $\pm 10$  yrs); height 166 cm ( $\pm 6$  cm); weight 71 kg ( $\pm 14$  kg); length of time since diagnosis 7yrs ( $\pm 8$  yrs). Two of the participants were on anti-spasticity medication (Baclofen); five participants were diagnosed with relapsing remitting MS, two with primary progressive MS and three with secondary progressive MS. Participants with MS were compared to 12 healthy controls with an average age of 54 yrs ( $\pm 5$  yrs); height 164 cm ( $\pm 8$  cm) and weight 72 kg ( $\pm 20$  kg). Further demographic information can be obtained from chapter seven (Tables 7.1 and 7.2; Subjects 1-3, 5-8 and 10, 12, 13 were included in this study).

### **8.5.1 Muscle and Tendon Length: MS and Control Comparison**

*Length when measured in plantarflexion:*

The baseline total length of the gastrocnemius muscle-tendon complex normalised to

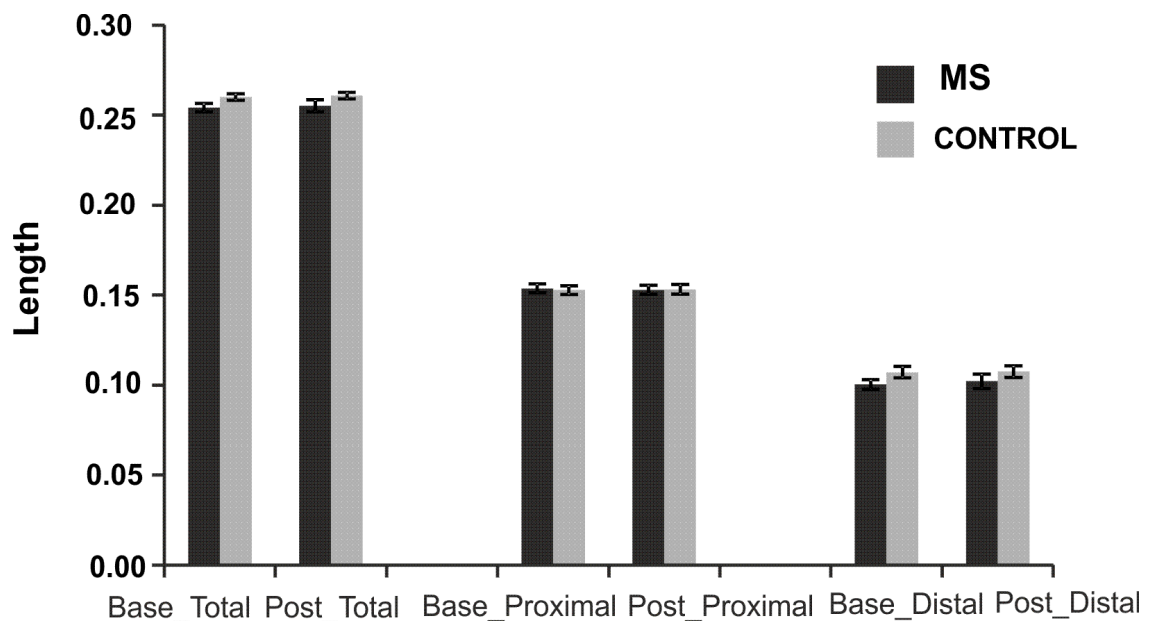
height was not significantly different between the pwMS and the control group when measured at 10° of plantarflexion where the muscle was off stretch ( $F(1,20)=1.3$   $p>0.05$ ) and there were no effects of stretch ( $F(1,20)=1.75$   $p>0.05$ ) or group x stretch interactions ( $F(1,20)=0.22$   $p>0.05$ ). Similarly the Achilles tendon length was not significantly different between the MS and control group ( $F(1,20)=0.004$   $p>0.05$ ) and there were no interaction effects ( $F(1,20)=0.07$   $p>0.05$ ) or effects of stretch ( $F(1,20)=1.81$   $p>0.05$ ). For the gastrocnemius muscle length there were no effects of group ( $F(1,20)=0.92$   $p>0.05$ ) or stretch ( $F(1,20)=0.028$   $p>0.05$ ). However, there was a trend towards significance for the group x stretch interaction ( $F(1,20)=3.69$   $p=0.069$ ). Here, following the stretch the muscle length was increased in the control group whilst it slightly decreased on average in the pwMS (Figure 8.6).



**Figure 8.6:** Total gastrocnemius muscle (Proximal) and Achilles tendon (distal) length (mm) measured with the foot in 10° plantarflexion. All lengths are normalised to the person's height. Total gastrocnemius and tendon length at baseline (Base\_Total), total gastrocnemius and tendon length post stretch (Post\_Total), gastrocnemius muscle length at baseline (Base\_Proximal), gastrocnemius muscle length post stretch (Post\_Proximal), Achilles tendon length at baseline (Base\_Distal), Achilles tendon length post stretch (Post\_Distal).

*Length when measured in dorsiflexion:*

The baseline total length of the gastrocnemius muscle-tendon complex normalised to height tended to be shorter in the pwMS when measured at 5° of dorsiflexion where the muscle was on stretch ( $F(1,20)=-3.3$   $p=0.08$ , Figure 8.7). There were no effects of stretch ( $F(1,20)=1.2$   $p>0.05$ ) or interaction effects ( $F(1,20)=0.013$   $p>0.05$ ). The Achilles tendon length was not significantly different between the MS and control group ( $F(1,20)=1.75$   $p>0.05$ ) and there were no time x group interaction effects ( $F(1,20)=0.60$   $p>0.05$ ) or effects of stretch ( $F(1,20)=1.2$   $p>0.05$ ). As with the measures in plantarflexion there was a trend towards a significance for the group x stretch interaction for the gastrocnemius muscle length ( $F(1,20)=3.89$   $p=0.063$ ) with the control group tending to show greater increases in muscle length following the stretch (Figure 8.7)



**Figure 8.7:** Total gastrocnemius muscle (Proximal) and Achilles tendon (distal) length (mm) measured with the foot in 5° dorsiflexion and normalised to height. Total gastrocnemius and tendon length at baseline (Base\_Total), total gastrocnemius and tendon length post stretch (Post\_Total), gastrocnemius muscle length at baseline (Base\_Proximal), gastrocnemius muscle length post stretch (Post\_Proximal), Achilles

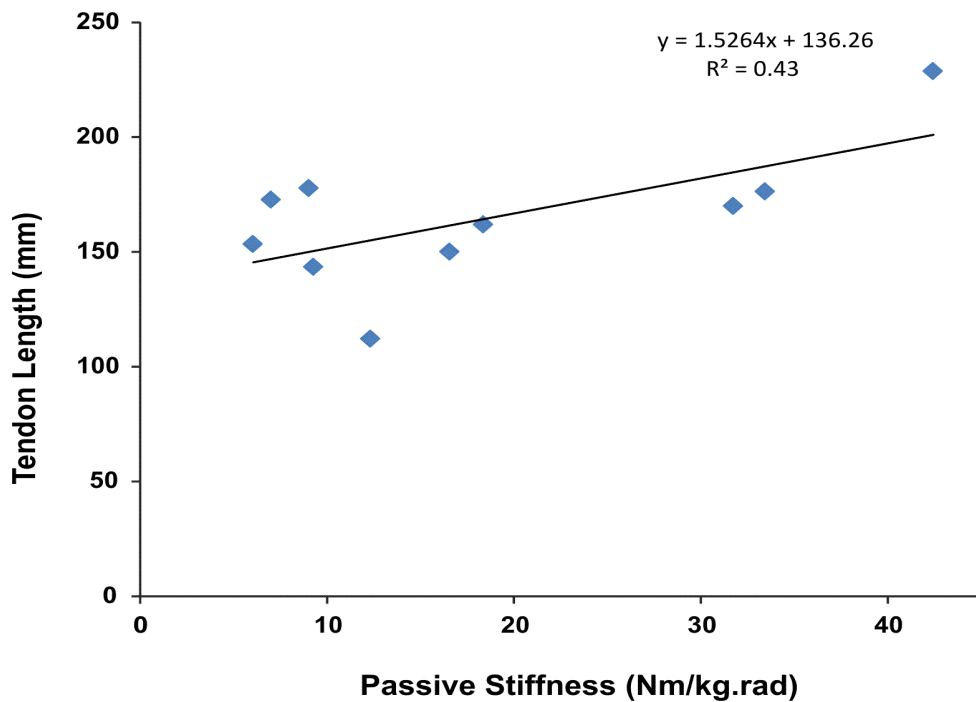
tendon length at baseline (*Base\_Distal*), Achilles tendon length post stretch (*Post\_Distal*).

### 8.5.2 Relationship Between Passive Stiffness and Muscle / Tendon Length

Passive stiffness, as measured using the motor, showed a moderately strong correlation with Achilles tendon length at baseline and post stretch (Table 8.1, Figure 8.8). Higher passive stiffness was associated with a longer Achilles tendon length.

	Baseline - Pre stretch	Post stretch
<b>Tendon Length Vs passive stiffness</b>	R=0.62*	R=0.65*
<b>Muscle length Vs passive stiffness</b>	R=0.27	R=0.29

**Table 8.1:** Relationships between passive stiffness and Achilles tendon and gastrocnemius muscle length measured with the ankle in dorsiflexion \* Indicates significance,  $P < 0.05$ .

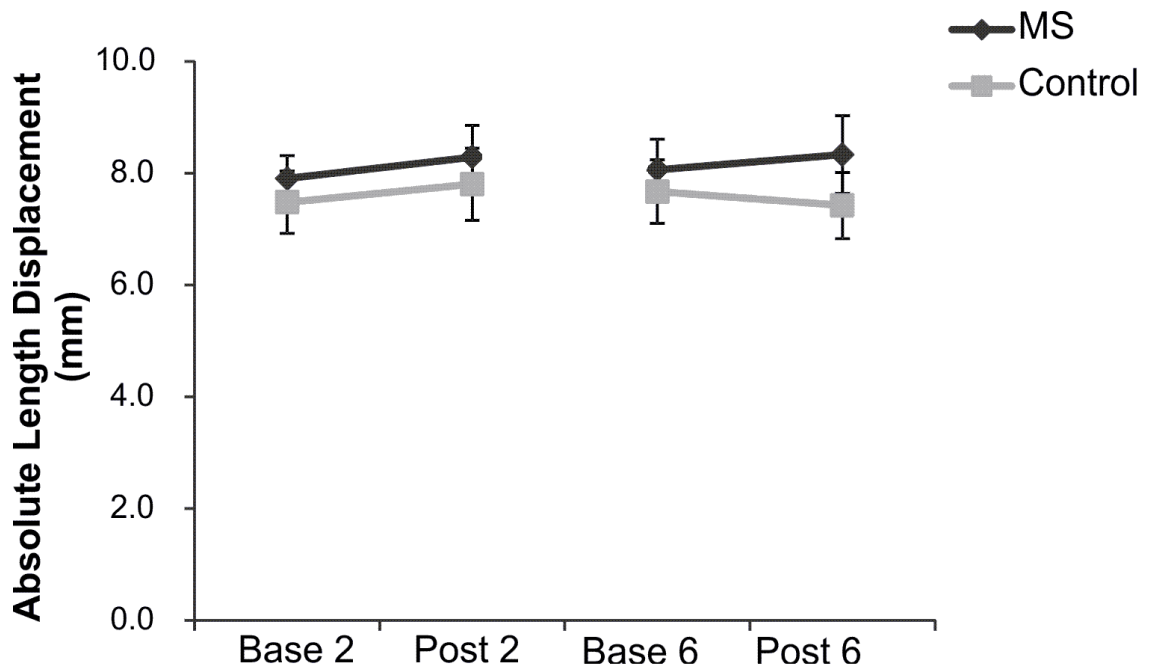


**Figure 8.8:** Relationship between passive stiffness and absolute Achilles tendon length in pwMS

### 8.5.3 Displacement of the ROI: MS and Control Comparison

There was no significant difference in displacement between the pwMS and control group (GROUP  $F(1,20)=0.48$   $p=0.50$ ) and there was no significant difference in displacement between measures taken at baseline and following the application of a low torque stretch for 10 minutes (STRETCH  $F(1,20)=1.08$   $p=0.31$ , Figure 8.9).

There was no significant difference between the second and sixth perturbation (TIME  $F(1,20)=0.001$   $p=0.98$ ). There were no other significant interaction effects (TIME X GROUP interaction  $F(1,20)=1.11$   $p=0.30$ ; STRETCH X GROUP interaction ( $F(1,20)=0.69$   $p=0.42$ ; TIME X STRETCH X GROUP interaction ( $F(1,20)=0.90$   $p=0.35$ ) (Figure 8.9).

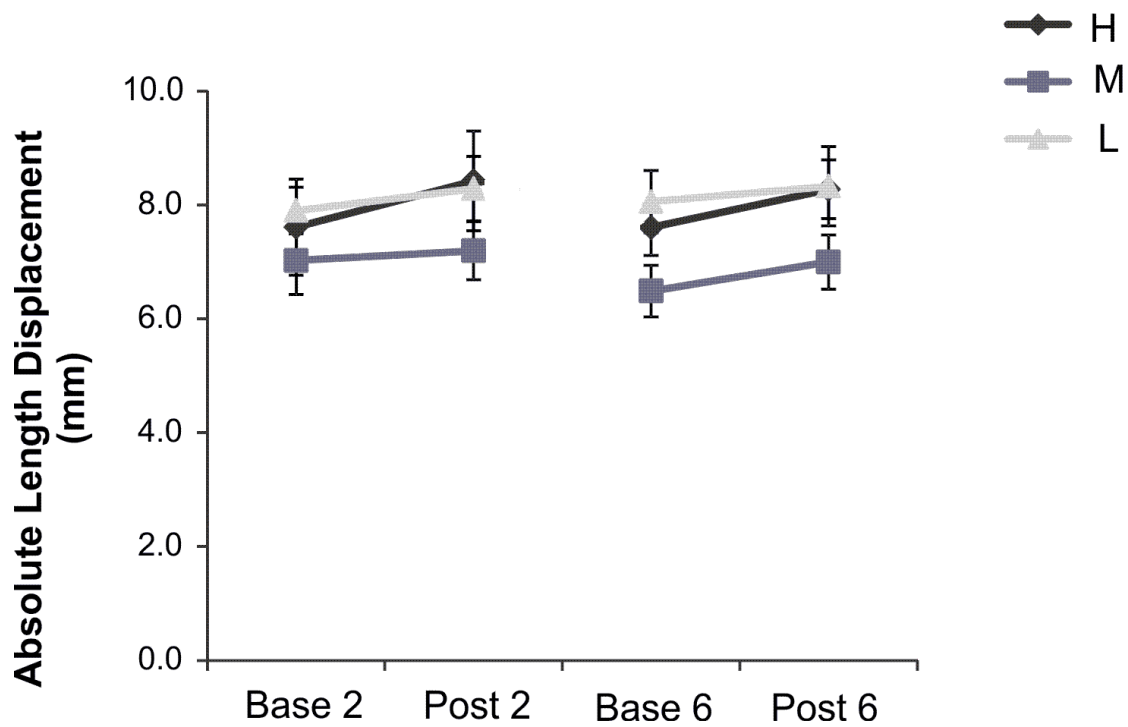


**Figure 8.9:** Absolute length displacement of ROI before and after stretch intervention with the low applied torque for the second and sixth perturbation: baseline second perturbation (Base2), post stretch second perturbation (Post2), baseline sixth perturbation (Base6), post stretch sixth perturbation (Post6) between the MS and control group. Mean  $\pm$ SEM are indicated.

#### 8.5.4 Absolute Displacement of ROI Following a Stretching Intervention in pw

##### MS

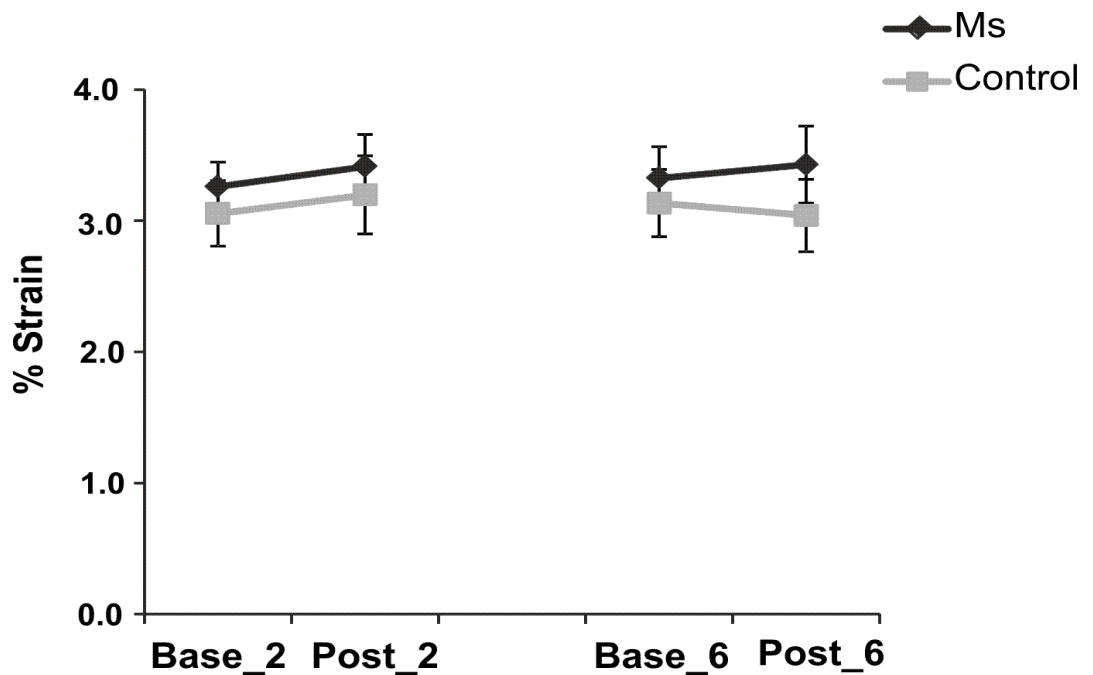
A significant difference in displacement between measures taken at baseline and post stretch intervention was observed (STRETCH  $F(1,9)=4.982$   $P=0.005$ ; Figure 8.10), with significantly greater displacement observed post stretch intervention. There was no significant difference in absolute length displacement with torque (TORQUE  $F(2,18)=3.023$   $p=0.074$ ). There was no significant effect observed between the second and the sixth perturbation at baseline or post stretch intervention (TIME  $F(1,9)=1.553$   $P=0.224$ ) (Figure 8.10). There was no other significant interaction effects; (TORQUE X TIME interaction ( $F(2,18)=1.501$   $p=0.250$ ); TORQUE X STRETCH interaction ( $F(2,18)=0.448$   $p=0.646$ ); TIME X STRETCH interaction ( $F(1,9)=0.021$   $p=0.888$ ); TORQUE X TIME X STRETCH interaction ( $F(2,18)=0.931$   $p=0.412$ ).



**Figure 8.10:** Absolute length displacement of ROI before and after stretch intervention with low applied torque for the second and sixth perturbation: baseline second perturbation (Base2), Post stretch second perturbation (Post2), baseline sixth perturbation (Base6), post stretch sixth perturbation (Post6) for the MS group. SEM are indicated. H = high , M = medium and L = low applied torque.

### 8.5.5 Strain: MS and Control Comparison

There was no significant difference in strain between the pwMS and control group (GROUP  $F(1,20)=0.49$   $P>0.05$ ) and no significant difference in strain measures taken at baseline and post stretch intervention (STRETCH  $F(1,20)=1.06$   $P>0.05$ ). There was no significant difference between the second and sixth perturbation (TIME  $F(1,20)=0.001$   $P=0.98$ ); TIME X GROUP interaction ( $F(1,20)=1.11$   $p>0.05$ ); STRETCH X GROUP interaction ( $F(1,20)=0.53$   $p>0.05$ ) and TIME X STRETCH X GROUP interaction ( $F(1,20)=0.89$   $p=0.36$ ) (Figure 8.11).

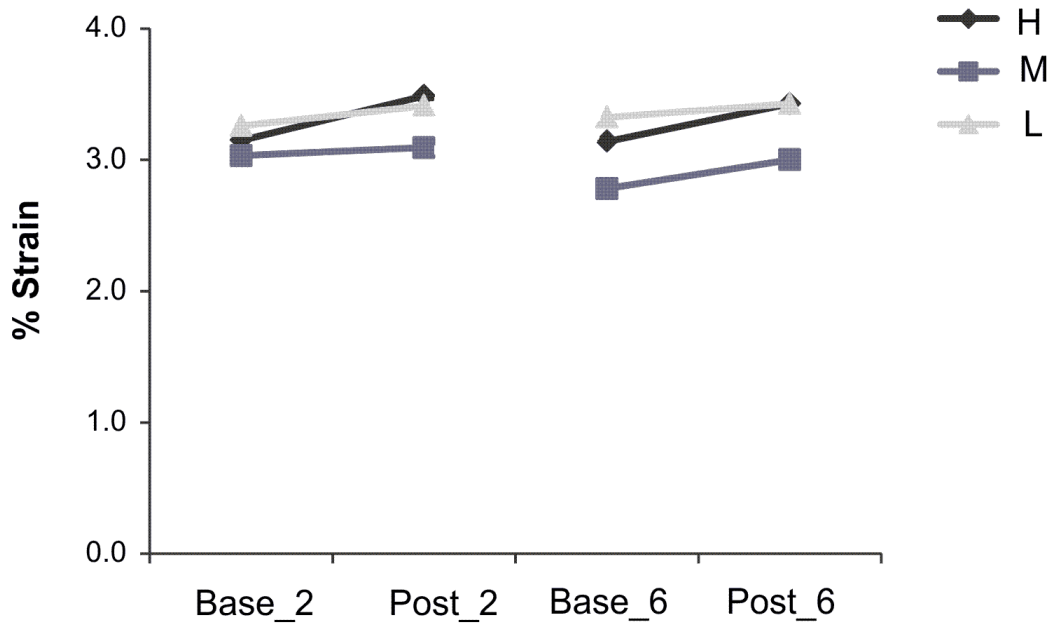


**Figure 8.11:** Percentage strain of ROI before and after stretching intervention with low applied torque for the second and sixth perturbation: baseline second perturbation (Base2), Post stretch second perturbation (Post2), baseline sixth perturbation (Base6), post stretch sixth perturbation (Post6) between the MS and control group. SEM are indicated.

### 8.5.6 Strain Following a Stretching Intervention in pwMS

There was a significant difference in strain between measures taken at baseline and following the 10 minute stretch intervention (STRETCH  $F(1,9)=5.07$   $p=0.05$ ) with a significant increase in strain being seen post intervention (Figure 8.12). There was no significant difference in strain measures with torque (TORQUE  $F(2,18)=1.76$   $p=0.20$ ). There was no significant difference between the second and sixth perturbation at baseline or post intervention (TIME  $F(1,9)=1.53$   $p=0.25$ ). Similarly, there was no significant TORQUE X TIME interaction ( $F(2,18)=1.43$   $p=0.27$ ); no significant TORQUE X STRETCH interaction ( $F(2,18)=0.55$   $p=0.59$ ); no significant TIME X STRETCH interaction ( $F(1,9)=0.12$   $p=0.74$ ) and no significant TORQUE X TIME X STRETCH interaction ( $F(2,18)=1.01$   $p=0.38$ ).





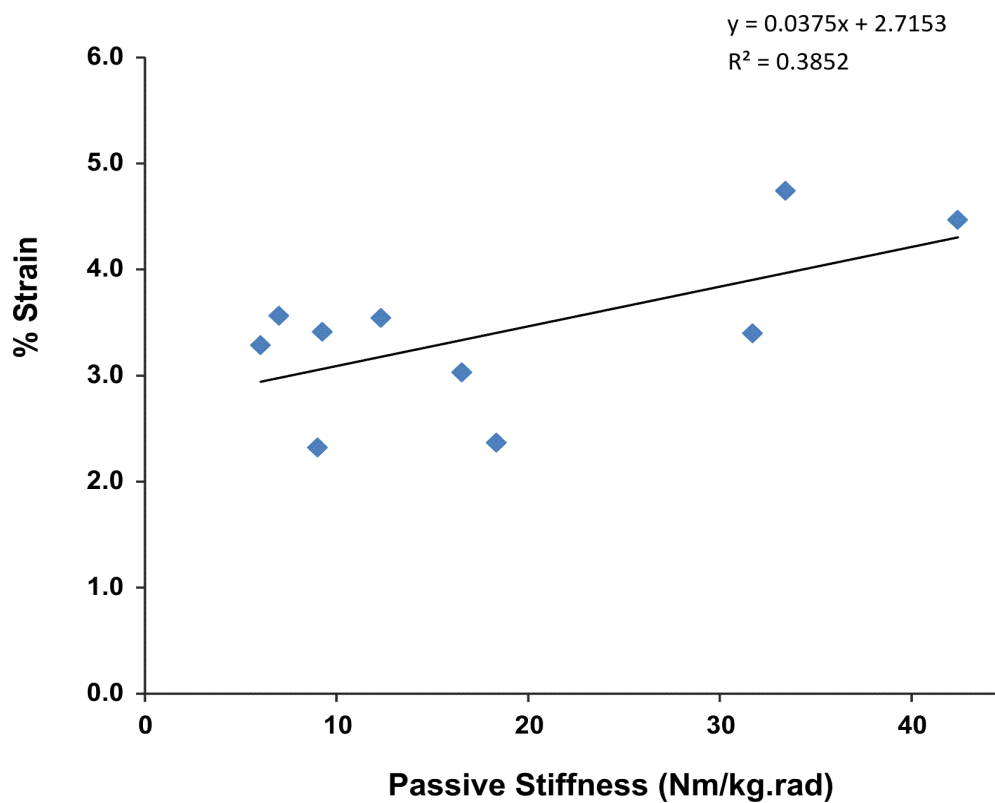
**Figure 8.12:** Percentage strain of ROI before and after intervention for the second and sixth perturbation: baseline second perturbation (Base\_2), Post stretch second perturbation (Post\_2), baseline sixth perturbation (Base\_6), post stretch sixth perturbation (Post\_6) for the MS group. SEM are indicated. H = high, M = medium and L = low applied torque.

### 8.5.7 Relationship between Passive Stiffness and Gastrocnemius Muscle-Tendon Strain

In pwMS the relationship between strain and passive stiffness was determined after the application of a 10 minute low torque stretch. A moderately strong significant correlation ( $r > 0.5$ , Cohen 1988) was observed between the post-stretch strain and post-stretch passive stiffness (Table 8.2, Figure 8.13). A higher passive stiffness was associated with an increase in strain. There were insubstantial to weak correlations ( $r < 0.3$  Cohen 1988) between the mean changes in strain and the change in passive stiffness as measured using the motor and the strain and stiffness measured at baseline (Table 8.2).

CONDITION	R Value	P Value
Baseline strain vs baseline passive stiffness	0.53	0.12
Post stretch strain vs post stretch passive stiffness	0.62	0.05
Change in strain vs change in passive stiffness	0.03	0.94

**Table 8.2.** Relationships between the strain and passive stiffness at baseline (pre stretch) and post 10 minute low torque stretch intervention. **R** = Pearson's rank correlation.



**Figure 8.13:** Passive stiffness measured post 10 minute low torque stretch compared with strain measures post stretch. All measures were taken with the foot in 10° plantarflexion.

## 8.6 Discussion

The aim of this study was to investigate the long term adaptations that may occur in the gastrocnemius muscle-tendon complex in pwMS and the short term changes following a 10 minutes constant torque passive stretch based intervention.

### 8.6.1 Differences in Total Gastrocnemius Muscle-Tendon Complex Length between pwMS and Controls

The total baseline length of the gastrocnemius muscle-tendon complex in a position of 10° plantarflexion was not significantly different between pwMS and the control group. However, when the gastrocnemius muscle was on stretch at 5° dorsiflexion there was a trend towards a difference between the groups with the controls demonstrating a longer total length compared to pwMS. It was anticipated that the *total* length would be identical between the two groups at these two positions, since every effort was made to fix the ankle and knee in identical positions in both groups and lengths were normalised to height. This trend suggests that in pwMS the heel may have come away from the footplate marginally as it was moved into dorsiflexion possibly due to increased stiffness in the muscle. Difficulties with maintaining ankle position during perturbations and isometric contractions when measuring muscle / tendon length and strain have been reported previously due to the small levers involved and the large force applied/generated at the ankle (Arampatiz et al. 2005). Although this result did not reach significance it must be acknowledged that this potential heel movement may have affected the results and more marked MS-control differences may have been seen with improved fixation systems. Future work could look at the reliability of this measurement system.

### **8.6.2 Gastrocnemius Muscle Stiffness and Achilles Tendon Compliance in MS**

There are several findings that suggest that the gastrocnemius muscle was stiffer and Achilles tendon longer and more compliant in some participants with MS. Firstly, muscle length increased following a 10 minute low torque stretch in controls whilst this was not seen in pwMS suggesting that the muscles were stiffer. Secondly, higher passive stiffness was associated with longer tendons in pwMS. Previous studies in stroke and CP have reported increased muscle stiffness and longer, more compliant tendons (Zhao et al. 2011). These findings lend support to this relationship.

### **8.6.3 Potential Site of Increased Passive Stiffness in pwMS**

One interesting finding was that higher passive stiffness was associated with greater strain. This suggests that our selected ROI, the MTJ, was actually less stiff / more compliant in people with a greater overall passive stiffness. This further implies that the area of increased stiffness must be located outside of the measured ROI. As the free tendon is longer (and possibly more compliant) in people with more overall passive stiffness this suggests that the increased stiffness lies within the muscle belly. The cause of this increased stiffness could be shortening of the muscle fascicles. Recent human studies have shown that muscle fascicle length can be decreased in people with CNS lesions although this has not been reported in pwMS to date (Gao et al. 2011; Kwah et al. 2012). Future works should therefore assess a broader ROI and / or measure muscle fascicle length directly.

### **8.6.4 Effects of Stretching on Passive Stiffness**

The results of chapter seven show that a 10 minute constant torque stretch results in a reduction in muscle-tendon passive stiffness as measured using the motor. The question remains as to the structures responsible for this reduction.

In pwMS stretching for 10 minutes at a constant torque resulted in a significant increase in strain in the ROI. As the ROI was located close to the tendon at the MTJ it is unclear whether the stretch targeted the main region that was stiff, which as

discussed above may be the bulk of the muscle more proximal to the region recorded with ultrasound. One conclusion that could be drawn from the finding that the muscle length in pwMS did not change as much as the controls post stretch is that this stretch may not have targeted the stiffest region.

Previous work highlights that the effects of stretching may not be uniform across the whole muscle-tendon complex. Nakamura et al. (2011) investigated in healthy participants the immediate effects of five minutes of constant torque stretching on the mechanical properties of the gastrocnemius muscle tendon unit using a dynamometer and ultrasonography. Total muscle-tendon and muscle stiffness were significantly reduced immediately following the intervention and 10 minutes post intervention as was observed in the studies undertaken for this thesis (see Chapters six and seven). Additionally, free tendon stiffness post intervention was found to be higher than the baseline measure (Nakamura et al. 2011). However, no significant difference in fascicle length was observed. It was therefore postulated that the change in muscle tendon stiffness observed post intervention could be due to changes in the properties of the internal tendon (aponeurosis); the ROI assessed in the current thesis study. In contrast, Gao et al. (2011) in a stroke population demonstrated that a 60 minute intelligent stretching regime does result in an increase in muscle fascicle length as well as a shortening of the tendon. Differences between these studies in the underlying population (healthy vs stroke) and the duration of stretch (five minutes vs 60 minutes) highlights the need for more work in this area assessing different populations and durations of stretch while measuring multiple areas of the muscle-tendon complex.

The current and past findings discussed above have important clinical implications for the management of hypertonia. The fact that longer, more compliant tendons associated with stiffer muscle groups have been reported in several populations with CNS damage suggests that the short term stretches that occur in everyday activities and are often implemented as part of a rehabilitation programme are resisted by the stiffer muscle and results in lengthening of the tendon. It would appear that, short term

stretches may exacerbate this issue. With a longer stretch, as applied in this thesis, stress relaxation may occur in the muscle and over the short and long duration result in muscle lengthening and a reduction in stiffness.

The finding of a longer muscle length in the control group is consistent with study one (Chapter 5) and suggests that this may be a real difference. It is possible that statistical significance was limited by the small sample size due to participant drop out, rather than reflecting other factors such as measurement error.

### **8.6.5 Changes in Gastrocnemius Muscle-Tendon Length with Stretching**

Following the application of a stretch the ankle was returned to the starting position and perturbed from 10° plantarflexion to 5° dorsiflexion. The length of the gastrocnemius muscle and Achilles tendon were assessed at the start and end of the perturbation and the displacement of an ROI at the muscle tendon complex assessed during the perturbation. As the position of the knee was fixed one would expect the total length of the muscle-tendon not to change following stretching when the ankle is placed in a standardised position. However, it is possible that the relative length of the muscle and tendon changes.

This study found no significant difference in the length of the gastrocnemius muscle or Achilles tendon following the application of either a high, medium or low torque constant stretch as measured by the combined 3D motion analysis – ultrasound technique. This suggests that a 10 minute stretch does not lead to any significant changes in overall length of either the tendon or muscle component. The implications of this in light of the observed changes in ROI displacement and strain will be discussed further in chapter eight.

### **8.6.6 Measurement of Gastrocnemius Muscle-Tendon Displacement and Strain**

There are several reported ways for evaluating the mechanical properties of the gastrocnemius muscle tendon unit. This experiment used tracking techniques of

manually selected ROI and a MATLAB software programme to calculate displacement. It has been demonstrated, in work looking at measuring strain in the Achilles tendon of rats, that the following techniques were all equally effective in accurately measuring strain: optical video for manual tracking of optical markers; optical video for DIC tracking of optical surface markers; and ultrasound video for DIC tracking of image texture within the tissue (Okotie et al., 2012).

The use of ultrasound accounted for only a two dimensional view of the selected ROI which is a 3 dimensional structure and this may have some potential influence on the findings related to the muscle-tendon aponeurosis. To minimise error, and to ensure smooth tracking of the selected ROI, continual visual checks were made and selected ROI were repositioned when the boxes did not appear to be tracking correctly (Herbert et al. 2011).

#### **8.6.7 Gastrocnemius Muscle-Tendon Displacement and Strain: Comparison Between MS and Controls**

There was no significant difference in the displacement of the ROI (the gastrocnemius muscle-tendon complex) and the percentage strain between the MS participants and control group. This finding is supported by the biomechanical measures of passive stiffness which demonstrated no significant difference between the MS and control group, indicating that the MS sample consisted of participants with only mild symptoms of hypertonia. Work by Hoang and colleagues in a comparable sample of pwMS observed similar findings and reported no significant difference in the mechanical properties of the gastrocnemius muscle-tendon complex between ambulatory MS patients and a healthy control group (Hoang et al. 2009).

Other studies have however found that neurological lesions can result in significant differences in muscle and tendon properties. The muscle fibres of people post stroke, for example, have been reported to be stiffer and shorter than healthy controls with an associated longer more compliant Achilles tendon (Gao & Zhang, 2008; Zhao et al. 2009). Further, in the Cerebral Palsy population, medial gastrocnemius strain was

significantly smaller than that of the healthy matched controls (Barber et al. 2011). The differences in findings between these studies and the work undertaken for this thesis may reflect differences in a range of factors including pathology, the severity of hypertonia, or in the methods used to calculate muscle stiffness. The studies in stroke assessed muscle fibre length changes when the muscle was either electrically stimulated or contracted isometrically. In contrast this thesis study assessed length changes following the application of a constant angle perturbation. This could result in differences in the underlying site of applied linear force (i.e. internally generated vs externally generated) and its transmission through the muscle-tendon complex (eg stressing mainly tendon – perimysium when applying an external force Vs additionally stressing endo- and epi- mysium when forces are generated internally).

#### **8.6.8 Gastrocnemius Muscle-Tendon Displacement and Strain: Effects of Stretching**

There were significantly greater levels of displacement of the ROI gastrocnemius muscle-tendon complex and greater strain in pwMS observed with a standardised perturbation following the 10 minute constant torque stretching intervention. As this ROI was placed within the muscle adjacent to the muscle-tendon junction this implies that the muscle fibres have moved more and so one may expect a longer end muscle length at the end of the perturbation. The fact that overall muscle length did not change suggests that either

(a) the measure of muscle and tendon length using combined ultrasound / 3D motion analysis was not sensitive enough to detect small length changes as found by the ultrasound cross correlation method

(b) the increase in displacement was not uniform across the whole muscle / tendon resulting in no overall change in the length of the muscle and tendon

(c) the increase in the displacement/strain is due to changes in the overall imposed stretch of the gastrocnemius resulting from changes in how the ankle attaches to the manipulandum moving the foot, that is movement of the foot during the stretch. If this



was true one would, however, expect an increase in overall length, which was not seen.

Nakamura and colleagues (2011) have provided support for point (b) that changes occurring with a stretch may not be evenly distributed for further details see (8.6.4). The current study assessed displacement around the muscle–tendon junction. Therefore, the observed increase in displacement and strain post stretch may reflect isolated alterations in the aponeurosis and muscle-tendon junction. Future work should simultaneously assess changes in displacement / strain at multiple sites within the muscle and tendon following a period of stretching to ascertain the exact site(s) of change.

#### **8.6.9 Measurement of Passive Stiffness**

Passive stiffness measured biomechanically using a motor showed moderate to moderately strong correlations ( $r > 0.5$ ) with the displacement and strain of the gastrocnemius muscle–tendon complex. This suggests that the biomechanical measure and ultrasound technique are measuring two related but different constructs. The biomechanical measure assesses the overall muscle-tendon stiffness and would include errors associated with estimating anthropometric data used to negate the contribution of the weight of the foot (see Chapter 4). In contrast the ultrasound method provided a measure of localised strain. Following a period of stretching increases in strain can be seen in the muscle with simultaneous reductions in strain seen in the tendon (Abellaneda et al. 2009). This highlights that a lack of a strong correlation between localised muscle and gross biomechanical measures may be expected.

As well as using biomechanical, EMG- and ultrasonography-based measures we also assessed the impact of stiffness in every study using the MSSS-88. As highlighted in appendix one, when the results of the three studies were combined a significant correlation ( $r = 0.44$ ) was seen between the total stiffness measured biomechanically (i.e. a combination of passive and stretch-mediated stiffness) and section three of the

MSSS-88 that assesses the effect of muscle spasm on walking. Additionally, sections 1 ( $r=0.34$ ), 2 (0.38), 4 ( $r=0.31$ ) and 6 ( $r=0.27$ ) of the MSSS88 showed weak correlation to biomechanical measures of total stiffness, for further detail (see appendix 1). The lack of correlation with the other sections of the MSSS88 probably reflect the difficulty in distinguishing between the impact of spasticity and passive stiffness on function from other co-existing impairments such as fatigue and weakness. Further work is needed to explore the relationship between self-reported impact of stiffness, using measures such as the MSS88, and lab based and clinician rated objective measures.

Knowledge about changes in stiffness that occur with pathology, and the effects of different interventions on stiffness, may require detailed assessment of strain using ultrasound as described in this chapter. It is important to acknowledge that the ultimate aim of many clinical interventions is to improve functional ability; measures relating to function, as in the MSSS-88, are also therefore relevant. Clinical trials may benefit from using a range of outcome measures to investigate changes at an impairment, activity and participation level.

## **9. Chapter Nine: Summary and Future Directions**

### **9.1 Introduction:**

MS is a chronic demyelinating disorder of the central nervous system (CNS) and is one of the leading causes of neurological disability in young adults. Pathologically MS can be extremely variable and multiple variants have been identified; this is predominantly due to differences in the site and severity of damage in the CNS. This variability leads to the unpredictability of the presenting signs and symptoms at disease onset; including altered balance and co-ordination, visual disturbances, bladder and bowel dysfunction, pain, fatigue, cognitive dysfunction, weakness, stiffness and spasms (Boyce, 1998). Increased limb stiffness, or hypertonia, is present in up to 85% of people with MS and is clinically observed as an increased resistance to passive movements of a limb. It is associated with considerable functional limitations and pain leading to reduced quality of life (Barber et al. 2011; Gao et al. 2011).

The main contributing factors to hypertonia are an increase in passive and stretch reflex related stiffness (spasticity) (Dietz & Sinkjaer, 2007). Currently spasticity is managed primarily through the use of pharmacological agents, and non-neural passive stiffness is predominantly managed through the use of stretching and physical adjuncts, with the fundamental focus being to: maintain or improve function; prevent the development of secondary complications; alter patterns of spasticity and spasm development; minimise pain; and improve comfort (Lockley & Buchanan, 2006).

The current literature surrounding the use of stretching for the management of hypertonia is inconclusive. Although previous research and reviews demonstrate some areas of agreement, disparity and inconsistencies of findings are also present. It is possible that the disparity in the literature stems from a lack of clarity surrounding the nature of hypertonia unrelated to stretch reflex activation. There are varying schools of thought regarding the contributing mechanisms of hypertonia including: changes in the extracellular matrix (ECM) of muscle and tendon; changes in intramuscular proteins,

changes in cross bridge attachment and changes in fascicle length and sarcomere length/number. Consequently, it is often not possible to identify the site or construct most affected in people with hypertonia; this results in further confusion regarding the efficacy of stretching passive interventions. Moreover poor knowledge of the optimal parameters for stretching interventions, the varied outcome measures used, and the variable nature of MS, all contribute to the lack of clarity in the literature. It is evident that there is a lot that is unknown regarding the management of hypertonia and further research is required. Knowledge of the optimal parameters for treatment such as: the type of stretch, applied force, stretch duration and method of application are key for the successful rehabilitation of people with hypertonia and it is clear that the paucity of information in this area has important clinical and function implications.

## **9.2 Aim**

This thesis therefore aimed to assess the effects of different torques applied over different time durations on passive stiffness, spasticity and ROM; additionally, the site affected by stiffness and the area targeted by stretching was investigated. The thesis therefore aimed to:

- a) Define the torques that are applied during commonly prescribed manual stretches in pwMS (Chapter 5)
- b) Investigate the effects of different levels of applied torque and durations of stretch on passive stiffness, spasticity and ROM in pwMS (Chapters 6 and 7)
- c) Investigate the effects of constant torque stretching on direct measures of muscle strain using ultrasonography (Chapter 8)

## 9.3 Stretching science and practice

### Summary of novel findings

#### *Torques achieved and duration of manual stretches in pwMS:*

The mean ankle torque achieved when stretching the PF muscles was higher in standing conditions compared to seated stretches applied using the upper limbs. It is feasible to postulate that the significant increase in applied torque achieved during standing is due to the effects of gravity and body weight providing a form of constant applied torque. This finding is supported by work conducted by Baker, et al (2007) who investigated the effects of 30 minutes of standing on a tilt table compared to an exercise programme, results showed that significantly greater ankle and hip ROM was achieved with the standing condition compared to an exercise programme. Furthermore, work by Odeen and Knutsson, (1981) found greater reductions in hypertonus with tilt table standing compared to torque applied in supine, this further supports the findings of this thesis that higher levels of applied torque are associated with a greater increase in joint ROM. Similarly, based on the meta-analysis findings conducted in this thesis, constant torque stretches are potentially more beneficial at increasing ROM and decreasing spasticity than stretching at a constant angle and cyclically.

The literature surrounding stretching for the treatment of hypertonia in people with CNS pathology is variable and specific investigation surrounding the most efficient stretching parameters that can produce long term carry over is limited. This is in part due to a lack of understanding regarding (a) the main structures contributing to the non-reflex component of hypertonia (b) what parameters are the most important to target/activate signaling pathways that lead to remodeling and muscle growth and achieve long term carryover of treatment benefits and (c) paucity of research investigating long term changes with stretching. However, it is clear from this work and other literature in the

area that parameters such as applied torque, stretch duration and type of stretch are important factors that can significantly alter joint ROM.

PwMS, were able to achieve similar torques compared to matched controls but were unable to achieve the same degree of muscle lengthening. This in part may be due to the fact that pwMS had a higher level of baseline passive stiffness and significantly greater levels of spasticity. In addition, pwMS had significantly higher EMG activation in both the DF and PF muscles for all stretching conditions in study 1 (Chapter 5). This could be either a reflection of stretch reflex activation or increased muscle activity required to maintain the stretch position in standing due poor underlying balance. Therefore, it can be speculated that the increased resistance to movement either due to enhanced neural (spasticity) or intrinsic stiffness in this group has negatively influenced the lengthening potential of the PF muscle in pwMS.

PWMS were able to sustain a PF stretch in standing, on average, for two and a half minutes with greater durations of up to four minutes with more supported stretches in sitting or in a standing frame. The current literature demonstrates that stretch durations from 30 minutes up to 6 hours are required to achieve a significant change in stiffness in people with CNS lesions. This therefore questions both the efficacy and feasibility of home exercise stretching programs and passive therapeutic stretching techniques implemented clinically.

***Effects of torque and duration on: passive stiffness, spasticity and ROM:***

This thesis has established that higher levels of torque are associated with a greater increase in ROM and longer durations of stretch, results in greater reductions in passive stiffness and greater increase in joint ROM. Neither applied torque nor stretch duration was found to influence spasticity in pwMS, and no high quality literature has demonstrated a significant reduction in spasticity with stretching at a constant torque, angle or cyclically. This further questions the feasibility of current stretching techniques for the management of spasticity and demonstrates the need for further work in this

area looking at different stretching techniques such as Proprioceptive Neuromuscular Facilitation.

***Preliminary work on site of stretch:***

People with hemiparesis due to chronic stroke for >1 year have been shown to demonstrate an increase in tendon length on the paretic side in addition to decreased stiffness. A more compliant tendon would elongate significantly more when loaded, potentially altering the force generating capacity and speed of force transmission of muscle; this would potentially impede movement, function and lead to muscle atrophy and decreased energy efficiency. In the stroke population it is thought that the ECM surrounding muscle is abnormally stiff and lies in series with a compliant tendon (Winters et al. 2009).

Similarly, people with CP have been demonstrated to have significantly shorter muscle fascicles in work by Mohagheghi et al. 2007. This thesis has established a significant relationship between passive stiffness, strain and tendon length; indicating that higher levels of passive stiffness are associated with increased strain in the region of the MTJ, in addition to increased free tendon length. This finding is supported by study 1 that demonstrated that pwMS were not able to achieve a similar level of muscle lengthening to a similar applied force and chapter 8 where a trend towards a significant group x time interaction was found following a stretch where the muscle length was increased in the control group while it decreased on average in the pwMS.

These findings have potentially revealed a potentially important problem; if stretches target compliant tendons this could have a detrimental effect on the efficacy of therapeutic interventions, compounding the problem of shortened muscle fascicles and elongated tendons which are thought to affect force output. This thesis presented preliminary, indirect evidence that increases in strain (compliance) were seen near the level of the MTJ but that the more proximal part of the muscle may not elongate with stretching. This further emphasizes the need for more high quality research in this

area and could potentially among other things explain some of the disparities currently present in the stretching literature.

***Understanding the cause of passive stiffness:***

It is thought that within the physiological sarcomere slack length both titin and cross bridge formation were the main contributing factors to passive tension formation. Outside this range it is thought that the ECM is the highest contributing factor to passive stiffness development along with a contribution due to shortened sarcomeres and muscle fascicles.

***Shortened sarcomeres:***

Early work by Katz and Rymer (1989) suggested that mechanical changes in the contractile properties of a patient with hypertonia was due to a combination of degenerative or atrophic morphological changes in the muscle structure including muscle atrophy with collagenous and elastic tissue infiltration. Investigations looking at muscle cells with the ECM removed using micromechanical testing apparatus had shown that the muscle fibres from patients with spasticity were over twice as stiff with a shorter resting length compared to healthy controls, suggesting intracellular changes associated with hypertonia and spasticity (Friden & Lieber, 2003; Wang et al. 1993). In contrast Lieber and Friden (2002) who used intraoperative laser diffraction techniques in order to compare Flexor Carpi Ulnaris (FCU) sarcomere length in children with chronic wrist flexion contracture with healthy controls reported that children with wrist flexion contractures had muscles with normal fibre length although the sarcomeres within the fibers were elongated. Elongated sarcomeres would result in a greater resistance to elongation at a given overall muscle length as there is a non-linear increase in stiffness with lengthening (Lieber & Friden, 2002).

***Titin:***

As muscle is stretched beyond its slack length the subsequent passive tension developed within fibres has been attributed in part to titin. It is reported to contribute an



estimated 90% towards passive force in skeletal muscle within the physiological sarcomere length. Titins' force is thought to reposition the thick filament in the centre of the sarcomeres length and contribute towards the structural integrity of the sarcomere during myofibrillogenesis (Fukuda et al, 1998). Thus loss of titin can result in abnormal sarcomeric organisation which has been established in cell culture Van der Ven et al. (2000) and within the disuse atrophy model (Udaka et al., 2008). In skeletal muscle two types of titins are expressed in slow and fast muscle with different sizes of IGH and PEVK segments: both segments are longer in slow than in fast muscle fibers.

Titin develops force in a non-linear manner when stretched with an external force and it is reported that stretches applied externally increases the end to end length in addition to reduced bending movement, which results in a decrease in passive force in muscle (Fukuda, 2008). However, due to the intimate relationship titin has, tightly binding to myosin and myosin-binding protein C, sarcomere extension by external forces may cause mechanical strain to thick filaments via titins' longitudinal force, allowing myosin attachment to actin and the formation of cross bridges in a passive state (Labeit et al., 1992).

Recent work by Udaka et al, (2008) reported that ultra-structural changes can occur in the sarcomere following long-term disuse in both a longitudinal and lateral direction; this is often associated with a reduction in passive and active contractile force. However, to date there is no definitive data demonstrating that titin is altered secondary to spasticity but there is circumstantial evidence suggesting that it is possible at least in cardiac muscle (Wu et al., 2002; Warren et al., 2003).

### ***ECM:***

The ECM has a variety of functions and plays an important role in force transmission and tissue structure maintenance in tendons, ligaments, bone and muscle. The study of muscle ECM is considerably complex, however it has been demonstrated that the mechanical properties of isolated single muscle fiber segments measured in muscle

cells from patients with CP were shown to develop passive tension at a significantly shorter sarcomere length and the modulus of the stress strain relationship was double that of healthy controls. These findings suggest that there has been noteworthy remodeling of either intracellular or extracellular muscle structural components such as collagen and titin. Additionally, work conducted in decellularizing skeletal muscle has shown that the modulus for single fibres is almost identical to grouped fibres that have had the ECM biochemically removed. In contrast, the modulus of fibre bundles with intact ECM was approximately five fold higher than that of single fibres, leading to speculation that the ECM is an extremely stiff structure encompassing relatively compliant muscle fibres (Winters et al., 2009).

***Crossbridges:***

The support for the role of cross bridge formation to tension development relies mainly on work conducted in animals. It is thought that when a muscle fibre is stretched there is an initial marked increase in stiffness, termed short range stiffness, which then decreases (Proske & Morgan, 1999). This initial increase in stiffness is felt to be due to the resistance applied by attached cross bridges' "flexural rigidity" that then breaks, leading to the reduction in stiffness. Importantly this short range tension depends on the history of the muscle, whether it is lengthen or contracted prior to application of the stretch.

In addition, it is thought that the muscles of patients with chronic CNS lesions may experience a severe slowing of the detachment rate, producing abnormal stiffness. It is thought that this may be an adaptation for the loss of cerebral control of tension. However, without more direct evidence for cross bridge stiffness in persons with CNS lesions and without a clear physiological mechanism, treatment based on this mechanism is premature. Furthermore Hagbarth et al, (1985) suggested that cross bridge connections between actin and myosin filaments at rest can potentially heighten muscle phasic stretch reflex activity.

In summary, an overview of literature on passive stiffness from quite disparate sources highlights that many potential sources of stiffness may interact; titin may lead to increase cross bridge attachment and increased cross bridge attachment has been hypothesized to enhance the phasic stretch reflex. Therefore, future work using human and animal models of stiffness and tone should look at these interactions and whether they are affected in models of hypertonia.

***Understanding molecular pathways that lead to fibrosis:***

Skeletal muscle fibrosis is an ongoing pathological problem in people with chronic myopathies, involving the continual laying down of collagen and other extracellular matrix proteins produced by fibroblasts in place of healthy myofibers (Zhoa et al., 2008). Fibroblasts have an important role in tissue healing and remodeling by secreting ECM proteins including collagen and growth factors. However, in some instances such as in the case of chronic myopathies, continued fibrosis often contributes to the pathological process. This process is also associated with decreased strength and increased passive stiffness of muscle fibers (Bischoff, 1994). Therefore, identification of the factors that regulate fibrosis is important in order to develop effective therapeutic interventions.

Atrophy in muscles is reported to be linked to muscle fibrosis and an increase in fatty deposits within cells; both atrophy and hypertrophy are thought to be controlled by interacting pathways (Naderi et al., 2009). Myostatin, which is from the family of transforming growth factor beta and is expressed in skeletal muscle; is thought to facilitate muscle atrophy, stimulate the proliferation of muscle fibroblasts and the production of ECM proteins, this process involves the activation of several pathways including Smad, p38 MAPK, PI3K/Akt, thus directly influencing fibrosis (Glass, 2005).

Other mediators include transforming growth factor beta1 (TGF $\beta$ -1) which is thought to induce a modification in satellite cells from myogenic to fibroblasts. Furthermore,

muscle fibroblasts are reported to express myostatin and its receptor activin IIB (Rebbapragada et al., 2003).

Current research evidence shows that in the absence of myostatin, muscle regeneration increases and fibrosis decreases. In addition, it has been demonstrated in mice that distraction of the myostatin gene leads to muscle hypertrophy and hyperplasia (McPherron et al., 1997). In support of this work by Schuelke et al, (2004) has demonstrated the function of myostatin as an inhibitor of muscle growth in humans. This is reported to be through the mechanism of proliferation and differentiation of muscle precursor cells (Wagner et al., 2005). In the absence of myostatin muscle regeneration following acute or chronic injury has been observed to be faster.

Thus it is clear that the muscle atrophy pathways and fibrosis pathways are intimately inter-linked. Understand the pathways underlying the regulation of connective tissue, titin and sacromere number would allow a) us to monitor the effects of stretching remotely i.e. using biomarkers (b) affect fibrosis pharmacologically (c) allow us to directly affect atrophy-fibrosis interactions through combined physical interventions e.g. stretching and strengthening combined.

***The future of stretching trials and clinical implications:***

This work highlights the fact that there are several parameters that can affect stiffness. Both stretch duration and applied force can significantly influence the ROM achieved when stretching, longer stretch durations achieve a greater reduction in passive stiffness and increase in ROM. However, it is possible that a combination of stretching and strengthening is required in order to be able to use the new available range gained through stretching and to break the interaction between the atrophy and fibrosis pathways.

Similarly, it has been established that stretching at a constant torque can significantly improve the passive joint ROM achieved over a short term period. However, this form of stretching had no influence on spasticity and it is possible that these short term

stretches may be targeting the compliant tendons in people with CNS lesions as opposed to the potentially stiffer muscle fibers, thus potentially accentuating this problem. Therefore, it is feasible to postulate that therapeutic stretching that incorporates direct deep tissue massage to muscle fascicles could be used to target the stiffer muscle fibers that may not be targeted with short term stretch. Hagbarth and Eklund, (1965) highlighted that brief vibration of the bellies of tendons of healthy muscle, which did not induce a tonic vibration reflex, caused a decrease in stiffness by disengaging attached cross bridges. Perhaps such mechanical agitation applied to muscle of patients with hypertonia after a contraction could facilitate the dislodging of cross bridge connections between filaments.

Understanding how these multiple factors and interactions affect stiffness in the long term in humans is difficult due to the length of time required to conduct individual clinical trials investigating the above mentioned parameters. Therefore animal models of hypertonia may be more appropriate.

The efficacy of stretch and the question as to whether stretching is “good or bad” with regards to its overall clinical effect is still unclear. Gunn et al, (2013), for example, has shown a decreased frequency of falls in people with MS and moderate stiffness (as measured by the MAS) compared to those with lower or higher stiffness. This relationship may reflect the fact that some degree of hypertonia may be useful for stability. In keeping with this, work by Marsden and Stevenson, (2013) investigating balance dysfunction in people with HSP demonstrated that postural sway was related to muscle paresis and decreased sensory input and importantly people with higher total ankle stiffness had less anterior / posterior sway which was postulated to help with stabilization of the body. Thus hypertonia may not always be detrimental to functional activities and a greater understanding of the relationship between stiffness enhancing stability but decreasing movement is required and how this changes across a person’s lifespan and disease course.

## **9.4 Summary of Literature Review Findings**

The findings from a review of the literature indicate that stretching interventions, applied as part of a controlled or uncontrolled trial can significantly improve ankle ROM. In controlled trials the 95% CI ranged from 3.3 to 8.62°, favoring treatment. It remains unclear if these findings, although statistically significant, translate to a clinical worthwhile effect, as it is not known what constitutes a minimally significant clinical difference.

It is assumed that transient stretch mediated effects may be useful for the immediate clinical situation however future work needs to be directed at improving understanding regarding the clinical utility of these improvements. The effects of stretching on passive stiffness and spasticity as measured using biomechanical and electrophysiological measures all show effect sizes whose 95% confidence limits cross zero. Therefore, it is unclear where the actual treatment effect lies. It is possible that the variable nature and presentation of stiffness/spasticity, the potential inconsistency in measures obtained over different treatment sessions (Cadenhead et al., 2002; Odeen, 1981; Selles et al., 2005) and test repetitions (Nuyens et al. 2001) have contributed to findings reported in the literature. Furthermore, stretching may have differential effects on the muscle and tendon depending on the degree of underlying stiffness (Abellaneda et al. 2009). Therefore, techniques to measure muscle fibre stiffness and tendon stiffness directly may be more sensitive at revealing changes with stretching compared to gross measures of the muscle-tendon stiffness.

## **9.5 Summary of Experimental Findings**

Study one (Chapter five), investigated the types of forces that pwMS could achieve while doing common clinically prescribed stretches for the plantarflexors. Both control and MS groups produced higher torques in standing conditions that used body weight and the effect of gravity; achieving greater reductions in stiffness. Participants with MS

produced less torque and achieved less lengthening of the plantarflexors when using their arms to apply a stretch; this may potentially reflect weakness and fatigue of the upper limb muscles resulting in an inability to generate a significant force to stretch the plantarflexor muscles. A net plantarflexor ankle torque can be caused by forces associated with passively stretching the plantarflexors and/or actively contracting the plantarflexors; the inverse dynamics approach used in the current study to calculate the ankle torque was unable to distinguish between these possibilities.

It was noted that people with lower functional ability as measured by the Barthel Index tended to favor the more supported FRAME and PULL stretching conditions whilst participants with higher functional ability favored the WALL and STEP stretches. However, no correlation was found between applied torque, level of stiffness and functional ability. On the basis of these results it is apparent that stretches in standing are more effective at improving ankle ROM and decreasing stiffness; however this may not be feasible for some individuals with more severe disability.

Experiments to date using motors to apply a stretching intervention have used arbitrary forces/torques, thus the first study within this thesis has established novel information regarding the level of applied torques that can be independently produced by pwMS. These findings can be used to investigate the effects of stretching using motors, with the results being also applicable to manually applied stretches. Although gravity and body weight can help to stretch the ankle plantarflexors it may not be possible to apply similar forces to other stiff muscle groups such as the knee extensors. In such cases a motor may be needed to apply higher force; therefore the studies reported here could also help to guide the development of interventions that aim to deliver stretches using a motor.

Studies two and three, reported in chapters six and seven, used a range of torques established in study one. They investigated the effects of a high, medium, and low constant torque applied over a 10 and 30 minute stretching duration. The use of a motor allows the stiffness of the whole muscle-tendon complex to be measured. This

was conducted by imposing stereotyped stretches and measuring both the mechanical and EMG response. This method has the advantage that it can measure stretch-evoked stiffness in the same units as passive stiffness. These studies indicated that stretching for both 10 and 30 minutes significantly improved ROM in pwMS. This is in line with what has been reported in the literature.

It is clear that both applied torque and stretch duration are important factors to be considered when implementing interventions to improve range at the ankle in pwMS with hypertonia. Higher applied torques resulted in greater improvements in ROM. Further, a greater percentage change in ROM was seen after a 30 minute stretch compared to a 10 minute stretch. This implies that for participants with contracture or significantly reduced ROM, such as those in study two, that both stretch duration and applied torque have to be considered in order to attain optimal improvement in ROM immediately post intervention.

A significantly greater decrease in passive stiffness was achieved with 30 minutes of stretch compared to 10 minutes, suggesting that patients with enhanced passive stiffness would potentially benefit from longer duration stretches irrespective of the force applied. The level of applied torque however, had no significant effect on measures of passive stiffness or spasticity. It is speculated that the high variability in baseline passive stiffness and spasticity among participants may have resulted in the above finding. Additionally, overlaps in the absolute levels of applied torque between different conditions may also have contributed to the observed findings when torque levels were normalised to body weight; suggesting the importance of absolute torque level applied in interventions. The small effect of the implemented stretching intervention on hypertonia potentially suggests the need to look at other stretching treatments/techniques with/without administration of anti-spasticity medication.

Chapter eight investigated the effects of constant torque stretching on direct measures of muscle strain using ultrasonography. The findings suggested that pwMS have stiffer



muscle and more compliant tendons, which is in line with the findings in the literature. Muscle length was found to increase following a low torque stretch in healthy controls whilst this was not seen in pwMS, suggesting that their muscles are stiffer. In addition, higher passive stiffness was associated with longer tendons in pwMS which is supported by work in stroke and CP populations. One cause of this increased stiffness could be shortening of the muscle fascicles. Recent human studies have shown that muscle fascicle length can be decreased in people with CNS lesions although this has not been reported in pwMS to date (Gao et al. 2011; Kwah et al., 2012). Alternatively, changes in muscle stiffness could be due to changes in the properties of the internal tendon (Nakamura et al. 2011). Further work is required measuring multiple areas of the muscle-tendon complex to establish the exact site and cause of increased passive stiffness in people whose severity of stiffness varies.

There were significantly greater levels of gastrocnemius muscle-tendon complex displacement and greater strain in pwMS following the 10 minute low torque stretching intervention. The observed increase in displacement and strain post stretch may reflect isolated alterations in the aponeurosis and muscle-tendon junction. Due to the ROI selected it was not possible to establish the effects of stretching on the muscle fascicles, it is therefore difficult to make any definitive statements regarding the area that the applied intervention was targeting. However, it is possible that the current stretching intervention may not be targeting the stiffest regions, therefore future work needs to look at a bigger ROI encompassing muscle fascicle/muscle bell as well as tendon complex.

## **9.6 Study Limitations**

There are several potential factors that affect the overall study interpretation including: the patient group targeted, the numbers recruited, the clinical feasibility of the stretches applied, the outcome measures used and the relationship between the short and long term effects of stretching.

***Study participants:***

The motor system used to assess stiffness required participants to have a minimum of 90 degrees ankle range with no inversion or eversion deformities in order to be able to safely use the motor. These inclusion criteria restricted the participants that could take part in the study and may be a contributing factor to the mild stiffness presentations of participants recruited. PwMS were also recruited based on their subjective reports of muscle stiffness. However, objective measurements indicated that the participants recruited, particularly in study three (Chapter seven) were not significantly stiffer from controls. This questions the accuracy of the subjective rating of stiffness by individuals with MS. It may be that subjective reports of stiffness reflect factors different from those objectively measured in the current study.

***Self-report measures of stiffness:***

Throughout this thesis the MSSS-88 was used at baseline to measure the subjective impact of muscle stiffness on aspects of daily life, including pain and function. This spasticity measure is unique in its attempt to try to measure the patient experience of spasticity (Hobart et al. 2006); it was therefore felt important to use it in this study. However, although the measure was published in 2006, apart from the original data published by the developers, a literature search highlighted that no MS studies have yet used this measure. While using the MSSS-88 has the advantage therefore of enabling unique information to be provided in this thesis (which will enable the validity of this measure to be further explored), it has the disadvantage of providing data that it not yet able to be compared to previous work. Of note, as highlighted in appendix one, only the total stiffness measured at the ankle using motor driven perturbations correlated significantly ( $p=0.001$ ,  $r=0.44$ ) with section three of the MSSS-88. The weak correlations between the other sections of the MSSS-88 with the objective measures possibly reflects the difficulty in distinguishing between the impact of

spasticity and passive stiffness on aspects of daily life, pain, mood, social functioning from other co-existing impairments such as fatigue and weakness. Further, both the subjective reports of stiffness (for eligibility screening) and the MSSS-88 ask about the effects of global symptoms rather than focusing on one body part such as the ankle. It is interesting that the only moderately significant correlation ( $r=0.44$ ,  $p=0.001$ ) was with a subjective rating of the impact of spasms on activities of daily living such as walking and lower limb movements which the ankle plantarflexors play a critical role in.

The findings suggest the need for a more robust method of defining stiffness for the inclusion of participants into similar studies. Suggestions include using a clinical scale such as the Ashworth scale or more objective measures such as motor driven perturbations. Unlike the self-report measures, both of these assessments can specifically target the ankle plantarflexors i.e. the muscle group of interest. This does not imply that subjective reports of spasticity / spasms are not potentially useful as an outcome measure; evaluating the impact of stretching on broader aspects such as daily functioning is clearly important since this is the ultimate aim of many clinical interventions.

***Study participant numbers:***

The sample sizes in studies two and three were based on work by Yeh et al. (2007). Yeh et al (2007) found an effect size of one when comparing a constant angle and constant torque stretch. The participant numbers required were based on the assumption that a similar effect size would be seen between the different levels of applied torque in the current thesis (see Chapter four). However, there was a large variability in stiffness levels pre/post stretching among the participants in studies two and three which affected the size of effect that could be detected. For example, for the measure of total stiffness, with a sample size of 14 and a standard deviation of 0.19 (as observed in the thesis) there would need to be a 70% difference in stiffness reduction with stretching between torque conditions to reach statistical significance (power=0.85;  $\alpha=0.05$ ). In this study there was only 50% difference in stiffness change following the

high and low torque stretch; this would require a sample size of 28 to detect a significant difference. In future, larger sample sizes and /or improved screening procedures as discussed above to achieve a more homogeneous population would therefore be required.

***Clinical feasibility of the applied stretches:***

In experiment two a 30 minute stretch was chosen as previous work (eg Yeh et al 2007, Bressel et al, 2002) had indicated that significant improvements of stiffness could be achieved over this time. As the initial study aimed to explore the impact of applied torque on stiffness / ROM it was decided to use a stretch duration that had previously been shown to be effective i.e. 30 minutes. The subsequent use of a 10 minute stretch was based on the finding that during the 30 minute stretch the effects seemed to plateau around the 10 minute mark. However, in experiment one pwMS could only sustain a stretch for 118-134 seconds i.e. 2 minutes. Therefore the clinical usefulness of these more prolonged stretches could be questioned particularly if they are expected to be applied manually. Future work could therefore look at even shorter stretch periods and / or the effects of 10 minutes of cumulative stretching.

The applied torque level administered in studies two and three had to be recalculated from original values due to early participants not being able to tolerate the high force. Therefore a new high force was calculated by establishing the midpoint between the original high and medium values. It is possible that this adjustment to the torque level may have contributed to the findings regarding torque reported in chapters six, seven and eight; this may have been prevented if the stretching sessions had been broken up as mentioned above. The fact that a similar level of motor driven stretch was not as well tolerated as the self-administered stretch suggests that people may perceive the stretch related sensation differently in the two situations. This could be due to other sensations being activated in either stretch (e.g. load related receptors in the self-administered stretch) that affect peoples' perception. Another possibility is that there are differences in the person's locus of control; with the motor imposed stretch people

may be more fearful and less tolerant of higher stretch related sensations, even though they were able to stop the stretch at any time, as they are not directly applying the stretch. These potential differences between motor driven and self-administered stretches have implications for the future use of motor driven stretches as a way of investigating stretching interventions, i.e. they may not be entirely applicable to clinical situations.

***Outcome measures used:***

The studies measured passive stiffness and stretch-evoked stiffness using motor driven perturbations. This measure assesses the overall stiffness of the muscle tendon complex as well as additional structures (e.g. joint capsule) that cross the ankle joint. As discussed in chapter eight, due to difficulties maintaining ankle position during perturbations, there is the potential for some movement of the foot during the stretch. Thus, the stiffness measured during the ankle perturbations may also include a contribution of structures in the foot such as the plantar fascia.

Stretch-reflex related stiffness was measured as the difference between the total stiffness measured during a fast stretch and the passive stiffness measured during the slow stretch. This measure correlated with the size of the EMG evoked response ( $R^2=0.3-0.4$ ) as previously described (Marsden et al 2012) suggesting that it is a valid measure. However, the correlation was not perfect and errors in the estimation of limb weight / contribution of the manipulandum may have affected the results. The muscle activation will not only contribute to limb stiffness but also to the viscous, velocity dependent resistance. As measures were taken after the limb had stopped moving this viscous component was not measured. In future, assessing the effects of stretching and pathology on the viscous component would be interesting. This thesis defined spasticity as being due to an enhanced stretch reflex; this is in keeping with the definition of Lance (Lance 1980). However, other groups have suggested that spasticity is more complicated than this and potentially encompasses abnormalities, for example, in cutaneomuscular reflexes and co-contraction (Stevenson & Marsden, 2006). These

factors were not measured in the thesis and so it may be that the effects of stretching on all components/aspects of spasticity were not fully explored. This viewpoint depends on the definition of spasticity adopted.

Chapter eight addressed some of the potential difficulties with the measurement of muscle / tendon stiffness with motor driven perturbation by using ultrasonography. However, ultrasound only provided a two dimensional view of the selected ROI and this may have some influence on the findings related to the muscle-tendon aponeurosis which is a three dimensional structure. Therefore it can be concluded that all measures have some drawback and that a combined approach may be useful in future clinical trials /studies.

***Short and Long term effects of stretching:***

This thesis looked at the short term effects of stretching on stiffness and ROM. It is therefore not known if the increases in ROM and decreases in stiffness are sustained for longer than 30 minutes, if the therapeutic effects of stretching accumulate over time or if they are dose related. However, monitoring stretch-induced effects over 30 minutes post stretch provided information about the post-stretch time course. It is assumed that transient stretch mediated effects may be useful for the immediate clinical setting e.g. rehabilitation of balance and gait in the immediate post stretch period; although this has yet to be investigated in clinical studies.

It is assumed that repetitive stretches that are effective at reducing stiffness in the short term will result in long term changes in stiffness and ROM due to tissue remodeling. This would require changes in the ECM and/or length of muscle fascicles and as such a change in protein turnover. Changes in protein turnover would in turn require a change in the activity of certain genes. The signal triggering this change is assumed to be a stretch although animal work and cellular studies have not yet elucidated the pathways linking stretch to a change in gene activation.

It may be that the stretches and associated stretch evoked signal studied in the current thesis are different from those leading to long term adaptive changes. Muscles behave in a thixotropic manner in that their stiffness is dependent on movement. When stretch is applied to a relaxed muscle that has been maintained in a lengthened position the initial resistance is lower (Lakie & Robson, 1988). It is possible that the stretches led to a reduction in stiffness by affecting muscle thixotropy. As discussed in chapter two, muscle thixotropy is felt to be generated by the breaking of stable cross bridges in the muscle. If the reductions in stiffness are mainly due to this mechanism rather than an effect, for example on the ECM or muscle fascicle, it may be that it is not possible to predict the long term consequences of stretching (that may target these latter structures) by their short term effects. The optimal parameters for a short term reduction in stiffness may not necessarily be the optimal parameters that lead to a long term reduction in stiffness.

## **9.7 Future Work**

Research regarding the long term effects of stretching for the treatment of hypertonia is limited. Therefore future research should look at the effects of stretching in different patient groups over a longer term (+30 minutes/over days/weeks). However, studying the effects of different parameters of stretching, as performed here, may not be feasible in terms of time, and cost. One additional difficulty when working with pwMS is that the condition is progressive making it more difficult to study the longer term effects of stretching as it is difficult to determine whether changes are pathology related or intervention related. For longer term studies, if the aim is to assess the effects of stretching on stiffness it may be that a chronic stroke population may provide a more stable and homogeneous group.

Further work should use combined electrophysiological and biomechanical measures in order to assess the effects of different stretching regimes on the time course of hypertonia. It is also important to establish what stimulus is required for long term adaptations and whether stretching in isolation is sufficient enough or whether we need

to address co-existing weakness in this population by combining stretching with strengthening exercises. In animal models of immobilization increases in muscle atrophy go hand in hand with increases in muscle fibrosis suggesting that these two processes are linked (Williams & Goldspink 1984). Therefore it may be that both atrophy and fibrosis need to be addressed simultaneously.

This thesis has shown that both stretch duration and torque level are important considerations for increasing ankle ROM and decreasing passive stiffness. It has highlighted that it is important to determine not just the presence but also the site of any increase in passive stiffness and how this is affected by stretching. The thesis highlights that there are several methods of measuring limb stiffness and that a combined approach may be useful in future clinical trials. Therefore this thesis will help to inform the design of future clinical trials not just into the long term effects of stretching but also other physical and pharmacological interventions that target ROM and stiffness.



## 10. Bibliography

- Abbruzzese, G., 2002. The medical management of spasticity. *European Journal of Neurology*, 9, pp.30–34. Available at: <http://www.ncbi.nlm.nih.gov/pubmed/11918647>.
- Abellaneda, S., Guissard, N. & Duchateau, J., 2009. The relative lengthening of the myotendinous structures in the medial gastrocnemius during passive stretching differs among individuals. *Journal of Applied Physiology*, 106, pp.169–177.
- Alexakis, C., Partridge, T. & Bou-Gharios, G., 2007. Implication of the satellite cell in dystrophic muscle fibrosis: a self-perpetuating mechanism of collagen overproduction. *American Journal of Physiology- Cell Physiology*, 293, pp.661–669.
- Arampatiz, A. et al., 2005. Strain and elongation of the human gastrocnemius tendon and aponeurosis during maximal plantarflexion effort. *Journal of Biomechanics*, 38, pp.833–841.
- Aymard, C., Katz, R & Lafitte, C. et al, 2000. Presynaptic inhibition and homosynaptic depression: a comparison between lower and upper limbs in normal human subjects and patients with hemiplegia. *Brain*, 123, pp.1688–1702.
- Bajd, T. & Vodovnik, L., 1982. Pendulum testing for spasticity. *Journal of Biomedical Engineering*, 4, pp.91–96.
- Baker, K., Cassidy, E. & Rone-Adams, S., 2007. Therapeutic standing for people with multiple sclerosis: efficacy and feasibility. *International Journal of Therapy and Rehabilitation*, 14(3).
- Bakheit, A. et al., 2003. The relation between Asworth scale scores and the excitability of the alpha motor neurones in patients with post-stroke muscle spasticity. *Journal of Neurology Neurosurgery and Psychiatry*, 74, pp.646–648.
- Bakheit, A., McLellan, D. & Burnett, M., 1996. Symptomatic and functional improvement in foot dystonia with medical popliteal nerve block. *Clinical Rehabilitation*, 10, pp.347–349.
- Bakheit, A.M.O., Maynard, V. & Shaw, S., 2005. The effects of isotonic and isokinetic muscle stretch on the excitability of the spinal alpha motor neurones in patients with muscle spasticity. *European Journal of Neurology*, 12, pp.719–724.
- Baldissera, F., Hultborn, H. & Illert, M., 1981. *Integration in spinal neuronal systems*. In V.B. Books (ed), Baltimore: Williams and Wilkins Publishing Company.
- Bandy, W.D., Irion, J.M. & Briggler, M., 1997. The effect of time and frequency of static stretching on flexibility of the hamstring muscles. *Physical Therapy*, 77(10), pp.:1090–1096.
- Barber, L., Barrett, Rob & Lichtwark, G., 2012. Medial gastrocnemius muscle fascicle active torque-length and Achilles tendon properties in young adults with spastic cerebral palsy. *Journal of Biomechanics*, 45(15), pp.2526–2530.

- Barber, L., Barrett, Rod & Lichtwark, G., 2011. Passive muscle mechanical properties of the medial gastrocnemius in young adults with spastic cerebral palsy. *Journal of Biomechanics*, 44(13), pp.2496–2500.
- Barnes, M., 1993. Local treatment of spasticity. *Clinical Neurology*, 2, pp.55–71.
- Beard, S., Hunn, A. & Wight, J., 2003. Treatments for spasticity and pain in multiple sclerosis: a systematic review. *Health Technology Assessment*, 7(40).
- Ben, M. et al., 2005. Does 12 weeks of regular standing prevent loss of ankle mobility and bone mineral density in people with recent spinal cord injuries? *Australian Journal of Physiotherapy*, 51, pp.251–256.
- Bennett, D. et al., 2001. Evidence for plateau potentials in tail motoneurons of awake chronic spinal rats with spasticity. *Journal of Neurophysiology*, 86, pp.1972–1982.
- Bes, A. et al., 1988. A multi-centre, double-blind trial of tizanidine, a new antispastic agent, in spasticity associated with hemiplegia. *Current Medical Research and Opinion*, 10, pp.709–718.
- Biering-Sørensen, F., Nielsen, J B & Klinge, K., 2006. Spasticity-assessment: a review. *Spinal Cord*, 44(12), pp.708–22.
- Bjornson, K., Hays, R. & Graubert, C., 2007. Botulinum toxin for spasticity in children with cerebral palsy: a comprehensive evaluation. *Pediatrics*, 120, pp.49–58.
- Blalock, T. et al., 2003. Connective tissue growth factor expression and action in human corneal fibroblast cultures and rat corneas after photorefractive keratectomy. *Investigative Ophthalmology and Visual Science*, 44, pp.1879–1887.
- Bohannon, R & Larkin, P, 1985. Passive ankle dorsiflexion increases in patients after a regimen of tilt table-wedge board standing. *Physical Therapy*, 65, pp.1676–1678.
- Bohannon, R & Smith, M., 1987. Inter rater reliability of a modified Ashworth scale of muscle spasticity. *Physical Therapy*, 67, pp.206–7.
- Bohannon, Richard & Larkin, Patricia, 1985. Passive ankle dorsiflexion increases in patients after a regimen of tilt table-wedge board standing: A clinical report. *Journal of the American Physical Therapy Association*, 65, pp.1676–1678.
- Boiteau, M., Malouin, Francine & Richards, Carol L, 1995. Use of a hand-held dynamometer and a kin-coma dynamometer for evaluating spastic hypertonia in children : A Reliability Study. *Physical Therapy*, 75, pp.796–802.
- Bovend' Eerd, T. et al., 2008. The effects of stretching in spasticity: A systematic review. *Archives Physical Medicine and Rehabilitation*, 89, pp.1395–1405.
- Boyce, M., 1998. *Multiple Sclerosis*, Available at:  
<http://serendip.brynmawr.edu/bb/neuro/neuro98/202s98-paper1/Boyce.html>.
- Brashear, A. et al., 2002. Inter-and intrarater reliability of the Ashworth scale and the disability assessment scale in patients with upperlimb poststroke spasticity. *Archives Physical Medicine Rehabilitation*, 83, pp.1349–1354.

- Bischoff, R., 1994. The satellite cell and muscle regeneration. In *Myology* (Engel, A.G, & Franzini-Armstrong, C., eds) (2<sup>ND</sup> ed), New York: McGraw-Hill, pp. 97-118
- Brenner, B. et al., 1982. Evidence for cross-bridge attachment in relaxed muscle at low ionic strength. *Proceedings of the National Academy of Sciences of the United States of America*, 79(23), pp.7288–91.
- Bressel, E. & McNair, P. J., 2002. The effect of prolonged static and cyclic stretching on ankle joint stiffness, torque relaxation, and gait in people with stroke. *Physical Therapy*, 82(9), pp.880–887.
- Brinar, V., 2003. Pathophysiology of multiple sclerosis. In *43rd International Neuropsychiatric Pula Symposium*. Zagreb, pp. 1–4.
- Brown, P., 1994. Pathophysiology of spasticity. *Journal of Neurology Neurosurgery and Psychiatry*, 57, pp.773–777.
- Burgess, M., 2003. *Multiple sclerosis theory and practice for nurses*, London: Whurr Publishers Ltd.
- Cadenhead, S.L., McEwen, I.R. & David, T.M., 2002. Effect of passive range of motion exercises on lower-extremity goniometric measurements of adults with cerebral palsy : A single-subject design. *Journal of the American Physical Therapy Association*, 82, pp.658–669.
- Carey, J., 1990. Manual stretch: effect on finger movemnet control and force control in stroke subjects with spastic extrinsic finger flexor muscles. *Archives Physical Medicine Rehabilitation*, 71, pp.888–894.
- Carey, J.R. & Burghardt, T.P., 1993. Movement dysfunction following central nervous system lesions : A problem of neurologic or muscular impairment ? *Journal of American Physical Therapy Association*, 73, pp.538–547.
- Carson, M.C. et al., 2001. “Kinematic analysis of a multi-segment foot model for research and clinical applications: a repeatability analysis”. *Journal of Biomechanics*, 33, pp.1299–1307.
- Chun-Yu, Y., Jia-Jin, C. & Kuen-Horng, T., 2006. Quantifying the effectiveness of the sustained muscle stretching treatments in stroke patients with ankle hypertonia. *Journal of Electromyography and Kinesiology*, 17, pp.453–461.
- Chung, S G et al., 2005. Changes of reflex, non-reflex and torque generation properties of spastic ankle plantar flexors induced by intelligent stretching. *Engineering in Medicine and Biology Society*, 4, pp.3672–3675.
- Chung, S. G. et al., 2005. Changes of reflex, non-reflex and torque generation properties of spastic ankle plantar flexors induced by intelligent stretching. *Engineering in Medicine and Biology*, 1-4, pp.3672–3675.
- Conway, B., Hultborn, H. & Kiehn, O., 1987. Proprioceptive input resets central locomotor rhythm in the spinal cat. *Experimental Brain Research*, 68(3), pp.643–656.

- Corry, I., Cosgrove, A. & Duffy, C., 1998. Botulinum toxin A compared with stretching casts in the treatment of spastic equinus: a randomised prospective trial. *Journal of Pediatric Orthopaedics*, 18, pp.304–311.
- Coward, D., 1994. Tizanidine: neuropharmacology and mechanism of action. *Neurology*, 44, pp.s6–s10.
- Crone, C. et al., 2006. Appearance of reciprocal facilitation of ankle extensors from ankle flexors in patients with stroke or spinal cord injury. *Brain*, 126, pp.495–507.
- Crone, C. et al., 1994. Disynaptic reciprocal inhibition of ankle extensors in spastic patients. *Brain*, 117, pp.1161–1168.
- Cumming, G., 2012. *Understanding the new statistics: effects sizes, confidence intervals and meta-analysis*, New York: Routledge.
- Cutter, N. et al., 2000. Gabapentin effect on spasticity in multiple sclerosis: a placebo-controlled, randomized trial. *Archives Physical Medicine Rehabilitation*, 81, pp.164–169.
- Delwaide, P. & Olivier, E., 1988. Short-latency autogenic inhibition (I<sub>B</sub>inhibition) in human spasticity. *Journal of Neurology Neurosurgery and Psychiatry*, 51, pp.1546–1550.
- Dietz, V. & Sinkjaer, T., 2007. Spastic movement disorder: impaired reflex function and altered muscle mechanics. *Lancet Neurology*, 6, pp.725–33.
- Dilley, A. et al., 2001. The use of cross-correlation analysis between high-frequency ultrasound images to measure longitudinal median nerve movement. *Ultrasound in Medicine and Biology*, 27(9), pp.1211–1218.
- Downs, S.H. & Black, N., 1998. The feasibility of creating a checklist for the assessment of the methodological quality both of randomised and non-randomised studies of health care interventions. *Journal of Epidemiology and Community Health*, 52(6), pp.377–84.
- Edwards, S. & Charlton, P., 2002. Splinting and the use of orthoses in the management of patients with neurological disorders. In S. Edwards, ed. *Neurological Physiotherapy: A Problem Solving Approach*. Edinburgh: Churchill Livingstone, pp. 219–253.
- Eklund, G. & Hagbarth, K.E., 1966. Normal variability of tonic vibration reflexes in man. *Experimental Neurology*, 16(1), pp.80-92
- Engle, H., 1966. The effects of diazepam (Valium) in children with cerebral palsy: a double-blind study. *Developmental Medicine and Child Neurology*, 8, pp.661–667.
- Engsberg, J. et al., 1996. Quantitative clinical measure of spasticity in children with cerebral palsy. *Archives Physical Medicine Rehabilitation*, 77, pp.594–599.
- Farrell, M. & Richards, J., 1986. Analysis of the reliability and validity of the kinetic communicator exercise device. *Medicine and Science in Sport and Exercise*, 18, pp.44–49.

- Feland, J.B., Myrer, J.W. & Merrill, R.M., 2001. Acute changes in hamstring  $\bar{\tau}$  exibility : PNF versus static stretch in senior athletes. *Physical Therapy in Sport*, 2(4), pp.186–193.
- Filipetti, P. & Decq, P., 2003. [Interest of anesthetic blocks for assessment of the spastic patient. A series of 815 motor blocks]. *Neurochirurgie*, 49, pp.226–238.
- Foran, J.R.H. et al., 2005. Review Structural and mechanical alterations in spastic skeletal muscle. *Developmental Medicine and Child Neurology*, 47, pp.713–717.
- Friden, J. & Lieber, R., 2003. Spastic muscle cells shorter and stiff than normal cells. *Muscle and Nerve*, 27(2), pp.157-164.
- Fowles, J.R., Sale, D.G. & MacDougall, J.D., 2000. Reduced strength after passive stretch of the human plantarflexors. *Journal of Applied Physiology*, 89(3), pp.1179–1188.
- Frerebeau, P. et al., 2003. [Percutaneous sacral thermorhizotomy to treat equinism of spastic cerebral palsy children]. *Neurochirurgie*, 49, pp.306–311.
- Fukuda, N.F. et al., 2008. Physiological functions of the giant elastic protein titin in mammalian striated muscle. *Journal of Physiological Science*, 58(3), pp.151–159.
- Fukuda, N. et al., 1998. Regulatory roles of MgADP and calcium in tension development of skinned cardiac muscle. *Journal of Muscle Research and Cell Motility*, 19, pp.909-921.
- Fukunaga, T. et al., 1996. Tendinous movement of a human muscle during voluntary contractions determined by real-time ultrasonography. *Journal of Applied Physiology*, 81, pp.1430–1433.
- Gajdosik, R., 2001. Passive extensibility of skeletal muscle: review of the literature with clinical implications. *Clinical Biomechanics*, 16, pp.87–101.
- Gajdosik, R.L., 2002. "Relationship between passive properties of the calf muscles and plantarflexion concentric isokinetic torque characteristics". *European Journal of Applied Physiology*, 87(3), pp.220–227.
- Gao, F. et al., 2011. Effects of repeated ankle stretching on calf muscle – tendon and ankle biomechanical properties in stroke survivors. *Clinical Biomechanics*, 26, pp.516–522.
- Gao, F. & Zhang, L.-Q., 2008. Altered contractile properties of the gastrocnemius muscle poststroke. *Journal of Applied Physiology (Bethesda, Md. : 1985)*, 105(6), pp.1802–8.
- Gao, F., Y. & Ren, et al, 2011. Effects of repeated ankle stretching on calf muscle–tendon and ankle biomechanical properties in stroke survivors. *Clinical Biomechanics*, pp.1–7.
- Gillies, A.R. et al., 2011. Method for decellularizing skeletal muscle without detergents or proteolytic enzymes. *Tissue Engineering Part C Methods*, 17, pp.383–389.

- Gillies, A.R. & Lieber, Richard L, 2011. Structure and function of the skeletal muscle. *Muscle & Nerve*, 44, pp.318–331.
- Glass, D.J., 2005. Skeletal muscle hypertrophy and atrophy signaling pathways. *The International Journal of Biochemistry and Cell Biology*, 37, pp. 1974-1984.
- Goodin, D., 1998. A questionnaire to assess neurological impairment in multiple sclerosis. *Multiple Sclerosis*, 4(2), pp.444–451.
- Gorter, J.W. et al., 2007. “To stretch or not to stretch in children with cerebral palsy”. *Developmental Medicine and Child Neurology*, 49(10), pp.797–800; author reply 799.
- Gracies, Jean-michel, 2005. Pathophysiology of spastic paraesis II: Emergence of muscle overactivity. *Muscle & Nerve*, 31(5), pp.552–571.
- Gracies, JM et al., 1997. Traditional pharmacological treatments for spasticity. Part 1: Local treatments. *Muscle & Nerve*, 20, pp.s61–s91.
- Granzier, H., 2007. Structure-function relations of the giant elastic protein titin in striated and smooth muscle cells. *Muscle & Nerve*, 36, pp.740–755.
- Greenberg, H. et al., 1994. Short-term effects of smoking marijuana on balance in patients with multiple sclerosis and normal volunteers. *Clinical Pharmacology Therapy*, 55, pp.324–328.
- Gunn, H. et al., 2013. Risk factors for falls in multiple sclerosis: an observational study. *Multiple Sclerosis*, 1352458513488233
- Haas, B.M. et al., 1996. The inter rater reliability of the original and of the modified Ashworth scale for the assessment of spasticity in patients with spinal cord injury. *Spinal Cord*, 34, pp.560–564.
- Hagbarth, K. et al., 1985. Thixotropic behaviour of human finger flexor muscles with accompanying changes in spindle and reflex responses to stretch. *Journal of Physiology*, 368, pp.323–342.
- Hall, J. et al., 2010. 'Factors influencing the applied torque during manually applied plantarflexor stretches in people with multiple sclerosis. In *Chartered society of physiotherapy (CSP) Congress*. Liverpool, 15-16 October 2010 (UK ): Chartered Society of Physiotherapy.
- Harlaar, J. et al., 2000. Passive stiffness characteristics of ankle plantar flexors in hemiplegia. *Clinical Biomechanics (Bristol, Avon)*, 15(4), pp.261–270.
- Harvey, L.A. et al., 2000. A randomized trial assessing the effects of 4 weeks of daily stretching on ankle mobility in patients with spinal cord injuries. *Archives of Physical Medicine and Rehabilitation*, 81, pp.1340–1347.
- Harvey, L.A. et al., 2009. Effects of 6 months of regular passive movements on ankle joint mobility in people with spinal cord injury: A randomised controlled trial. *Spinal Cord*, 47, pp.62–66.

- Harvey, L.A. et al., 2003. Randomised trial of the effects of four weeks of daily stretch on extensibility of hamstring muscles in people with spinal cord injuries. *Australian Journal of Physiotherapy*, 49, pp.176–181.
- Harvey, R. & Ferrier, D., 2011. *Biochemistry* 5th ed. R. Harvey, ed., Baltimore: Lippincott Williams and Wilkins.
- Hass, B. & Crow, J., 1995. Towards a clinical measurement of spasticity? *Physiotherapy*, 81(8), pp.474–479.
- He, J. & Norling, W., 1997. A dynamic neuromuscular model for describing the pendulum test for spasticity. *IEEE Transactions on Biomedical Engineering*, 44, pp.175–183.
- Helsinki, 1996. *World medical association declaration of helsinki*, Available at: [http://www.jcto.co.uk/Documents/Training/Declaration\\_of\\_Helsinki\\_1996\\_version.pdf](http://www.jcto.co.uk/Documents/Training/Declaration_of_Helsinki_1996_version.pdf).
- Herbert, R & Balnave, R., 1993. The effect of position of immobilisation on resting length, resting stiffness, and weight of the soleus muscle of the rabbit. *Journal Of Orthopaedic Research*, 11, pp.358–366.
- Herbert, Robert, 1988. The passive mechanical properties of muscle.pdf. *The Australian Journal of Physiotherapy*, 34(3), pp.141–149.
- Herbert, Robert D et al., 2011. In vivo passive mechanical behaviour of muscle fascicles and tendons in human gastrocnemius muscle-tendon units. *The Journal Of Physiology*, 589(Pt 21), pp.5257–5267.
- Herndon, R.M., 2003. *Multiple sclerosis: immunology, pathology, and pathophysiology*, New York: Demos Medical Publishing.
- Higgins, J. & Green, S., 2009. *Cochrane handbook for systematic reviews of interventions version 5.0.2* J. Higgins & S. Green, eds., The Cochrane Collaboration.
- Hinson, J. & Boone, T., 1996. Urodynamics and multiple sclerosis. *Urologic Clinics of North America*, 23, pp.475–481.
- Hoang, P. et al., 2009. Passive mechanical properties of gastrocnemius in people with multiple sclerosis. *Clinical Biomechanics*, 24(3), p.291.
- Hoang, P.D., 2009. *Practice Spasticity and multiple sclerosis ( MS )*, Australia.
- Hobart, J C et al., 2006. Getting the measure of spasticity in multiple sclerosis: the Multiple Sclerosis Spasticity Scale (MSSS-88). *Brain*, 129, pp.224–234.
- Hobart, J. C. et al., 2003. Measuring the impact of MS on walking ability: The 12-item MS walking scale. *Neurology*, 60(1), pp.444–451.
- Hodgkinson, I. et al., 1997. Selective dorsal rhizotomy in children with cerebral palsy. Results in 18 cases at one year postoperatively. *Stereotactic and Functional Neurosurgery*, 69, pp.259–267.

- Hultborn, H. et al., 2003. Variable amplification of synaptic input to cat spinal motoneurons by dendritic persistent inward currents. *Journal of Physiology*, 552, pp.945–952.
- Huxley, A., 1957. Muscle structure and theories of contraction. *Biophysics and Biophysical Chemistry*, 7, pp.255–318.
- Johnson, G. & Pandyan, A., 2008. The measurement of spasticity. In M. Barnes & G. Johnson, eds. *Upper motor neurone syndrome and spasticity*. Cambridge: Cambridge University Press, pp. 64–78.
- Katalinic, O.M., Harvey, L.A. & Herbert, Robert D, 2012. Effectiveness of stretch for the treatment and prevention of contractures in people With neurological conditions : A systematic review. *Physical Therapy*, 91(1), pp.11–24.
- Katz, R, 1994. Electrophysiologic assessment of spastic hypertonia. *Physical Medicine and Rehabilitation*, 8, pp.465–471.
- Katz, R et al., 1992. Objective quantification of spastic hypertonia. *Archives of Medicine and Rehabilitation*, 73, pp.339–347.
- Katz, R & Rymer, W., 1989. Spastic hypertonia. Correlation with clinical findings. *Archives Physical Medicine Rehabilitation*, 70, pp.144–155.
- Killestein, J. & Hoogervorst, E. et al, 2002. Safety, tolerability and efficacy of orally administered cannabinoids in multiple sclerosis. *Neurology*, 58, pp.1404–1407.
- Kjaer, M., 2004. Role of extracellular matrix in adaptation of tendon and skeletal muscle to mechanical loading. *Physiological Reviews*, 84, pp.649–698.
- Kubo, K. et al., 2000. Changes in the elastic properties of tendon structures following 20 days bed rest in humans. *European Journal of Applied Physiology*, 83(6), pp.463–468.
- Kubo, K., Kanehisa, H. & Fukunaga, T., 2002. Effects of transient muscle contractions and stretching on the tendon structures in vivo. *Acta Physiol Scand*, 175(2), pp.157–164.
- Kunkel, C. et al., 1993. Effect of “standing” on spasticity, contracture, and osteoporosis in paralyzed males. *Archives of Medicine and Rehabilitation*, 74, pp.73–78.
- Kwah, L.K. et al., 2012. Passive mechanical properties of gastrocnemius muscles of people with ankle contracture after stroke. *Archives of Physical Medicine and Rehabilitation*, 93(7), pp.1185–90.
- Labeit, S. et al., 1992. Towards a molecular understanding of titin. *European Molecular Biology Organization Journal*, 11, pp.1711-1716.
- Lamontagne, A. et al., 2002. Mechanisms of disturbed motor control in ankle weakness during gait after stroke. *Gait & posture*, 15(3), pp.244–55.
- Lamy, J.-C. et al., 2009. Impaired efficacy of spinal presynaptic mechanisms in spastic stroke patients. *Brain*, 132, pp.734–48. Available at: <http://www.ncbi.nlm.nih.gov/pubmed/19036767> [Accessed March 8, 2012].



- Lance, J., 1980. No Title. In R. Feldman, R. Young, & W. Koella, eds. *Spasticity: Disordered Motor Control*. Chicago: IL: Year Book Symposia Specialists, pp. 485–494.
- Leslie, G. et al., 1992. A comparison of the assessment of spasticity by the Wartenberg pendulum test and the Ashworth grading scale in patients with multiple sclerosis. *Clinical Rehabilitation*, 6, pp.41–48.
- De Leva, P., 1996. Adjustments to Zatsorsky-Seluyanov's segmental inertial parameters. *Journal of Biomechanics*, 29, pp.1223–1230.
- Lieber, R.L., Friden, J., 2002. Spasticity causes a fundamental rearrangement of muscle-joint interaction. *Muscle and Nerve*, 25, pp. 265-270.
- Li, Y. & Bennett, D., 2003. Persistent sodium and calcium currents cause plateau potentials in motoneurons of chronic spinal rats. *Journal of Neurophysiology*, 90, pp.857–869.
- Lichtwark, G. a, Bougoulas, K. & Wilson, a M., 2007. Muscle fascicle and series elastic element length changes along the length of the human gastrocnemius during walking and running. *Journal of Biomechanics*, 40(1), pp.157–64.
- Lieber, R L et al., 2004. Structure and functional changes in spastic skeletal muscle. *Muscle & Nerve*, 29(May), pp.615–627.
- Lieber, Richard & Friden, Jan, 2001. Clinical significance of skeletal muscle architecture. *Clinical Orthopaedics & Related Research*, 838, pp.140–151.
- Lieber, Richard L, Ponten, E. & Friden, J, 1996. Sarcomere length changes after flexor carpi ulnaris-to-ectensor digitorum communis tendon transfer. *The Journal of Hand Surgery*, 21A, pp.612–618.
- Lockley, L. & Buchanan, K., 2006. Physical management of spasticity. In V. L. Stevenson & L. Jarrett, eds. *Spasticity Management: A Practical Multidisciplinary Guide*. Oxon: Informa Healthcare, pp. 37–58.
- Loram, I., Maganaris, C. & Lakie, M., 2006. Use of ultrasound to make noninvasive in vivo measurement of continuous changes in human muscle contractile length. *Journal of Applied Physiology*, 100(4), pp.1311–1323.
- Lorentzen, J. et al., 2010. Distinguishing active from passive components of ankle plantar flexor stiffness in stroke, spinal cord injury and multiple sclerosis. *Clinical Neurophysiology*, 121, pp.1939–1951.
- Maganaris, C. & Paul, J.P., 2002. Tensile properties of the in vivo human gastrocnemius tendon. *Journal of Biomechanics*, 35(12), pp.1639–1646.
- Magnusson, S.P. et al., 1998. A biomechanical evaluation of cyclic and static stretch in human skeletal muscle. *Int J Sports Med*, 19(5), pp.310–316.
- Magnusson, S.P. et al., 1996. Viscoelastic stress relaxation during static stretch in human skeletal muscle in the absence of EMG activity. *Scandinavian Journal of Medicine and Science in Sport*, 6, pp.323–328.

- Marsden, J. & Stevenson, V., 2013. Balance dysfunction in hereditary and spontaneous spastic paraparesis. *Gait and Posture*, pp. 1-3.
- Marsden, J et al., 2012. Muscle paresis and passive stiffness: key determinants in limiting function in hereditary and sporadic spastic paraparesis. *Gait and Posture*, 35(2), pp.266–271.
- Marsden, Jonathan et al., 2012. The effects of functional electrical stimulation on walking in hereditary and spontaneous spastic paraparesis. *Neuromodulation: Technology at the Neural Interface*, pp.1–6.
- Matthews, W. et al., 1991. *McAlpine's Multiple Sclerosis* 2nd ed. W. Matthews, ed., London: Churchill Livingstone.
- McPherron, A.C. et al., 1997. Regulation of skeletal muscle mass in mice by a new TGF-beta superfamily member. *Nature*, 387, pp.83-90
- Mohagheghi, A.A. et al., 2007. Differences in gastrocnemius muscle architecture between the paretic and non-paretic legs in children with hemiplegic cerebral palsy. *Clinical biomechanics (Bristol, Avon)*, 22(6), pp.718–24.
- Morris, S., 2002. Ashworth and tardieu scales: their clinical relevance for measuring spasticity in adult and paediatric neurological populations. *Physical Therapy Reviews*, 7, pp.53–62.
- Morse, C. et al., 2008. The acute effect of stretching on the passive stiffness of the human gastrocnemius muscle tendon unit. *The Journal of Physiology*, 586(1), pp.97–106.
- Mortenson, P. & Eng, J., 2003. The use of casts in the management of joint mobility and hypertonia following brain injury in adults: a systematic review. *Physical Therapy*, 83, pp.648–658.
- Naderi, J. et al., 2009. Plasminogen activator inhibitor type 1 up-regulation is associated with skeletal muscle atrophy and associated fibrosis. *The American Journal of Pathology*, 175(2), pp.763-771.
- Nakamura, M. et al., 2011. Acute and prolonged effect of static stretching on the passive stiffness of the human gastrocnemius muscle tendon unit in vivo. *Journal Of Orthopaedic Research: Official Publication Of The Orthopaedic Research Society*, 29(11), pp.1759–1763.
- Nickolls, P. et al., 2004. Forces consistent with plateau-like behaviour of spinal neurons evoked in patients with spinal cord injuries. *Brain*, 127, pp.660–70.
- Nielsen, JB B, Crone, C. & Hultborn, H., 2007. The spinal pathophysiology of spasticity- from a basic science point of view. *Acta Physiologica*, 189, pp.171–180.
- Nordez, A. et al., 2009. Improvements to Hoang et al.'s method for measuring passive length-tension properties of human gastrocnemius muscle in vivo. *Journal of Biomechanics*.
- Nuyens, G, DeWeerd, W. & Ketelaer, P. et al, 1994. Inter rater reliability of the Ashworth scale in multiple sclerosis. *Clinical Rehabilitation*, 8, pp.286–292.

- Nuyens, Godelieve et al., 2002. Reduction of spastic hypertonia during repeated passive knee movements in stroke patients. *Archives of Medicine and Rehabilitation*, 83, pp.930–935.
- Nuyens, Godelieve et al., 2001. Torque variations during repeated passive isokinetic knee movements in persons with multiple sclerosis. *Journal of Rehabilitation and Medicine*, 33, pp.85–89. Odeen, I & Knutsson, E., 1981. Evaluation of the effects of muscle stretch and weight load in patients with spastic paraplegia. *Scandinavian Journal of Rehabilitation Medicine*, 13, pp.117–121.
- Odeen, Ingrid, 1981. Reduction of muscular hypertonus by long-term muscle stretch. *Scandinavian Journal of Rehabilitation Medicine*, 13, pp.93–99.
- Odeen, Ingrid & Knutsson, E., 1981. Evaluation of the effects of muscle stretch and weight load in patients with spastic paraplegia. *Scandinavian Journal of Rehabilitation Medicine*, 13, pp.117–121.
- Okotie, G. et al., 2012. Tendon strain measurements with dynamic ultrasound images: evaluation of digital image correlation. *Journal Of Biomechanical Engineering*, 134(2), p.24504.
- Olsson, M.C. et al., 2006. Fibre type-specific increase in passive muscle tension in spinal cord-injured subjects with spasticity. *Journal of Physiology*, 577(1), pp.339–352.
- Pandyan, A et al., 2001. Biomechanical examination of a commonly used measure of spasticity. *Clinical Biomechanics*, 16, pp.859–865.
- Pandyan, A, Price, C. & Curless, R. et al, 1999. A review of the properties and limitations of the Ashworth and modified Ashworth scales as measures of spasticity. *Clinical Rehabilitation*, 13, pp.337–383.
- Partridge, C., 2002. Early rehabilitation of a stroke patient. In C. Partridge, ed. *Neurological Physiotherapy: Bases of evidence for practice*. London: Whurr Publishers Ltd, pp. 7–23.
- Passerieux, E. et al., 2006. Structural organisation of the perimysium in bovine skeletal muscle: junctional plates and associated intracellular subdomains. *Journal of Structural Biology*, 154, pp.206–216.
- Petro, D. & Ellenberger, C., 1981. Treatment of human spasticity with delta a-tetrahydrocannabinol. *Journal of Clinical Pharmacology*, 21, pp.4135–4165.
- Pierrot-Deseilligny, E. & Brussel, B., 1975. Evidence for recurrent inhibition by motoneurons in human subjects. *Brain*, 88(105-108).
- Pierrot-Deseilligny, E. & Burke, D, 2005. *The circuitry of the human spinal cord: Its role in motor control and movement disorders*, Cambridge: Cambridge University Press.
- Pinder, R. et al., 1977. Dantrolene sodium: a review of its pharmacological properties and therapeutic efficacy in spasticity. *Drugs*, 13, pp.3–23.
- Price, R. et al., 1991. Quantitative measurement of spasticity in children with cerebral palsy. *Developmental Medicine and Child Neurology*, 33(7), pp.585–595.

- Proske, U. & Morgan, D.L., 1999. Do cross-bridges contribute to the tension during stretch of passive muscle? *Journal of Muscle Research and Cell Motility*, 20, pp.433–442.
- van der Putten, J.J. et al., 1999. Measuring change in disability after inpatient rehabilitation: comparison of the responsiveness of the Barthel index and the Functional Independence Measure. *Journal of neurology, neurosurgery, and psychiatry*, 66, pp.480–484.
- Rebbapragada, A. et al., 2003. Myostatin signals through a transforming growth factor b -like signaling pathway to block adipogenesis. *Molecular Cellular Biology*, 23, pp.7230-7242
- Roncaroli, F., 2005. Neuropathology of multiple sclerosis. *Advances in Clinical Neuroscience and Rehabilitation*, 5(2), pp.16–22.
- Rothwell, J., 1994. Investigating reflex pathways and their function. In *Control of Human Voluntary Movement*. London: Chapman & Hall, pp. 153–212.
- Ryan, E.D. et al., 2008. The time course of musculotendinous stiffness responses following different durations of passive stretching. *Journal of Orthopedics and Sports Physical Therapy*, 38(10), pp.632–639.
- Schmit, B., Dewald, J. & Rymer, W., 2000. Stretch reflex adaptation in elbow flexors during repeated passive movements in unilateral brain-injured patients. *Archives Physical Medicine Rehabilitation*, 81, pp.269–278.
- Scholtes, V. et al., 2006. Clinical assessment of spasticity in children with cerebral palsy: a critical review of available instruments. *Developmental Medicine and Child Neurology*, 48, pp.64–73.
- Schuelke, M. et al., 2004. Myostatin mutation associated with gross muscle hypertrophy in a child. *New England Journal of Medicine*, 350, pp. 2682-2688
- Sehgal, N. & McGuire, J., 1998. Beyond Ashworth. Electrophysiologic quantification of spasticity. *Physical Medicine and Rehabilitation Clinics of North America*, 9, pp.949–979.
- Selles, R. et al., 2005. Feedback-controlled and programmed stretching of the ankle plantarflexors and dorsiflexors in stroke: Effects of a 4-week intervention program. *Archives of Physical Medicine and Rehabilitation*, 86, pp.2330–2336.
- Shortland, A. et al., 2002. Architecture of the medial gastrocnemius in children with spastic diplegia. *Developmental Medicine and Child Neurology*, 44(158-163).
- Singer, B.J., Dunne, J.W. & Singer, K.P., 2008. The short term effect of cyclic passive stretching on plantarflexor resistive torque after acquired brain injury. *Clinical Biomechanics*, 23, pp.1178–1182.
- Sloan, R. et al., 1992. Interrater reliability of the modified Ashworth scale for spasticity in hemiplegic patients. *International Journal of Rehabilitation Research*, 15, pp.158–161.

- Stephens, M.J. & Yang, J.F., 1996. Short latency, non-reciprocal group I inhibition is reduced during the stance phase of walking in humans. *Brain*, 743(1-2), pp.24–31.
- Stevenson, V.L., 2006a. Focal treatments, including botulinum toxin. In V. L. Stevenson & L. Jarrett, eds. *Spasticity Management: A Practical Multidisciplinary Guide*. Oxon: Informa Healthcare, pp. 71–83.
- Stevenson, V.L., 2006b. Oral medication. In V. L. Stevenson & Louise Jarrett, eds. *Spasticity Management: A Practical Multidisciplinary Guide*. Oxon: Informa Healthcare, pp. 59–70.
- Stevenson, V.L. & Marsden, Jonathan, 2006. N. In VL Stevenson & L Jarrett, eds. *Spasticity Management: A Practical Multidisciplinary Guide*. Oxon: Informa Healthcare, pp. 3–14.
- Sugisaki, N. et al., 2011. Effect of muscle contraction levels on the force-length relationship of the human Achilles tendon during lengthening of the triceps surae muscle-tendon unit. *Journal of Biomechanics*, 44(11), pp.2168–2171.
- Tardieu, C. et al., 1988. For how long must the soleus muscle be stretched each day to prevent contracture? *Developmental Medicine and Child Neurology*, 30, pp.3–10.
- Thilmann, A.F., Fellows, S.J. & Ross, H.F., 1991. Biomechanical changes at the ankle joint after stroke. *Journal of Neurology, Neurosurgery and Psychiatry*, 54, pp.134–139.
- Thompson, A.J. et al., 2005. Clinical management of spasticity. *Journal of neurology, neurosurgery, and psychiatry*, 76, pp.459–63.
- Thompson, A.J. & Baker, D., 2002. Cannabinoids in multiple sclerosis: potentially useful but not just yet! *Neurology*, 58, pp.1323–1324.
- Thornton, H. & Kilbride, C., 2004. Physical management of abnormal tone and movement. In M. Stokes, ed. *Physical Management in Neurological Rehabilitation*. London: Elsevier Mosby, pp. 431–450.
- Tremblay, F. et al., 1990. Effects of prolonged muscle stretch on reflex and voluntary muscle activations in children with spastic cerebral palsy. *Scandinavian Journal of Rehabilitation Medicine*, 22, pp.171–180.
- Tsai, K. et al., 2001. Effects of a single session of prolonged muscle stretch on spastic muscle of stroke patients. *Proceedings of the National Science Council Republic of China B*, 25, pp.76–81.
- Tseng, C.-N. et al., 2006. Effects of a range-of-motion exercise programme. *Journal of Advanced Nursing*, 57(2), pp.181–191.
- Udaka, J. et al., 2008. Disuse-induced preferential loss of the giant protein titin depresses muscle performance via abnormal sarcomeric organization. *The Journal of general physiology*, 131(1), pp.33–41.

- Ungerleider, J. et al., 1987. Delta 9 THG in the treatment of spasticity associated with multiple sclerosis. *Advances in Alcohol and Substance Abuse*, 7, pp.39–50.
- Van der Ven, P.F. et al., 2000. A functional knock out of titin results in defective myofibril assembly. *Journal of Cell Science*, 113, pp.1405-1414.
- Verrier, M., Ashby, P. & MacLeod, S., 1977. Diazepam effects on reflex activity in patients with complete spinal lesions and in those with other causes of spasticity. *Archives Physical Medicine Rehabilitation*, 58, pp.148–153.
- Wagner, K.R. et al., 2005. Muscle regeneration in the prolonged absence of myostatin. *Proceeding of the National Academy and Science*, 102, pp.2519-2524.
- Wang, D. & Bakhai, A., 2006. *Clinical trials: a practical guide to design, analysis and reporting* D. Wang & A. Bakhai, eds., London UK: Remedica.
- Wang, K. et al., 1993. Viscoelasticity of the sarcomere matrix of skeletal muscles and the titin-myosin composite filament is a dual-stage molecular spring. *Biophysical Journal*, 64, pp. 1161–1177.
- Ward, A., 2002. A summary of spasticity management--a treatment algorithm. *European journal of neurology*, 9, pp.48–52.
- Wartenberg, R., 1951. Pendulousness of the legs as a diagnostic test. *Neurology*, 1, pp.18–24.
- Weiner, H. & Seikoe, D., 2002. Inflammation and therapeutic vaccination in central nervous system diseases. *Nature*, 420, pp.879–884.
- Weppler, C., 2011. 'On " Effectiveness of stretch for the treatment and prevention of contractures in people with neurological conditions"'. *Physical Therapy*, 91(4), pp.590–595.
- Williams, P.E., 1990. Use of intermittent stretch in the prevention of serial sarcomere loss in immobilised muscle. *Annals of the Rheumatic Diseases*, 49(5), pp.316–7.
- Williams, P.E. & Goldspink, G., 1984. Connective tissue changes in immobilised muscle. *Journal of Anatomy*, 138(2), pp.343–350.
- Winters, T. et al., 2009. *Nonlinear scaling of passive tension in skeletal muscle.*, California.
- Wood, D. et al., 2005. Biomechanical approaches applied to the lower and upper limb for the measurement of spasticity: a systematic review of the literature. *Disability and Rehabilitation*, 7-21(27(1-2)), pp.19–32.
- Wu, C.-L. et al., 2006. Effect on spasticity after performance of dynamic-repeated-passive ankle joint motion exercise in chronic stroke patients. *The Kaohsiung Journal of Medical Sciences*, 22, pp.610–617.
- Wu, Y et al., 2000. Changes in titin and collagen underlie diastolic stiffness diversity of cardiac muscle. *Journal of Molecular and Cellular Cardiology*, 32, pp.1027–1044.

- Wu, Y. et al., 2002. Changes in titin isoform expression in pacing-induced cardiac failure give rise to increased passive muscle stiffness. *Circulation*, 106(11), pp.1384–1389.
- Wu, Y.-N. et al., 2011. Combined passive stretching and active movement rehabilitation of lower-limb impairments in children with cerebral palsy using a portable robot. *Neurorehabilitation and Neural Repair*, 25, pp.378–385.
- Yeh, C.-Y., Chen, J.-J.J. & Tsai, K.-H., 2004. Quantitative analysis of ankle hypertonia after prolonged stretch in subjects with stroke. *Journal of Neuroscience Methods*, 137, pp.305–14.
- Yeh, Chun-yu, Chen, J.-J. & Tsai, K.-H., 2007. Quantifying the effectiveness of the sustained muscle stretching treatments in stroke patients with ankle hypertonia. *Journal of Electromyography and Kinesiology*, 17, pp.453–461.
- Yeh, Chun-yu, Tsai, K.-H. & Chen, J.-J., 2005. Effects of prolonged muscle stretching with constant torque or constant angle on hypertonic calf muscles. *Archives of Physical Medicine and Rehabilitation*, 86, pp.235–241.
- Yuktasir, B. & Kaya, F., 2009. Investigation into the long-term effects of static and PNF stretching exercises on range of motion and jump performance. *J Bodyw Mov Ther*, 13(1), pp.11–21.
- Zajicek, John P et al., 2010. Patient-orientated longitudinal study of multiple sclerosis in south west England (The South West Impact of Multiple Sclerosis Project, SWIMS) 1: protocol and baseline characteristics of cohort. *BMC Neurology*, 10(1), p.88.
- Zajicet, J. et al., 2003. Cannabinoids for treatment of spasticity and other symptoms related to multiple sclerosis (CAMS study):multicentre randomised placebo-controlled trial. *The Lancet*, 362, pp.1517–1526.
- Zhang, L. et al., 2002. Intelligent stretching of ankle joints with contracture/spasticity. *IEEE Transactions on Neural Systems and Rehabilitation Engineering*, 10(3), pp.149–157.
- Zhao, H. et al., 2011. Changes of calf muscle-tendon biomechanical properties induced by passive-stretching and active-movement training in children with cerebral palsy. *Journal Of Applied Physiology (Bethesda, Md.: 1985)*, 111(2), pp.435–442.
- Zhao, H., Ren, Y., Wu, Y.-N., et al., 2009. Ultrasonic evaluations of Achilles tendon mechanical properties poststroke. *Journal Of Applied Physiology (Bethesda, Md.: 1985)*, 106(3), pp.843–849.
- Zhoa, H. et al., 2008. Ultrasonic evaluation of Achilles tendon mechanical properties poststroke. *Journal of Applied Physiology*, 106, pp. 843-849.
- Zhao, H., Ren, Y., Wu, Yi-ning, et al., 2009. Ultrasonic evaluations of Achilles tendon mechanical properties poststroke Ultrasonic evaluations of Achilles tendon mechanical properties poststroke. *Journal of Applied Physiology*, 106, pp.843–849.

## 11. Appendix 1

### Comparison of MSSS88 with biomechanical measures of stiffness

The relationship between sections 1-8 of the MSSS88 were compared with biomechanical measures of total stiffness, passive stiffness and stretch reflex related stiffness for all participants who took part in study 1-3. All the participants had a progressive condition and each experiment was conducted months apart; therefore, each subject who participated in all three experiments was considered as a separate entry.

Comparisons were determined using a Pearson's rank correlation; a Bonferroni correction was made to account for the multiple comparisons ( $n=24$  significance taken  $P < 0.05/24 = 0.0021$ ). Therefore, a  $p$  value  $\leq 0.0019$  was considered as a significant relationship (see Table A1).

### Results

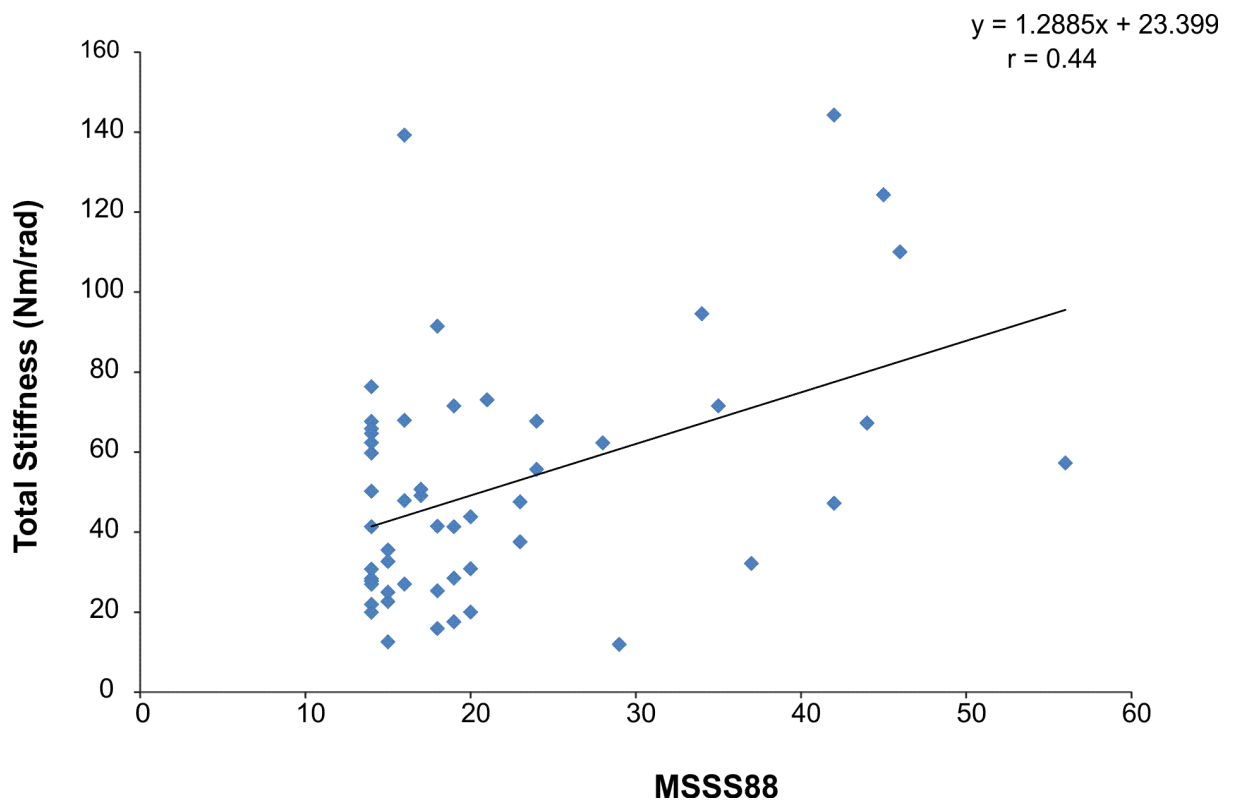
Section three of the MSSS88, looks at the effect of muscle spasm on daily activities and limb movements; when compared with total stiffness which encompasses passive and stretch reflex stiffness elements, a statistical significance was observed and demonstrated a moderate correlation ( $r=0.44$ ). This indicated that participants who scored lower on section three of the MSSS88 tended to have lower total stiffness values (see Figure A1).



MS88 Sections	Total Stiffness		Passive Stiffness		Stretch Reflex Mediated Stiffness	
	r	p	r	p	r	p
<b>Section 1</b>	0.34	0.01	0.22	0.10	0.28	0.04
<b>Section 2</b>	0.38	0.01	0.32	0.02	0.20	0.17
<b>Section 3</b>	0.44	0.001*	0.28	0.04	0.39	0.004
<b>Section 4</b>	0.31	0.02	0.26	0.06	0.17	0.24
<b>Section 5</b>	0.22	0.12	0.14	0.32	0.20	0.17
<b>Section 6</b>	0.27	0.05	0.22	0.11	0.14	0.31
<b>Section 7</b>	0.19	0.17	0.05	0.71	0.30	0.03
<b>Section 8</b>	0.21	0.13	0.08	0.58	0.28	0.03
<b>Sum</b>	0.33	0.01	0.22	0.10	0.26	0.04

**Table: A.1** Relationship between sections 1-8 of the MSSS88 and biomechanical measures of total stiffness, passive stiffness and stretch reflex mediated stiffness at baseline for all MS participants. Sum = total of sections 1-8 compared with stiffness measures. \* Significant following bonferonni correction for multiple comparisons

R = Pearson's rank correlation



**Figure A.1:** Total stiffness compared with section 3 of the MSSS88 measure of the effect of muscle spasm on walking in MS.