

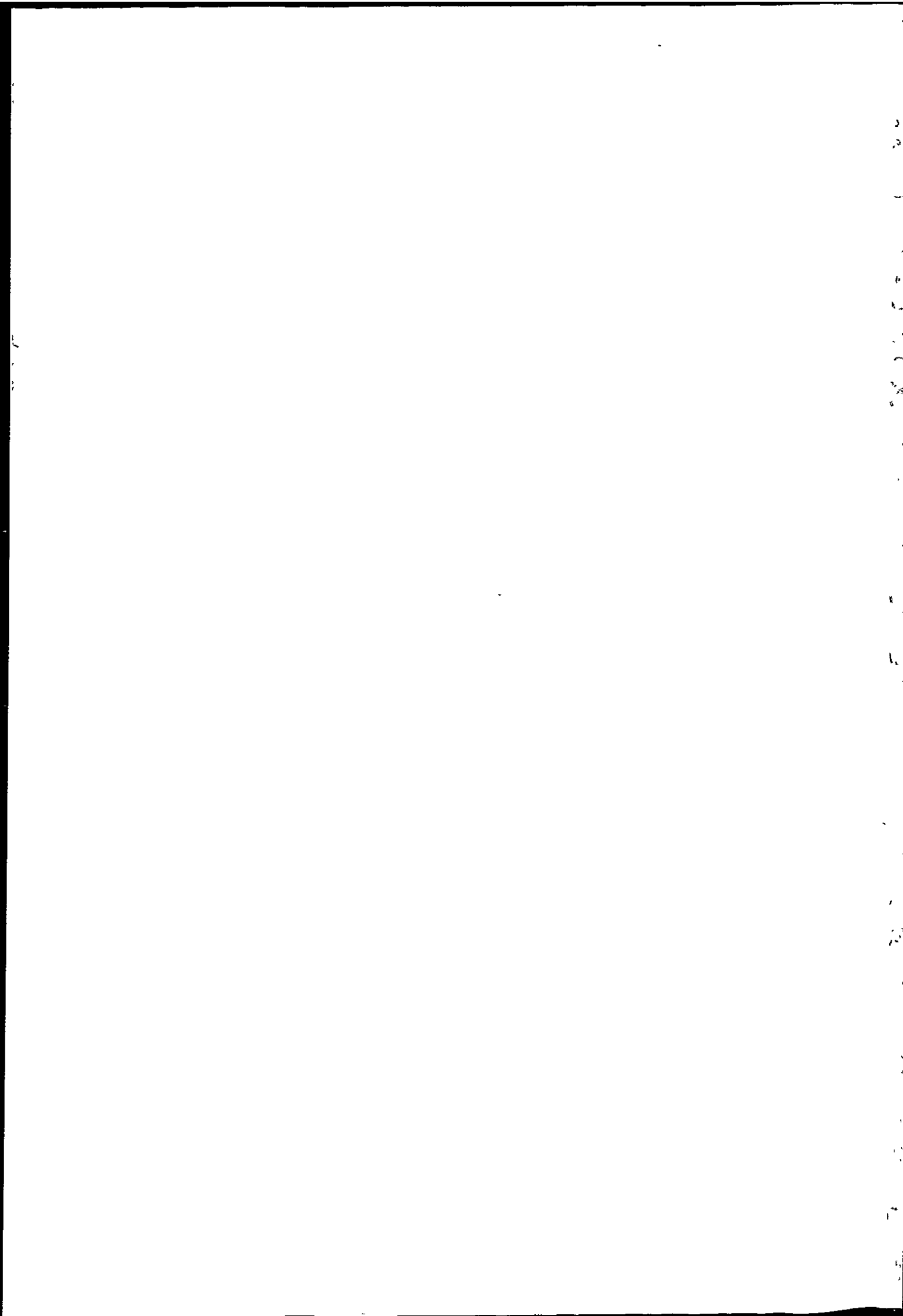
store

AUTOMATED INTERPRETATION OF THE  
BACKGROUND EEG USING FUZZY LOGIC

EDWARD PETER RIDDINGTON

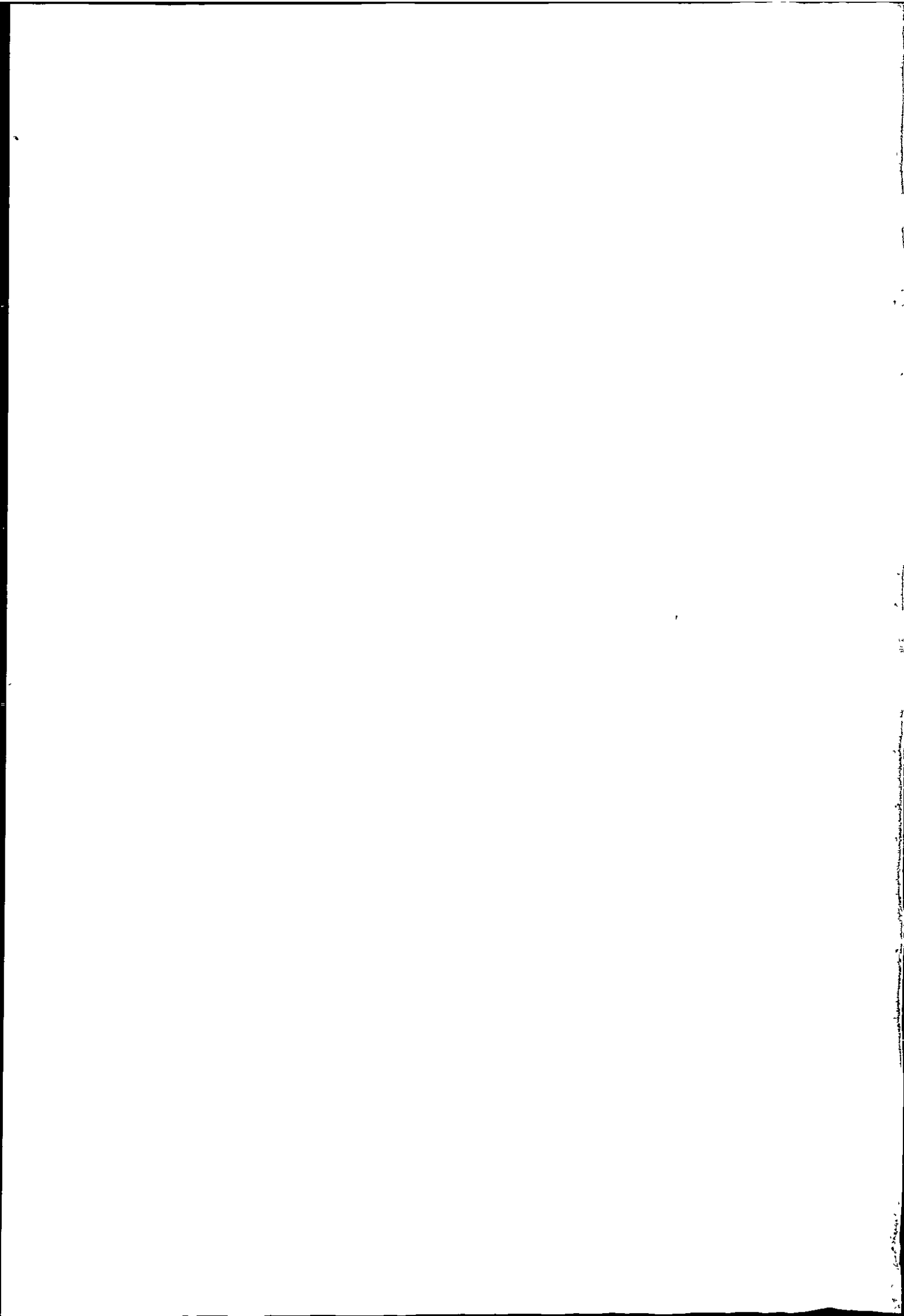
REFERENCE ONLY

LIBRARY STORE



## COPYRIGHT STATEMENT

*This copy of the thesis has been supplied on the condition that anyone who consults it is understood to recognise that its copyright rests with its author and that no quotation from the thesis and no information derived from it may be published without the author's prior consent.*



**AUTOMATED INTERPRETATION OF THE BACKGROUND EEG  
USING FUZZY LOGIC**

by

**EDWARD PETER RIDDINGTON**

A thesis submitted to the University of Plymouth  
in partial fulfilment for the degree of

**DOCTOR OF PHILOSOPHY**

School of Electronic, Communication and Electrical Engineering  
Faculty of Technology

In collaboration with the  
Department of Neurophysiology  
Derriford Hospital  
Plymouth

**August 1998**

BHDSC Thesis Number DX 228650

REFERENCE ONLY

LIBRARY STORE

UNIVERSITY OF PLYMOUTH	
Item No.	900 382670 0
Date	24 NOV 1998 T
Class No.	T616.804-7547 RD
Cont. No.	X703804889
LIBRARY SERVICES	

90 0382670 0



# Automated Interpretation of the Background EEG using Fuzzy Logic

by

Edward Peter Riddington

A new framework is described for managing uncertainty and for dealing with artefact corruption to introduce objectivity in the interpretation of the electroencephalogram (EEG).

Conventionally, EEG interpretation is time consuming and subjective, and is known to show significant inter- and intra-personnel variation. A need thus exists to automate the interpretation of the EEG to provide a more consistent and efficient assessment. However, automated analysis of EEGs by computers is complicated by two major factors. The difficulty of adequately capturing in machine form, the skills and subjective expertise of the experienced electroencephalographer, and the lack of a reliable means of dealing with the range of EEG artefacts (signal contamination). In this thesis, a new framework is described which introduces objectivity in two important outcomes of clinical evaluation of the EEG, namely, the clinical factual report and the clinical 'conclusion', by capturing the subjective expertise of the electroencephalographer and dealing with the problem of artefact corruption.

The framework is separated into two stages to assist piecewise optimisation and to cater for different requirements. The first stage, 'quantitative analysis', relies on novel digital signal processing algorithms and cluster analysis techniques to reduce data and identify and describe background activities in the EEG. To deal with artefact corruption, an artefact removal strategy, based on new reliable techniques for artefact identification is used to ensure that artefact-free activities only are used in the analysis. The outcome is a quantitative analysis, which efficiently describes the background activity in the record, and can support future clinical investigations in neurophysiology. In clinical practice, many of the EEG features are described by the clinicians in natural language terms, such as *very high, extremely irregular, somewhat abnormal* etc. The second stage of the framework, 'qualitative analysis', captures the subjectivity and linguistic uncertainty expressed by the clinical experts, using novel, intelligent models, based on fuzzy logic, to provide an analysis closely comparable to the clinical interpretation made in practice. The outcome of this stage is an EEG report with qualitative descriptions to complement the quantitative analysis.

The system was evaluated using EEG records from 1 patient with Alzheimer's disease and 2 age-matched normal controls for the factual report, and 3 patients with Alzheimer's disease and 7 age-matched normal controls for the 'conclusion'. Good agreement was found between factual reports produced by the system and factual reports produced by qualified clinicians. Further, the 'conclusion' produced by the system achieved 100% discrimination between the two subject groups. After a thorough evaluation, the system should significantly aid the process of EEG interpretation and diagnosis.



This thesis is dedicated to  
my parents Peter and Sandra,  
my sisters Catherine and Sally  
and the memory of my grandparents Ann and Cyril.

## LIST OF CONTENTS

<b>1. Introduction</b>	<b>1</b>
1.1 The electroencephalogram	1
1.2 The clinical EEG assessment	6
1.3 The need for automated interpretation	7
1.4 EEG interpretation methods	8
1.5 Key problems in EEG interpretation methods	9
1.6 A new framework for handling uncertainty and artefacts in EEG interpretation	11
1.7 Thesis overview	12
1.8 References	15
<b>2. Principles of fuzzy logic</b>	<b>20</b>
2.1 Introduction	20
2.2 Ordinary set theory	20
2.2.1 Ordinary sets	21
2.2.2 Ordinary set relations	21
2.2.3 Ordinary set composition	22
2.3 Linguistic variables	23
2.3.1 Fuzzy sets	23
2.3.2 Linguistic variables, hedges and connectives	24
2.4 Approximate reasoning	27
2.4.1 Fuzzy set relations	27
2.4.2 Inference using binary fuzzy relations	28
2.4.3 Inference using multi-dimensional relations	31
2.4.4 Inference using fuzzy rules	32
2.4.5 Linguistic approximation	34
2.5 Summary	36
2.6 References	37
<b>3. Data collection</b>	<b>39</b>
3.1 Introduction	39
3.2 Data acquisition system specification	40
3.3 Data acquisition system design	41
3.4 Pre-processing	42
3.5 Digitisation	45
3.6 Data collection protocols	46
3.7 Data collection	52
3.8 Summary	53
3.9 References	53
<b>4. Spectrum estimation of the EEG</b>	<b>55</b>
4.1 Introduction	55
4.2 Pre-processing	55
4.3 Power spectrum estimation	56
4.4 Power spectrum estimation for the background EEG	59

4.4.1	Reducing side lobe distortion	62
4.4.2	Pseudo ensemble averaging	66
4.4.3	Interpolating the power spectrum	69
4.5	Summary	71
4.6	References	73
<b>5.</b>	<b>Quantitative EEG analysis</b>	<b>76</b>
5.1	Introduction	76
5.2	Identification of background EEG activities	77
5.3	Feature extraction	79
5.3.1	Frequency domain analysis	79
5.3.2	Time domain analysis	80
5.4	Data reduction	83
5.5	Artefact Removal	87
5.6	Summary	90
5.7	References	90
<b>6.</b>	<b>Qualitative EEG analysis</b>	<b>93</b>
6.1	Introduction	93
6.2	Descriptive interpretation	94
6.2.1	A model for describing the feature 'organisation'	94
6.2.2	A model for describing the feature 'location'	104
6.3	Diagnostic interpretation	107
6.3.1	Characteristics of the normal and Alzheimer's EEG	107
6.3.2	A model to determine the degree of normality or abnormality in the EEG	110
6.4	Tools and methods	115
6.5	Summary	118
6.6	References	119
<b>7.</b>	<b>System evaluation and results</b>	<b>124</b>
7.1	Introduction	124
7.2	Automatic EEG reporting	124
7.3	Automatic assessment of the degree of abnormality of the EEG	134
7.4	Evaluation of fuzzy operators using ROC analysis	139
7.4.1	Introduction to ROC analysis	139
7.4.2	Operator evaluation	142
7.5	References	144
<b>8.</b>	<b>Review, future work and conclusion</b>	<b>145</b>
8.1	Review	145
8.2	Future work	147
8.3	Conclusion	149
8.4	References	149
<b>Appendix A. Multi-valued logic</b>		<b>151</b>
<b>Appendix B. Recording montages</b>		<b>154</b>
<b>Appendix C. Mini-mental state assessment</b>		<b>156</b>

<b>Appendix D. Searching the MDI database</b>	<b>159</b>
<b>Appendix E. EEG data file formats</b>	<b>162</b>
<b>Appendix F. Inference in fuzzy systems</b>	<b>163</b>
<b>Appendix G. Rules used for the diagnostic interpretation</b>	<b>167</b>
<b>Appendix H. System user guide</b>	<b>170</b>
<b>Appendix I. Implication operator evaluation results</b>	<b>175</b>
<b>Appendix J. Papers</b>	<b>186</b>

## ACKNOWLEDGEMENT

I would like to acknowledge:

Prof. Emmanuel Ifeakor, for his competent supervision and for the influence he has made on my belief in achievement by hard work and high standards;

Dr Elaine Allen, for her valuable advice and the many hours of instruction in neurophysiology;

Nigel Hudson, for his discussions in EEG technology and his co-operation during the data collection;

Prof. Des Mapps and Dr Sunil Wimalaratna, for their respected advice and discussions;

the EEG Dept. Technical Staff, for their help and assistance, particularly during data collection;

all the subjects, for volunteering during EEG data collection;

all my colleagues at the Centre for Intelligent Systems at the University for contributing to the creative and enjoyable working atmosphere, especially Gary Darragh, Steve Harris and Nick Outram

and the Engineering and Physical Sciences Research Council (EPSRC) and the University of Plymouth, for funding this work.

## AUTHOR'S DECLARATION

At no time during the registration for the degree of Doctor of Philosophy has the author been registered for any other University award.

This study was financed with the aid of a studentship from the Engineering and Physical Sciences Research Council (EPSRC) and the University of Plymouth.

### Papers:

Riddington, E. P., Ifeachor, E. C., Allen, E. M., Hudson, N. R., Wimalaratna, H. S. K. and Mapps, D. J. (1997) Automated qualitative interpretation of EEGs using fuzzy logic. The British Society for Clinical Neurophysiology (formerly the EEG Society) Scientific Meeting, National Hospital for Neurology and Neurosurgery, London. January, 1997.

Riddington, E. P., Ifeachor, E. C., Wu, J., Allen, E. M., Hudson, N. R. Wimalaratna, H. S. K. and Mapps, D. J. (1996d) Knowledge-based automated interpretation of the background EEG using fuzzy logic. *IEEE Transactions on Biomedical Engineering* (Revised and re-submitted November, 1997)

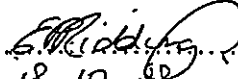
Riddington, E. P., Ifeachor, E. C., Allen, E. M., Hudson, N. R. and Mapps, D. J. (1996c) Knowledge-based enhancement and interpretation of EEG signals. *Proceedings of the 2<sup>nd</sup> International Conference on Neural Networks and Expert Systems in Medicine and Healthcare*, University of Plymouth, Plymouth. pp. 246-255.

Riddington, E. P., Ifeachor, E. C., Allen, E. M., Hudson, N. R. and Mapps, D. J. (1996b) Investigation into different methods of fuzzy inference using ROC analysis. *Proceedings of the 2<sup>nd</sup> International Conference on Neural Networks and Expert Systems in Medicine and Healthcare*, University of Plymouth, Plymouth. pp. 104-111.

Riddington, E. P., Wu, J., Ifeachor, E. C., Allen, E. M. and Hudson, N. R. (1996a) Intelligent enhancement and interpretation of EEG signals. *Proceedings of the IEE Colloquium on Artificial Intelligent Methods for Biomedical Data Processing*, Savoy Place, London. pp. 11/1-11/7.

Riddington, E. P., Ifeachor, E. C., Allen, E. M., Hudson, N. R. and Mapps, D. J. (1994) A fuzzy expert system for EEG interpretation. *Proceedings of the International Conference on Neural Networks and Expert Systems in Medicine and Healthcare*, University of Plymouth, Plymouth. pp. 291-302.

Ifeachor, E. C. and Riddington, E. P. (1993) Use of artificial intelligence in EEG evaluation. The Electrophysiological Technologists' Scientific Meeting, Postgraduate Medical Centre, Derriford Hospital, Plymouth.

Signed..........  
Date.....18.10.92.....

## GLOSSARY OF TERMS

TERM	MEANING
<b>electroencephalogram</b>	recording of electrical activity of the brain
<b>EEG</b>	electroencephalogram
<b>EEG artefact</b>	waveforms which do not originate from the brain and which corrupt the EEG
<b>Alzheimer's disease</b>	a brain disorder characterised by a progressive dementia
<b>background EEG activities</b>	continuous, quasi-periodic EEG waveforms
<b>paroxysmal EEG activities</b>	short duration, non-periodic EEG waveforms
<b>delta activity</b>	background EEG activity with a frequency between 0 and 4 Hz
<b>theta activity</b>	background EEG activity with a frequency between 4 and 8 Hz
<b>alpha activity</b>	background EEG activity with a frequency between 8 and 13 Hz
<b>beta activity</b>	background EEG activity with a frequency greater than 13 Hz
<b>factual report<sup>1</sup></b>	description made by clinicians of the background and paroxysmal activities in the EEG
<b>dominant activity</b>	the background EEG activity having the largest power in the occipital channels

---

<sup>1</sup> NB. The factual report produced by the automated system for EEG interpretation provides a description of background activities only.

# 1. Introduction

---

## 1.1 The electroencephalogram

The electroencephalogram (EEG), the recording of electrical activities of the brain, is a non-invasive, inexpensive tool, used to analyse and diagnose many neurological disorders such as epilepsy, dementia and coma. Typically, it is recorded from 8, 16 or 21 locations from the scalp and, for the routine examination, lasts for between 15 and 60 minutes.

Waveforms of interest in the EEG, called 'activities', can be classified as either 'background' or 'paroxysmal'. Background activities are continuous, quasi-periodic and are traditionally grouped by frequency into the bands: delta (0 - 4Hz); theta (4 - 8Hz); alpha (8 - 13Hz) and beta (13 - 30Hz). Paroxysmal activities are short duration, non-periodic and are usually described in terms of wave shape such as 'spikewave' or 'sharpwave'. Examples of these waveforms are given in Figure 1 and Figure 2.

In addition to cerebral activities, the EEG will also record activities from other biological sources such as the eyes (electro-oculography signals), muscles (electromyography signals) and heart (electrocardiography signals). The EEG will also pick up electrical interference such as mains noise. These 'artefacts' corrupt the cerebral activity making EEG interpretation difficult. This is particularly so for



eye movement artefact and muscle artefact, which share many of the characteristics, such as frequency, with the genuine EEG waveforms.

A 4 second excerpt taken from an EEG record is shown in Figure 3. Alpha activity with a frequency at about 10Hz, which can be seen to attenuate with eye opening, is clearly discernible, particularly at the back of the head. This activity is characteristic of the normal adult. Figure 4 shows a section of EEG recorded from a patient with Alzheimer's disease. Here, the activity is less at about 8Hz and shows no change with eye opening (Visser 1991).

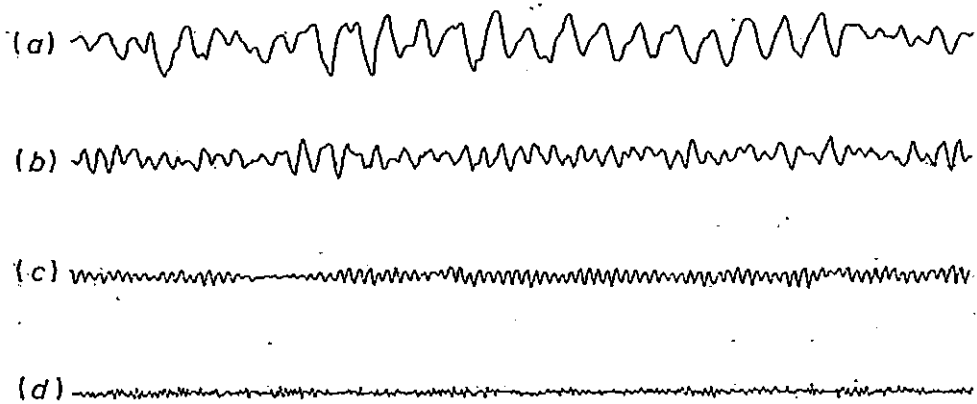


Figure 1. Examples of (a) delta, (b) theta, (c) alpha and (d) beta activity (from Cooper et al. 1980).

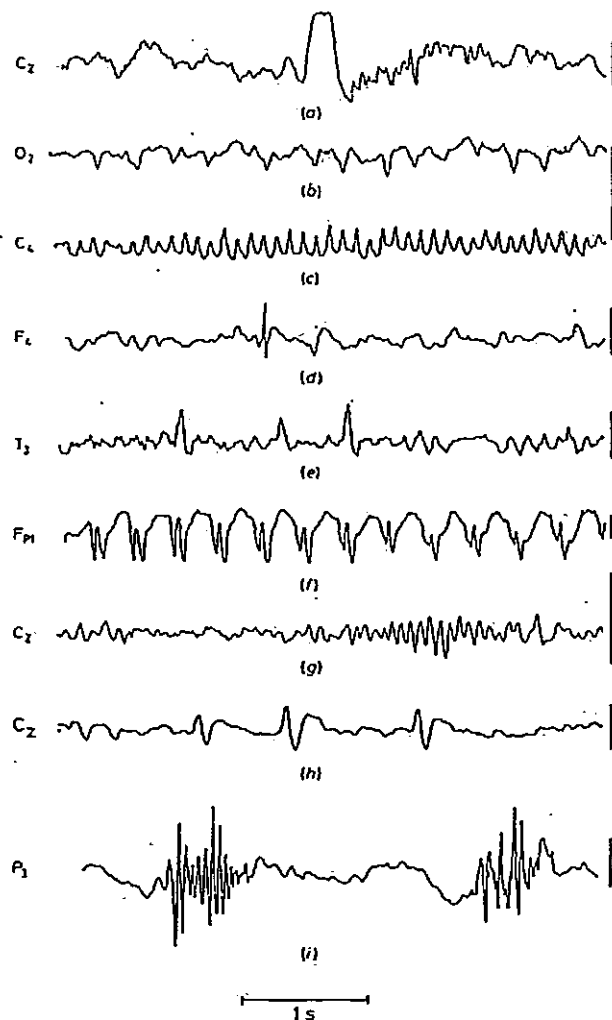


Figure 2. Examples of specific waveforms. (a) K-complex. (b) Lambda wave. (c) Mu rhythm. (d) Spike. (e) Sharp waves. (f) Repetitive spike and wave activity. (g) Sleep spindle. (h) Vertex sharp waves. (i) Polyspike discharges. (from Cooper et al. 1980).

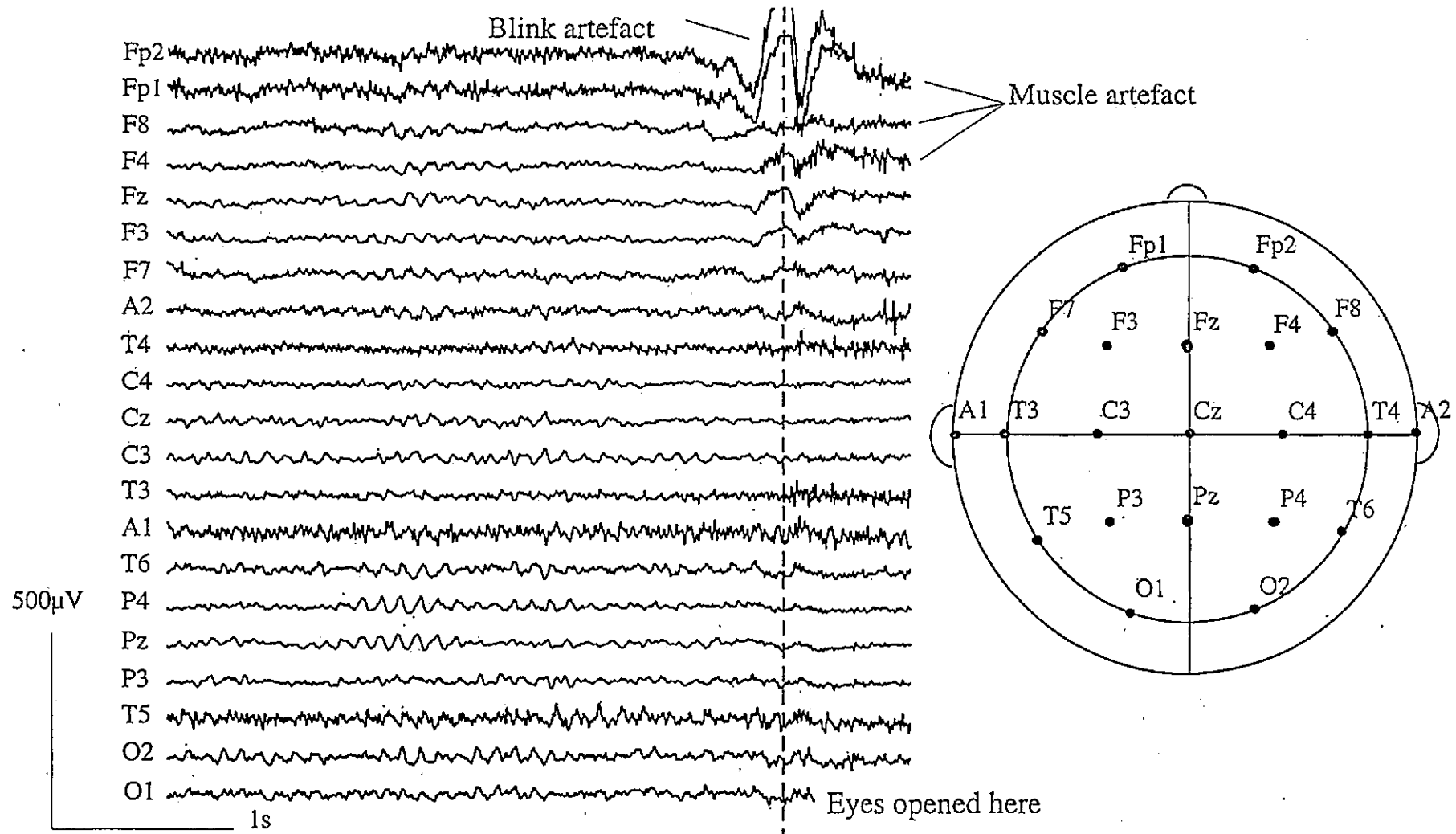


Figure 3. A section of EEG recorded from the normal adult. Characteristic of the normal EEG is the alpha rhythm at about 10Hz which attenuates with eye opening. Note the corruption of the EEG by blink and muscle artefact.

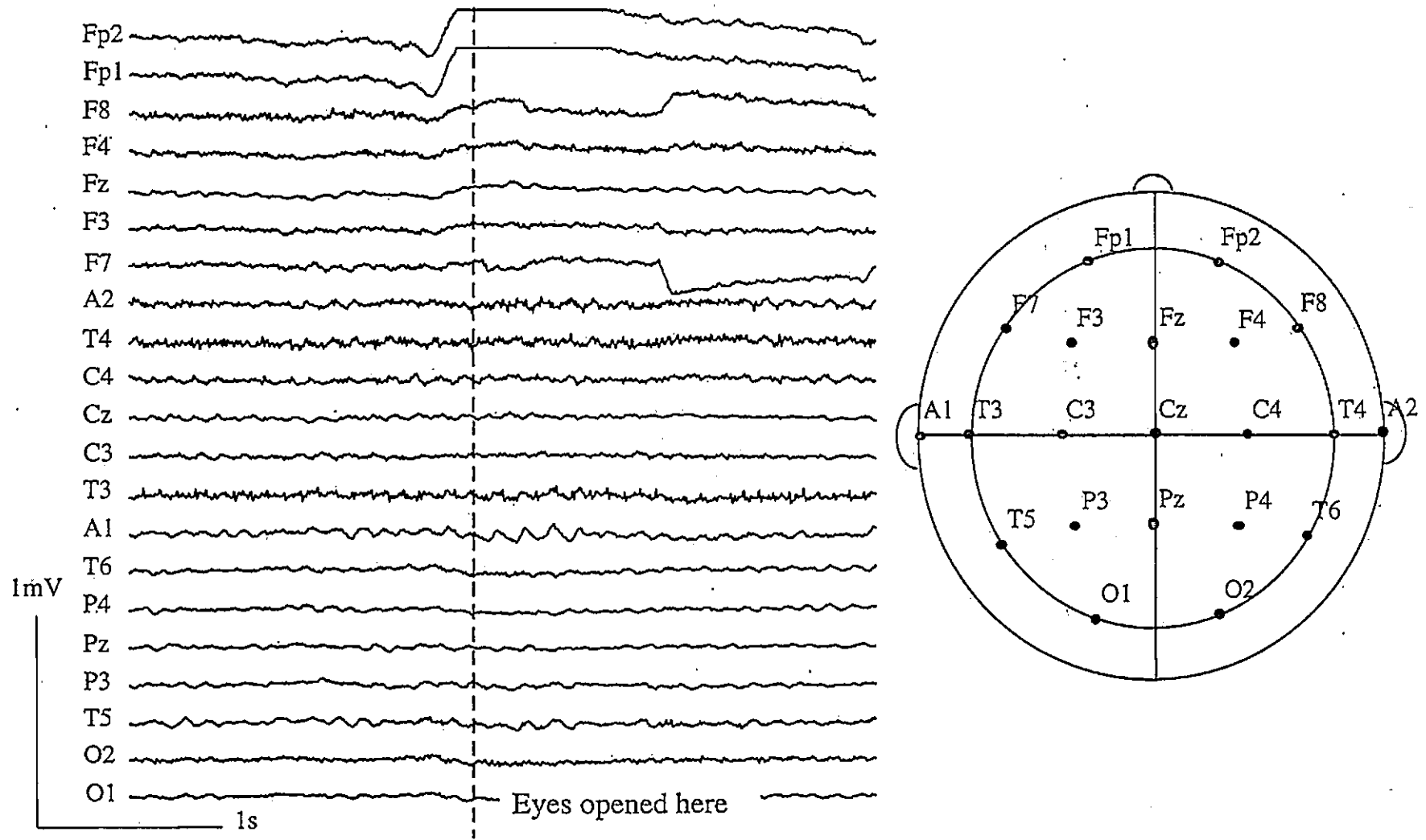
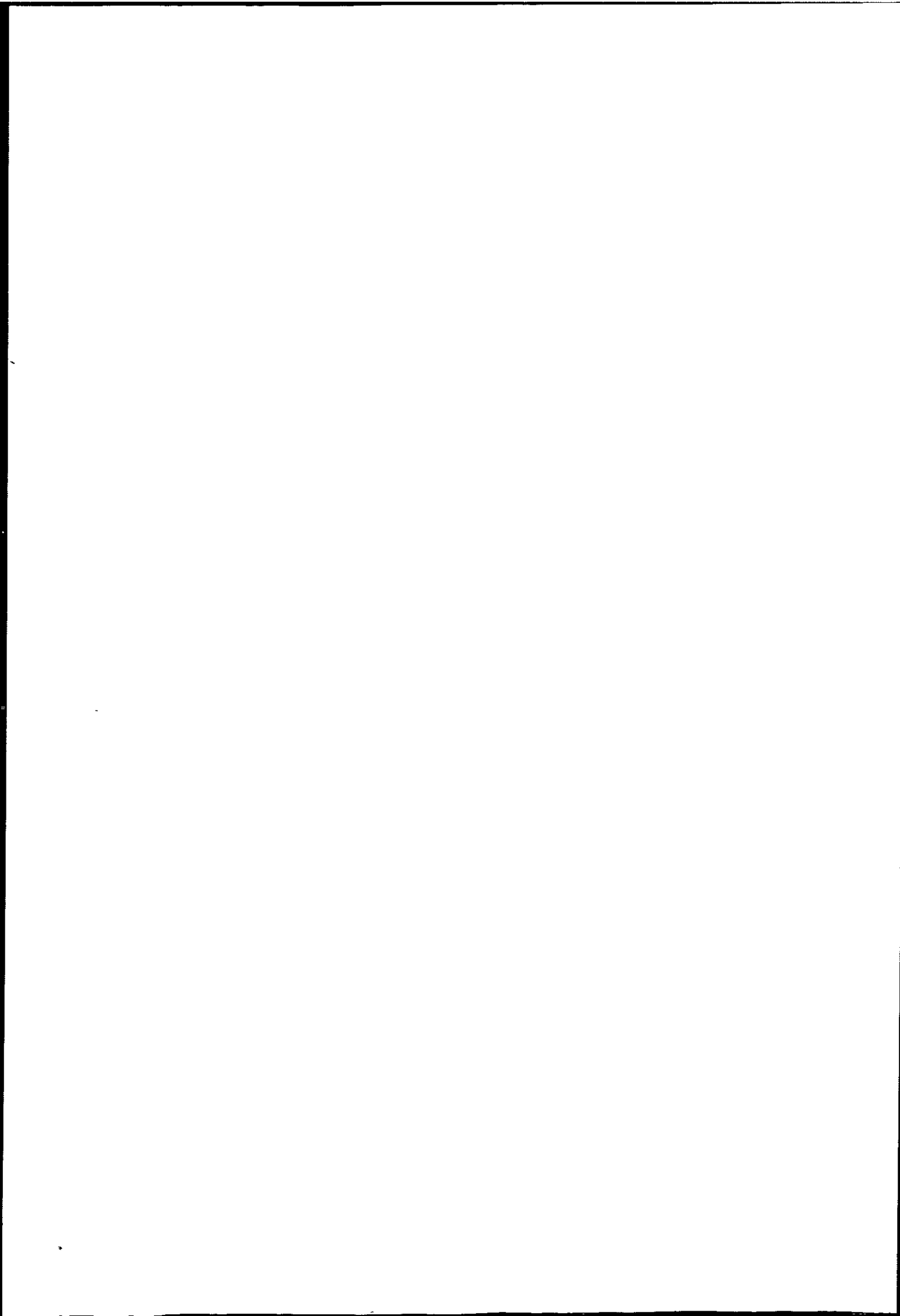


Figure 4. A section of EEG recorded from a patient with Alzheimer's disease. Characteristic of this is an alpha rhythm which has slowed in frequency and which elicits no change in eye opening.



## 1.2 The clinical EEG assessment

Typically an EEG assessment will be requested by a doctor to provide supportive evidence or otherwise of a provisional diagnosis. A typical request is given in Figure 5, where tonic-clonic fits is given as a provisional diagnosis. An EEG recording will then be made and for the basic EEG, will require the patient to be awake and with eyes closed. Activation procedures, such as the opening of the eyes, 'hyperventilation' and 'photic stimulation' will then be performed to elicit further information. Significant activities that are found in the EEG are subsequently described in a factual report. (Figure 6). Such as report needs to be descriptive and can be quite personalised. Finally an analysis made for the referring doctor by a neurophysiologist based on the EEG, the factual report and the original clinical request (the CONCLUSION in Figure 6).

NAME A N Other	AGE 30	EEG No. 944/90	DATE 24.12.90
HOSPITAL No 7856745 CONSULTANT Dr. Thrush			
PROVISIONAL DIAGNOSIS Tonic-clonic fits			
MAIN SYMPTOMS Tonic clonic fits as a child and June 1990, also obscure seizures as a child.			
PREVIOUS HISTORY Febrile convulsions.			
FAMILY HISTORY Aunt has tonic clonic fits.			
OTHER CLINICAL FEATURES Previous EEG spike and-wave 1975.			
MEDICATION Nil.			

*Figure 5. EEG request form questioning a provisional diagnosis of tonic-clonic fits.*

The patient was alert and co-operative.

The EEG shows an alpha rhythm 9-10Hz, 50-120 $\mu$ V, which is symmetrical and attenuated by eye opening. Intermittent low voltage beta activity 15-25Hz is also recorded bilaterally. Theta activity 4-7Hz is recorded diffusely bilaterally, predominantly in the right centro and posterior temporal areas where it is frequently the dominant rhythm. Delta activity 3-3.5Hz is also recorded, again predominantly recorded in the right posterior temporal area. Occasional sharp elements are recorded phase reversing about T6 (often with slow elements). A burst of bilaterally synchronous irregular spike and wave activity 3-4Hz, up to 300 $\mu$ V of 3 seconds duration is recorded. Hyperventilation was performed well and evokes a marked increase in slow activity bilaterally. Two further bursts of spike and wave activity of 4 and 6 seconds duration are recorded during which the patient continued to hyperventilate with no obvious hesitation. Following overbreathing the patient was asked to count backwards from 100 but no further spike and wave activity is recorded at this time. Photic stimulation elicits flash following responses at 8-20 f/sec. At 18 and 20 f/sec, low voltage spikes are recorded from the right posterior temporal area during stimulation with eyes open. Further stimulation at 20 f/sec elicits another burst of high voltage spike and wave activity lasting three seconds after cessation of stimulation.

**CONCLUSION** The relevant abnormalities are high voltage spike and wave activity which occurred both spontaneously and during activation by hyperventilation and photic stimulation. Although impairment of awareness was not demonstrated during the recording, there were probably episodes of petit mal.

*Figure 6. EEG factual report and interpretation of findings. The factual report describes the background and paroxysmal activities in the EEG and the conclusion describes the significance of the assessment in relation to the clinical problem described on the request form.*

### **1.3 The need for automated interpretation**

Interpreting the EEG record is a difficult task which requires many years of experience. It is time consuming, subjective and is known to show significant inter- and intra-personnel variation (Kiloh et al. 1981 pp. 272-280). A need thus exists to automate the interpretation of the EEG to provide a more consistent and efficient assessment (Barlow 1979, Ktonas 1983). For example, objective evaluation provided by automated interpretation would help standardise the clinical interpretation and minimise inter- and intra-examiner variability. Assistance provided by an automated system would also help reduce the clinical workload.

## 1.4 EEG interpretation methods

Previous attempts in computer-based EEG interpretation, modelled the reasoning process of the clinicians using decision algorithms (MacGillivray and Wadbrook 1974, Frost 1980, and Pradhan et al. 1993), syntactic pattern recognition (Giese et al. 1979 and Bourne et al. 1980) and rule-based expert systems (Jagannathan et al. 1982, Bourne et al. 1983, Baas and Bourne 1984, Davey et al. 1989 and Glover et al. 1990).

Methods based on syntactic analysis are used to analyse the structure of the EEG by first dividing the EEG record into short epochs and classifying each epoch into labels. Rules which embody the knowledge of the clinical experts, subsequently classify structures in these labels, in an iterative fashion, until an overall interpretation of the record is obtained. For example, in Giese et al. (1979), a system is described to analyse the structure of the EEG both spatially across the scalp and in time. The EEG is first divided into 1s epochs. Each epoch is then characterised by spectral parameters such as peak frequency and peak power, and discriminant analysis attaches one of several labels to the epoch such as *normal*, *artefact*, *slow* etc. Finally, rules which have been developed to analyse these labels provide an overall interpretation of the record such as *low amplitude*, *slow* etc.

Rule-based approaches, whilst theoretically equivalent to the syntactic analysis based methods, are significantly more efficient for representing the knowledge provided by the clinical experts. In Bourne et al. (1983), frequencies in each 5s epoch, are labelled in terms of amplitude e.g. *alpha is low*. IF-THEN type rules



are then used to classify the labels, first spatially, to produce classifications for each epoch such as *alpha*, *diffuse slowing* (delta or theta activity located diffusely on the scalp) etc., and then temporally, to determine an overall impression such as *normal*, *abnormal* etc. To account for uncertainty which may be present in the reasoning process employed by the clinician, Jagannathan et al. (1982) enhanced the rule-based approach by providing a measure of belief for the conclusions made by the system. The use of the rule-based approach to model the patterns of reasoning used by the clinician was also applied by Davey et al. (1989) for the analysis performed across the scalp to detect paroxysmal activities in the EEG. Detection is performed using the algorithms developed by Gotman and Gloor (1976). False positives (false spikes and sharp waves) are subsequently eliminated by the rule-based system by taking into account factors such as the expected spatial distribution of an event. A similar approach is also described in Glover et al. (1990).

## **1.5 Key problems in EEG interpretation methods**

Despite the above attempts, automated interpretation of the EEG is complicated by two major factors. The difficulty of adequately capturing in machine form, the subjective expertise of the experienced electroencephalographer, and the lack of a reliable means of dealing with the range of EEG artefacts (signal contamination).

In practice, many EEG features are described by clinical experts in natural language terms such as *small amounts* or *low amplitude* etc. For example, Table 1 shows short extracts from a paper on EEG interpretation by Visser (1991).

---

In normal adults the alpha rhythm is *usually rather* abundant  
12% of normal young adults have a *slight* excess of fast activity  
24% of normal adults over 70 have a *slight* excess of fast activity  
In old age the reactivity of the alpha rhythm *slightly* diminishes  
In normal subjects, focal abnormalities *rarely* exceed 25% of the EEG  
recording

---

*Table 1. Subjectivity when describing the EEG is evident in much of the literature. These examples were taken from Visser (1991).*

Significant attempts have been made, to cater for the subjective nature of the EEG interpretation (Jagannathan et al. 1982, Bourne et al. 1983 and Baas and Bourne 1984). However, the techniques developed thus far, do not provide an adequate model of the reasoning process employed by experts. For example, the uncertainty in the conclusions of the rules in the expert systems are represented numerically (e.g. where 1 indicates complete belief and 0 indicates complete disbelief). In practice, uncertainty is not dealt with numerically, but linguistically (expressed using terms such as *very, more or less, extremely* etc.).

The second major issue is that current EEG analysis systems fail to process the EEG adequately for artefacts. For example, in the systems developed by Giese et al. (1979) and Bourne et al. (1983), artefacts are identified using basic time domain or frequency domain features only. For these systems to be reliable, artefact identification should be based on a wide range of characteristic features such as spectral shape, inter-channel relationships and heuristic rules (Ifeachor et al. 1990, Hellyar 1991, Wu et al. 1997).

## 1.6 A new framework for handling uncertainty and artefacts in EEG interpretation

A new framework for managing uncertainty and dealing with artefacts in EEG interpretation is described (Figure 7).

To assist piecewise optimisation, the framework is separated into two stages. Each caters for different requirements. The first stage, 'quantitative analysis', identifies the significant activities which exist in the EEG and using digital signal processing (DSP) algorithms, extracts the time domain, frequency domain and spatial features that characterise them. The effects caused by artefacts are minimised by integrating new techniques for artefact identification (Wu et al. 1997) and implementing a basic artefact removal algorithm. The outcome of this stage is a quantitative interpretation, which is important in its own right, and may be used to support future clinical investigations in neurophysiology.

In clinical practice, many of the EEG features are described by the clinicians in natural language terms, such as *very high*, *extremely irregular*, *somewhat abnormal* etc. The second stage of the framework, 'qualitative analysis', captures the subjective expertise of the electroencephalographer, using models based on fuzzy logic (Zadeh 1975a, 1975b, 1975c). The models are used to analyse EEG activities using the time, frequency and spatial features and the underlying reasoning process used by the clinical experts. The outcome of this stage is an EEG report with qualitative descriptions to complement the quantitative analysis.

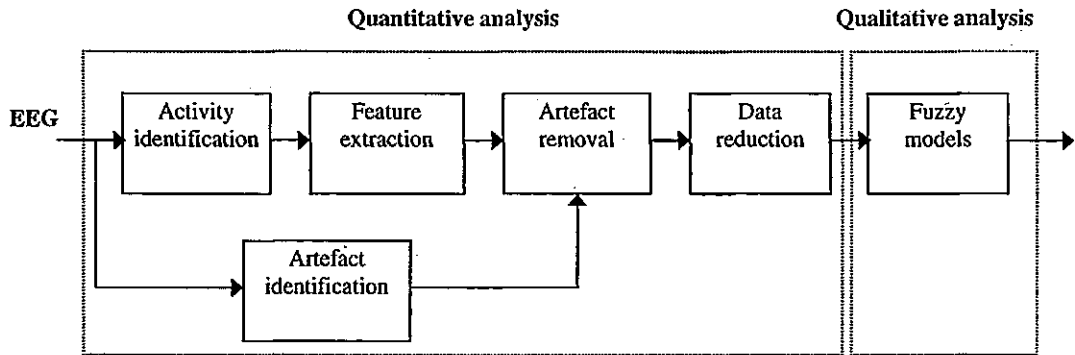


Figure 7. A new framework for managing uncertainty and dealing with artefacts in EEG interpretation.

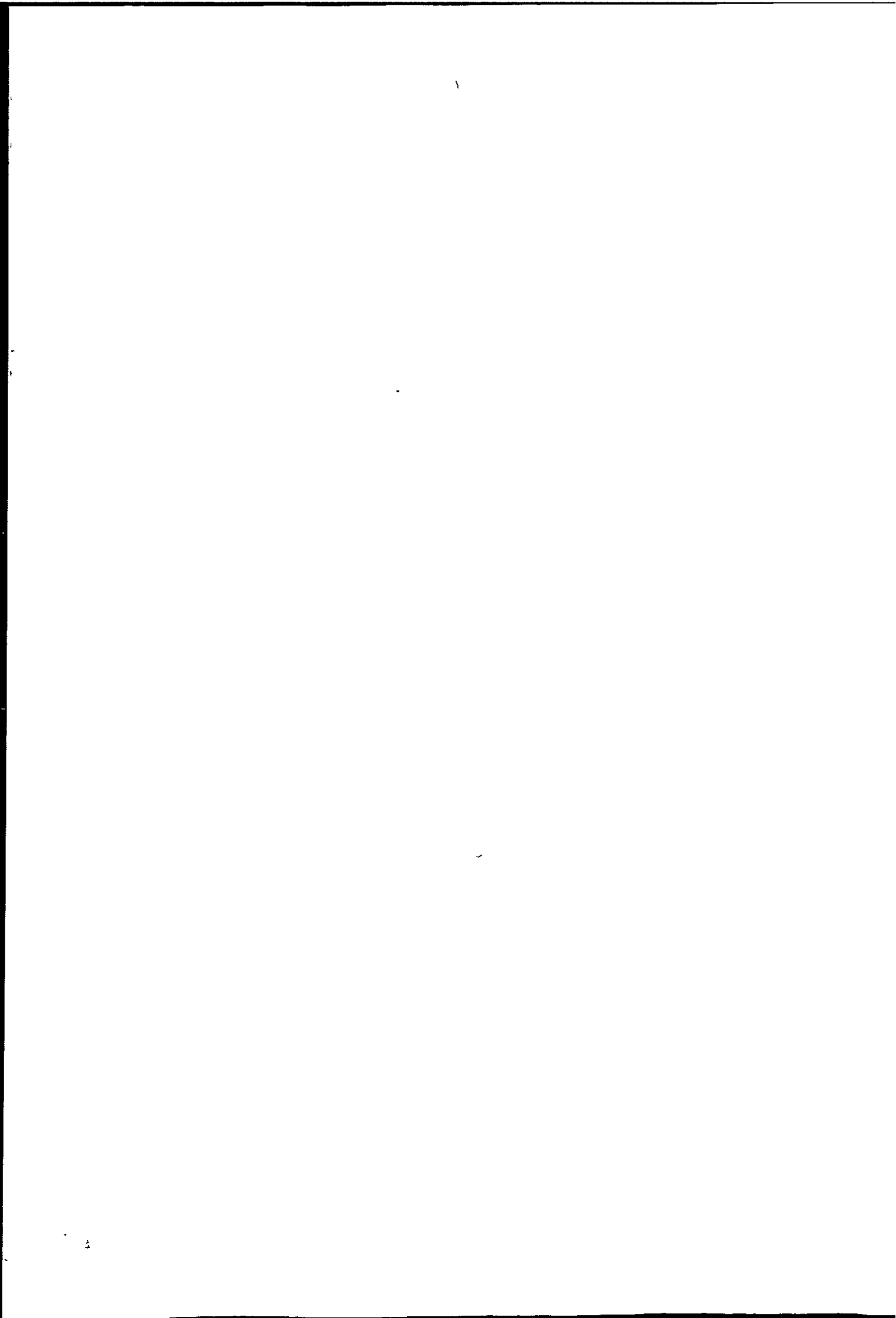
## 1.7 Thesis overview

The body of the thesis is arranged in 6 chapters outlined below.

### Principles of fuzzy logic

In Chapter 2, two important concepts in fuzzy logic which provide a suitable framework for capturing the underlying decision processes used by the clinical experts are described. The first concept, 'linguistic variables', provides a methodology for representing qualitative propositions such as *age is neither young nor old*, *temperature is hot*, *car is slow* etc. The second concept, 'approximate reasoning', provides a framework for inference using qualitative propositions such as these and for managing natural language uncertainty using terms such as *very*, *somewhat*, *extremely* etc.

### Data collection



In order to acquire sufficient data, in a controlled environment, a data acquisition system and data collection protocols were designed and implemented within the hospital environment. This provided a database of normal and abnormal EEG signals, information on a range of EEG activities and artefacts, and data with which to develop and evaluate EEG analysis and artefact processing techniques. Chapter 3 details the design and implementation of the data acquisition system and the data collection protocols.

### **Spectrum estimation of the EEG**

Background EEG activities, due to their rhythmic nature, are well suited to analysis in the frequency domain and as such, many techniques to interpret background EEG activities rely on methods for estimating power spectral density. Chapter 4 thus describes the development of a reliable technique for power spectral density estimation, based on the Welch periodogram.

### **Quantitative EEG analysis**

Costs in time taken and inter- and intra-personnel variation could be minimised in clinical EEG assessment, if digital signal processing (DSP) algorithms were developed which reliably identify and describe the activities in the EEG in an objective manner. In Chapter 5, DSP algorithms are described which identify in the frequency domain, background activities in 4 second EEG segments and for each activity identified, extract basic time and frequency domain features. These

features are classified using clustering techniques to remove redundancy and to identify the significant background activities which exists in the entire EEG record. Further processing techniques are then used to calculate salient features which describe each activity. At this stage, the corruption of the EEG by artefacts, which share many characteristics with the EEG activities, would produce misleading results in the analysis. To deal with this problem, an artefact removal strategy is used to minimise the effects of muscle or eye movement artefacts during the clustering procedure. The outcome is a quantitative analysis which efficiently describes the background activity in the EEG record.

### **Qualitative analysis**

In the previous chapter, techniques are described which quantitatively extract the salient features for each background activity. In practice however, many EEG features are described qualitatively using terms such as *very low amplitude*, *extremely abnormal* etc. In Chapter 6, models based on fuzzy logic (Zadeh 1975a, 1975b, 1975c), are described which are used to analyse EEG activities based on the underlying processes of judgement and reasoning used by the clinical experts. These models are used to describe three important features in the EEG: the *organisation* of each activity; the *location* of each activity on the scalp and the overall *assessment* regarding the degree of abnormality or otherwise in the EEG. The outcome is an analysis which provides qualitative descriptions such as *somewhat irregular, frontal - more on the left* and *very possibly normal*, which were lacking in the quantitative analysis

## System evaluation and results

In Chapter 7, a limited evaluation of the system to assess the viability of the new framework is presented. The evaluation is described in three sections: (i) the evaluation of the aspect of the system that provides the factual report automatically; (ii) the evaluation of the aspect of the system that provides the assessment of abnormality of the EEG; and (iii) the evaluations of 11 fuzzy implication operators which was carried out to identify the operator that was most suitable.

## 1.8 References

Baas, L. and Bourne, J. R. (1984) A rule-based microcomputer system for electroencephalogram evaluation. *IEEE Transactions on Biomedical Engineering*, vol. BME-31, no. 10, pp. 660-664.

Barlow, J. S. (1979) Computerized clinical electroencephalography in perspective. *IEEE Transactions on Biomedical Engineering*, vol. BME-26, no. 7, pp. 377-391.

Bourne, J. R., Jagannathan, V., Giese, B. and Ward, J. W. (1980) A software system for syntactic analysis of the EEG. *Computer Programs in Biomedicine*, vol. 11, pp. 190-200.



Bourne, J. R., Matousek, M., Friberg, S. and Arvidsson, A. (1983) SEER-I: The semantic EEG evaluation regimen. *IEEE Transactions on Biomedical Engineering*, vol. BME-31, no. 4, pp. 239-244.

Cooper, R., Osselton, J. W. and Shaw, J. C. (1980) EEG Technology. 3<sup>rd</sup> Edition. Butterworth and Co. (Publishers) Ltd., London.

Davey, B. L. K., Fright, W. R., Carrol, G. J. and Jones, R. D. (1989) Expert system approach for the detection of epileptiform activity in the EEG. *Medical and Biological Engineering and Computing*, vol. 27, pp. 365-370.

Frost, Jr., J. D., Hillman, Jr., C. E. and Kellaway, P. (1980) Automatic interpretation of EEG: Analysis of background activity. *Comput. Biomed. Res.*, vol. 13, pp. 242-257.

Giese, D. A., Bourne, J. R. and Ward, J. W. (1979) Syntactic analysis of the electroencephalogram. *IEEE Transactions on Systems, Man, and Cybernetics*, vol. SMC-9, no. 8, pp. 429-435.

Glover, Jr., J. R., Ktonas, P. Y. and Jansen, B. H. (1990) Knowledge-based interpretation of bioelectrical signals. *IEEE Engineering in Medicine and Biology Magazine*, March, 51-54.



Gotman, J. and Gloor, P. (1976) Automatic recognition and quantification of interictal epileptic activity in the human scalp EEG. *Electroencephalography and clinical Neurophysiology*, vol. 41, pp. 513-529.

Hellyar, M. T. (1991) Investigation, Development and Application of Knowledge Based Digital Signal Processing Methods for Enhancing Human EEGs. PhD Thesis, Polytechnic South West, Plymouth, Devon.

Ifeachor, E. C., Hellyar, M. T., Mapps, D. J. and Allen, E. M. (1990) Knowledge-based enhancement of human EEG signals. *IEE Proceedings*, vol. 137, pt. F, no. 5, pp. 302-310.

Jagannathan, V., Bourne, J. R., Jansen, B. H. and Ward, J. W. (1982) Artificial intelligence methods in quantitative electroencephalogram analysis. *Computer Programs in Biomedicine*, vol. 15, pp. 249-258.

Kiloh, L. G., McComas, A. J., Osselton, J. W. and Upton, A. R. M. (1981) *Clinical Electroencephalography*. 4<sup>th</sup> Edition. Butterworths and Co. (Publishers) Ltd., London.

Ktonas, P. Y. (1983) Automated analysis of abnormal electroencephalograms. *CRC Critical Reviews in Biomedical Engineering*, vol. 9, pp. 39-97.

MacGillivray, B. B. and Wadbrook, D. G. (1975) A system for extracting a diagnosis from the clinical EEG. In: Dolce, G. and Kunkel, H. (Eds.) CEAN - Computerised EEG analysis. Gustav Fisher Verlag, Stuttgart. pp. 344-364.

Pradhan, N., Narayana, D. N., and Satyam, S. (1993) A mimetic-based frequency domain technique for automatic generation of EEG reports. *Computers in Biology and Medicine*, vol. 23, no. 1, pp. 15-20.

Swets, J. A. (1988) Measuring the accuracy of diagnostic systems. *Science*, June, pp. 1285-1293.

Visser, S. L. (1991) The electroencephalogram and evoked potentials in normal and ageing dementia. *Event-Related Brain Research* (EEG Suppl. 42).

Wu, J., Ifeachor, E. C., Allen, E. M., Wimalaratna, S. K. and Hudson, N. R. (1997) Intelligent artefact identification in electroencephalography signal processing. *IEE Proceedings - Science, Measurement and Technology*, (accepted for publication).

Zadeh, L. A. (1975a) The concept of a linguistic variable and its application to approximate reasoning-I. *Information Sciences*, vol. 8, pp. 199-249.

Zadeh L. A. (1975b) The concept of a linguistic variable and its application to approximate reasoning-II. *Information Sciences*, vol. 8, pp. 301-357.

Zadeh L. A. (1975c) The concept of a linguistic variable and its application to approximate reasoning-III. *Information Sciences*, vol. 9, pp. 43-80.

## 2. Principles of fuzzy logic

---

### 2.1 Introduction

In this chapter, fuzzy logic, a methodology for managing uncertain and imprecise information is reviewed with regard to providing a suitable framework for capturing the underlying decision processes which are used by the clinical experts. In particular, the chapter reviews two important concepts to fuzzy logic, namely, 'linguistic variables', a methodology for representing qualitative propositions such as *age is young*, *car is fairly slow*, *amplitude is low* etc. and 'approximate reasoning', a framework for inferring qualitative deductions, such as *low*, *small*, *large* etc., and for managing uncertainty expressed naturally, such as *very*, *somewhat*, *extremely* etc. (Zadeh 1975a, 1975b, 1975c).

### 2.2 Ordinary set theory

To introduce some of the concepts and notation which will be used throughout this chapter, this section provides a brief overview of ordinary set theory (Halmos 1960).

### 2.2.1 Ordinary sets

Conventionally, the symbols used to denote a set and an element in a set are upper case letters and lower case letters respectively. For example, to represent the set of all positive integers, the terminology shown in Equation 1 is used.

$$\begin{aligned} U &= \{u \mid u \text{ is integer, } u \geq 0\} \\ &= \{0, 1, 2, 3, \dots\} \end{aligned} \tag{1}$$

which reads  $U$  is the set of numbers  $u$  such that  $u$  is integer and  $u$  is greater or equal to 0. If in an application, all sets are subsets of a fixed set  $U$ , then  $U$  is regarded as a universal set. For example, Equation 2 is used to represent the subset of numbers in  $U$  which are greater than 1.

$$\begin{aligned} X &= \{x \mid x > 1, x \in U\} \\ &= \{2, 3, 4, 5, \dots\} \end{aligned} \tag{2}$$

which reads  $X$  is the set of numbers  $x$  such that  $x$  is greater than 1 and is a member of  $U$ .

### 2.2.2 Ordinary set relations

Relations in set theory are used to represent relationships between elements of two sets, e.g. a proposition such as  $x$  is older than  $y$  is a relation, if  $x$  and  $y$  are set elements. Often a relation is denoted by  $R$ . The solution set for a relation  $R$  is the set of  $(x, y)$  pairs that satisfy the relation.

For example,

$$A = \{1, 2, 3, 4\} \quad (3)$$

$$B = \{1, 3, 5\} \quad (4)$$

$$\begin{aligned} R &= \{(x, y) \mid x \in A, y \in B, x < y\} \\ &= \{(1, 3), (1, 5), (2, 3), (2, 5), (3, 5), (4, 5)\} \end{aligned} \quad (5)$$

### 2.2.3 Ordinary set composition

The composition of two relations  $R_1$  and  $R_2$ , denoted  $R_2 \circ R_1$ , gives a new relation  $R_3$ , where  $R_1$  is a relation from  $A$  to  $B$ , and  $R_2$  is a relation from  $B$  to  $C$  and  $R_3$  gives the relation from  $A$  to  $C$ . In the example below, composition is used to represent the new relation *a is a nephew of c*, given the relation *a is a son of b* and *b is a brother of c*.

$$A = \{\text{Steve, Nick, Gary}\} \quad (6)$$

$$B = \{\text{John, Nigel, Dennis}\} \quad (7)$$

$$C = \{\text{Stanley, Stuart, Jim}\} \quad (8)$$

$$\begin{aligned} R_1 &= \{(a, b) \mid a \in A, b \in B, a \text{ is a son of } b\} \\ &= \{(\text{Steve, John}), (\text{Nick, Nigel}), (\text{Gary, Dennis})\} \end{aligned} \quad (9)$$

$$\begin{aligned} R_2 &= \{(b, c) \mid b \in B, c \in C, b \text{ is a brother of } c\} \\ &= \{(\text{John, Stanley}), (\text{Nigel, Stuart}), (\text{Dennis, Jim})\} \end{aligned} \quad (10)$$

$$\begin{aligned} R_2 \circ R_1 &= \{(a, c) \mid (a, b) \in R_1, (b, c) \in R_2\} \\ &= \{(\text{Steve, Stanley}), (\text{Nick, Stuart}), (\text{Gary, Jim})\} \\ &= \{(a, c) \mid a \in A, c \in C, a \text{ is a nephew of } c\} \end{aligned} \quad (11)$$



## 2.3 Linguistic variables

### 2.3.1 Fuzzy sets

There are many instances when membership of an object to a set is neither completely inclusive nor exclusive, for example, the number 8 to the class of numbers *much greater than 1*. These imprecisely defined classes play an important role in human thinking (Komatsu 1992).

To deal with classes of this type, the concept of the fuzzy set was devised (Zadeh 1968). A fuzzy set is a class that allows not just two grades of membership, inclusive or exclusive, but a continuum from 0 and 1. For example, let  $U$  be the universe of positive integers. The fuzzy set to represent the class of numbers much greater than 1 might be characterised as follows.

$$\begin{aligned} A &= \{a \mid a \in U, a \text{ is much greater than } 1\} \\ &= \left\{ \begin{array}{l} 0/0 + 0/1 + 0.031/2 + 0.125/3 + 0.281/4 + 0.5/5 + 0.719/6 + 0.875/7 \\ + 0.969/8 + 1/9 + 1/10 + \dots \end{array} \right\} \end{aligned} \tag{12}$$

The notation in Equation 12 specifies the degree of membership denoted  $\mu(a)$  of  $a$  to the set  $A$  in the format  $\mu(a)/a$ , where each term is separated by the symbol '+'. Plotting the membership values  $\mu(a)$  on the axis  $U$ , gives the membership function, shown in Figure 8, for positive integers *much greater than 1*.

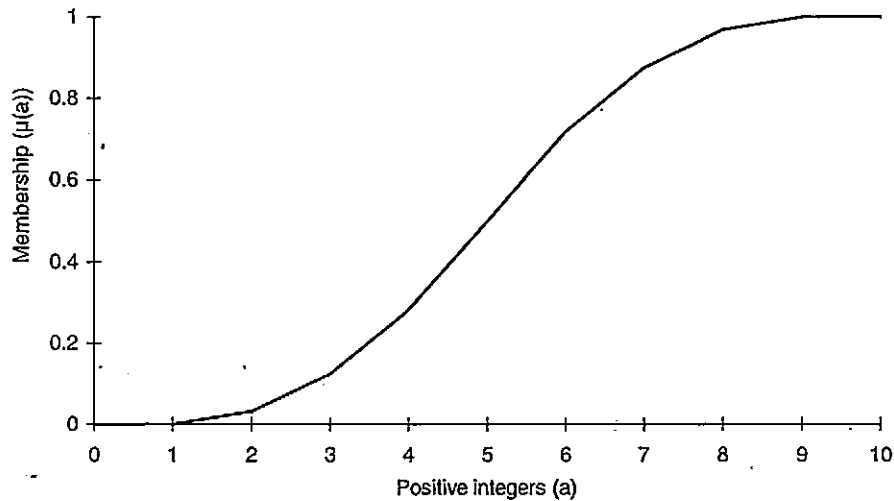


Figure 8. Membership function to represent the class of numbers 'much greater than 1'.

### 2.3.2 Linguistic variables, hedges and connectives

In humanistic systems such as in the fields of artificial intelligence, medical diagnosis and pattern recognition, much of the information is expressed in terms of linguistic variables i.e. variables whose values are words in a natural language. For example *age* is a linguistic variable if its values are linguistic such as *young*, *not young*, *very young*, *quite young*, *old*, *not very old*, *not very young* etc. (Zadeh 1975a, 1975b and 1975c). In Figure 9, membership functions have been defined to represent the linguistic values *young* and *old*.

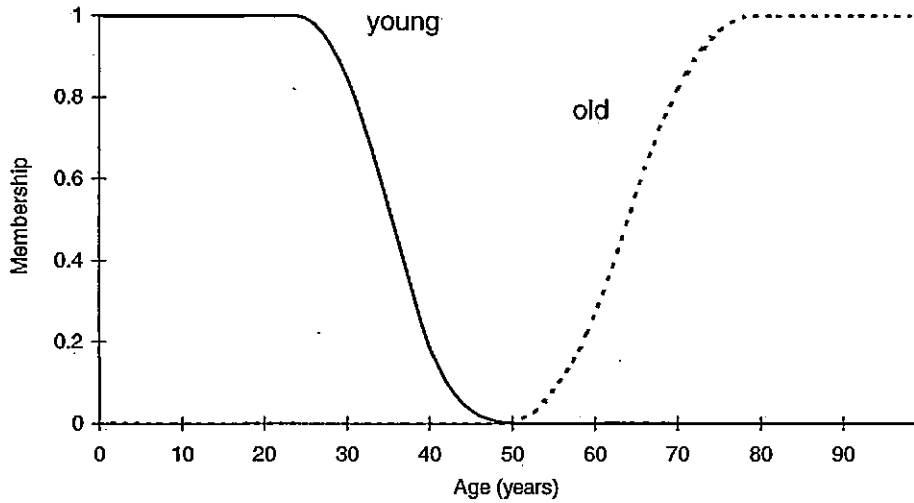


Figure 9. Membership functions for 'young' and 'old' to represent values of the linguistic variable 'age'.

Given a linguistic value such as *young*, additional values may be derived using 'hedges'. Hedges are operators such as *very*, *somewhat*, *indeed* which change the meaning of a fuzzy set typically by increasing or reducing vagueness using operations such as 'concentration', 'dilation' and 'intensification'. These operations are defined in Equations 13 - 15 (Zadeh 1972). Figure 10 illustrates these operations when used as hedges.

$$\text{concentration} = \text{very} = \mu(a)^2 \quad (13)$$

$$\text{dilation} = \text{somewhat} = \mu(a)^{0.5} \quad (14)$$

$$\text{intensification} = \text{indeed} = \begin{cases} 2\mu(a)^2 & \text{when } 0 \leq \mu(a) \leq 0.5 \\ 1 - 2(1 - \mu(a))^2 & \text{when } 0.5 < \mu(a) \leq 1 \end{cases} \quad (15)$$

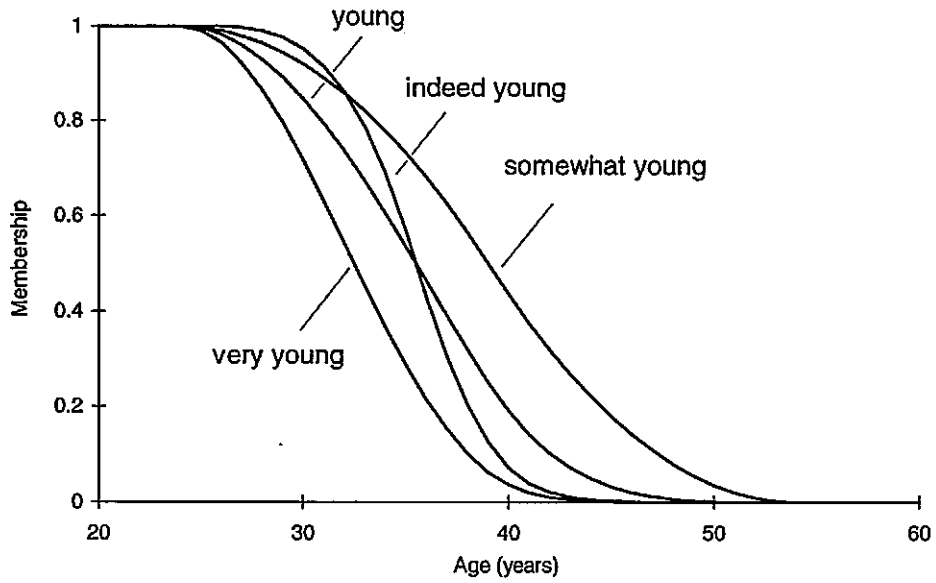


Figure 10. Hedge operations: 'very', 'somewhat' and 'indeed' on the linguistic value 'young'.

Values can also be combined to produce new values using the fuzzy set operations 'intersection', 'union' and 'complementation'. These operations are defined in Equations 16 - 18. Figure 11 illustrates the use of these operations.

$$\textit{intersection} = \textit{and} = \min(\mu(a), \mu(b)) \quad (16)$$

$$\textit{union} = \textit{or} = \max(\mu(a), \mu(b)) \quad (17)$$

$$\textit{complementation} = \textit{not} = 1 - \mu(a) \quad (18)$$

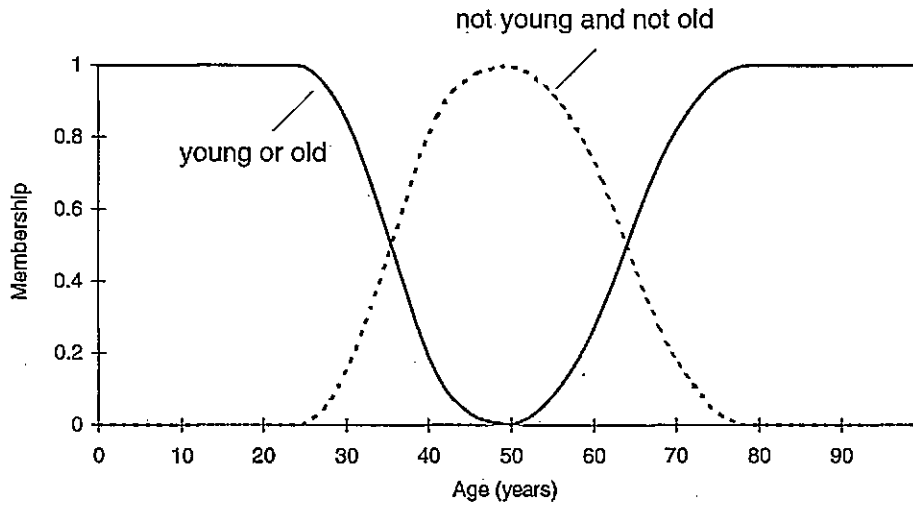


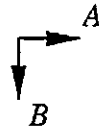
Figure 11. Combining linguistic values using the fuzzy set operations 'intersection', 'union' and 'complementation'.

## 2.4 Approximate reasoning

### 2.4.1 Fuzzy set relations

In section 2.2.2, crisp relations were described which represent association between the elements of two or more sets. This concept has been generalised in fuzzy set theory, to allow for various degrees of association (Zadeh 1968). In the example which follows, a fuzzy relation is defined to represent the relation *a is approximately b*. Let  $A$  and  $B$  be universes of integers ranging from 0 to 4, and let  $R(a,b)$  be defined as *a is approximately b*, where

$$\begin{aligned}
R(a,b) &= \{ \mu(a,b)/(a,b) \mid a \in A, b \in B, a \text{ is approximately } b \} \\
&= \{ 1/(0,0) + 0.5/(1,0) + 0/(2,0) + \dots \} \\
&= \begin{bmatrix} 1 & 0.5 & 0 & 0 & 0 \\ 0.5 & 1 & 0.5 & 0 & 0 \\ 0 & 0.5 & 1 & 0.5 & 0 \\ 0 & 0 & 0.5 & 1 & 0.5 \\ 0 & 0 & 0 & 0.5 & 1 \end{bmatrix}
\end{aligned}
\tag{19}$$



In this example the membership value  $\mu(a,b)$  is subjectively selected to describe the relationship between  $x$  and  $y$ . The matrix in the example provides an alternative representation of a binary relation. In this case the  $x$  co-ordinate represents the universe  $A$  for the variable  $a$  (from left to right), the  $y$  co-ordinate represents universe  $B$  for the variable  $b$  (from top to bottom) and the matrix values represent the membership values for each  $(a,b)$  pair. Other examples of fuzzy relations might be *much greater than*, *less experienced than*, *resembles* etc. Note that membership functions are often in part, determined arbitrarily. For example, the membership values defined in the example for *a is approximately b*, were set intuitively.

#### 2.4.2 Inference using binary fuzzy relations

Given a fuzzy relation  $R(a,b)$  between sets  $A$  and  $B$  and a fuzzy relation  $R(b,c)$  between sets  $B$  and  $C$ , the composition of  $R(a,b)$  and  $R(b,c)$  determines the relation between  $A$  and  $C$  (Zadeh 1968). In the example which follows, the relations *a is approximately b* and *b is more or less smaller than c* are composed to determine the relation *a is approximately more or less smaller than c*. Let  $A, B$

and  $C$  be universes of integers ranging from 0 to 4 and let  $R(a,b)$  be defined as  $a$  is approximately  $b$ , where

$$\begin{aligned}
 R(a,b) &= \{ \mu(a,b)/(a,b) \mid a \in A, b \in B, a \text{ is approximately } b \} \\
 &= \{ 1/(0,0) + 0.5/(1,0) + 0/(2,0) + \dots \} \\
 &= \begin{bmatrix} 1 & 0.5 & 0 & 0 & 0 \\ 0.5 & 1 & 0.5 & 0 & 0 \\ 0 & 0.5 & 1 & 0.5 & 0 \\ 0 & 0 & 0.5 & 1 & 0.5 \\ 0 & 0 & 0 & 0.5 & 1 \end{bmatrix}
 \end{aligned} \tag{20}$$

Let  $R(b,c)$  be defined as  $b$  is more or less smaller than  $c$ , where

$$\begin{aligned}
 R(b,c) &= \{ \mu(b,c)/(b,c) \mid b \in B, c \in C, b \text{ is more or less smaller than } c \} \\
 &= \{ 0.75/(0,0) + 0.5/(1,0) + 0.25/(2,0) + \dots \} \\
 &= \begin{bmatrix} 0.75 & 0.5 & 0.25 & 0 & 0 \\ 1 & 0.75 & 0.5 & 0.25 & 0 \\ 1 & 1 & 0.75 & 0.5 & 0.25 \\ 1 & 1 & 1 & 0.75 & 0.5 \\ 1 & 1 & 1 & 1 & 0.7 \end{bmatrix}
 \end{aligned} \tag{21}$$

Finally, let  $R(a,c)$  be defined as the composition of  $R(a,b)$  with  $R(b,c)$ , denoted

$R(a,b) \circ R(b,c)$ , where

$$\begin{aligned}
R(a,c) &= R(a,b) \circ R(b,c) \\
&= \left\{ \max_b (\min(\mu(a,b), \mu(b,c))) / (a,c) \right. \\
&\quad \left. \left| \mu(a,b) / (a,b) \in R(a,b), \mu(b,c) / (b,c) \in R(b,c) \right. \right\} \\
&= \{0.75/(0,0) + 0.5/(1,0) + 0.5/(2,0) + \dots\} \\
&\quad \circ \{1/(0,0) + 0.5/(1,0) + 0/(2,0) + \dots\} \\
&= \begin{bmatrix} 0.75 & 0.5 & 0.25 & 0 & 0 \\ 1 & 0.75 & 0.5 & 0.25 & 0 \\ 1 & 1 & 0.75 & 0.5 & 0.25 \\ 1 & 1 & 1 & 0.75 & 0.5 \\ 1 & 1 & 1 & 1 & 0.75 \end{bmatrix} \circ \begin{bmatrix} 1 & 0.5 & 0 & 0 & 0 \\ 0.5 & 1 & 0.5 & 0 & 0 \\ 0 & 0.5 & 1 & 0.5 & 0 \\ 0 & 0 & 0.5 & 1 & 0.5 \\ 0 & 0 & 0 & 0.5 & 1 \end{bmatrix} \\
&= \begin{bmatrix} 0.75 & 0.5 & 0.5 & 0.25 & 0 \\ 1 & 0.75 & 0.5 & 0.5 & 0.25 \\ 1 & 1 & 0.75 & 0.5 & 0.5 \\ 1 & 1 & 1 & 0.75 & 0.5 \\ 1 & 1 & 1 & 1 & 0.75 \end{bmatrix} \\
&= \{0.75/(0,0) + 0.5/(1,0) + 0.5/(2,0) + \dots\} \\
&= \left\{ \mu(a,c) / (a,c) \right. \\
&\quad \left. \left| a \in A, c \in C, a \text{ is approximately more or less smaller than } c \right. \right\} \tag{22}
\end{aligned}$$

Here the membership values for the new relation between  $A$  and  $C$  are determined by  $\max_b (\min(\mu(a,b), \mu(b,c)))$  which reads the maximum over the domain  $b$  of the minimum of the membership values  $\mu(a,b)$  and  $\mu(b,c)$ . In this case, the operation is simply the matrix product between  $\mu(b,c)$  and  $\mu(a,b)$  but where the multiplication and addition have been replaced by minimum and maximum operations respectively (Zadeh 1973).



### 2.4.3 Inference using multi-dimensional relations

In the previous section, composition was shown to infer the new relation  $R(a,c)$  given the relations  $R(a,b)$  and  $R(b,c)$ . These relations are called binary because they map from one domain to another. Relations can also be  $n$ -ary, mapping from  $x$  domains to  $y$  domains. Relations can also be *unary*, mapping in a single domain. For example, the fuzzy set *young* can be seen as a unary relation in the domain *age*. When a unary relation  $R(a)$  is composed with a binary relation  $R(a,b)$ , the result is  $R(b)$ , the unary relation which can be inferred (Zadeh 1973 and 1975c). In the example which follows, the relation *a is small* and *a is approximately b* are composed to determine the relation *b is more or less small*. Let  $A$  and  $B$  be universes of integers ranging from 0 to 5, let  $R(a)$  be defined as *a is small*, and let  $R(a,b)$  be defined as *a is approximately b*, where

$$\begin{aligned}
 R(a) &= \{ \mu(a)/a \mid a \in A, a \text{ is small} \} \\
 &= \{ 1/0 + 0.9/1 + 0.8/2 + 0.5/3 + 0.2/4 + 0.1/5 \}
 \end{aligned}
 \tag{23}$$

$$\begin{aligned}
 R(a,b) &= \{ \mu(a,b)/(a,b) \mid a \in A, b \in B, a \text{ is approximately } b \} \\
 &= \{ 1/(0,0) + 0.5/(1,0) + 0/(2,0) + \dots \}
 \end{aligned}
 \tag{24}$$

$$= \begin{bmatrix} 1 & 0.5 & 0 & 0 & 0 & 0 \\ 0.5 & 1 & 0.5 & 0 & 0 & 0 \\ 0 & 0.5 & 1 & 0.5 & 0 & 0 \\ 0 & 0 & 0.5 & 1 & 0.5 & 0 \\ 0 & 0 & 0 & 0.5 & 1 & 0.5 \\ 0 & 0 & 0 & 0 & 0.5 & 1 \end{bmatrix}$$

Finally, let  $R(b)$ , the set approximately equal to  $R(a)$ , be defined as the composition of  $R(a)$  with  $R(a,b)$ , denoted  $R(a) \circ R(a,b)$ , where

$$\begin{aligned}
 R(b) &= R(a) \circ R(a,b) \\
 &= \{1/0 + 0.9/1 + 0.8/2 + 0.5/3 + 0.2/4 + 0.1/5\} \\
 &\quad \circ \{1/(0,0) + 0.5/(1,0) + 0/(2,0) + \dots\} \\
 &= \begin{bmatrix} 1 & 0.5 & 0 & 0 & 0 & 0 \\ 0.5 & 1 & 0.5 & 0 & 0 & 0 \\ 0 & 0.5 & 1 & 0.5 & 0 & 0 \\ 0 & 0 & 0.5 & 1 & 0.5 & 0 \\ 0 & 0 & 0 & 0.5 & 1 & 0.5 \\ 0 & 0 & 0 & 0 & 0.5 & 1 \end{bmatrix} \circ \begin{bmatrix} 1 \\ 0.9 \\ 0.8 \\ 0.5 \\ 0.2 \\ 0.1 \end{bmatrix} \\
 &= \max_u (\min(\mu(a), \mu(a,b))) / b \\
 &= [1 \ 0.9 \ 0.8 \ 0.5 \ 0.5 \ 0.2] \\
 &= \{1/0 + 0.9/1 + 0.8/2 + 0.5/3 + 0.5/4 + 0.2/5\}
 \end{aligned} \tag{25}$$

which may be approximated as *more or less small*.

#### 2.4.4 Inference using fuzzy rules

The previous section showed that composition can be used to infer a unary relation  $R(b)$  given a unary relation  $R(a)$  and a binary relation  $R(a,b)$ . When  $R(a,b)$  represents the conditional, such as *if a is small then b is large* a fuzzy rule-based system is defined. Constructing the membership function for the conditional is partly dependent on the application and partly on multi-valued logic theory (see Appendix A) (Whalen and Schott 1983, 1985). In the example which follows, the conditional,  $R(a,b)$ , is defined according to Lukasiewicz's multi-valued logic implication operator. In the example, the relations *a is more or less small* and *if a is small then b is large* are composed to determine the relation *b is more or less large*. Let  $A$  and  $B$  be universes of integers ranging from 0 to 5, let  $R(a)$  be

defined as *a is small*, let  $R(b)$  defined as *b is large*, let  $R(a,b)$  be defined as *if a is small then b is large*, and let  $R'(a)$  be defined as *a is more or less small*, where

$$\begin{aligned} R(a) &= \{\mu(a)/a \mid a \in A, a \text{ is small}\} \\ &= \{1/0 + 0.9/1 + 0.8/2 + 0.5/3 + 0.2/4 + 0.1/5\} \end{aligned} \quad (26)$$

$$\begin{aligned} R(b) &= \{\mu(b)/b \mid b \in B, b \text{ is large}\} \\ &= \{0.1/0 + 0.2/1 + 0.5/2 + 0.8/3 + 0.9/4 + 1/5\} \end{aligned} \quad (27)$$

$$\begin{aligned} R(a,b) &= \{\mu(a,b)/(a,b) \mid a \in A, b \in B, \min(1, 1 - \mu(a) + \mu(b))\} \\ &= \{0.1/(0,0) + 0.2/(1,0) + 0.3/(2,0) + \dots\} \\ &= \begin{bmatrix} 0.1 & 0.2 & 0.3 & 0.6 & 0.9 & 1 \\ 0.2 & 0.3 & 0.4 & 0.7 & 1 & 1 \\ 0.5 & 0.6 & 0.7 & 1 & 1 & 1 \\ 0.8 & 0.9 & 1 & 1 & 1 & 1 \\ 0.9 & 1 & 1 & 1 & 1 & 1 \\ 1 & 1 & 1 & 1 & 1 & 1 \end{bmatrix} \end{aligned} \quad (28)$$

$$\begin{aligned} R'(a) &= \{\mu(a)/a \mid a \in A, a \text{ is more or less small}\} \\ &= \{1/0 + 0.9/1 + 0.9/2 + 0.7/3 + 0.4/4 + 0.3/5\} \end{aligned} \quad (29)$$

Finally, let  $R'(b)$ , the set which can be inferred from the fact  $R'(a)$  and the rule  $R(a,b)$ , be defined as the composition of  $R'(a)$  with  $R(a,b)$ , denoted  $R'(a) \circ R(a,b)$ , where

$$\begin{aligned}
R'(b) &= R'(a) \circ R(a, b) \\
&= \{1/0 + 0.9/1 + 0.9/2 + 0.7/3 + 0.4/4 + 0.3/5\} \\
&\quad \circ \{0.1/(0,0) + 0.2/(1,0) + 0.3/(2,0) + \dots\} \\
&= \begin{bmatrix} 0.1 & 0.2 & 0.3 & 0.6 & 0.9 & 1 \\ 0.2 & 0.3 & 0.4 & 0.7 & 1 & 1 \\ 0.5 & 0.6 & 0.7 & 1 & 1 & 1 \\ 0.8 & 0.9 & 1 & 1 & 1 & 1 \\ 0.9 & 1 & 1 & 1 & 1 & 1 \\ 1 & 1 & 1 & 1 & 1 & 1 \end{bmatrix} \circ \begin{bmatrix} 1 \\ 0.9 \\ 0.9 \\ 0.7 \\ 0.4 \\ 0.3 \end{bmatrix} \\
&= \max_a (\min(\mu(a), \mu(a, b))) / b \\
&= [0.6 \ 0.7 \ 0.7 \ 0.9 \ 0.9 \ 1] \\
&= \{0.6/0 + 0.7/1 + 0.7/2 + 0.9/3 + 0.9/4 + 1/5\}
\end{aligned} \tag{30}$$

which may be approximated to *more or less large*.

#### 2.4.5 Linguistic approximation

In applications where the fuzzy system is required to interact linguistically with the user, such as in applications that provide decision support, a linguistic output will be required. This would require the assignment of a linguistic label to a deduction which has been calculated by the fuzzy system. This process is called linguistic approximation. Fuzzy sets that represent standard linguistic values are compared to the deduction, and the fuzzy set with the greater measure of similarity is selected as the linguistic approximation. In Eshragh and Mamdani (1979), hedges, connectives and primary sets provided by the user are used to construct a library of linguistic values such as *not very low and not very high*. A search algorithm is then implemented to determine which linguistic value would provide the best approximation to a given deduction. It should be noted that this should not necessarily be the most exact because this might provide an excessive number

of connected linguistic terms which would produce a long, incomprehensible phrase. Often a compromise is selected between exactness and comprehensibility.

In Sugeno and Yasukawa (1993) the similarity between two fuzzy sets, denoted  $A(x)$  and  $B(x)$ , is calculated as a value between 0 and 1 using Equation 31. This equation can be used in linguistic approximation to calculate the similarity between a set whose meaning is not known and sets which have been pre-determined. To illustrate, Figure 12 shows a fuzzy set representing *age* but whose meaning is not known. In the figure are also fuzzy sets for ages *very young*, *young*, *indeed young* and *somewhat young*. An approximation can be made to the unknown fuzzy set by finding out which of the labels *very young*, *young*, *indeed young* and *somewhat young* are most similar. In this case, *somewhat young* has been found to be the most similar, followed by *very young*, *young* and *indeed young*, each with measures 0.717, 0.679, 0.675 and 0.643 respectively.

$$S(A(x), B(x)) = \frac{\sum_x \min(A(x), B(x))}{\sum_x \max(A(x), B(x))} \quad (31)$$

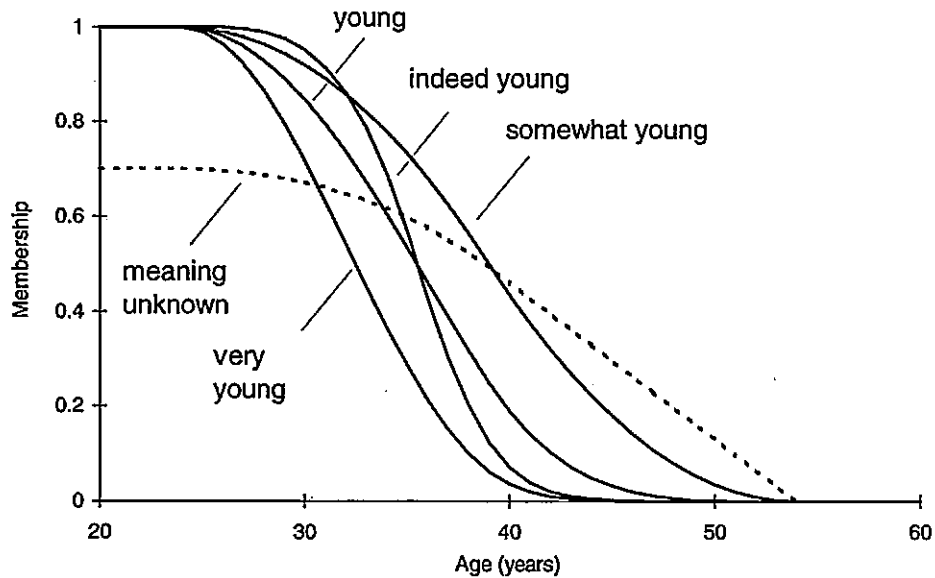


Figure 12. A library of pre-defined fuzzy sets for age and a fuzzy set whose exact meaning is unknown. Linguistic approximation finds from the library a meaning to which it approximates best.

## 2.5 Summary

In this chapter, two important concepts to fuzzy logic, namely linguistic variables and approximate reasoning have been reviewed. Linguistic variables were shown to provide a framework designed for quantifying qualitative propositions such as *age is young*, *temperature is neither hot nor cold*, *car is fairly slow* etc. Approximate reasoning was shown to be able to reason with fuzzy relations such as *x is approximately y*, *x is more or less small*, *x is much greater than y*, *x is extremely large* etc. A special case dealt with the conditional fuzzy relation such as *if the car is fast then the insurance risk is high*. This special case provides the basis for implementing fuzzy rule-based systems. Deductions made by

approximate reasoning implicitly represent uncertainty using the concept of partial membership. This uncertainty is made explicit by a process of linguistic approximation, where the closest approximation to the deduction is selected from a library of pre-defined terms.

## 2.6 References

Eshragh, F. and Mamdani, E. H. (1979) A general approach to linguistic approximation. *International Journal of Man-Machine Studies*, vol. 11, pp. 501-519.

Halmos, P. R. (1960) *Naïve Set Theory*. Van Nostrand Reinhold Co., New York.

Komatsu, L. K. (1992) Recent views of conceptual structure, *Psychological Bulletin*, vol. 112, no. 3, pp. 500-526.

Sugeno M and Yasukawa T. (1993) A fuzzy-logic-based approach to qualitative modelling. *IEEE Transactions on Fuzzy Systems*, vol. 1, no. 1, pp. 7-31.

Whalen, T. and Schott, B. (1983) Issues in fuzzy production systems. *International Journal of Man-Machine Studies*, vol. 19, pp. 57-71.

Whalen, T. and Schott, B. (1985) Alternative logics for approximate reasoning in expert systems: A comparative study. *International Journal of Man-Machine Studies*, vol. 22, pp. 327-346.

Zadeh L. A. (1968) Fuzzy sets. *Information and Control*, vol. 8, pp. 338-353.

Zadeh L. A. (1972) A fuzzy-set-theoretic interpretation of linguistic hedges. *Journal of Cybernetics*, vol. 3, no. 3, pp. 4-34.

Zadeh L. A. (1973) Outline of a new approach to the analysis of complex systems and decision processes. *IEEE Transactions on Systems, Man and Cybernetics*, vol. SMC-3, pp. 28-44.

Zadeh, L. A. (1975a) The concept of a linguistic variable and its application to approximate reasoning-I. *Information Sciences*, vol. 8, pp. 199-249.

Zadeh L. A. (1975b) The concept of a linguistic variable and its application to approximate reasoning-II. *Information Sciences*, vol. 8, pp. 301-357.

Zadeh L. A. (1975c) The concept of a linguistic variable and its application to approximate reasoning-III. *Information Sciences*, vol. 9, pp. 43-80.



## 3. Data collection

---

### 3.1 Introduction

Important to research in general is often the issue of data collection, and for this investigation in particular, data plays an important factor in the many stages of the programme. For example, to develop strategies to analyse the EEG, close collaboration with the experienced EEG expert is required. For this collaboration, conventional paper EEG recordings are necessary. Data is also required for the development and evaluation of automated analysis techniques by PC (personal computer). For this work, EEG data needs to be digitised. Data collection is also required for other current and future projects such as research in artefact processing.

The design of a system which acquires data from the auxiliary output of a conventional paper EEG recorder is described in this chapter. Data collection is thus integrated within the routine clinical procedure. To ensure reproducibility of the data collection procedures, data collection protocols and standardised data elicitation forms were used.

### 3.2 Data acquisition system specification

The machine used by the collaborative group for routine EEG recordings was the Medelec<sup>2</sup> 1121. This machine records on paper 21 EEG channels plus an additional channel for other recording information. The machine provides an auxiliary output which provides 0.1V per 1mm pen deflection for each of the 21 EEG channels and the additional information channel. Pen deflection range is 28mm peak to peak which gives an auxiliary output range from -1.4V to +1.4V.

To represent the bandwidth of the EEG which ranges from 0.5 to 60Hz (Binnie et al. 1982 p. 20), a sampling rate of greater than twice the highest frequency of interest is required to satisfy the sampling theorem, i.e. greater than 120Hz. Dynamic range is catered for by the resolution of the analogue to digital converter (ADC). For EEG voltages, a dynamic range of 70dB is adequate (Lesser et al. 1992). From Equation 32 (Ifeachor and Jervis 1993, pp. 26-29), a resolution of 11.627 i.e. 12 bits is therefore required.

$$Resolution (bits) = \log_2 10^{dynamic\ range(dB)/20} = \log_2 10^{3.5} = 11.627 \quad (32)$$

Finally, real time transfer to optical disk (a high volume storage medium), was performed by a PC. To allow adequate time for the PC to achieve this, the digitiser would require minimal central processing unit (CPU) time. The desired specification for the digitiser can now be summarised as follows:

---

<sup>2</sup> Medelec Ltd., Old Woking, Surrey, England.

- 22 analogue inputs
- greater than 120 Hz sampling frequency per input
- at least 12 bit ADC
- require minimal CPU time of PC.

### **3.3 Data acquisition system design**

To meet this specification, a data acquisition system was designed and integrated into the Department of Clinical Neurophysiology in Derriford Hospital, Plymouth. Figure 13 illustrates a conceptual diagram of the system. EEG data is taken from the auxiliary output of the recorder to the pre-processor, where the analogue signals are anti-alias filtered and amplified to the full range of the digitiser. The next stage then multiplexes the EEG into a single channel which is then sampled. This stage is carried out by a card which connects to the PC bus. Finally, real-time transfer of data from the digitiser to the optical archive disk is carried out using two alternating swap buffers.

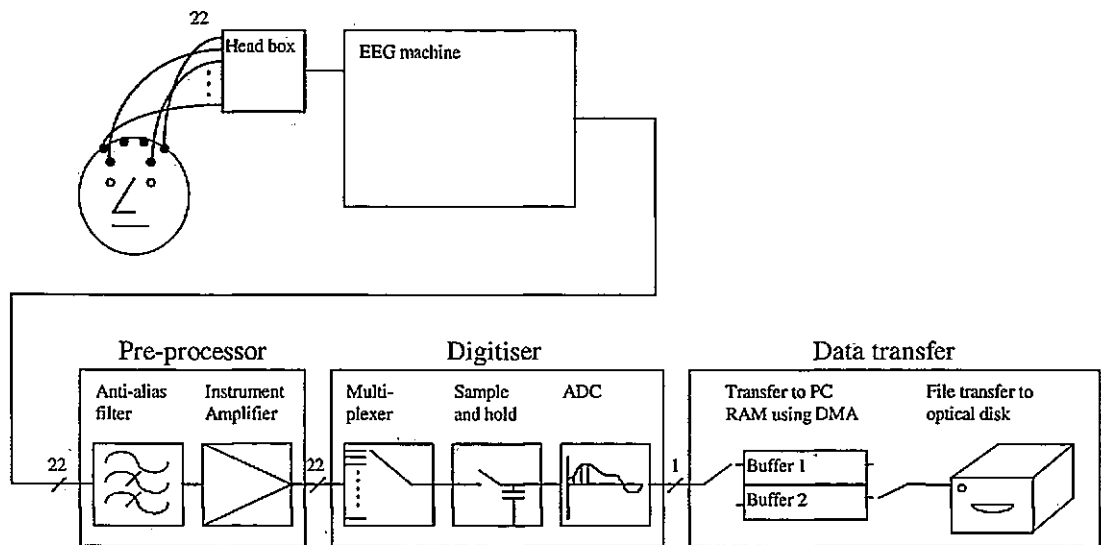


Figure 13. The EEG data acquisition system consists of three stages: pre-processing, digitisation and file transfer.

### 3.4 Pre-processing

To ensure signals that might exist outside the 60Hz bandwidth do not alias with the signal after sampling and to utilise the full range of the ADC, anti-alias filtering and amplification from  $\pm 1.4V$  to  $\pm 10V$  is required.

The selected anti-alias filter response was Butterworth to provide maximum flatness in the pass band. The fall-off near the cut-off frequency was also minimised by extending the pass band by 10Hz to 70Hz. The magnitude response for a Butterworth filter is calculated using Equation 33, and is shown in Figure 14.

$$H(f) = 20 \text{Log}_{10} \frac{1}{\sqrt{1 + \left(\frac{f}{f_c}\right)^{2n}}} \quad (33)$$

where  $n$  = filter order and  $f_c$  = cut off frequency.

The sampling frequency was selected to be 256Hz to be compatible with other work in the research group (Hellyar 1991).

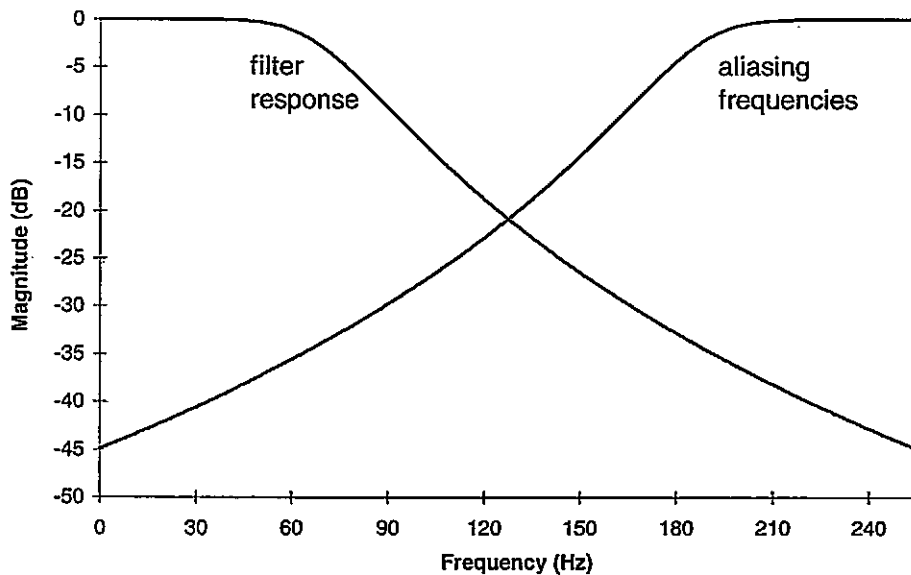


Figure 14. Anti-alias filter response.

To realise the filter, a voltage controlled voltage source (VCVS) circuit was used to minimise components needed (4 poles per operational amplifier) (Stanley 1984). The circuit, denormalised to 70Hz, and impedance scaled to suitable component values is shown in Figure 15. Operational amplifiers with low offset voltage and low power consumption are required to utilise the full range of the ADC and to economise on power supply unit cost. The OP-200GP and the OP-

400GP are dual and quad operational amplifiers with  $80\mu\text{V}$  offset voltage and low power consumption.

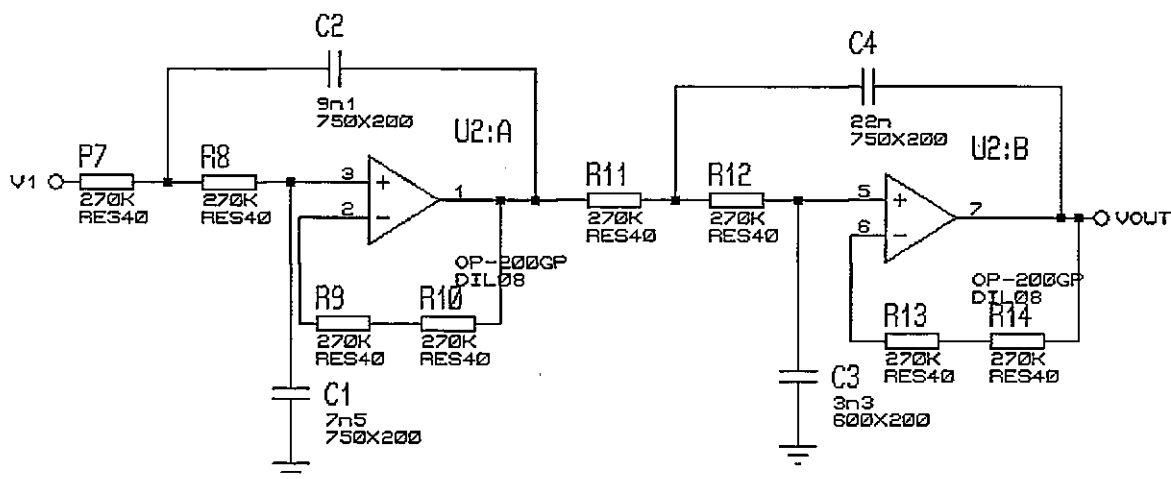


Figure 15. Anti-alias filter.

To amplify each channel by 7 from  $\pm 1.4\text{V}$  to  $\pm 10\text{V}$ , an instrumentation amplifier (Stanley 1984) was used. Instrumentation amplifiers provide adjustable gain with a single variable resistor, high common mode rejection ratio and high input impedance. The circuit used is given in Figure 16.

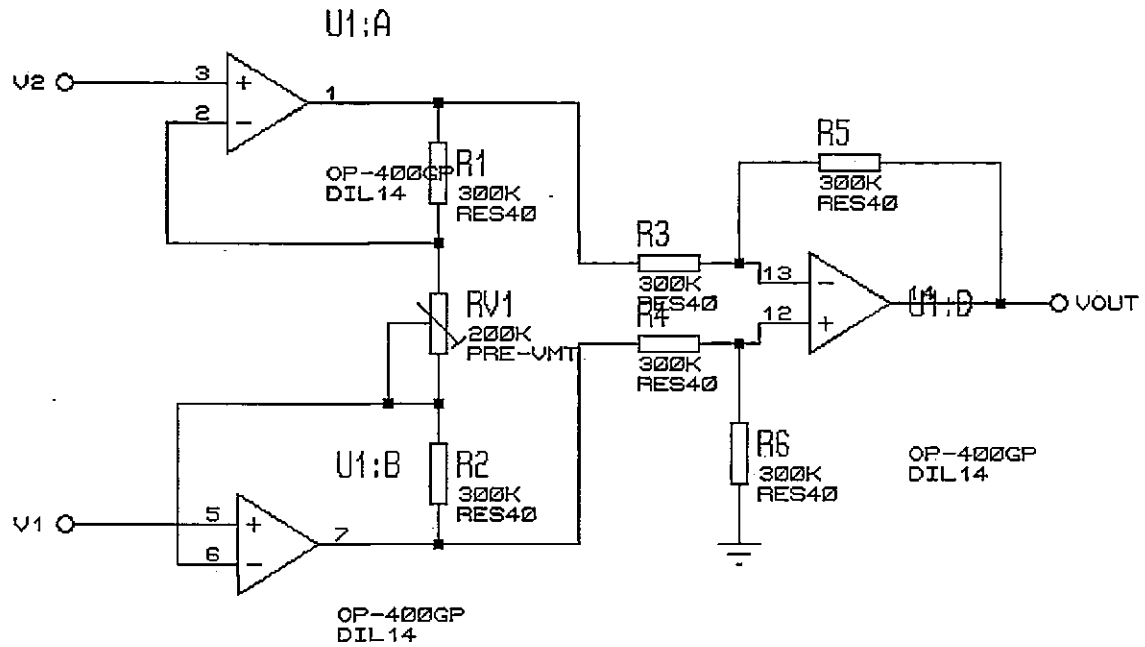
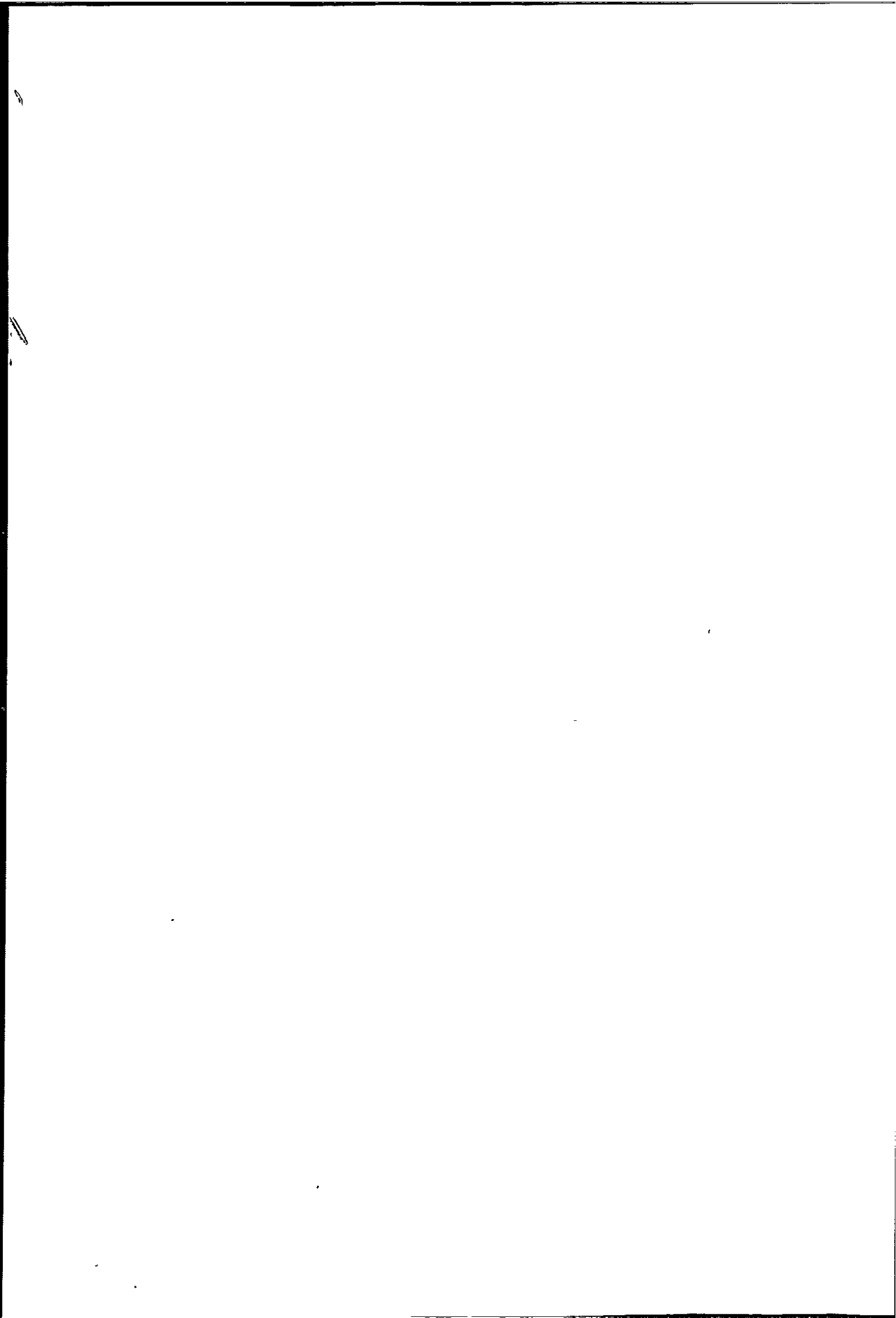


Figure 16. Instrumentation amplifier.

### 3.5 Digitisation

To meet the specification, the 16 channel PCI-20098C-2 data acquisition board from Intelligent Instrumentation<sup>3</sup> was used with a 32 channel PCI-20031M-1 input expander. These boards connect to the PC bus and provide the functions of multiplexing, sample and hold, ADC and data transfer to memory using either direct memory access (DMA), interrupt or polled modes. When used with a 80286, 12MHz PC, the boards provide 12 bit ADC for up to 48 inputs with a throughput rate of 100kHz (up to 4.545kHz per channel for 22 channels) and analogue input ranges of  $\pm 5V$ ,  $\pm 10V$  and 0-10V. Of the data transfer modes

<sup>3</sup> Intelligent Instrumentation Ltd., 2 Penn Place, Northway, Rickmansworth, Herts, England.





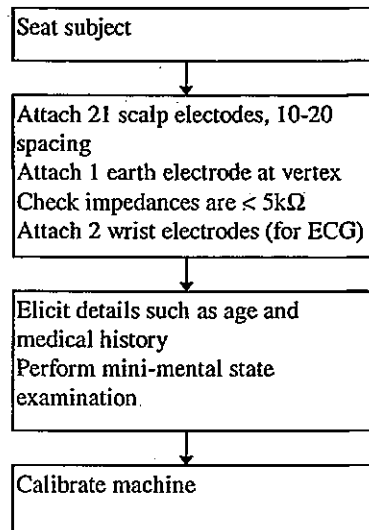
supported, interrupt and polled modes transfer data from external device to CPU and then CPU to memory. DMA mode bypasses the CPU and transfers data directly to memory using the DMA controller. This was the mode of transfer used so as to free the resources of the CPU for data transfer from memory to optical disk.

### **3.6 Data collection protocols**

Clinical electroencephalography covers many normal and abnormal conditions. Careful consideration was therefore necessary to determine which classes of subject were to be considered during the investigation. Given the importance of Alzheimer's disease, whose incidence has appeared to increase with life expectancy, and further, given that Alzheimer's and normal EEGs are largely characterised by background activities only (Visser et al. 1991), the investigation was confined to the background activities of the awake Alzheimer's EEG and awake, age-matched, normal controls.

The collection protocols which were adopted are shown in Figure 17, Figure 18 and Figure 19. In a routine EEG recording, the clinician will change 'montage' (montages specify the point of reference for each EEG channel and are used to visually enhance activity which is localised on the scalp - see Appendix B). In the common reference montage each channel measures electrical voltage between electrode and a common reference such as the ear lobe, whilst in bipolar montages, each channel measures electrical voltage between neighbouring electrodes. In digital recordings, any bipolar montage can be derived from a

reference montage. The reference montage was therefore selected in the recording protocols.



*Figure 17. Recording set-up and volunteer questioning.*

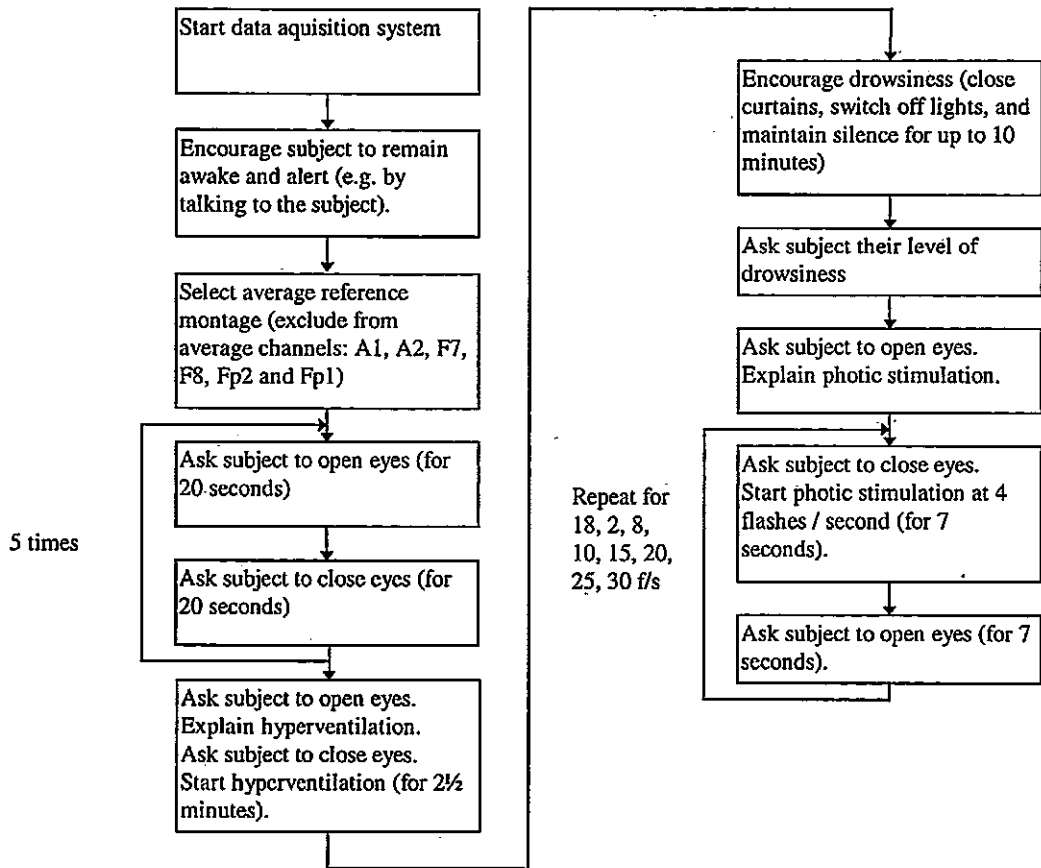


Figure 18. Protocol for the collection of EEG data.

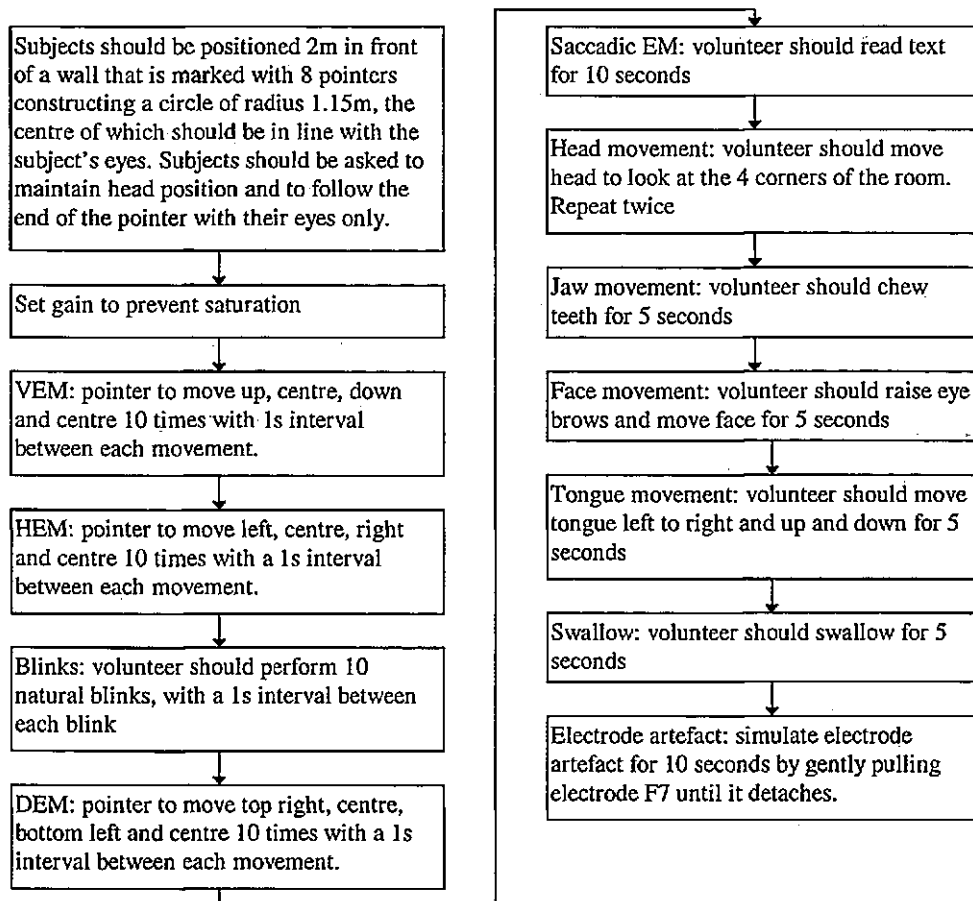


Figure 19. Protocol for the collection of different artefacts (modified from Hellyar (1991)).

In addition to certain abnormalities, the EEG is also sensitive to features which are normal such as age, sex, etc. For example, delta activity is expected in childhood, but is usually abnormal in adults. Details such as these were recorded from each subject using the form in Figure 20.

<b>Patient Details</b>	
Initials:	_____
DOB:	_____
Sex:	_____
Medical history (e.g. birth injury or head injury):	_____ _____ _____
Recent events which may effect the EEG (e.g. fits or fainting):	_____ _____ _____
L/R Handed?:	_____
Time since last meal:	_____
Medication:	_____ _____ _____

*Figure 20. Standardised form for the elicitation of patient details.*

Screening criteria for the normal controls was necessary to ensure the subjects were typical of the normal population. Alzheimer's disease can occur in ages as early as 40, therefore the normals, which are age-matched to Alzheimer's patients, were screened for ages 40 and above. Normals having a medical history, medication or occurrence of events such as fainting or fits which may effect the EEG were also rejected. Finally, normals were screened for mental state using the 'mini-mental state assessment' by Folstein et al. (1975). The assessment measures cognitive aspects of mental functions such as orientation, registration, attention

and calculation, recall and language, using the form shown in Figure 21. Instructions for using this form are given in Appendix C. The mental state score for normals is 24 or greater. Therefore, the screening criteria for the normal controls was to reject volunteers with a score less than 24.

Mini-mental state assessment		
		Patient: _____
		Examiner: _____
		Date: _____
Maximum Score	Score	
		Orientation
5	( )	What is the (year) (season) (date) (day) (month)?
5	( )	Where are we: (country) (county) (city) (hospital) (floor).
		Registration
3	( )	Name 3 objects: 1 second to say each. Then ask the patient all 3 after you have said them. Give 1 point for each correct answer. Then repeat them until he learns all 3. Count trials and record. Trials:
		Attention and Calculation
5	( )	Serial 7's (93,86,79,72,65). 1 point for each correct. Stop after 5 answers. Alternatively spell "world" backwards.
		Recall
3	( )	Ask for the 3 objects repeated above. Give 1 point for each correct.
		Language
9	( )	Name a pencil, and watch (2 points). Repeat the following "No ifs, ands or buts." (1 point) Follow 3-stage command (3 points): "Take a paper in your right hand, fold it in half, and put it on the floor" Read and obey the following (1 point): CLOSE YOUR EYES. Write a sentence (1 point). Copy design (1 point).
		Total score
		ASSESS level of consciousness along a continuum:
		Alert   Drowsy   Stupor   Coma

Figure 21. Standardised form for performing the mini-mental state assessment.

### 3.7 Data collection

Volunteers for the normal control subject group were recruited by a letter sent to family and colleagues of the author. At present EEGs from eight volunteers<sup>4</sup> have been collected.

Since April 1995, the Dept. of Neurophysiology at Derriford Hospital, Plymouth, has used the Bio-logic<sup>5</sup> Ceegraph SE (a computer network of recording and reading stations and an EEG data archive) for conventional EEG recordings. The system provided the data for the abnormal subject group. EEGs from three patients which were provisionally diagnosed as having Alzheimer's disease by clinical examination at the Plymouth Community Healthcare Trust and whose EEGs were subsequently found to be in keeping with the disease by EEG assessment at the Dept. of Neurophysiology, were selected by searching the centralised patient information system at the hospital. Details for carrying out this search are given in Appendix D.

The storage formats for both the data acquisition system and Ceegraph system are given in Appendix E.

---

<sup>4</sup> The mini-mental state was not introduced into the protocol until after volunteer #6.

<sup>5</sup> Bio-logic, Astley House, Cromwell Park, Chipping Norton, Oxon, England.

### 3.8 Summary

In order to acquire sufficient data, in a controlled environment, a data acquisition system and data collection protocols were developed and integrated within the hospital environment. This provided a database of normal and abnormal EEG signals and EEGs with different types of artefacts for developing and evaluating EEG analysis and artefact processing techniques. Careful consideration was necessary to determine which types of EEG will be used during the investigation. Given the importance of Alzheimer's disease, and that the Alzheimer's and normal EEGs are largely characterised by background activities only (Visser et al. 1991), the investigation was restricted for practical reasons to the Alzheimer's EEG and age-matched normal controls. This chapter described the design and implementation of the data acquisition system and the controlled collection protocols.

### 3.9 References

Binnie, C. D., Rowan, A. J. and Gutter, T. H. (1982) *A Manual of Electroencephalographic Technology*. Cambridge University Press, Cambridge.

Folstein, M., Folstein, S. and McHugh, P. R. (1975) Mini-mental state: A practical method for grading the cognitive state of patients for the clinician. *J. Psychiatric Res.*, Vol. 12, pp. 189-98.



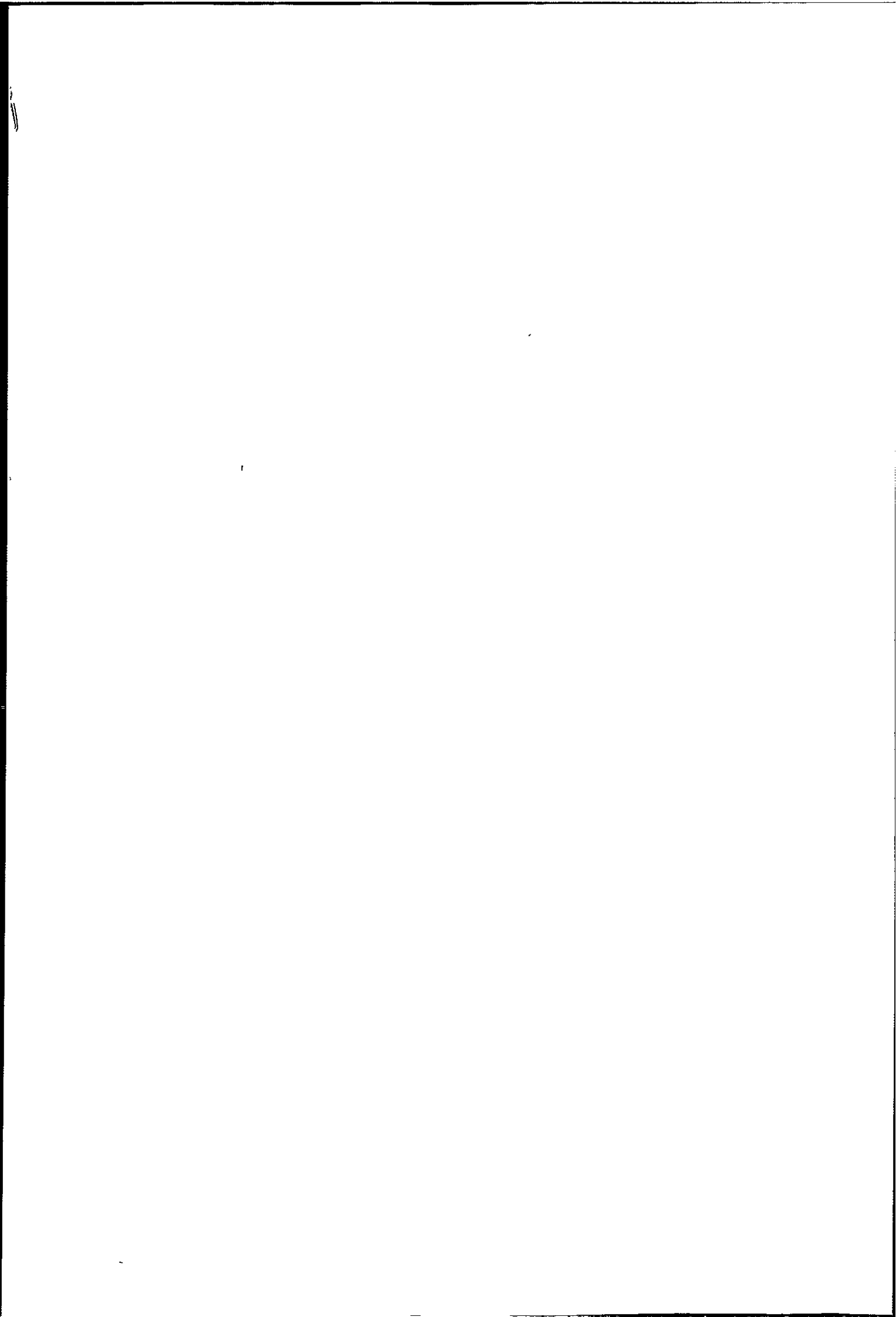
Hellyar, M. T. (1991) Investigation, Development and Application of Knowledge Based Digital Signal Processing Methods for Enhancing Human EEGs. PhD Thesis, Polytechnic South West, Plymouth, Devon.

Ifeachor, E. C. and Jervis, B. W. (1993) Digital Signal Processing: A Practical Approach. Addison-Wesley Publishers Ltd., Wokingham, England.

Lesser, R. P., Webber, W. R. S. and Fisher, R. S. (1992) Design principles for computerized EEG monitoring. *Electroencephalography and clinical Neurophysiology*, vol. 82, pp. 239-247.

Stanley, W. D. (1984) Operational Amplifiers with Linear Integrated Circuits. Charles E. Merrill.

Visser, S. L. (1991) The electroencephalogram and evoked potentials in normal and ageing dementia. *Event-Related Brain Research* (EEG Suppl. 42).



# 4. Spectrum estimation of the EEG

---

## 4.1 Introduction

Background activities in the EEG, due to their rhythmic, sinusoidal-like nature, are well suited to analysis in the frequency domain and as such, many techniques to interpret background EEG activities, rely on methods for estimating the power spectral density distribution, or simply the power spectrum (Gotman et al. 1973, Gotman et al. 1975, Salinsky et al. 1992, Nakamura et al. 1992). These techniques however, often trade accuracy and resolution of the power spectral estimates arbitrarily, leading to estimates which are excessively noisy or excessively low in resolution. In this chapter, a technique to estimate the EEG power spectrum is described which ensures a reliable estimate is obtained at minimum cost in resolution. The technique is based on the Welch periodogram (Marple 1987 pp.130-170), where an estimate is obtained using pseudo ensemble averaging and windowing.

## 4.2 Pre-processing

Frequencies of interest in the EEG typically range from 0.5 to 60Hz (Binnie et al. 1982 p. 20). However, background activities i.e. delta (0 - 4Hz), theta (4 - 8Hz), alpha (8 - 13Hz) and beta (13 - 30Hz) activity, only occur at frequencies up to 30Hz. Reducing the 256Hz sampling frequency by a factor of four will give an



acceptable working frequency range of 0 to 32Hz and would greatly reduce computation in the analysis techniques. Reducing the sampling frequency concerns 'decimation' (Ifeachor and Jervis 1993), where frequencies greater than the new Nyquist frequency, need to be removed to prevent them aliasing frequencies at the new sampling frequency. This was carried out by digital low pass filtering. A reduction of the sampling frequency by a factor of four was then obtained by selecting every fourth sample in the data and disregarding the remainder.

### **4.3 Power spectrum estimation**

Estimating the power spectrum of a signal is usually based on classical procedures such as the fast Fourier transform (FFT), or relatively modern procedures such as parametric modelling. Whilst the classical approach is computationally efficient and is typically adequate for a wide range of applications, it can be limited in terms of resolution for short data sequences. Alternative methods typically aim to remedy this limitation by providing enhanced resolution for sequences which can consist of as little as a few data samples (Kay and Marple 1981).

In practice, signals such as the EEG cannot be predicted exactly and as such are random. These signals are therefore often characterised in terms of statistics and probability (Beauchamp 1973 pp. 22-25 and Marple 1978 pp. 111-129). For example, a stationary random process, may be defined by its mean and autocorrelation.

Let an 'ensemble' be defined as a set of discrete random signals obtained from a set of statistically identical discrete random processes, and referenced at the same instance in time (e.g.  $n = 0$ ). This random process is 'stationary' if the ensemble has a mean and an autocorrelation function (ACF), defined in Equation 34 and 35 respectively, which are constant for  $n$ .

$$\bar{x} = \varepsilon\{x[n]\} \quad (34)$$

$$r_{xx}[k] = \varepsilon\{x^*[n]x[n+k]\} \quad (35)$$

where  $\bar{x}$  denotes the mean of a discrete random process,  $n$  denotes the discrete time index,  $x[n]$  denotes a discrete random signal from the ensemble,  $\varepsilon$  denotes expectation and is obtained by averaging  $x[n]$  across the ensemble;  $r_{xx}[k]$  denotes the ACF of  $x[n]$ ,  $x^*[n]$  denotes the conjugate of  $x[n]$  and  $k$  denotes the time lag between  $x[n]$  and  $x[n+k]$ .

The Z transform of the ACF, when evaluated on the unit circle, leads to the definition of the power spectrum given in Equation 36 (Marple 1987 p. 117).

$$P_{xx}(f) = T \sum_{k=-\infty}^{\infty} r_{xx}[k] e^{-j2\pi kT} \quad V^2 \text{Hz}^{-1} \quad (36)$$

where  $f$  denotes frequency in Hertz and  $T$  denotes the sampling interval in seconds.

This definition for the power spectrum, the 'Wiener-Khinchin' theorem, describes the distribution in frequency of the power of  $x[n]$ , and as such is real and non-negative. An alternative definition of the power spectrum, which uses  $x[n]$  directly, is given in Equation 37.

$$P_{xx}(f) = \lim_{N \rightarrow \infty} \varepsilon \left\{ \frac{1}{(2N+1)T} \left| T \sum_{n=-N}^N x[n] e^{-j2\pi f n T} \right|^2 \right\} V^2 \text{ Hz}^{-1} \quad (37)$$

where  $P_{xx}(f)$  denotes the power spectrum of  $x[n]$ , and  $n$  denotes the discrete time index which ranges from  $-N$  to  $N$ .

This definition takes the magnitude squared of the Fourier transform of  $x[n]$ , scaled by the data sequence length, which is infinite. Since for each realisation of  $x[n]$ , the quantity in curly brackets will be randomly different, the ensemble average, denoted by the expectation operator,  $\varepsilon$ , needs to be calculated to obtain a statistically consistent estimate. A proof which shows that Equation 37 is equivalent to Equation 36 is given in Marple (1987 p. 123).

A poor but practical estimate of the power spectrum, called the periodogram is given in Equation 38, and is obtained from Equation 37 by ignoring the expectation operator and assuming a finite data set from  $n=0$  to  $n=N-1$  (Marple 1987 p. 152).

$$\hat{P}_{xx}(f) = \frac{T}{N} \left| \sum_{n=0}^{N-1} x[n] e^{-j2\pi f n T} \right|^2 V^2 \text{ Hz}^{-1} \quad (38)$$

A better estimate of the power spectrum, called the Welch periodogram (Marple 1987 pp. 130-170) attempts to account for the expectation operator by performing 'pseudo ensemble averaging'. The Welch periodogram also windows the data using functions such as the 'Kaiser-Bessel' window (Harris 1978) to minimise the sidelobe distortion introduced by assuming a finite data length.

In pseudo ensemble averaging, the data is broken into overlapping segments,  $L$  in length. Periodograms calculated for each segment are then averaged. Reducing the segment length  $L$  increases the accuracy of the resulting power spectral estimate at the expense of reduced resolution. The Kaiser-Bessel window is characterised by an adjustable parameter  $\alpha$ , which, when increased, reduces sidelobe distortion but again, at the expense of reduced resolution. In the next section, the optimum trade-off between  $\alpha$ ,  $L$  and resolution, which can often only be found experimentally, is determined by increasing  $\alpha$  and  $L$  until no discernible change in the noise in the spectral plot can be visibly seen.

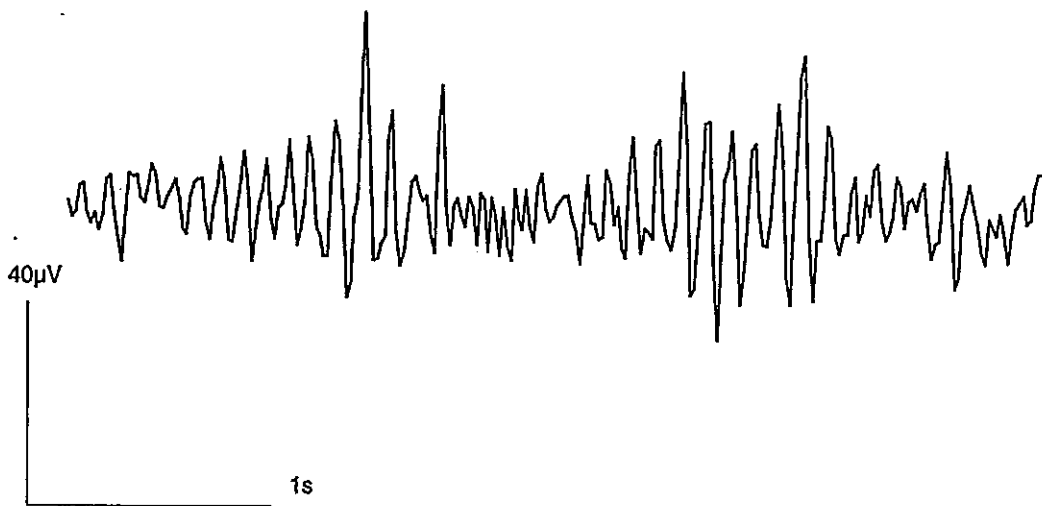
## **4.4 Power spectrum estimation for the background EEG**

In practice, spectrum analysis is often required for processes which are not stationary. This is the case for the EEG, which will change statistically with levels of awareness, opening and closing of the eyes and between the cycles of waking and sleeping.

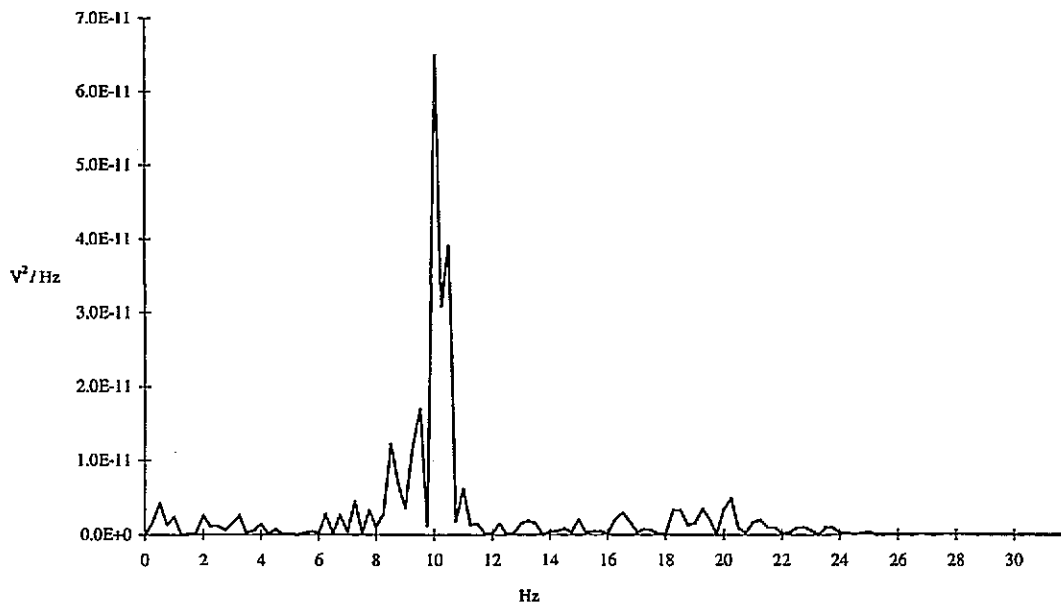
The reason for segmenting the EEG is to analyse changes between eyes open and eye closed data, and to produce sections of EEG which are as stationary as possible. In consultation with the clinical experts, background activities were considered unlikely to change significantly in any 4 second section of the EEG. Thus each 4 second section was assumed in a wide sense to be stationary.



In Figure 23, the power spectral estimate using the periodogram method in Equation 38 ( $T = 1/64s$ ,  $N = 256$ ) is given for the 4 second segment of EEG shown in Figure 22.

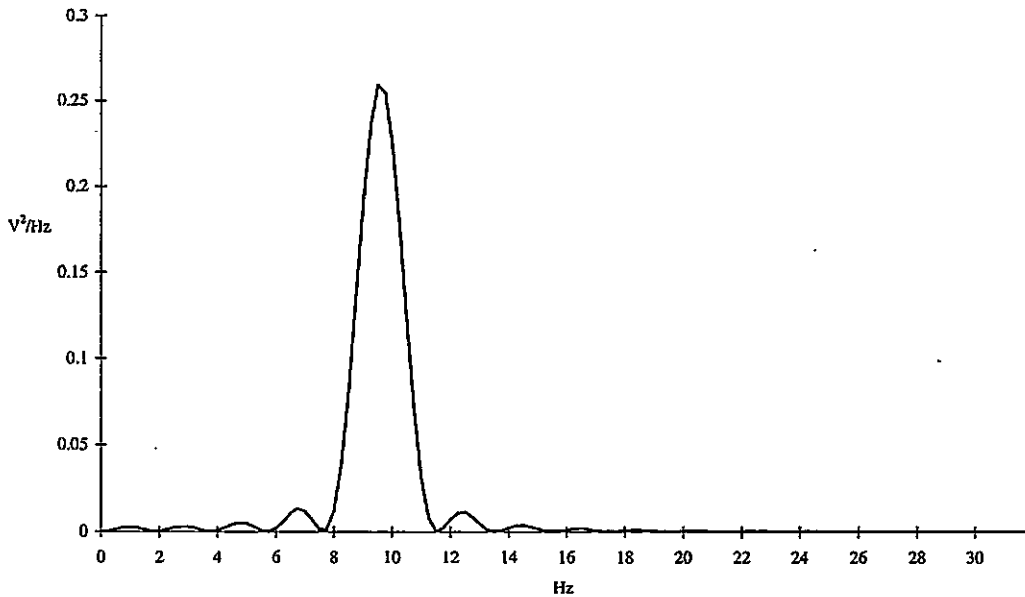


*Figure 22. A 4s segment of EEG taken from a normal adult.*



*Figure 23. Power spectrum of the 4s segment of EEG in Figure 22 using the periodogram method (Equation 38).*

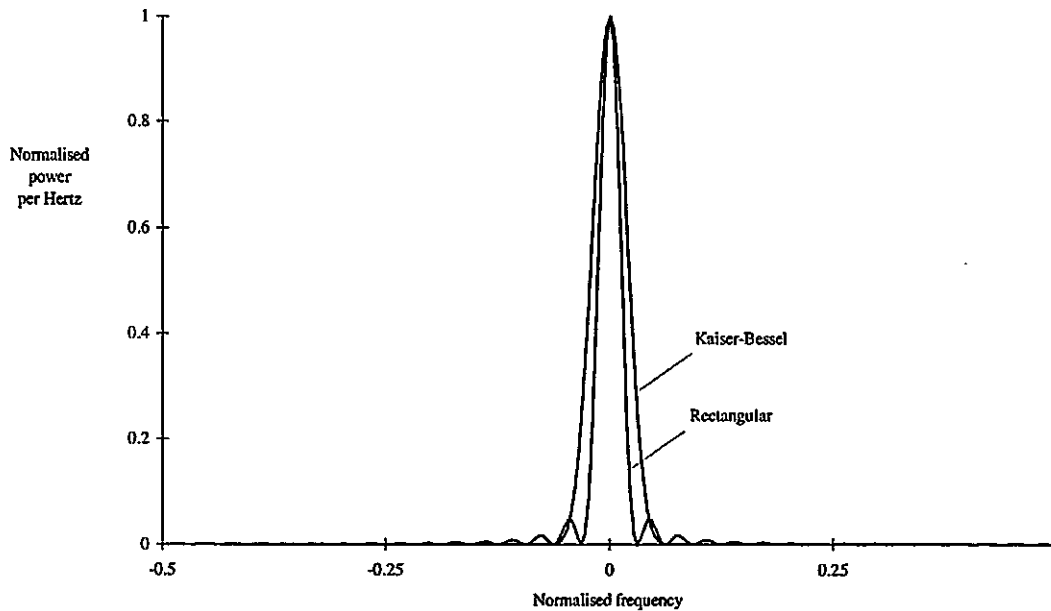
The consequence of calculating the power spectrum over a finite data sequence is that the sequence is assumed to be zero elsewhere i.e. time limited by a rectangular window. This is seen in the frequency domain as the convolution of the sequence transform with a sinc function, which is the rectangular window transform. For example, the power spectrum of a time limited, sinusoid sequence is given in Figure 24. The figure represents the convolution of the impulse from the sinusoid with the sinc function due to the finite sequence. Calculating the power spectrum using a finite data sequence distorts the amplitudes of adjacent frequencies due to the sinc function sidelobes and limits the resolution to the width of the sinc function mainlobe.



*Figure 24. Power spectrum of a time limited sinusoid using the periodogram method in Equation 38.*

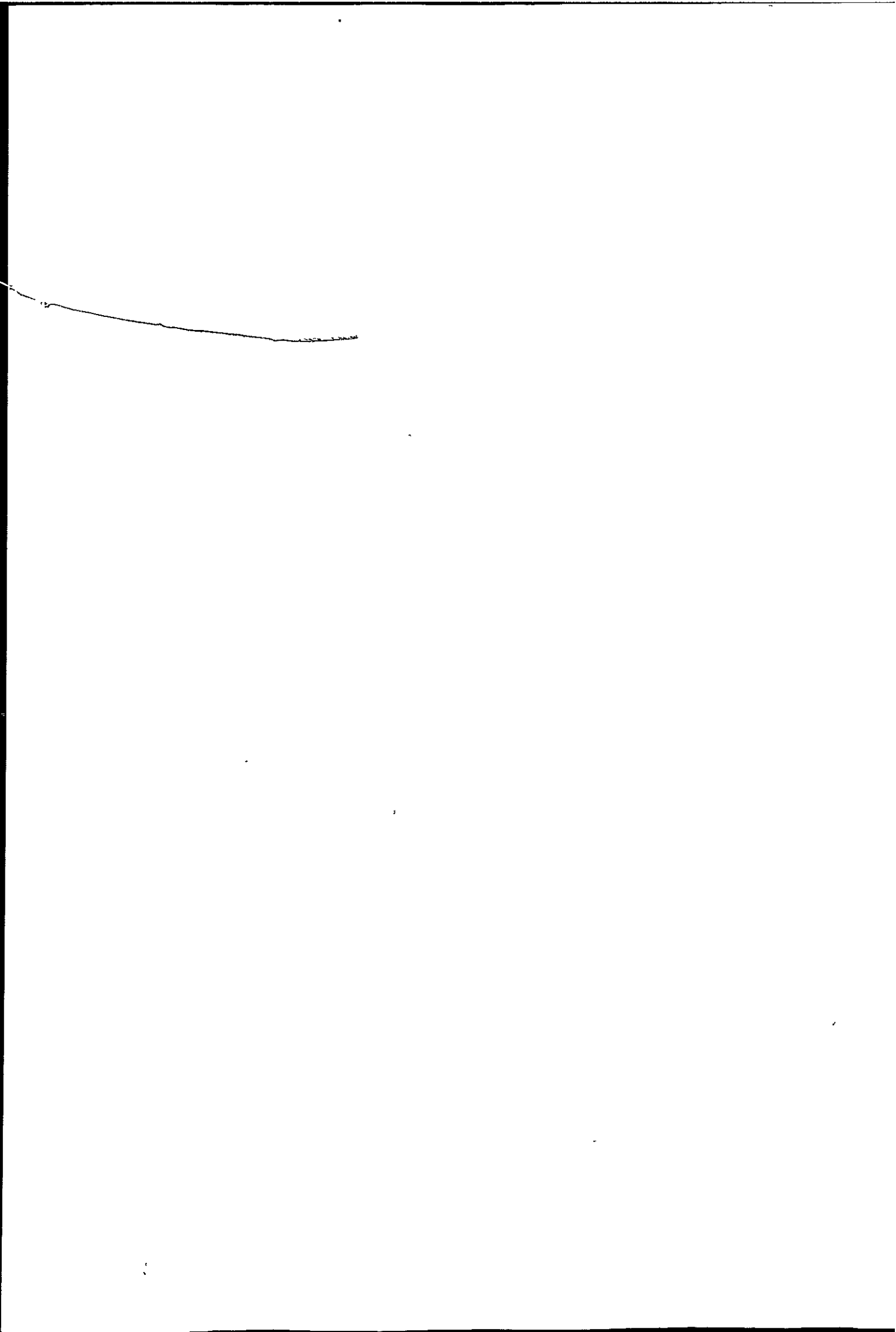
#### **4.4.1 Reducing side lobe distortion**

Window functions other than the rectangular window exist that exhibit reduced sidelobe levels, at the expense of a wider mainlobe. These functions will reduce the sidelobe distortion if applied to the data sequence prior to calculation of the power spectrum. In Figure 25 the transform of the rectangular window and the Kaiser-Bessel function ( $\alpha = 2$ ) are given to compare differences in sidelobe levels and mainlobe width. Advantages of the Kaiser-Bessel function over other window functions such as the 'Hann' or 'Hamming' is the ability to and ease of varying the sidelobe level and mainlobe width using the single parameter  $\alpha$ .



*Figure 25. Power spectrum of the Kaiser-Bessel and rectangular window function.*

In Figure 26, estimates of the power spectrum using the Kaiser-Bessel window function, with  $\alpha$  set at 0.75, 2 and 2.5 are shown for the sequence given in Figure 22. In the figure, a reduction in the amplitude level of the sidelobes can be seen when the parameter  $\alpha$  is increased. Figures of merit for these window functions and the rectangular window are given in Table 2 (Harris 1978).



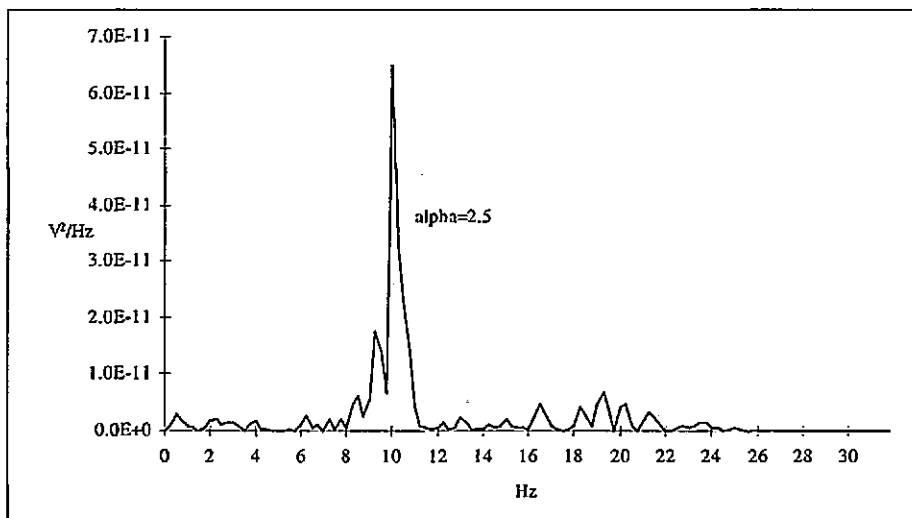
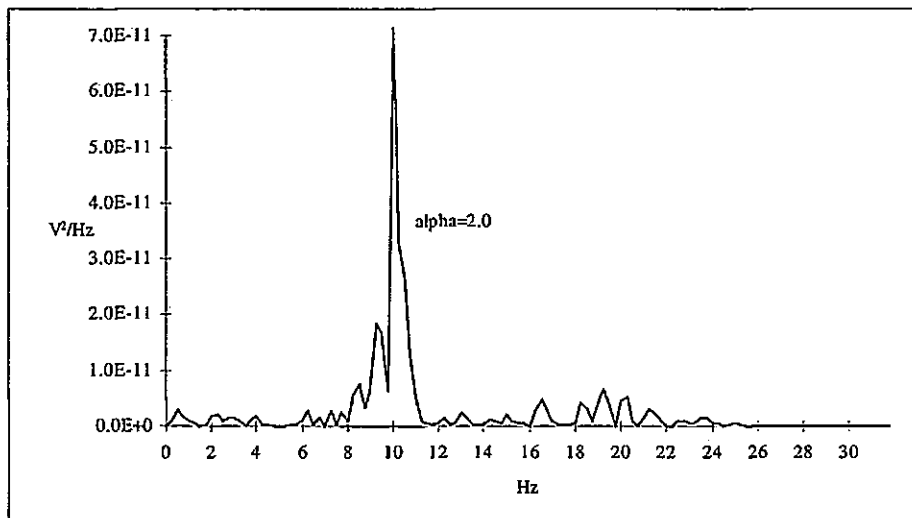
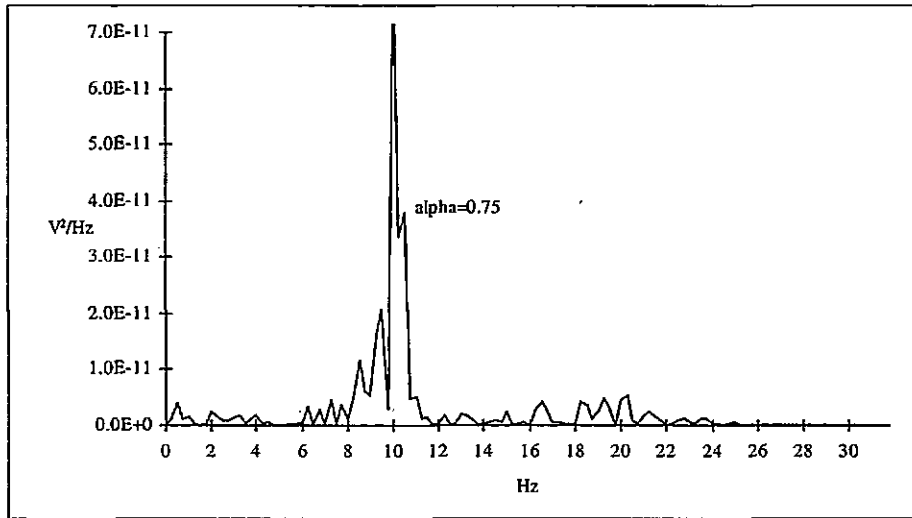


Figure 26. Power spectrum estimation of the 4s segment of EEG in Figure 22 using the periodogram method (Equation 38) and the Kaiser-Bessel window function ( $\alpha=0.75, 2$  and  $2.5$ ).

Window name	Highest sidelobe level	Sidelobe decay rate	-6dB bandwidth
Rectangular	-13dB	-6dB / octave	1.21/(NT) Hz
Kaiser-Bessel ( $\alpha = 0.75$ )	-20dB	-6dB / octave	1.4/(NT) Hz
Kaiser-Bessel ( $\alpha = 2$ )	-46dB	-6dB / octave	2/(NT) Hz
Kaiser-Bessel ( $\alpha = 2.5$ )	-57dB	-6dB / octave	2.2/(NT) Hz

*Table 2. Figures of merit for the rectangular window and Kaiser-Bessel window ( $N$  is the number of data points in the FFT and  $T$  is the sampling interval in seconds).*

The highest sidelobe level and the sidelobe decay rate indicate sidelobe distortion performance. This is traded with the -6dB mainlobe bandwidth, which specifies the spectral resolution, that is, the minimum distance for two adjacent spectral responses to be resolved. Two sinusoids may be no closer than this to be distinguishable (Harris 1978). Selecting the value 2 for  $\alpha$ , produces a -6dB bandwidth and hence resolution given in Equation 39 ( $N = 256$  and  $T = 1/64$  seconds).

$$\text{Resolution} = \frac{2}{N \cdot T} = \frac{2}{256 \cdot 1/64} = 0.5\text{Hz} \quad (39)$$

The operation of windowing has the effect of introducing a dc component to the data sequence. This can be compensated for prior to windowing by subtracting from the data sequence the offset calculated as in Equation 40 (Jervis et al. 1989).



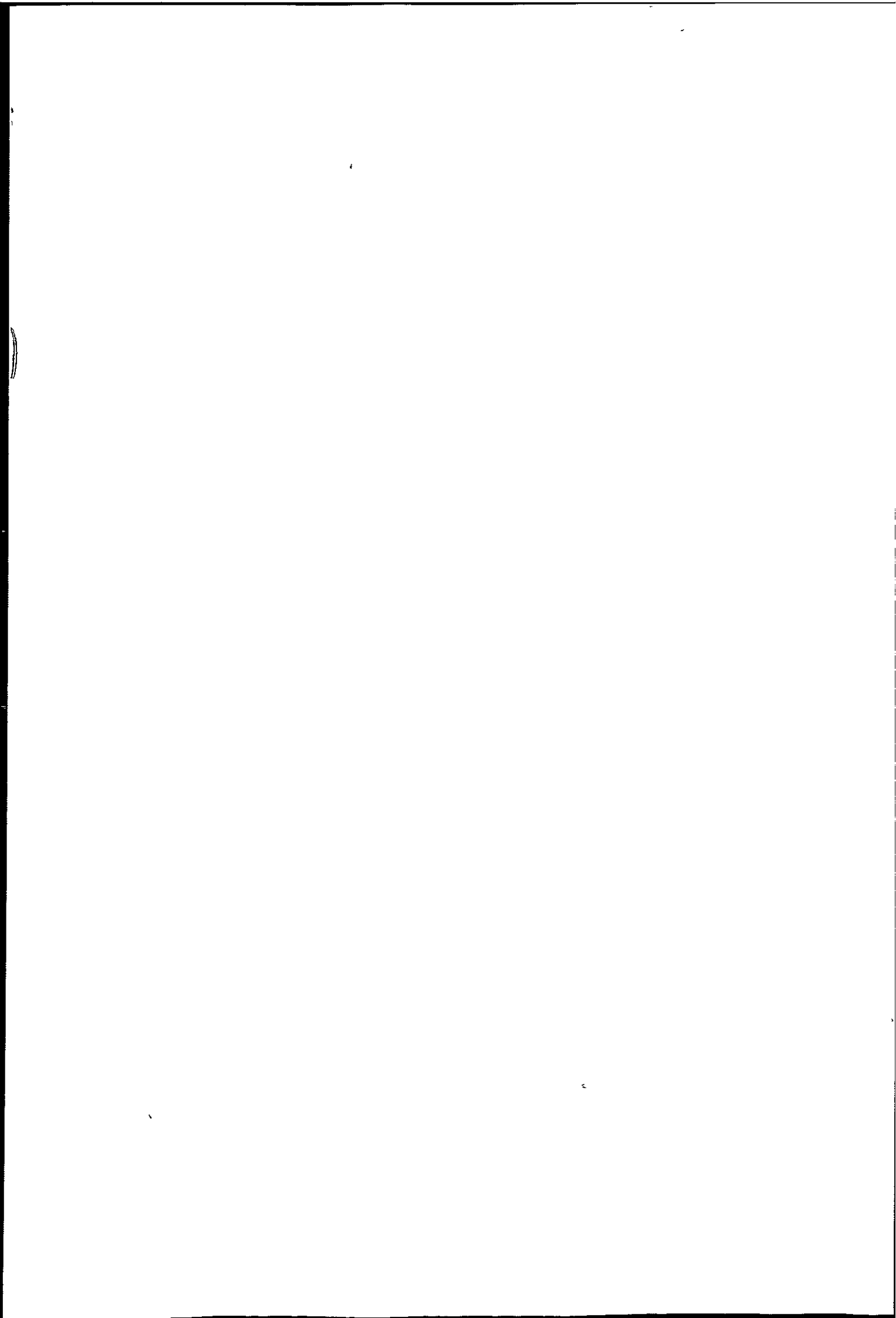


$$offset = \frac{\sum_{n=0}^{N-1} x[n]w[n]}{\sum_{n=0}^{N-1} w[n]} \quad (40)$$

where  $x[n]$  denotes a discrete time signal,  $w[n]$  denotes a discrete time window and  $n$  a discrete time index from 0 to  $N - 1$ .

#### 4.4.2 Pseudo ensemble averaging

Ignoring the expectation operator in Equation 37, which is necessary to ensure a statistically consistent estimate, gives rise to a statistically unstable estimate which suffers from the noisy fluctuations which can be observed in Figure 23. To increase the accuracy of the spectral estimate, Welch proposed pseudo ensemble averaging, in order to smooth the periodogram plot. The method separates the data sequence into smaller segments that overlap. The periodograms of the segments are then averaged, resulting in an improvement in the spectral estimate stability by a factor roughly equal to the number of segments averaged (Marple 1987 pp. 130-170). The cost in pseudo ensemble averaging, however, is a reduction in resolution due to the segmentation of the data sequence into shorter data sequences. However, an optimal trade-off can be experimentally obtained by incrementally reducing the segment length  $L$ , until minimal changes in the noise fluctuations can be observed. In Figure 27, estimates of the power spectrum using pseudo ensemble averaging for 3, 7 and 15 segments ( $L = 128, 64$  and  $32$  respectively) overlapped by 50%, are shown for the sequence given in Figure 22. It is seen that as the value of  $L$  is reduced the noise fluctuations are reduced, but this is at the expense of the resolution of the main spectral component.  $L = 64$  is



chosen as a compromise and provides a resolution which is given in Equation 41  
( $N = 64$  and  $T = 1/64$  seconds).

$$\text{Resolution} = \frac{2}{N \cdot T} = \frac{2}{64 \cdot 1/64} = 2\text{Hz} \quad (41)$$

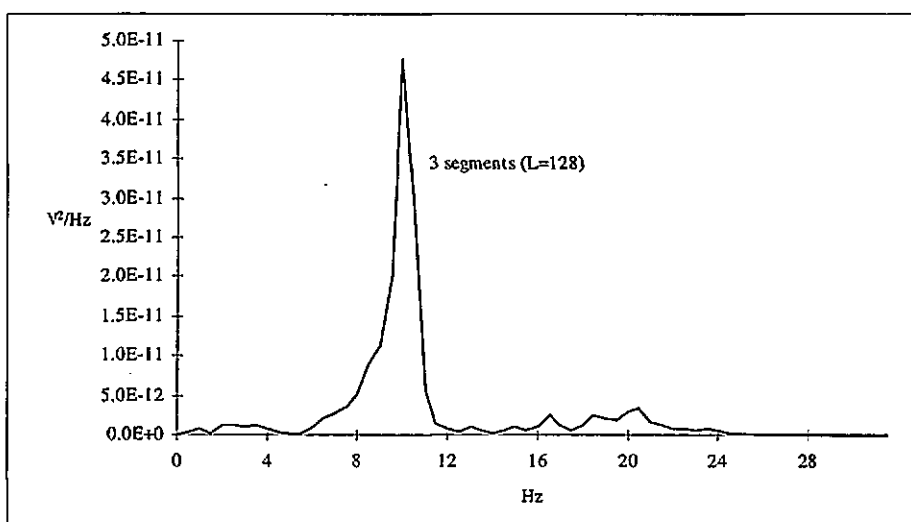
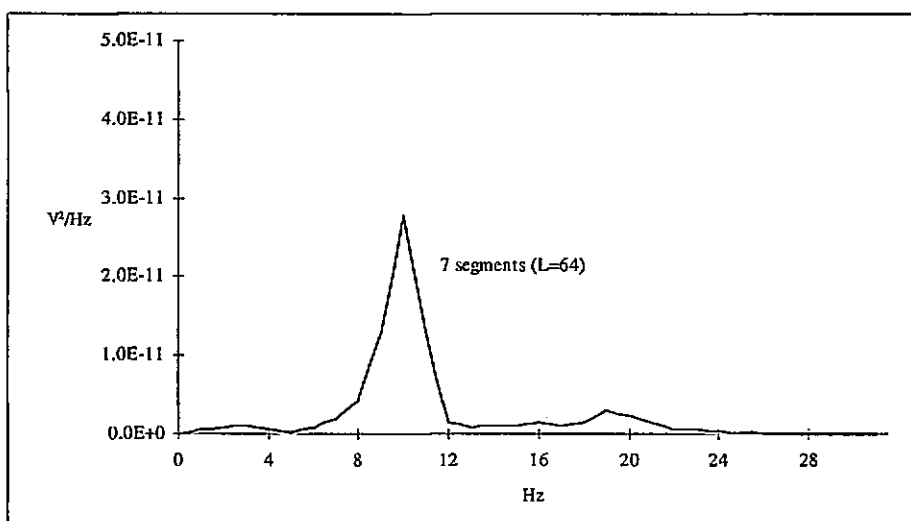
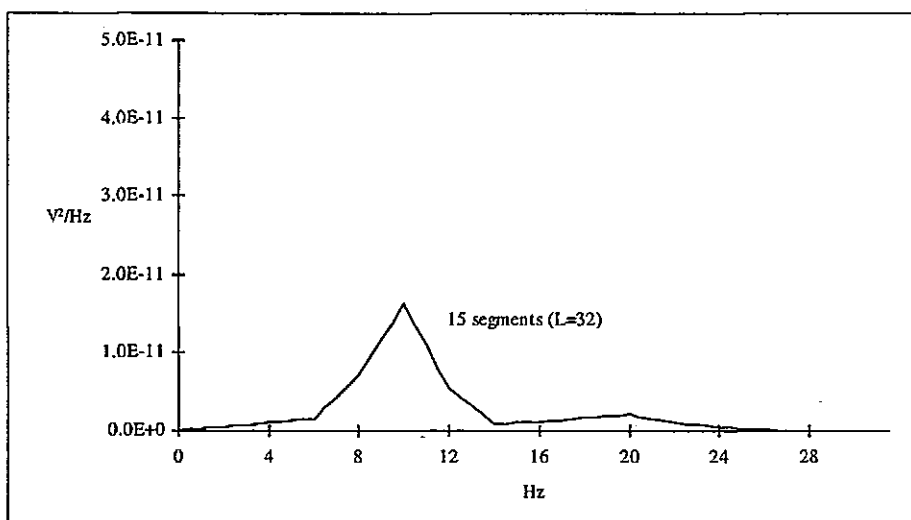


Figure 27. Power spectrum of the 4s segment of EEG in Figure 22 using the periodogram method (Equation 38) and pseudo ensemble averaging 15, 7 and 3 segments.

### 4.4.3 Interpolating the power spectrum

When a frequency component in the data sequence is not equal to a harmonic frequency of the power spectrum (the harmonic frequencies are located at  $k/NT$  Hz, where  $k = 0, 1, \dots, N/2-1$ ,  $N$  is the number of data points in the FFT and  $T$  is the sampling interval in seconds), its power is shared between the adjacent harmonic frequencies. This ambiguity can be reduced by a process called 'zero padding' (Marple 1987). Zero padding, which is the appendage of zeros to the end of the data sequence, interpolates the power spectrum. The result is a plot having a smoother appearance. Zero padding does not, however, affect the resolution. In Figure 28, power spectral estimates with no padding, padding to two and padding to four times the data segment length are given for the data sequence in Figure 22.

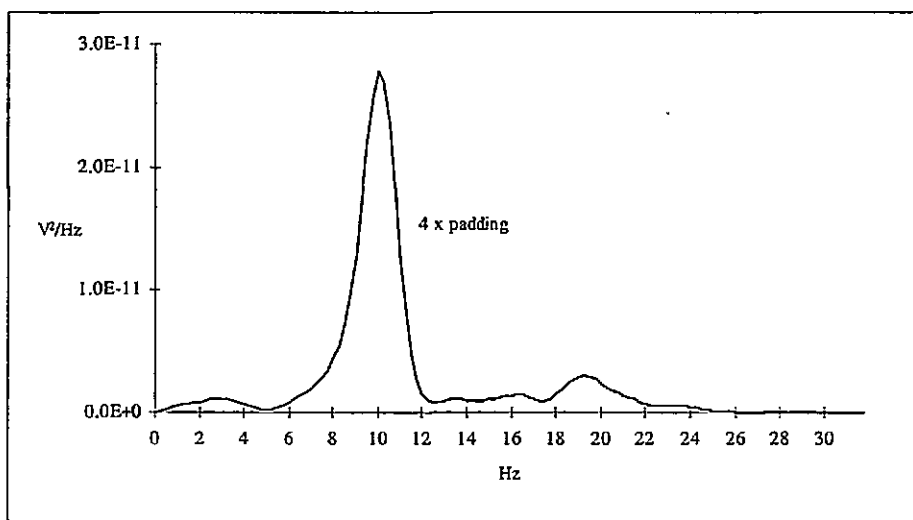
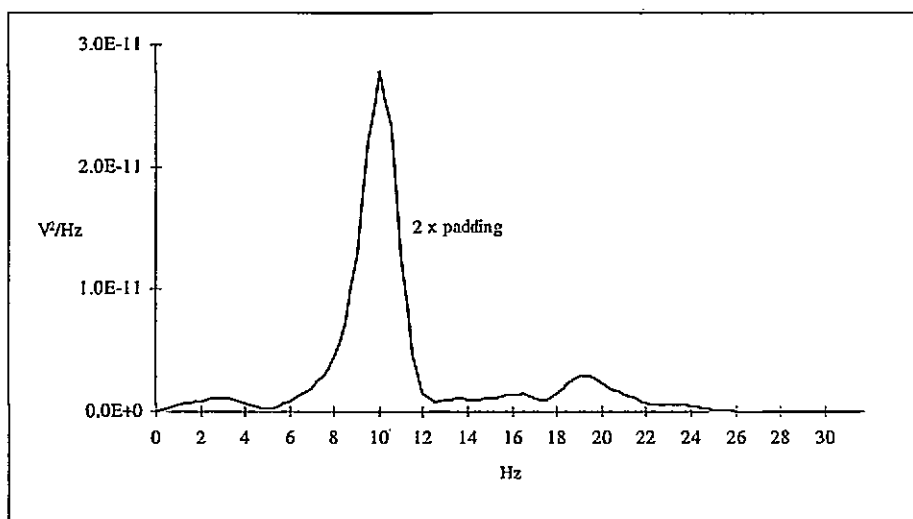
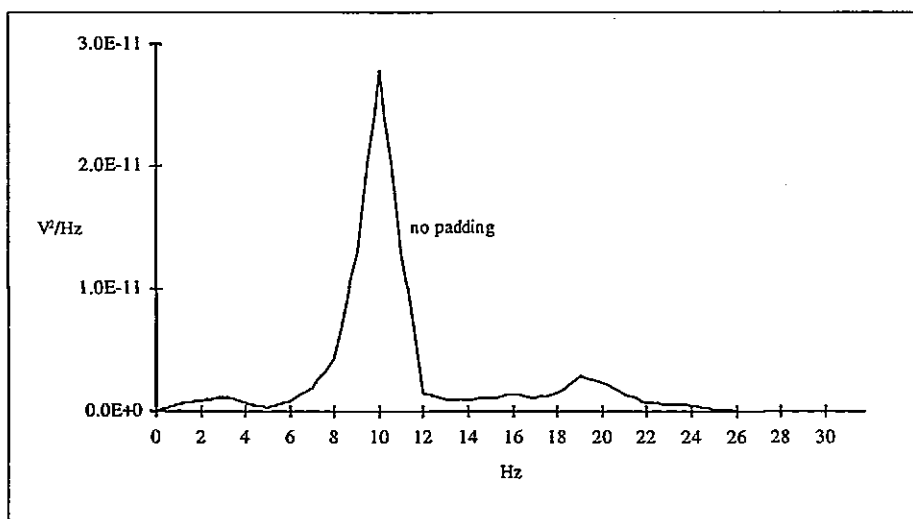
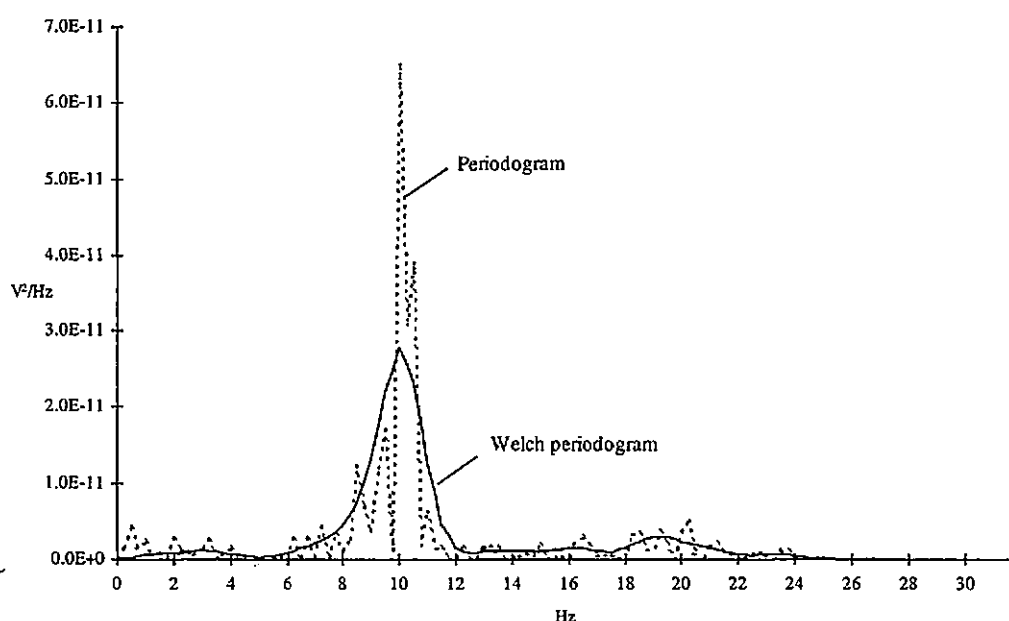


Figure 28. Power spectrum of the 4s segment of EEG in Figure 22 using no zero padding and zero padding to two and four times the data segment length.

In Figure 29, estimates of the power spectrum using the periodogram method and the Welch periodogram method are shown for the sequence given in Figure 22. In the Welch periodogram estimate, which was calculated using the Kaiser-Bessel window ( $\alpha = 2$ ), and pseudo ensemble averaging 7 segments and zero padding to twice the data segment length, the alpha and beta activities in Figure 22 (at 10 and 19.25Hz respectively) are clearly well represented.



*Figure 29. Power spectrum estimation using the periodogram method and Welch periodogram method (using a Kaiser-Bessel window ( $\alpha=2$ ), pseudo ensemble averaging by segmenting the data by 7, and zero padding to twice the data segment length).*

## 4.5 Summary

In this chapter, a reliable technique is described by which the power spectrum of the EEG is calculated. The technique is based on the Welch periodogram (Marple

1987 pp.130-170), where an estimate of the EEG power spectrum is obtained using pseudo ensemble averaging and windowing. In pseudo ensemble averaging, the data is broken into segments,  $L$  in length. Periodograms calculated for each segment are then averaged. Reducing the segment length  $L$  increases the accuracy of the estimate at the expense of reduced resolution. Windowing also increases the accuracy of the estimate by reducing sidelobe noise. Many window functions have been proposed, each providing a different trade-off between noise and resolution (Harris 1978). An advantage of the Kaiser-Bessel window however, is adjustment in this trade-off using a single parameter  $\alpha$ . In most applications, the optimum trade-off between  $\alpha$ ,  $L$  and resolution can often only be found experimentally. The method used in this case was to incrementally increase  $\alpha$  and reduce  $L$  until no significant change in the spectral plot was visible. The method ensured a reliable estimate was obtained with minimum cost in resolution.

The sampling frequency was first decimated to 64Hz, a frequency more appropriate to background EEG processing. The data were then sectioned into 4 second segments, a duration deemed sufficiently long to ensure good spectral estimates, but short enough to ensure the data within the segment remained stationary (in a wide sense). Estimates were calculated for the EEG segments with  $\alpha$  ranging from 0 to 2.5 and with  $L$  ranging from 256 samples to 32. Minimal changes in terms of noise can be observed in the estimate when  $\alpha = 2$  and  $L = 64$  samples. Selecting these parameters for the estimate provides a resolution (the minimum distance for two adjacent spectral responses to be resolved) of 2Hz. In



clinical practice, frequency components spaced less than 2 Hz in an EEG segment, will not be distinguishable.

## 4.6 References

Beauchamp, K. G. (1973) *Signal Processing*. George Allen and Unwin Ltd., London.

Giese, D. A., Bourne, J. R. and Ward, J. W. (1979) Syntactic analysis of the electroencephalogram. *IEEE Transactions on Systems, Man, and Cybernetics*, vol. SMC-9, no. 8, pp. 429-435.

Gotman, J., Gloor, P. and Ray, W. F. A quantitative comparison of traditional reading of the EEG and interpretation of computer-extracted features in patients with supratentorial brain lesions. *Electroencephalography and clinical Neurophysiology*, vol. 38, pp. 623-639.

Gotman, J., Skuce, D. R., Thompson, C. J., Gloor, P., Ives, J. R. and Ray, W. F. Clinical applications of spectral analysis and extraction of features from electroencephalograms with slow waves in adult patients. *Electroencephalography and clinical Neurophysiology*, vol. 35, pp. 225-235.

Harris, F. J. (1978) On the use of windows for harmonic analysis with the discrete Fourier transform. *Proceedings of the IEEE*, vol. 66, no. 1, pp. 302-310.

Ifeachor, E. C. and Jervis, B. W. (1993) *Digital Signal Processing: A Practical Approach*. Addison-Wesley Publishers Ltd., Wokingham, England.

Jagannathan, V., Bourne, J. R., Jansen, B. H. and Ward, J. W. (1982) Artificial intelligence methods in quantitative electroencephalogram analysis. *Computer Programs in Biomedicine*, vol. 15, pp. 249-258.

Jervis, B. W., Coelho, M. and Morgan, G. W. (1989) Spectral analysis of EEG responses. *Medical and Biological Engineering and Computing*, vol. 27, pp. 230-238.

Kay, S. M. and Marple, S. L. Jr. (1981) Spectrum analysis - a modern perspective. *Proceedings of the IEEE*, vol. 69, no. 11, pp. 1880-1419.

Marple, S. L. (1987) *Digital Spectral Analysis with Applications*. Prentice-Hall, Englewood Cliffs, New Jersey.

Nakamura, M., Shibasaki, H., Imajoh, K., Nishida, S., Neshige, R. and Ikeda, A. (1992) Automatic EEG interpretation: A new computer-assisted system for the automatic integrative interpretation of awake background EEG. *Electroencephalography and clinical Neurophysiology*, vol. 82, pp. 423-431.

Salinsky, M. C., Oken, B. S., Kramer, R. E. and Morehead, L. (1992) A comparison of quantitative EEG frequency analysis and conventional EEG in

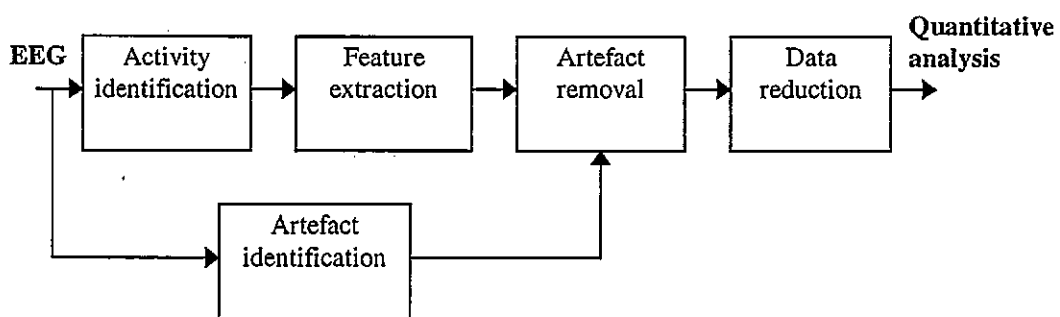
patients with focal brain lesions. *Electroencephalography and clinical Neurophysiology*, vol. 83, pp.358-366.

# 5. Quantitative EEG analysis

---

## 5.1 Introduction

In this chapter, digital signal processing (DSP) algorithms which identify the significant activities in the EEG and extract the time domain, frequency domain and spatial features which characterise them are presented. A conceptual diagram showing the stages in the analysis is given in Figure 30.



*Figure 30. Stages of the quantitative analysis.*

The background activities in each 4 second EEG segment are identified in the frequency domain, and for each activity, six basic time and frequency domain features are extracted. At this stage, the corruption of the EEG by artefacts, which have similar characteristics to the EEG activities, would produce misleading results in the analysis. To deal with the corruption, an artefact removal strategy is implemented (Riddington et al. 1996a), based on new and reliable techniques for identifying different artefact types in the EEG (Wu et al. 1997). Next, data

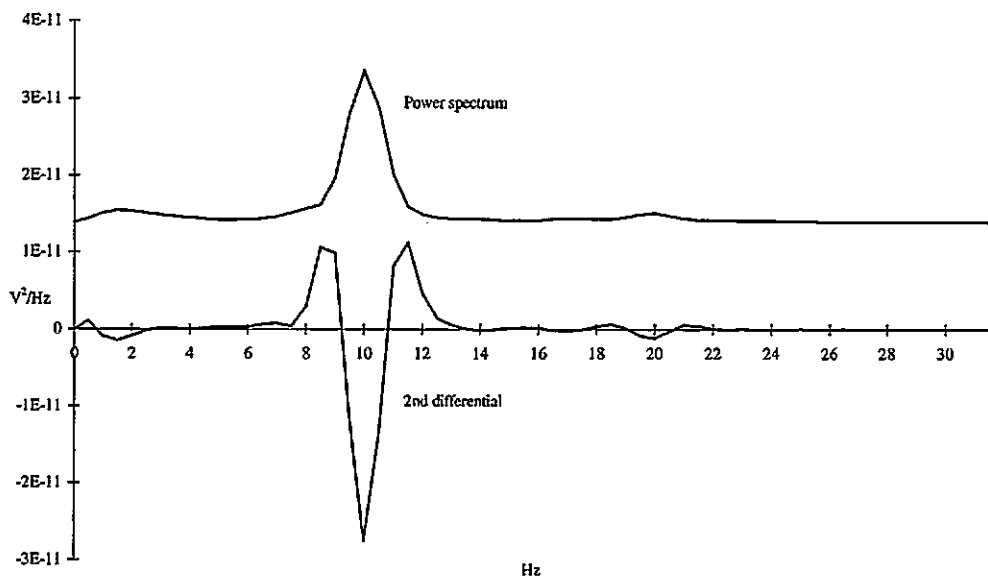
reduction is performed using the leader cluster algorithm to remove redundancy and to unify the segment-by-segment analysis. This produces clusters which represent the delta, theta, alpha and beta activities for the entire EEG record. Quantitative descriptions for each cluster are finally derived by processing the features in each cluster. The outcome is a quantitative analysis which efficiently describes the significant background activities in the record.

## **5.2 Identification of background EEG activities**

In the time domain, background EEG activities manifest themselves as a pseudo-periodic series of positive and negative peaks (see Figure 22), and in the frequency domain as spectral peaks (see Figure 29). Previous methods for analysing the background EEG activities, typically identify delta, theta, alpha and beta activities using parameters such as the spectral power in the fixed frequency bands: delta (0.5 to 4Hz); theta (4 to 8Hz); alpha (8 to 13Hz) and beta (13 to 30Hz) (Gotman et al. 1973, Gotman et al. 1975, Nakamura et al. 1985, Nakamura et al. 1992, Pradhan et al. 1993). However, the frequency content of these activities may extend across the band edges, leading to potential misclassifications. For example, an alpha activity at about 8Hz, might appear inside both the theta and alpha activity bands. By identifying activities by spectral peak rather than frequency band and categorising these frequencies using a cluster algorithm, this ambiguity can be avoided.

The procedure for identifying background activities in an EEG segment was implemented as follows. The  $i$ th peak in the power spectrum of the  $j$ th channel in

the  $k$ th EEG segment defined the presence of a background activity. The start and end of each peak was defined as a change from concave to convex followed by a change from convex to concave, that is, the start and end of each peak was characterised by a point of inflexion. Each of these points can be identified in the power spectrum as zero crossings in the second differential (Figure 31). Each zero crossing having a negative slope indicates a change from concave to convex i.e. a peak start, and each zero crossing having a positive slope indicates a change from convex to concave i.e. a peak end.



*Figure 31. Second differential of the power spectrum showing zero crossing for detecting peak boundaries.*

## 5.3 Feature extraction

After consultation with EEG experts, six quantitative time and frequency domain features were selected to characterise each background activity: *frequency*; *absolute power*; *relative power*; *frequency variability*; *amplitude* and *amplitude variability*.

### 5.3.1 Frequency domain analysis

The four features *frequency*, *absolute power*, *relative power* and *frequency variability*, were obtained from each identified peak in the power spectrum. *Frequency* was defined as the frequency of the peak, *absolute power* was defined as the area between the peak start and end, *relative power* was defined as the *absolute power* divided by the area of the whole power spectrum (i.e. between 0Hz and 32Hz) and expressed as a percentage and *frequency variability* was defined as the peak width (Figure 32).

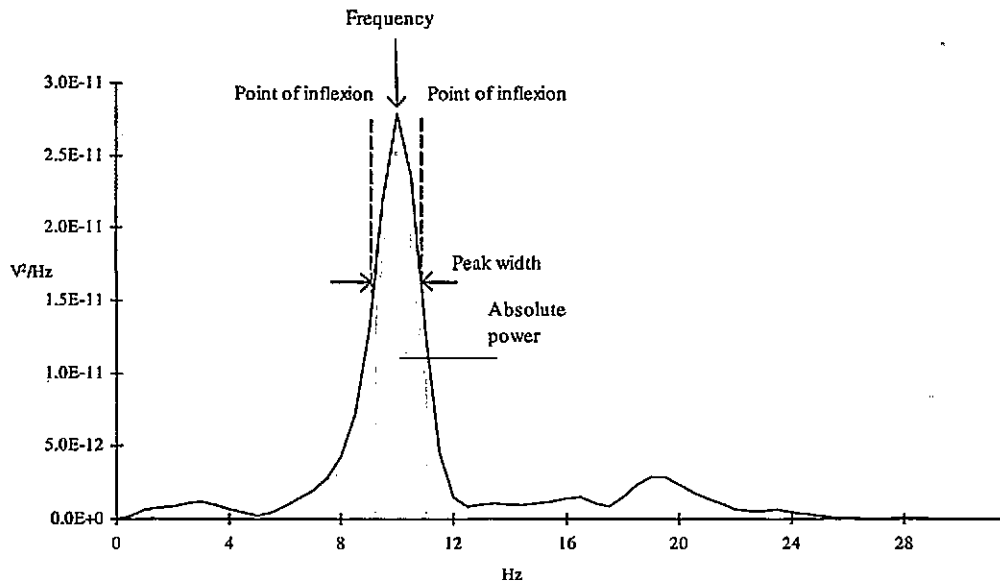


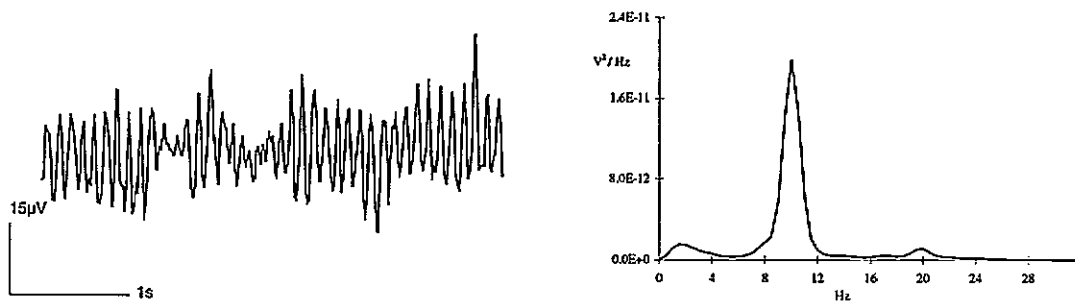
Figure 32. Frequency domain feature extraction using power spectrum analysis.

### 5.3.2 Time domain analysis

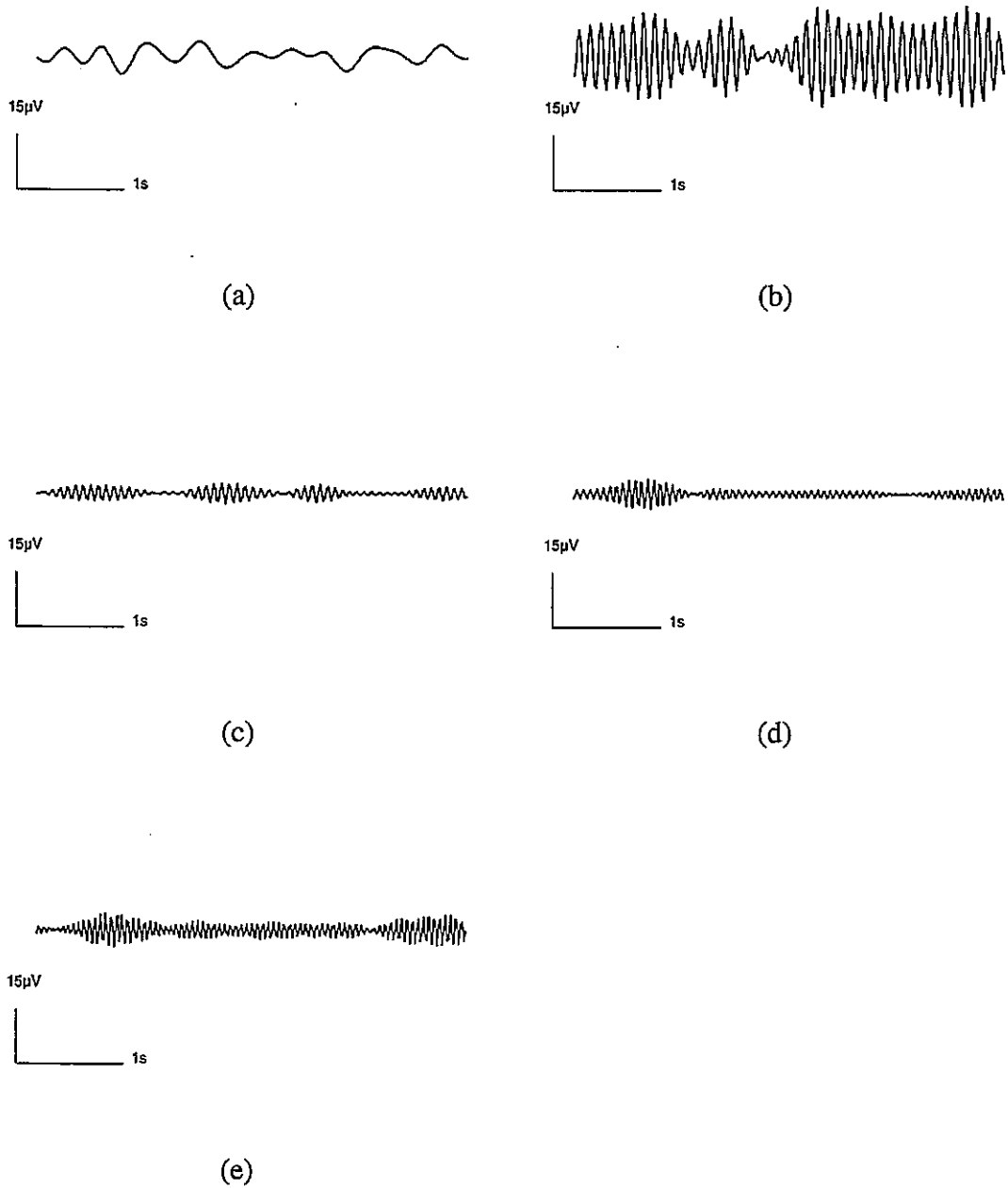
Each background activity identified as a peak in the power spectrum was isolated in the time domain from the other waveforms, using a 110th order finite impulse response bandpass filter with pass band defined by the spectral peak start and end. Automated coefficient calculation was efficiently carried out by using the window method of design (Kaiser-Bessel window,  $\alpha = 3.975$ ) (Ifeachor and Jervis 1993). The isolated waveform, which was characterised by a series of positive and negative peaks, was then used to determine the time domain features *amplitude* and *amplitude variability*. *Amplitude* was defined as the maximum peak-to-peak swing, and *amplitude variability* as the average between the standard deviation of the maxima and the standard deviation of the minima (see Table 3). Whilst the



*amplitude variability* calculation provided a measure of the degree the activity varied in time, it produced a measure which was proportional to the amplitude of the waveform. To produce an *amplitude variability* feature independent of amplitude, the maxima and minima mean were first normalised. For the EEG and the corresponding power spectrum shown in Figure 33, the activities corresponding to each spectral peak are shown in Figure 34. Note the isolation in time of the alpha and beta activities at 10 and 20Hz respectively.



*Figure 33. A 4s EEG segment and corresponding power spectrum.*



*Figure 34. EEG activities at 1.5Hz (a), 10Hz (b), 14.5Hz (c), 17Hz (d) and 20Hz (e) which have been isolated in time from the EEG in Figure 33 using a digital filter.*

A summary of the DSP algorithms used for the feature extraction from 4s EEG segments is given in Table 3.



Feature	Method of calculation	Units	Description
frequency	$f_{peak}$	Hz	frequency of the power spectral peak
absolute power	$\sum_{f_{start}}^{f_{end}} P[k] \Delta f$	V <sup>2</sup>	area of the power spectral peak
frequency variability	$f_{end} - f_{start}$	Hz	power spectral peak width
relative power	$\frac{\sum_{f_{start}}^{f_{end}} P[k] \Delta f}{\sum_f P[f] \Delta f} \cdot 100$	%	power as a percentage of the whole power spectrum
amplitude	$\max_i \{ \text{extremum}_i - \text{extremum}_{i+1} \}$	V	maximum pk-pk swing of $x'[n]$
amplitude variability	$\frac{\text{nsd}(\text{maxima}) + \text{nsd}(\text{minima})}{2}$ $\text{maxima} = \{ \text{maximum}_l \}$ $\text{minima} = \{ \text{minimum}_m \}$	V (norm)	standard deviation (normalised for amplitude) of the maxima and minima of $x'[n]$

Table 3. Basic features extracted from activity identified in an EEG segment.

where:

- $x[n]$  = single channel in a 4s epoch of EEG  
 $P[k]$  = power spectrum of  $x[n]$   
 $\Delta f$  = power spectrum frequency bin width  
 $f_{start}$  = frequency of the start of the power spectral peak determined by point of inflexion  
 $f_{peak}$  = frequency of the power spectral peak maximum  
 $f_{end}$  = frequency of the end of the power spectral peak determined by point of inflexion  
 $x'[n]$  =  $x[n]$  bandlimited between  $f_{start}$  and  $f_{end}$   
 $\text{extremum}_i$  = amplitude of the  $i$ th extremum of  $x'[n]$   
 $\text{maximum}_l$  = amplitude of the  $l$ th maximum of  $x'[n]$   
 $\text{minimum}_m$  = amplitude of the  $m$ th minimum of  $x'[n]$

$$\text{nsd}(x) = \sqrt{\sum_j (y_j - \bar{y})^2}; \quad x = \{x_j\}; \quad y_j = \left\{ \frac{x_j}{\bar{x}} \right\}; \quad y = \{y_j\}$$

## 5.4 Data reduction

The peak detection technique, which relies on peak shape rather than height, typically identifies around 200 activities (i.e. peaks in the power spectrum of each



channel) in each 4s segment. Many of these activities are insignificant, i.e. are not identified in the conventional assessment, or are redundant i.e. they are the same activities identified in other channels and segments. Data reduction therefore was necessary to remove insignificant activities and to categorise, or cluster activities which were the same.

Insignificant activities in the EEG were defined by those having amplitudes less or equal to the following thresholds (Frost et al. 1980):

- 14 $\mu$ V for delta ( $< 4\text{Hz}$ )
- 14 $\mu$ V for theta ( $\geq 4\text{Hz}$  and  $< 8\text{Hz}$ )
- 9 $\mu$ V for alpha ( $\geq 8\text{Hz}$  and  $\leq 13\text{Hz}$ )
- 5 $\mu$ V for beta ( $> 13\text{Hz}$ )

These activities were not included in subsequent analysis.

Whilst background EEG activities are traditionally classified by frequency into the bands: delta (0 - 4Hz), theta (4 - 8Hz), alpha (8 - 13Hz) and beta (13 - 30Hz), they may, occasionally, range across the frequency band edges. By clustering the activities identified in the EEG using the *frequency* feature, such misclassification can be avoided. The leader clustering algorithm (Hartigan 1975) shown in Figure 35, provides a simple, one-pass, clustering procedure for data where the number of clusters are not known in advance, and was used to find clusters in *frequency* which corresponded to the unique activities in the EEG record. The algorithm clusters according to a parameter which specifies the minimum distance permissible between cluster centres. This distance was set empirically at 5Hz.

Let  $f(i)$  be the set of PSD peak frequencies,  $C(i)$  be the cluster in which  $f(i)$  belongs,  $k$  be the number of clusters, where  $k = 1, 2, 3, \dots, K$  and  $L(k)$  be the leader frequency associated with cluster  $k$ .

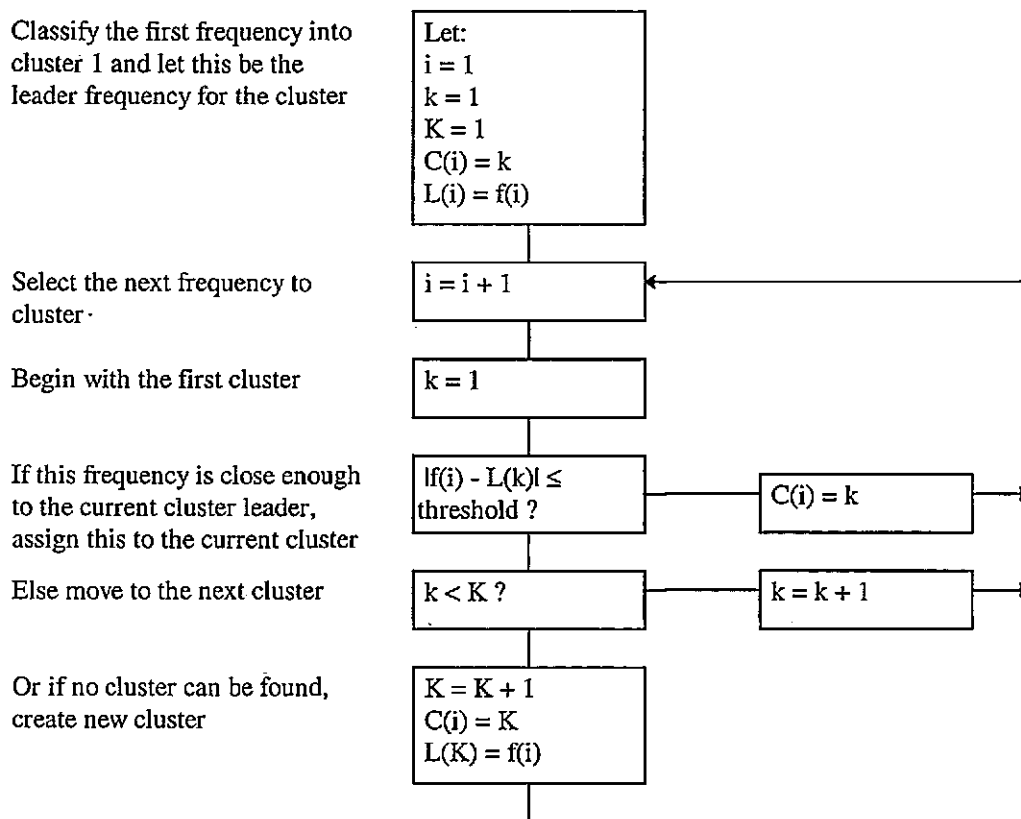


Figure 35. The leader cluster algorithm used to cluster the feature 'frequency'.

Quantitative descriptions for each activity were then derived by processing the basic time and frequency domain features within each cluster. The descriptions, which were calculated from clusters representing activity in the eyes closed and eyes open data, are defined in Table 4.

Feature	Calculation
Frequency	mean frequency of a cluster from eyes closed data
Amplitude	maximum amplitude of a cluster from eyes closed data
Absolute power	mean absolute power of a cluster from eyes closed data
Amplitude variability	mean amplitude variability of a cluster from eyes closed data
Frequency variability	mean frequency variability of a cluster from eyes closed data
Absolute power in eyes closed and eyes open data	the mean absolute power of a cluster from the eyes closed data and the corresponding cluster in the eyes open data (where 'corresponding cluster' denotes the cluster whose mean frequency is the nearest and within 1Hz of the cluster from eyes closed data)
Frequency in eyes eyes closed and eyes open data	the mean frequency of a cluster from the eyes closed data and the corresponding cluster in the eyes open data (where 'corresponding cluster' denotes the cluster whose mean frequency is the nearest and within 1Hz of the cluster from eyes closed data)
Absolute power symmetry	ratio of mean absolute power in the left (channels: Fp1, F7, F3, A1, T3, C3, T5, P3 and O1) and right (channels: Fp2, F4, F8, C4, T4, A2, P4, T6 and O2) regions of the scalp of a cluster from eyes closed data
Frequency symmetry	mean frequency in the left (channels: Fp1, F7, F3, A1, T3, C3, T5, P3 and O1) and right (channels: Fp2, F4, F8, C4, T4, A2, P4, T6 and O2) regions of the scalp of a cluster from eyes closed data
Absolute power distribution	distribution of the mean absolute power across the scalp of a cluster from eyes closed data
Relative power distribution	distribution of the mean relative power across the scalp of a cluster from eyes closed data
Frequency distribution	distribution of the mean absolute power across the scalp of a cluster from eyes closed data

*Table 4. Features calculated from clusters representing activities in the eyes closed and the eyes open data.*

Table 5 shows the quantitative features which describe the beta activity for one of the data sets.

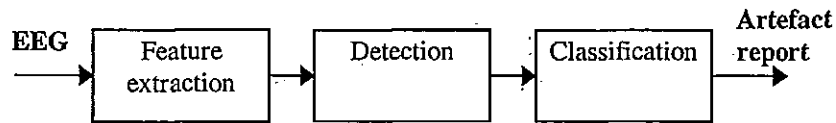


Feature	Quantitative description	Units
Frequency	19.8	Hz
Amplitude	24.000	$\mu\text{V}$
Absolute power	2.030e-12	$\text{V}^2$
Amplitude variability	1.1	$\mu\text{V}$ (norm.)
Frequency variability	1.6	Hz
Absolute power in eyes closed and eyes open data	4.263e-11 : 2.332e-11	$\text{V}^2$
Frequency in eyes eyes closed and eyes open data	19.8 : 19.5	Hz
Absolute power symmetry	1.0 : 0.9	ratio
Frequency symmetry	19.8 : 19.7	Hz
Absolute power / channel	2.9e-12/Fp1 2.5e-12/Fp2 1.2e-12/F7 ...	$\text{V}^2$
Relative power / channel	3.9/Fp1 3.7/Fp2 2.9/F7 5.7/F3 ...	%
Frequency / channel	19.4/Fp1 19.8/Fp2 19.4/F7 20.0/F3 ...	Hz

Table 5. *Quantitative features representing beta activity for one of the EEG data sets.*

## 5.5 Artefact Removal

Misleading results are obtained if the EEG is contaminated by artefacts. This is particularly so for blinks, eye movement and muscle artefacts which share many of their characteristics with EEG activities, such as wave shape and frequency. To overcome this problem, a new approach to EEG artefact identification has been developed within the research group (Wu et al. 1997). The technique uses neural networks together with a knowledge-based system to identify, for each channel, in each EEG segment, corruption due to eye blink, eye movement and muscle artefact. The block diagram in Figure 36 shows the stages of artefact identification, namely, feature extraction, detection and classification.



*Figure 36. Block diagram of the artefact identification system.*

Features that are characteristic of ocular artefacts and muscle artefacts include spectral shape and phase relationships between the left and right frontal EEG channels. These features are extracted using techniques such as parametric modelling and cross correlation to produce for each 4s segment, fifteen frequency features per channel and eight cross-correlation features. Three multilayer perceptron (MLP) neural networks (Bishop 1994) are subsequently used to perform blink, eye movement and muscle detection respectively. Each MLP detector was developed using the normal control data which was collected using the protocols and acquisition system described in Chapter 3. The final stage enhances the classification by incorporating heuristic criteria used by the electroencephalographer such as the spatial distribution of features on the scalp. These heuristics are implemented as rules in a rule-based system. For example the rule given in Table 6 uses spatial information to classify blink artefact.

---

IF the blink detector output is high in the left-frontal channel  
 AND the blink detector output is medium in the right-frontal channel  
 THEN the left frontal channel contains blink artefact  
 AND the right frontal channel contains blink artefact.

---

*Table 6. Heuristic criteria used to classify blink artefact.*

The performance of the system was tested using 60 segments of EEG test data pre-classified by the EEG experts. Out of the 1260 single channel EEG segments (60

segments x 21 channels of EEG), 94.52% were correctly classified. At the end of artefact classification, an artefact report is produced which labels each EEG segment with the types and locations of artefacts or as artefact-free (Table 7).

Channel	Segment #	Artefact
Fp1	38	blink, muscle
Fp2	38	blink, muscle
F7	38	muscle
F3	38	muscle
Fz	38	muscle
F4	38	muscle
F8	38	muscle
A1	38	artefact free
T3	38	muscle
C3	38	artefact free
Cz	38	artefact free
C4	38	artefact free
T4	38	muscle
A2	38	muscle
T5	38	artefact free
P3	38	artefact free
Pz	38	artefact free
P4	38	artefact free
T6	38	muscle
O1	38	artefact free
O2	38	artefact free

Table 7. Artefact report produced for a 4s segment of EEG.

The removal algorithm operated as follows (Riddington et al. 1996a). EEG corruption due to eye blink, eye movement and muscle artefact were identified in each  $j$ th channel in each  $k$ th EEG segment using the artefact processor. Activities identified during quantitative analysis by a peak at a frequency  $f_{i,j,k}$  Hz, were then labelled as *artefact corrupted*, if they co-existed in the frequency range for the type of artefact (i.e.  $< 4$ Hz for eye blinks and eye movement, and  $> 13$ Hz for muscle artefact). These activities were then excluded during the clustering procedure.

## 5.6 Summary

In this chapter, quantitative techniques were described which identify and describe the significant activities in the EEG, for the purpose of introducing consistency and efficiency in the clinical interpretation which is widely recognised as time consuming and suffering from inter- and intra-clinician variation.

DSP algorithms were developed to identify background activities in the power spectrum of 4 second EEG segments, and for each activity, to extract six basic time and frequency domain features. Artefact identification was carried out using the system described in Wu et al. (1997), which detected corruption by muscle and eye movement using the spectral properties and inter-channel relationships of the artefact and the heuristic rules used by the electroencephalographer. Activities deemed insignificant or corrupted by artefacts were then ignored. Next, data reduction was performed based on the leader cluster algorithm, to unify the segment-by-segment analysis. This produced clusters of features, each representing a delta, theta, alpha or beta activity in the entire EEG record. Quantitative descriptions for each cluster were then derived by processing the features.

## 5.7 References

Bishop, C. M. (1994) Neural networks and their applications. *Rev. Sci. Instrum.*, vol. 65, no. 6, pp. 1803-1832.

Frost, Jr., J. D., Hillman, Jr., C. E. and Kellaway, P. (1980) Automatic interpretation of EEG: Analysis of background activity. *Comput. biomed. Res.*, vol. 13, pp. 242-257.

Gotman, J., Gloor, P. and Ray, W. F. (1975) A quantitative comparison of traditional reading of the EEG and interpretation of computer-extracted features in patients with supratentorial brain lesions. *Electroencephalography and clinical Neurophysiology*, vol. 38, pp. 623-639.

Gotman, J., Skuce, D. R., Thompson, C. J., Gloor, P., Ives, J. R. and Ray, W. F. (1973) Clinical applications of spectral analysis and extraction of features from electroencephalograms with slow waves in adult patients. *Electroencephalography and clinical Neurophysiology*, vol. 35, pp. 225-235.

Hartigan, J. A. (1975) *Clustering Algorithms*, John Wiley and Sons, New York.

Ifeachor, E. C. and Jervis, B. W. (1993) *Digital Signal Processing: A Practical Approach*. Addison-Wesley Publishers Ltd., Wokingham, England.

Nakamura, M., Nishida, S., Neshige, R. and Shibasaki, H. (1985) Quantitative analysis of 'organisation' by feature extraction of the EEG power spectrum. *Electroencephalography and clinical Neurophysiology*, vol. 60, pp. 84-89.

Nakamura, M., Shibasaki, H., Imajoh, K., Nishida, S., Neshige, R. and Ikeda, A. (1992) Automatic EEG interpretation: A new computer-assisted system for the

automatic integrative interpretation of awake background EEG.

*Electroencephalography and clinical Neurophysiology*, vol. 82, pp. 423-431.

Pradhan, N., Narayana, D. N., and Satyam, S. (1993) A mimetic-based frequency domain technique for automatic generation of EEG reports. *Computers in Biology and Medicine*, vol. 23, no. 1, pp. 15-20.

Riddington, E. P., Wu, J., Ifeakor, E. C., Allen, E. M. and Hudson, N. R. (1996a) Intelligent enhancement and interpretation of EEG signals. *Proceedings of the IEE Colloquium on Artificial Intelligent Methods for Biomedical Data Processing*, Savoy Place, London. pp. 11/1-11/7.

Wu, J., Ifeakor, E. C., Allen, E. M., Wimalaratna, S. K. and Hudson, N. R. (1997) Intelligent artefact identification in electroencephalography signal processing. *IEE Proceedings - Science, Measurement and Technology* (accepted for publication).

# 6. Qualitative EEG analysis

---

## 6.1 Introduction

Two important outcomes of a clinical evaluation of the EEG are the factual report and the conclusion. The factual report is compiled by a clinical technician and describes the salient features in the EEG. It is then used by a clinical neurophysiologist to arrive at a diagnostic conclusion. However, both the factual report and the conclusion have been found to lack consistency and this has created the need to introduce objectivity in EEG evaluation, by producing the factual report and diagnostic interpretation automatically. In the previous chapter, techniques were described for quantitative description of the salient features of background activities. However, missing in this analysis are the qualitative descriptions which are used in practice. For example, uncertainty is often expressed in the analysis, using terms such as *very*, *more or less*, *extremely*. In this chapter, models based on fuzzy logic (Zadeh 1975a, 1975b, 1975c) are described that are used to analyse background activities (i.e. delta, theta, alpha and beta activity) using the underlying reasoning process used by clinical experts (Ifeachor et al. 1993, Riddington et al. 1994, 1996a, 1996b, 1996c and 1997). These models are used to describe three important features in the EEG. The organisation of each activity in terms of frequency and amplitude, the location of each activity on the scalp and the overall assessment regarding the degree of abnormality in the EEG. The outcome is an analysis which provides the qualitative descriptions such as

*somewhat irregular, frontal - more on the left or very possibly normal*, that complement the quantitative analysis.

## 6.2 Descriptive interpretation

In the previous chapter, DSP algorithms were developed to extract features which characterise background EEG activities. The outcome is an analysis of the EEG which is quantitative, where features such as *organisation* and *location* were described numerically. In practice however, many EEG features are described by the clinical experts in natural language terms such as *very high* or *somewhat irregular*. In this section, fuzzy models, based on approximate reasoning (Zadeh 1975a, 1975b, 1975c) are developed to provide the qualitative descriptions which were lacking in the quantitative analysis. These models describe the features *organisation* and *location* using natural language such as *somewhat irregular* or *frontal-more on the left*.

### 6.2.1 A model for describing the feature 'organisation'

*Organisation* is an important feature, particularly when assessing the dominant activity in the EEG (the dominant activity is defined as the activity having the largest power in the occipital channels). It is defined as the degree to which an activity conforms to certain ideal characteristics (Chatrjian et al. 1974). An 'ideal' activity is sinusoidal in shape and is described by the clinician as *regular*, whereas a 'non-ideal' activity has varying amplitude and frequency, and is described as



*irregular*. A further term, *moderately organised*, describes an activity which is neither *regular* nor *irregular*.

Organisation for each activity was assessed using the rules in Table 8.

---

<b>Rule 1:</b> IF amplitude variability is low AND frequency variability is low THEN the organisation is regular
<b>Rule 2:</b> IF amplitude variability is high AND frequency variability is low THEN the organisation is moderate
<b>Rule 3:</b> IF amplitude variability is low AND frequency variability is high THEN the organisation is moderate
<b>Rule 4:</b> IF amplitude variability is high AND frequency variability is high THEN the organisation is irregular

---

Table 8. Rules used to calculate the feature 'organisation'.

Each fuzzy term was defined by a membership function on a universe of values as follows. For *amplitude variability*, the fuzzy terms *low* and *high* were defined by membership functions  $\mu_{low}(a)$  and  $\mu_{high}(a)$  respectively; for *frequency variability*, the fuzzy terms *low* and *high* were defined by membership functions  $\mu_{low}(b)$  and  $\mu_{high}(b)$  respectively; and for *organisation*, the fuzzy terms *regular*, *moderately organised* and *irregular* were defined by membership functions  $\mu_{reg}(c)$ ,  $\mu_{mod}(c)$  and  $\mu_{irreg}(c)$  respectively. Each membership function was sigmoidal and was characterised by shape and roll-off points. The shapes, denoted  $z$ ,  $pi$  and  $s$ , are depicted in Figure 37 and defined in Equations 42, 43 and 44 (NRCC 1994).

$$s(x, a, b) = \begin{cases} 0, & x \leq a \\ 2\left(\frac{x-a}{b-a}\right)^2, & a < x \leq \frac{a+b}{2} \\ 1-2\left(\frac{x-b}{b-a}\right)^2, & \frac{a+b}{2} < x \leq b \\ 1, & b < x \end{cases} \quad (42)$$

$$z(x, a, b) = 1 - s(x, a, b) \quad (43)$$

$$pi(x, a, b, c, d) = \begin{cases} s(x, a, b), & x \leq b \\ 1, & b < x < c \\ z(x, c, d), & c \leq x \end{cases} \quad (44)$$

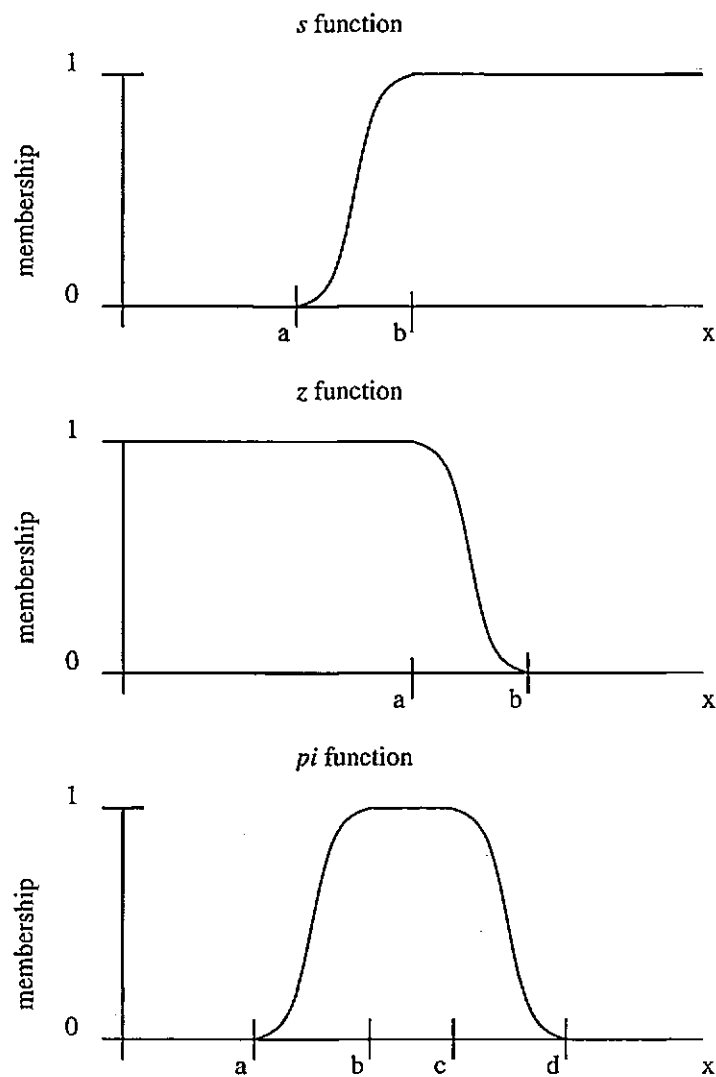


Figure 37. Membership function shapes used to represent each fuzzy term.

It should be noted that, although no change between sigmoidal and trapezoidal membership functions was observed in the results, sigmoidal shapes are intuitively preferred over trapezoidal shapes because they do not exhibit discontinuities.

The membership function roll-off points for  $\mu_{low}(a)$ ,  $\mu_{high}(a)$ ,  $\mu_{low}(b)$  and  $\mu_{high}(b)$  were defined as follows. Activities identified in 42 EEG segments from an EEG record were classified by clinicians as having either *low*, *borderline* or *high* amplitude variability and either *low*, *borderline* or *high* frequency variability. The quantitative feature *amplitude variability* was calculated for each category *low* and *high amplitude variability* and their mean values, denoted  $\bar{A}_{low}$  and  $\bar{A}_{high}$ , were used to define the roll-off points for the membership functions  $\mu_{low}(a)$  and  $\mu_{high}(a)$  as shown in Figure 38. Likewise, the quantitative feature *frequency variability* was calculated for each category *low* and *high frequency variability* and their mean values, denoted  $\bar{F}_{low}$  and  $\bar{F}_{high}$ , were used to define the roll-off points for the membership functions  $\mu_{low}(b)$  and  $\mu_{high}(b)$  as shown in Figure 39.

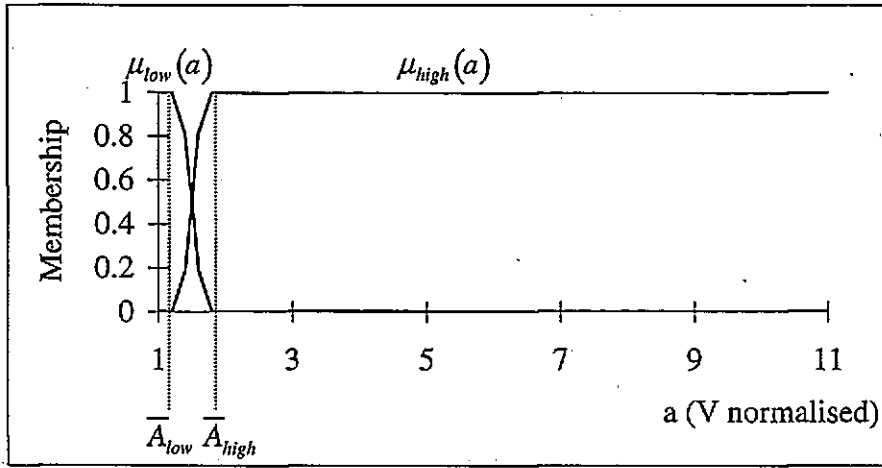


Figure 38. Membership functions defined for the terms 'low' and 'high' amplitude variability.

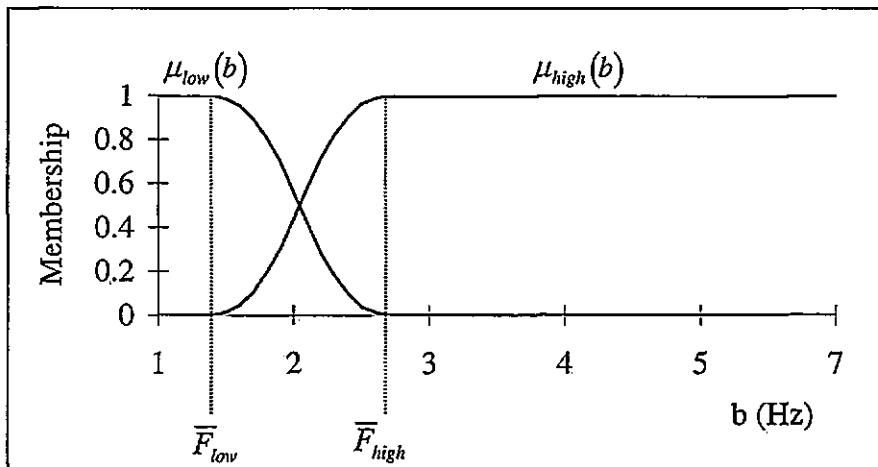


Figure 39. Membership functions defined for the terms 'low' and 'high' frequency variability.

The universe and the roll-off points for  $\mu_{reg}(c)$ ,  $\mu_{mod}(c)$  and  $\mu_{irreg}(c)$ , being unitless, were defined arbitrarily. Table 9 summarises the characteristics for each fuzzy term.

Membership function	Shape	1st roll-off point (a)	2nd roll-off point (b)	3rd roll-off point (c)	4th roll-off point (d)	Units
$\mu_{low}(a)$	<i>z</i>	1.062	1.136	-	-	$\mu\text{V}$ (norm.)
$\mu_{high}(a)$	<i>s</i>	1.062	1.136	-	-	$\mu\text{V}$ (norm.)
$\mu_{low}(b)$	<i>z</i>	1.785	2.056	-	-	Hz
$\mu_{high}(b)$	<i>s</i>	1.785	2.056	-	-	Hz
$\mu_{reg}(c)$	<i>z</i>	0	50	-	-	%
$\mu_{mod}(c)$	<i>pi</i>	25	50	50	75	%
$\mu_{irreg}(c)$	<i>s</i>	50	100	-	-	%

Table 9. Membership function shapes and roll-off points for each fuzzy term.

The membership functions for rules 1 - 4 in Table 8 can now be determined using Equations 45 - 48 respectively.

$$\mu_{P1}(a,b,c) = \min(\min(\mu_{low}(a), \mu_{low}(b)), \mu_{reg}(c)) \quad (45)$$

$$\mu_{P2}(a,b,c) = \min(\min(\mu_{low}(a), \mu_{high}(b)), \mu_{mod}(c)) \quad (46)$$

$$\mu_{P3}(a,b,c) = \min(\min(\mu_{high}(a), \mu_{low}(b)), \mu_{mod}(c)) \quad (47)$$

$$\mu_{P4}(a,b,c) = \min(\min(\mu_{high}(a), \mu_{high}(b)), \mu_{irreg}(c)) \quad (48)$$

These equations capture the relationship between each fuzzy term for each rule in Table 8 and were derived using the concepts outlined in Chapter 2 as follows. In Section 2.4.4, the *Lukasiewicz implication* operation given in Equation 49 was used to define the membership function that described the relationship between two fuzzy sets  $\mu(x)$  and  $\mu(y)$  in a rule, where  $\mu(x)$  represented the fuzzy term in the IF part of the rule and  $\mu(y)$  the fuzzy term in the THEN part.

$$\mu(x, y) = \text{IF } \mu(x) \text{ THEN } \mu(y) = \min(1, 1 - \mu(x) + \mu(y)) \quad (49)$$

It was indicated that other definitions for the implication operation have been proposed, eleven of which have been compared by Whalen and Schott (1985). One such implication operation which has found widespread use is called the *Mamdani* operation and is given in Equation 50.

$$\mu(x, y) = \text{IF } \mu(x) \text{ THEN } \mu(y) = \min(\mu(x), \mu(y)) \quad (50)$$

Now referring to the rules in Table 8. The IF part in each rule is composed of two fuzzy terms combined by the intersection operation given in Equation 51 to represent the AND connective (see Section 2.3.2 for an introduction on connectives).

$$\mu(u, v) = \mu(u) \text{ AND } \mu(v) = \min(\mu(u), \mu(v)) \quad (51)$$

The membership function which represents the relationship between each fuzzy term in each rule can thus be defined by substituting Equation 51 for  $\mu(x)$  in Equation 50 to produce Equation 52.

$$\mu(u, v, y) = \text{IF } \mu(u) \text{ AND } \mu(v) \text{ THEN } \mu(y) = \min(\min(\mu(u), \mu(v)), \mu(y)) \quad (52)$$

These membership functions capture the knowledge-base which will be used to determine a qualitative description for the feature *organisation*. The procedure for

inference using these fuzzy rules is described in Section 2.4.4. An example illustrating the inference procedure is also given in Appendix F. The procedure calculates the membership function of the fuzzy set which can be inferred given the membership function of a rule and the membership function of the facts on which the rules operate. In this case, the rules in Table 8 will operate on the quantitative features *amplitude variability*, denoted  $k_1$ , and *frequency variability*, denoted  $k_2$  (these features are described in detail in Chapter 5). Given that these features are not subjective and thus not fuzzy, their grades of membership, denoted  $\mu_{k_1}(a)$  and  $\mu_{k_2}(b)$  respectively, were defined as single discrete values called *singletons*, i.e.  $\mu_{k_1}(a)=1$  when  $a=k_1$  and  $\mu_{k_1}(a)=0$  elsewhere, and likewise,  $\mu_{k_2}(b)=1$  when  $b=k_2$  and  $\mu_{k_2}(b)=0$  elsewhere. An example illustrating the singleton membership function  $\mu_{k_1}(a)$  is given in Figure 40.

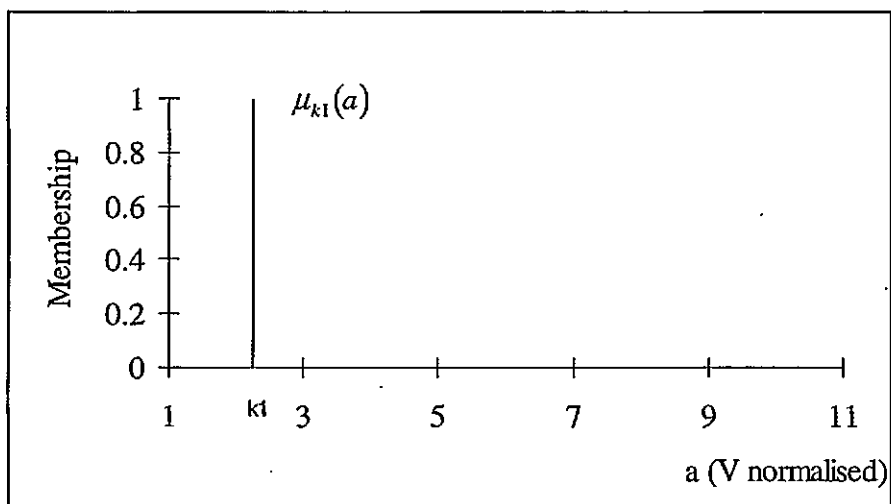


Figure 40. Membership function example for a single, non-fuzzy value.

Facts may be represented as a single membership function by using the intersection operation (Yager 1984). For example, Equation 53 gives the membership function, denoted  $\mu_Q(a,b)$ , to represent the facts  $\mu_{k1}(a)$  and  $\mu_{k2}(b)$ .

$$\mu_Q(a,b) = \min(\mu_{k1}(a), \mu_{k2}(b)) \quad (53)$$

The inference which can be made from the rules and facts can be determined using the compositional rule of inference given in Equation 54 (Zadeh 1975c).

$$\mu_{Ri}(c) = \max_{a,b}(\min(\mu_{Pi}(a,b,c), \mu_Q(a,b))) \quad (54)$$

where  $\mu_{Pi}(a,b,c)$  is the membership function for rule  $i$ ,  $\mu_Q(a,b)$  is the membership function for the facts and  $\mu_{Ri}(c)$  is the membership function of the deduction. The  $\max_{a,b}$  operation calculates the maximum across the variables  $a$  and  $b$ .

The contribution  $\mu_{Ri}(c)$ , made by each rule, may be combined according to Equation 55 (Turksen and Tian 1993), to produce what is called, the 'global' deduction,  $\mu_R(c)$ .

$$\mu_R(c) = \min_i(\mu_{Ri}(c)) \quad (55)$$

Whilst the membership function  $\mu_R(c)$  represents *organisation*, its meaning remains to be articulated. This can be achieved by a process called 'linguistic



approximation'. A 'fuzzy library' is constructed to represent the linguistic values used to describe organisation using terms such as *very irregular*, *somewhat moderately organised* etc. The value having the closest measure of similarity to  $\mu_R(c)$  is then selected as the linguistic description. To construct the fuzzy library, values are typically built using a vocabulary of terms such as (i) primary sets, in this case *regular*, *moderately organised* and *irregular*; (ii) hedges, such as *very*, *somewhat*, *extremely* etc.; and (iii) connectives, such as *not*, *and* and *or* (Wenstop 1980). Many possible values in the library may thus exist such as *somewhat irregular*, *not very regular* etc. In this case, combinations between the primary sets *regular*, *moderately organised* and *irregular*, denoted by  $\mu_{reg}(c)$ ,  $\mu_{mod}(c)$  and  $\mu_{irreg}(c)$ , which are defined in Table 9, and the hedges *extremely*, *very*, *somewhat* and *more or less* which are defined as power operations on the primary sets by the values 3, 2, 0.5 and 0.333 respectively (see Section 2.3.2 for a description on fuzzy operations), were deemed a sufficiently detailed library. Let  $\mu_m(c)^n$  denote the membership functions of the fuzzy library, where the primary sets are represented by the variable  $m$  ( $m = reg, mod$  or  $irreg$ ) and the hedge operation by the variable  $n$  ( $n = 3, 2, 1, 0.5$  or  $0.333$ , where  $n = 1$  represents no hedge). For example, membership function for the linguistic value *extremely irregular* would be denoted  $\mu_{irreg}(c)^3$ . The linguistic value with the closest measure of similarity to  $\mu_R(c)$  was finally selected using the measure of similarity of two fuzzy sets,  $s_{n,m}$ , given in Equation 56 (Sugeno and Yasukawa 1993), where  $0 \leq s_{n,m} \leq 1$ .

$$s_{n,m} = \frac{\sum_c \min(\mu_R(c), \mu_m(c)^n)}{\sum_c \max(\mu_R(c), \mu_m(c)^n)} \quad (56)$$

### 6.2.2 A model for describing the feature 'location'

To describe 'location', the scalp is normally divided into regions which correspond to the anatomical regions of the brain such as *frontal*, *central*, *temporal*, *parietal*, and *occipital*. Whilst most electrodes of the 10-20 system lie within these regions, some lie exactly midway. For example electrodes C3, Cz and C4 lie midway between the regions *posterior* and *anterior*. These electrodes may thus be considered partial members according to fuzzy set theory. Further, certain electrodes within a region may be considered members to a degree greater than others e.g. the membership of the electrodes Fp1 and Fp2 to the region *anterior* may be considered greater than the membership of the electrodes F3, Fz and F4. Finally, whilst the positions of the electrodes are fixed, the location of abnormalities and EEG activity, in terms of these points, can often be fuzzy. For example, the location of an activity may be described as *frontal - more on the left*.

Each expression used to describe 'location' can be represented using fuzzy sets whose discrete membership values represent the membership of a particular EEG channel to a region on the scalp. For example, let  $\mu_u(x)$  denote the grade of membership of channel  $x$ , to region  $u$ , where  $x$  is a variable representing a channel such as defined by the 10-20 placement system, and  $u$  is a region such as *frontal*, *occipital* etc. A typical example is the location *posterior*, a region at the back of the head. This region may be represented by the membership function,  $\mu_u(x)$ ,

given in Equation 57, where  $u = \text{posterior}$  and  $x \in \{\text{Fp1, Fp2, F7, F3, Fz, F4, F8, A1, T3, C3, Cz, C4, T4, A2, T5, P3, Pz, P4, T6, O1 and O2}\}$ .

$$\mu_{\text{posterior}}(x) = \{0, 0, 0.2, 0.2, 0.2, 0.2, 0.2, 0.2, 0.5, 0.5, 0.5, 0.5, 0.5, 0.5, 0.5, 0.8, 0.8, 0.8, 0.8, 0.8, 1, 1\} \quad (57)$$

The fuzzy library for 'location' which can be represented using this method, can be expanded using fuzzy hedges such as *right* or *more on the left* to produce expressions such as *frontal - more on the left, right posterior* etc. For example, let  $\mu_u^v(x)$  denote the grade of membership of channel  $x$ , to region  $u$ , modified by the hedge  $v$ , where  $v$  is a fuzzy hedge such as *left*, *right*, *more on the left* or *more on the right* as defined according to Equation 58, 59, 60 and 61.

$$\mu_u^{\text{left}}(x) = \begin{cases} \mu_u(x) & \text{for } x = \text{Fp1, F7, F3, A1, T3, C3, T5, P3 and O1} \\ \mu_u(x)/2 & \text{for } x = \text{Fz, Cz, Pz} \\ 0 & \text{otherwise} \end{cases} \quad (58)$$

$$\mu_u^{\text{right}}(x) = \begin{cases} \mu_u(x) & \text{for } x = \text{Fp2, F4, F8, C4, T4, A2, P4, T6 and O2} \\ \mu_u(x)/2 & \text{for } x = \text{Fz, Cz, Pz} \\ 0 & \text{otherwise} \end{cases} \quad (59)$$

$$\mu_u^{\text{more on the left}}(x) = \begin{cases} \mu_u(x) & \text{for } x = \text{Fp1, F7, F3, A1, T3, C3, T5, P3 and O1} \\ \mu_u(x)/3 & \text{for } x = \text{Fz, Cz, Pz} \\ \mu_u(x)/6 & \text{otherwise} \end{cases} \quad (60)$$

$$\mu_u^{\text{more on the right}}(x) = \begin{cases} \mu_u(x) & \text{for } x = \text{Fp2, F4, F8, C4, T4, A2, P4, T6 and O2} \\ \mu_u(x)/3 & \text{for } x = \text{Fz, Cz, Pz} \\ \mu_u(x)/6 & \text{otherwise} \end{cases} \quad (61)$$

An example is the location *posterior - more on the left*. This region may be represented by the membership function,  $\mu_u^v(x)$ , given in Equation 62, where  $u = \textit{posterior}$ ,  $v = \textit{more on the left}$ , and  $x \in \{\text{Fp1, Fp2, F7, F3, Fz, F4, F8, A1, T3, C3, Cz, C4, T4, A2, T5, P3, Pz, P4, T6, O1 and O2}\}$ .

$$\mu_{\textit{posterior}}^{\textit{more on the left}}(x) = \{0, 0, 0.2, 0.2, 0.15, 0.1, 0.1, 0.5, 0.5, 0.5, 0.375, 0.25, 0.25, 0.5, 0.8, 0.8, 0.6, 0.4, 0.4, 1, 0.5\} \quad (62)$$

The 'location' for each EEG activity can also be represented by a membership function. The power calculated for an activity at each EEG channel, denoted by  $p(x)$ , characterises the distribution of the amount of EEG activity across the scalp. When normalised to unity,  $p(x)$  may be used to define the membership function location, denoted  $\mu_p(x)$ , using Equation 63.

$$\mu_p(x) = \frac{p(x)}{\max_x(p(x))} \quad (63)$$

The linguistic expression which describes  $\mu_p(x)$  may now be determined by performing linguistic approximation, where the region from the fuzzy library  $\mu_u^v(x)$  having the closest measure of similarity  $s_{u,v}$ , is selected using Equation 64, where  $0 \leq s_{u,v} \leq 1$ .

$$s_{u,v} = \frac{\sum_x \min(\mu_p(x), \mu_u^v(x))}{\sum_x \max(\mu_p(x), \mu_u^v(x))} \quad (64)$$

## **6.3 Diagnostic interpretation**

An important outcome during the clinical evaluation is the diagnostic conclusion provided by the clinical neurophysiologist. Previous computerised methods of EEG analysis for patients with Alzheimer's disease have used statistical techniques to analyse quantitative features such as frequency band power (Streletz et al. 1990, Szekely et al. 1992). In this section, a qualitative method is described which provides a measure of the degree of abnormality in the EEG of patients with Alzheimer's disease using an analysis which is qualitative. The method assesses the EEG using four quantitative features and the underlying rules of the clinical experts. These rules have been implemented in a fuzzy rule-based system, to assess the degree of abnormality in the Alzheimer's EEG.

### **6.3.1 Characteristics of the normal and Alzheimer's EEG**

In this section the features which characterise the normal and the Alzheimer's EEG are first highlighted and then fuzzy models for assessing the degree of abnormality are developed.

#### **The normal adult EEG**

In normal adults, the EEG is characterised predominantly by background activity called the alpha rhythm. This activity is usually between 9 and 11Hz, located at the back of the head, attenuates in amount on eye opening, dominates the occipital region (see Figure 41), ranges in amplitude from 50-100mV and should be symmetrical between both hemispheres in amount and frequency (Binnie 1982 pp.



21-25; Kiloh et al. 1981 pp. 64-67 and Visser 1991). The other major activity in normal adults is beta activity i.e. a background activity greater than 13Hz. This activity is typically greatest in amplitude over the anterior region and ranges in amplitude from 10-50mV (Binnie 1982 pp.25-26). A background activity in the theta range is generally present in small amounts over the temporal regions but is not a prominent feature (Binnie 1982 pp. 25-27). Finally, an activity in the alpha range called the *mu* rhythm which consists of runs of arch-like waves having a frequency between 7 and 11Hz is sometimes present over central regions and is suppressed not by eye opening but by arm or leg movement (Binnie 1982 pp. 27-28 and Kiloh et al. 1981 pp. 67-68).

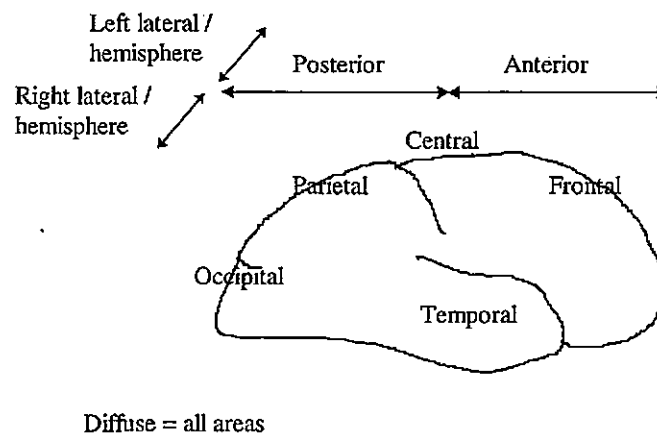


Figure 41. Physiological regions of the brain.

Changes in background activity with age are a reduction in the alpha rhythm frequency by between 0.5 and 1Hz, a slight reduction in the alpha rhythm reactivity to eye opening and an increase in the amount of theta and delta activity (Visser 1991).

## **The Dementia EEG**

Dementia, the decline of memory and other cognitive functions, is a condition caused by disorders such as Alzheimer's disease, manic depression, Parkinson's disease, multi-infarct dementia and drug intoxication (McKhann et al. 1984). Diagnosing these disorders is essential for determining the appropriate therapy. The EEG in dementia is characterised by a reduction in frequency, amount (the feature *relative power*) and reaction to eye opening of the alpha rhythm, the latter being a highly sensitive sign. In severe dementia, the alpha rhythm is absent. A considerable excess of slow activity is also present (Visser 1991).

## **The Alzheimer's disease EEG**

The most common disorder responsible for dementia is Alzheimer's disease, a brain disorder characterised by a progressive dementia (McKhann et al. 1984), that occurs as early as the age of 40 years but is most commonly seen after the age of 60 years (Khachaturian 1985). Clinical criteria for the diagnosis of Alzheimer's disease have been devised by McKhann et al. (1984). A definite diagnosis is made on evidence obtained from autopsy or biopsy. A probable diagnosis is made on the exclusion of other possible causes of dementia and a possible diagnosis is given if other possible causes of dementia are present but Alzheimer's is considered the more likely. The diagnosis of Alzheimer's is largely based on clinical and psychological assessments. Laboratory assessments such as electroencephalography and computerised tomography, usually either have a confirmatory role, or enhance the diagnostic accuracy by excluding other causes of



dementia (McKhann et al. 1984). However, the EEG is *the* functional additional examination that does not place any stress on the patient. It is also easy to perform and is low cost. In the Alzheimer's EEG, a reduction in frequency, amount (the feature *relative power*) and absence in reactivity of the alpha rhythm plus an excess of slow activity are almost always found, hence a diagnosis must be re-evaluated if none are found (Visser 1991).

### 6.3.2 A model to determine the degree of normality or abnormality in the EEG

The degree of abnormality in the EEG was assessed using four quantitative features. From the dominant activity, the features: *relative power*, *change in power with eye opening*, and *frequency* were calculated, and from slow activities i.e. less than 8Hz, the total *absolute power* was calculated. These features were assessed using twenty-two rules, two of which are shown in Table 10.

---

**Rule 16:**

IF the dominant occipital rhythm amount is not small  
AND the dominant occipital rhythm attenuates with eye opening  
AND the dominant occipital rhythm frequency is alpha  
AND the amount of slow activity is below moderate  
THEN EEG is probably normal

**Rule 9:**

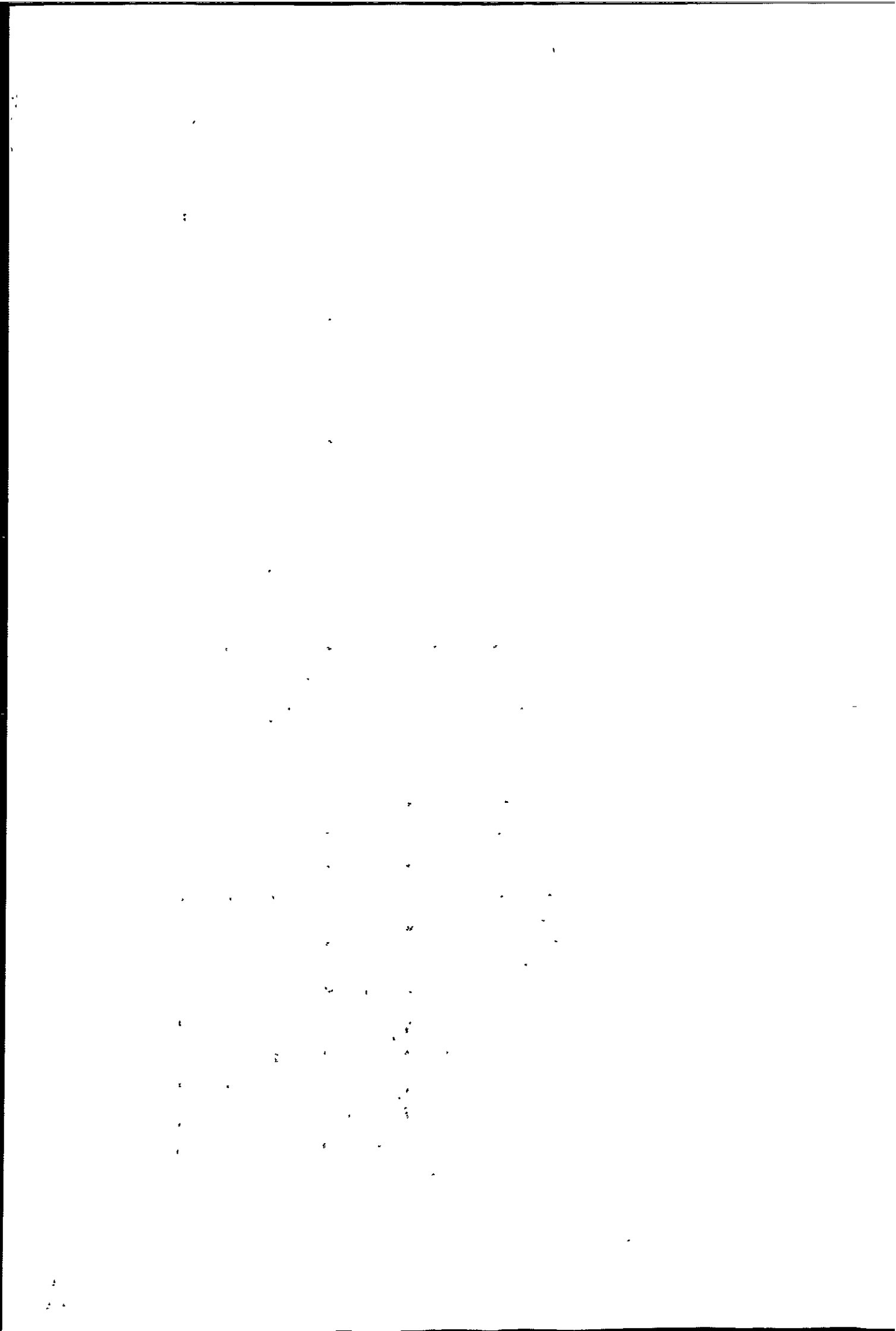
IF the dominant occipital rhythm amount is not small  
AND the dominant occipital rhythm does not change with eye opening  
AND the dominant occipital rhythm frequency is very slow alpha  
AND the amount of slow activity is above small  
THEN EEG is probably abnormal

---

*Table 10. Two rules used to determine the degree of abnormality in the EEG.*

Rules 16 and 9 were used to determine the probable degree of normality or abnormality in the EEG. In rule 16, the 1st, 2nd and 3rd premises determine whether a dominant occipital rhythm exists, whether it attenuates in amount with eye opening and whether it has a frequency within the normal region of the alpha band. The 4th premise determines whether slow activity, which is usually considered abnormal in the adult, exists in small amounts only. If all premises are satisfied, the EEG is declared *probably normal*. If the dominant occipital rhythm does not change with eye opening and it has a frequency at the lowest end of the alpha band, and if a sufficient amount of slow activity is present, rule 9 will declare the EEG *probably abnormal*. Other rules provide the analysis for EEG's which are *possibly normal*, *possibly abnormal* and *equivocal*. All the rules are listed in Appendix G.

Each fuzzy term was defined by a membership function on a universe of values as follows. For the dominant rhythm *relative power*, the fuzzy terms *small* and *not small* were defined by membership functions  $\mu_{small}(d)$  and  $\mu_{nsmall}(d) = 1 - \mu_{small}(d)$ , respectively; for dominant rhythm *change in power with eye opening*, the fuzzy terms *increases*, *does not change*, *slightly attenuates* and *attenuates* were defined by membership functions  $\mu_{incr}(e)$ ,  $\mu_{dnc}(e)$ ,  $\mu_{satten}(e)$  and  $\mu_{atten}(e)$  respectively; for dominant rhythm *frequency*, the fuzzy terms *above alpha*, *alpha*, *slow alpha*, *very slow alpha* and *below alpha* were defined by membership functions  $\mu_{aalpha}(f)$ ,  $\mu_{alpha}(f)$ ,  $\mu_{salpha}(f)$ ,  $\mu_{vsalpha}(f)$  and  $\mu_{balpha}(f)$  respectively; for slow activity *absolute power*, the fuzzy terms *insignificant*, *small*, *above small*, *below moderate*, *moderate* and *large* were defined by membership functions



$\mu_{insig}(g)$ ,  $\mu_{small}(g)$ ,  $\mu_{asmall}(g)$ ,  $\mu_{bmod}(g)$ ,  $\mu_{mod}(g)$  and  $\mu_{large}(g)$  respectively; finally, for *abnormality* the fuzzy terms *probably normal*, *possibly normal*, *equivocal*, *possibly abnormal* and *probably abnormal* were defined by membership functions  $\mu_{pnorm}(h)$ ,  $\mu_{ponorm}(h)$ ,  $\mu_{equ}(h)$ ,  $\mu_{poab}(h)$  and  $\mu_{prab}(h)$  respectively. Each membership function was sigmoidal and was characterised by shape and roll-off points. Table 11 summarises the characteristics for each fuzzy term.

Membership function	Shape	1st roll-off point (a)	2nd roll-off point (b)	3rd roll-off point (c)	4th roll-off point (d)	Units
$\mu_{small}(d)$	<i>z</i>	5	20	-	-	%
$\mu_{incr}(e)$	<i>z</i>	-50	0	-	-	%
$\mu_{dnc}(e)$	<i>pi</i>	-50	0	0	50	%
$\mu_{satten}(e)$	<i>pi</i>	12.5	37.5	37.5	62.5	%
$\mu_{atten}(e)$	<i>s</i>	12.5	37.5	-	-	%
$\mu_{alpha}(f)$	<i>s</i>	10	11.5	-	-	Hz
$\mu_{alpha}(f)$	<i>pi</i>	8.5	10	10	11.5	Hz
$\mu_{salpha}(f)$	<i>pi</i>	7.5	9	9	10.5	Hz
$\mu_{vsalpha}(f)$	<i>pi</i>	6.5	8	8	9.5	Hz
$\mu_{balpha}(f)$	<i>z</i>	6.5	8	-	-	Hz
$\mu_{insig}(g)$	<i>z</i>	0	0.5e-11	-	-	V <sup>2</sup>
$\mu_{small}(g)$	<i>pi</i>	0	0.5e-11	0.5e-11	1e-11	V <sup>2</sup>
$\mu_{asmall}(g)$	<i>s</i>	0.5e-11	1e-11	-	-	V <sup>2</sup>
$\mu_{bmod}(g)$	<i>z</i>	0.5e-11	1e-11	-	-	V <sup>2</sup>
$\mu_{mod}(g)$	<i>pi</i>	0.5e-11	1e-11	1.75e-11	3e-11	V <sup>2</sup>
$\mu_{large}(g)$	<i>s</i>	1.75e-11	3e-11	-	-	V <sup>2</sup>
$\mu_{pnorm}(h)$	<i>z</i>	10	30	-	-	%
$\mu_{ponorm}(h)$	<i>pi</i>	10	30	30	50	%
$\mu_{equ}(h)$	<i>pi</i>	30	50	50	70	%
$\mu_{poab}(h)$	<i>pi</i>	50	70	70	90	%
$\mu_{prab}(h)$	<i>s</i>	70	90	-	-	%

Table 11. Membership function shapes and roll-off points for each fuzzy term.

The procedure which was used to develop the fuzzy model to determine the degree of normality of abnormality followed the exact steps outlined in Section 6.2.1. For example, the membership functions for rules 16 and 9 were determined using Equation 65 and 66 respectively.

$$\mu_{p16}(d, e, f, g, h) = \min(\min(\mu_{nsmall}(d), \mu_{atten}(e), \mu_{alpha}(f), \mu_{bmod}(g)), \mu_{pnorm}(h)) \quad (65)$$

$$\mu_{p9}(d, e, f, g, h) = \min(\min(\mu_{nsmall}(d), \mu_{dnc}(e), \mu_{vsalpha}(f), \mu_{asmall}(g)), \mu_{prab}(h)) \quad (66)$$

where  $\mu_{pi}(d, e, f, g, h)$  denotes the membership function representing rule  $i$ .

The facts *relative power*, *change in power with eye opening* and *frequency*, denoted by  $k3$ ,  $k4$ ,  $k5$  and  $k6$  were represented by singleton membership functions  $\mu_{k3}(d)$ ,  $\mu_{k4}(e)$ ,  $\mu_{k5}(f)$  and  $\mu_{k6}(g)$ , respectively. These were then represented by a single membership function  $\mu_Q(d, e, f, g)$  using Equation 67.

$$\mu_Q(d, e, f, g) = \min(\mu_{k3}(d), \mu_{k4}(e), \mu_{k5}(f), \mu_{k6}(g)) \quad (67)$$

The composition of each rule with the facts represented by the membership functions  $\mu_{pi}(d, e, f, g, h)$  and  $\mu_Q(d, e, f, g)$  respectively, produced the deduction  $\mu_{Ri}(h)$  (Equation 68).

$$\mu_{Ri}(c) = \max_{d, e, f, g} (\min(\mu_{pi}(d, e, f, g, h), \mu_Q(d, e, f, g))) \quad (68)$$

Each deduction made by each rule, were combined according to Equation 69 to produce the overall deduction,  $\mu_R(h)$ .

$$\mu_R(h) = \min_i(\mu_{Ri}(h)) \quad (69)$$

Linguistic approximation was then performed. Combinations between the primary sets *probably normal*, *possibly normal*, *equivocal*, *possibly abnormal* and *probably abnormal*, denoted by  $\mu_{prnorm}(h)$ ,  $\mu_{ponorm}(h)$ ,  $\mu_{equ}(h)$ ,  $\mu_{poab}(h)$  and  $\mu_{prab}(h)$ , which are defined in Table 11, and the hedges *extremely*, *very*, *somewhat* and *more or less*, which are defined as power operations on the primary sets by the values 3, 2, 0.5 and 0.333 respectively, were deemed a sufficiently detailed library. Let  $\mu_m(h)^n$  denote the membership functions of the fuzzy library, where the primary sets are represented by the variable  $m$  ( $m = prnorm, ponorm, equ, poab$  and  $prab$ ) and the hedge operation by the variable  $n$  ( $n = 3, 2, 1, 0.5$  and  $0.333$ , where  $n = 1$  represents no hedge operation). The linguistic value with the closest measure of similarity to  $\mu_R(h)$  was then determined using the measure of similarity of two fuzzy sets  $s_{n,m}$ , given in Equation 70, where  $0 \leq s_{n,m} \leq 1$ .

$$s_{n,m} = \frac{\sum_h \min(\mu_R(h), \mu_m(x)^n)}{\sum_h \max(\mu_R(h), \mu_m(x)^n)} \quad (70)$$

## 6.4 Tools and methods

The system was implemented off-line on a personal computer using the C programming language, a PC-based application for artefact identification and *FuzzyCLIPS*, a knowledge-based system development environment. Data collection, power spectrum estimation and the basic feature extraction algorithms were implemented in C, artefact identification was performed using the PC-based tool described in Wu et al. (1997) and artefact removal, clustering and the fuzzy models were implemented using *FuzzyCLIPS*. In this section, an overview is given of the use of the knowledge-based system development environment, *FuzzyCLIPS*, for implementing the fuzzy models. For a system user guide that details the steps required to obtain an automated interpretation of the EEG, see Appendix H.

*FuzzyCLIPS*<sup>6</sup> is an extension of *CLIPS*<sup>7</sup> a knowledge-based system development environment which has found widespread acceptance through flexibility and ease of use. *CLIPS* was developed by NASA in C and can be easily integrated with C based applications. *FuzzyCLIPS* extends *CLIPS* by adding fuzzy systems functionality such as fuzzy data representation and fuzzy reasoning.

---

<sup>6</sup> *FuzzyCLIPS*, National Research Council of Canada, Institute for Information technology (www address: ai.iit.nrc.ca)

<sup>7</sup> *CLIPS*, NASA/Johnson Space Center (www address: www.jsc.nasa.gov)

The artefact report described in Section 5.5 and the basic EEG features described in Section 5.3 for each EEG segment are passed to the FuzzyCLIPS environment as data structures called *facts*. Table 12 depicts two such facts. The first describes the frequency of the second EEG waveform identified in EEG segment number 38 and in channel Fp1, the second states the presence of a blink artefact in the same segment and channel.

---

(segment 38 channel Fp1 waveform 2 frequency 24.2)  
 (segment 38 channel Fp1 artefact blink)

---

*Table 12. Facts used in the FuzzyCLIPS environment to describe the frequency of an EEG waveform and the presence of a blink artefact.*

The quantitative features described in Section 5.4 are then created as new facts by implementing within the FuzzyCLIPS environment the artefact removal described in Section 5.5 and the cluster algorithm described in Section 5.4. For example, Table 13 depicts the new facts which would be used to represent the quantitative features which are given in Table 5.

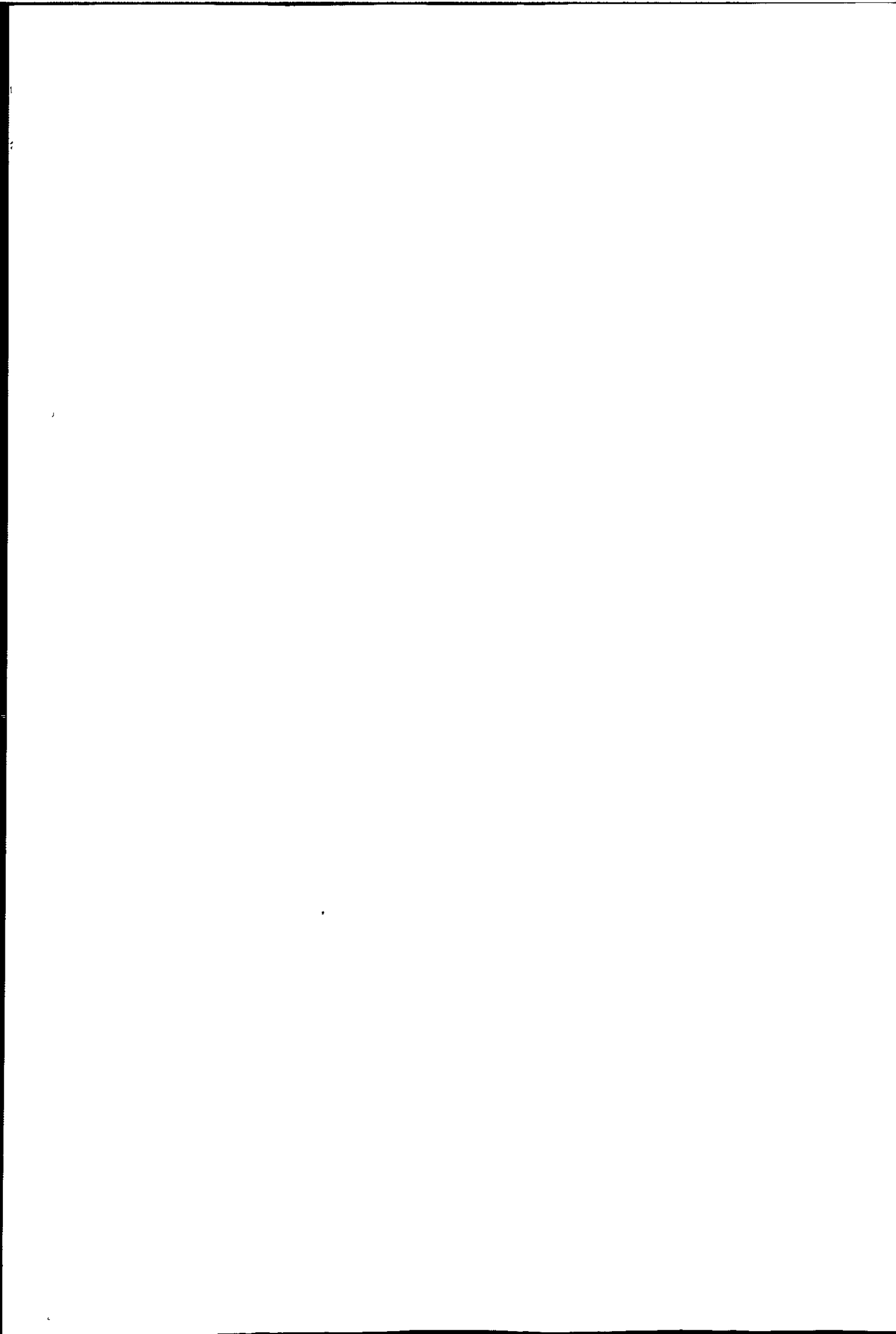
---

(activity 1 frequency 19.8)  
 (activity 1 amplitude 24.000)  
 (activity 1 absolute\_power 2.030e-12)  
 (activity 1 amplitude\_variability 1.1)  
 (activity 1 frequency\_variability 1.6)  
 (activity 1 absolute\_power\_in\_eyes\_closed\_and\_eyes\_opening\_data 4.263e-11 2.332e-11)  
 (activity 1 frequency\_in\_eyes\_closed\_and\_eyes\_opening\_data 19.8 19.5)  
 (activity 1 absolute\_power\_symmetry 1.0 0.9)  
 (activity 1 frequency\_symmetry 19.8 19.7)  
 (activity 1 absolute\_power\_per\_channel 2.9e-12 2.5e-12 1.2e-12 ... )  
 (activity 1 relative\_power\_per\_channel 3.9 3.7 2.9 5.7 ... )  
 (activity 1 frequency\_per\_channel 19.4 19.8 19.4 20.0 ... )

---

*Table 13. Facts representing the quantitative features in Table 5.*





The fuzzy models which operate using these facts were implemented in FuzzyCLIPS as follows. Each fuzzy value described in Table 9 and Table 11 was first defined within the FuzzyCLIPS environment. For example, Table 14 shows the format for defining the fuzzy values *low* and *high* for the variable *amplitude variability*.

```

(amplitude_variability
  1 11 volts_normalised
  (
    (low (z 1.062 1.136))
    (high (s 1.062 1.136))
  )
)

```

Table 14. An example showing the format used in FuzzyCLIPS for defining fuzzy values.

Each rule described in Table 8 and Table 10 was then defined within the FuzzyCLIPS environment. For example, Table 15 shows the format for defining the rule *if amplitude variability is low and frequency variability is low then organisation is regular*.

```

(if
  (waveform ?x amplitude_variability low)
  (waveform ?x frequency_variability low)
  then
  (waveform ?x organisation regular))

```

Table 15. An example showing the format used in FuzzyCLIPS for defining fuzzy rules.

Note the implicit *and* between lines 2 and 3 and the implicit *is* in lines 2, 3 and 4. The symbol *?x* is a dummy variable used to pass values between the IF part of the rule and the THEN part of the rule. These rules *execute* when the facts which represent each of the variables in the IF part of the rule have been created, such as

lines 4 and 5 in Table 15. When this occurs, the FuzzyCLIPS *inference engine* will carry out the inference process described in Section 6.2.1 and Section 6.3.2.

## 6.5 Summary

An aim of the work described in the thesis is to introduce objectivity and hence consistency in the clinical factual report and the clinical conclusion by developing a system to provide these interpretations automatically. In Chapter 5, DSP algorithms were developed which identified the significant activities in the EEG and described the salient features of each activity quantitatively. Lacking in the quantitative analysis however, were the descriptions used in practice to describe features which are qualitative. For example, the features *amplitude variability* and *frequency variability*, which were calculated in Chapter 5, provide a quantitative measure of the clinical feature *organisation*. However, in practice, *organisation* is described qualitatively, using terms such as *somewhat regular* or *very irregular* etc. Likewise, to indicate the distribution, or *location*, of the activity on the scalp, a measure of the power for the activity is given at each EEG channel. In practice however, *location* is described in terms of the physiological regions of the brain such as *left-occipital* or *frontal-more on the left* etc.

In this chapter, models based on fuzzy logic (Zadeh 1975a, 1975b, 1975c) have been described, which analyse EEG activities using the underlying reasoning process used by the clinical experts. The models are used to describe three important features in the EEG: organisation (the variability of amplitude and

frequency) of each activity; location of each activity and overall assessment regarding the degree of abnormality in the EEG.

## 6.6 References

Binnie, C. D., Rowan, A. J. and Gutter, T. H. (1982) A Manual of Electroencephalographic Technology. Cambridge University Press, Cambridge.

Chatrian, G. E., Bergamini, L., Dondey, M., Klass, D. W., Lennox-Buchthal, M. and Petersen, I. (1974) A glossary of terms most commonly used by clinical electroencephalographers. *Electroencephalography and clinical Neurophysiology*, vol. 82, pp. 423-431.

Ifeachor, E. C. and Riddington, E. P. (1993) Use of artificial intelligence in EEG evaluation. The Electrophysiological Technologists' Scientific Meeting, Postgraduate Medical Centre, Derriford Hospital, Plymouth.

Khachaturian, Z. S. (1985) Diagnosis of Alzheimer's disease. *Arch. Neurol.*, Vol. 42, pp. 1097-1105.

Kiloh, L. G., McComas, A. J., Osselton, J. W. and Upton, A. R. M. (1981) *Clinical Electroencephalography*. 4<sup>th</sup> Edition. Butterworths and Co. (Publishers) Ltd., London.

McKhann, G., Drachman, D., Folstein, M., Katzman, R., Price, D. and Stadlan, E. M. (1984) Clinical diagnosis of Alzheimer's disease: Report of the NINCDS-ADRDA work group under the auspices of the Dept. Health and Human Services Task Force on Alzheimer's disease. *Neurology*, vol. 34, pp. 939-944.

NRCC (National Research Council Canada) (1994) FuzzyCLIPS Version 6.02A User's Guide.

Riddington, E. P., Ifeachor, E. C., Allen, E. M., Hudson, N. R. and Mapps, D. J. (1994) A fuzzy expert system for EEG interpretation. *Proceedings of the International Conference on Neural Networks and Expert Systems in Medicine and Healthcare*, University of Plymouth, Plymouth. pp. 291-302.

Riddington, E. P., Wu, J., Ifeachor, E. C., Allen, E. M. and Hudson, N. R. (1996a) Intelligent enhancement and interpretation of EEG signals. *Proceedings of the IEE Colloquium on Artificial Intelligent Methods for Biomedical Data Processing*, Savoy Place, London. pp. 11/1-11/7.

Riddington, E. P., Ifeachor, E. C., Allen, E. M., Hudson, N. R. and Mapps, D. J. (1996b) Investigation into different methods of fuzzy inference using ROC analysis. *Proceedings of the 2<sup>nd</sup> International Conference on Neural Networks and Expert Systems in Medicine and Healthcare*, University of Plymouth, Plymouth. pp. 104-111.

Riddington, E. P., Ifeakor, E. C., Allen, E. M., Hudson, N. R. and Mapps, D. J. (1996c) Knowledge-based enhancement and interpretation of EEG signals. *Proceedings of the 2<sup>nd</sup> International Conference on Neural Networks and Expert Systems in Medicine and Healthcare*, University of Plymouth, Plymouth. pp. 246-255.

Riddington, E. P., Ifeakor, E. C., Allen, E. M., Hudson, N. R., Wimalaratna, H. S. K. and Mapps, D. J. (1997) Automated qualitative interpretation of EEGs using fuzzy logic. The British Society for Clinical Neurophysiology (formerly the EEG Society) Scientific Meeting, National Hospital for Neurology and Neurosurgery, London. January, 1997.

Streletz, L. J., Reyes, P. F., Zalewska, M., Katz, L. and Fariello, R. G. (1990) Computer analysis of EEG activity in dementia of the Alzheimer's type and Huntington's disease. *Neurobiology of Aging*, vol. 11, pp. 15-20.

Szelies, B., Grond, M., Herholz, K., Kessler, J., Wullen, T. and Heiss, W. -D. (1992) Quantitative EEG mapping and PET in Alzheimer's disease. *Journal of Neurological Sciences*, vol. 110, pp. 46-56.

Sugeno M and Yasukawa T. (1993) A fuzzy-logic-based approach to qualitative modelling. *IEEE Transactions on Fuzzy Systems*, vol. 1, no. 1, pp. 7-31.

Turksen, I. B. and Tian, Y. (1993) Combination of rules or their consequences in fuzzy expert systems. *Fuzzy Sets and Systems*, vol. 58, pp. 3-40.

Visser, S. L. (1991) The electroencephalogram and evoked potentials in normal and ageing dementia. *Event-Related Brain Research* (EEG Suppl. 42).

Wenstop F. (1980) Qualitative analysis with linguistic variables. *Fuzzy Sets and Systems*, vol. 4, pp. 99-115.

Whalen, T. and Schott, B. (1985) Alternative logics for approximate reasoning in expert systems: A comparative study. *International Journal of Man-Machine Studies*, vol. 22, pp. 327-346.

Wu, J., Ifeachor, E. C., Allen, E. M., Wimalaratna, S. K. and Hudson, N. R. (1997) Intelligent artefact identification in electroencephalography signal processing. *IEE Proceedings - Science, Measurement and Technology* (accepted for publication).

Yager, R. R. (1984) Approximate reasoning as a basis for rule-based expert systems. *IEEE Transactions on Systems, Man and Cybernetics*, vol. SMC-14, no. 4, pp.636-643.

Zadeh, L. A. (1975a) The concept of a linguistic variable and its application to approximate reasoning-I. *Information Sciences*, vol. 8, pp. 199-249.

Zadeh L. A. (1975b) The concept of a linguistic variable and its application to approximate reasoning-II. *Information Sciences*, vol. 8, pp. 301-357.

Zadeh L. A. (1975c) The concept of a linguistic variable and its application to approximate reasoning-III. *Information Sciences*, vol. 9, pp. 43-80.



# 7. System evaluation and results

---

## 7.1 Introduction

In this chapter, a limited evaluation of the system to assess the viability of the new framework is presented. The evaluation is described in three sections: (i) the evaluation of the aspect of the system that provides the factual report automatically; (ii) the evaluation of the aspect of the system that provides the assessment of abnormality of the EEG; and (iii) the evaluations of 11 fuzzy implication operators which was carried out to identify the operator that was most suitable.

## 7.2 Automatic EEG reporting

The aspect of the system that provides the factual report automatically was tested using EEG data sets recorded from three subjects. One dataset was used for system development (record #1) and two datasets were used for system testing (record #2 and record #3). Each data set consisted of equal amounts of eyes closed and eyes open data. Record #1, record #2 and record #3 consisted of 120, 288 and 136 seconds of EEG data respectively. Each duration was limited by the amount of eye open data available. Excerpts from these records are given in Figure 42. Interpretations for each EEG record by the system (with the artefact processor disconnected) and by a qualified clinician are given in Table 16, Table 17 and

Table 18. Each table depicts the clinical factual report and the automated factual report. These reports describe each activity and each artefact identified in the EEG record. To aid comparisons, activities and artefacts which correspond in the clinical and automated reports are shown side by side. The descriptions in the automated factual report detail for each activity, a description for organisation, whether it is the dominant activity, its frequency and amplitude, its location and its change with eye opening. The canonogram displays the distribution of power of activity on the scalp. Dominant activity was defined as the activity having the largest power in the occipital channels. A 25% or more reduction in power with eye opening was deemed an *attenuation*, a 25% or more increase in power with eye opening was deemed an *increase*. For clarity, the description *moderately organised* for the feature *organisation* has been omitted.

Interpretations for each activity for each record were assessed by an experienced clinical neurophysiologist (EMA) and a research engineer (EPR) regarding agreement. The scores were 0, +, ++ or +++, where 0 represented no agreement and +++ represented full agreement. Table 19, Table 20 and Table 21 show the scores for records #1, #2 and #3. Significant differences between the computerised and clinical interpretations concern either failure by the system to distinguish artefact from genuine activity, or failure by the clinician to identify subtle features, such as slight asymmetries or small amounts of alpha activity. Other differences include the subclustering by the computer of the beta band (>13Hz), and the failure to identify features which were novel to the system.

Table 22 and Table 23 show the interpretation and the scores with the artefact processor connected for record #1. The results show a significant improvement for the beta description. Prior to artefact processing, contamination due to muscle artefact has biased features such as *frequency*, *amplitude* and *location* for the beta activity. Much of this contamination and thus the bias is removed by the artefact processor. However, in the case where activity is masked by persistent artefacts, the lack of artefact-free data may introduce a different bias in the analysis particularly for the feature *location*. Such artefacts will of course also be a cause of difficulty for the clinician. This problem may be alleviated somewhat by indicating on the canonogram display, the degree of artefact removal carried out. This would indicate to the clinician where the areas of error are most likely. A shortcoming of the system is the failure to adequately deal with ocular artefacts, leading to erroneous reporting of delta and theta activity. Given that the system is intended to assist rather than replace the clinician, some misclassifications can be tolerated. Consistent misclassifications however will require repeated cross-checking of the EEG record by the clinician to verify each misclassification. Future work is needed to increase the sensitivity of the artefact processor further (see also Section 8.2). Some minor differences between the amplitude measurements, the description for the location of activity and the description for organisation can be accounted for as follows. During the clinical assessment, amplitude is often measured peak-to-peak. For the analysis this is also done, however, the activity is first isolated from other activity using a digital filter. Harmonics, which have been found to exist for the alpha activity at multiples of the alpha frequency (Dumermuth et al. 1975), are thus removed by the system. Descriptions for the location for each activity may be further validated by

observing the distribution of power depicted by the canonogram. Disagreement for this feature, which occurs only very occasionally, may be attributed to the library representing a limited vocabulary of terms for location. This feature however, has demonstrated significant value by highlighting subtle asymmetries overlooked during the clinical interpretation. Future work should expand this library further. In the clinical interpretation, the description for the organisation of an activity can be highly qualitative and inconsistent, and may benefit by the added consistency which the automated system may provide. Disagreement, may be attributed to the fuzzy model which was developed for this feature. The model uses a conventional inference technique which is not optimal for linguistic approximation. Conventional inference methods which are used in practice, normally produce outputs intended for engineering applications which require defuzzified outputs (Mendel 1995), and not linguistic outputs as required for this application. The fuzzy output sets differ in shape from the primary sets and hedges and it is difficult to find a linguistic approximation to describe them using the same vocabulary of fuzzy variables. This problem is described in more detail in Section 7.3.

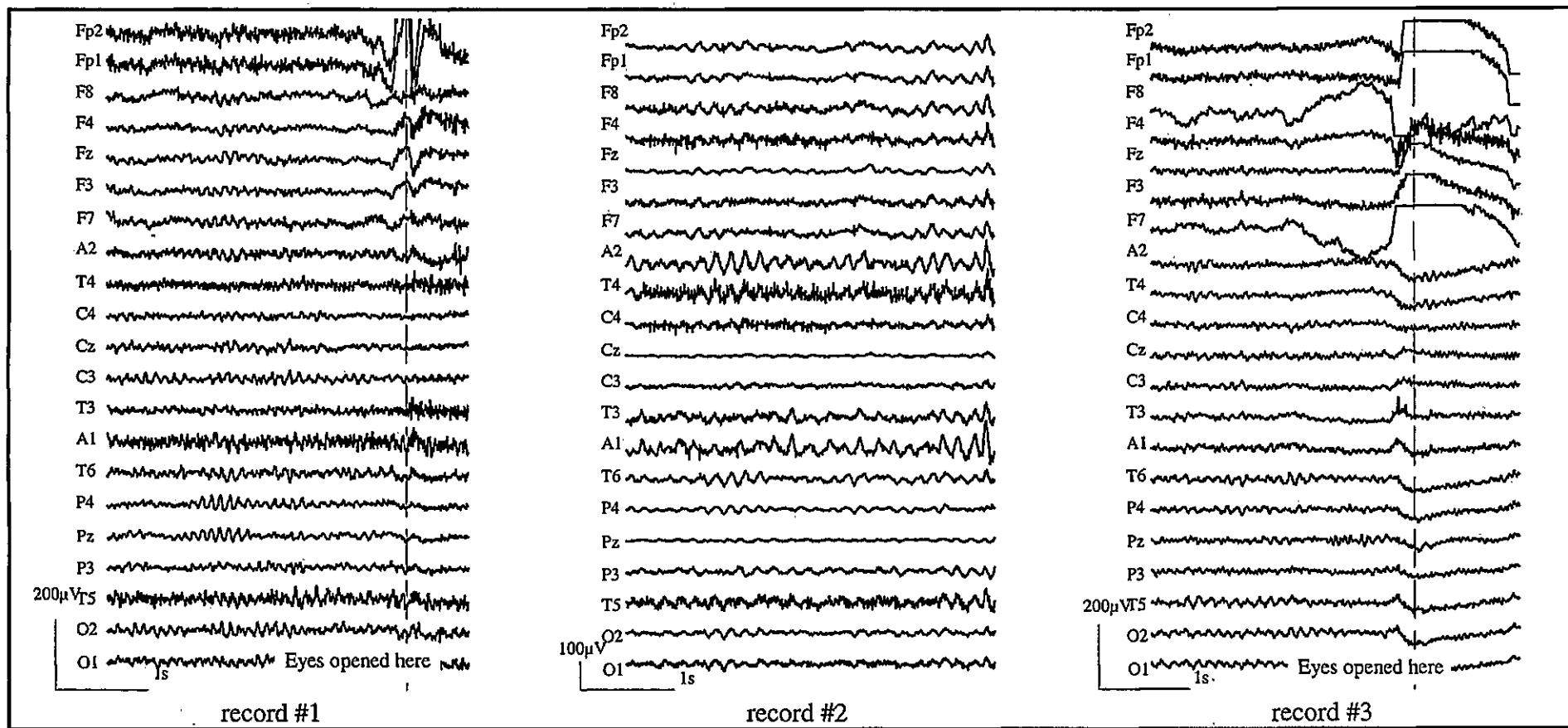


Figure 42. Excerpts from EEG data sets used for system development and testing.


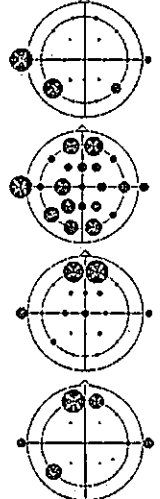
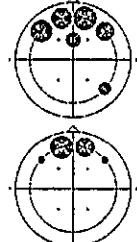
Clinical factual report	Automated factual report
<p>A persistent regular alpha rhythm at 9-10Hz, &lt;math&gt;50\mu\text{V}&lt;/math&gt;, which is symmetrical in posterior quadrants and is responsive to visual attention.</p>	<p>Regular dominant alpha activity, 9.8Hz, 44<math>\mu\text{V}</math>, posterior more on the right, attenuates with eye opening.</p> 
<p>Low amplitude beta activity, 14-25Hz is recorded diffusely bilaterally - maximally in frontal and central derivations.</p> <p>Muscle artefact, located in the frontal and temporal regions.</p>	<p>Beta activity, 15.6Hz, 31<math>\mu\text{V}</math>, temporal more on the left, attenuates with eye opening.</p> <p>Beta activity, 20Hz, 24<math>\mu\text{V}</math>, diffuse more on the left, attenuates with eye opening.</p> <p>Beta activity, 24.2Hz, 25<math>\mu\text{V}</math>, anterior more on the left, attenuates with eye opening.</p> <p>Beta activity, 27.9Hz, 11<math>\mu\text{V}</math>, anterior more on the left, attenuates with eye opening.</p> 
<p>Small eye movement artefact.</p>	<p>Delta activity, 1.7Hz, 38<math>\mu\text{V}</math>, frontal more on the right, increases with eye opening.</p> <p>Theta activity, 4.6Hz, 37<math>\mu\text{V}</math>, frontal more on the left, attenuates with eye opening.</p> 

Table 16. Interpretations for record #1 by a qualified clinician and the automated system (without artefact processing).

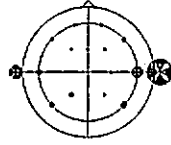
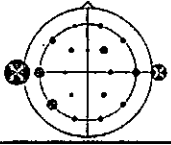
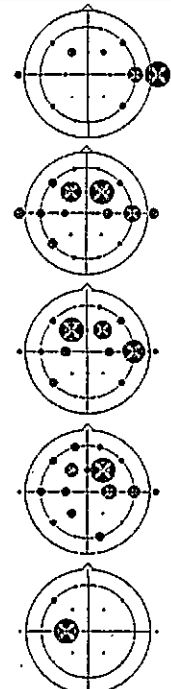
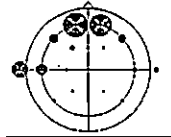
Clinical factual report	Automated factual report
<p>The EEG is dominated by rhythmic theta activity 4-6Hz, 10-60uV, predominantly in temporal and parietal areas - right slightly more than left. At times theta waves occur in short 1s duration runs in temporal areas, particularly on the left where it appears to have a sharp component.</p>	<p>Dominant theta activity, 5.9Hz, 110μV, temporal more on the right, does not change with eye opening.</p> 
<p>NB. no alpha was identified in the clinical factual report.</p>	<p>Alpha activity, 10.3Hz, 52μV, temporal more on the left, does not change with eye opening.</p> 
<p>A small amount of low amplitude beta activity 14-18Hz is diffuse.</p> <p>Muscle artefact, almost continuous low amplitude, in the frontal temporal areas, slightly more on the right, slightly variable in amplitude. Occasional bursts of high voltage are associated with swallow.</p>	<p>Beta activity, 13.5Hz, 37μV, temporal more on the right, increases with eye opening.</p> <p>Beta activity, 17.1Hz, 76μV, anterior, does not change with eye opening.</p> <p>Beta activity, 21.4Hz, 69μV, anterior more on the right, does not change with eye opening.</p> <p>Beta activity, 25.1Hz, 92μV, anterior more on the right, does not change with eye opening.</p> <p>Beta activity, 28Hz, 44μV, anterior more on the left, attenuates with eye opening.</p> 
<p>Occasional delta waves are recorded in mid-temporal areas independently.</p> <p>Blink artefact, lateral eye movements and slow rolling artefacts are most evident.</p>	<p>Delta activity, 1.6Hz, 150μV, anterior more on the left, increases with eye opening.</p> 

Table 17. Interpretations for record #2 by a qualified clinician and the automated system (without artefact processing).


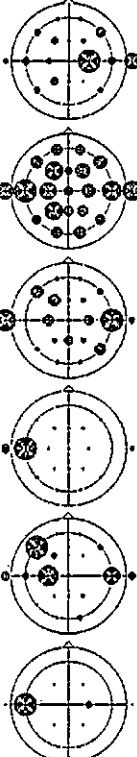
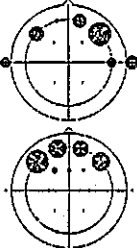
Clinical factual report	Automated factual report
<p>Intermittent, moderately irregular alpha rhythm at 8-9Hz, 20-30uV. This is symmetrical and is attenuated by eye opening.</p>	<p>Dominant alpha activity, 8.9Hz, 43μV, posterior, attenuates with eye opening.</p> 
<p>Beta activity at 20-25Hz up to 10uV is diffuse and symmetrical.</p> <p>Muscle artefact, bitemporal maximally, variable amplitude but fairly continuous.</p>	<p>Beta activity, 13.4Hz, 22μV, temporal more on the right, attenuates with eye opening.</p> <p>Beta activity, 15.8Hz, 24μV, diffuse, does not change with eye opening.</p> <p>Beta activity, 19Hz, 27μV, diffuse more on the left, increases with eye opening.</p> <p>Irregular beta activity, 21.9Hz, 23μV, diffuse more on the right, attenuates with eye opening.</p> <p>Irregular beta activity, 25.6Hz, 27μV, anterior more on the left, attenuates with eye opening.</p> <p>Irregular beta activity, 28.5Hz, 14μV, left temporal, attenuates with eye opening.</p> 
<p>Intermittent, irregular theta activity, at 4-7Hz, 20-30uV is seen in fronto-temporal areas bilaterally.</p> <p>Blink artefact, at Fp1+Fp2, less at F7+F8, F4, F3 etc. Eye opening, eye closure and slow, rolling artefact with same distribution, probably associated with drowsiness.</p>	<p>Theta activity, 5.3Hz, 21μV, frontal more on the right, attenuates with eye opening.</p> <p>Delta activity, 1.4Hz, 62μV, frontal more on the left, attenuates with eye opening.</p> 

Table 18. Interpretations for record #3 by a qualified clinician and the automated system (without artefact processing).



Score of agreement for record #1		
Activity	Score	Comments
delta	o	Computer picked up eye movement artefact
theta	o	Computer picked up eye movement artefact
alpha	++	Clinician failed to report asymmetry
beta	++	Computer failed to distinguish beta from muscle artefact

*Table 19. Scores for agreement for record #1 between the qualified clinician and the automated system (without artefact processing).*

Score of agreement for record #2		
Activity	Score	Comments
delta	++	Clinician failed to report asymmetry Computer failed to distinguish eye movement from the delta activity
theta	++	Computer failed to pick up single waveforms
alpha	o	Clinician failed to report the alpha activity
beta	++	Computer failed to distinguish beta from muscle artefact

*Table 20. Scores for agreement for record #2 between the qualified clinician and the automated system (without artefact processing).*

Score of agreement for record #3		
Activity	Score	Comments
delta	o	Computer picked up eye movement artefact
theta	++	Clinician failed to report asymmetry
alpha	+++	
beta	++	Computer failed to distinguish beta from muscle artefact

*Table 21. Scores for agreement for record #3 between the qualified clinician and the automated system (without artefact processing).*


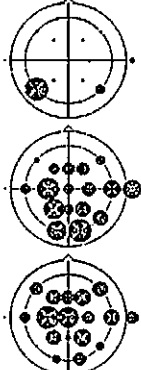
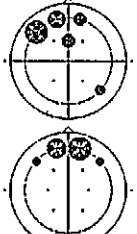
Clinical factual report	Automated factual report
<p>A persistent regular alpha rhythm at 9-10Hz, &lt;math&gt;50\mu\text{V}&lt;/math&gt;, which is symmetrical in posterior quadrants and is responsive to visual attention.</p>	<p>Regular dominant alpha activity, 9.8Hz, 44<math>\mu\text{V}</math>, posterior more on the right, attenuates with eye opening.</p> 
<p>Low amplitude beta activity, 14-25Hz is recorded diffusely bilaterally - maximally in frontal and central derivations.</p> <p>Muscle artefact, located in the frontal and temporal regions.</p>	<p>Beta activity, 15.1Hz, 19<math>\mu\text{V}</math>, posterior more on the right, attenuates with eye opening.</p> <p>Beta activity, 19.3Hz, 18<math>\mu\text{V}</math>, posterior, attenuates with eye opening.</p> <p>Beta activity, 23.5Hz, 11<math>\mu\text{V}</math>, anterior more on the left, attenuates with eye opening.</p> 
<p>Small eye movement artefact</p>	<p>Delta activity, 1.8Hz, 20<math>\mu\text{V}</math>, frontal more on the right, attenuates with eye opening.</p> <p>Theta activity, 4.8Hz, 23<math>\mu\text{V}</math>, frontal more on the right, attenuates with eye opening.</p> 

Table 22. Interpretations for record #1 by a qualified clinician and the automated system (with artefact processing).

Score of agreement for record #1 (with artefact processing)		
Activity	Score	Comments
delta	o	Computer picked up eye movement artefact
theta	o	Computer picked up eye movement artefact
alpha	++	Clinician failed to report asymmetry
beta	+++	

*Table 23. Scores for agreement for record #1 between the qualified clinician and the automated system (with artefact processing).*

### **7.3 Automatic assessment of the degree of abnormality of the EEG**

An important aspect to the development of a diagnostic or detection technique is the standard against which the technique will be validated. For example, Table 24 describes three standards, each having different degrees of accuracy and practicality. Validation data which has been pre-classified to a particular standard is often called the 'gold standard'.

Standard for obtaining a diagnosis for Alzheimer's disease	Accuracy and practicality
Diagnosis by presence of neuritic plaques and neurofibrillary tangles.	Accurate, but requires brain autopsy or biopsy.
Diagnosis by clinical examination and laboratory assessments such as electroencephalography (EEG), computerised tomography (CT) scan, single photon emission computed tomography (SPECT) scan, test for neurosyphilis, and various blood tests (thyroid gland, urea and electrolyte, haemoglobin, vitamin B12 and folic acid).	Method used to obtain a diagnosis by the Plymouth Community Healthcare Trust.
Diagnosis by clinical examination and EEG assessment.	Method immediately accessible to the research group and thus used for the study.

*Table 24. Possible standards for obtaining a diagnosis for Alzheimer's disease, each providing different degrees of accuracy and practicality.*

In this section, a limited evaluation of the aspect of the system which provided the assessment of the degree of abnormality is described. EEG data recorded from three patients with provisional diagnosis of Alzheimer's disease plus supported diagnosis by neurophysiologists and seven normal age-matched controls were used in the evaluation. It should be noted that this work was carried out before the artefact processor was fully developed. Each data set thus consisted of data selected from artefact-free sections of the EEG record. The interpretations made by the fuzzy system, for each EEG data set are given in Table 25.

EEG	Deduction made by the system
Alzheimer #1	probably-abnormal
Alzheimer #2	equivocal
Alzheimer #3	equivocal
Normal #2	probably-normal
Normal #3	possibly-normal
Normal #4	possibly-normal
Normal #5	probably-normal
Normal #6	more-or-less-probably-normal
Normal #7	probably-normal
Normal #8	somewhat-possibly-normal

*Table 25. Diagnostic interpretations made by the fuzzy system for 10 EEG data sets.*

The table depicts for each EEG data set, the linguistic approximation for the global deduction  $\mu_R(h)$ , made by the fuzzy system. It can be seen that the system has correctly discriminated between the EEGs recorded from the normal subjects and those with Alzheimer's disease. All EEGs recorded from the normal subjects were classified by the system as normal. However, of the EEGs recorded from the abnormal subjects, two EEG records were classified as equivocal, even though they were abnormal. This is because of the way the inference of the system operates; the system starts by trying to establish that the record is an Alzheimer's case or a normal case, and where it fails to do so, it defaults to equivocal. Each global deduction may be explained by highlighting the rules which contributed to the deduction. For example, given the global deduction  $\mu_R(h)$ , shown in Figure 43.

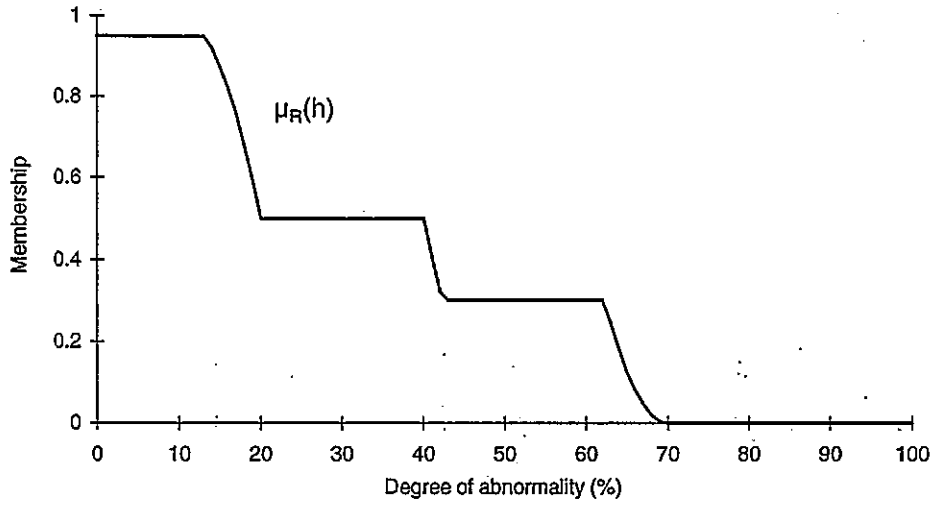


Figure 43. The deduction made by the fuzzy system for data set 'Normal #6'.

Rules which contributed significantly to  $\mu_R(h)$  were rules #16, #20 and #1. Figure 44 show their individual contributions, denoted  $\mu_{R16}(h)$ ,  $\mu_{R20}(h)$  and  $\mu_{R1}(h)$  respectively.

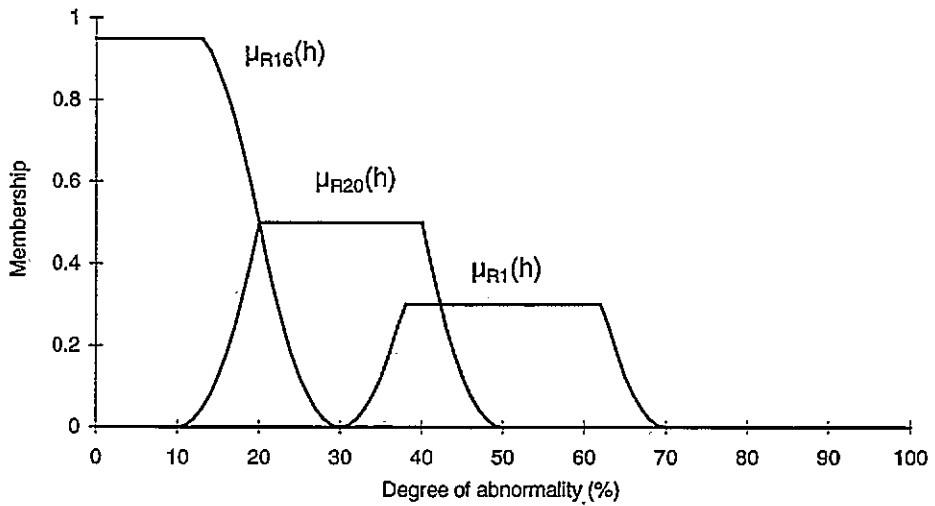


Figure 44. Individual contributions made by rules #16, #20 and #1 to the overall deduction for data set 'Normal #6'.

The linguistic approximation to  $\mu_R(h)$ , shown in Figure 45, consists of the primary set *probably abnormal*, which accounts for the contribution made by rule #16, but which has been modified by the hedge *more or less* to account for the partial contributions made by rules #20 and #1. The significant differences in shape between the deduction  $\mu_R(h)$  and the primary sets and hedges do, however, indicate that the inference technique is not optimal for linguistic approximation.

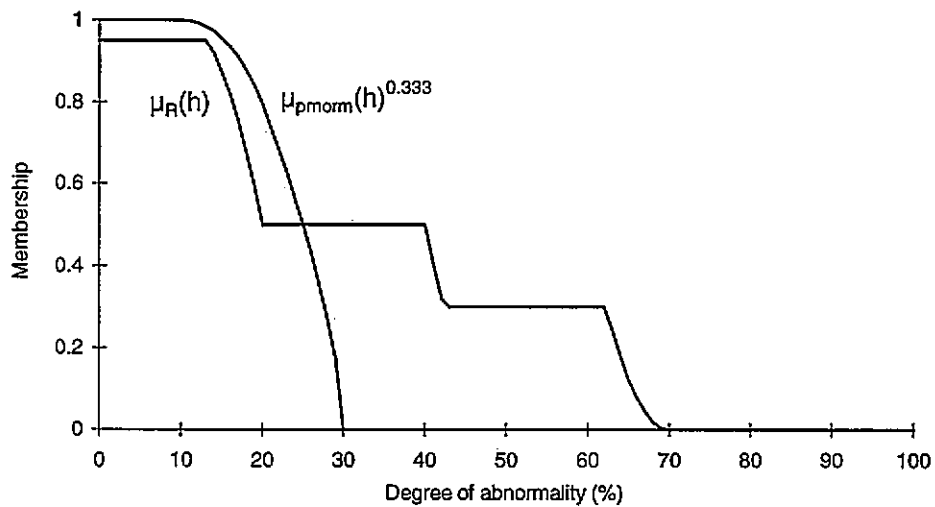


Figure 45. The linguistic approximation 'more or less probably normal' for the deduction made by the fuzzy system for data set 'Normal #6'.

## **7.4 Evaluation of fuzzy operators using ROC analysis**

Evaluations of 11 fuzzy implication operators (functions used to calculate the membership function of each rule in fuzzy rule-based system) using ROC (receiver operating characteristic) analysis were carried out in order to identify the operator to use in the system.

### **7.4.1 Introduction to ROC analysis**

To assess the accuracy of a system four parameters are often used. Events to be detected (in this case abnormal EEGs) are called positives, and events which are not positive (in this case normal EEGs) are called negatives. Correctly identified positives are called true positives, incorrectly identified positives are called false positives, correctly identified negatives are called true negatives and incorrectly identified negatives are called false negatives. These parameters are often displayed in the format shown in Table 26, where the columns represent the classifications according to the gold standard, and the rows represent the classifications according to the system under evaluation. An example is given in Table 27 which was taken from Centor (1991). The example shows a validation matrix for a new x-ray technique which provides 5 possible classifications with regard to cancer. The table shows the results for 120 subjects free of cancer and 77 subjects with cancer. To describe the technique in terms of true and false positives and true and false negatives, a dividing line must be specified, as indicated



conceptually by the dotted line. This dividing line usually needs to be specified with care because it provides the trade-off between the proportion of hits ((true positives) / (true positives + false negatives)) and the proportion of false alarms ((false positives) / (false positives + true negatives)). The correct trade-off often depends on the benefits of having a large proportion of hits and the costs of having a large proportion of false alarms. For example, a large proportion of hits (i.e. a small proportion of misses) is desirable in situations where high cost is associated with a miss, such as with life threatening diagnosis, whilst a small proportion of false alarms is desirable where high cost is associated with a false alarm such as with life threatening surgery.

		Gold standard	
		abnormal	normal
System	abnormal	True positives	False positives
	normal	False negatives	True negatives

Table 26. Matrix for system validation.

		Gold standard	
		abnormal	normal
System	probably abnormal	20	1
	possibly abnormal	30	3
	equivocal	20	15
	possibly normal	5	38
	probably normal	2	63

Table 27. Validation matrix for an example involving 77 subjects with cancer and 120 subjects without.



ROC (receiver operating characteristic or relative operating characteristic) analysis validates accuracy independent of the hit and false alarm bias, by calculating the true and false positives and true and false negatives for every possible dividing line and plotting the results on a graph of proportion of hits vs. proportion of false alarms (Centor 1991 and Swets 1988). For example, the ROC plot for the results given in Table 27 (the curve in Figure 46), is produced by plotting proportion of hits vs. proportion of false alarms i.e.  $((\text{true positives}) / (\text{true positives} + \text{false negatives}))$  vs.  $((\text{false positives}) / (\text{false positives} + \text{true negatives}))$ , whilst changing the position of the dividing line which defines these parameters. Selecting the dividing line above *probably abnormal* would produce no false alarms, but would also produce no hits. This threshold corresponds to the point plotted at [0, 0] in Figure 46. This process is repeated for each possible dividing line position including the position below *probably normal*, which corresponds to point [1, 1].

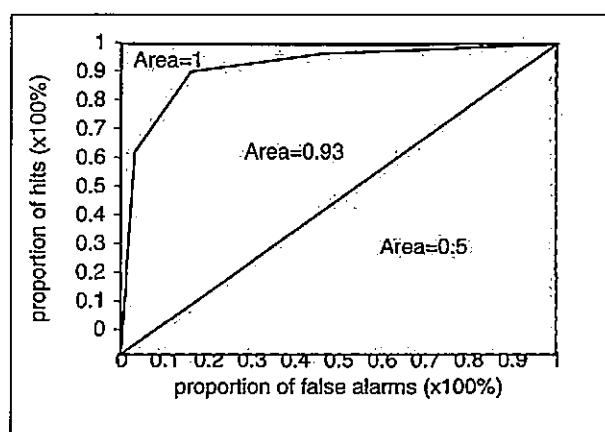


Figure 46. ROC curve derived from Table 27.

The main application of ROC analysis is for providing an unbiased comparison of different techniques which perform the same classification task. This is because a simple, single measure can be derived from the plot that represents the probability of the technique at correctly classifying an event as either positive or negative (Centor 1991). This measure is the area under the ROC plot and ranges from 0.5, which indicates a technique which classifies by chance alone, and 1, which indicates a technique which classifies without error. Figure 46 illustrates this measure. Given a technique which operates by chance, the proportion of correct hits would always be equal to the proportion of false alarms and the ROC plot would be seen to follow the diagonal. Given a technique which at some dividing line classified without error, the proportion of hits at that threshold would be one and the proportion of false alarms would be zero and the ROC plot would be seen to pass through the [0, 1] coordinate.

#### **7.4.2 Operator evaluation**

An important issue at present for designing fuzzy rule-based systems is the selection of an appropriate fuzzy implication operator (functions used to calculate the membership function of each rule in fuzzy rule-based system) (Whalen and Schott 1983). Evaluations of 11 fuzzy implication operators using ROC analysis were therefore carried out in order to identify the operator to use in the system (Riddington et al. 1996b). The 11 operators, which are described in Whalen and Schott (1985), were used in the aspect of the system which assessed the abnormality of the EEG. ROC analysis was carried out to measure the performance of the system at discriminating EEG data from 3 subjects with

Alzheimer's disease and 7 normal age-matched controls. The results are summarised in Table 28. Shown is the operator name, definition, the method necessary to combine each deduction made by each rule (Turksen and Tian 1993), and the ROC measure for discriminating the Alzheimer's and normal, age-matched controls obtained by calculating the area under the ROC plot. Full results are given in Appendix I. The results indicate that the choice of the fuzzy implication operator has a significant impact on the performance of the system. For example, the 'Kleene/Diensi', 'Mamdani' and 'Product' were the only operators which were able to discriminate between the normal and abnormal EEGs without error. The operator which was finally selected was the 'Mamdani'. It must be stressed that these results are only preliminary because the sample numbers were not large enough to adequately represent the population of Alzheimer's EEGs and normal EEGs.

operator name	operator (a→b) definition	combination operator	area under the ROC plot
Lukasiewicz	1 if $b \geq a$ $\min(1, 1-a+b)$ if $b < a$	min	0.917
Brouwer / Godel	1 if $b \geq a$ b otherwise	min	0.905
Kleene / Diensi	$\max(1-a, b)$	min	1
Mamdani	$\min(a, b)$	max	1
Sharp	1 if $a < 1$ or if $b = 1$ 0 otherwise	min	0.667
S	1 if $a \leq b$ 0 otherwise	min	0.809
Quotient	1 if $a = 0$ $\min(1, b/a)$ otherwise	min	0.905
Augmented quotient	1 if $a = 0$ or if $b = 1$ $\min(\min(1, b/a), (1-a)/(1-b))$ otherwise	min	0.905
Zadeh	$\max(\min(a,b), 1-a)$	min	0.952
Product	$\min(1, 1-a+a.b)$	min	1
Willmott	$\max(\min(a,b), \min(1-a, 1-b), \min(1-a, b))$	min	0.809

Table 28. Implication operators used in the investigation with their corresponding ROC score.

## 7.5 References

Centor, R. M. (1991) Signal detectability: The use of ROC curves and their analyses. *Medical Decision Making*, vol. 11, no. 2, pp. 102-106.

Dumermuth, G., Gasser, T. and Lange, B. (1975) Aspects of EEG analysis in the frequency domain. In: Dolce, G. and Kunkel, H. (Eds.) *CEAN - Computerised EEG analysis*. Gustav Fisher Verlag, Stuttgart. pp. 429-457.

Mendel, J. M. (1995) Fuzzy Logic Systems for Engineering: A Tutorial. *Proceedings of the IEEE*, vol. 83, no. 3, pp. 345-377.

Swets, J. A. (1988) Measuring the accuracy of diagnostic systems. *Science*, June, pp. 1285-1293.

Turksen, I. B. and Tian, Y. (1993) Combination of rules or their consequences in fuzzy expert systems. *Fuzzy Sets and Systems*, vol. 58, pp. 3-40.

Whalen, T. and Schott, B. (1985) Alternative logics for approximate reasoning in expert systems: A comparative study. *International Journal of Man-Machine Studies*, vol. 22, pp. 327-346.

# 8. Review, future work and conclusion

---

## 8.1 Review

A new framework for capturing the subjective expertise of the electroencephalographer and dealing with the effects from artefact corruption has been described. The framework separates the analysis into two stages.

The first stage, 'quantitative analysis', relies on novel DSP algorithms and a cluster algorithm to reduce data and identify and describe the significant activities in the EEG. Effects caused by artefact corruption are minimised by integrating new techniques for artefact identification and implementing a basic removal algorithm. Three achievements have been made with regard to this work. (i) Fundamental to this and many previous approaches in EEG analysis is power spectrum estimation. Previous approaches arbitrarily trade between estimate accuracy and resolution. This approach uses a technique which has been optimally developed to be accurate and low in noise but at minimal cost in resolution. (ii) In previous approaches, background activities are typically analysed within fixed frequency band thresholds. Frequency spread of background activities however, may fall across these band thresholds. This approach avoids this ambiguity by identifying activities by spectral peak rather than frequency band, and categorising

these frequencies using cluster analysis. The technique ensures that activities whose spectra exist in more than a single EEG frequency band are not incorrectly classified. (iii) Current systems fail to process the EEG adequately for artefacts. This work extends the solution to this problem by integrating a new reliable technique for artefact identification and implementing a basic removal algorithm. The outcome is an interpretation which is quantitative, and may be used to support future clinical investigations in neurophysiology.

The second stage, 'qualitative analysis', extends the analysis using salient time domain, frequency domain and spatial features and the underlying decision processes used by the clinical experts. Previous approaches fail to adequately account for the subjective nature of EEG interpretation. This work however, provides a new solution to this problem. Novel, intelligent models, based on fuzzy logic, capture the subjectivity and linguistic uncertainty expressed by the clinical experts, to provide an analysis closely comparable to the clinical interpretation made in practice. The outcome for this stage is an interpretation which, for the first time, provides the qualitative descriptions lacking in conventional quantitative analysis of the EEG.

A limited evaluation of the overall system has demonstrated the advantages of the framework. For example, on three occasions, the system reported asymmetry in the distribution of activity (an important feature in EEG evaluation), but which were missed by the clinical experts. The system thus may provide an enhancement to the conventional interpretation, by highlighting the subtle abnormalities which may be overlooked.



## 8.2 Future work

Whilst the limited evaluation demonstrated the feasibility of the approach, further work is required to enhance the performance of the system and develop the system into a commercially exploitable tool for routine use.

The importance of artefact processing for reliable automated analysis cannot be over-stressed. The framework presented here, integrates advanced techniques for artefact identification (Wu et al. 1997), and implements a basic removal algorithm. A shortcoming of the technique was the failure to identify all ocular artefacts, leading to erroneous reporting of delta and theta activity in the factual report. Future work should increase the sensitivity of the artefact processing further. Future work should also incorporate reliable removal techniques, such as those developed previously by the research group (Ifeachor et al. 1990, Hellyar 1991). These techniques adapt the removal algorithm to the characteristics of the artefact and are thus less prone to removing EEG activities of genuine interest.

The clustering algorithm, which identified the activities in the EEG, was prone to classify activity into subclusters, making interpretation difficult, and a more effective clustering strategy will need to be developed. This may include integrating heuristics to refine the clustering outcome. Further, the algorithm which was used, although efficient, was not optimal. For example, the outcome was dependent on the order with which the data was clustered. A practical alternative would be to cluster the *frequency* feature by identifying significant peaks in the frequency histogram.

Further research is also necessary to develop an inference technique specifically for linguistic applications. This is likely to involve an assessment of other methods of inference, and the development of an appropriate vocabulary which correspond with the inference output and is consistent with the descriptions used in practice. Different methods of inference which have been proposed include alternative techniques to construct the membership functions which model the rules of the system (Whalen and Schott 1983) and alternative methods of composition for calculating the deductions which can be made by the system (Dubois and Prade 1984).

If the system is to be adopted clinically, a full evaluation would be necessary. This is likely to require several key stages. Initially, a robust validation using a representative set of test cases and using an objective measure of performance would be necessary to direct the future work described above. This would require more normal and abnormal data. Typical sample numbers in EEG research have been found to range from 15 to 269 (Wu 1996). The next stage in the evaluation should involve an expansion of the system to other types of abnormal activity and artefacts. This could include extending the analysis to the other types of dementia such as multi-infarct (vascular) dementia and mixed dementia. Characteristics of the EEG for these and other dementias can be found in Torres and Hutton (1986) and Visser (1991). Finally the system should be set up in the hospital to evaluate the system within the intended clinical environment. This would require a refinement of the user interface in a way that will assist the clinician without hindrance during the conventional EEG assessment.

## 8.3 Conclusion

The work described in the thesis has demonstrated the feasibility of automated EEG analysis, taking into account the processes of judgement and reasoning employed by the experienced neurophysiologist. In particular, the work has addressed the two key obstacles in automated EEG analysis, namely capturing the subjectivity and uncertainty expressed by the clinical experts and dealing with the problem of artefact corruption.

The outcome, a PC-based automated EEG analysis system, should open the way for the development of an efficient and reliable clinical tool which will complement the digital PC based EEG recorders and reader stations rapidly replacing the conventional paper-based systems.

By introducing objectivity in EEG analysis it is hoped that the automated system, when fully evaluated, will significantly aid the process of EEG diagnosis.

## 8.4 References

Dubois, D. and Prade, H. (1984) Fuzzy logics and the generalised modus ponens revisited. *Int. J. Cybernetics and Systems*, Vol. 15, pp. 293-331.

Hellyar, M. T. (1991) Investigation, Development and Application of Knowledge Based Digital Signal Processing Methods for Enhancing Human EEGs. PhD Thesis, Polytechnic South West, Plymouth, Devon.



Ifeachor, E. C., Hellyar, M. T., Mapps, D. J. and Allen, E. M. (1990) Knowledge-based enhancement of human EEG signals. *IEE Proc.*, Vol. 137, Pt. F, No. 5, pp. 302-310.

Torres, F. and Hutton, J. T. (1986) Clinical neurophysiology of dementia. *Neurologic Clinics*, vol. 4, no. 2, pp. 369-386.

Visser, S. L. (1991) The electroencephalogram and evoked potentials in normal and ageing dementia. *Event-Related Brain Research* (EEG Suppl. 42).

Whalen, T. and Schott, B. (1983) Issues in fuzzy production systems. *Int. J. Man-Machine Studies*, vol. 19, pp. 57-71.

Wu, J., Ifeachor, E. C., Allen, E. M., Wimalaratna, S. K. and Hudson, N. R. (1997) Intelligent artefact identification in electroencephalography signal processing. *IEE Proc.-Sci. Meas. Technol.* (accepted for publication).

Wu, P. (1996) Sample numbers in the EEG research. Internal report of the EEG research group, School of Electronic, Communication and Electrical Engineering, University of Plymouth.

# Appendix A

## Multi-valued logic

---

To overcome limitations with 2-valued logic e.g. to account for propositions whose truth is unknown, undecided, neither true or false, indeterminate, paradoxical or meaningless, 3rd logical value were introduced (Turner 1985 pp. 32-37).

For example, Lukasiewicz introduced a third logical value to reason with propositions whose truth is not unknown but rather *indeterminate* such as the truth of future events (Turner 1985 pp. 32-37). This third value, denoted  $I$ , can also represent the truth of a proposition whose definition is not precise. For example, temperatures may be neither hot nor cold and so the truth of the temperature being either hot or cold at this temperature will be  $I$ .

However, which range of temperatures between cold and hot should be considered as indeterminate?

Rather than using a single indeterminate truth value corresponding to a single indeterminate temperature range, an infinite-valued logic places a continuum from 1 and 0 to correspond to the continuum of indeterminate temperatures (Figure 47).

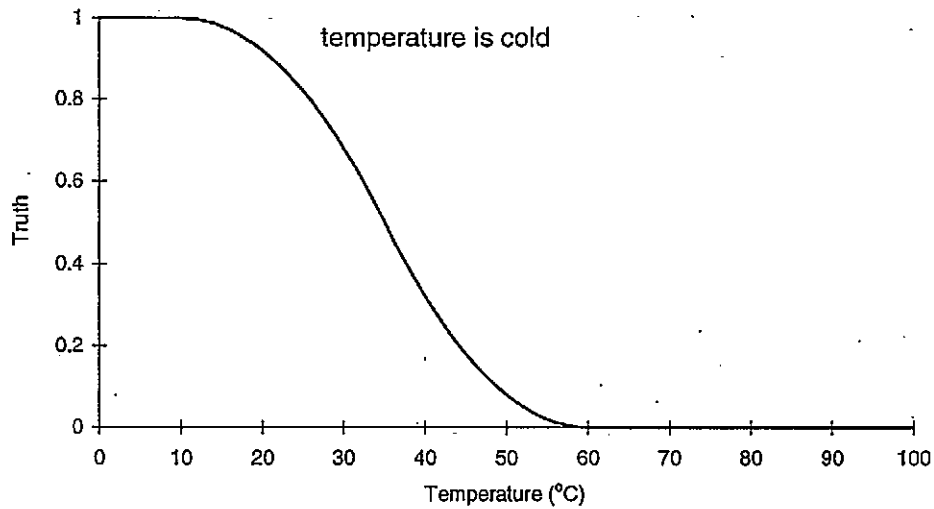


Figure 47. Truth values at each temperature for the proposition 'temperature is cold'.

To derive each infinite-valued logic operator, Lukasiewicz substituted each Boolean operator with the functions in Table 29.

Operator name	Meaning	Boolean definition	Lukasiewicz's infinite-valued logic definition
negation	NOT	$\neg p$	$1 - p$
conjunction	AND	$p \wedge q$	$\min(p, q)$
disjunction	OR	$p \vee q$	$\max(p, q)$
implication	IF-THEN	$p \rightarrow q$	$\min(1, 1 - p + q)$

Table 29. Definitions for the infinite-valued logic operators negation, conjunction, disjunction and implication.

These functions can be seen to subsume Boolean logic by substituting true and false with the values 1 and 0. Membership grades of a set can be interpreted as truth values of a proposition and vice-versa because infinite-valued logic is isomorphic to fuzzy set theory, just as Boolean logic is to ordinary set theory (Klir

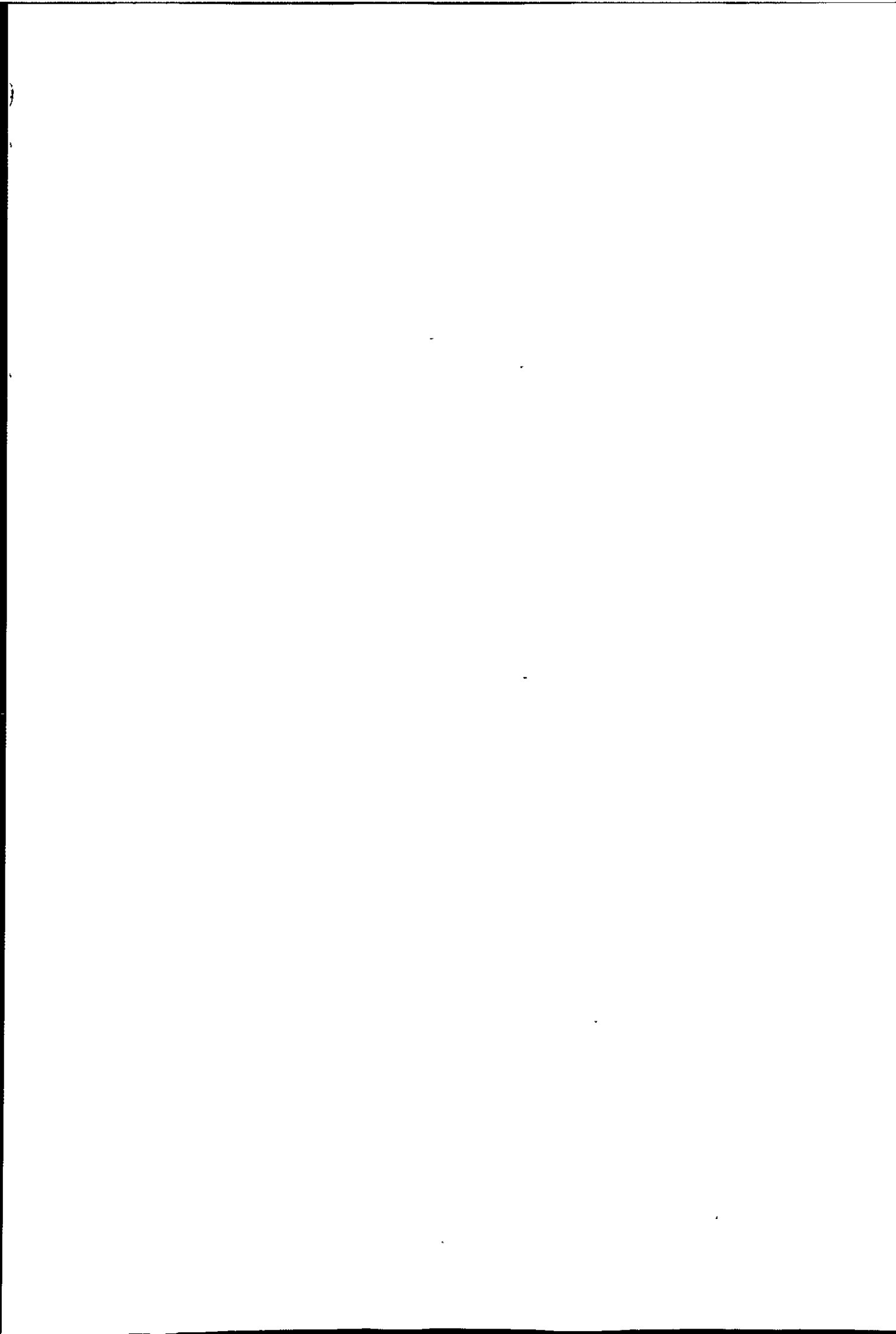
and Folger 1988). Hence, Lukasiewicz's infinite-valued logic operators 'conjunction', 'disjunction', 'negation' and 'implication' are isomorphic respectively to the fuzzy set operators 'intersection', 'union', 'complement' and the 'conditional'.

## References

Turner, R. (1985) *Logics for Artificial Intelligence*. Ellis Horwood Ltd, West Sussex.

Klir, G. J. and Folger, T. A. (1988) *Fuzzy Sets, Uncertainty, and Information*. Prentice Hall, Englewood Cliffs, New Jersey.





# Appendix B

## Recording montages

---

There are many techniques to effectively record the distribution of electrical potentials from the scalp. Each technique differs with the method of reference used to measure electrical potential difference. Three methods are routinely used: common reference, common average reference and bipolar. Common reference displays the potential difference between each electrode and a common reference such as the ear lobes or chin (Figure 48 (a)). Care needs to be taken to select a reference site which only picks up signals common to all the electrodes. Common average reference displays the potential difference between each electrode and the average of all the electrodes (Figure 48 (b)). This method removes the need of finding a suitable reference. It assumes the average of all the electrodes is negligible, which is often not the case. Large isolated potentials will affect the reference adversely and often the frontal electrodes that pick up eye movement artefact are omitted from the reference calculation. Bipolar reference displays potential difference between pairs of adjacent electrodes (Figure 48 (c), (d), (e), (f) and (g)). This method provides identification of activity that is localised on the scalp as a phase reversal of the activity between two channels. As is shown in Figure 48, there can be many possible pair arrangements for bipolar reference, each providing detail for different areas of the scalp. Each arrangement for common, common average and bipolar reference is called a montage.

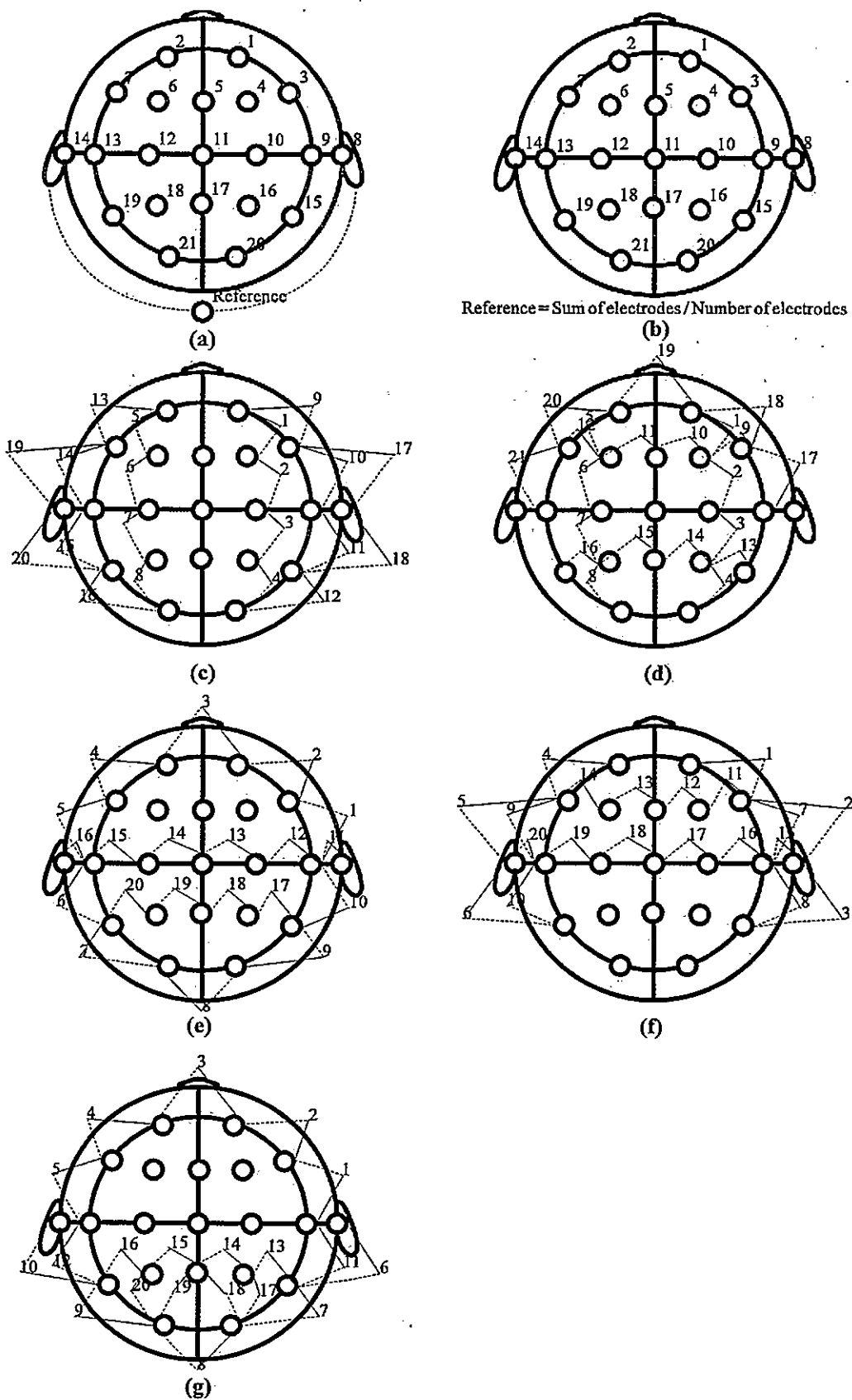


Figure 48. Different EEG montages used to record electrical potentials from the scalp. (a) Common reference. (b) Common average reference. (c) - (g) Bipolar reference.

# Appendix C

## Mini-mental state assessment

Mini-mental state assessment		
		Patient: _____
		Examiner: _____
		Date: _____
		Orientation
5	( )	What is the (year) (season) (date) (day) (month)?
5	( )	Where are we: (country) (county) (city) (hospital) (floor).
		Registration
3	( )	Name 3 objects: 1 second to say each. Then ask the patient all 3 after you have said them. Give 1 point for each correct answer. Then repeat them until he learns all 3. Count trials and record. Trials:
		Attention and Calculation
5	( )	Serial 7's (93,86,79,72,65). 1 point for each correct. Stop after 5 answers. Alternatively spell "world" backwards.
		Recall
3	( )	Ask for the 3 objects repeated above. Give 1 point for each correct.
		Language
9	( )	Name a pencil, and watch (2 points). Repeat the following "No ifs, ands or buts." (1 point) Follow 3-stage command (3 points): "Take a paper in your right hand, fold it in half, and put it on the floor" Read and obey the following (1 point): CLOSE YOUR EYES. Write a sentence (1 point). Copy design (1 point).
		Total score
		ASSESS level of consciousness along a continuum:
		Alert   Drowsy   Stupor   Coma

## Mini-mental state assessment instructions

### *Orientation*

(1) Ask for the date. Then ask specifically for parts omitted, e.g., "Can you also tell me what season it is?" One point for each correct.

Ask in turn "Can you tell me the name of this hospital?" (town, country, etc.). One point for each correct.

### *Registration*

Ask the patient if you may test his memory. Then say the names of 3 unrelated objects, clearly and slowly, about one second for each. After you have said all 3, ask him to repeat them. This first repetition determines his score (0-3) but keep saying them until he can repeat all 3, up to 6 trials. If he does not eventually learn all 3, recall cannot be meaningfully tested.

### *Attention and Calculation*

Ask the patient to begin with 100 and count backwards by 7. Stop after subtractions (93, 86, 79, 72, 65). Score the total number of correct answers.

If the patient cannot or will not perform this task, ask him to spell the "world" backwards. The score is the number of letters in correct order. E.G. dlrow = 5, dlrow = 3.

### *Recall*

Ask the patient if he can recall the 3 words you previously asked him to remember. Score 0-3.

### *Language*

*Naming:* Show the patient a wrist watch and ask him what it is. Repeat for pencil. Score 0-2.

*Repetition:* Ask the patient to repeat the sentence after you: 'No ifs, ands or buts'. Allow only one trial. Score 0 or 1.

*3-stage command:* Give the patient a piece of plain blank paper and repeat the command: 'Take the paper in your right hand, fold it in half, and put it on the floor'. Score 1 point for each part correctly executed.

*Reading:* On a blank piece of paper print the sentence "Close your eyes", in letters large enough for the patient to see clearly. Ask him to read it and do what it says. Score 1 point only if he actually closes his eyes.

*Writing:* Give the patient a blank piece of paper and ask him to write a sentence for you. Do not dictate a sentence, it is to be written spontaneously. It must contain a subject and verb and be sensible. Correct grammar and punctuation are not necessary.

*Copying:* On a clean piece of paper, draw intersecting pentagons, each side about 1 in., and ask him to copy it exactly as it is. All 10 angles must be present and 2 must intersect to score 1 point. Tremor and rotation are ignored.

Estimate the patient's level of sensorium along a continuum, from alert on the left to coma on the right.

*Screening Criteria*

Reject normal controls having score less than 24.

Reject Alzheimer patients having score greater than 20.

# Appendix D

## Searching the MDI database

---

Enter the MDI database by entering the following:

username: MDI  
system: LI  
username: NP  
password: see technician

The options of interest at the main menu are:

04 **Query package**  
02 **Output control**

### **Query package**

To search the database select:

01 **Enquiry package**  
and complete the search form shown below

Any unique name

Any description

Enquiry Name	[Eddie04]	Title	[Alzheimer diagnosis]
Index	[%NP-%ODATEATT]	Range	[010495 ] to [160196 ]
A	[%NP-%CONC1 ]	[C ]	[Alzheimer ] [N]
B	[%NP-%CONC2 ]	[C ]	[Alzheimer ] [N]
C	[%NP-%CONC3 ]	[C ]	[Alzheimer ] [N]
D	[%NP-%CONC4 ]	[C ]	[Alzheimer ] [N]
E	[%NP-%CONC1 ]	[C ]	[AD ] [N]
F	[%NP-%CONC2 ]	[C ]	[AD ] [N]
G	[%NP-%CONC3 ]	[C ]	[AD ] [N]
H	[%NP-%CONC4 ]	[C ]	[AD ] [N]
I	[ ]	[ ]	[ ] [ ]
J	[ ]	[ ]	[ ] [ ]
Relationship		[A!B!C!D!E!F!G!H	]
Correct		[Y]	

Fields of a record to search. In this case each line in the interpretation conclusion written by the Consultant Neurophysiologist

Search terms. In this case the words Alzheimer and AD (abbr. for Alzheimer's disease)

Index of records to search. In this case date and range 1.4.95 to 16.1.96

Boolean relationship: ! for OR, & for AND.

Contains

To run the enquiry select:

04 Run

giving the results file the same name as the enquiry.

To check the status of the enquiry select:

05 Status

### Output control

To save the search results to a file select:

02 Create

and complete the download form as shown



Same as search

Record fields to download. In this case:  
 EEG record number.  
 Referring consultant's provisional diagnosis and name.  
 EEG interpretation from the consultant neurophysiologist.  
 Patient's name

Title: [Eddie04 ]		Data Group: [%NPTEST ]	
Data Item Name	Title	Format	Record
[%NP-NOEEG ]	EEG NUMBER	[	]
[%NP-PDIA1 ]	Provisional Diagnosis 1	[	]
[%NP-PDIA2 ]	Provisional Diagnosis 2	[	]
[%NP-PDIA3 ]	Provisional Diagnosis 3	[	]
[%NP-PDIAC ]	PROVISIONAL DIAGNOSIS - ICD9	[Interpreted	]
[%NP-OCONS1 ]	Referring Consultant	[Interpreted	]
[%NP-CONC1 ]	Conclusion and Interpretation 1	[	]
[%NP-CONC2 ]	Conclusion and Interpretation 2	[	]
[%NP-CONC3 ]	Conclusion and Interpretation 3	[	]
[%FN	Patient's Forename	[	]
[%SN	Patient's Surname	[	]
[	]	[	]
[	]	[	]

To run the data extraction select:

04 Run

then select extraction file, giving the extraction file the same name as the enquiry.

To check the status of the extraction select:

05 Status

To run the data download select:

04 Run

then select download file, giving the extraction file the same name as the enquiry.

On 'format' select the desired file format. Then press ALT F - CAPTURE SETUP

Type path and file name for the data. Then ALT F - CAPTURE. Then ALT F - C to finish capture.

### Other useful keys

F2 print screen  
 \* previous menu  
 Num Lock field options

# Appendix E

## EEG data file formats

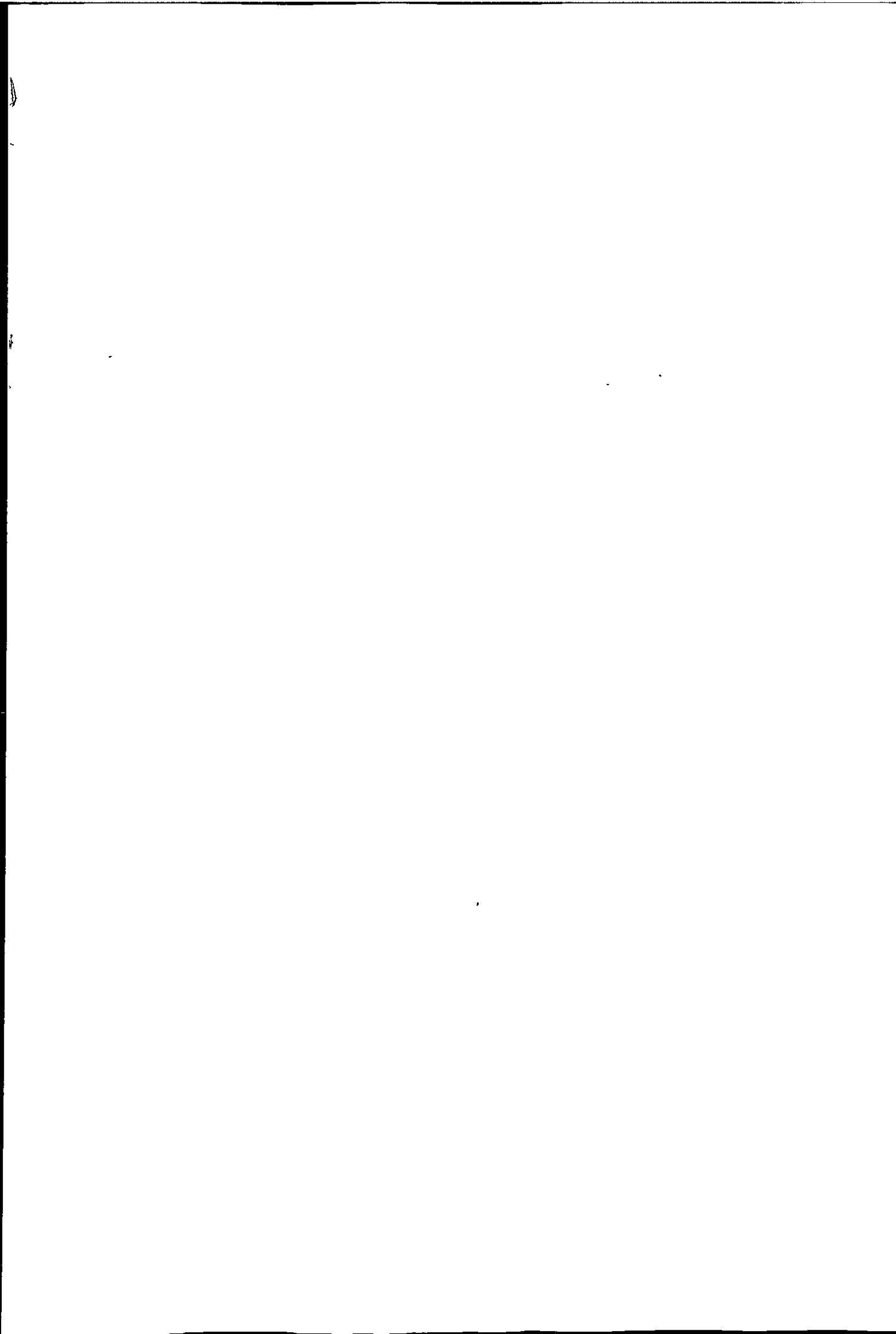
---

### Data acquisition system file format

- The recording method for the acquisition is as follows: 12 bits per channel were sampled at 256Hz from 22 channels. Each 12 bits are stored as 2 bytes. Data is stored as 8 second files. To deformat:
  - Take 2 bytes from a D\*.DAT file. The 1<sup>st</sup> byte is the least significant byte.
  - Samples range from 0 to 4095.
  - EEG originates as 1V/cm, therefore multiplying by machine sensitivity which is in V/cm gives actual volts. However, prior to digitisation, the EEG is amplified by 7.143 (to convert the EEG machine's full scale range of  $\pm 1.4V$  to the  $\pm 10V$  input range of the digitiser). Digitisation then negates and stores  $\pm 10V$  as 12 bits. To scale to volts therefore, subtract 2048 to centre about zero and use the factor  $-20.0 / 7.143 / 4096.0 * \text{machine sensitivity}$
  - Store as 1<sup>st</sup> sample of 1<sup>st</sup> channel.
  - Repeat until 1<sup>st</sup> sample of 22 channels have been obtained.
  - Repeat until 2048 samples (8 seconds) for each channel have been obtained.
  - Note,  $2 \times 22 \times 2048 = 90112 = D*DAT$  file size.

### Ceegraph file format

- For the Ceegraph system 12 bits per channel were sampled at 256Hz from 34 channels. Each 12 bits are stored as 2 bytes. Data is stored as a single file, and thus is variable in size. To deformat:
  - Ignore 3276 byte header
  - Take 2 bytes. The 1<sup>st</sup> byte is the least significant byte.
  - Samples range from 0 to 4095, where 2048 to 4095 are values -2048 to -1, therefore for samples  $\geq 2048$  remove 4096.
  - Scale to V using the factor  $-0.301810176 * 10^{-6}$
  - Store as 1<sup>st</sup> sample of 1<sup>st</sup> channel.
  - Repeat until 1<sup>st</sup> sample of 34 channels have been obtained.
  - Re-sort the channels: 5 4 10 9 8 7 6 17 16 15 14 13 12 11 22 21 20 19 28 24 23 25 which correspond to channels: 1, 2, 3, 4, ..., 22 respectively.
  - Repeat until end of file.



# Appendix F

## Inference in fuzzy systems

---

This appendix provides an example to illustrate the inference procedure which was used in Section 6.2.1 and Section 6.3.2.

In Section 6.2.1 and Section 6.3.2, Equation 71 was used to define the membership function which describes the relationship between two fuzzy sets  $\mu(a)$  and  $\mu(b)$  in a rule, where  $\mu(a)$  represents the fuzzy term in the IF part and  $\mu(b)$  the fuzzy term in the THEN part.

$$\mu(a,b) = \min(\mu(a), \mu(b)) \quad (71)$$

To illustrate Equation 71, consider the rule *if a is small then b is large*. This relationship can be illustrated by the surface in Figure 49.

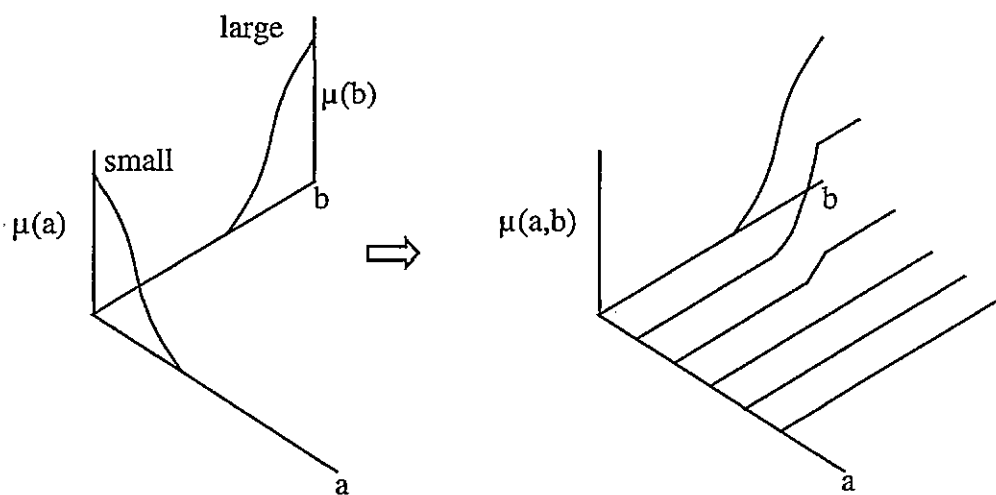


Figure 49. Membership function representing the rule 'if a is small then b is large'.

Each point on the surface represents the contribution the variable  $a$  makes to the membership function representing the deduction, which shall be denoted  $\mu_{R1}(b)$ .

For example, given the membership function  $\mu(a)'$  which represents the point at which the variable  $a$  equals  $k1$ , i.e. the fact  $a$  is  $k1$ , shown in Figure 50.

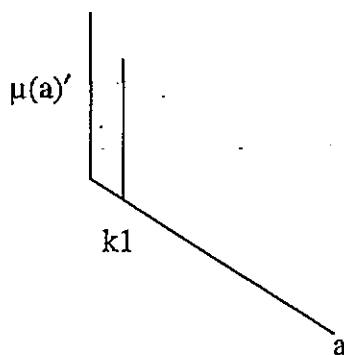


Figure 50. Membership function representing the fact 'a is k1'

The inference which can be made is calculated by the composition given in Equation 72 and illustrated in Figure 51.

$$\mu_{R1}(b) = \mu(a)' \circ \mu(a,b) = \max_a(\min(\mu(a)', \mu(a,b))) \quad (72)$$

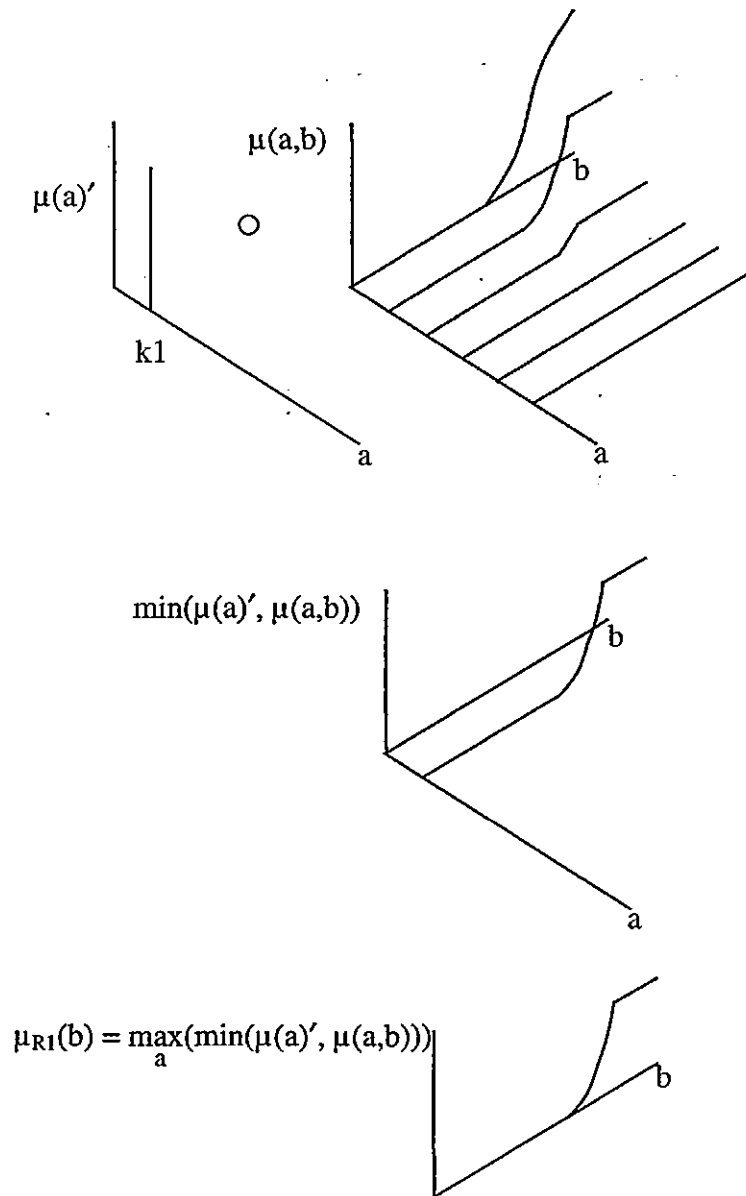


Figure 51. Deduction which can be made given the fact 'a is k1' and the rule 'if a is small then b is large'.

Contributions made by each rule are then combined in a single overall deduction, denoted  $\mu_R(b)$ , using Equation 73.

$$\mu_R(b) = \min_i(\mu_{Ri}(b)). \quad (73)$$

For example, given the deductions  $\mu_{R1}(b)$ ,  $\mu_{R2}(b)$  and  $\mu_{R3}(b)$  shown in Figure 53, the global deduction  $\mu_R(b)$  is shown in Figure 54.

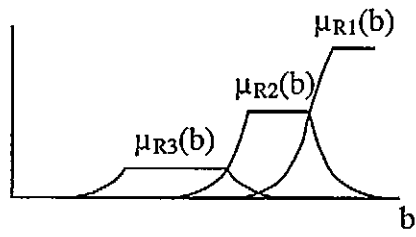


Figure 53. Deductions made by individual rules..



Figure 54. Combined deductions to produce the 'global' deduction.

# Appendix G

## Rules used for the diagnostic interpretation

---

**Rule 1:**

IF the dominant occipital rhythm frequency is below slow alpha  
OR the dominant occipital rhythm frequency is above alpha  
THEN EEG is equivocal

**Rule 2:**

IF the dominant occipital rhythm amount is not small  
AND the dominant occipital rhythm increases with eye opening  
THEN EEG is equivocal

**Rule 3:**

IF the dominant occipital rhythm amount is small  
THEN EEG is equivocal

**Rule 4:**

IF the dominant occipital rhythm amount is not small  
AND the dominant occipital rhythm does not change with eye opening  
AND the dominant occipital rhythm frequency is alpha  
THEN EEG is equivocal

**Rule 5:**

IF the dominant occipital rhythm amount is not small  
AND the dominant occipital rhythm does not change with eye opening  
AND the dominant occipital rhythm frequency is slow alpha  
AND the amount of slow activity is below moderate  
THEN EEG is equivocal

**Rule 6:**

IF the dominant occipital rhythm amount is not small  
AND the dominant occipital rhythm does not change with eye opening  
AND the dominant occipital rhythm frequency is slow alpha  
AND the amount of slow activity is above small  
THEN EEG is possibly abnormal

**Rule 7:**

IF the dominant occipital rhythm amount is not small  
AND the dominant occipital rhythm does not change with eye opening  
AND the dominant occipital rhythm frequency is very slow alpha  
AND the amount of slow activity is insignificant  
THEN EEG is equivocal

**Rule 8:**

IF the dominant occipital rhythm amount is not small  
AND the dominant occipital rhythm does not change with eye opening  
AND the dominant occipital rhythm frequency is very slow alpha  
AND the amount of slow activity is small  
THEN EEG is possibly abnormal



**Rule 9:**

IF the dominant occipital rhythm amount is not small  
AND the dominant occipital rhythm does not change with eye opening  
AND the dominant occipital rhythm frequency is very slow alpha  
AND the amount of slow activity is above small  
THEN EEG is probably abnormal

**Rule 10:**

IF the dominant occipital rhythm amount is not small  
AND the dominant occipital rhythm slightly attenuates with eye opening  
AND the dominant occipital rhythm frequency is alpha  
AND the amount of slow activity is insignificant  
THEN EEG is probably normal

**Rule 11:**

IF the dominant occipital rhythm amount is not small  
AND the dominant occipital rhythm slightly attenuates with eye opening  
AND the dominant occipital rhythm frequency is alpha  
AND the amount of slow activity is not insignificant and not large  
THEN EEG is possibly normal

**Rule 12:**

IF the dominant occipital rhythm amount is not small  
AND the dominant occipital rhythm slightly attenuates with eye opening  
AND the dominant occipital rhythm frequency is alpha  
AND the amount of slow activity is large  
THEN EEG is equivocal

**Rule 13:**

IF the dominant occipital rhythm amount is not small  
AND the dominant occipital rhythm slightly attenuates with eye opening  
AND the dominant occipital rhythm frequency is slow alpha  
AND the amount of slow activity is below moderate  
THEN EEG is possibly normal

**Rule 14:**

IF the dominant occipital rhythm amount is not small  
AND the dominant occipital rhythm slightly attenuates with eye opening  
AND the dominant occipital rhythm frequency is slow alpha  
AND the amount of slow activity is above small  
THEN EEG is equivocal

**Rule 15:**

IF the dominant occipital rhythm amount is not small  
AND the dominant occipital rhythm slightly attenuates with eye opening  
AND the dominant occipital rhythm frequency is very slow alpha  
THEN EEG is equivocal

**Rule 16:**

IF the dominant occipital rhythm amount is not small  
AND the dominant occipital rhythm attenuates with eye opening  
AND the dominant occipital rhythm frequency is alpha  
AND the amount of slow activity is below moderate  
THEN EEG is probably normal

**Rule 17:**

IF the dominant occipital rhythm amount is not small  
AND the dominant occipital rhythm attenuates with eye opening  
AND the dominant occipital rhythm frequency is alpha  
AND the amount of slow activity is moderate  
THEN EEG is possibly normal

**Rule 18:**

IF the dominant occipital rhythm amount is not small  
AND the dominant occipital rhythm attenuates with eye opening  
AND the dominant occipital rhythm frequency is alpha  
AND the amount of slow activity is large  
THEN EEG is equivocal

**Rule 19:**

IF the dominant occipital rhythm amount is not small  
AND the dominant occipital rhythm attenuates with eye opening  
AND the dominant occipital rhythm frequency is slow alpha  
AND the amount of slow activity is insignificant  
THEN EEG is probably normal

**Rule 20:**

IF the dominant occipital rhythm amount is not small  
AND the dominant occipital rhythm attenuates with eye opening  
AND the dominant occipital rhythm frequency is slow alpha  
AND the amount of slow activity is not insignificant and not large  
THEN EEG is possibly normal

**Rule 21:**

IF the dominant occipital rhythm amount is not small  
AND the dominant occipital rhythm attenuates with eye opening  
AND the dominant occipital rhythm frequency is slow alpha  
AND the amount of slow activity is large  
THEN EEG is equivocal

**Rule 22:**

IF the dominant occipital rhythm amount is not small  
AND the dominant occipital rhythm attenuates with eye opening  
AND the dominant occipital rhythm frequency is very slow alpha  
THEN EEG is equivocal

10

# Appendix H

## System user guide

---

The system for automated EEG interpretation consists of 3 PC software applications: EXTRACT.EXE, EEGINT.CLP and CANO.EXE. In this section, the steps that are required to use these applications to obtain an automated interpretation of the EEG are described.

The input to the system are raw EEG data files, an EEG record details file and artefact report files.

The raw EEG data files are binary files of 21 channel EEG data which were obtained using the data acquisition system described in Chapter 3. The files each correspond to 8 seconds of EEG and are sequentially numbered using the naming convention D\*.DAT, e.g. D0.DAT to D111.DAT corresponds to 112 x 8 seconds of raw EEG data. The format of these files is given in Appendix E.

The EEG record details file contains details of the EEG recording procedure such as how many EEG data files exist for a particular subject and when the subject closed and opened his or her eyes. the default name for this file is DETAILS.TXT and is stored in the same directory as the corresponding raw EEG data file. An example of this file is given in Table 30.

Seg. No.	Time	Dir.	Day	Mon.	Yr.	Mont.	HPF (Hz)	LPF (s)	Sens (uV/cm)	Eyes closed (1/0)	Hypervent.	Sleep (a/d/s)	EMGf (1/0)	Mainst (1/0)
84	0	vol2	11	8	93	5	60	0.3	10	1	0	a	0	0
85	0	vol2	11	8	93	5	60	0.3	10	1	0	a	0	0
86	0	vol2	11	8	93	5	60	0.3	10	1	0	a	0	0
87	0	vol2	11	8	93	5	60	0.3	10	1	0	a	0	0
.														
114	0	vol2	11	8	93	5	60	0.3	10	0	0	a	0	0
115	0	vol2	11	8	93	5	60	0.3	10	0	0	a	0	0

Table 30. Example EEG record details file (DETAILS.TXT).

The artefact report files are text files which specify the type of artefacts that exist in each channel of the EEG data (see Section 5.5). The files each correspond to 4 seconds of EEG and are sequentially numbered using the naming convention ARTE\*.TXT, e.g. ARTE0.TXT to ARTE223.TXT corresponds to 224 x 4 seconds of EEG data. 2 artefact report files correspond to 1 raw EEG data file. An example of this file is given in Table 31.

Channel	Segment	Artefact
Fp1	100	artefact muscle blink
Fp2	100	artefact muscle blink
F7	100	artefact muscle blink
F3	100	artefact muscle blink
Fz	100	artefact blink
F4	100	artefact blink
F8	100	artefact muscle blink
A1	100	artefact muscle
T3	100	artefact muscle
C3	100	artefact free
Cz	100	artefact muscle
C4	100	artefact free
T4	100	artefact muscle
A2	100	artefact muscle
T5	100	artefact muscle
P3	100	artefact muscle
Pz	100	artefact free
P4	100	artefact free
T6	100	artefact muscle
O1	100	artefact muscle
O2	100	artefact muscle

Table 31. Example artefact report file (ARTE\*.TXT).

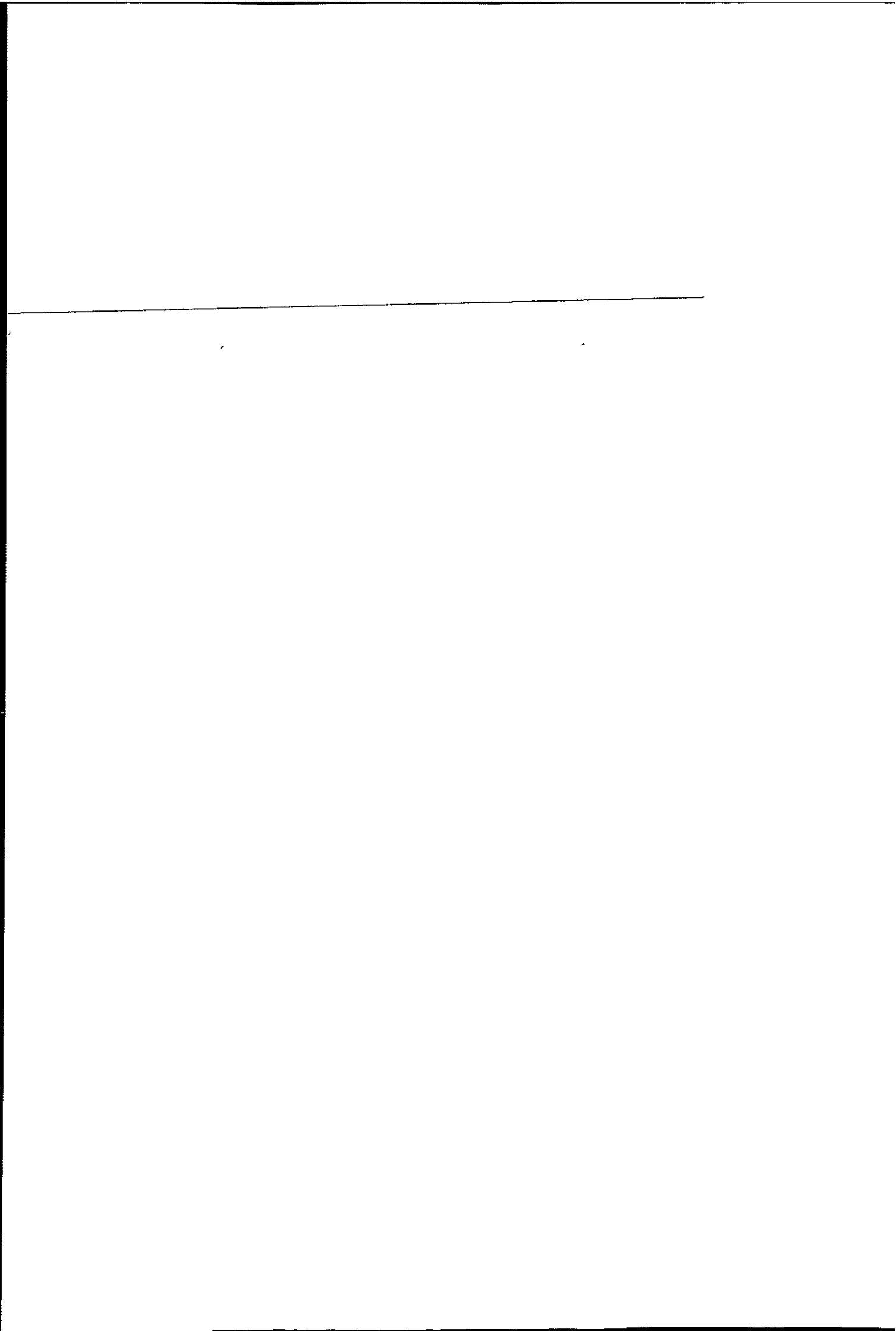
The first application, EXTRACT.EXE, takes as input the raw EEG data files and performs the background EEG activity identification (see Section 5.2) and extracts the 6 quantitative time domain and frequency domain features for each identified

activity (see Section 5.3). The output of this application are activity feature files which specify the features for each activity identified in each channel. The files each correspond to 4 seconds of EEG and are sequentially numbered using the naming convention FEAT\*.TXT, e.g. FEAT0.TXT to FEAT223.TXT correspond to 224 x 4 seconds of EEG data. 2 activity feature files correspond to 1 raw EEG data file. In addition to the raw EEG data files, the application also takes as input 4 parameters: raw EEG data file directory name, the number of the 4 second EEG segment to begin with and the number of the segment to end with. An example of this file is given in Table 32.

channel	activity no.	feature	value
1	1	frequency	2
1	1	amplitude	1.90E-04
1	1	relative-power	48.2
1	1	absolute-power	5.60E-10
1	1	frequency-organisation	1.5
1	1	amplitude-organisation	1.947
1	2	frequency	10.5
1	2	amplitude	1.60E-05
1	2	relative-power	0.6
1	2	absolute-power	6.87E-12
1	2	frequency-organisation	2.5
1	2	amplitude-organisation	1.159
:	:	:	:
21	6	frequency	25.5
21	6	amplitude	5.10E-06
21	6	relative-power	2
21	6	absolute-power	6.82E-13
21	6	frequency-organisation	1
21	6	amplitude-organisation	1.139

Table 32. Example feature file (FEAT\*.TXT)

The next application, EEGINT.CLP, is a knowledge base for the expert system shell FuzzyCLIPS, and takes as input the artefact report files, the activity feature files and the EEG record details file. This application performs the artefact removal (see Section 5.5), the data reduction (see Section 5.4) and the analysis to produce the factual report and the assessment of the abnormality of the EEG. The output file is named REPORT.TXT. An example is depicted in Table 33.



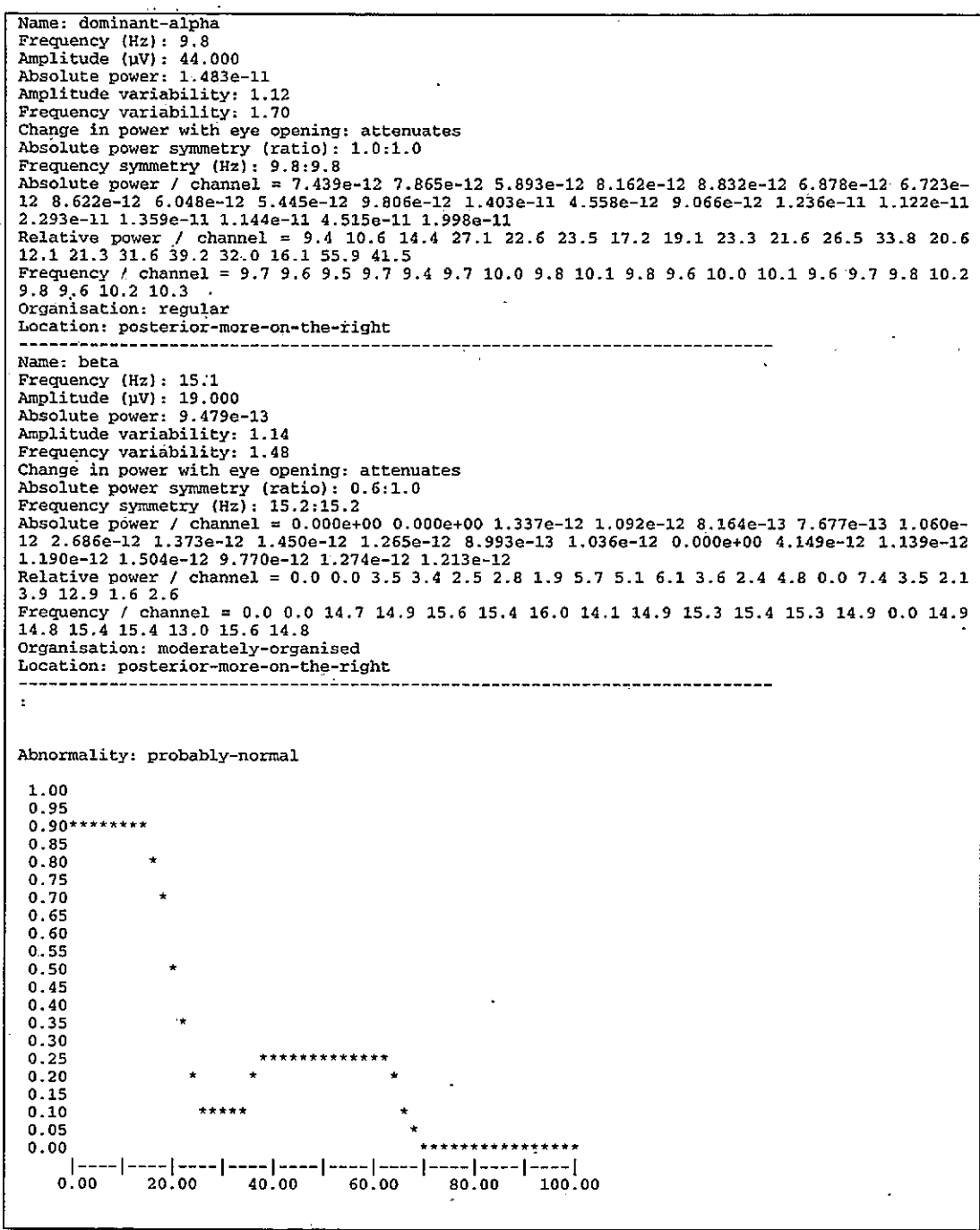
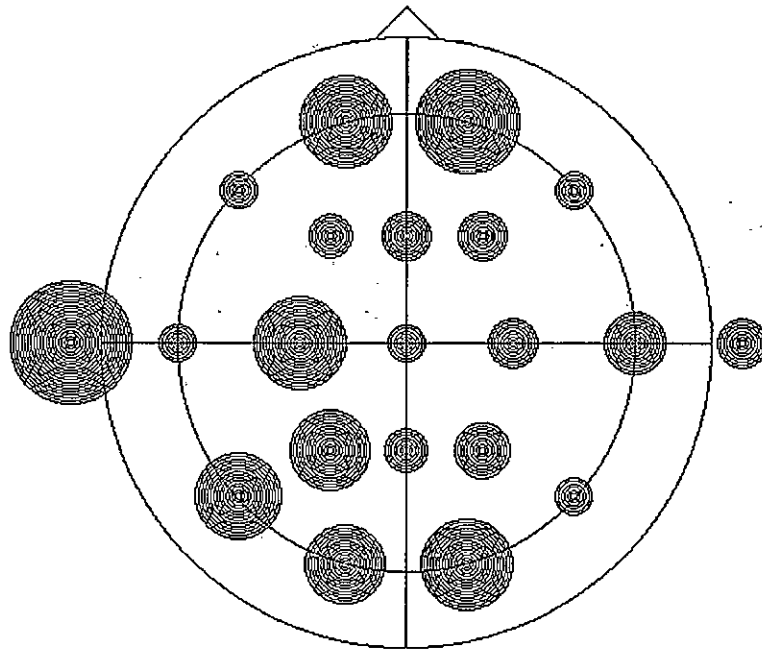


Table 33. Example output file (REPORT.TXT)

The last application, CANO.EXE takes as input 21 values corresponding to the absolute power of an activity in channels 1 to 21 and produces a graphical display of the power by way of a weighted marker superimposed on the EEG electrode positions on a diagram of the scalp (Figure 55).





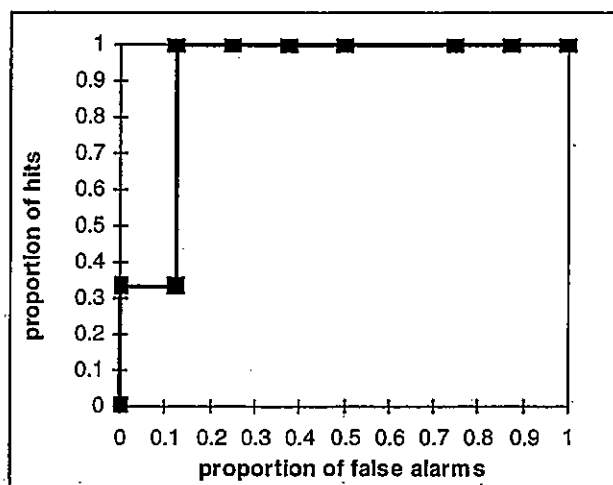
*Figure 55. Canonogram. The graphical display of power of an activity.*

# Appendix I

## Implication operator evaluation results

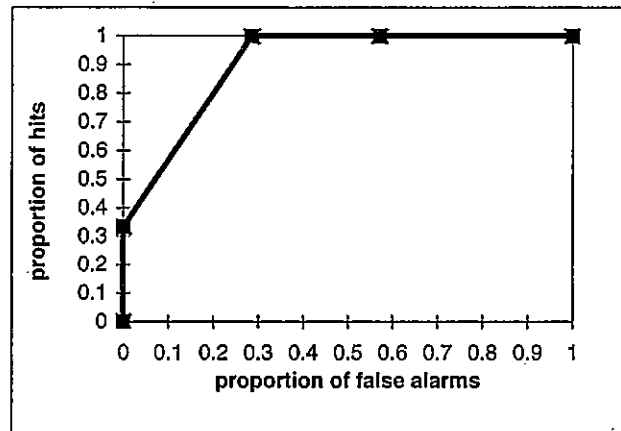
Lukasiewicz

		Gold standard	
		abnormal	normal
System	extremely-probably-abnormal	1	
	very-probably-abnormal		
	probably-abnormal		
	somewhat-probably-abnormal		
	more-or-less-probably-abnormal		
	extremely-possibly-abnormal		
	very-possibly-abnormal		
	possibly-abnormal		
	somewhat-possibly-abnormal		
	more-or-less-possibly-abnormal		
	equivocal	2	1
	more-or-less-possibly-normal		
	somewhat-possibly-normal		
	possibly-normal		
	very-possibly-normal		
	extremely-possibly-normal		
	somewhat-probably-normal		
	more-or-less-probably-normal		
	probably-normal		
	very-probably-normal		
extremely-probably-normal			



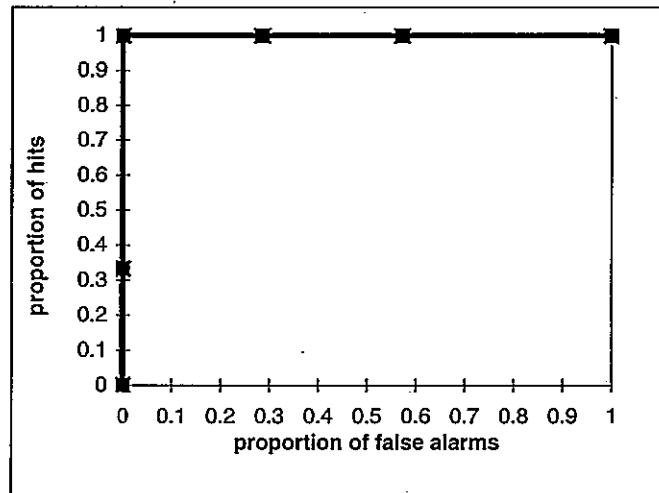
Brouwer / Godel

		Gold standard	
		abnormal	normal
System	extremely-probably-abnormal	1	
	very-probably-abnormal		
	probably-abnormal		
	somewhat-probably-abnormal		
	more-or-less-probably-abnormal		
	extremely-possibly-abnormal	2	
	very-possibly-abnormal		
	possibly-abnormal		
	somewhat-possibly-abnormal		
	more-or-less-possibly-abnormal		
	equivocal	2	
	more-or-less-possibly-normal		
	somewhat-possibly-normal		
	possibly-normal		
	very-possibly-normal		
	extremely-possibly-normal	3	
	somewhat-probably-normal		
	more-or-less-probably-normal		
	probably-normal		
	very-probably-normal		
extremely-probably-normal			



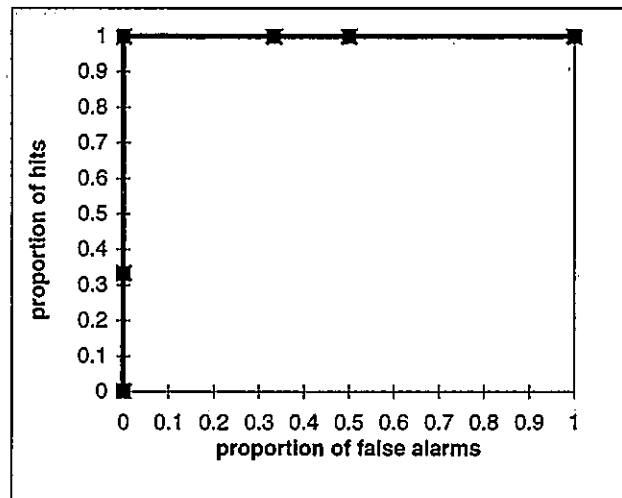
Kleene / Diens

		Gold standard	
		abnormal	normal
System	extremely-probably-abnormal	1	
	very-probably-abnormal		
	probably-abnormal		
	somewhat-probably-abnormal		
	more-or-less-probably-abnormal		
	extremely-possibly-abnormal		
	very-possibly-abnormal		
	possibly-abnormal	2	
	somewhat-possibly-abnormal		
	more-or-less-possibly-abnormal		
	equivocal	3	
	more-or-less-possibly-normal		
	somewhat-possibly-normal		
	possibly-normal		
	very-possibly-normal		
	extremely-possibly-normal		
	somewhat-probably-normal		
	more-or-less-probably-normal		
	probably-normal		
	very-probably-normal		
extremely-probably-normal			



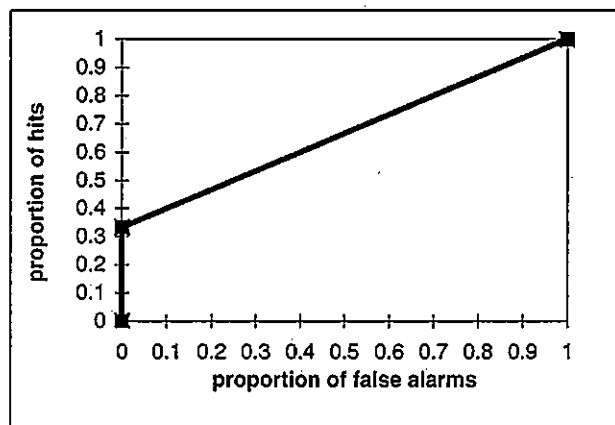
Mamdani

		Gold standard			
		abnormal	normal		
System	extremely-probably-abnormal	1			
	very-probably-abnormal				
	probably-abnormal				
	somewhat-probably-abnormal				
	more-or-less-probably-abnormal				
	extremely-possibly-abnormal				
	very-possibly-abnormal				
	possibly-abnormal	2			
	somewhat-possibly-abnormal				
	more-or-less-possibly-abnormal				
	equivocal	1			
	more-or-less-possibly-normal				
	somewhat-possibly-normal				
	possibly-normal			2	
	very-possibly-normal			1	
	extremely-possibly-normal				
	somewhat-probably-normal				
	more-or-less-probably-normal				
	probably-normal				3
	very-probably-normal				
extremely-probably-normal					

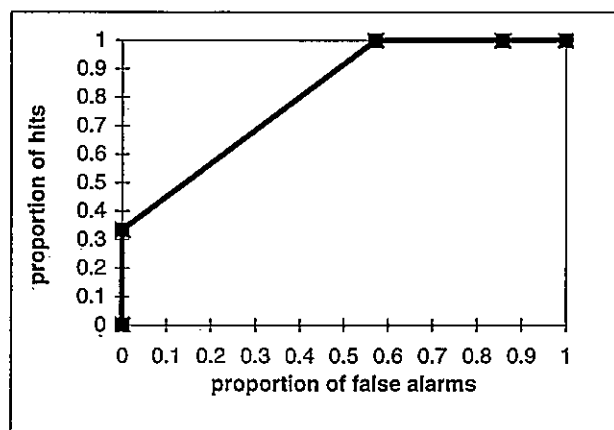


# Sharp

		Gold standard		
		abnormal	normal	
System	extremely-probably-abnormal	1		
	very-probably-abnormal			
	probably-abnormal			
	somewhat-probably-abnormal			
	more-or-less-probably-abnormal			
	extremely-possibly-abnormal			
	very-possibly-abnormal			
	possibly-abnormal			
	somewhat-possibly-abnormal			
	more-or-less-possibly-abnormal			
	equivocal	2		
	more-or-less-possibly-normal			7
	somewhat-possibly-normal			
	possibly-normal			
	very-possibly-normal			
	extremely-possibly-normal			
	somewhat-probably-normal			
	more-or-less-probably-normal			
	probably-normal			
	very-probably-normal			
extremely-probably-normal				

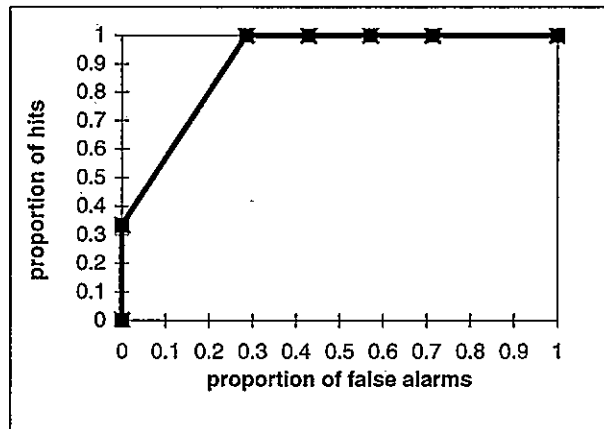


		Gold standard			
		abnormal	normal		
System	extremely-probably-abnormal	1			
	very-probably-abnormal				
	probably-abnormal				
	somewhat-probably-abnormal				
	more-or-less-probably-abnormal				
	extremely-possibly-abnormal				
	very-possibly-abnormal				
	possibly-abnormal	2	4		
	somewhat-possibly-abnormal				
	more-or-less-possibly-abnormal				
	equivocal				
	more-or-less-possibly-normal				
	somewhat-possibly-normal				
	possibly-normal				
	very-possibly-normal				
	extremely-possibly-normal			2	
	somewhat-probably-normal				
	more-or-less-probably-normal				
	probably-normal				
	very-probably-normal		1		
extremely-probably-normal					



# Quotient

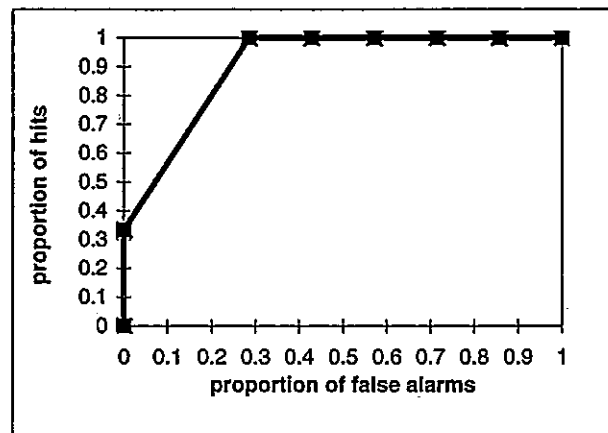
		Gold standard	
		abnormal	normal
System	extremely-probably-abnormal	1	
	very-probably-abnormal		
	probably-abnormal		
	somewhat-probably-abnormal		
	more-or-less-probably-abnormal		
	extremely-possibly-abnormal		
	very-possibly-abnormal		
	possibly-abnormal		
	somewhat-possibly-abnormal		
	more-or-less-possibly-abnormal		
	equivocal	2	2
	more-or-less-possibly-normal		
	somewhat-possibly-normal		1
	possibly-normal		1
	very-possibly-normal		
	extremely-possibly-normal		
	somewhat-probably-normal		1
	more-or-less-probably-normal		
	probably-normal		2
	very-probably-normal		
extremely-probably-normal			





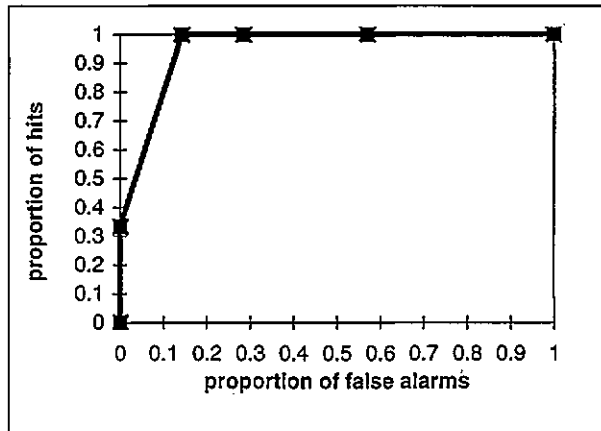
## Augmented quotient

		Gold standard	
		abnormal	normal
System	extremely-probably-abnormal	1	
	very-probably-abnormal		
	probably-abnormal		
	somewhat-probably-abnormal		
	more-or-less-probably-abnormal		
	extremely-possibly-abnormal		
	very-possibly-abnormal		
	possibly-abnormal		
	somewhat-possibly-abnormal		
	more-or-less-possibly-abnormal		
	equivocal	2	2
	more-or-less-possibly-normal		
	somewhat-possibly-normal		
	possibly-normal		1
	very-possibly-normal		
	extremely-possibly-normal		1
	somewhat-probably-normal		
	more-or-less-probably-normal		
	probably-normal		1
	very-probably-normal		1
extremely-probably-normal		1	



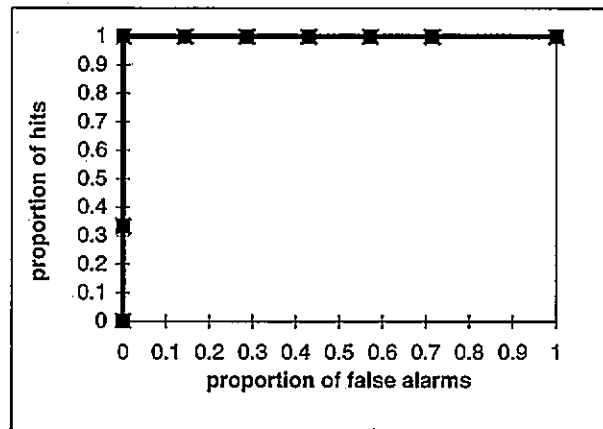
Zadeh

		Gold standard		
		abnormal	normal	
System	extremely-probably-abnormal	1		
	very-probably-abnormal			
	probably-abnormal			
	somewhat-probably-abnormal			
	more-or-less-probably-abnormal			
	extremely-possibly-abnormal			
	very-possibly-abnormal			
	possibly-abnormal	2		
	somewhat-possibly-abnormal			
	more-or-less-possibly-abnormal			
	equivocal			1
	more-or-less-possibly-normal			1
	somewhat-possibly-normal			2
	possibly-normal			
	very-possibly-normal			
	extremely-possibly-normal			
	somewhat-probably-normal			
	more-or-less-probably-normal			3
	probably-normal			
	very-probably-normal			
extremely-probably-normal				



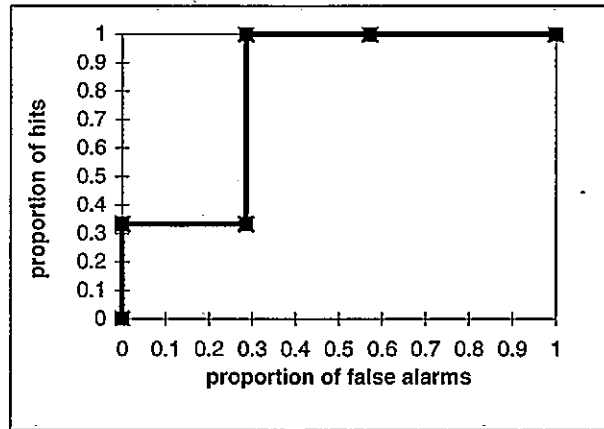
# Product

		Gold standard	
		abnormal	normal
System	extremely-probably-abnormal	1	
	very-probably-abnormal		
	probably-abnormal		
	somewhat-probably-abnormal		
	more-or-less-probably-abnormal		
	extremely-possibly-abnormal		
	very-possibly-abnormal		
	possibly-abnormal		
	somewhat-possibly-abnormal		
	more-or-less-possibly-abnormal		
	equivocal	2	
	more-or-less-possibly-normal		
	somewhat-possibly-normal		
	possibly-normal		
	very-possibly-normal		
	extremely-possibly-normal		
	somewhat-probably-normal		
	more-or-less-probably-normal		
	probably-normal		
	very-probably-normal		
extremely-probably-normal			



Willmott

		Gold standard	
		abnormal	normal
System	extremely-probably-abnormal	1	
	very-probably-abnormal		
	probably-abnormal		
	somewhat-probably-abnormal		
	more-or-less-probably-abnormal		
	extremely-possibly-abnormal		
	very-possibly-abnormal		
	possibly-abnormal		
	somewhat-possibly-abnormal		
	more-or-less-possibly-abnormal		
	equivocal	2	
	more-or-less-possibly-normal	2	
	somewhat-possibly-normal		
	possibly-normal		
	very-possibly-normal		
	extremely-possibly-normal		
	somewhat-probably-normal		
	more-or-less-probably-normal		
	probably-normal		
	very-probably-normal		
extremely-probably-normal	3		



# Appendix J

## Papers

---

# Automated qualitative interpretation of EEGs using fuzzy logic

E. P. Riddington<sup>1</sup>, E. C. Ifeachor<sup>1</sup>, E. M. Allen<sup>2</sup>, N. Hudson<sup>2</sup>, H. S. K. Wimalaratna<sup>2</sup>  
and D. J. Mapps<sup>1</sup>.

<sup>1</sup>School of Electronic, Communication and Electrical Engineering, University of  
Plymouth.

<sup>2</sup>Dept. of Clinical Neurophysiology, Derriford Hospital, Plymouth.

## Abstract

This paper describes a method for producing an automated qualitative factual report using fuzzy logic. EEG features such as frequency, amplitude, absolute power, relative power, frequency variability and amplitude variability are extracted on a segment-by-segment basis and formed into clusters which correspond to unique activities in the EEG. In each cluster, quantitative features like average frequency or maximum amplitude are then calculated. Qualitative features such as organisation, amount, symmetry and distribution over scalp - often described as 'rather asymmetric' or 'somewhat irregular' - are modelled on fuzzy logic to capture the subjectivity prevalent in clinical practice. These models are embodied into a knowledge-based system which automatically analyses the EEG and generates a factual report describing the salient features; e.g. 'somewhat regular alpha rhythm, 8.4Hz, 40 $\mu$ V, distributed posteriorly - more on the right than left, and attenuates on eye opening'. The report is objective, consistent and lacks the inter-personnel variability.

# KNOWLEDGE-BASED ENHANCEMENT AND INTERPRETATION OF EEG SIGNALS

Riddington E P<sup>1</sup>, Wu J<sup>1</sup>, Ifeachor E C<sup>1</sup>, Allen E M<sup>2</sup> and Hudson N R<sup>2</sup>.

<sup>1</sup>School of Electronic, Communication and Electrical Engineering, University of Plymouth.

<sup>2</sup>Dept. of Clinical Neurophysiology, Derriford Hospital, Plymouth.

## ABSTRACT

The need to automate the interpretation of the EEG to provide a more efficient and reliable assessment is widely recognised. Techniques developed thus far however, neither adequately deal with the uncertainty in the knowledge, which is linguistic in nature, or deal with contamination of the EEG by artefacts. By developing models to interpret the EEG based on fuzzy logic, and integrating many years of research for the reliable processing of artefacts, this work aims to develop a reliable technique for the purpose of developing a decision support system for EEG staff to ensure accurate interpretation of the EEG. Results include an automatically generated factual report of an EEG which deals with uncertainty in manner akin to the human reasoning. The results also show a reduction in bias in the factual report introduced by artefact contamination.

## INTRODUCTION

The electroencephalogram (EEG), the recording of electrical activity of the brain, is used in hospitals world-wide for the analysis and diagnosis of various normal and diseased states of the brain such as sleep, dementia and epilepsy. Typically it is recorded for 15 - 60 minutes from 21 locations on the scalp. A report is then written describing the relevant features of the EEG, and finally an interpretation is made in the light of the clinical problem. The waveforms of interest in the EEG are often called *activity* and can be classified as either background or transient. Background activity is on-going and rhythmic and is usually classified by frequency into the bands: delta (0 - 4Hz), theta (4 - 8Hz), alpha (8 - 13Hz) and beta (> 13Hz). Transient activity is short duration and is usually described in terms of waveform such as spikewave or sharpwave. Figure 1 shows 4 seconds of EEG and the electrode positions from where each EEG channel was recorded. An alpha rhythm is clearly discernible, particularly at the back of the head. This rhythm is characteristic of the normal adult.

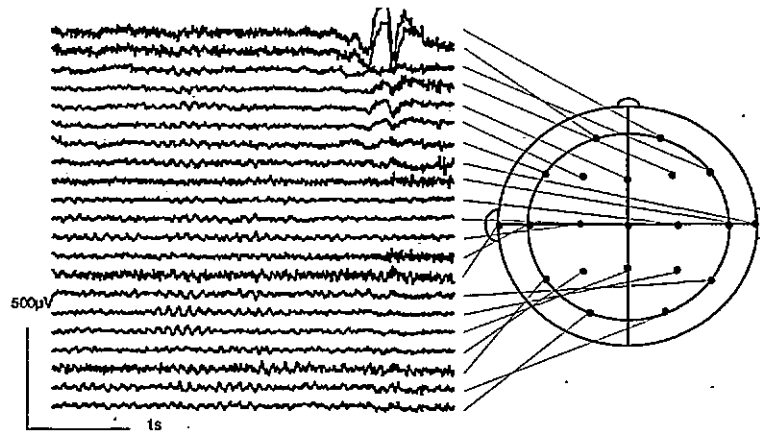


Figure 1. The normal EEG.

Although some knowledge of the origin of EEG signals exists, much is still unknown. As a consequence, the interpretation of these signals is based partly on an empirical as well as physiological understanding, making EEG interpretation a subjective procedure requiring many years of experience. Further, to interpret the EEG, features such as frequency and amplitude need to be analysed both in time and spatially on the scalp. This makes EEG interpretation a difficult, time consuming and laborious task, especially when carried out on the routine 15 - 60 minute recording. Interpretations consequently differ between clinicians, leading to variable and sometimes erroneous assessments [Kiloh *et al.* 1981].

The need to automate the interpretation of the EEG to provide a more efficient and reliable assessment is widely recognised, but is complicated by 2 factors: the presence of artefacts which contaminate the EEG, making interpretation difficult, and the adequate capture of subjective expertise which is ill-suited to conventional methods of artificial intelligence. Techniques developed to interpret the EEG thus far [Nakamura *et al.* 1992, Jagannathan *et al.* 1982], neither adequately, if at all, deal with the uncertainty in the knowledge which is linguistic in nature, or deal with the contamination of the EEG by artefacts, which seriously biases or invalidates system results. Unlike certainty factors, fuzzy logic deals with uncertainty in a manner akin to human reasoning, that is linguistically (e.g. very normal, somewhat normal, extremely abnormal) rather than numerically (e.g. normal [0.7], normal [0.3], abnormal [1]). By developing models to interpret the EEG based on fuzzy logic, and integrating many years of research for the reliable processing of artefacts, this work aims to develop a reliable technique for the purpose of developing a decision support system for EEG staff to ensure accurate interpretation of the EEG and provide some relief to the clinical work load.

## DATA COLLECTION

For the development of a reliable technique to interpret the EEG the collection of appropriate data in sufficient amounts is paramount. The data required is 21 channel EEG taken from awake Alzheimer's disease patients and age-matched normal controls and for screening purposes, age, medical history, family medical history and a mental state assessment. For the initial study, a collection system and protocol was integrated into the hospital environment and 8 normal control volunteers and 3 Alzheimer's EEGs were recorded.



## FEATURE EXTRACTION

To characterise each activity in each channel in each 4 second segment, 6 basic time and frequency domain features were extracted. The features *frequency*, *power*, *amount* and *frequency variability*, were taken from the power spectral density (PSD), where frequency was the frequency of a PSD peak maximum, power was the area of a PSD peak, amount was the area of a PSD peak as a percentage of the whole PSD and frequency variability was the width of a PSD peak (Figure 2). The features *amplitude* and *amplitude variability* were taken from the time domain by isolating the activity in time using a digital filter whose passband was defined by the width of the PSD peak (Figure 3). Amplitude was defined as the maximum peak to peak swing and amplitude variability was defined as the mean standard deviation of the maxima and minima. To produce a value that was amplitude independent, the maxima and minima values were first divided by their mean value.

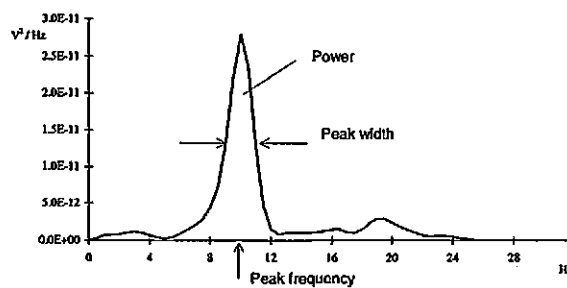


Figure 2. Frequency domain features using power spectral density estimation.

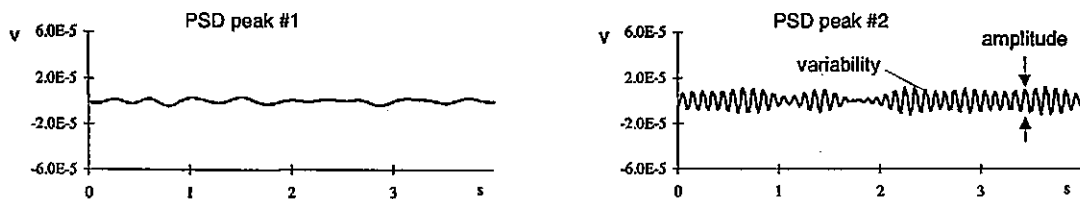


Figure 3. Time domain features using frequency band filtering.

## DATA REDUCTION

PSD peak detection is a highly sensitive method for identifying activity in the EEG, typically identifying around 100 activities in a 4 second epoch. Many of the activities however are of the same origin, in fact, the clinician rarely identifies more than 10 activities in the entire EEG record. Because background activity is usually classified according to frequency, activities were clustered by frequency using the leader cluster algorithm. This procedure usually produces about 9 - 15 clusters, each corresponding to unique activities in the EEG.

## INTELLIGENT SIGNAL ANALYSIS

Some of the features used to describe the EEG can and are expressed *quantitatively*. For example, amplitude is often measured by the clinician as the maximum peak-peak swing (in  $\mu\text{V}$ ), and frequency is often measured by counting the number of peaks contained in a 1 second window (in Hz). Other features such as the organisation of activity or the location of activity on the scalp cannot quantitatively be measured without additional computerised analysis. Instead, these features are measured by the clinician *qualitatively* using pattern analysis expertise obtained through training and experience.

Table 1 shows 7 features used to describe each activity in the EEG. Also shown are the extracted features from which these features will be calculated. For the quantitative features: amplitude, frequency and symmetry, the extracted features can be used directly. For the qualitative features, location, organisation and change on eye opening, an intelligent technique is necessary to model the pattern analysis expertise of the clinician.

Features	Example	Extracted features
Frequency	10Hz	mean cluster frequency
Amplitude	50 $\mu\text{V}$	maximum cluster amplitude
Amount symmetry	1 : 0.6	ratio of the cluster power in the left and right hemisphere
Frequency symmetry	10Hz : 10.6Hz	mean cluster frequencies in the left and right hemisphere
Location	right anterior	distribution of cluster power across the scalp normalised to 1
Organisation	irregular	mean cluster frequency variability and mean cluster amplitude variability
Change on eye opening	attenuates	difference between eyes closed cluster power and corresponding eyes open cluster power

Table 1. Features used to describe activity in the EEG.

## FUZZY SYSTEM DEVELOPMENT

The development of a fuzzy system to model imprecise expertise is typically carried out in 4 stages:

- *define rules*
- *define fuzzy relations* to model each rule and fact
- *perform compositional rule of inference* to calculate the deduction
- *utilise deduction* e.g. for a crisp output perform defuzzification, for a linguistic output perform linguistic approximation or for forward chaining assert the deduction as a new fact

To model the pattern analysis expertise to extract the features organisation and change on eye opening, fuzzy models were developed using the stages described above. For a detailed example of performing these stages see [Riddington *et al.* 1996].

### Organisation

Organisation is an important feature, particularly when assessing the dominant rhythm in the EEG. Defined as the degree to which an activity conforms to certain ideal

characteristics [Chatrian *et al.* 1974], and measured in this case as variability in amplitude and frequency. The relationship between the organisation of an activity and the features frequency variability and amplitude variability is described by the rules in Table 2. Each fuzzy proposition were defined using s, z or pi shaped fuzzy sets. From these, rule models were constructed using the Mamdani implication and the deduction calculated using the compositional rule of inference. Finally a linguistic approximation to the deduction was calculated using primary sets *regular*, *moderate* and *irregular* and hedges *extremely*, *very*, *somewhat*, and *more or less*. Each hedge performed a power operation of 3, 2, 0.5 and 0.333 on the primary sets respectively.

IF frequency variability is organised	IF frequency variability is organised
AND amplitude variability is organised	AND amplitude variability is disorganised
THEN organisation is regular	THEN organisation is moderate
IF frequency variability is disorganised	IF frequency variability is disorganised
AND amplitude variability is organised	AND amplitude variability is disorganised
THEN organisation is moderate	THEN organisation is irregular

Table 2. Knowledge-base modelling expertise to calculate the feature organisation.

### Reactivity To Eye Opening

Another important feature for assessing the dominant rhythm in the EEG is its reactivity to eye opening. For example, in dementia, the lack of alpha rhythm reactivity can be a highly sensitive diagnostic sign [Visser 1991]. To calculate the change of an activity between eyes open and eyes closed states, clusters needed to be identified in each state which corresponded to the same activity. This was carried out using a measure of similarity. The difference between the average power in each cluster pair was then used to give the change on eye opening. Similarity between eyes closed and eyes open clusters was measured using frequency (mean cluster frequency) and location (distribution of power across the scalp normalised to 1) by the rules shown in Table 3. Defuzzification of the deduction from these rules provided a numerical measure for similarity. Eyes open / eyes closed cluster pairs having the maximum measure of similarity were thus selected as clusters corresponded to the same activity. Change on eye opening was calculated using cluster average power using the rules in Table 4. Finally, a linguistic approximation to the deduction was calculated using primary sets *attenuates*, *does not change* and *increases* and hedges *extremely*, *very*, *somewhat*, and *more or less*.

```

IF eyes open frequency equals eyes closed frequency
AND eyes open location equals eyes closed location
THEN similarity is high
IF eyes open frequency does not equal eyes closed frequency
AND eyes open location equals eyes closed location
THEN similarity is moderate
IF eyes open frequency equals eyes closed frequency
AND eyes open location does not equal eyes closed location
THEN similarity is moderate
IF eyes open frequency does not equal eyes closed frequency
AND eyes open location does not equal eyes closed location
THEN similarity is low

```

*Table 3. Knowledge-base modelling expertise to measure similarity between eyes open and closed activity.*

```

IF difference between eyes closed and eyes open power as a
percentage is positive
THEN activity attenuates on eye opening
IF difference between eyes closed and eyes open power as a
percentage is zero
THEN activity does not change on eye opening
IF difference between eyes closed and eyes open power as a
percentage is negative
THEN activity increases on eye opening

```

*Table 4. Knowledge-base modelling expertise to calculate the feature reactivity to eye opening.*

## Location

The calculation of location of activity on the scalp was based on the distribution across the channels of power in a cluster. Normalising the distribution to 1 provides the membership values of the location of the clusters for each channel. Linguistic approximation was then calculated using primary fuzzy sets *posterior*, *anterior*, *frontal*, *central*, *post-central*, *parietal*, *occipital*, *left-temporal*, *right-temporal*, *temporal*, *right-laterally*, *left-laterally* and *diffuse* and hedges *left*, *right*, *more-on-the-left* and *more-on-the-right*.

## ARTEFACT PROCESSING

An important issue in visual EEG examination is the effect of artefacts, which are mostly non-cerebral activities. Artefacts can seriously affect the interpretation of EEG since they could have similar waveforms as genuine activities. The importance of artefact processing to automated EEG is widely recognized to ensure that the interpretation takes place in the proper context.

In general, artefact processing includes two major steps: artefact identification and artefact removal/rejection. The former detects the existence of artefacts in EEG and identifies their types. The latter removes the contamination caused by artefacts from EEG signals with minimal distortion of important clinical information or rejects the signal if no appropriate removal procedure can be found.

In this paper, we use an artefact processing system based on neural networks (NN) and expert system, whose structure is shown in Figure 4. Time and frequency domain features are extracted from EEG. The phase I identification involves classifier design using multilayer feedforward networks. The networks are trained using the data selected by medical experts. The phase II identification employs the expert knowledge to analyse the outputs from the NN classifiers to further increase the successful rate of classification. The detailed description of feature extraction and classifier design can be found in [Wu *et al.* 1994].

The output of the artefact processing system is a table which labels each channel of EEG with the artefact type or as artefact-free.

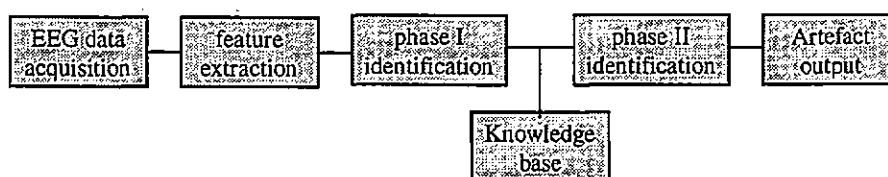


Figure 4. Artefact processing system.

These labels can then be used to exclude from the clustering procedure the PSD peaks suspected of artefact contamination (Figure 5).

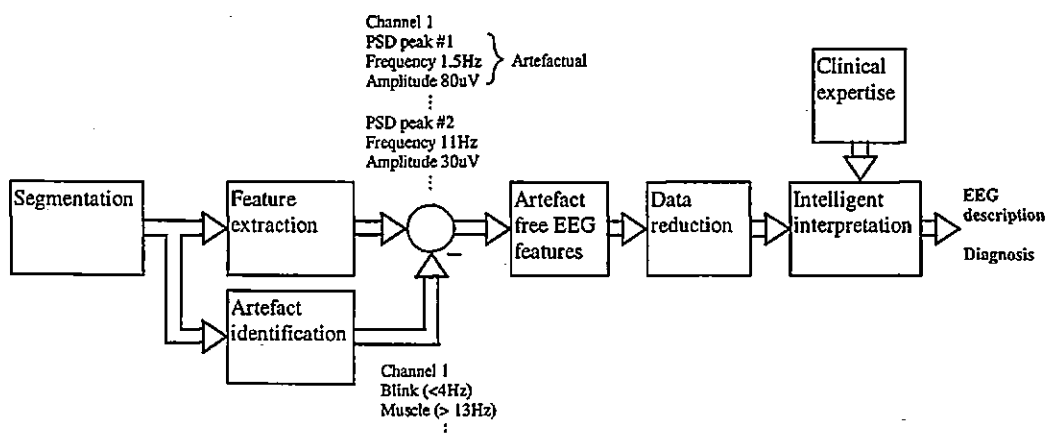


Figure 5. System for intelligent enhancement and interpretation.

## RESULTS

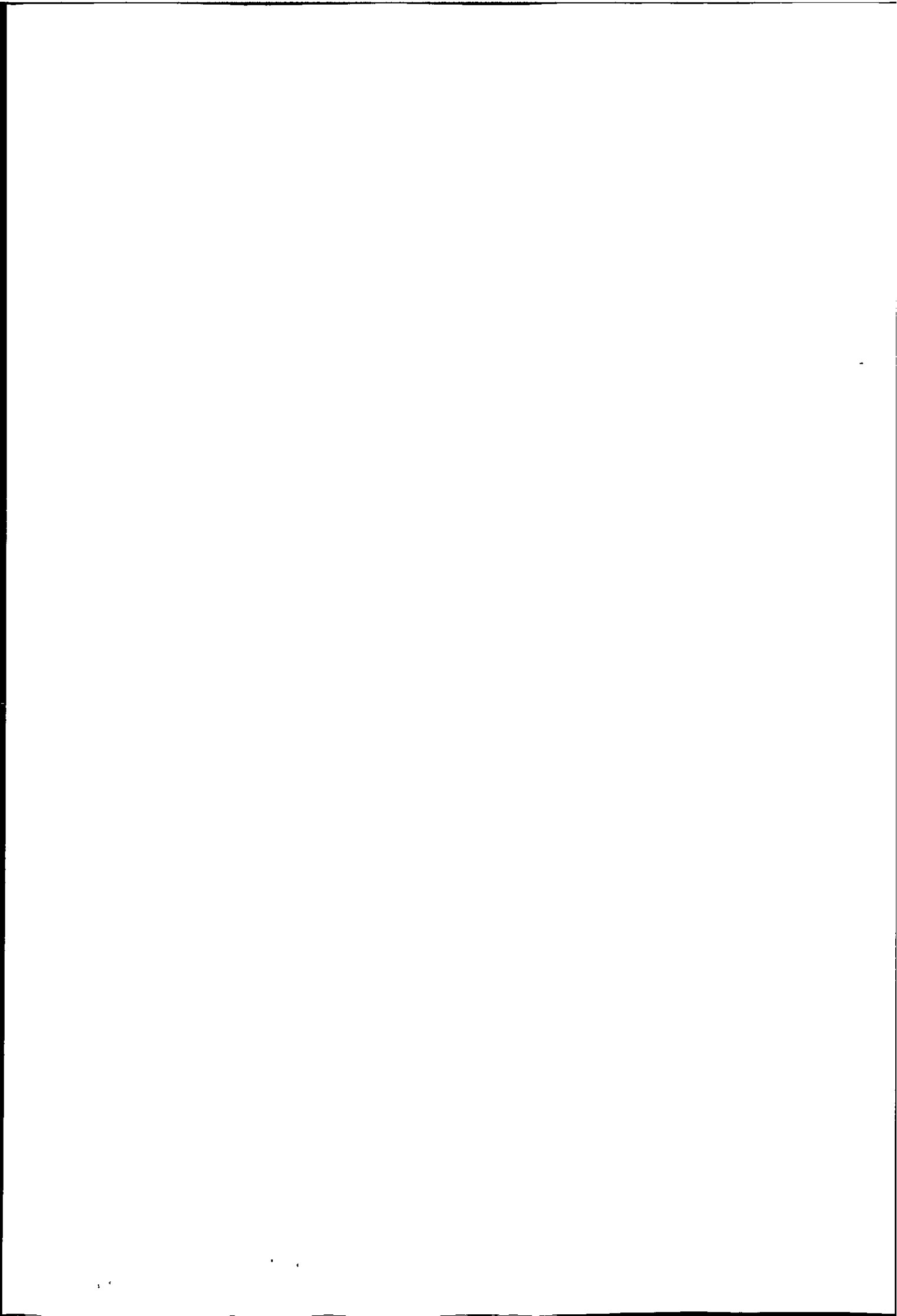
Quantitative features calculated during feature extraction and qualitative features calculated during intelligent signal analysis, when combined, produce a description which efficiently characterises the entire EEG. Table 5 shows the generated description produced from the EEG of volunteer #2. Significant activities and artefacts for volunteer #2 are a regular dominant alpha rhythm, located in the posterior region, 10Hz, 50 $\mu$ V, which is symmetrical and attenuates on eye opening; beta activity, located diffusely, 20Hz, up to 20 $\mu$ V, which is symmetrical; muscle, located in the frontal region, approx 22Hz upwards, 50 $\mu$ V, which reduces on eye opening; muscle, located temporal regions - more on the left, approx 20Hz upwards, 30-50 $\mu$ V, which does not change on eye opening and small eye movements, up to 40 $\mu$ V, which increases considerably on eye opening.



The canonogram, the display of the distribution of power for each cluster, verifies the effectiveness of the linguistic approximation technique for describing activity location. Cluster #6 describes the alpha rhythm well. The large and artefact prone frequency range of beta activity (> 13Hz) has resulted in the sharing of beta activity between clusters #1, #3 and #4. All other clusters are probably artefact. Only PSD peaks  $\leq 4$ Hz were removed by the system when eye movement or blinks were identified. As a consequence cluster #7 which is > 4Hz have not been removed. Cluster #2 is very low power and is probably insignificant. Cluster #5 represents eye movements not identified by the artefact processor.

Computer generated factual report				
#	Description	Amount symmetry	Frequency symmetry	Canonogram
1	somewhat-regular <b>beta</b> -activity, 19Hz, 18 $\mu$ V, located-post-central-more-on-the-left, attenuates-on-eye-opening	0.9 : 1	18.9 : 19	
2	moderately-organised <b>beta</b> -activity, 25.1Hz, 8.8 $\mu$ V, located-diffuse-more-on-the-right, attenuates-on-eye-opening	0.9 : 1	25 : 25	
3	somewhat-moderately-organised <b>beta</b> -activity, 22.2Hz, 12 $\mu$ V, located-central, attenuates-on-eye-opening	1 : 0.9	22.3 : 22.2	
4	regular <b>beta</b> -activity, 15.1Hz, 19 $\mu$ V, located-posterior-more-on-the-right, attenuates-on-eye-opening	0.6 : 1	15.2 : 15.2	
5	somewhat-regular <b>delta</b> -activity, 1.8Hz, 20 $\mu$ V, located-frontal-more-on-the-right, increases-on-eye-opening	1 : 1	1.6 : 1.9	
6	more-or-less-regular <b>dominant-alpha</b> -rhythm, 9.8Hz, 44 $\mu$ V, located-posterior-more-on-the-right, attenuates-on-eye-opening	0.9 : 1	4.5 : 5.1	
7	regular <b>delta-theta</b> -activity, 4.8Hz, 23 $\mu$ V, located-frontal-more-on-the-right, increases-on-eye-opening	0.9 : 1	4.5 : 5.1	

Table 5. Factual description of the EEG for volunteer #2.





The effects of artefact processing on the interpretation are shown in Table 6. Prior to artefact processing, muscle activity found in the frontal, and left temporal regions have biased many of the features of the beta activity. Artefact processing removes PSD peaks suspected of muscle, blink or eye movement corruption and has thus removed some of the bias in the results.

Description	Amount symmetry	Frequency symmetry	Canonogram
<p><i>Without artefact processing</i></p> <p>somewhat-regular beta-activity, 20Hz, 24<math>\mu</math>V, located-diffusely-more-on-the-left, attenuates-on-eye-opening</p>	1 : 0.9	19.9 : 19.9	
<p><i>With artefact processing</i></p> <p>somewhat-regular beta-activity, 19Hz, 18<math>\mu</math>V, located-posterior-central-more-on-the-left, attenuates-on-eye-opening</p>	0.9 : 1	18.9 : 19	

Table 6. Effects of artefact processing.

## CONCLUSIONS

Salient features of the EEG are both quantitative and qualitative. Quantitative examples are amplitude where the clinician measures the parameter using a ruler, or frequency, where peaks in a 1 second segment are counted. Qualitative examples include organisation where the amplitude and frequency of a rhythm are assessed with regard to uniformity and descriptions such as *regular* or *irregular* are subjectively applied. Similar situations exist for location, change on eye opening and overall abnormality.

Fuzzy sets enable such descriptions to be formally represented by allowing objects such as frequency variation measurements to be members to subjective terms such as *organised* or *disorganised* to a degree. Inference in formal systems have long been based on truth. How does one however represent the truth of the proposition *the rhythm is organised* if *organised* is ill-defined? Fuzzy logic represents the truth of such propositions with equally ill-defined measures of truth such as *somewhat true*. Reasoning with fuzzy logic modifies the conclusion of a rule given the truth of the rule antecedent by increasing the vagueness for decreasing truth. A procedure called linguistic approximation then identifies the changes made in the conclusion and applies *hedges* such as *the rhythm is very irregular* or *the rhythm is somewhat regular* to represent these changes.

The qualitative nature of EEG interpretation was represented using these techniques to provide a factual report of the EEG which accurately describes the qualitative features such as organisation and location of activity e.g. descriptions such as *organisation is very irregular, location is posterior - more on the left*. This is in stark difference with existing published techniques to interpret the EEG which portray uncertainty to the clinician numerically, and being incompatible to the clinician, require experience to understand and interpret.

To take into account the effects of artefacts, the system omits from the clustering procedure, frequency peaks which are suspected of having artefact origin by incorporating work from [Wu *et al.* 1994]. Rather than omitting the PSD peak, further work will correct the effects of artefacts in a PSD peak, particularly if it contains information of cerebral origin by incorporating work from [Ifeachor *et al.* 1990].

## ACKNOWLEDGEMENTS

We would like to thank the EPSRC for their financial support, each volunteer for providing the normal control EEG data and Dr Sunil Wimalaratna and the EEG technicians for their help and assistance. We would also like to thank Ping Wu for providing the canonogram software.

## REFERENCES

- Chatrian G E, Bergamini L, Dondey M, Klass D W, Lennox-Buchthal M and Petersen I. (1974) A glossary of terms most commonly used by clinical electroencephalographers. *Electroenceph. and clin. Neurophys.* Vol. 82, pp. 423-431.
- Ifeachor E C, Hellyar M T, Mapps D J and Allen E M. (1990) Knowledge-based enhancement of human EEG signals. *IEE Proc.* Vol. 137, Pt. F, pp. 302-310.
- Jagannathan V, Bourne J R, Jansen B H and Ward J W. (1982) Artificial intelligence methods in quantitative electroencephalogram analysis. *Computer Programs in Biomedicine*, Vol. 15, pp. 249-258.
- Kiloh L G, McComas A J, Osselton J W and Upton A R M. (1981) Clinical electroencephalography, 4<sup>th</sup> Ed. Butterworths.
- Nakamura M, Shibasaki H, Imajoh K, Nishida S, Neshige R and Ikeda A. (1992) Automatic EEG interpretation: a new computer-assisted system for the automatic integrative interpretation of awake background EEG. *Electroenceph. and clin. Neurophys.* Vol. 82, pp. 423-431.
- Riddington E P, Ifeachor E C, Allen E M, Hudson N R and Mapps D J. (1996) Investigation into different methods of fuzzy inference using ROC analysis. Proc. of the 2<sup>nd</sup> Int. Conf. on Neural Networks and Expert Systems in Medicine and Healthcare, University of Plymouth, Plymouth.
- Visser S L. (1991) The electroencephalogram and evoked potentials in normal and ageing dementia. *Event-Related Brain Research (EEG Suppl. 42)*, pp. 289-303.
- Wu J, Ifeachor E C, Allen E M and Hudson N R. (1994) A neural network based artefact detection system for EEG signal processing. Proc. of the Int. Conf. on Neural Networks and Expert Systems in Medicine and Healthcare, University of Plymouth, Plymouth, pp. 257-266.

# INVESTIGATION INTO DIFFERENT METHODS OF FUZZY INFERENCE USING ROC ANALYSIS

Riddington E P<sup>1</sup>, Ifeachor E C<sup>1</sup>, Allen E M<sup>2</sup> and Mapps D J<sup>1</sup>.

<sup>1</sup>School of Electronic, Communication and Electrical Engineering, University of Plymouth.

<sup>2</sup>Dept. of Clinical Neurophysiology, Derriford Hospital, Plymouth.

## ABSTRACT

Fuzzy logic is well suited to EEG analysis, where imprecision is prevalent. However, reasoning with fuzzy logic is still at present, largely unestablished, particularly for linguistic decision support systems. To assess the performance of different methods of fuzzy inference, a fuzzy system was developed to classify 3 Alzheimer's and 7 age-matched control EEGs. Different methods of inference based on 11 different implication operators were then validated using ROC analysis. Results showed that 3 operators: *Kleen-Diens*, *Mamdani* and *Product* out-performed the remainder: *Lukasiewicz*, *Brouwer-Godel*, *S#*, *S*, *Quotient*, *Augmented Quotient*, *Zadeh* and *Willmott*. Although sample numbers are small, the investigation indicates that for linguistic decision support, these operators may provide a more accurate deduction.

## INTRODUCTION

There are many examples where humans succeed to understand a process that is too complex to be modelled quantitatively, e.g. driving a car. These systems cannot be modelled quantitatively because, as stated by the *principle of incompatibility*, there is an inverse relationship between complexity of a system and the precision with which it can be understood [Zadeh 1973]. Humans succeed to understand such complex systems using knowledge that is imprecise rather than precise. The EEG, 21 channels of random signals which require analysis both spatially and temporally is an excellent example of a complex process of this type. To interpret the EEG much of the knowledge which the clinician uses is imprecise.

Some of the features used to describe the EEG can and are expressed *quantitatively*, for example, amplitude is often measured by the clinician as the maximum peak-peak swing (in  $\mu\text{V}$ ), and frequency is often measured by counting the number of peaks contained in a 1

second window (in Hz). Other features such as the organisation of activity or the location of activity on the scalp cannot quantitatively be measured without additional computerised analysis. Instead, these features are measured by the clinician *qualitatively* using pattern analysis expertise obtained through training and experience.

To model such expertise three techniques might be considered: neural networks, expert systems and fuzzy logic. Neural networks encode expertise through training. They do not need expertise to be explicitly expressed, and are therefore suited to applications where the elicitation of expertise is not possible. If the expertise can be expressed explicitly, then expert systems may be a preferred alternative to neural networks. Expert systems encode expertise in the form of rules elicited from the expert. Unlike neural networks, whose expertise is distributed across the network in the form of weights the expertise in an expert system is *transparent* which provides important validation and explanation advantages. Conventional expert systems produce a discontinuous output, switching from one deduction to another, when the input crosses rule boundaries. Fuzzy logic overcomes this problem by producing a continuous output when the input moves between rules. Fuzzy logic can provide a better approximation to expertise expressed qualitatively, whilst maintaining transparency.

## FUZZY SYSTEM DEVELOPMENT

The development of a fuzzy system to model imprecise expertise is typically carried out in 4 stages:

- *define rules*
- *define fuzzy relations* to model each rule and fact
- *perform compositional rule of inference* to calculate the deduction
- *utilise deduction* e.g. for a crisp output perform defuzzification, for a linguistic output perform linguistic approximation or for forward chaining assert the deduction as a new fact

For example,

**Stage 1.** The relationship between the organisation of an activity and the features frequency and amplitude variability might be described by the rules in Table 1.

```
Rule 1:
IF frequency variability is organised
AND amplitude variability is organised
THEN organisation is regular

Rule 3:
IF frequency variability is organised
AND amplitude variability is disorganised
THEN organisation is moderate

Rule 2:
IF frequency variability is disorganised
AND amplitude variability is organised
THEN organisation is moderate

Rule 4:
IF frequency variability is disorganised
AND amplitude variability is disorganised
THEN organisation is irregular
```

*Table 1. Rules describing the relationship between the features frequency and amplitude variability and the organisation of an activity.*



**Stage 2.** Let each rule be modelled by the fuzzy relation  $R(x,y,z) = A(x) \wedge B(y) \rightarrow C(z)$  and the facts be modelled by the fuzzy relation  $R(x,y) = A(x)' \wedge B(y)'$ , where  $A(x)$ ,  $B(y)$ ,  $C(z)$ ,  $A(x)'$  and  $B(y)'$  are fuzzy sets and  $\wedge$  and  $\rightarrow$  are the connectors conjunction and implication.

Defining fuzzy sets for the first rule:

$A(x)$  = frequency variability is organised (in Hz)

$$= \{1/0 + 1/0.5 + 1/1 + 0.75/1.5 + 0.5/2 + 0.25/2.5 + 0/3 + 0/3.5 + 0/4 + 0/4.5\}$$

$B(y)$  = amplitude variability is organised (in V normalised)

$$= \{1/0 + 1/0.5 + 0.5/1 + 0/1.5 + 0/2 + 0/2.5 + 0/3 + 0/3.5 + 0/4 + 0/4.5\}$$

$C(z)$  = organisation is regular

$$= \{1/0 + 1/0.1 + 0.7/0.2 + 0.3/0.3 + 0/0.4 + 0/0.5 + 0/0.6 + 0/0.7 + 0/0.8 + 0/0.9\}$$

$A(x)'$  = frequency variability is 1.5Hz

$$= \{0/0 + 0/0.5 + 0/1 + 1/1.5 + 0/2 + 0/2.5 + 0/3 + 0/3.5 + 0/4 + 0/4.5\}$$

$B(y)'$  = amplitude variability is 1.5V (normalised)

$$= \{0/0 + 0/0.5 + 0/1 + 1/1.5 + 0/2 + 0/2.5 + 0/3 + 0/3.5 + 0/4 + 0/4.5\}$$

The relationship between each domain in the relation  $R(x,y,z)$  and  $R(x,y)$  can be defined from the logical definitions for  $\wedge$  and  $\rightarrow$  in Lukasiewicz's infinite valued logic ( $L_\infty$ ) because membership values in fuzzy set theory and logical values in  $L_\infty$  are *isomorphic* [Klir and Folger 1988].

In  $L_\infty$ :

$P(u) \wedge Q(v)$  = conjunction =  $\text{Min}(P(u), Q(v))$

$P(u) \rightarrow Q(v)$  = implication =  $\text{Min}(1, 1-P(u)+Q(v))$

Therefore in fuzzy set theory:

$R(x,y,z) = A(x) \wedge B(y) \rightarrow C(z) = \text{Min}(1, 1-\text{Min}(A(x), B(y))+C(z))$

$R(x,y) = A(x)' \wedge B(y)' = \text{Min}(A(x)', B(y)')$

**Stage 3.** To calculate the fuzzy relation  $R(z)$  which can be inferred from the rule and fact  $R(z,y,z)$  and  $R(x,y)$ , we take their composition [Zadeh 1973]:

$R(z) = R(x,y) \circ R(x,y,z)$

$= \text{Sup}_{x,y} \text{Min}(\mu(x,y), \mu(x,y,z))$

$$= \{1/0 + 1/0.1 + 0.95/0.2 + 0.55/0.3 + 0.25/0.4 + 0.25/0.5 + 0.25/0.6 + 0.25/0.7 + 0.25/0.8 + 0.25/0.9\}$$

Here the membership values for the new relation  $R(z)$  are determined by  $\text{Sup}_{x,y} \text{Min}(\mu(x,y), \mu(x,y,z))$  which reads the supremum over the domains  $x$  and  $y$  of the minimum of the membership values  $\mu(x,y)$  and  $\mu(x,y,z)$ , and is no more than the matrix product between  $\mu(x,y)/(x,y)$  and  $\mu(x,y,z)/(x,y,z)$  but where the addition and multiplication have been replaced by maximum and minimum operations [Zadeh 1973].

Each deduction  $R_1(z)$ ,  $R_2(z)$ ,  $R_3(z)$  and  $R_4(z)$  corresponding to the inference from each rule above can be combined to give a single deduction  $R(z)$  using the operators  $\wedge$  or  $\vee$ . Which operator to use is dependent on the implication used (of which there are many). For the  $L_\infty$  implication, each operator is combined with the  $\wedge$  operator.

$R(z) = R_1(z) \wedge R_2(z) \wedge R_3(z) \wedge R_4(z)$

$$= \{0.75/0 + 0.75/0.1 + 0.75/0.2 + 0.55/0.3 + 0.25/0.4 + 0.25/0.5 + 0.25/0.6 + 0.25/0.7 + 0.25/0.8 + 0.25/0.9\}$$

**Stage 4.** Finally, a linguistic approximation to the deduction can be calculated using primary sets *regular*, *moderate* and *irregular* and hedges *extremely*, *very*, *somewhat*, and *more or less* and using the measure of similarity between two sets  $A(x)$  and  $B(x)$ :  $\Sigma \min(A(x), B(x)) / \Sigma \max(A(x), B(x))$ . This gives *somewhat moderate* and *more-or-less regular* as equal approximations to the deduction above.

## DIFFERENT METHODS OF INFERENCE

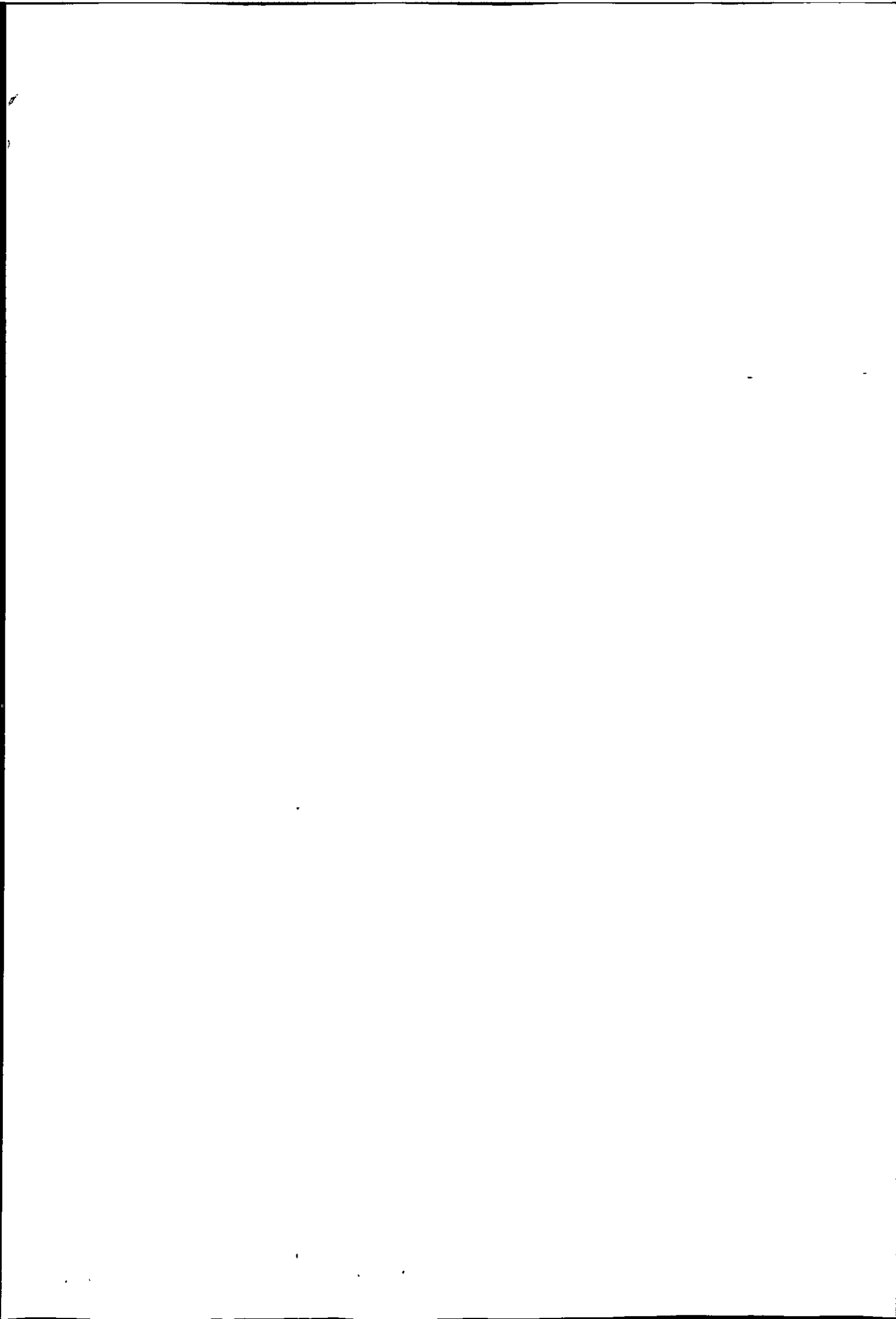
The compositional rule of inference described above is probably the most widely used method for fuzzy inference. It is not the only method devised however. Another method for fuzzy inference is truth functional modification [Baldwin and Guild 1980]. This method operates directly in the fuzzy logic domain. Given the truth of the compatibility between fact and rule, the truth of the deduction is determined and given this truth value, the deduction is modified appropriately. In systems surveyed by [Whalen and Schott 1985], nearly all selected the compositional rule of inference for its simplicity of operating directly with the propositions and not via fuzzy truth values. The greater variation among different methods of fuzzy inference is not with the algorithm used but the definition of the multi-valued logic operators on which these methods are based i.e. conjunction  $\wedge$ , disjunction  $\vee$ , negation  $\neg$  and implication  $\rightarrow$ . Different logics exist to handle the different kinds of uncertainty. Many however, are based on general mathematical constructors called t-norms and t-conorms. A t-norm is defined as a mapping  $*$  from domains  $[0, 1] \times [0, 1]$  to  $[0, 1]$  i.e.  $x*y = z$ , such that: it is non-decreasing in each argument i.e. if  $a \leq b$  and  $c \leq d$ , then  $a*c \leq b*d$ ; it is commutative i.e.  $a*(b*c) = (a*b)*c$ ; it is associative i.e.  $a*b = b*a$  and it satisfies the boundary condition  $1*a = a$ . The t-conorm is defined by replacing  $\leq$  for  $\geq$  and 0 for 1. Restricting the conjunction operation to a t-norm and the disjunction operation to a t-conorm gives many possible definitions for conjunction and disjunction. Likewise, defining the implication operation  $\rightarrow$  as  $\neg a \vee b$  or  $\neg a \vee (a \wedge b)$  gives many possible definitions for 'implies' [Dubois and Prade 84]. Table 2 lists some of them.

$a \wedge b$	$a \vee b$	$a \rightarrow b = \neg a \vee b$	$a \rightarrow b = \neg a \vee (a \wedge b)$
$\min(a, b)$	$\max(a, b)$	$\max(1-a, b)$	$\max(1-a, \min(a, b))$
$a.b$	$a+b-a.b$	$1-a+a^2.b$	$b+(1-a).(1-b)^2$
$\max(0, a+b-1)$	$\min(1, a+b)$	$\min(1, 1-a+b)$	$\max(1-a, b)$
a if b=1 b if a=1 0 otherwise	a if b=0 b if a=0 1 otherwise	1-a if b=0 b if a=1 1 otherwise	1-a if b $\neq$ 1 and a $\neq$ 1 b if a=1 1 otherwise

Table 2. Different possible definitions for conjunction, disjunction and implication based on t-norms and co-norms.

Variation among methods of fuzzy inference is not with the definition of the operators conjunction and disjunction, which are usually defined as  $\min(a, b)$  and  $\max(a, b)$ , but with the implication definition. [Whalen and Schott 1985] surveys fuzzy systems which use 11 definitions for the implication operator.

In the next section, a fuzzy system will be developed according to the 4 stages described above to interpret the EEG for evidence of Alzheimer's disease. To validate the ability of





the system to differentiate between a normal and Alzheimer's EEG, ROC analysis was performed. This was carried out for the 11 different implication operators surveyed in [Whalen and Schott 1985] to compare their performance.

## INTELLIGENT DIAGNOSIS

The system assesses 4 features which were extracted from the EEG: dominant occipital rhythm frequency, amount and reactivity to eye opening and the amount of slow activity. The relationship between these features and classifying the EEG as normal or Alzheimer's is documented in [Visser 1991] and was described using 22 rules. Table 3 shows 2 of them.

<p>Rule 9:          IF dominant occipital rhythm amount is not small          AND dominant occipital rhythm change on eye opening does not change          AND dominant occipital rhythm frequency is very slow alpha          AND the amount of slow activity is above small          THEN EEG is probably in keeping with Alzheimer's disease</p>	<p>Rule 16:          IF dominant occipital rhythm amount is not small          AND dominant occipital rhythm change on eye opening largely attenuates          AND dominant occipital rhythm frequency is alpha          AND the amount of slow activity is below moderate          THEN EEG is probably in keeping with a normal adult</p>
---	---

Table 3. Two rules used to classify the abnormality of the EEG.

To model the relationship between each rule premise and conclusion and between the facts, fuzzy sets were defined (e.g. Figure 1), and fuzzy relations constructed as described above in **Stage 2**. To investigate the different definitions for multi-valued logic implication (the formula used to model the relationship between the premises and conclusion of a rule), 11 different definitions were selected and are shown in Table 5.

The compositional rule of inference was then applied to infer abnormality from each rule and each deduction combined using the appropriate  $\wedge$  or  $\vee$  operator. Finally, a linguistic approximation to the deduction was calculated using primary sets: *probably normal*, *possibly normal*, *equivocal*, *possibly Alzheimer's* and *probably Alzheimer's* and hedges *extremely*, *very*, *somewhat*, and *more or less* using the measure of similarity between two sets  $A(x)$  and  $B(x)$ :  $\sum \min(A(x), B(x)) / \sum \max(A(x), B(x))$ . This gives the interpretation: *more or less normal* for the deduction shown in Figure 1, which was calculated using the Mamdani operator.

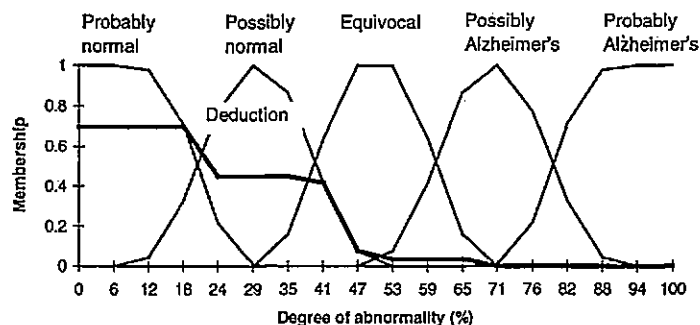
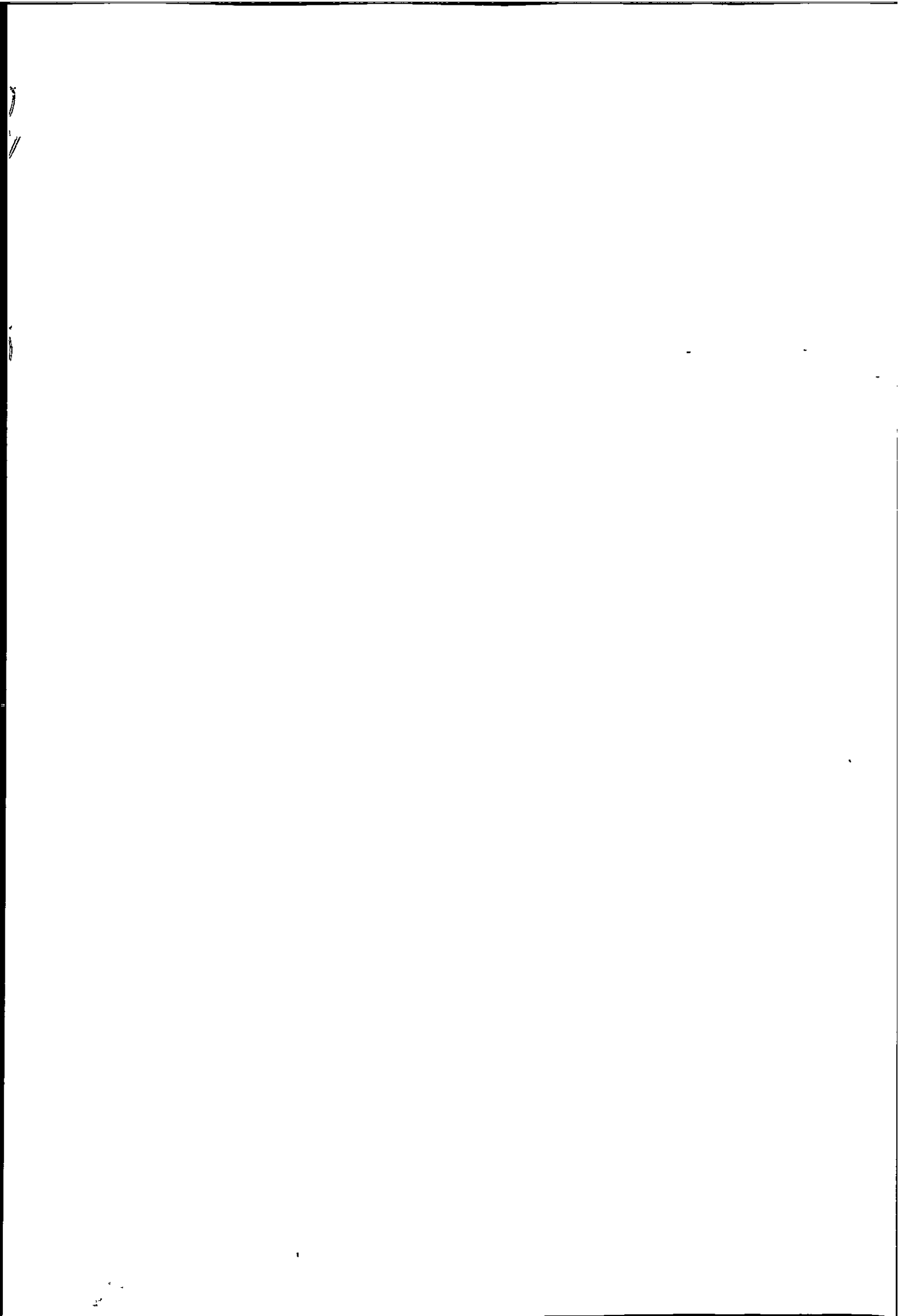


Figure 1. Fuzzy sets defined for abnormality, and calculated using compositional rule of inference.

## SELECTING THE GOLD STANDARD



An important aspect to the development of a diagnostic or detection technique is the accuracy of the data used for validation. There are many techniques possible to determine whether data is Alzheimer's or not, each with different degrees of accuracy and practicality. The technique which is selected to validate is called the *gold standard*. For the study, EEGs from 7 normal age-matched controls and 3 patients with provisional diagnosis of Alzheimer's disease plus supported diagnosis by Neurophysiologists were used.

## VALIDATION USING ROC ANALYSIS

To assess the accuracy of a diagnostic technique 4 parameters are often used. Events to be detected (in this case Alzheimer's disease) are called *positive*, and events which are not positive (in this case normal controls) are called *negative*. Then the number of correctly identified positives is called *true positives*, the number of incorrectly identified positives is called *false positives*, and likewise for the negatives. These parameters are often displayed in the format of a table called a *confusion matrix*. As can be seen in Table 4, a threshold must exist within the technique to trade off true positives (hits) and false positives (false alarms), an increase in the hit rate leads to an increase in the false alarm rate (unless 100% discrimination is possible). This trade-off is variable among clinicians and depends largely on the benefits of having a large hit rate and the costs of having a large false alarm rate. For example, a high hit rate i.e. a low miss rate is desirable in situations where high cost is associated with a miss such as with life threatening diagnosis, whilst a low false alarm rate is desirable where high cost is associated with a false alarm such as with life threatening surgery.

		Gold standard	
		Positive event	Negative event
Technique under assessment	Positive event	True positives	False positives
	Negative event	False negatives	True negatives

Table 4. Confusion matrix for assessing the accuracy of a technique.

ROC analysis validates accuracy independent of hit and false alarm bias by plotting accuracy over different hit / false alarm thresholds [Swets 88]. The area under the ROC curve gives a reliable, single measure of accuracy of any technique that classifies events as either positive or negative e.g. positive or negative diagnosis using blood tests, or signal or noise classification using neural networks. The measure can then be used to assess different techniques which perform the same classification task. To perform ROC analysis, the following are required from the technique: actual positive and negative classifications as determined by the gold standard (e.g. diagnosis by post-mortem), positive and negative classifications by the technique under investigation, and adjustment of the hit / false alarm trade-off. To adjust the hit / false alarm trade-off, many automated techniques will have an adjustable threshold setting. When the technique is manual e.g. performed by a clinician, the hit / false alarm trade-off can be varied by asking them to classify into usually 5 categories: probably positive, possibly positive, equivocal, possibly negative, probably negative.

To assess the accuracy of the above technique, ROC analysis was performed using the 3 Alzheimer's and 7 normal controls. A plot of false alarm by hit rate gives the ROC curve in Figure 2.

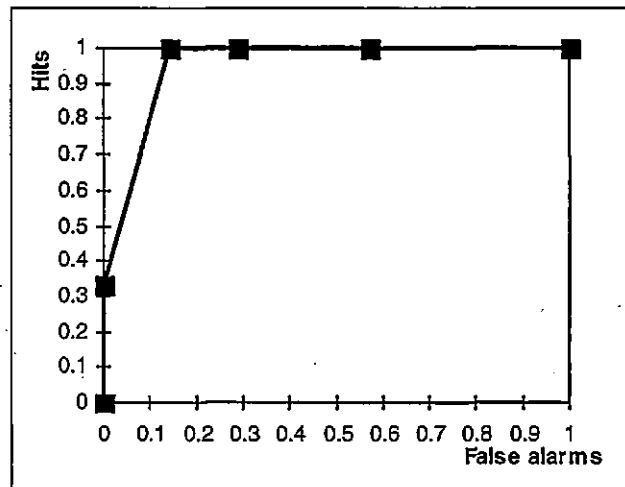


Figure 2. ROC curve showing hit / false alarm accuracy for different hit / false alarm thresholds.

To represent this curve by a single number, the area is often quoted which ranges from 0.5 (no discrimination) to 1 (100% discrimination). Table 5 shows ROC scores for each of the implication operators used in the investigation.

#	$a \rightarrow b$ name	$a \rightarrow b$ definition	Combination operator	Area under ROC curve
1	Lukasiewicz	1 if $b \geq a$ , $\min(1, 1-a+b)$ if $b < a$	min	0.917
2	Brouwer / Godel	1 if $b \geq a$ , b otherwise	min	0.905
3	Kleene / Diens	$\max(1-a, b)$	min	1
4	Mamdani	$\min(a, b)$	max	1
5	Sharp	1 if $a < 1$ or $b = 1$ , 0 otherwise	min	0.667
6	S	1 if $a \leq b$ , 0 otherwise	min	0.809
7	Quotient	1 if $a = 0$ , $\min(1, b/a)$ otherwise	min	0.905
8	Augmented Quotient	1 if $a = 0$ or $b = 1$ $\min(\min(1, b/a), (1-a)/(1-b))$ otherwise	min	0.905
9	Zadeh	$\max(\min(a,b), 1-a)$	min	0.952
10	Product	$\min(1, 1-a+a.b)$	min	1
11	Willmott	$\max(\min(a,b), \min(1-a,1-b), \min(1-a, b))$	min	0.809

Table 5. Operators used in the investigation with their corresponding ROC score.

## CONCLUSIONS

Reasoning with fuzzy logic is at present still largely unestablished, particularly for *linguistic* decision support systems and, for a given knowledge base and fact list, an almost unlimited number of deductions is possible, depending on the method of inference and linguistic approximation technique that is used. Much of the variation stems from the definitions for the conjunction and disjunction operators - on which much of the rules of inference such as compositional rule of inference is based and on the implication operator whose definition is extremely loose. To assess the performance of 11 different implication operators which have been used in previous published work, a given knowledge base, fact list, inference procedure and linguistic approximation procedure, together with each of the different implication operators provided 11 different techniques for classifying the abnormality of the EEG. Given 3 Alzheimer and 7 age-matched control EEGs, the performance of each technique was assessed using ROC analysis. 3 operators: *Kleen-Diens*, *Mamdani* and *Product* out performed the remainder: *Lukasiewicz*, *Brouwer-Godel*, *S#*, *S*, *Quotient*, *Augmented Quotient*, *Zadeh* and *Willmott*. ROC analysis assesses the performance of a technique independent of the desired hit rate and false alarm rate (which often conflict). Two issues however need to be considered with this technique. ROC analysis provides an assessment only by the domain represented by the data, in this case the 7 normals and 3 abnormals. For ROC analysis to be robust, a data set is necessary which covers the entire domain. Secondly, ROC analysis deals with positive events (abnormals) and negative events (normals) only. EEG interpretation however deals with more than a single abnormal class (unlike techniques used to screen for a single abnormality such as breast cancer) and the possibility of a *novelty* occurring must be a consideration of the system.

## ACKNOWLEDGEMENTS

We would like to thank the EPSRC for their financial support, each volunteer for providing the normal control EEG data and Dr Sunil Wimalaratna and the EEG technicians for their help and assistance.

## REFERENCES

- Baldwin J F and Guild N C F. (1980) Feasible algorithms for approximate reasoning using fuzzy logic. *Fuzzy Sets and Systems*, Vol. 3, pp. 225-251.
- Dubois D and Prade H. (1984) Fuzzy logics and the generalized modus ponens revisited. *Cybernetics and Systems*, Vol. 15, pp. 293-331.
- Klir G J and Folger T A. (1988) Fuzzy sets, uncertainty, and information. Prentice Hall.
- Swets J. (1988) Measuring the accuracy of diagnostic systems. *Science*, Vol. 240, pp.1285-1293.
- Whalen T and Schott B. (1985) Alternative logics for approximate reasoning in expert systems: a comparative study. *Int. J. Man-Machine Studies*, Vol. 22, pp. 327-346.
- Visser S L. (1991) The electroencephalogram and evoked potentials in normal and ageing dementia. *Event-Related Brain Research* (EEG Suppl. 42), pp. 289-303
- Zadeh L A (1973) Outline of a new approach to the analysis of complex systems and decision processes. *IEEE Trans. on Systems, Man and Cybernetics*, Vol. SMC-3, pp. 28-44.
- Proc. of the 2<sup>nd</sup> Int. Conf. on Neural Networks and Expert Systems in Medicine and Healthcare*, University of Plymouth, Plymouth. pp. 104-111.

## INTELLIGENT ENHANCEMENT AND INTERPRETATION OF EEG SIGNALS

Riddington E P<sup>1</sup>, Wu J<sup>1</sup>, Ifeachor E C<sup>1</sup>, Allen E M<sup>2</sup> and Hudson N R<sup>2</sup>.

### Introduction

The electroencephalogram (EEG), the recording of electrical activity of the brain, is used in many hospitals world-wide for the analysis and diagnosis various normal and diseased states of the brain such as sleep, dementia and epilepsy. Typically it is recorded for 15 - 60 minutes from 21 locations on the scalp. A report is then written describing the relevant features of the EEG, and finally an interpretation is made in the light of the clinical problem. Activity in the EEG can be classified as either background or transient. Background activity is on-going and rhythmic and is usually classified by frequency into the bands: delta (0 - 4Hz), theta (4 - 8Hz), alpha (8 - 13Hz) and beta (> 13Hz). Transient activity is short duration and is usually described in terms of waveform e.g. spikewave, sharpwave, spike and wave [Chatrian *et al* 74]. Figure 1 shows 4 seconds of EEG and the electrode positions from where each EEG channel was recorded. An alpha rhythm is clearly discernible, particularly at the back of the head. This rhythm is characteristic of the normal adult.

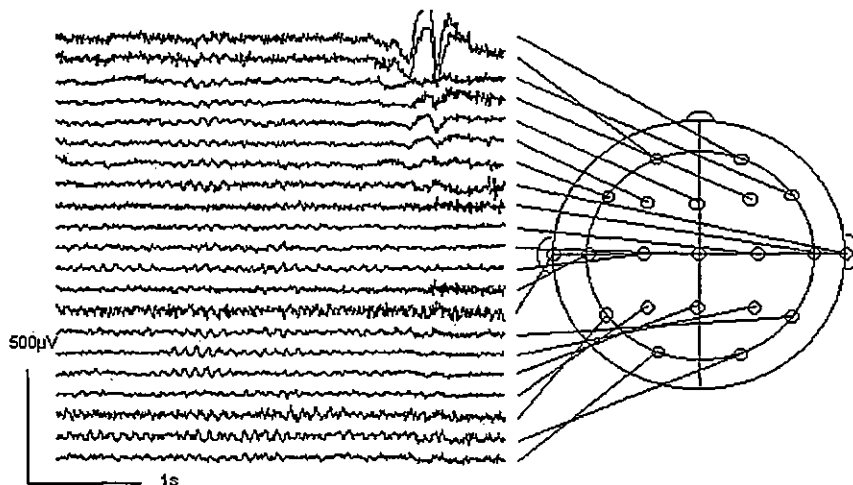


Figure 1. The normal EEG

To interpret the EEG, features such as the frequency and amplitude need to be analysed both in time and spatially on the scalp. This makes EEG interpretation complex and subjective which can be time consuming and laborious, especially when carried out on the routine 15 - 60 minute recording. Interpretations thus differ, particularly between clinicians leading to variable and sometimes erroneous assessments [Kiloh *et al* 81]. The need to automate the interpretation of the EEG to provide a more efficient and reliable assessment is widely recognised [Barlow 79, Ktonas 83], but is complicated by two factors: the presence of artefacts which contaminate the EEG, making interpretation difficult, and the capture of subjective expertise which is ill-suited to conventional methods

<sup>1</sup> School of Electronic, Communication and Electrical Engineering, University of Plymouth, UK.

<sup>2</sup> Dept. of Clinical Neurophysiology, Derriford Hospital, Plymouth, U.K.

of artificial intelligence. This paper brings together work carried out in both these areas [Ifeachor *et al* 90, Riddington *et al* 94, Wu *et al* 94] for the purpose of developing a decision support system for EEG staff to ensure accurate interpretation of the EEG and provide some relief to the clinical work load. In particular, the system will be required to highlight subtle abnormalities, enhance corrupt waveforms, provide a more objective interpretation and perform menial tasks such as estimating amplitudes, frequency, amount and asymmetry.

### Automatic interpretation

Examples of the subjective nature of EEG interpretation can be seen in many EEG publications e.g. Table 1. [Visser 91].

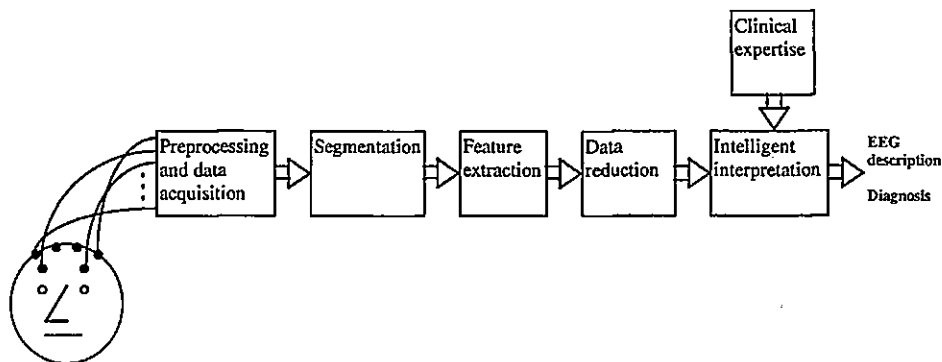
<p>In normal adults the alpha rhythm is <i>usually rather</i> abundant          12% of normal young adults have a <i>slight excess</i> of fast activity          24% of normal adults over 70 have a <i>slight excess</i> of fast activity          In old age the reactivity of the alpha rhythm <i>slightly</i> diminishes          In normal subjects, focal abnormalities <i>rarely</i> exceed 25% of the EEG recording</p>
---

**Table 1. Examples showing the subjective nature of EEG interpretation.**

To model expertise three techniques might be considered: neural networks, expert systems and fuzzy logic. Neural networks encode expertise through training. They do not need expertise to be explicitly expressed, and are therefore suited to applications where the elicitation of expertise is not possible. If the expertise can be expressed explicitly, then expert systems may be a preferable alternative to neural networks. Expert systems encode expertise in the form of rules elicited from the expert. Unlike neural networks, whose expertise is distributed across the network in the form of weights the expertise in an expert system is *transparent* which provides important validation and explanation advantages. Conventional expert systems produce a discontinuous output, switching from one deduction to another, when the input crosses rule boundaries. Fuzzy logic overcomes this problem by producing a continuous output when the input moves between rules. Fuzzy logic can provide a better approximation to expertise expressed qualitatively, whilst maintaining transparency.

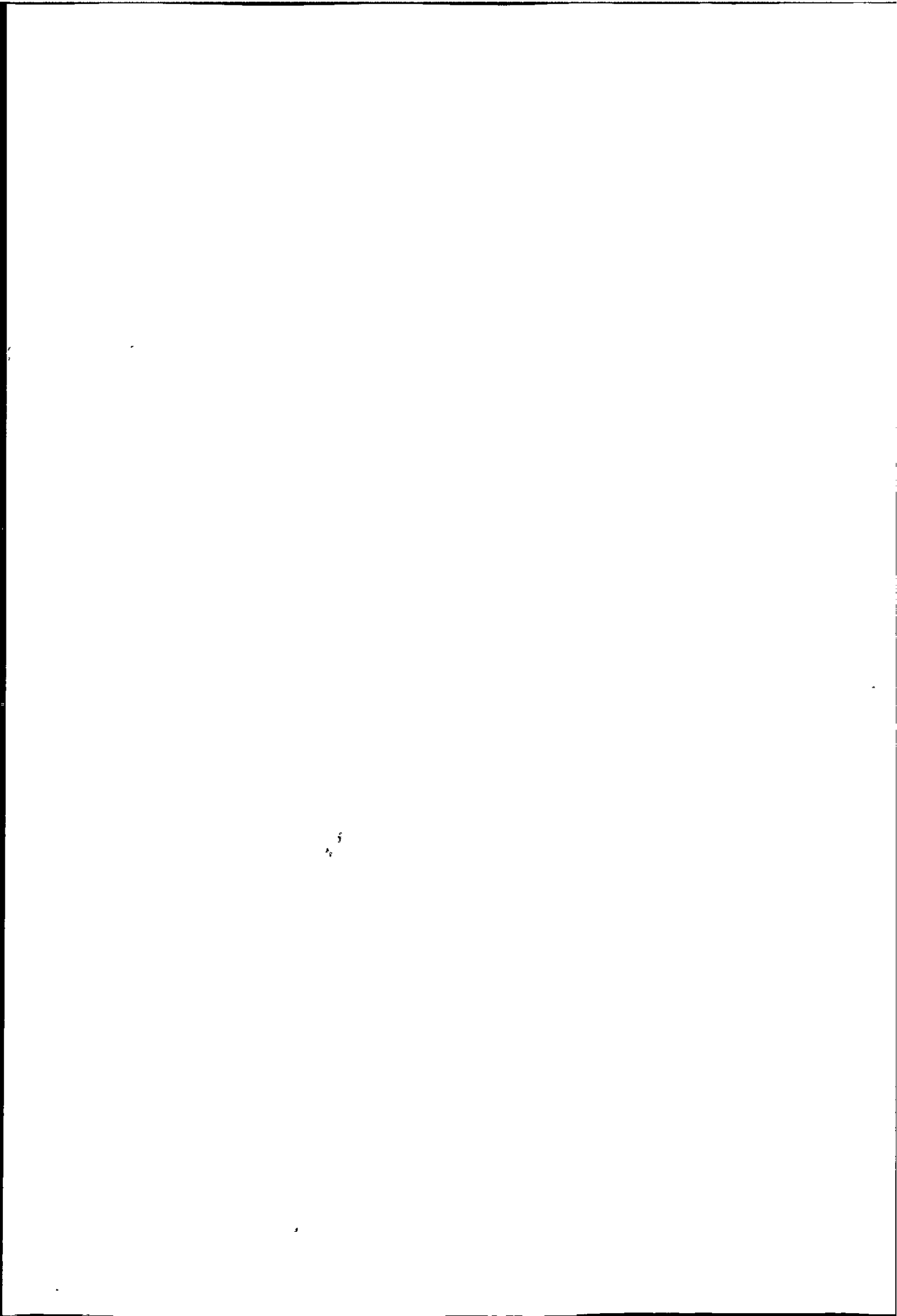
### System design

A breakdown of the technique developed for automatic interpretation is given in Figure 2.



**Figure 2. Technique developed for automatic EEG interpretation**

Electroencephalographic voltage signals are measured from 21 electrodes attached to the scalp. These analogue signals are then preprocessed and digitised ready for computer analysis. Next, feature extraction identifies from





the data features which are clinically significant, and, after removing redundant information, produces an EEG description which efficiently characterises the entire EEG record. Finally, intelligent interpretation will determine which condition the EEG record is in keeping with, normal, Alzheimer's or equivocal.

### Feature extraction

To characterise each activity in each channel in each 4 second segment, 6 basic features were extracted. Features *frequency*, *power*, *amount* and *frequency organisation* were taken directly from the frequency domain, frequency being the frequency of the PSD peak maximum, power being the area of the PSD peak, amount being the power as a percentage of the whole PSD power and frequency organisation being the width of the PSD peak (Figure 3). Features *amplitude* and *amplitude organisation* were taken from the time domain by isolating the activity in time using an FIR filter whose passband was defined by the PSD peak beginning and end (Figure 4).

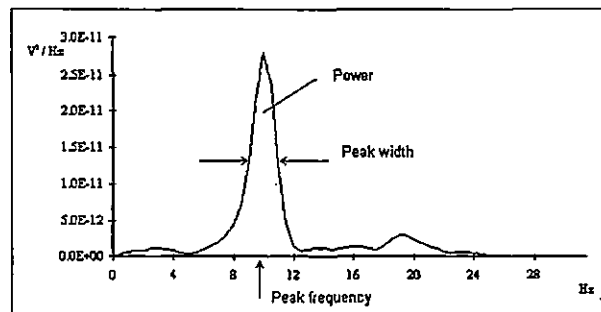


Figure 3. Frequency domain features using power spectral density estimation.

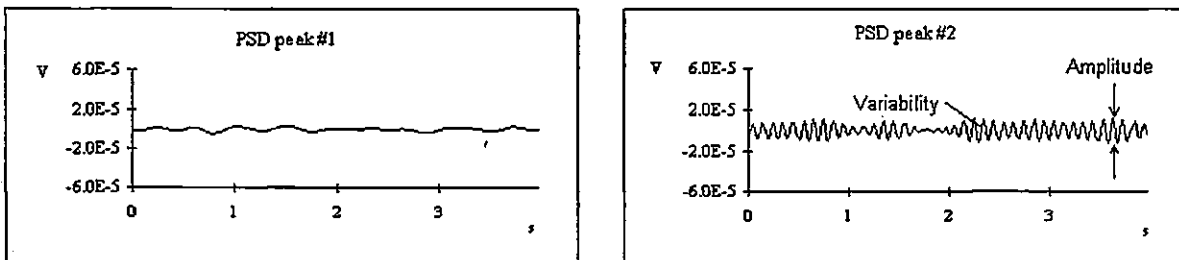


Figure 4. Time domain features using frequency band filtering.

### Data reduction

PSD peak detection is a highly sensitive method for identifying activity in the EEG, typically identifying around 100 activities in a 4 second epoch. Many of the activities however are of the same origin, in fact, the clinician rarely identifies more than 10 activities in the entire EEG record. Because background activity is usually classified according to frequency, activities having the same frequency both spatially across the scalp, and in time, across the epochs, were clustered using the leader cluster algorithm [Hartigan 75]. This procedure usually produces about 9 - 15 clusters. Table 2 shows an example of two clusters and their associated features.



Name: <b>delta</b>	Name: <b>dominant-slow</b>
Amount: moderate	Amount: moderate
Organisation: regular	Organisation: regular
Frequency (Hz): 2.0	Frequency (Hz): 9.5
Amplitude ( $\mu$ V): 22.000	Amplitude ( $\mu$ V): 61.000
Location: left-anterior	Location: diffuse-more-on-the-right
Symmetry: asymmetrical	Symmetry: symmetrical
Change on eye opening: increases	Change on eye opening: attenuates
Amount symmetry (ratio): 1.0:0.4	Amount symmetry (ratio): 0.9:1.0
Frequency symmetry (Hz): 1.9:2.3	Frequency symmetry (Hz): 9.5:9.5
Average power: 4.089e-13	Average power: 1.550e-11
Change of power on eye opening (factor): 2.1	Change of power on eye opening (factor): 0.3
Change of frequency on eye opening (Hz): 0.0	Change of frequency on eye opening (Hz): 0.1

**Table 2. Two clusters with associated features.**

### Intelligent diagnosis

The development of a fuzzy system to model imprecise expertise is typically carried out in 4 stages:

- *define rules*
- *define fuzzy sets* for each rule and fact
- *perform compositional rule of inference* to calculate the deduction
- *utilise deduction* e.g. for a crisp output perform defuzzification, for a linguistic output perform linguistic approximation or for forward chaining assert as a new fact

To interpret the EEG for evidence of Alzheimer's disease, a fuzzy system was developed using the stages described above. The system assesses 4 features which were extracted from the EEG: dominant occipital rhythm frequency, amount and change on eye opening and the amount of slow activity. The relationship between these features and classifying the EEG as: normal or Alzheimer's is documented in [Visser 91] and was described using 22 rules. Table 3 shows 2 of them.

<b>Rule 9:</b> If dominant occipital rhythm amount is not small and dominant occipital rhythm does not change on eye opening and dominant occipital rhythm frequency is very slow alpha and the amount of slow activity is above small then EEG is probably in keeping with Alzheimer's disease	<b>Rule 16:</b> If dominant occipital rhythm amount is not small and dominant occipital rhythm largely attenuates on eye opening and dominant occipital rhythm frequency is alpha and the amount of slow activity is below moderate then EEG is probably in keeping with a normal adult
---	---

**Table 3. Two rules used to classify the abnormality of the EEG.**

Each fuzzy proposition was then defined (e.g. Figure 5), and from these, rule models constructed using the Mamdani implication. The deduction was then calculated using the compositional rule of inference [Mamdani and Sembi 80]. A typical example of the deduction is also shown in Figure 5. Finally, a linguistic approximation to the deduction was calculated using primary sets: *probably normal*, *possibly normal*, *equivocal*, *possibly Alzheimer's* and *probably Alzheimer's* and hedges *extremely*, *very*, *somewhat*, and *more or less* using the measure of similarity between two sets  $A(x)$  and  $B(x)$ :  $\sum \min(A(x), B(x)) / \sum \max(A(x), B(x))$ . This gives the interpretation: *more or less normal* for the deduction shown.

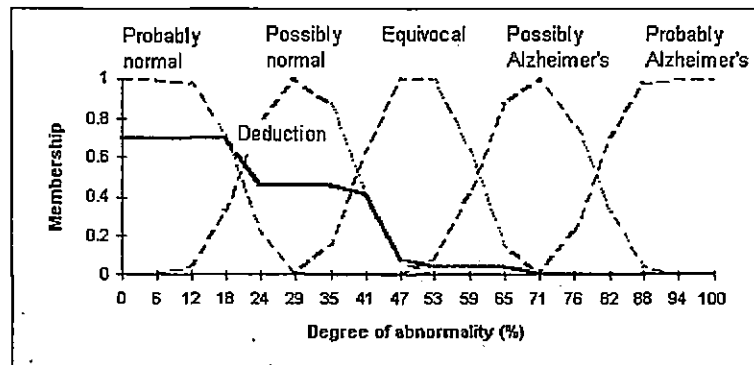


Figure 5. Fuzzy sets defined for abnormality, and calculated using compositional rule of inference.

### Artefact Processing

The presence of artefacts could severely affect the visual examination of EEG signals. For an automated EEG interpretation system, it is essential to have an artefact processing block which serves as a front-end to ensure any interpretation made by the system is based on the non-contaminated data.

Generally speaking, artefact processing can be divided into two stages: artefact identification and artefact removal/rejection. The identification involves artefact detection - to detect the existence of artefacts in EEG, and artefact classification - to recognise the type of artefacts being detected. On the other hand, artefact removal/rejection is to remove the contamination caused by artefacts from EEG signals without losing important clinical information or to reject the signal if no appropriate removal procedure can be found. For an automated EEG interpretation system, artefact identification is often more important. Once an EEG section is labelled by the artefact, the interpretation system can decide whether to include this section in its analysis, to removal it from the analysis, or simply reject it.

The main techniques used in the artefact processing system are neural networks (NN) and expert system (ES). NN provides the classifier design and ES incorporates the expert knowledge into the system. The advantage of combining these two techniques together is to increase the successful rate of identification. If the NN classifiers fail to give a clear-cut decision, then it is possible to use the knowledge base to enhance the system performance.

The system structure is shown in Figure 6.

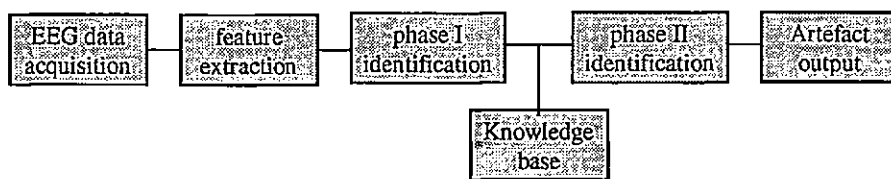


Figure 6. Artefact processing system.

The features used in the NN-based classifiers include both frequency domain and time domain parameters. The detailed description of feature extraction can be found in [Wu *et al* 94]. The phase I identification consists of three different classifiers which are designed to identify blink, eye movement and muscle artefacts respectively. Each classifier is designed using a multilayer feedforward network. The knowledge base includes rules extracted

from medical experts and also some common knowledge of EEG signals such as spatio-temporal relationship between different EEG channels.

Phase II identification takes the output from Phase I identification. If the NN classifier is able to make a clear-cut decision based on numerical parameters, the EEG is labelled with that particular artefact. Otherwise the knowledge base is used to provide more detailed analysis of the signal. At the end of the artefact processing, each channel of EEG is labelled with the corresponding artefact name or as an artefact-free section. These labels can then be used to exclude from the clustering procedure the PSD peaks suspected of artefact contamination (Figure 7).

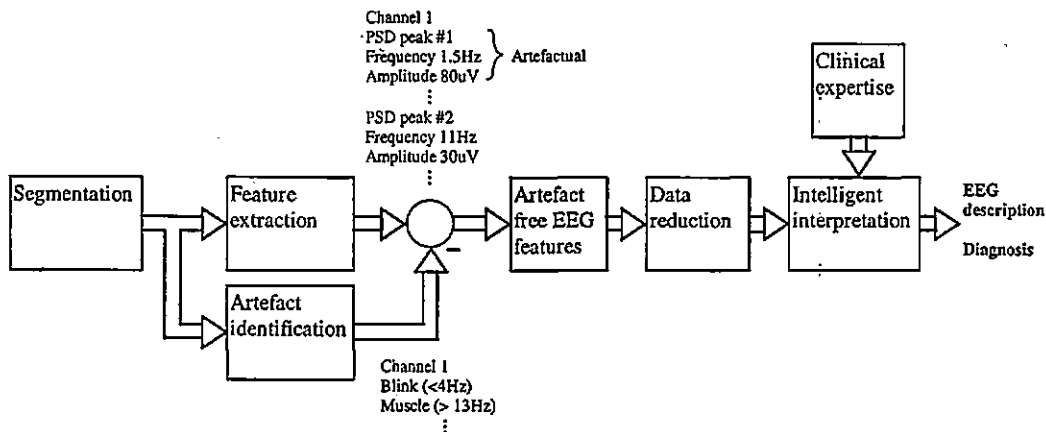


Figure 7. System for intelligent enhancement and interpretation.

## Conclusions

This paper describes the development of a technique which identifies frequency clusters within the EEG and calculates for each cluster the features: amount, organisation, frequency, amplitude, location, symmetry and changes on eye opening.

Previously developed techniques to interpret the EEG represent expertise using conventional knowledge-based systems and algorithms. These systems produce discontinuous outputs, switching from one deduction to another when the inputs cross rule boundaries. The technique described in this paper provides more accurate approximation to the expertise by basing the representation of the knowledge and inference on fuzzy sets and fuzzy logic. In such systems, boundaries need not exist. Only at the final stage, linguistic approximation, do any effects of boundaries have any effect, and these can be minimised by appropriate selection of primary fuzzy sets (*probably normal, possibly normal, equivocal, possibly Alzheimer's, probably Alzheimer's*), hedges (*extremely, very, somewhat, and more or less*), and connectives (such as *and* and *or*, but not used in this case).

Previous techniques neither take into account the effect of artefacts or adequately model the expertise, which is widely recognised as largely subjective. This paper brings together work carried out in both these areas to produce a system which should provide value to the clinical workplace. The system proposed eliminates the bias in the output by omitting from the clustering procedure, frequency peaks which are suspected of having artefact origin by incorporating work from [Wu *et al* 94]. Rather than omitting the PSD peak, further work will correct the effects of artefacts in a PSD peak, particularly if it contains information of cerebral origin by incorporating work from [Ifeachor *et al* 90].

## Acknowledgements

We would like to thank EPSRC for their financial support, each volunteer for providing the normal control EEG data and Dr Sunil Wimalaratna and the EEG technicians for their help and assistance.

## References

- Chatrian G E, Bergamini L, Dondey M, Klass D W, Lennox-Buchthal M and Petersen I. (1974) A glossary of terms most commonly used by clinical electroencephalographers. *Electroenceph. and clin. Neurophys.* **82**, 423-431.
- Kiloh L G, McComas A J, Osselton J W and Upton A R M. (1981) *Clinical electroencephalography*, 4th Ed. Butterworths.
- Barlow J S. (1979) Computerized clinical electroencephalography in perspective. *IEEE Trans. on Biomed. Eng.* **BME-26**, 7, 377-391.
- Ktonas P Y. (1983) Automated analysis of abnormal electroencephalograms. *CRC Critical Reviews in Biomed. Eng.* **9**, 39-97.
- Ifeachor E C, Hellyar M T, Mapps D J and Allen E M. (1990) Knowledge-based enhancement of human EEG signals. *IEE Proc.* **137**, F, 5, 302-310.
- Riddington E P, Ifeachor E C, Allen E M, Hudson N R and Mapps D J. (1994) A fuzzy expert system for EEG interpretation. *Proc. Int. Conf. Neural Networks and Expert Systems in Medicine and Healthcare*, 291-302, University of Plymouth, Plymouth.
- Wu J, Ifeachor E C, Allen E M and Hudson N R. (1994) A neural network based artefact detection system for EEG signal processing. *Proc. Int. Conf. Neural Networks and Expert Systems in Medicine and Healthcare*, 257-266, University of Plymouth, Plymouth.
- Visser S L. (1991) The electroencephalogram and evoked potentials in normal and ageing dementia. *Event-Related Brain Research (EEG Suppl.* **42**).
- Hartigan J A. (1975) *Clustering algorithms*, John Wiley and Sons.
- Mamdani E H and Sembi B S. (1980) Process control using fuzzy logic. In *Fuzzy sets: theory and applications to policy analysis and information systems*. Eds. Wang P P and Chang S K.

## **A FUZZY EXPERT SYSTEM FOR EEG INTERPRETATION**

E. P. Riddington<sup>1</sup>, E. C. Ifeachor<sup>1</sup>, E. M. Allen<sup>2</sup>, N. R. Hudson<sup>2</sup> and D. J. Mapps<sup>1</sup>.

<sup>1</sup> School of Electronic, Communication and Electrical Engineering, University of Plymouth, Plymouth, PL4 8AA, U.K.

<sup>2</sup> Department of Neurophysiology, Derriford Hospital, Plymouth, PL6 8DH, U.K.

### **ABSTRACT**

The purpose of automating the interpretation of the EEG is to assist clinicians in the diagnosis of brain abnormalities and evaluation of treatment. An important problem however, is the lack of precise criteria for interpreting the EEG. This paper describes a system to represent and reason with imprecise criteria using linguistic variables and approximate reasoning. First an introduction to the basic concepts of representing and reasoning with imprecision is given, the paper then presents a fuzzy expert system that interprets the EEG taking imprecision into account. Advantages that the system provides over conventional systems include a more accurate model of the interpretation process used and powerful explanation potential.

### **INTRODUCTION**

The electroencephalogram (EEG), the recording of the electrical activity of the brain, is routinely recorded for between 15 to 60 minutes at 21 locations on the scalp. At present, EEG interpretation is a time consuming process that is carried out in many hospitals worldwide for the analysis and diagnosis of brain abnormalities, such as epilepsy and dementia. The purpose of automating the interpretation of the EEG therefore is to relieve some of the mundane tasks involved and to save valuable time of medical personnel, but this is complicated by several factors. The EEG contains many artefacts such as eye movement and muscle potentials which contaminate the EEG making interpretation more difficult. Processing the EEG to identify and remove the artefacts is vital, but this represents a major problem in its own right [6]. Interpreting the EEG is a complex procedure to emulate because it takes into account the distribution over time and on the scalp of features such as frequency, amplitude and shape of certain waves. This problem has been found to be well

suited to expert systems [7, 1, 5, 4] which are proficient at solving complex real-world problems that are difficult enough to require an expert for their solution. EEG features can often only be described in vague terms [2]. This is because in the normal EEG, features vary widely and as a result there are few precise criteria for assessing abnormality. For example, the theta activity in the EEG is sometimes described as being acceptable in small amounts for the normal awake adult. This kind of imprecision lends itself to linguistic variables and approximate reasoning [13].

The aim of the work on which this paper is based is to develop a fuzzy expert system to automate interpretation of the EEG to assist busy clinicians in the diagnosis of brain abnormalities and evaluation of treatment.

## BASIC CONCEPTS OF FUZZY EXPERT SYSTEMS

In expert systems, knowledge is often represented as rules and facts, where the rules have the format *if antecedent then consequent*, and where antecedents, consequents and facts are propositions. Typically, a proposition consists of a variable and a value. For example in the proposition *theta rhythm duration is less than 5% of the EEG*, *theta rhythm duration* is the variable and *less than 5% of the EEG* is the value. Thus an example of a rule could therefore be *if the theta rhythm amplitude is greater than 15 $\mu$ V and the theta rhythm duration is less than 5% of the EEG then the theta rhythm abnormality is mild*, in this case the antecedent of the rule contains two propositions and the consequent contains one.

To deduce a solution, given rules and facts about a problem, expert systems usually use the Boolean theorem modus ponens and the forward and/or backward chaining procedure. The modus ponens theorem states if facts exist that satisfy the antecedent of a rule then the consequent is satisfied. For example, given the above rule and the facts *theta rhythm amplitude is 60 $\mu$ V* and *theta rhythm duration is 2% of the EEG* the modus ponens would state that *theta rhythm abnormality is mild* is fact. In forward chaining, modus ponens is used to deduce new facts from previous facts to arrive at a desired solution, whilst in backward chaining, modus ponens is used to work back from a desired solution by chaining rule antecedents with rule consequents until facts are found to support the chain [10].

### Representing vague knowledge

One of the limitations of conventional expert systems is that they reason using two-valued logic and as a result propositions must be precisely defined. In EEG interpretation however, knowledge is often vague such as *high* and *mild* in the proposition *if beta rhythm amplitude is high then beta rhythm abnormality is mild*. This imprecision can be represented using linguistic variables and reasoned with using approximate reasoning. Imprecise proposition values are represented as fuzzy subsets which are characterised by membership functions. These membership functions express the degree crisp values such as 50.432 are members of a fuzzy subset. They represent vagueness, by using partial membership to model the uncertainty in the boundary between membership and non-membership. Fig. 1 shows the membership functions for the fuzzy sets *low*, *high* and *very high* for beta rhythm amplitude.

A fuzzy proposition is a proposition whose value is a fuzzy subset e.g. *beta rhythm amplitude is low* is a fuzzy proposition that has as its value the fuzzy subset *low* in fig. 1. When assigning a fuzzy subset to a proposition variable the subset acts as a possibility distribution which specifies how possible a precise value could be assigned to the variable.



Just as conventional propositions are used to represent precise rules and facts in an expert system, fuzzy propositions are used to represent imprecise rules and facts.

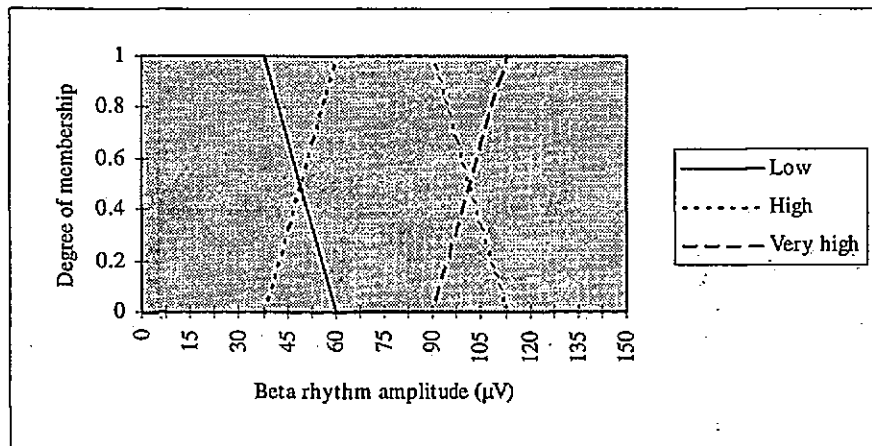


Figure 1. Membership functions for the beta rhythm amplitude values low, high and very high.

### Reasoning with vague knowledge

As with the modus ponens in conventional expert systems, the generalised modus ponens is used to deduce new facts but given rules and facts constructed from fuzzy propositions. Systems that represent and reason with fuzzy propositions are called fuzzy expert systems. To illustrate the reasoning in a fuzzy expert system, consider the simple problem to determine whether the theta rhythm exists in a section of an EEG record using the rules and fact in table 1.

---

Rule 1 : If the theta rhythm amplitude is negligible then the theta rhythm existence is low

Rule 2 : If the theta rhythm amplitude is not negligible then the theta rhythm existence is high

Fact : Theta rhythm amplitude is about  $16\mu\text{V}$

---

Table 1. Example rules and fact

In the rules and fact, the fuzzy subsets *negligible*, *low*, *not negligible*, *high* and *about  $16\mu\text{V}$*  are used. Membership functions for these fuzzy subsets are given in figures 2 and 3. When fuzzy subsets are used as values in fuzzy propositions, they become possibility distributions. Let us denote the symbols  $\pi_{A1}(x)$ ,  $\pi_{C1}(y)$ ,  $\pi_{A2}(x)$ ,  $\pi_{C2}(y)$  and  $\pi_F(x)$  to represent the possibility distributions for the antecedent and consequent of rule 1, antecedent and consequent of rule 2 and the fact, respectively. Definitions for these distributions are given in (1) - (5).

$$\pi_{A1}(x) = [1 \ 1 \ 0.5 \ 0 \ 0 \ 0 \ 0 \ 0 \ 0 \ 0 \ 0 \ 0 \ 0 \ 0 \ 0 \ 0 \ 0 \ 0 \ 0 \ 0 \ 0] \quad (1)$$

$$\pi_{C1}(y) = [1 \ 1 \ 1 \ 1 \ 1 \ 0.9 \ 0.8 \ 0.7 \ 0.6 \ 0.5 \ 0.4 \ 0.3 \ 0.2 \ 0.1 \ 0 \ 0 \ 0 \ 0 \ 0 \ 0 \ 0] \quad (2)$$

$$\pi_{A2}(x) = [0 \ 0 \ 0.5 \ 1 \ 1 \ 1 \ 1 \ 1 \ 1 \ 1 \ 1 \ 1 \ 1 \ 1 \ 1 \ 1 \ 1 \ 1 \ 1 \ 1 \ 1] \quad (3)$$

$$\pi_{C2}(y) = [0 \ 0 \ 0 \ 0 \ 0 \ 0 \ 0.1 \ 0.2 \ 0.3 \ 0.4 \ 0.5 \ 0.6 \ 0.7 \ 0.8 \ 0.9 \ 1 \ 1 \ 1 \ 1 \ 1 \ 1] \quad (4)$$

$$\pi_F(x) = [0.333 \ 0.666 \ 1 \ 0.666 \ 0.333 \ 0 \ 0 \ 0 \ 0 \ 0 \ 0 \ 0 \ 0 \ 0 \ 0 \ 0 \ 0 \ 0 \ 0 \ 0 \ 0] \quad (5)$$

where  $x = 0, 7.5, \dots, 150 \mu V$  and  $y = 0, 5, \dots, 100\%$ .

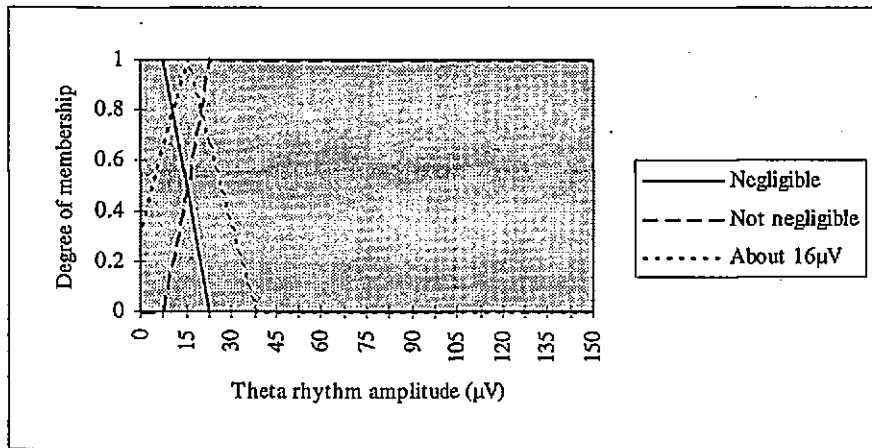


Figure 2. Membership functions for the theta rhythm amplitude values negligible, not negligible and about 16µV.

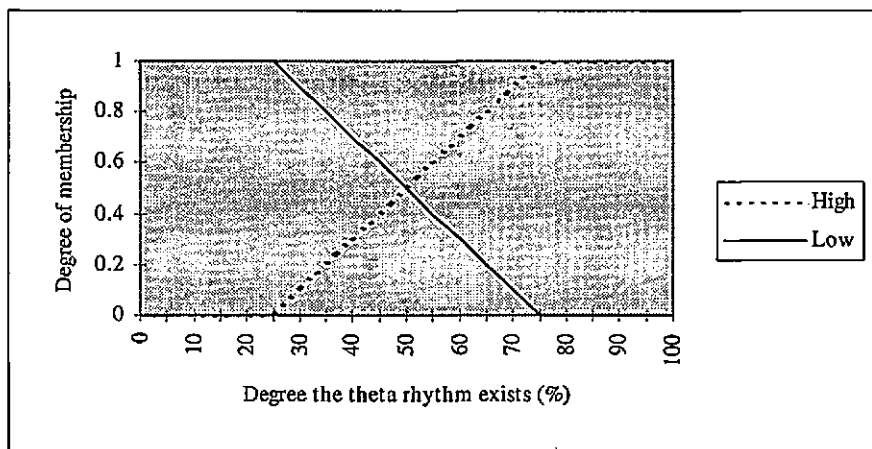


Figure 3. Membership functions for the theta rhythm existence values low and high.

The relationship that is implied in each rule between the antecedent and consequent can be modelled using the implication as shown in (6) for rule 1.

$$\pi_{A1}(x) \Rightarrow \pi_{C1}(y) \quad (6)$$

where  $\Rightarrow$  is the implication operation. From the implication a possibility distribution associated with the rule can be derived. Let us denote  $\pi_{A1,C1}(x,y)$  to represent the possibility distribution of the implication for rule 1.

$$\pi_{A_i, C_i}(x, y) = \text{Min}(1, 1 - \pi_{A_i}(x) + \pi_{C_i}(y)) \quad (7)$$

$$\pi_{A_i, C_i}(x, y) = \begin{bmatrix} 1 & 1 & 1 & 1 & 1 & 1 & 0.9 & 0.8 & 0.7 & 0.6 & 0.5 & 0.4 & 0.3 & 0.2 & 0.1 & 0 & 0 & 0 & 0 & 0 & 0 \\ 1 & 1 & 1 & 1 & 1 & 1 & 0.9 & 0.8 & 0.7 & 0.6 & 0.5 & 0.4 & 0.3 & 0.2 & 0.1 & 0 & 0 & 0 & 0 & 0 & 0 \\ 1 & 1 & 1 & 1 & 1 & 1 & 1 & 1 & 1 & 1 & 1 & 0.9 & 0.8 & 0.7 & 0.6 & 0.5 & 0.5 & 0.5 & 0.5 & 0.5 & 0.5 \\ 1 & 1 \\ & & & & & & & & & & & \vdots & & & & & & & & & \\ 1 & 1 \end{bmatrix} \quad (8)$$

where *Min* is the minimum operation [11, 12]. To deduce new facts from the given facts and rules, the generalised modus ponens operation is performed by composing the possibility distribution of the given fact with the possibility distribution of each given rule. Let us denote  $\pi_{F_1}(y)$  to represent the possibility distribution of the deduced fact from the possibility distribution of the given fact and rule 1.

$$\pi_{F_1}(y) = \pi_F(x) \circ \pi_{A_i, C_i}(x, y) = \text{Max}_x(\pi_F(x) \wedge \pi_{A_i, C_i}(x, y)) \quad (9)$$

$$\pi_{F_1}(y) = [1 \ 1 \ 1 \ 1 \ 1 \ 1 \ 1 \ 1 \ 1 \ 1 \ 0.9 \ 0.8 \ 0.7 \ 0.666 \ 0.666 \ 0.666 \ 0.666 \ 0.666 \ 0.666 \ 0.666 \ 0.666] \quad (10)$$

where  $\circ$  is the composition operation,  $\wedge$  is the intersection operation and  $\text{Max}_x$  is the maximum operation with respect to  $x$  [11, 14]. Repeating steps (7) and (9) for rule 2 gives the possibility distribution of the deduced fact from rule 2. Let us denote  $\pi_{F_2}(y)$  to represent this deduced fact.

$$\pi_{F_2}(y) = [0.666 \ 0.666 \ 0.666 \ 0.666 \ 0.666 \ 0.666 \ 0.666 \ 0.666 \ 0.7 \ 0.8 \ 0.9 \ 1 \ 1 \ 1 \ 1 \ 1 \ 1 \ 1 \ 1 \ 1 \ 1] \quad (11)$$

These facts can be represented as a single possibility distribution that represents the existence of the theta rhythm by their intersection. Let us denote  $\pi_{F_1, F_2}(y)$  to represent the existence of the theta rhythm as a single possibility distribution.

$$\pi_{F_1, F_2}(y) = \pi_{F_1}(y) \wedge \pi_{F_2}(y) \quad (12)$$

$$\pi_{F_1, F_2}(y) = [0.666 \ 0.666 \ 0.666 \ 0.666 \ 0.666 \ 0.666 \ 0.666 \ 0.666 \ 0.7 \ 0.8 \ 0.9 \ 1 \ 0.9 \ 0.8 \ 0.7 \ 0.666 \ 0.666 \ 0.666 \ 0.666 \ 0.666 \ 0.666] \quad (13)$$

This distribution is shown in fig. 4. The only completely possible real value that theta existence can take on is 50%, which is the boundary between low and high, other real values are less possible but not completely impossible.

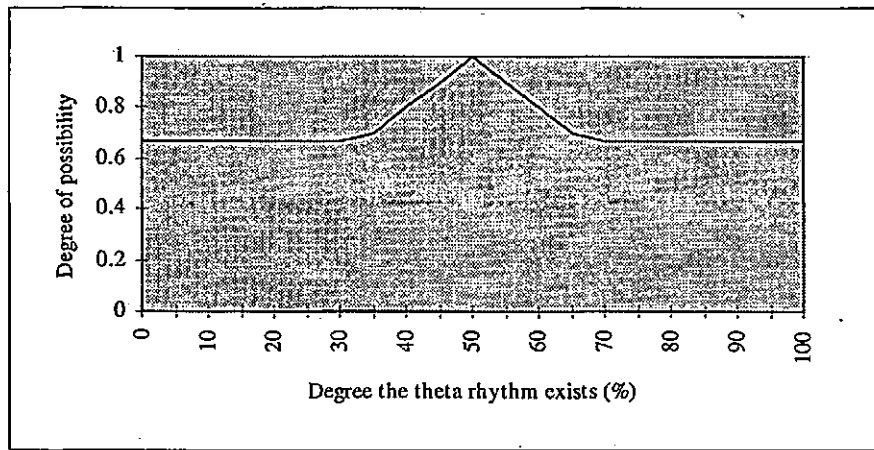


Figure 4. Possibility distribution representing the existence of the theta rhythm.

### Linguistic approximation

The meaning of a possibility distribution can be approximated to the natural language of the human expert by using linguistic approximation. Distributions that represent standard linguistic values are compared to the possibility distribution of a deduced fact and the distribution with the greater measure of similarity is selected as the linguistic approximation. In this paper the measure of similarity used was the Euclidean distance.

$$d_n = \sum_y (\pi(y) - \pi_n(y))^2 \quad (14)$$

where  $n$  is a sequence of standard linguistic subsets e.g.  $n = low, low-high\ boundary, high$ ,  $\pi(y)$  is the possibility distribution of a deduced fact,  $\pi_n(y)$  is the possibility distribution of the standard linguistic subset  $n$ ,  $y$  is the sequence of crisp values representing the base of the possibility distributions e.g.  $y = 0, 5, \dots, 100\%$  and  $d_n$  is the Euclidean distance between the deduced fact and the standard linguistic subset  $n$ . Applying linguistic approximation to the theta rhythm existence  $\pi_{F1,F2}(y)$  using the standard linguistic subsets in (15), (16) and (17) produces the distances,  $d_{low} = 4.816$ ,  $d_{low-high\ boundary} = 2.435$  and  $d_{high} = 4.816$ . The smallest distance represents the nearest approximation, the existence of the theta rhythm therefore approximates to being on the low and high boundary.

$$\pi_{low}(y) = [1 \ 1 \ 1 \ 1 \ 1 \ 1 \ 0.9 \ 0.8 \ 0.7 \ 0.6 \ 0.5 \ 0.4 \ 0.3 \ 0.2 \ 0.1 \ 0 \ 0 \ 0 \ 0 \ 0 \ 0] \quad (15)$$

$$\pi_{low-high\ boundary}(y) = [0 \ 0.1 \ 0.2 \ 0.3 \ 0.4 \ 0.5 \ 0.6 \ 0.7 \ 0.8 \ 0.9 \ 1 \ 0.9 \ 0.8 \ 0.7 \ 0.6 \ 0.5 \ 0.4 \ 0.3 \ 0.2 \ 0.1 \ 0] \quad (16)$$

$$\pi_{high}(y) = [0 \ 0 \ 0 \ 0 \ 0 \ 0 \ 0.1 \ 0.2 \ 0.3 \ 0.4 \ 0.5 \ 0.6 \ 0.7 \ 0.8 \ 0.9 \ 1 \ 1 \ 1 \ 1 \ 1 \ 1] \quad (17)$$

2

## SYSTEM DEVELOPMENT

EEGs were recorded from 5 volunteers aged between 49 and 88 years. Each EEG was taken from 21 electrodes placed at locations Fp1, Fp2, F7, F3, Fz, F4, F8, A1, T3, C3, Cz, C4, T4, A2, T5, P3, Pz, P4, T6, O1 and O2 of the international 10-20 system. Electrodes were referenced to an average of all electrodes except A1, A2, F7, F8, Fp2 and Fp1 for the majority of the recording except for the initial few minutes where a bipolar signal derivation was used. The recording time was approximately 15 minutes.

The 21 channels were each bandlimited to 70 Hz using a 4th order Butterworth low pass filter and then digitised at 256 Hz / channel at 12 bit resolution.

### Quantitative interpretation of the EEG

A quantitative system for interpreting the EEG [9] was developed first, to provide a basis on which to develop the qualitative system. The system extracts and assesses 13 features of the EEG normally assessed in routine work i.e. dominant rhythm existence, organisation, organisation asymmetry, frequency, frequency asymmetry, amplitude, amplitude asymmetry and extension; beta rhythm amplitude and amplitude asymmetry; theta rhythm duration; delta rhythm duration; and non-dominant alpha rhythm duration, using equations based on the power spectral density of the EEG and threshold criteria e.g. (18) was used to extract from the EEG the beta rhythm amplitude and the criteria in table 2 was used to classify its abnormality.

$$\text{beta amplitude} = 6\sqrt{S_\beta} \quad (\mu V) \quad (18)$$

where  $S_\beta$  is the area of the power spectral density in the range 13-32 Hz.

Normal	Mildly abnormal	Moderately abnormal	Markedly abnormal
beta rhythm amplitude $\leq 50\mu V$	$50\mu V < \text{beta rhythm amplitude} < 100\mu V$	$100\mu V \leq \text{beta rhythm amplitude}$	-

Table 2. Threshold criteria for classifying beta rhythm amplitude abnormality

The power spectral density of the EEG was calculated using the modified periodogram method developed by Walsh [8] which allows adjustment of the trade off between noise and resolution and was correctly scaled in terms of power. The system was implemented in the expert system tool CLIPS [3] except the equation calculations which were implemented in C.

### Qualitative interpretation of the EEG

In the quantitative system described above, crisp values were used to represent the features extracted from the EEG and crisp categories were used to classify these features. To realise a more accurate model of the expert, a qualitative system was developed that uses fuzzy values to represent the features extracted from the EEG and fuzzy categories to classify these features.

Threshold criteria were converted back to the qualitative rules they were intended to represent by expressing them as fuzzy rules in the format *if antecedent then consequent*. For example, to extract the duration of the theta rhythm and assess its abnormality for each channel of the EEG, the quantitative system used (19) and the criteria in table 3.

$$\frac{s_{\theta}}{s_r} \cdot 100 \text{ when } 6\sqrt{s_{\theta}} \geq 15e-6 \quad (19)$$

where  $s_{\theta}$  is the area of the power spectral density in the range 4-8 Hz,  $s_r$  is the total area of the power spectral density,  $s_{\theta}/s_r \cdot 100$  measures theta rhythm duration (%),  $6\sqrt{s_{\theta}}$  measures theta rhythm amplitude (V) and  $6\sqrt{s_{\theta}} \geq 15e-6$  is the threshold for measuring the existence of the theta rhythm.

Normal	Mildly abnormal	Moderately abnormal	Markedly abnormal
-	theta rhythm duration < 5%	5% ≤ theta rhythm duration < 50%	50% ≤ theta rhythm duration

Table 3. Criteria for assessing theta rhythm duration abnormality

From the threshold criteria in (19) and table 3 the qualitative rules in table 4 were derived.

---

Rule 1: If the theta rhythm amplitude is not negligible then the theta rhythm existence is high

Rule 2: If the theta rhythm amplitude is negligible then the theta rhythm existence is low

Rule 3: If the theta rhythm existence is low then the theta rhythm abnormality is normal

Rule 4: If the theta rhythm existence is high and the theta rhythm duration is small then the theta rhythm abnormality is mild

Rule 5: If the theta rhythm existence is high and the theta rhythm duration is medium then the theta rhythm abnormality is moderate

Rule 6: If the theta rhythm existence is high and the theta rhythm duration is large then the theta rhythm abnormality is marked

---

Table 4. Qualitative rules derived from threshold criteria in (19) and table 3.

Membership functions for each fuzzy proposition value were created by "fuzzifying" the existing crisp threshold criteria e.g. fig. 5 shows membership functions used to represent theta rhythm amplitude values negligible and not negligible.

The system operates by converting the crisp values calculated by the equations of the quantitative system into fuzzy propositions and asserting them as facts e.g. for the calculated theta rhythm amplitude 21.473μV, the fuzzy proposition *theta rhythm amplitude is about*

22.5 $\mu$ V would be asserted with the membership function given in fig. 5. Possibility distributions representing the abnormality of each feature are deduced from the fuzzy rules and facts using the forward chaining procedure and the generalised modus ponens. Each possibility distribution is then approximated to the standard linguistic subsets  $\pi_{normal}(y)$ ,  $\pi_{mildly\ abnormal}(y)$ ,  $\pi_{moderately\ abnormal}(y)$ ,  $\pi_{markedly\ abnormal}(y)$  and  $\pi_{unknown}(y)$  given in (20), (21), (22), (23) and (24). The system was implemented in CLIPS except the equation calculations, the generalised modus ponens inference and the linguistic approximation which were implemented in C.

$$\pi_{normal}(y) = [1 \ 1 \ 1 \ 1 \ 0.75 \ 0.5 \ 0.25 \ 0 \ 0 \ 0 \ 0 \ 0 \ 0 \ 0 \ 0 \ 0 \ 0 \ 0 \ 0 \ 0 \ 0] \quad (20)$$

$$\pi_{mildly\ abnormal}(y) = [0 \ 0 \ 0 \ 0 \ 0.25 \ 0.5 \ 0.75 \ 1 \ 1 \ 0.75 \ 0.5 \ 0.25 \ 0 \ 0 \ 0 \ 0 \ 0 \ 0 \ 0 \ 0] \quad (21)$$

$$\pi_{moderately\ abnormal}(y) = [0 \ 0 \ 0 \ 0 \ 0 \ 0 \ 0 \ 0 \ 0 \ 0.25 \ 0.5 \ 0.75 \ 1 \ 1 \ 0.75 \ 0.5 \ 0.25 \ 0 \ 0 \ 0 \ 0] \quad (22)$$

$$\pi_{markedly\ abnormal}(y) = [0 \ 0 \ 0 \ 0 \ 0 \ 0 \ 0 \ 0 \ 0 \ 0 \ 0 \ 0 \ 0 \ 0 \ 0.25 \ 0.5 \ 0.75 \ 1 \ 1 \ 1 \ 1] \quad (23)$$

$$\pi_{unknown}(y) = [1 \ 1 \ 1 \ 1 \ 1 \ 1 \ 1 \ 1 \ 1 \ 1 \ 1 \ 1 \ 1 \ 1 \ 1 \ 1 \ 1 \ 1 \ 1 \ 1] \quad (24)$$

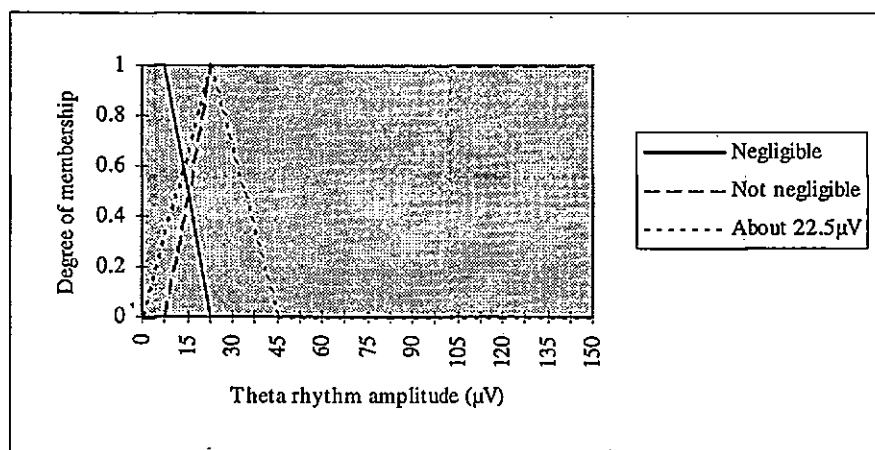


Figure 5. Membership functions for the theta rhythm amplitude values negligible, not negligible and about 22.5 $\mu$ V.

## RESULTS AND DISCUSSION

Quantitative and qualitative interpretation of the EEG segment in fig. 6 is given in table 5. For the quantitative interpretation, crisp measurements representing the extraction of each feature and the crisp classification of the abnormality of each feature is given, for the qualitative interpretation, Euclidean distances between the fuzzy classification of the abnormality of each feature and standard linguistic subsets is given.

For the quantitative system, the interpretation has found the dominant rhythm to exist in the right hemisphere of the brain but not in the left and as a result, features measuring asymmetry of the dominant rhythm have been scored as *markedly abnormal*. Theta rhythm and non-dominant alpha rhythm have been found to occupy 17.1% and 20.7% of the total activity from the channels where they have been found to exist, and have consequently been classified as *moderately abnormal* and *mildly abnormal* respectively. All other features have been found to be within normal limits.

For the qualitative system, the fuzzy classification for almost every feature has been approximated to *unknown*. This is because the rules which have the effect of restricting a



distribution, have been insufficiently satisfied due to over fuzzification of the features and criteria. Reducing fuzzification should, for the incorrectly classified features, increase the Euclidean distance to the subset *unknown* and reduce the distance to the correct classification. The results indicate that, after this adjustment, the fuzzy classification of each feature would be similar to the results of the quantitative system.

The potential advantages that the qualitative interpretation has over the quantitative interpretation are numerous. For example, the degree of classification is reflected in each deduction. This information can be vital when reasoning occurs near category boundaries. Further, information meaningful to medical personnel are used throughout the reasoning process of the system, this information can be approximated to their natural language, thus allowing powerful interfacing potential.

As the trend in EEG recording and assessment is towards computerisation, the system could provide an important role as part of a segment by segment review of the EEG and during the compilation of the summary report for the entire EEG record. Subtle abnormalities that might otherwise be overlooked could be highlighted, questions raised on uncertainties could be answered and a summary report containing both quantitative and qualitative results for the entire record could be produced.

Further work that is necessary, is the inclusion of features to assess theta, delta and non-dominant alpha rhythm asymmetry and location, automatic segmentation of the EEG into different patient states such as awake or drowsy and summarising the interpretation for each patient state.

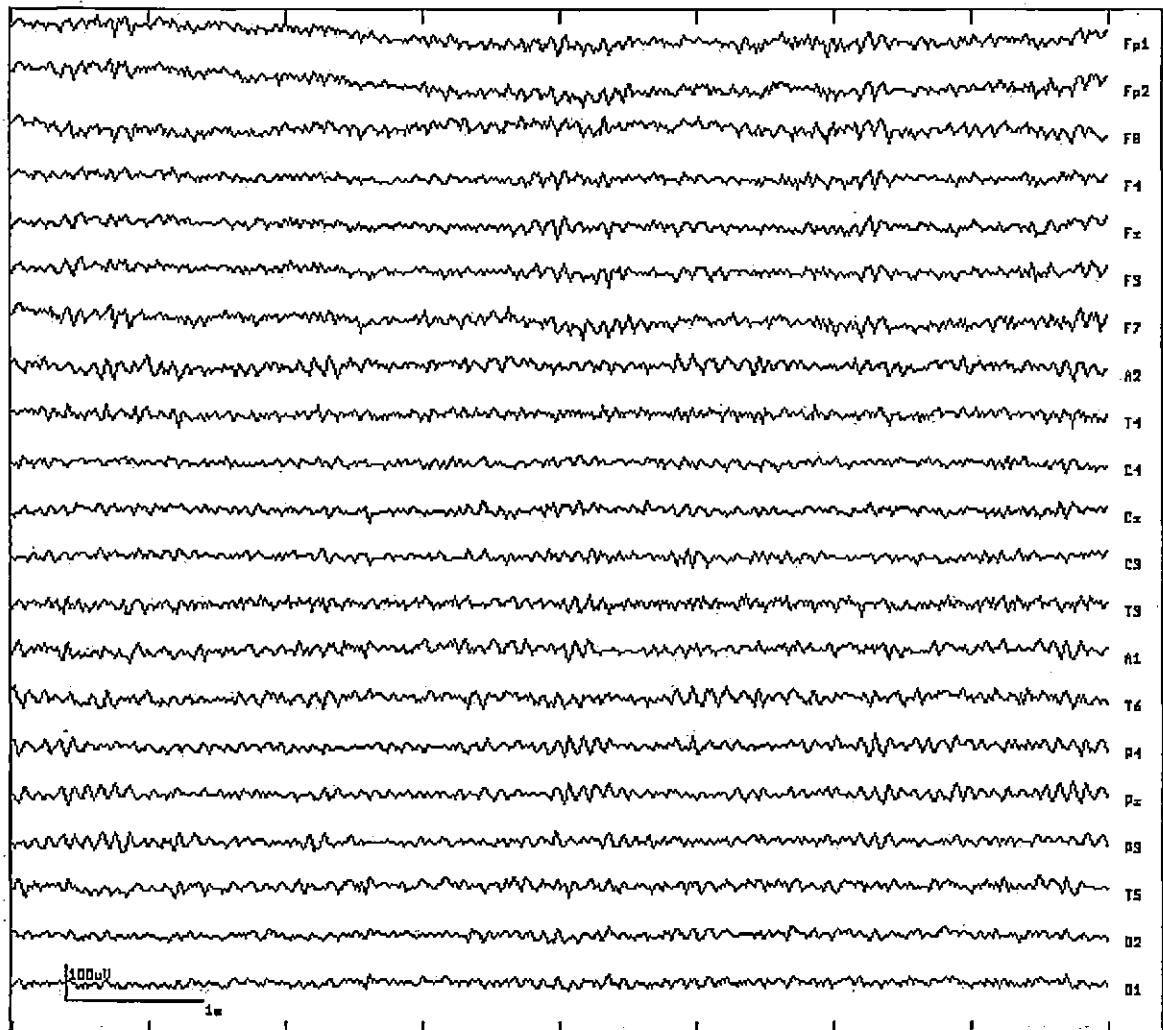


Figure 6. EEG segment used in the analysis.

Feature		Quantitative interpretation		Qualitative interpretation				
		Feature measurement	Feature classification	Normal distance	Mildly abnormal distance	Moderately abnormal distance	Markedly abnormal distance	Unknown distance
Dominant rhythm	Left existence	False	Normal	7.385	8.660	9.110	9.535	1.360
	Right existence	True						
	Left organisation	n/a	n/a	12.215	12.790	13.090	13.315	0.140
	Right organisation	0.4	Normal	7.385	9.560	10.060	10.485	1.310
	Organisation asymmetry (%)	n/a	Markedly abnormal	9.535	9.110	8.660	7.385	1.360
	Left frequency (Hz)	n/a	n/a	12.255	12.030	12.330	12.555	0.180
	Right frequency (Hz)	10.0	Normal	7.385	9.560	10.060	10.485	1.310
	Frequency asymmetry (%)	n/a	Markedly abnormal	9.535	9.110	8.660	7.385	1.360
	Left amplitude ( $\mu$ V)	n/a	n/a	12.215	12.790	13.090	13.315	0.140
	Right amplitude ( $\mu$ V)	43.4	Normal	7.385	9.560	10.060	10.485	1.310
	Amplitude asymmetry (%)	n/a	Markedly abnormal	9.535	9.110	8.660	7.385	1.360
	Left extension (%)	n/a	n/a	12.215	12.790	13.090	13.315	0.140
	Right extension (%)	26.8	Normal	7.385	9.560	10.060	10.485	1.310
Beta rhythm	Amplitude ( $\mu$ V)	19.6	Normal	5.833	8.461	8.686	9.178	2.110
	Amplitude asymmetry (%)	0.2	Normal	5.833	8.461	8.686	9.178	2.110
Theta rhythm	Duration (%)	17.1	Moderately abnormal	7.770	6.620	3.595	7.245	3.795
Delta rhythm	Duration (%)	0.0	Normal	7.532	9.657	10.332	10.757	1.282
Non-dominant alpha rhythm	Duration (%)	20.7	Mildly abnormal	8.501	6.212	8.042	8.627	1.898

Table 5. Quantitative and qualitative analysis of an 8 second EEG segment.

## ACKNOWLEDGEMENTS

We would like to thank each volunteer for their participation in the EEG recordings. This work was supported by the Science and Engineering Research Council.

## REFERENCES

1. Baas L and Bourne J R. (1984) A rule-based microcomputer system for electroencephalogram evaluation. *IEEE Trans. on Biomedical Eng.*, **31**, 10, 660-664.
2. Chatrian G E, Bergamini L, Dondey M, Klass D W, Lennox-Buchthal M and Petersen I. (1974) A glossary of terms most commonly used by clinical electroencephalographers. *Electroenceph. and clin. Neurophys.* **82**, 423-431.
3. COSMIC, 382 E. Broad St. Athens, GA 30602.
4. Dawant B M and Jansen B H. (1991) Coupling numerical and symbolic methods for signal interpretation. *IEEE Trans. on Systems, Man, and Cybernetics*, **12**, 1, 115-124.
5. Glover Jr J R, Ktonas P Y and Jansen B H. (1990) Knowledge-based interpretation of bioelectrical signals. *IEEE Eng. in Medicine and Biology Magazine*, March, 51-54.
6. Ifeachor E C, Hellyar M T, Mapps D J and Allen E M. (1990) Knowledge-based enhancement of human EEG signals. *IEE Proc.* **137**, F, 5, 302-310.
7. Jagannathan V, Bourne J R, Jansen B H and Ward J W. (1982) Artificial intelligence methods in quantitative electroencephalogram analysis. *Computer Programs in Biomedicine*, **15**, 249-258.
8. Marple S L. (1987) Digital spectral analysis with applications. Prentice-Hall, Englewood cliffs, New Jersey 07632.
9. Nakamura M, Shibasaki H, Imajoh K, Nishida S, Neshige R and Ikeda A. (1992) Automatic EEG interpretation: a new computer-assisted system for the automatic integrative interpretation of awake background EEG. *Electroenceph. and clin. Neurophys.* **82**, 423-431.
10. Winston P H (1992) Rules and rule chaining. In: Artificial intelligence 3rd ed., Addison Wesley.
11. Yager R R (1984) Approximate reasoning as a basis for rule-based expert systems. *IEEE Trans. on Systems, Man and Cybernetics*, **14**, 4, 636-643.
12. Zadeh L A (1981) PRUF-a meaning representation language for natural languages. In: Mamdani E H and Gaines B R (1981) Fuzzy reasoning and its applications. Academic press, London.
13. Zadeh L A (1975) The concept of a linguistic variable and its application to approximate reasoning-I. *Information sciences*, **8**, 199-249.
14. Zadeh L A (1975) The concept of a linguistic variable and its application to approximate reasoning-III. *Information sciences*, **9**, 43-80.



## Use of Artificial Intelligence in EEG Evaluation

Dr Emmanuel Ifeakor and Mr Edward Riddington  
University of Plymouth

Electroencephalography (EEG) is a useful and relatively inexpensive, though time-consuming, tool for the diagnosis and evaluation of treatment of neurological disorders. The need for automatic analysis of the EEG signals by computers, to allow for a more efficient use of the valuable time of the clinician and a more reliable diagnosis, is widely recognised. For this to succeed, several key issues must be addressed:

1) the need for a reliable means of detecting and, where appropriate, removing EEG artefacts (e.g. eye artefacts). In some patient categories, a significant proportion of the EEG records are contaminated by artefacts, and so an effective means of dealing with artefacts is mandatory.

2) how to mimic the methods used by human experts to analyse, interpret and report EEGs. This is important if we are to obtain results that match the skills and expertise of experienced electroencephalographers, especially when analysing abnormal EEG records in the presence of significant artefacts.

3) how to integrate computer-based decision support systems into the clinical environment. Such systems must be interactive, make effective use of the strengths of the clinician, and present the results in a form that should practically aid the busy clinician.

The issues above can only be adequately addressed using artificial intelligence techniques. This paper discusses how the expert systems approach, combined with conventional signal processing and artificial neural networks may be used to provide an elegant solution.

