

Corrosion and corrosion preventive methods

Dr. T.S.N. Sankara Narayanan



National Metallurgical Laboratory
Madras Centre, CSIR Complex
Taramani, Chennai-600 113

E-mail: tsnsn@rediffmail.com

Mobile: 9444606088

Introduction to corrosion

What is Corrosion?

- ⦿ The tendency of a metal to revert to its native state (or) Metallurgy in reverse
- ⦿ The chemical or electrochemical reaction between a material and its environments that produces a deterioration of the material and its properties
- ⦿ The destructive attack of a material by reaction with its environment
- ⦿ Corrosion of metals is the commonest electrochemical phenomenon encountered in day-to-day life

Corrosion – A natural process

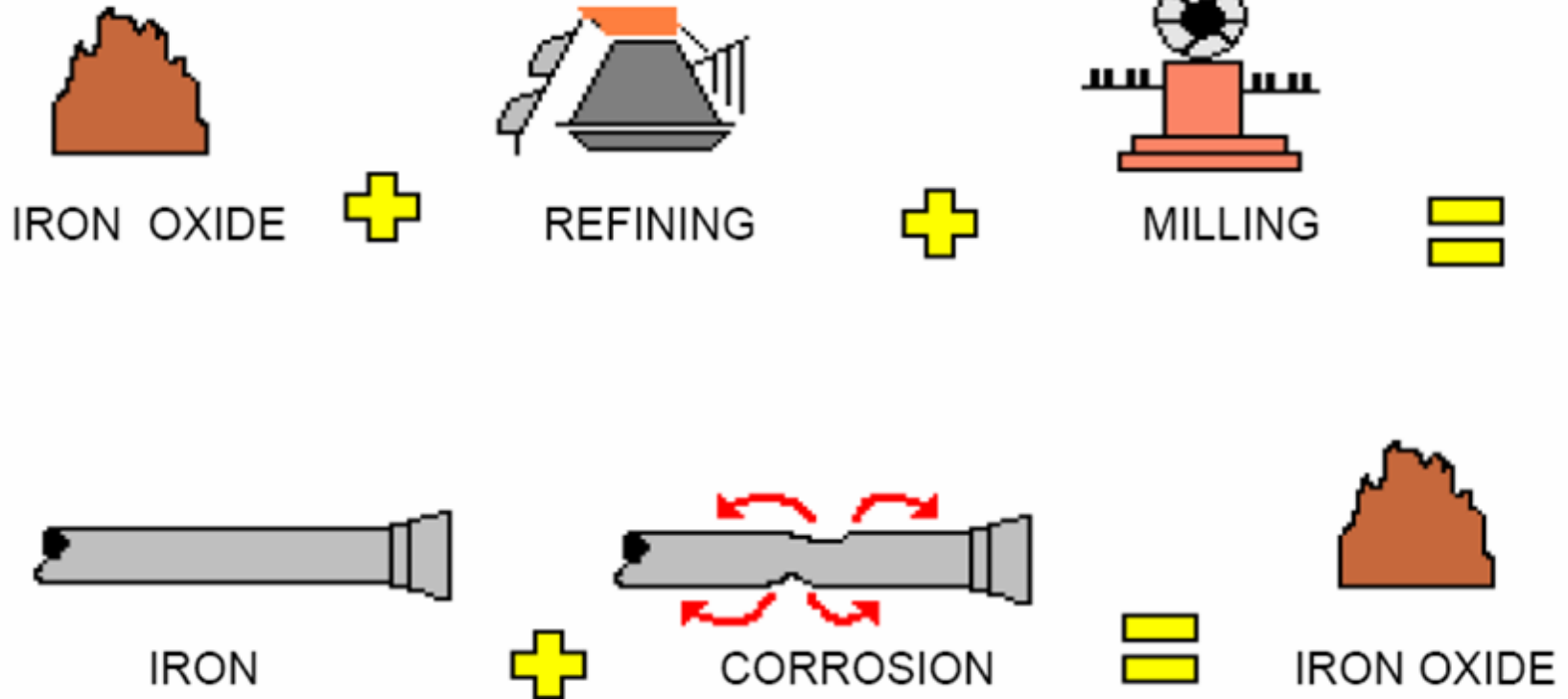

Corrosive environment

- ⦿ All environments are corrosive to some degree
- ⦿ Typical corrosive environments:
 - ⦿ Air and humidity
 - ⦿ Fresh, distilled, salt and marine water
 - ⦿ Natural, urban, marine and industrial atmospheres.
 - ⦿ Steam and gases, like chlorine
 - ⦿ Ammonia
 - ⦿ Hydrogen sulfide
 - ⦿ Sulfur dioxide and oxides of nitrogen
 - ⦿ Fuel gases
 - ⦿ Acids and Alkalies
 - ⦿ Soils

Consequences of corrosion

- ⦿ Plant shutdowns
 - ⦿ Shutdown of nuclear plants, process plants, power plants and refineries may cause severe problems to industry and consumers.
- ⦿ Loss of products
 - ⦿ leaking containers, storage tanks, water and oil transportation lines and fuel tanks cause significant loss of product
 - ⦿ It may generate severe accidents and hazards
 - ⦿ It is well known that at least 25% of water is lost by leakage.

Consequences of corrosion

- ⦿ Loss of efficiency
 - ⦿ Insulation of heat exchanger tubing and pipelines by corrosion products reduces heat transfer and piping capacity.
- ⦿ Contamination
 - ⦿ Corrosion products may contaminate chemicals, pharmaceuticals, dyes, packaged goods, etc. with dire consequences to the consumers.
- ⦿ Nuclear hazards
 - ⦿ The Chernobyl disaster is a continuing example of transport of radioactive corrosion products in water, fatal to human, animal and biological life



It was supposed to look like this

Due to corrosion it could ... would turn like this ...



Corrosion of boats and ships





Corrosion on the bow of an [Oil tanker](#)



Rusting tank at the Highway of Death in Iraq

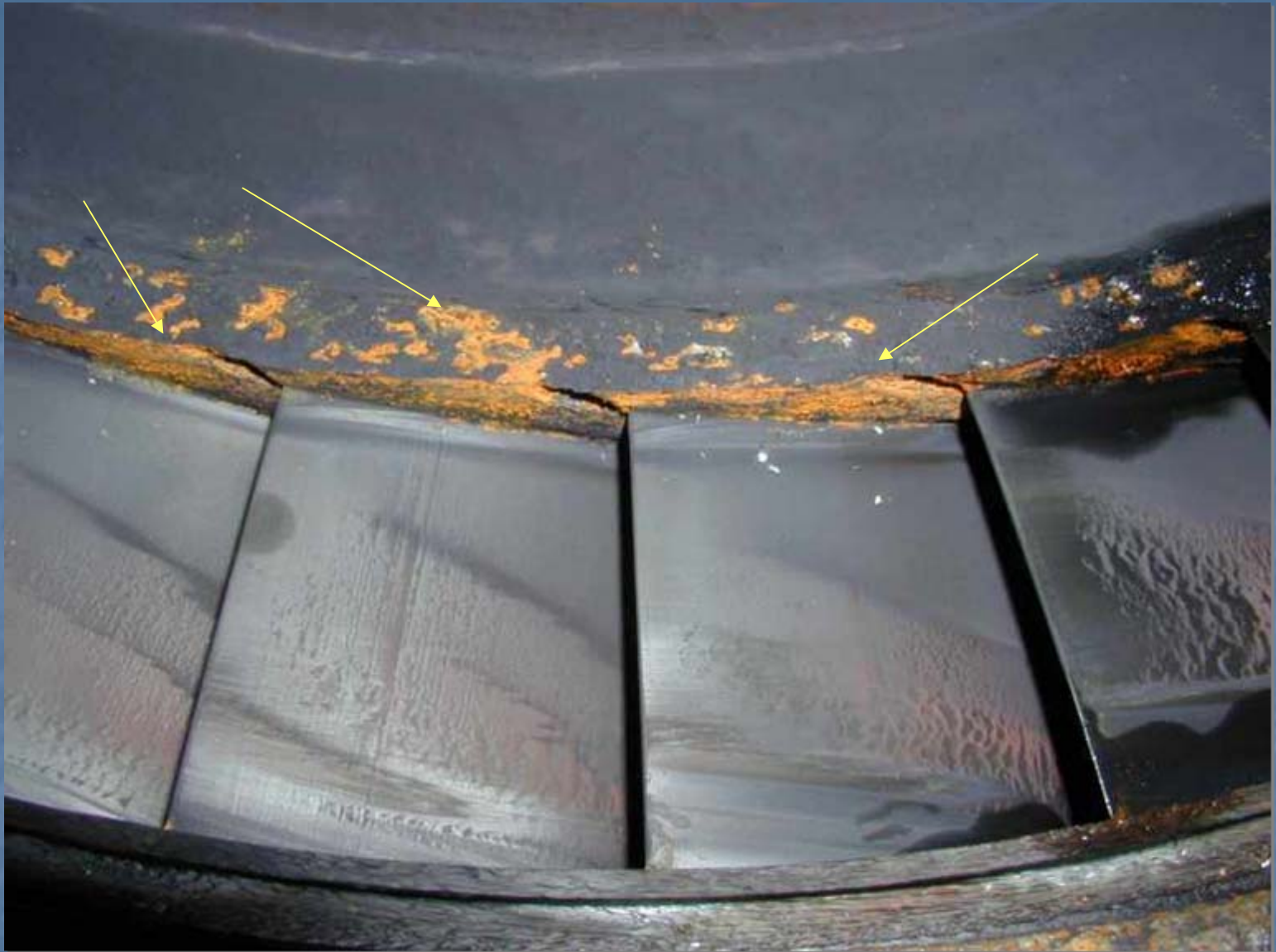

Erosion-corrosion of carbon steel components of a low pressure turbine caused by the passage of high velocity wet steam



Pitting corrosion of high pressure turbine blades caused by a leaking isolation valve combined with incorrect steam chemistry

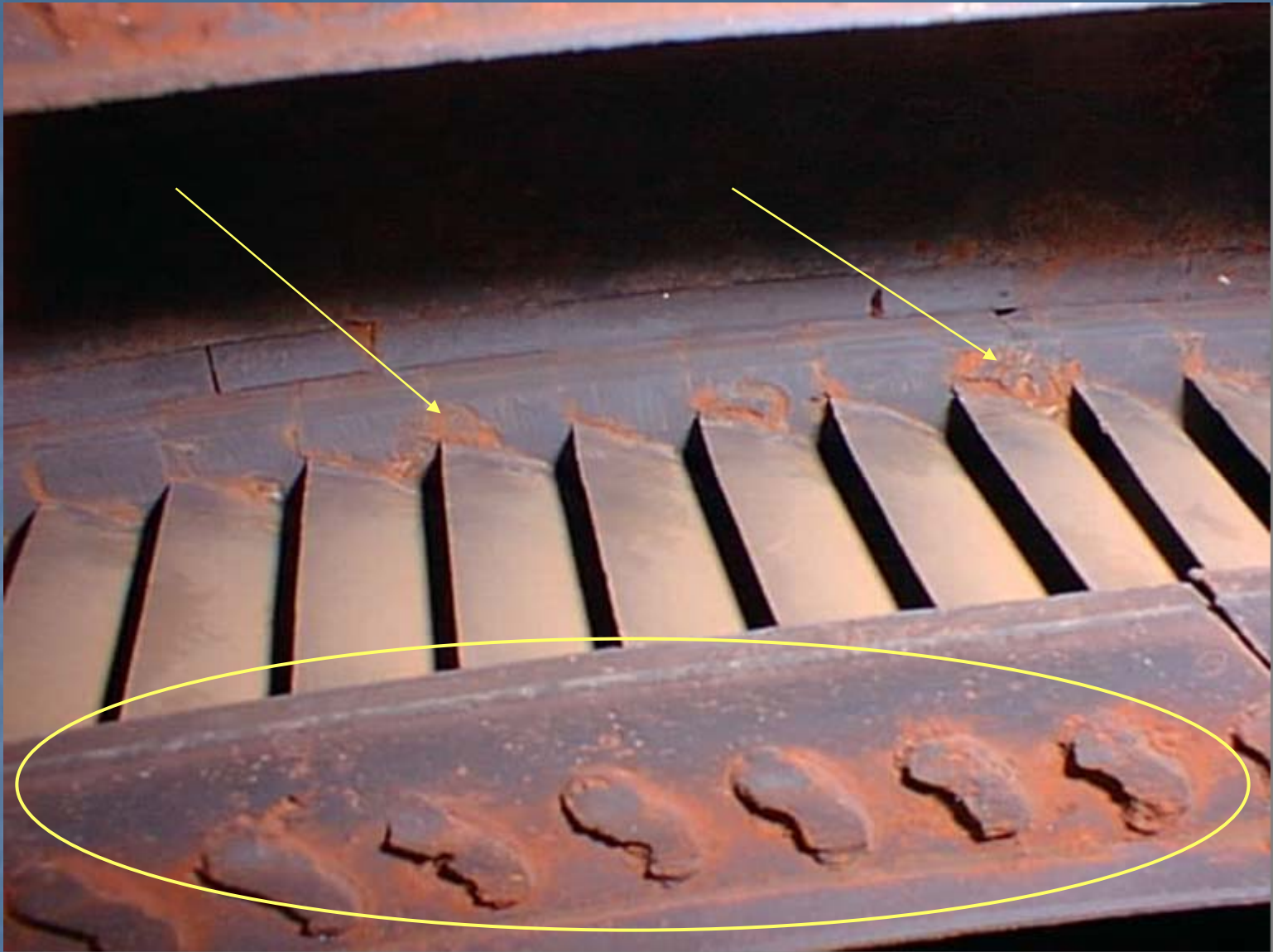

Pitting corrosion of turbine blade roots and cover band caused by incorrect steam chemistry



rusty, bolt, rust, steel,
metal, machinery





Pressure Valve in Petrochemical Plant

Courtesy: Corbis Photos



Rusty Gear



Corrosion of ipod nano

Loss due to corrosion

Economic impact: ~3.5% of GDP in developed countries

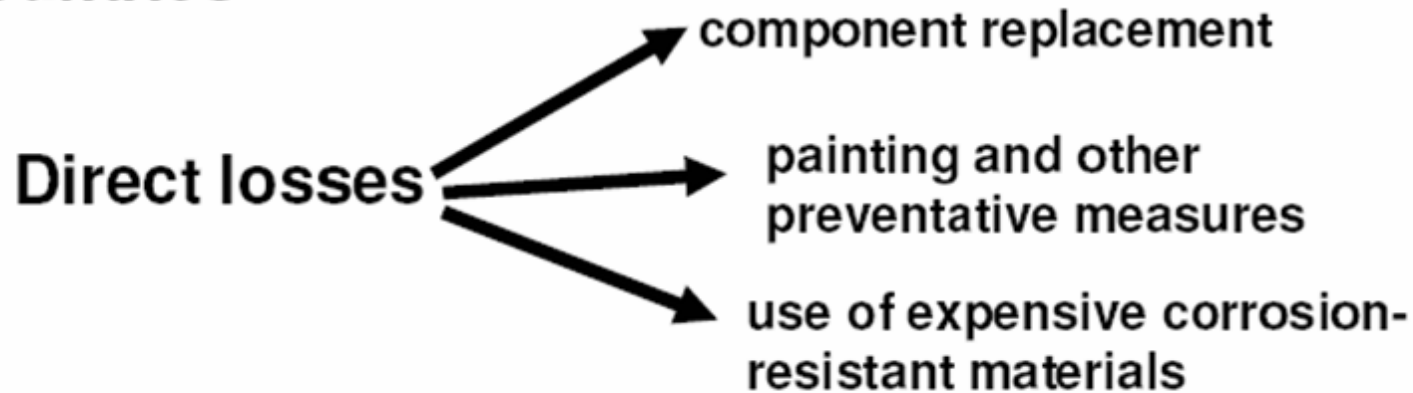

Cost of corrosion

- For most industrialized nations - 3.0 to 4.5% of the GNP
- In U.S.A. - About 3.1% - \$276 billion/yr

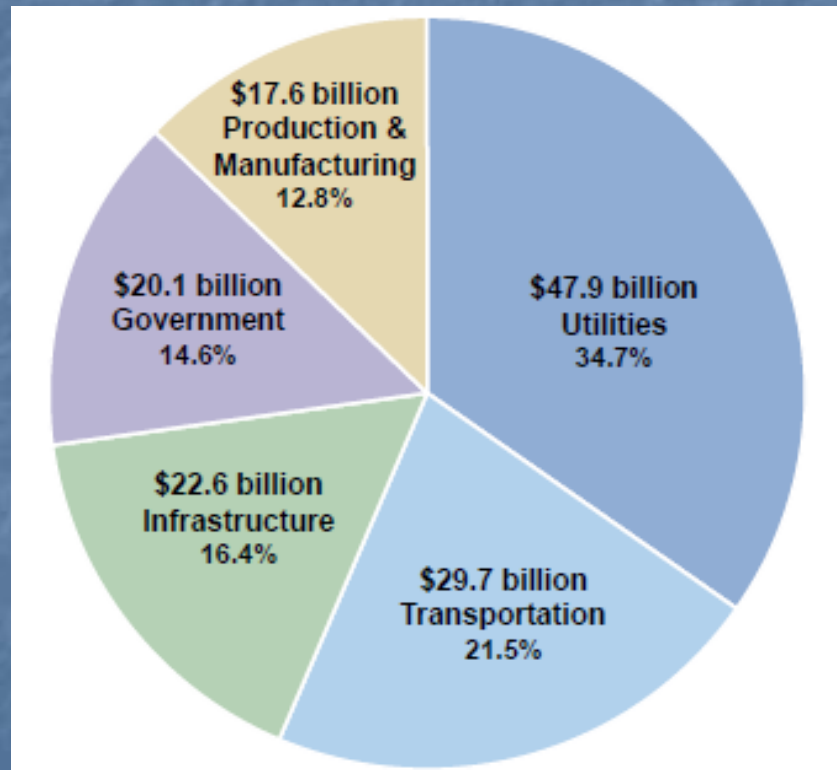

Cost of corrosion in USA

Cost of corrosion

- ⦿ The corrosion-free life of automobiles in the coastal regions of Arabian Gulf is about six months only
- ⦿ The corrosion cost of gas & liquid transmission pipelines
 - ⦿ In USA - seven billion US dollars
 - ⦿ In gulf countries? - several times higher
- ⦿ Nearly 95% of concrete damage in the Arabian Gulf coastal region is caused by reinforcement corrosion and consequent spalling of concrete
- ⦿ It is estimated that 10% of all aircraft maintenance in USA is spent on corrosion remediation
- ⦿ Every new born baby in the world now has an annual corrosion debt of \$40.

Why one should study corrosion?

Five Good Reasons to Study Corrosion

- ◎ Reason 1 – Preservation of valuable resources
- ◎ Materials are precious resources of a country.
- ◎ Our material resources of iron, aluminum, copper, chromium, manganese, titanium, etc. are dwindling fast.
- ◎ To preserve these valuable resources, we need to understand how these resources are destroyed by corrosion and how they must be preserved by applying corrosion protection technology.

Five Good Reasons to Study Corrosion

- ⊙ Reason 2 - Engineering knowledge is incomplete without an understanding of corrosion
- ⊙ Aeroplanes, ships, automobiles and other transport carriers cannot be designed without any recourse to the corrosion behavior of materials used in these structures.

Five Good Reasons to Study Corrosion

- ◎ Reason 3 – Disaster prevention
- ◎ Several engineering disasters, such as crashing of civil and military aircraft, naval and passenger ships, explosion of oil pipelines and oil storage tanks, collapse of bridges and decks and failure of drilling platforms and tanker trucks have been witnessed in recent years
- ◎ Corrosion has been a very important factor in these disasters. Applying the knowledge of corrosion protection can minimize such disasters.
- ◎ Two million miles of pipe need to be corrosion-protected for safety

Five Good Reasons to Study Corrosion

- ⦿ Reason 4 – health care
- ⦿ The designing of artificial implants for the human body requires a complete understanding of the corrosion science and engineering
- ⦿ Surgical implants must be very corrosion-resistant because of corrosive nature of human body environment

Five Good Reasons to Study Corrosion

- ⦿ Reason 5 - threat to the environment
- ⦿ Water can become contaminated by corrosion products and unsuitable for consumption
- ⦿ Corrosion prevention is integral to stop contamination of air, water and soil.

Classification of corrosion process

- ⦿ Depending on the characteristics of the environment, corrosion processes are classified as:
 - ⦿ chemical – Dry corrosion
 - ⦿ Electrochemical – Wet corrosion
- ⦿ Chemical corrosion - Reaction of metals with a non-electrolyte
 - ⦿ oxidation in high temperature air
 - ⦿ dissolution in liquid metals
 - ⦿ dissolution in a carbon tetrachloride solution containing iodine

Classification of corrosion process

- ⦿ Electrochemical corrosion – Dissolution of metals in an electrolyte forming metal cations, which implies transfer of electric charge across the metal/environment interface.
- ⦿ Electrochemical corrosion occurs in the large variety of electrolytes found in natural environments and industrial applications ranging from groundwater to molten salts and acids dissolved in organic polar solvents (e.g., hydrochloric acid in methanol)

Dry corrosion / oxidation / tarnishing

Formation of oxide film at metal surface

e.g. Aluminium (Al) \rightarrow Alumina (Al₂O₃)

Not generally a problem at room temperature, because:

- ✱ reaction is slow
- ✱ film is protective i.e. separates reacting species

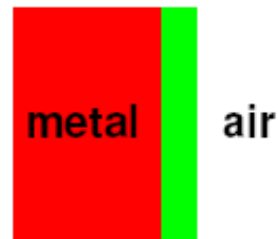

Can be a problem at high temperatures, especially if film quality is poor i.e. it has cracks or pores, or is unstable

Oxidation: examples

Aluminium: oxide film is of high quality → protects underlying metal

Magnesium: low-quality oxide film, with cracks and pores → high oxidation rates

Stainless steel: contains Cr, which forms protective and highly adherent Cr_2O_3 film

Tungsten: oxide volatile above $800\text{ }^\circ\text{C}$ → no protection

Rate of oxidation

Rate of oxidation and the tendency of the film to protect the metal from further oxidation are related to the relative volumes of the oxide and metal.

$$P - B \text{ ratio} = \frac{A_0 \rho_M}{A_M \rho_0}$$

Where:

P-R ratio = Pilling-Bedworth ratio

A_0 = is the molecular (or formula) weight of the oxide

A_M = is the atomic weight of the metal

ρ_0 = oxide density

ρ_M = metal density

Oxidation rate (kinetics)

Where:

ω = weight gain per unit area

t = time

κ_L , κ_p and κ_e are the constant linear, parabolic and logarithmic respectively.

C and A are constant.

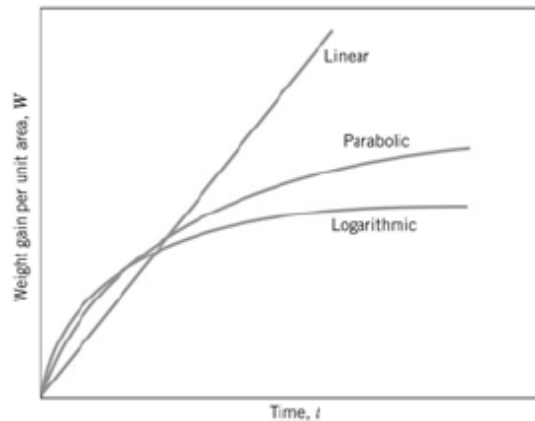

Linear:	$\omega = \kappa_L t$
---------	-----------------------

Parabolic	$\omega^2 = \kappa_p t + C$
-----------	-----------------------------

Logarithmic	$\omega = \kappa_e \log (C \cdot t + A)$
-------------	--

Electrochemical (Wet) corrosion

Basic principles:

Metals in aqueous solutions tend to form ions

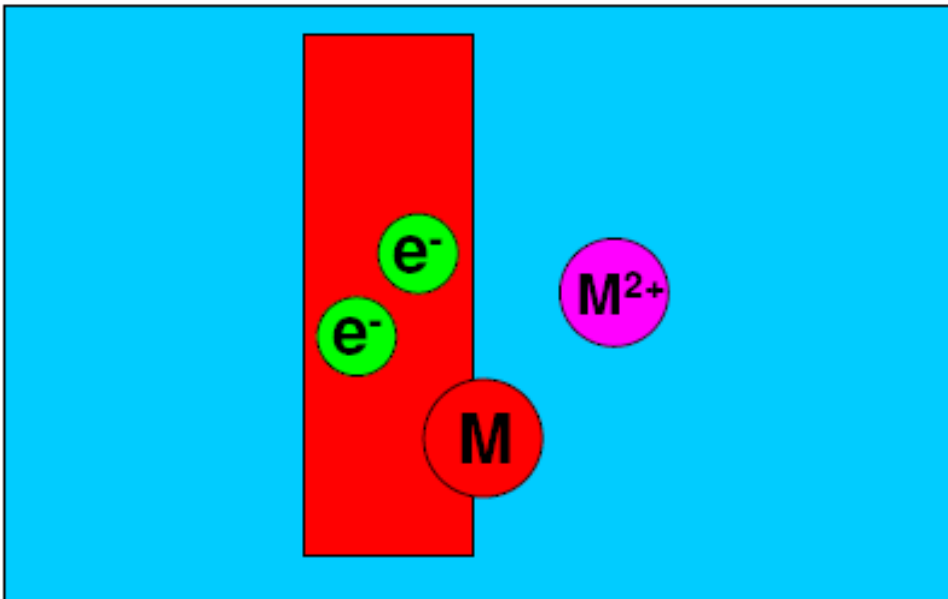

Electrochemical (Wet) corrosion

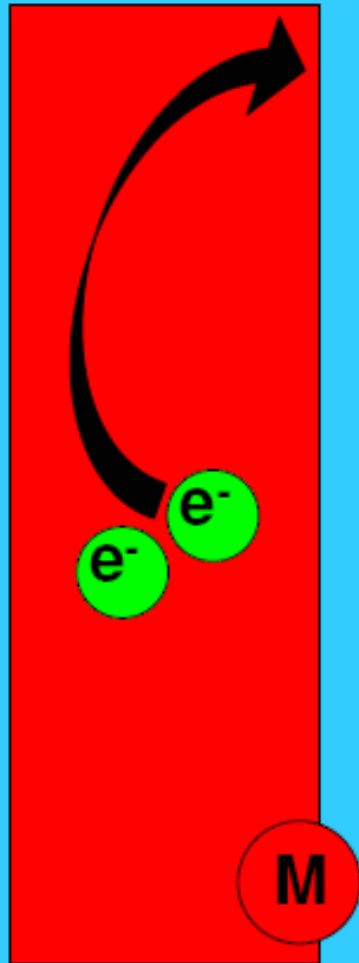

e.g. evolution of hydrogen:



or, if oxygen is present:

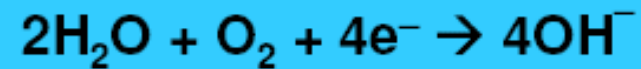

Electrochemical (Wet) corrosion

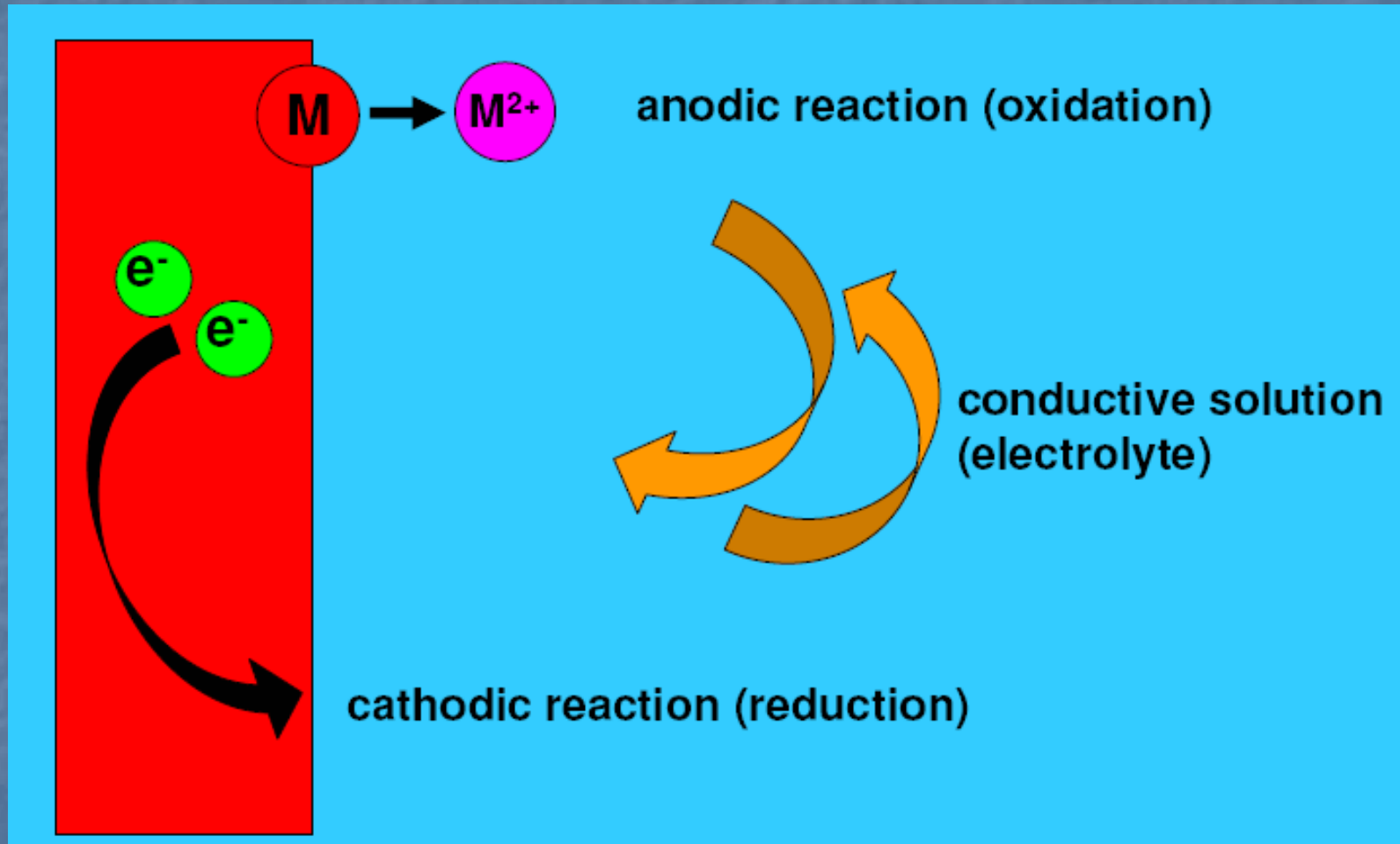

Electrochemical (Wet) corrosion

OXIDATION REACTION (*occurs at the ANODE*) - Corrosion (dissolving)

Metals \rightarrow Ions



i.e. Metal anode dissolves.

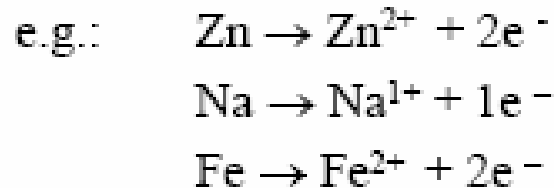

REDUCTION reactions (occur at the cathode - Cathodic Reaction)

• These depend on what is available:

- ✓ If H^{+} ions are available then: $2\text{H}^{+} + 2e^{-} \rightarrow \text{H}_2$
- ✓ If acid solution with dissolved oxygen: $\text{O}_2 + 4\text{H}^{+} + 4e^{-} \rightarrow 2\text{H}_2\text{O}$
- ✓ If basic/neutral with dissolved oxygen: $\text{O}_2 + 2\text{H}_2\text{O} + 4e^{-} \rightarrow 4(\text{OH}^{-})$

Total oxidation = Total reduction (Charge balance)

The four basic parts of a corrosion cell

- 💧 Anode – A metal electrode in contact with the electrolyte which corrodes
- 💧 Cathode - A metal electrode in contact with the electrolyte which is protected against corrosion
- 💧 Electrolyte – A solution or conducting medium such as soil, water or concrete which contains oxygen and dissolved chemicals
- 💧 Metal Path – An external circuit that connects the anode and the cathode

The simplified corrosion cell

1. Anode
2. Cathode
3. Electrolyte
4. Metal Path

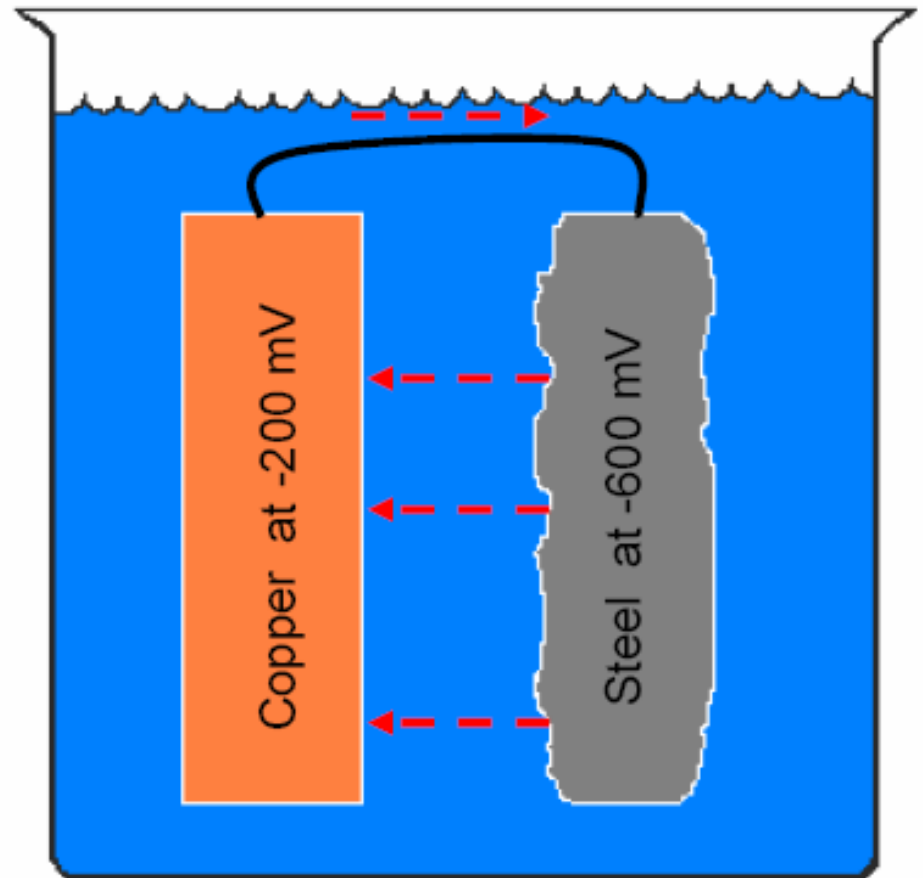

Corrosion cell – Anodic reactions

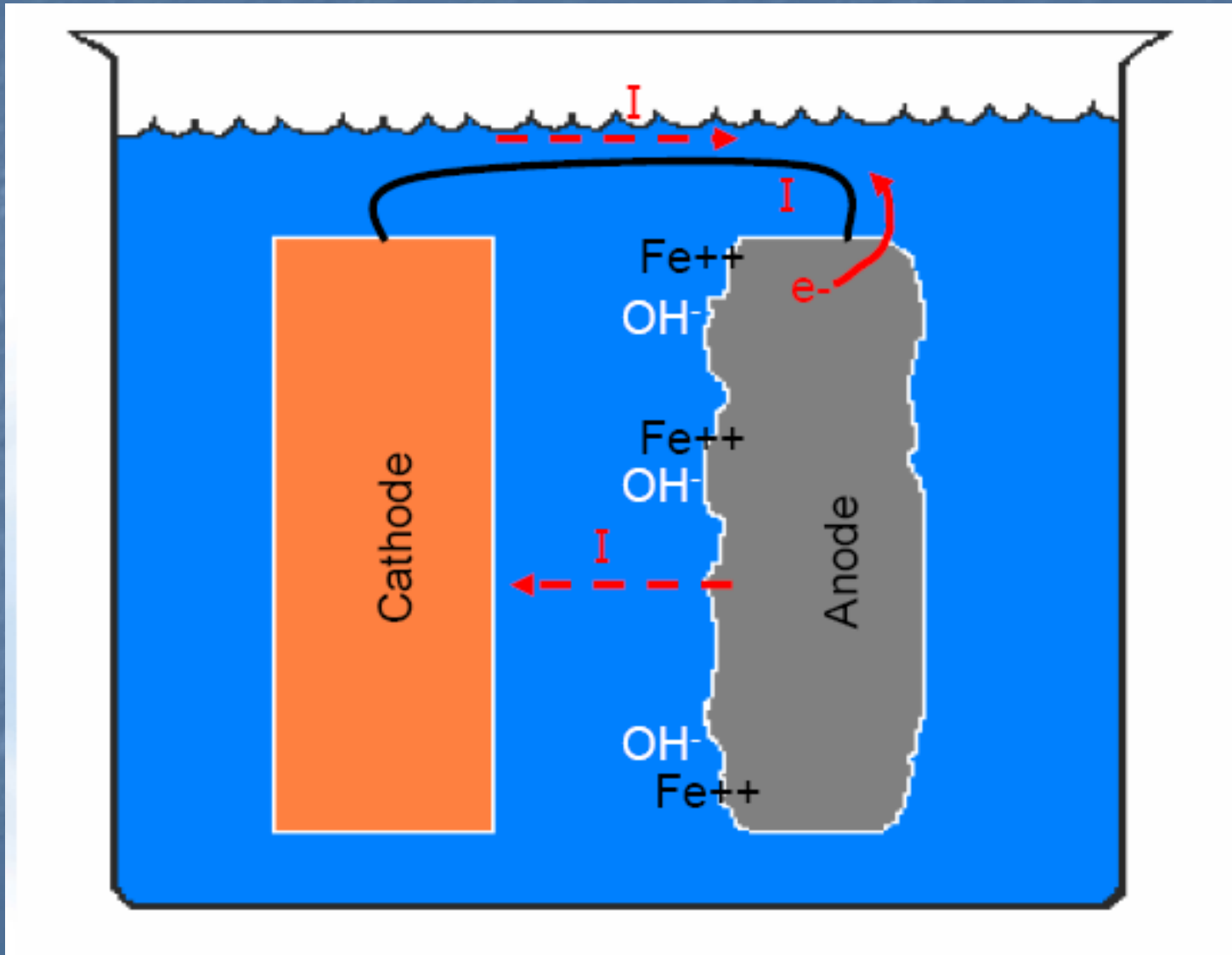

Corrosion cell – Cathodic reactions

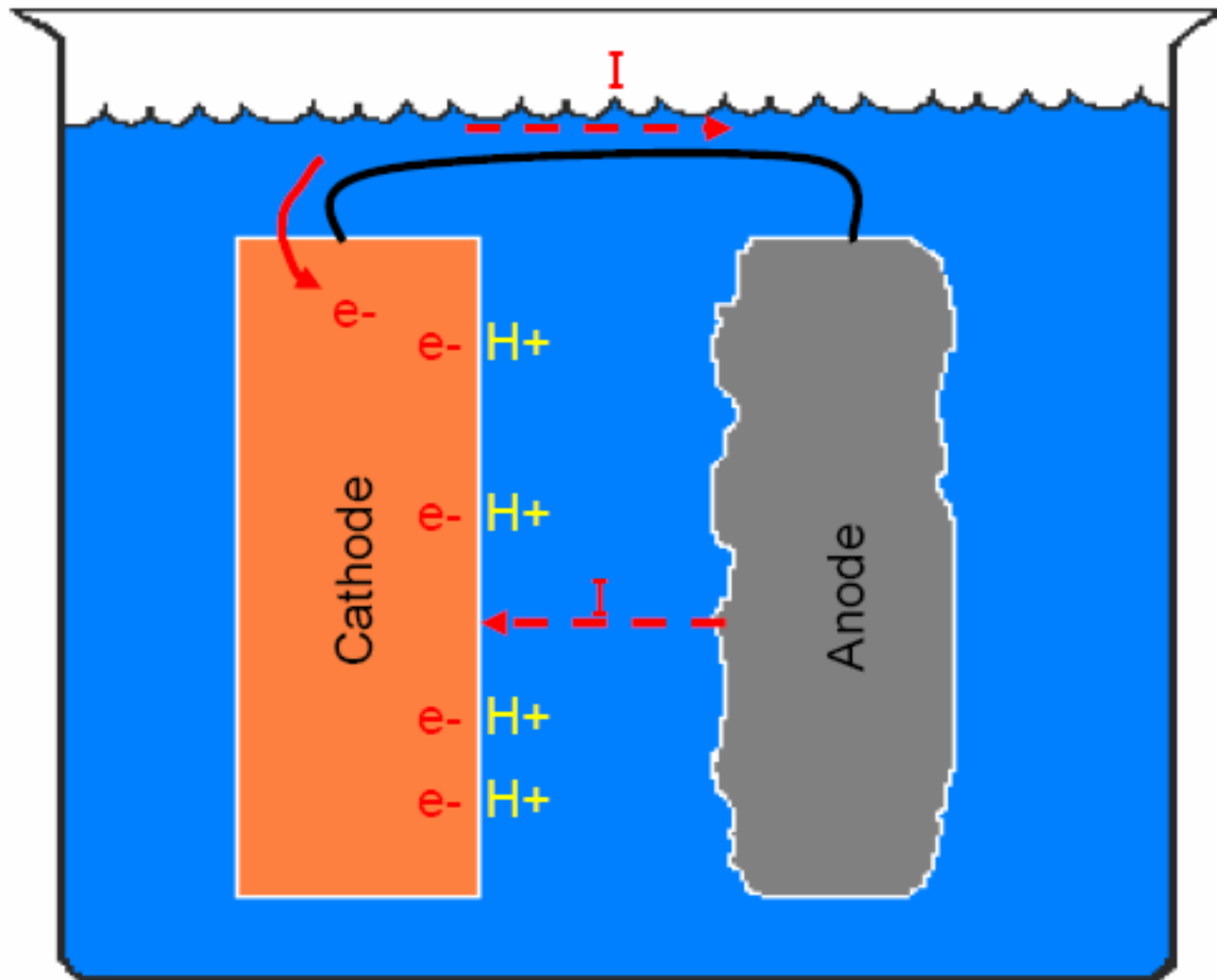

Corrosion cell – Combined reactions

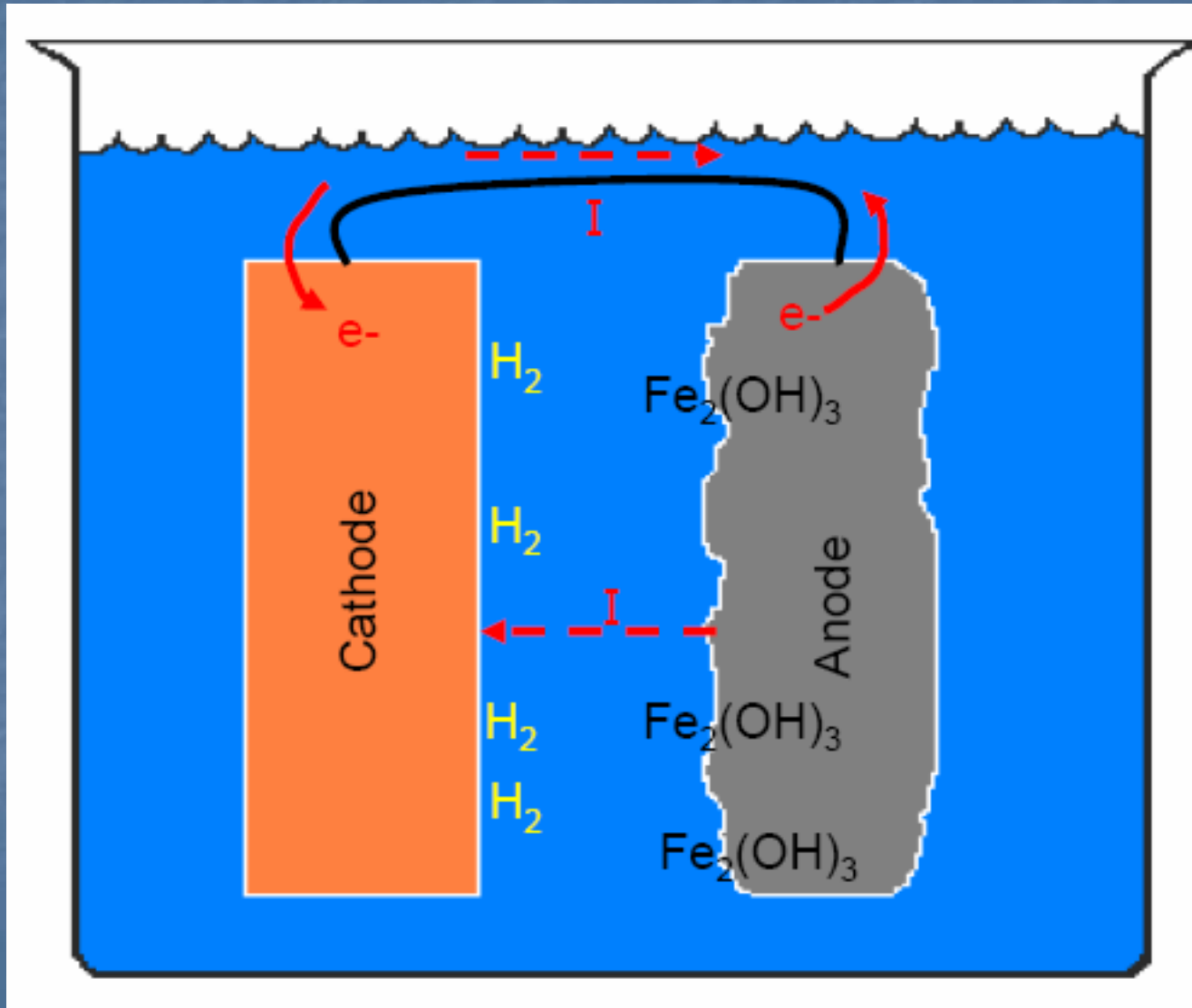

Corrosion Memorabilia!

- Electron flow direction is FAT CAT (from anode to cathode)
- Oxidation at the anode, reduction at the cathode (OAR-CAT !)
- Anion to anode - cation to cathode
- ANO (anode attracts negative ions and results in oxidation)
- CPR (cathode attracts positive ions and results in reduction)

Standard electrode potential

- **EMF series**

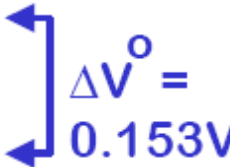
	metal	V_{metal}°	
	Au	+1.420 V	
	Cu	+0.340	
	Pb	-0.126	
	Sn	-0.136	
	Ni	-0.250	
	Co	-0.277	
	Cd	-0.403	
	Fe	-0.440	
	Cr	-0.744	
	Zn	-0.763	
	Al	-1.662	
	Mg	-2.262	
Na	-2.714		
K	-2.924		

Data based on Table 17.1, *Callister 6e*.

Metals with a more negative Standard Electrode Potential are more likely to corrode relative to other metals.

Galvanic series

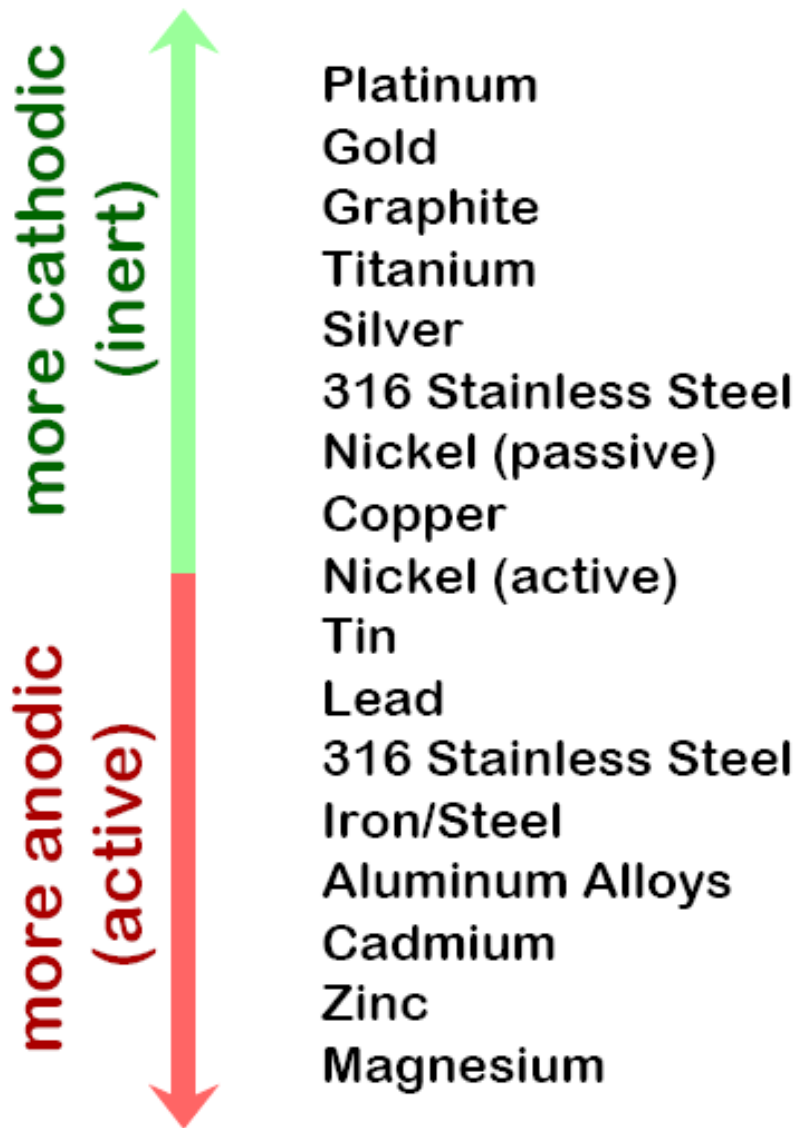

Reactivity of metals and alloys in sea water based on standard electrode potential

Tendency of metals to oxidize

Corrosion of Zinc in acid

- Two reactions are necessary:

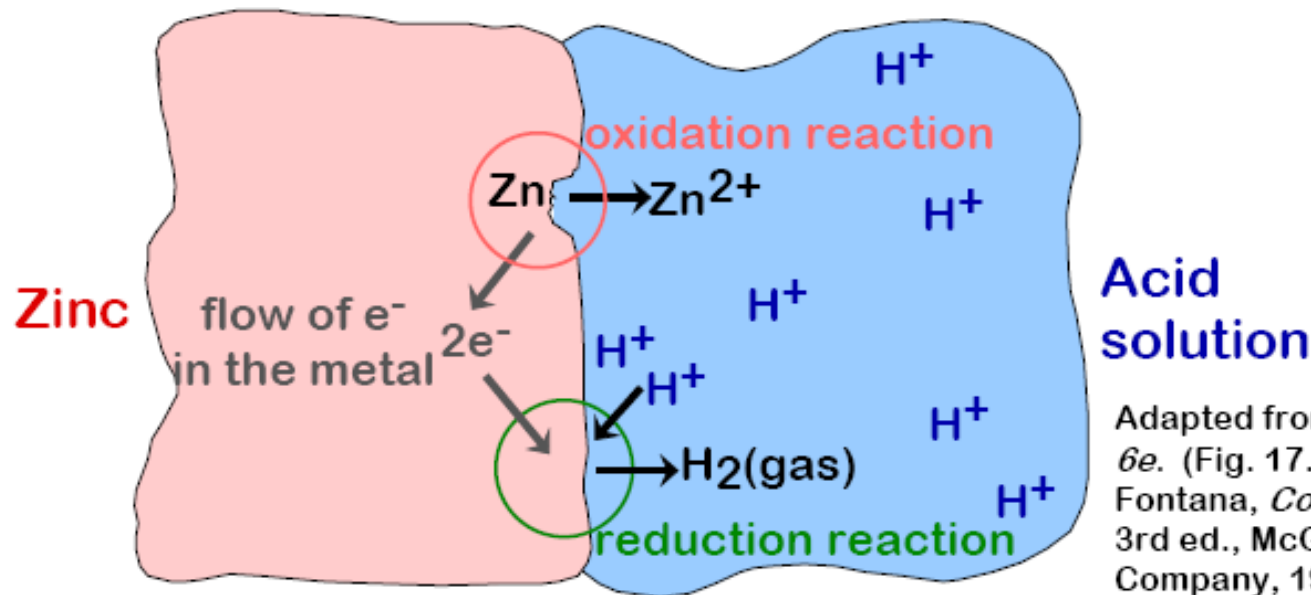
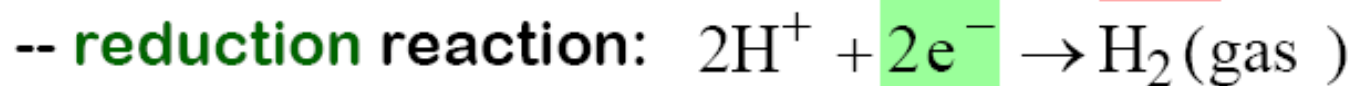
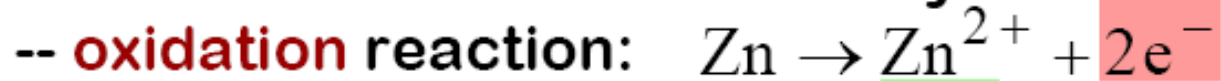

- Other **reduction** reactions:

-- in an acid solution

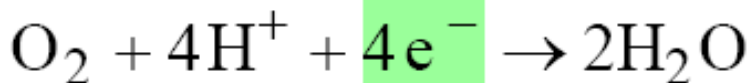

-- in a neutral or base solution

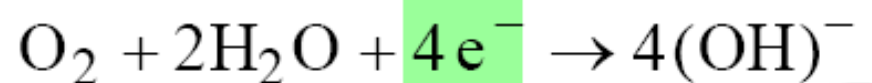

Rusting of iron in water

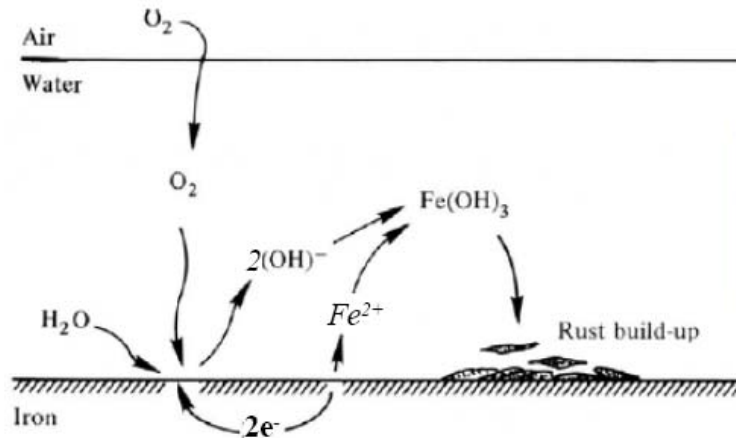

Dissolved oxygen is needed to form OH^- ions.

Two step process:

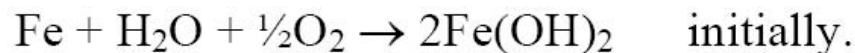
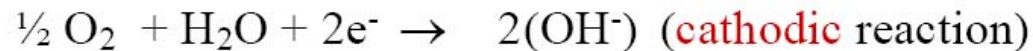

Then:

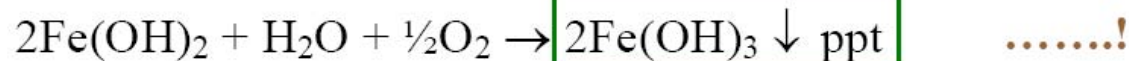

Factors influencing corrosion

- Metal
 - Chemical composition
 - Reactivity – Inclusions and Stress
- Environment
 - Humidity (Dry corrosion)
 - Concentration of corrosive gases (Dry corrosion)
 - Concentration of the electrolyte (Wet corrosion)
 - Type of anions present (Wet corrosion)
 - Acidity (pH) (Wet corrosion)
 - Temperature (Dry and wet corrosion)
 - Dissolved oxygen concentration (Wet corrosion)
 - Time of exposure (Dry and wet corrosion)

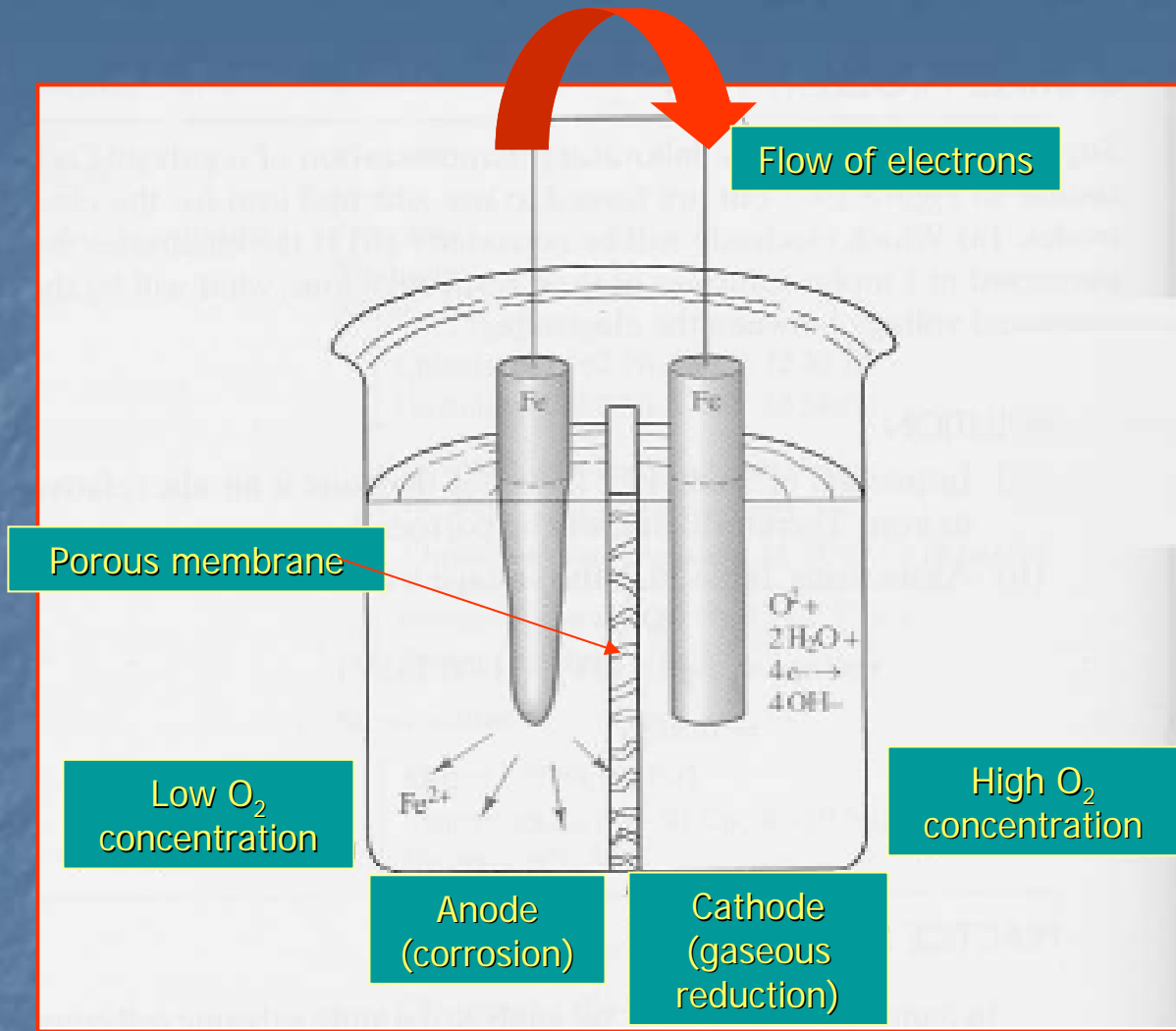

Effect of dissolved oxygen on the corrosion

Is corrosion always a problem?

Is corrosion always a problem?

- Anodizing – formation of TiO_2 nanoporous structure – nanotubes – controlled drug delivery
- AAO membranes for preparing metallic nanowires and nanotubes
- Etching of metals – metallographic
- Cathodic protection – sacrificial anodes
- Dry cell batteries

Forms of corrosion

Forms of corrosion

- ❖ The eight forms of corrosion are:
 - Uniform or general attack
 - Galvanic or bi-metal corrosion
 - Crevice corrosion
 - Pitting corrosion
 - Intergranular corrosion
 - Selective leaching or parting
 - Erosion corrosion
 - Stress corrosion

Uniform corrosion

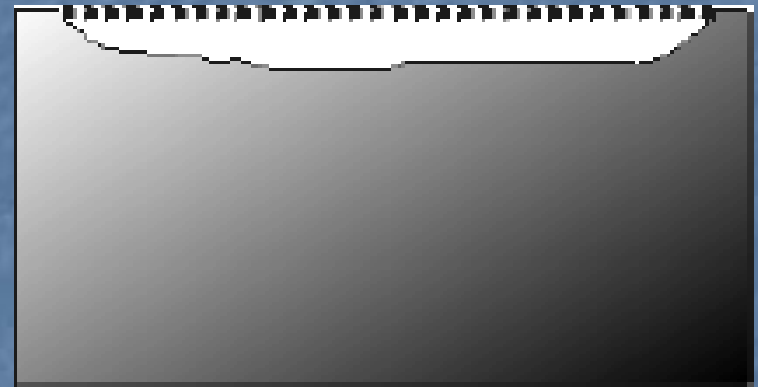

Uniform corrosion

- ❖ Most common form of corrosion.
- ❖ Characterized by a chemical or electrochemical reaction which proceeds uniformly over the entire exposed surface or over a large area
- ❖ The metal becomes thinner and eventually fails
- ❖ Steel or zinc immersed in dilute sulfuric acid will normally dissolve at a uniform rate over its entire surface
- ❖ A sheet iron roof will show essentially the same degree of rusting over its entire outside surface.
- ❖ Uniform corrosion represents the greatest destruction of metal on a tonnage basis
- ❖ This form of corrosion, however, is not of too great concern from the technical standpoint, because the life of equipment can be accurately estimated on the basis of comparatively simple tests.



Corrosion on Weathering Steel Lamppost



Active Corrosion on Carbon Steel Manhole



Corrosion Hues on a Weathering Steel



Courtesy of NASA

Galvanic corrosion



Galvanic or Two-Metal Corrosion

- ❖ When two dissimilar metals are immersed in a corrosive or conductive solution - A potential difference usually exists between them - electron flow between them.
- ❖ The less resistant metal becomes the anode and the more resistant metal becomes the cathode
- ❖ Corrosion of the less corrosion-resistant metal is usually increased and attack of the more resistant material is decreased, as compared with the behavior of these metals when they are not in contact.
- ❖ Usually the cathode corrodes very little or not at all in this type of couple.
- ❖ Because of the involvement of electric currents and dissimilar metals, this form of corrosion is called galvanic, or two-metal, corrosion.



Galvanic Corrosion Couple between Steel and Brass

Factors influencing galvanic corrosion

- ❖ The voltage difference between the two metals on the galvanic series
- ❖ The nature of the environment
- ❖ The size of the exposed area of cathodic metal relative to that of the anodic metal
- ❖ Factors such as area ratios, distance between electrically connected materials, and geometric shapes also affect galvanic-corrosion behavior
- ❖ Corrosion of the anodic metal is both more rapid and more damaging as the voltage difference increases and as the cathode area increases relative to the anode area.

Galvanic series in seawater at 25 °C

Corroded end (anodic, or least noble)
Magnesium
Magnesium alloys
Zinc
Galvanized steel or galvanized wrought iron
Aluminum alloys
5052, 3004, 3003, 1100, 6053, in this order
Cadmium
Aluminum alloys
2117, 2017, 2024, in this order
Low-carbon steel
Wrought iron
Cast iron
Ni-Resist (high-nickel cast iron)
Type 410 stainless steel (active)
50-50 lead-tin solder
Type 304 stainless steel (active)
Type 316 stainless steel (active)
Lead
Tin
Copper alloy C28000 (Muntz metal, 60% Cu)
Copper alloy C67500 (manganese bronze A)
Copper alloys C46400, C46500, C46600, C46700 (naval brass)
Nickel 200 (active)
Inconel alloy 600 (active)

Contd

Galvanic series in seawater at 25 °C (Cont ...)

Hastelloy alloy B
Chlorimet 2
Copper alloy C27000 (yellow brass, 65% Cu)
Copper alloys C44300, C44400, C44500 (admiralty brass)
Copper alloys C60800, C61400 (aluminum bronze)
Copper alloy C23000 (red brass, 85% Cu)
Copper C11000 (ETP copper)
Copper alloys C65100, C65500 (silicon bronze)
Copper alloy C71500 (copper nickel, 30% Ni)
Copper alloy C92300, cast (lead tin bronze G)
Copper alloy C92200, cast (lead tin bronze M)
Nickel 200 (passive)
Inconel alloy 600 (passive)
Monel alloy 400
Type 410 stainless steel (passive)
Type 304 stainless steel (passive)
Type 316 stainless steel (passive)
Incoloy alloy 825
Inconel alloy 625
Hastelloy alloy C
Chlorimet 3
Silver
Titanium
Graphite
Gold
Platinum
Protected end (cathodic, or most noble)

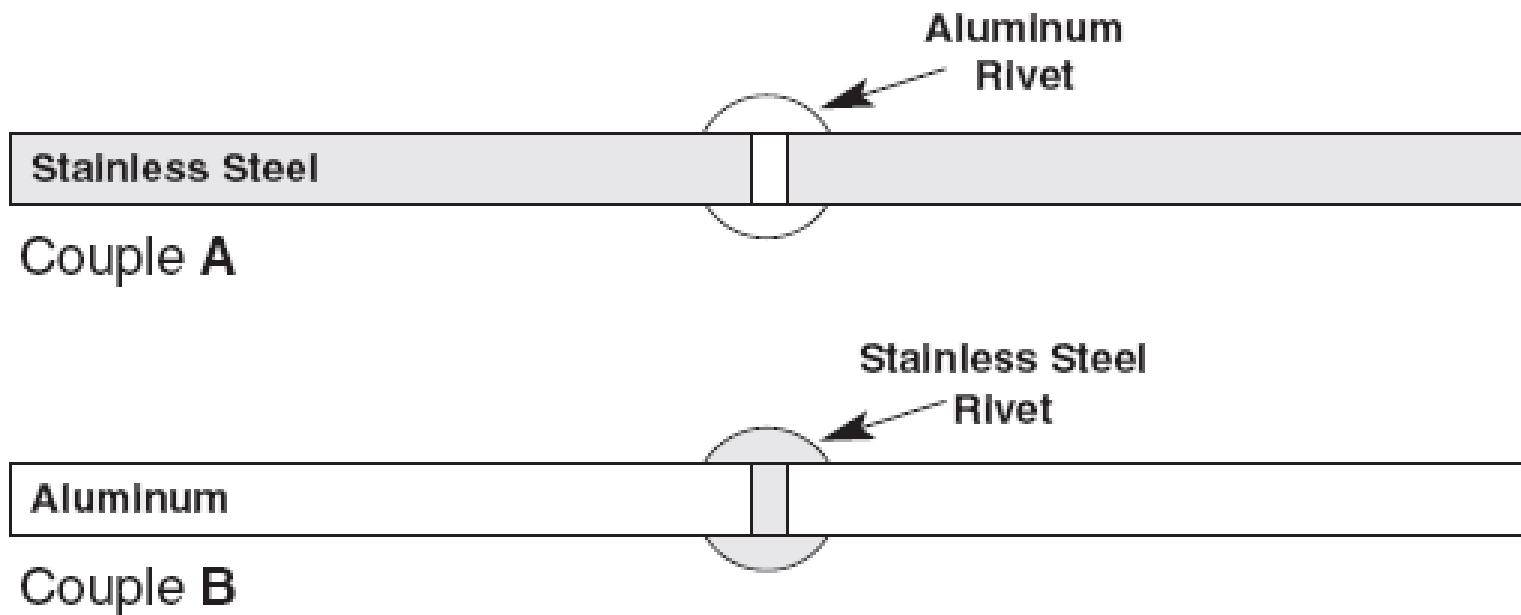

In both couples, aluminum is the anode, and stainless steel is the cathode.

Couple A – Size of the Al rivet is very small - the C/A ratio is large.

Couple B – Size of SS rivet is very small - the C/A ratio is also small.

Corrosion of the aluminum rivet in couple A will be severe.

However, corrosion of the large aluminum plate in couple B will be much less, even though the potential difference is the same in each case.

Effect of distance on galvanic corrosion

- ❖ Dissimilar metals in a galvanic couple that are in close physical proximity usually suffer greater galvanic effects than those that are further apart.
- ❖ The distance effect is dependent on solution conductivity because the path of current flow is the primary consideration
- ❖ Thus, if dissimilar pipes are butt welded with the electrolyte flowing through them, the most severe corrosion will occur adjacent to the weld on the anodic member.

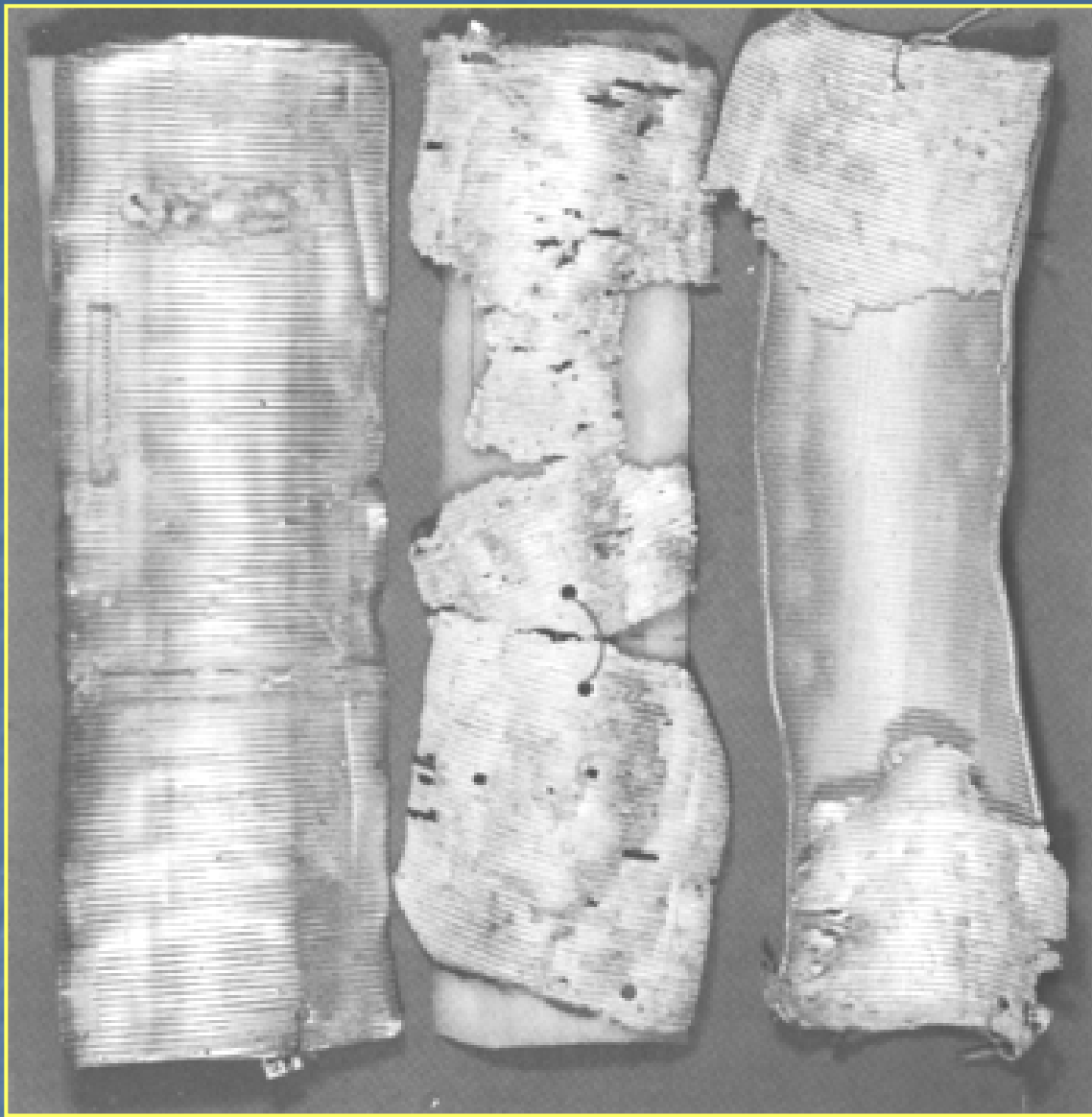

Galvanic corrosion of aluminum shielding in buried telephone cable coupled to buried copper plates

Courtesy: R. Baboian, Texas Instruments, Inc.

CORROSION OF ALUMINUM IN

COPPER-ALUMINUM POWER CABLE SPLICE

COPPER

ALUMINUM

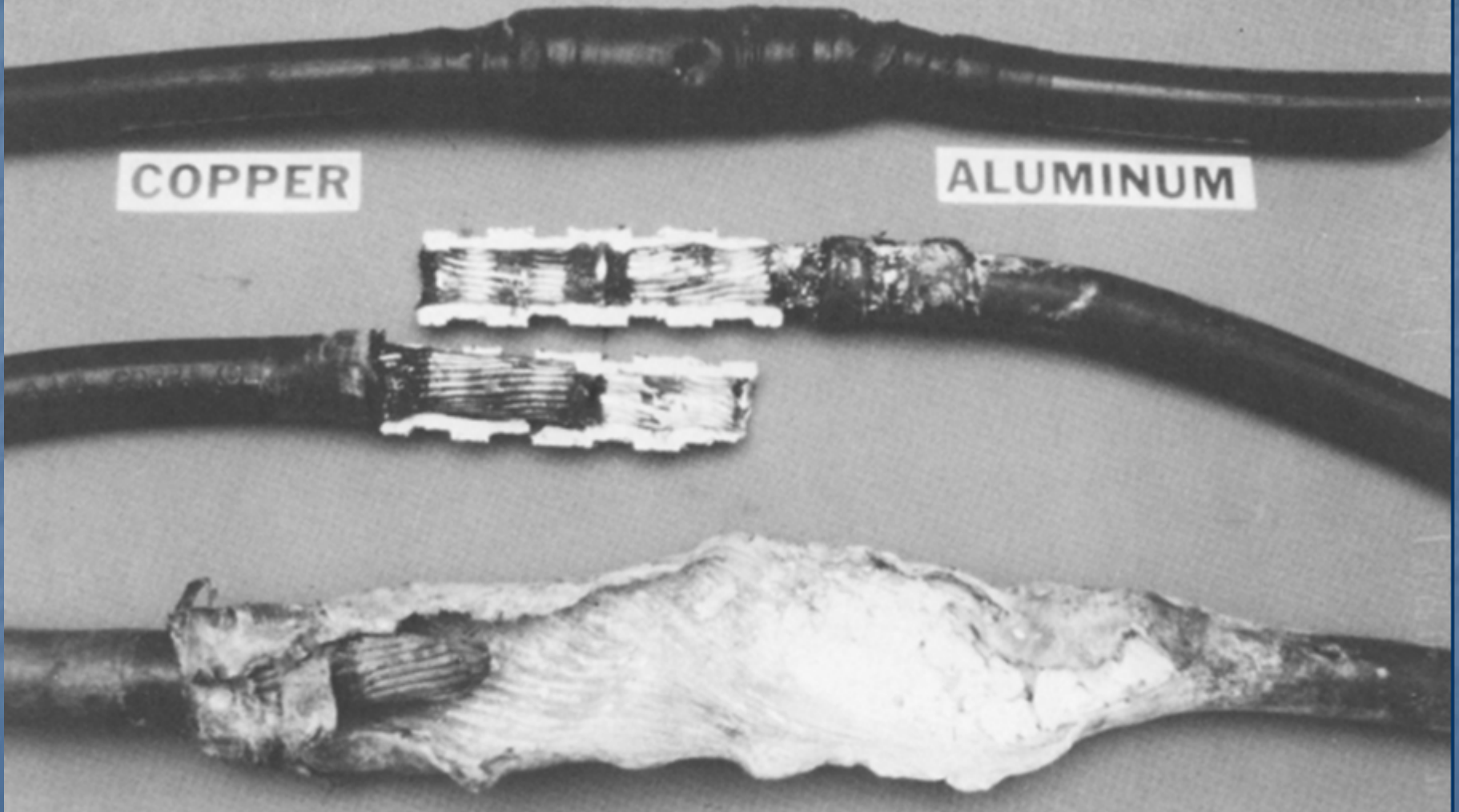

Galvanic corrosion of aluminum in buried power cable splice

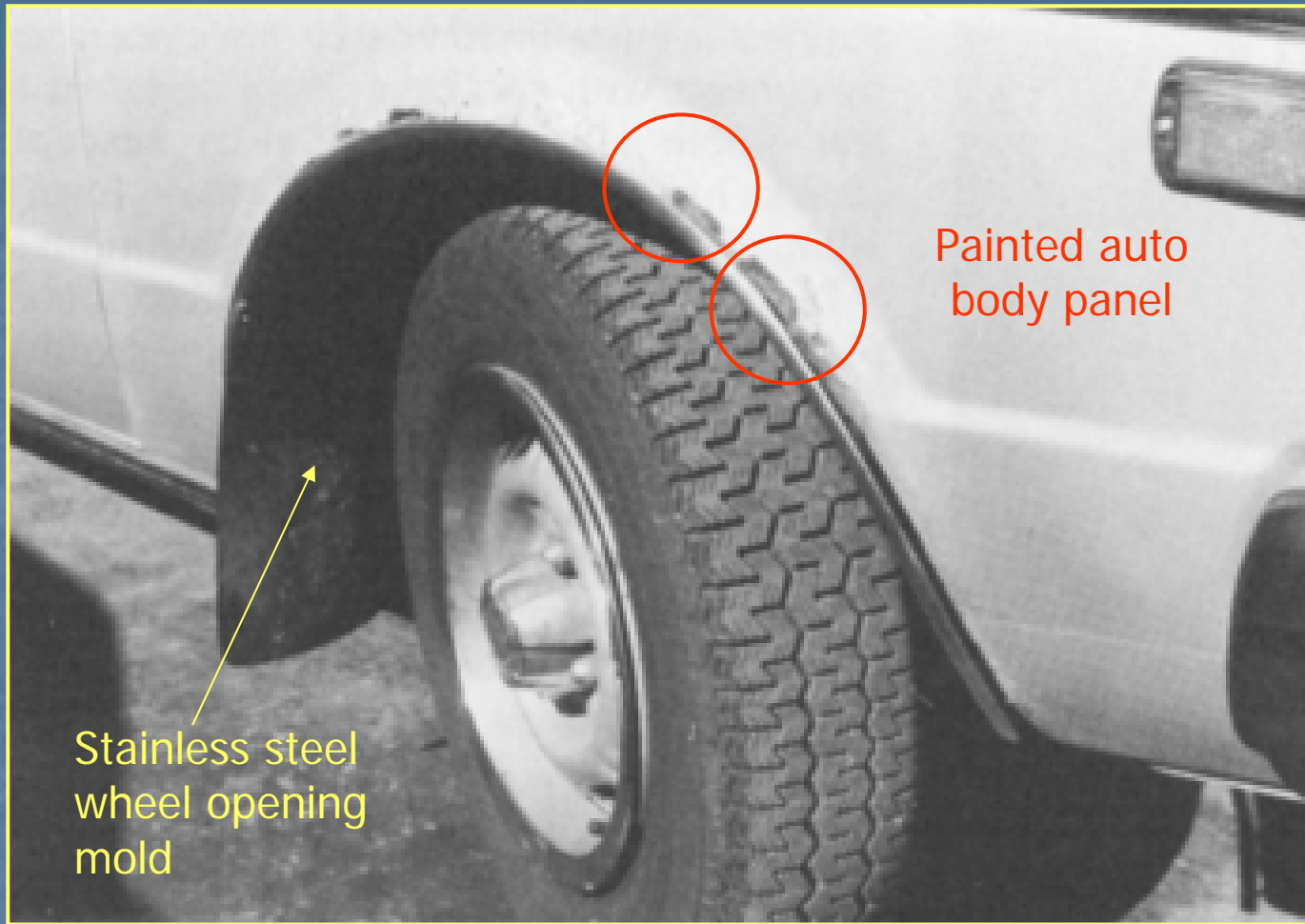

Galvanic corrosion of painted steel auto body panel in contact with stainless steel wheel opening molding



Galvanic corrosion of steel pipe at brass fitting in humid marine atmosphere

Crevice corrosion



Crevice Corrosion

- ❖ Crevice corrosion - corrosion in occluded regions, is one of the most damaging forms of material degradation.
- ❖ Intense localized corrosion frequently occurs within crevices and other shielded areas on metal surfaces exposed to corrosive environment
- ❖ Crevice corrosion occurs as a consequence of concentration differences of ions or dissolved gases in an electrolytic solution.

Crevice Corrosion

- ❖ Crevice corrosion attack is usually associated with small volumes of stagnant solution caused by holes, gasket surfaces, lap joints, surface deposits, and crevices under bolt and rivet heads
- ❖ Solution trapped between a pipe and the flange - The stagnant liquid in the crevice eventually had a lowered dissolved oxygen concentration and crevice corrosion took over and destroyed the flange
- ❖ In the absence of oxygen, the metal and/or its passive layer begin to oxidize

When crevice corrosion occurs?

- ❖ Crevice corrosion occurs when a wetted metallic surface is in close proximity to another surface

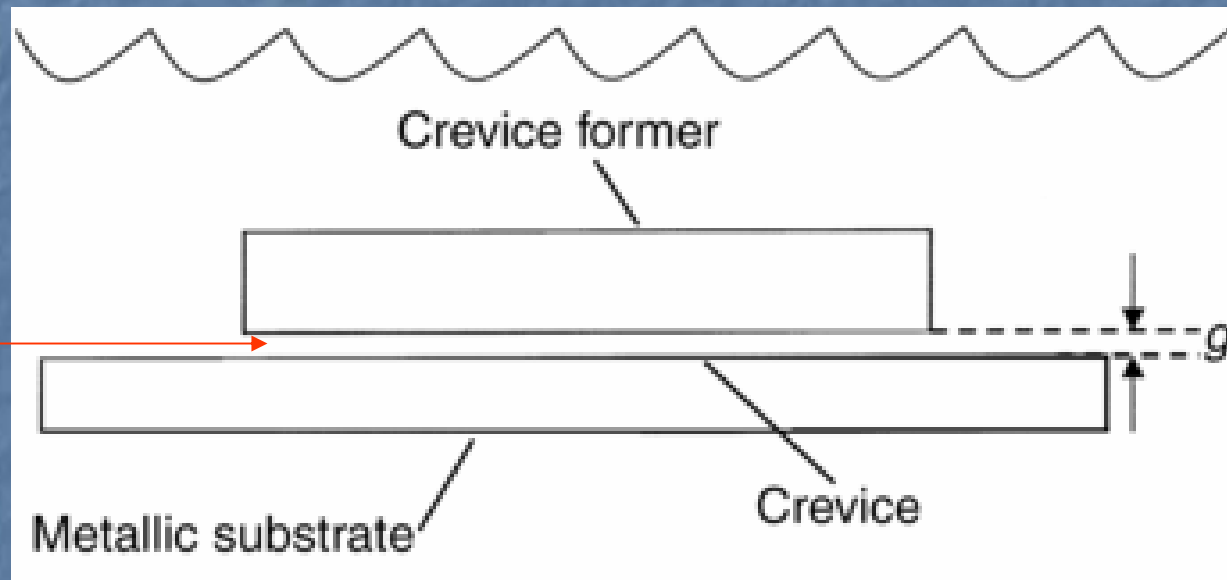

Geometry of crevice corrosion

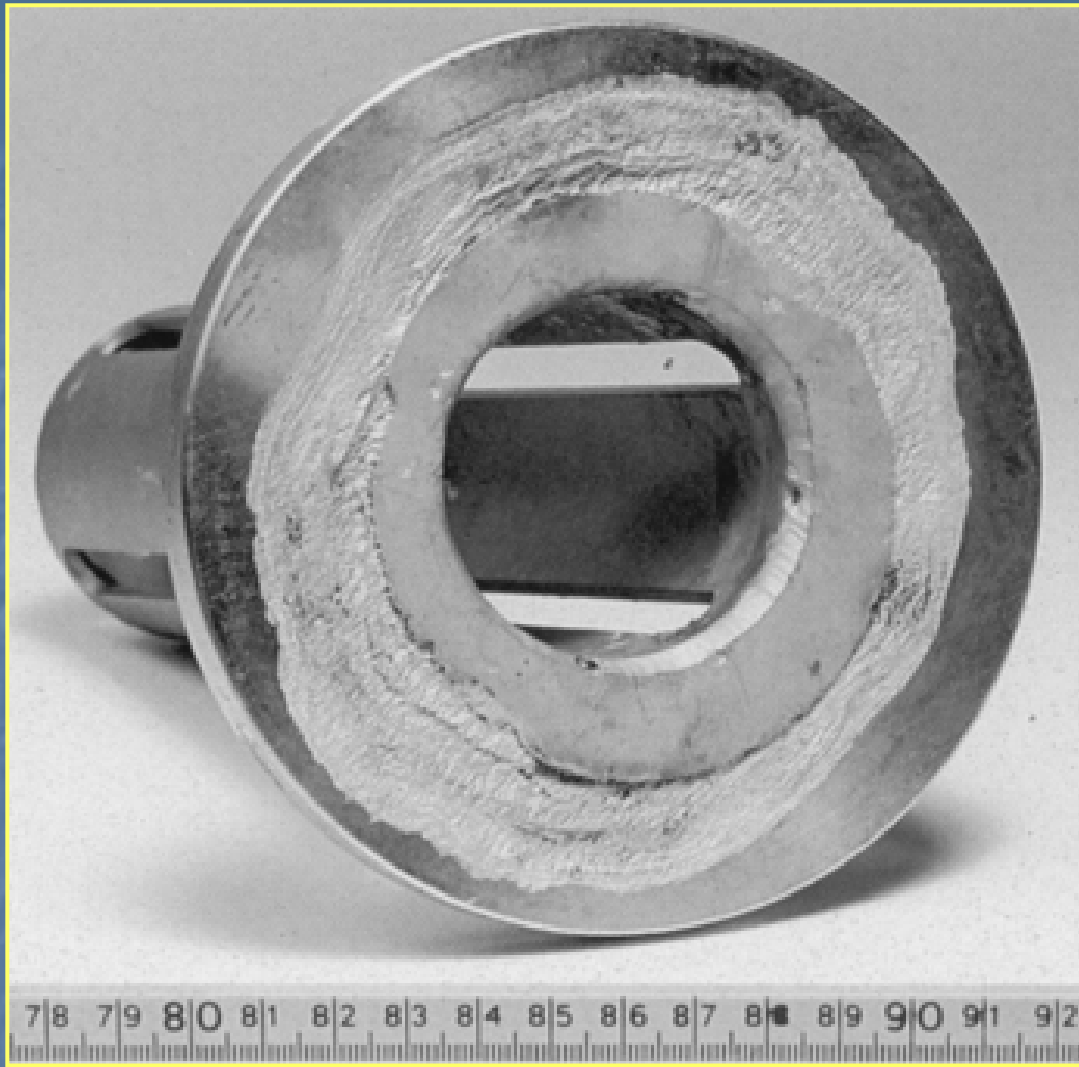

Crevice corrosion under seal in type 316 stainless steel sieve from steam condenser cooling water system exposed to flowing seawater for two years at less than 40 °C

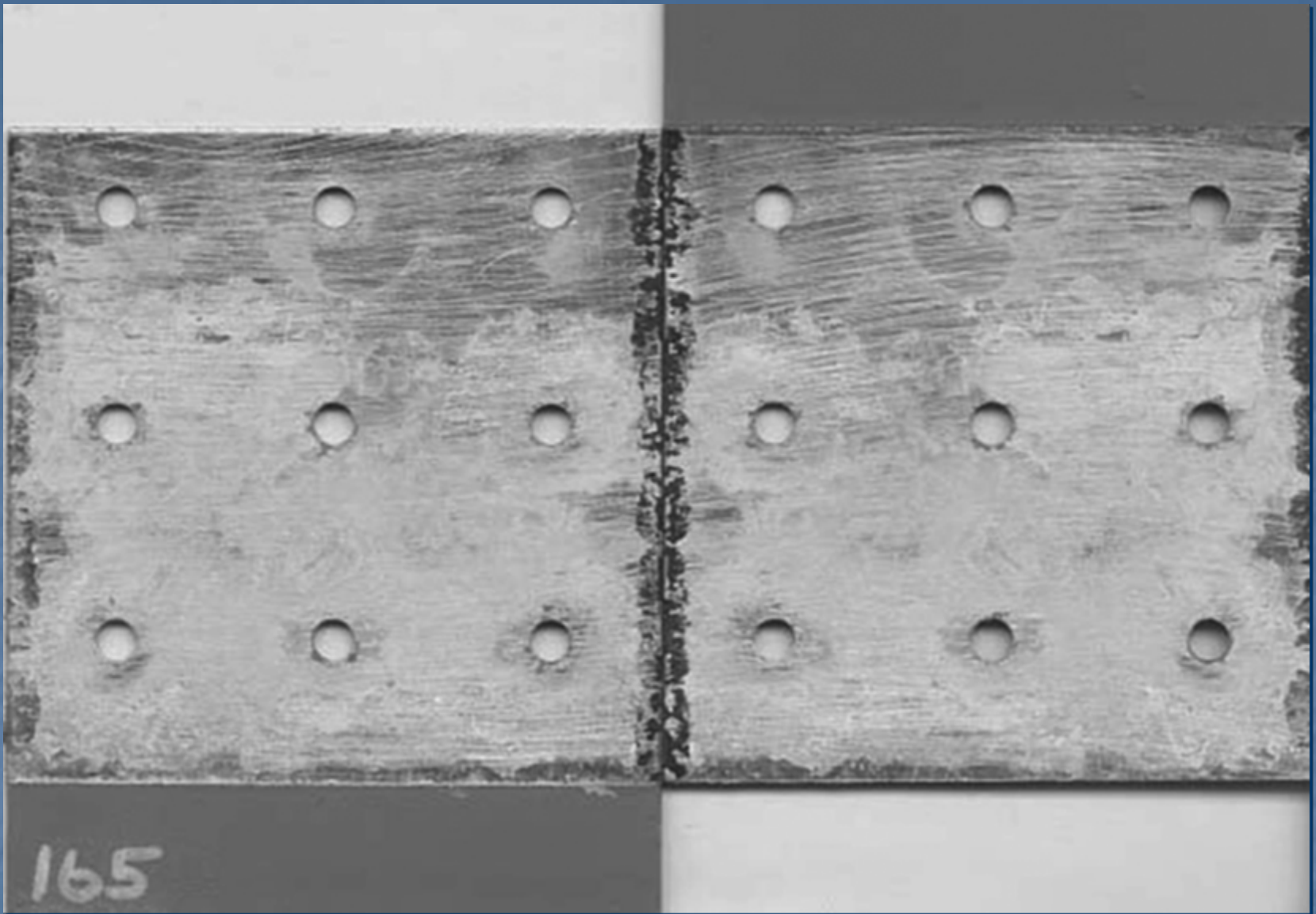

Crevice corrosion of aluminum, alloy 2024-T3 surfaces after three-month exposure to simulated lap-joint solution

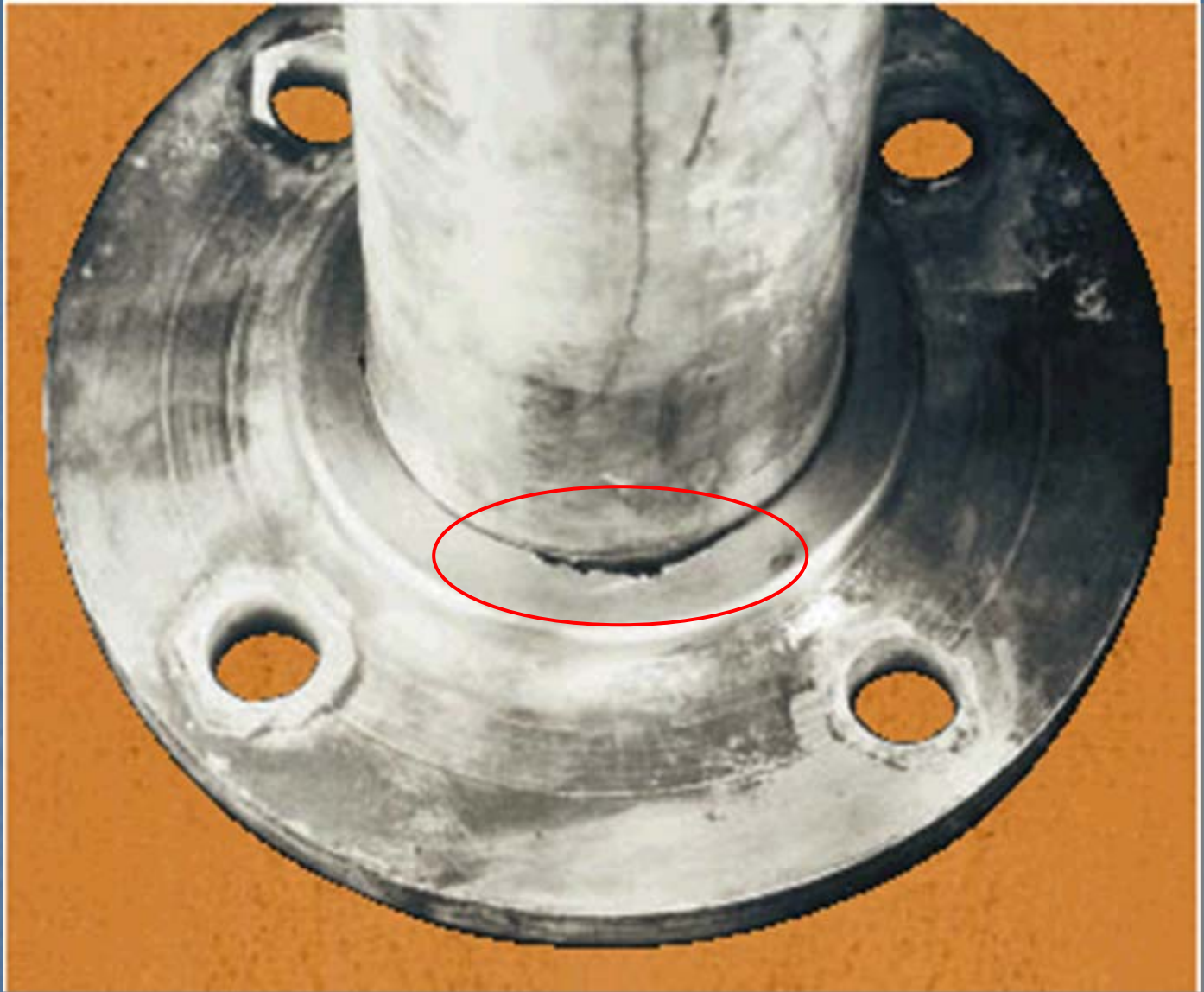

Crevice corrosion between a pipe and flange

Pitting corrosion



Corrosion of a metal surface, confined to a point or small area, that takes the form of cavities

Pitting corrosion

- ❖ Pitting corrosion is a localized form of corrosion by which cavities or "holes" are produced in the material
- ❖ These holes may be small or large in diameter, but in most cases they are relatively small.
- ❖ Pits are sometimes isolated or so close together that they look like a rough surface.
- ❖ Pitting is one of the most destructive and insidious forms of corrosion and failures often occur with extreme suddenness.
- ❖ Pitting is considered to be more dangerous than uniform corrosion damage because it is more difficult to detect - small size and often covered with corrosion products

Pitting corrosion

- ❖ A small, narrow pit with minimal overall metal loss can lead to the failure of an entire engineering system.
- ❖ It is difficult to measure quantitatively and compare the extent of pitting because of the varying depths and numbers of pits that may occur under identical conditions.
- ❖ Pitting can go on undetected for extended periods of time, until a failure occurs.
- ❖ Example – Stainless steel in sea water
- ❖ Pitting would overrun stainless steel in a matter of weeks due to its very poor resistance to chlorides, which are notorious for their ability to initiate pitting corrosion

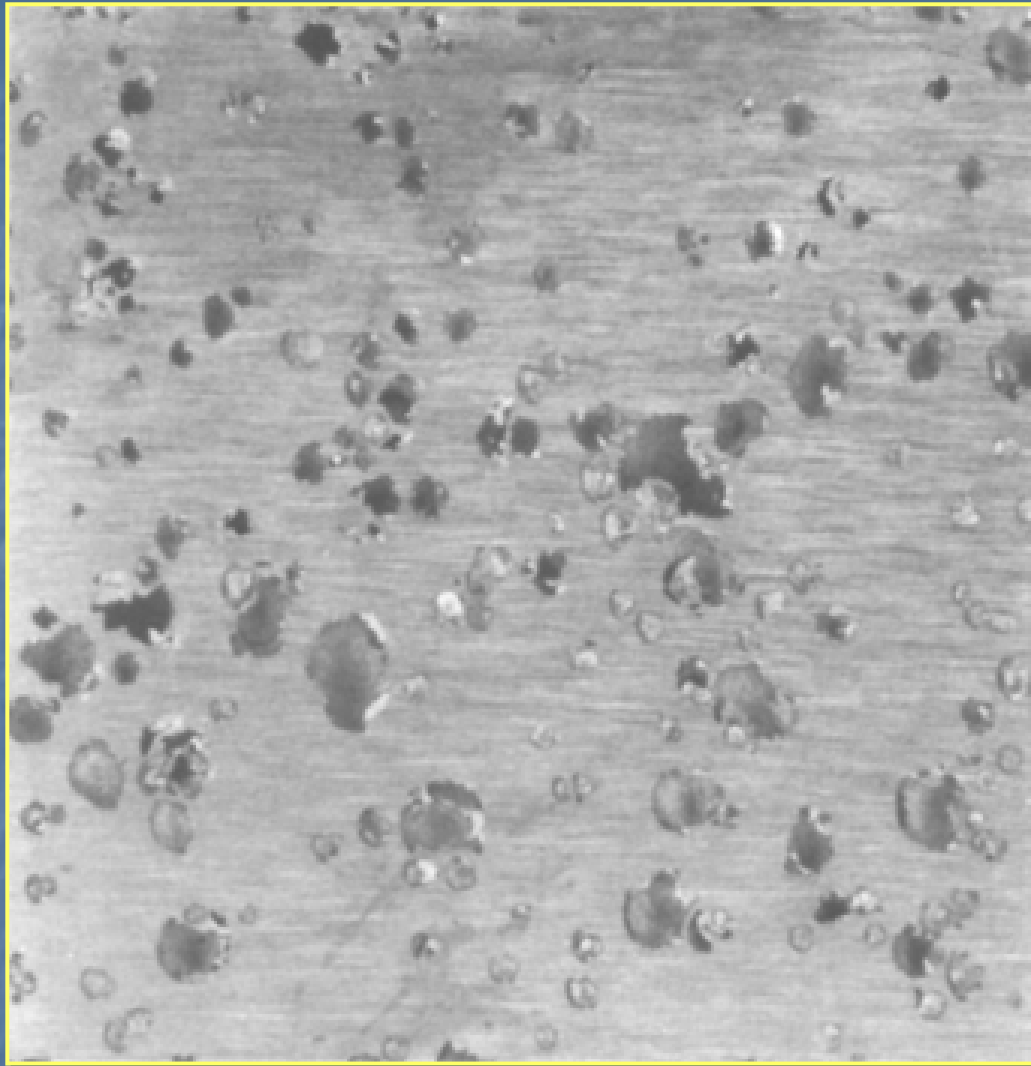

Deep pits in a metal



Pitting corrosion in a stainless steel water jug

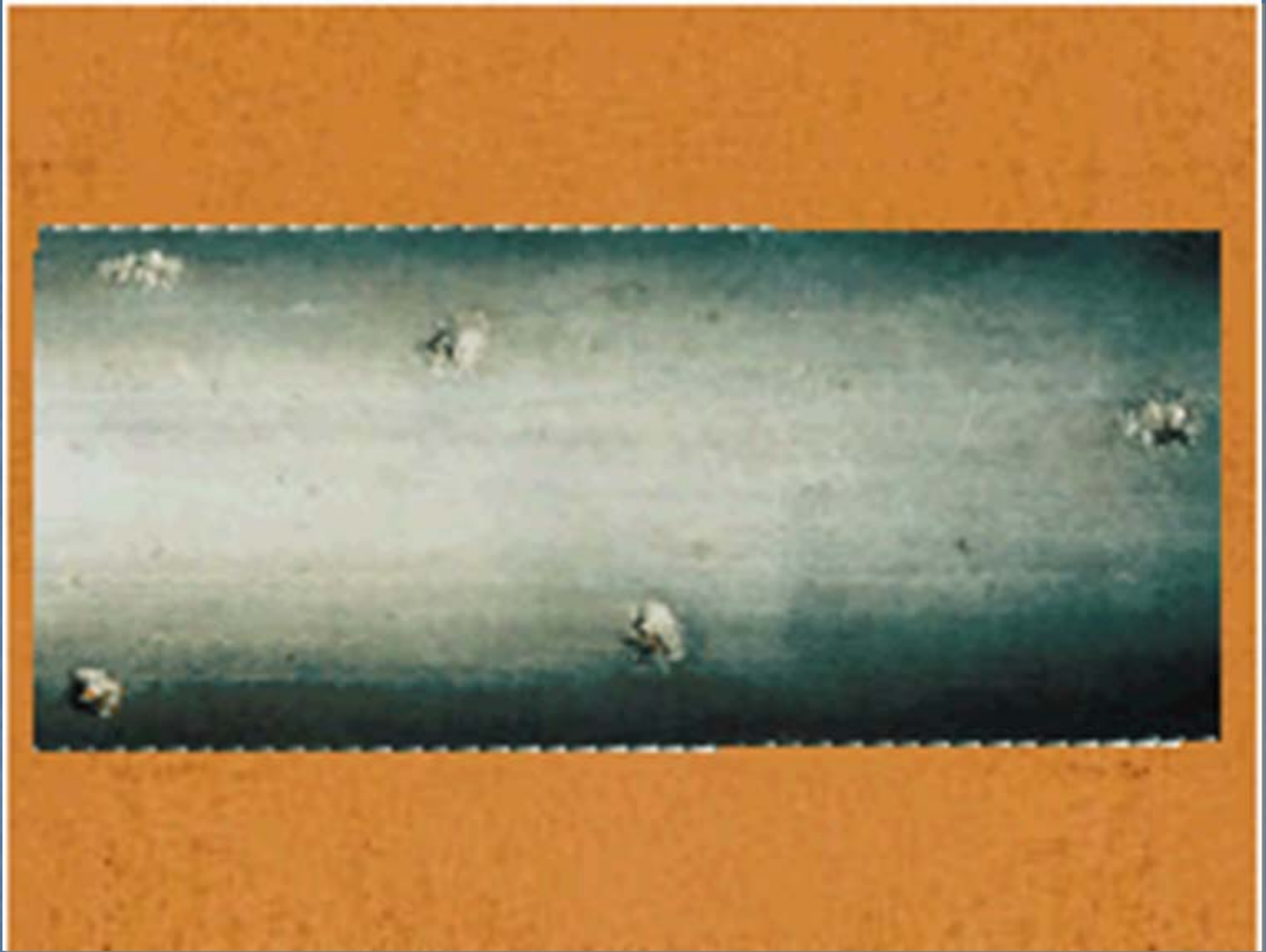

Pitting corrosion in a stainless steel tube

Intergranular Corrosion

- ❖ The microstructure of metals and alloys is made up of grains, separated by grain boundaries

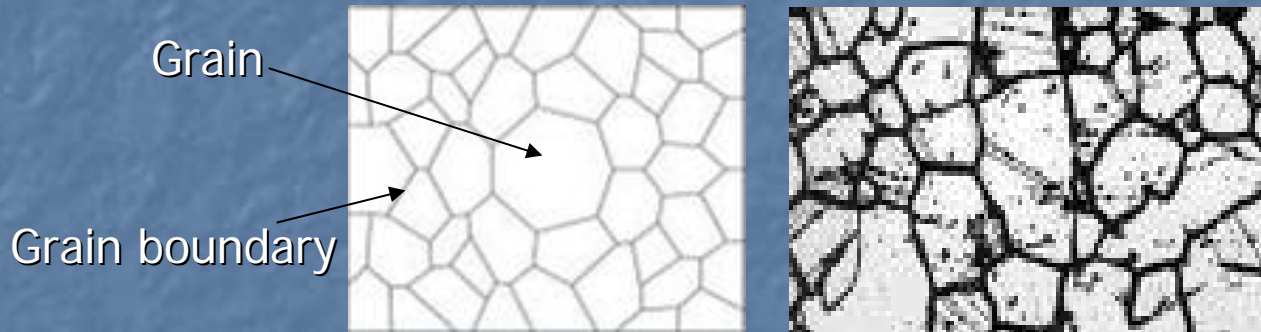

- ❖ Intergranular corrosion is localized corrosion attack which occurs along the grain boundaries, or immediately adjacent to grain boundaries, while the bulk of the grains remain largely unaffected
- ❖ The alloy disintegrates (grains fall out) and/or loses its strength.

Intergranular Corrosion

- ❖ Intergranular corrosion can be caused
 - ❖ by impurities at the grain boundaries
 - ❖ enrichment or depletion of one of the alloying elements in the grain-boundary areas
 - ❖ Small amounts of Fe in Al wherein the solubility of Fe is low, have been shown to segregate in the grain boundaries and cause intergranular corrosion.
 - ❖ Depletion of Cr in the grain-boundary regions results in intergranular corrosion – sensitization of SS

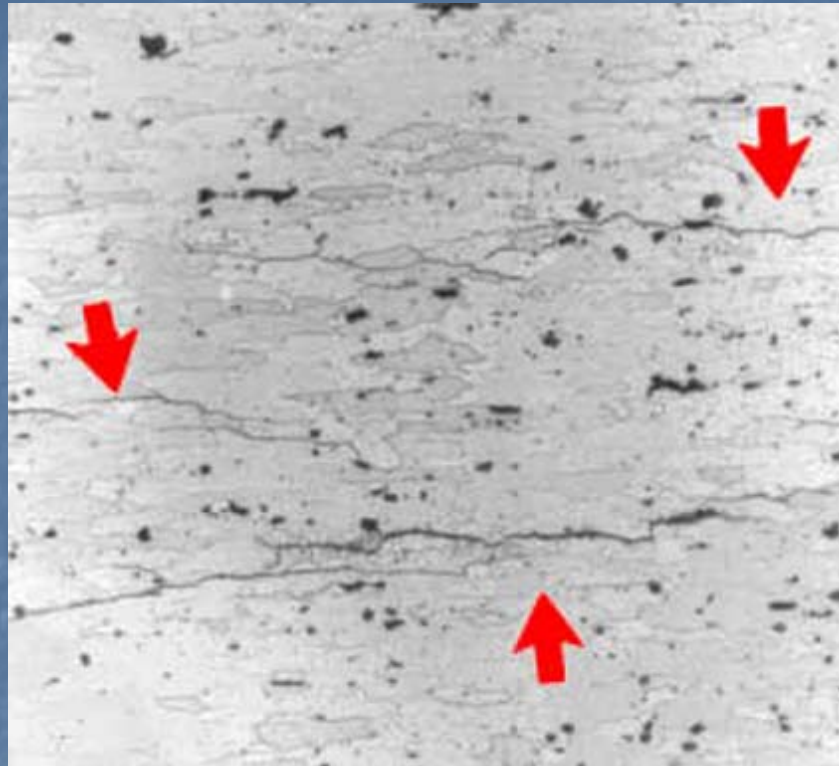

Intergranular corrosion of a failed aircraft component made of 7075-T6 aluminum (picture width: 500 μm)

Dealloying (selective leaching)

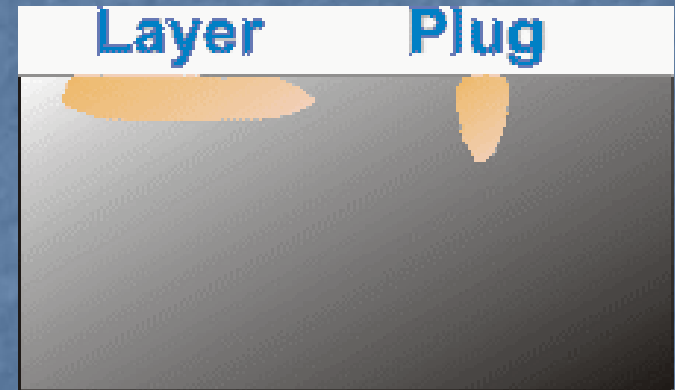

Dealloying or selective leaching

- ❖ Dealloying or selective leaching refers to the selective removal of one element from an alloy by corrosion
- ❖ A common example is the dezincification of brass, a copper-zinc alloy
- ❖ Copper-zinc alloys containing more than 15% zinc are susceptible to dezincification
- ❖ During dezincification, the more active zinc is selectively removed from the brass, leaving behind a weak deposit of the porous, more noble copper-rich metal.
- ❖ After leaching, the mechanical properties of brass gets impaired – cracking of the alloy
- ❖ Conditions favoring dezincification are contact with slightly acid or alkaline water

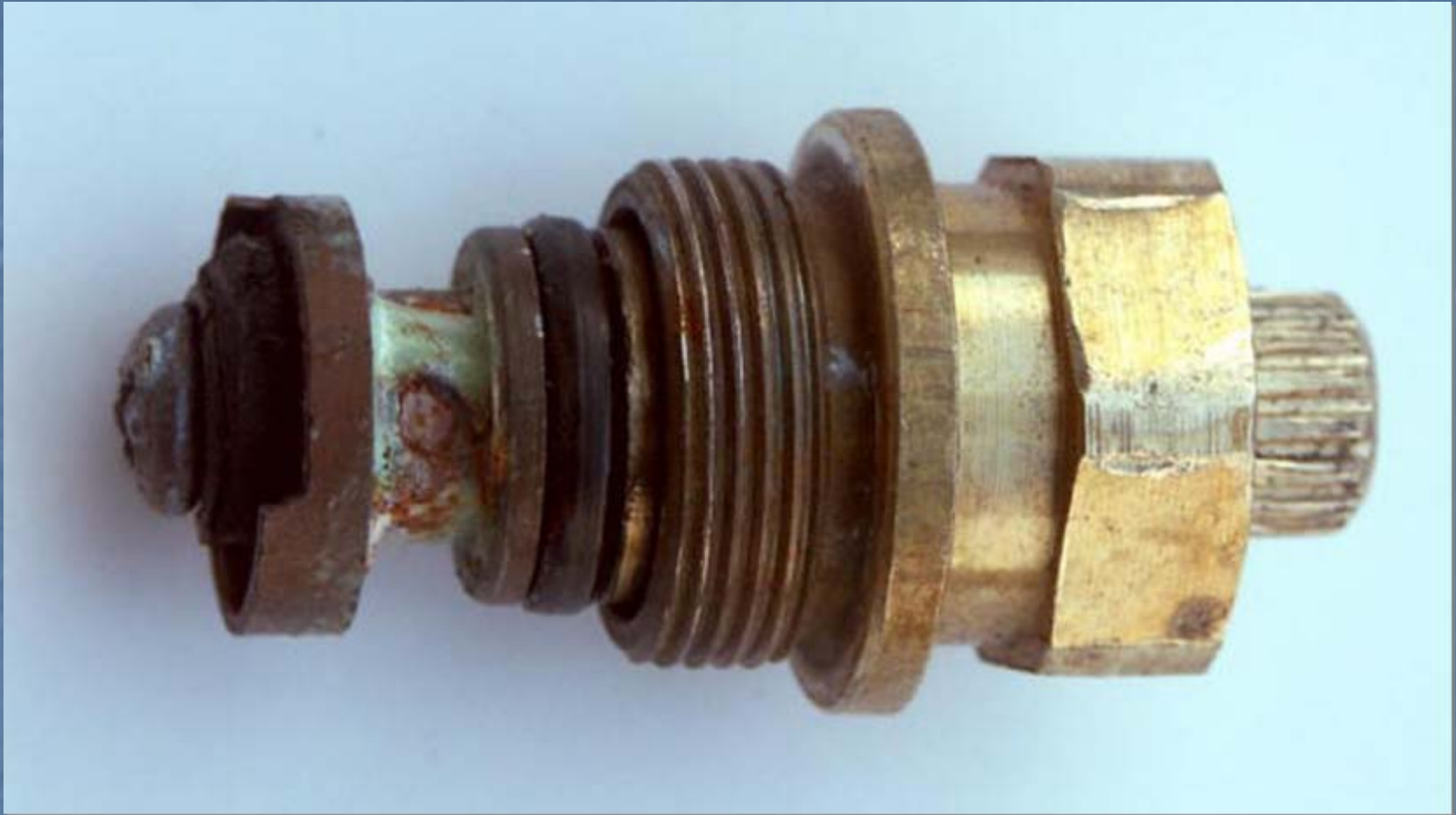

Dezincification of a Brass Valve

Types of dezincification

- ❖ **Plug-type dezincification** is localized and the surrounding surfaces are mostly unaffected by corrosion
- ❖ This type of dezincification penetrates deeply into the sidewalls of valves and fittings
- ❖ Common failures associated with plug-type attack include penetration through the sidewalls that causes water seepage or loss of mechanical strength in threaded sections to the point of fracture.
- ❖ **Uniform-layer dezincification** leaches zinc from a broad area of the surface
- ❖ This type of dezincification uniformly reduces the wall thickness of the valve or fitting.

Uniform-layer dezincification



Plug-type dezincification

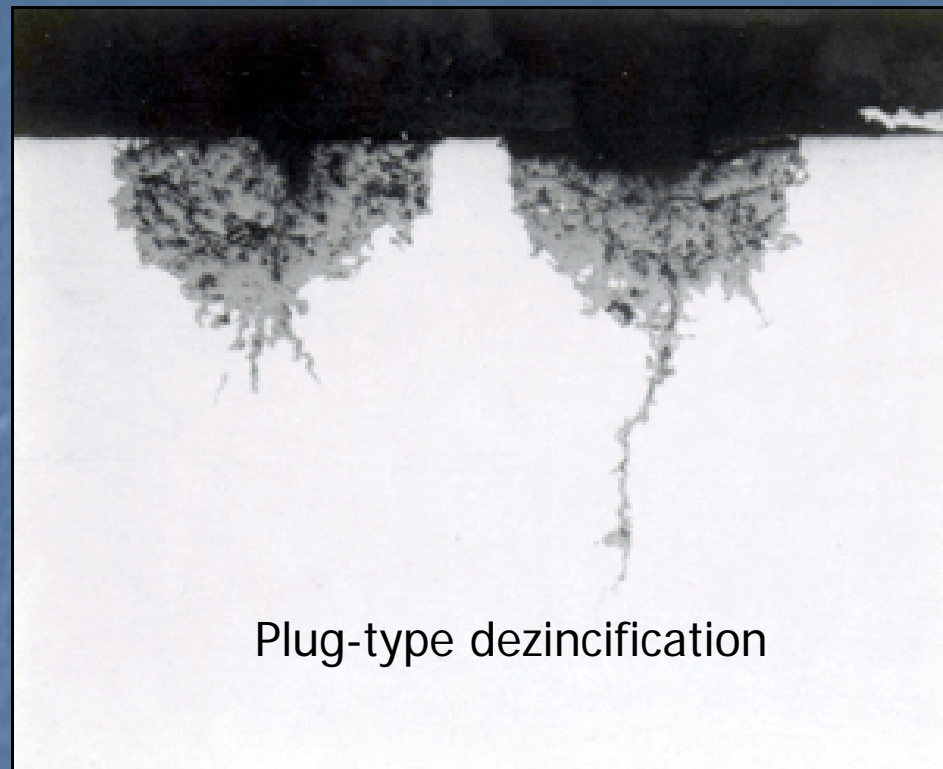

Erosion corrosion

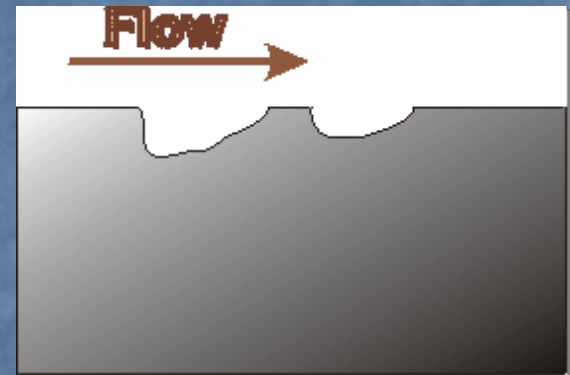

Erosion Corrosion

- ❖ Acceleration in rate of corrosion attack in metal due to the relative motion of a corrosive fluid/metal surface
- ❖ Arises from a combination of chemical attack and the physical abrasion as a consequence of the fluid motion.
- ❖ Characterized in appearance by grooves, gullies, waves, rounded holes, and valleys and usually exhibits a directional pattern.
- ❖ Failures - relatively short time, and they are unexpected
- ❖ All types of metals and alloys are susceptible for erosion-corrosion

Erosion Corrosion

- ❖ Erosion-corrosion is most prevalent in soft alloys (i.e. copper, aluminum and lead alloys)
- ❖ Materials rely on a passive layer are especially sensitive to erosion-corrosion (stainless steel and titanium)
- ❖ Once the passive layer has been removed, the bare metal surface is exposed to the corrosive material. If the passive layer cannot be regenerated quickly significant damage can be seen.
- ❖ If the fluids contain suspended solids, then the erosion-corrosion rate will be significantly high.



corrosion-doctors.org

Erosion corrosion of a brass tube in flowing seawater

Stress-corrosion cracking

- ❖ Cracking induced due to the combined influence of tensile stress and a corrosive medium
- ❖ Some materials become susceptible to SCC in a given environment once a tensile stress is applied.
- ❖ The tensile stresses may be in the form of directly applied stresses or in the form of residual stresses
- ❖ Once the stress cracks begin, they easily propagate throughout the material, which in turn allows additional corrosion and cracking to take place.
- ❖ All cracking failures that occur in corrosive medium can not be considered as stress-corrosion cracking since hydrogen embrittlement also leads to cracking

Stress-corrosion cracking

- ❖ During SCC, the metal or alloy is virtually unattacked over most of its surface, while fine cracks progress through it.
- ❖ Cold deformation and forming, welding, heat treatment, machining and grinding can introduce residual stresses. The magnitude and importance of such stresses is often underestimated
- ❖ SCC usually occurs in certain specific alloy-environment-stress combinations.
- ❖ SCC is classified as a catastrophic form of corrosion, as the detection of such fine cracks can be very difficult and the damage not easily predicted
- ❖ A disastrous failure may occur unexpectedly, with minimal overall material loss.



Stress corrosion cracking (SCC) of an aircraft component



Stress Corrosion Cracking in a bronze component

most of the surface
remains unattacked



cracks can have an
intergranular
or a transgranular
morphology



The micrograph on the right (X500) illustrates intergranular SCC of an Inconel heat exchanger tube with the crack following the grain boundaries



SCC in a 316 stainless steel chemical processing piping system
Chloride stress corrosion cracking in austenitic SS is characterized
by the multi-branched "lightning bolt" transgranular crack pattern

Type of stress corrosion cracking

- ❖ Chloride SCC – Nuclear industry
- ❖ Austenitic stainless steel under tensile stress in the presence of oxygen, chloride ions, and high temperature.
- ❖ Chromium carbide deposits along grain boundaries that leave the metal open to corrosion
- ❖ This form of corrosion is controlled by maintaining low chloride ion and oxygen content in the environment and use of low carbon steels.
- ❖ Caustic SCC – Inconel and steel

Effective means of preventing SCC

- ❖ The most effective means of preventing SCC are:
- ❖ Choose the right materials
- ❖ Reduce stresses
- ❖ Remove critical environmental species such as hydroxides, chlorides, and oxygen
- ❖ Avoid stagnant areas and crevices in heat exchangers where chloride and hydroxide might become concentrated

Cavitation and Impingement

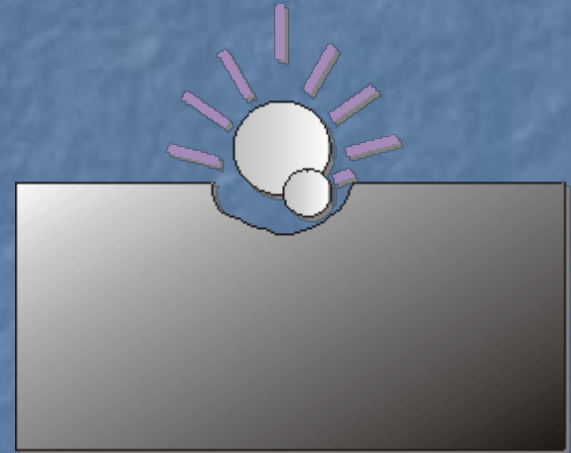

Cavitation

- ❖ Cavitation occurs when a fluid's operational pressure drops below its vapor pressure causing gas pockets and bubbles to form and collapse
- ❖ Cavitation can occur in a rather explosive and dramatic fashion
- ❖ The locations where cavitation is most likely to occur:
 - ❖ At the suction of a pump, especially if operating near the net positive suction head required (NPSHR)
 - ❖ At the discharge of a valve or regulator, especially when operating in a near-closed position
 - ❖ At other geometry-affected flow areas such as pipe elbows and expansions
 - ❖ By processes incurring sudden expansion, which can lead to dramatic pressure drops

Cavitation

- ❖ This form of corrosion will eat out the volutes and impellers of centrifugal pumps with ultra pure water as the fluid.
- ❖ It will eat valve seats
- ❖ It will contribute to other forms of erosion corrosion, such as found in elbows and tees.
- ❖ Cavitation should be designed out by reducing hydrodynamic pressure gradients and designing to avoid pressure drops below the vapor pressure of the liquid and air ingress.
- ❖ The use of resilient coatings and cathodic protection can also be considered as supplementary control methods.

Impingement

- ❖ Impingement attack is related to cavitation damage, and has been defined as 'localized erosion-corrosion caused by turbulence or impinging flow
- ❖ Entrained air bubbles tend to accelerate this action, as do suspended solids
- ❖ This type of corrosion occurs in pumps, valves, orifices, on heat-exchanger tubes, and at elbows and tees in pipelines.
- ❖ Impingement corrosion usually produces a pattern of localized attack with directional features. The pits or grooves tend to be undercut on the side away from the source of flow, in the same way that a sandy river bank at a bend in the river is undercut by the oncoming water.

Impingement

- ❖ When a liquid is flowing over a surface (e.g. in a pipe), there is usually a critical velocity below which impingement does not occur and above which it increases rapidly
- ❖ Impingement attack first received attention due to the poor behavior of some copper alloys in seawater.
- ❖ In practice, impingement and cavitation may occur together, and the resulting damage can be the result of both
- ❖ Impingement may damage a protective oxide film and cause corrosion, or it may mechanically wear away the surface film to produce a deep groove.



Cavitation corrosion of a deaerator

Corrosion-fatigue

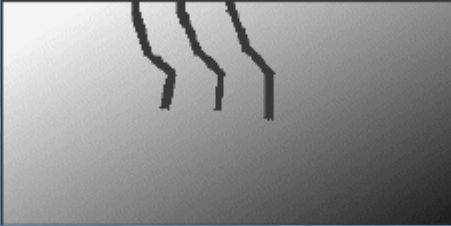

- ❖ Corrosion-fatigue is the result of the combined action of an alternating or cycling stresses and a corrosive environment
- ❖ The fatigue process is thought to cause rupture of the protective passive film, upon which corrosion is accelerated
- ❖ If the metal is simultaneously exposed to a corrosive environment, the failure can take place at even lower loads and after shorter time.

Other types of corrosion

- Hydrogen embrittlement - The embrittlement of a metal or alloy by atomic hydrogen involves the ingress of hydrogen into a component, an event that can seriously reduce the ductility and load-bearing capacity, cause cracking and catastrophic brittle failures
- Fretting corrosion
- Stray current corrosion

Potential-pH diagrams

Limitations of EMF series

- ❖ Prediction of corrosion only based on EMF series has very severe limitations
- ❖ EMF series does not account for the effect of films which may form on metals under a variety of conditions

Potential-pH diagrams

- ❖ The principle of potential-pH diagrams was established in the 1940s in Belgium by Marcel Pourbaix
- ❖ In 1945, Marcel Pourbaix submitted a Ph.D. dissertation entitled “Thermodynamics in dilute solutions: graphical representation of the role of pH and potential”, which was initially rejected
- ❖ It is also called as Pourbaix diagram
- ❖ Phase diagram – Temperature – composition diagram - Metallurgy or Materials science
- ❖ Pourbaix diagram – Electrochemistry



Marcel Pourbaix and U.R. Evans

Potential-pH diagrams

- ❖ It provides a useful means of summarizing the thermodynamic behavior of a metal and associated species in given environmental conditions.
- ❖ It is a graphical representation - relation between the pH and the equilibrium potentials (E) of the most probable electrochemical reactions occurring in a solution containing a specific element
- ❖ E -pH diagrams are typically plotted for various equilibria with potential (E) as the ordinate (y axis) and pH as the abscissa (X axis)

Potential-pH diagrams

- ❖ Three types of lines exist on Pourbaix diagrams
- ❖ Horizontal lines describe reactions that are dependent only on potential (e.g., $\text{Fe} = \text{Fe}^{2+} + 2\text{e}^-$)
- ❖ Vertical lines describe reactions that are dependent only on pH (e.g., $\text{Fe}^{2+} + 2\text{OH}^- = \text{Fe}(\text{OH})_2$)
- ❖ Angled lines correspond to reactions that depend on both potential and pH (e.g., $\text{O}_2 + 4\text{H}^+ + 4\text{e}^- = 2\text{H}_2\text{O}$)

Potential-pH diagrams

- ❖ Potential- pH diagrams synthesize many important types of information that are useful in corrosion and in other fields.
- ❖ They make it possible to discern at a glance the stable species for specific conditions of potential and pH
- ❖ Thermodynamic data can be used to map out the occurrence of corrosion, passivity, and nobility of a metal as a function of pH and potential

E-pH (Pourbaix) diagram for water

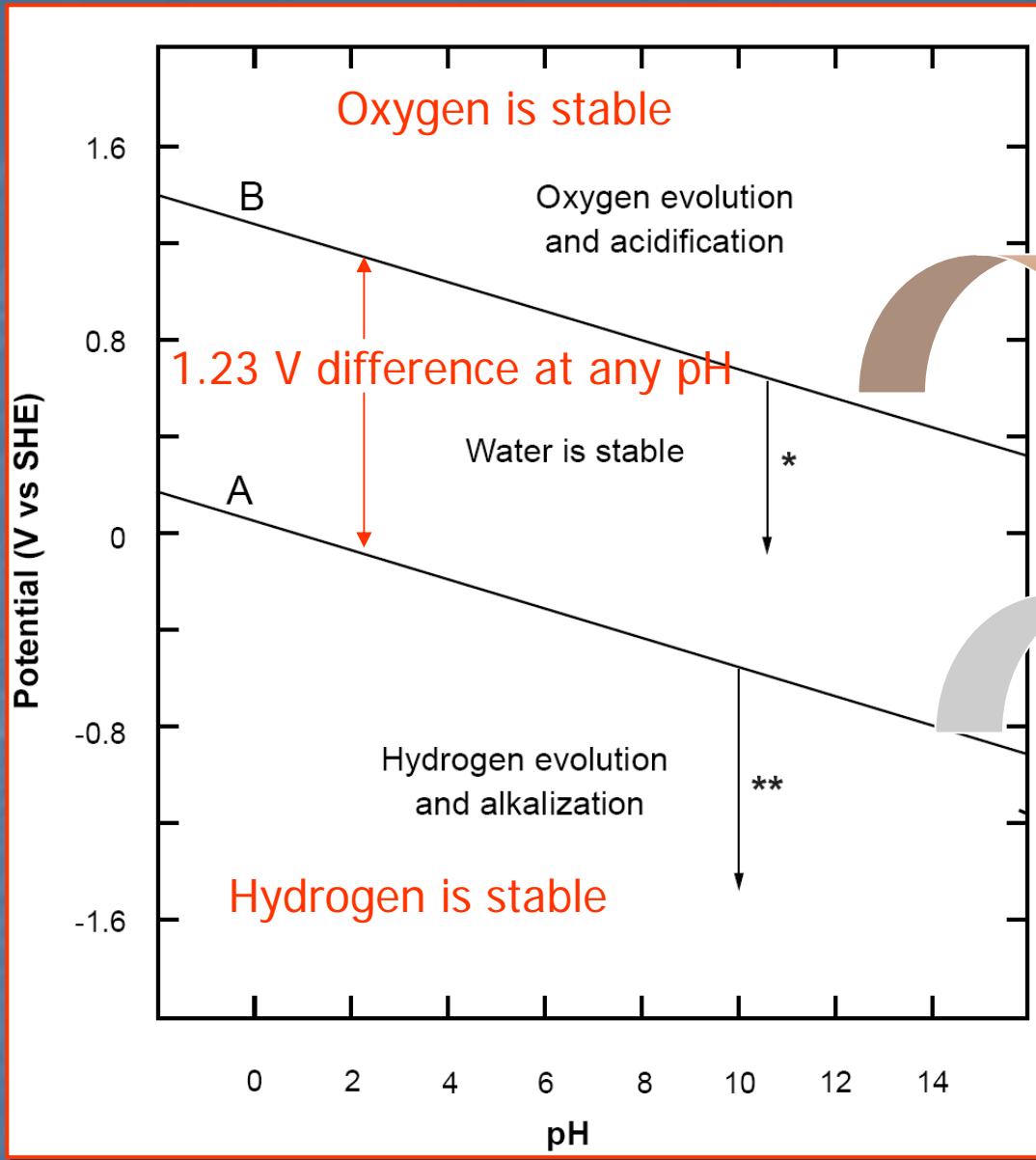

Equilibrium line for the reaction:
 $2\text{H}_2\text{O} \longrightarrow \text{O}_2 + 5\text{H}^+ + 4\text{e}^-$

Equilibrium line for the reaction:
 $\text{H}_2 \longrightarrow 2\text{H}^+ + 2\text{e}^-$

* indicates increasing thermodynamic driving force for cathodic oxygen reduction

** indicates increasing thermodynamic driving force for cathodic hydrogen evolution

Thermodynamic stability of water, oxygen, and hydrogen

Three possible states of a metallic material

❖ Immune region

- ❖ In this region a metal is considered to be totally immune from corrosion attack and safe to use.
- ❖ Cathodic protection may be used to bring the potential of a metal closer to the immune region by forcing a cathodic shift

❖ Passive region

- ❖ In such region a metal tends to become coated with an oxide or hydroxide that may form on the metal either as a compact and adherent film practically preventing all direct contact between the metal itself and the environment, or as a porous deposit which only partially prevents contact between the metal and the environment

❖ Corrosive region

- ❖ In such region, a metal is stable as an ionic (soluble) product and therefore susceptible to corrosion attack.

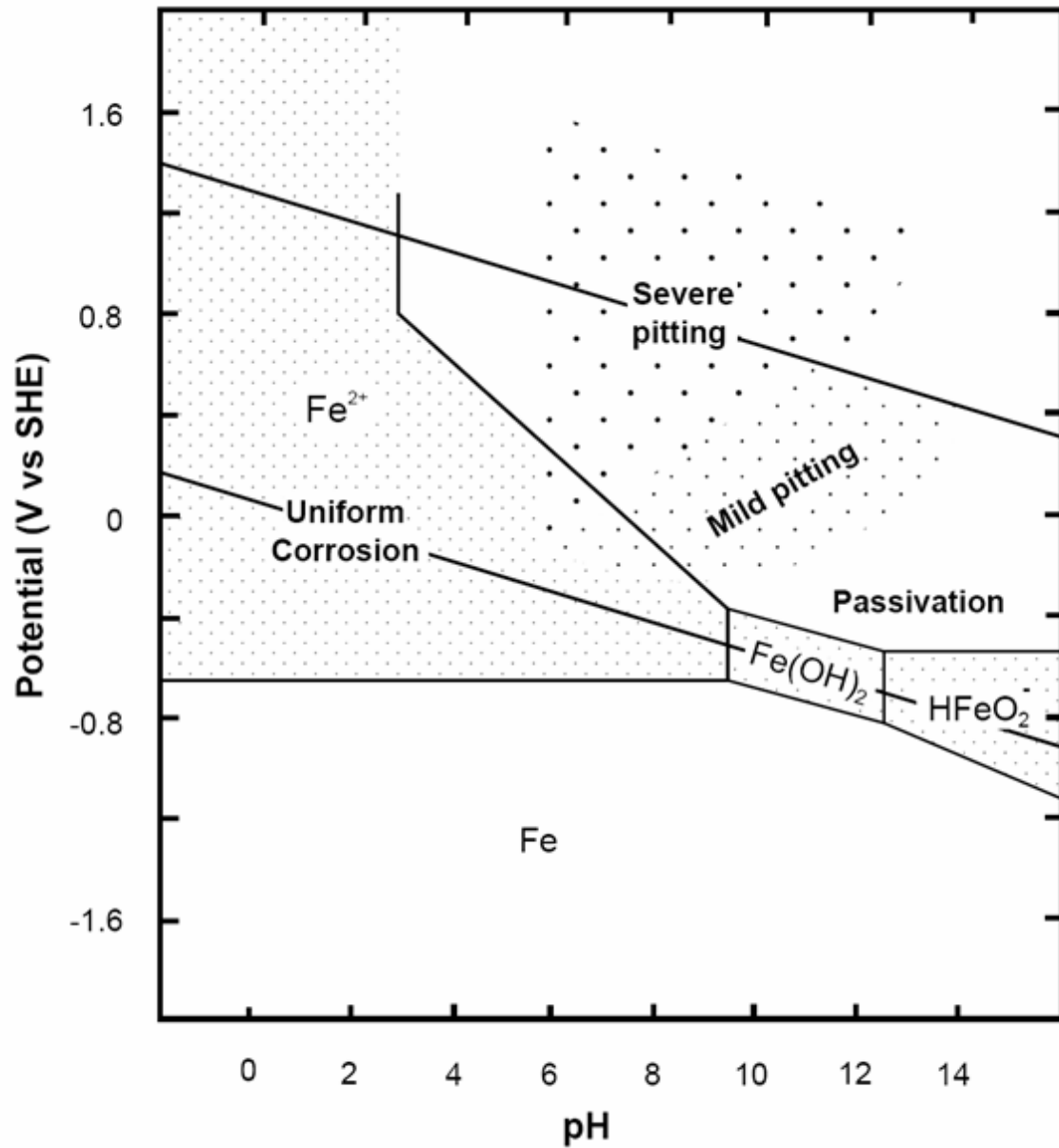

Thermodynamic boundaries of the types of corrosion observed on steel

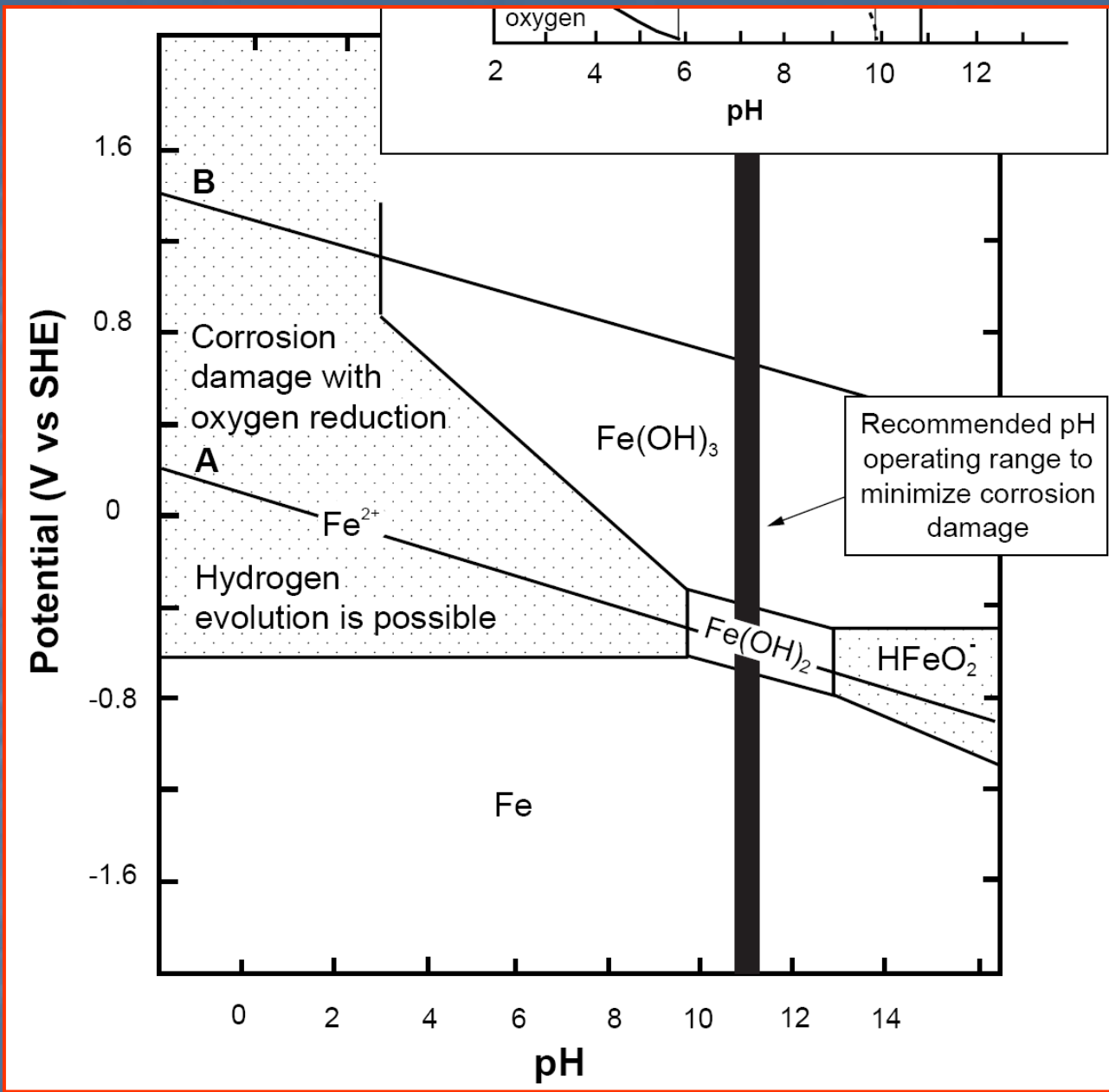

E-pH diagram of iron in water at 25°C

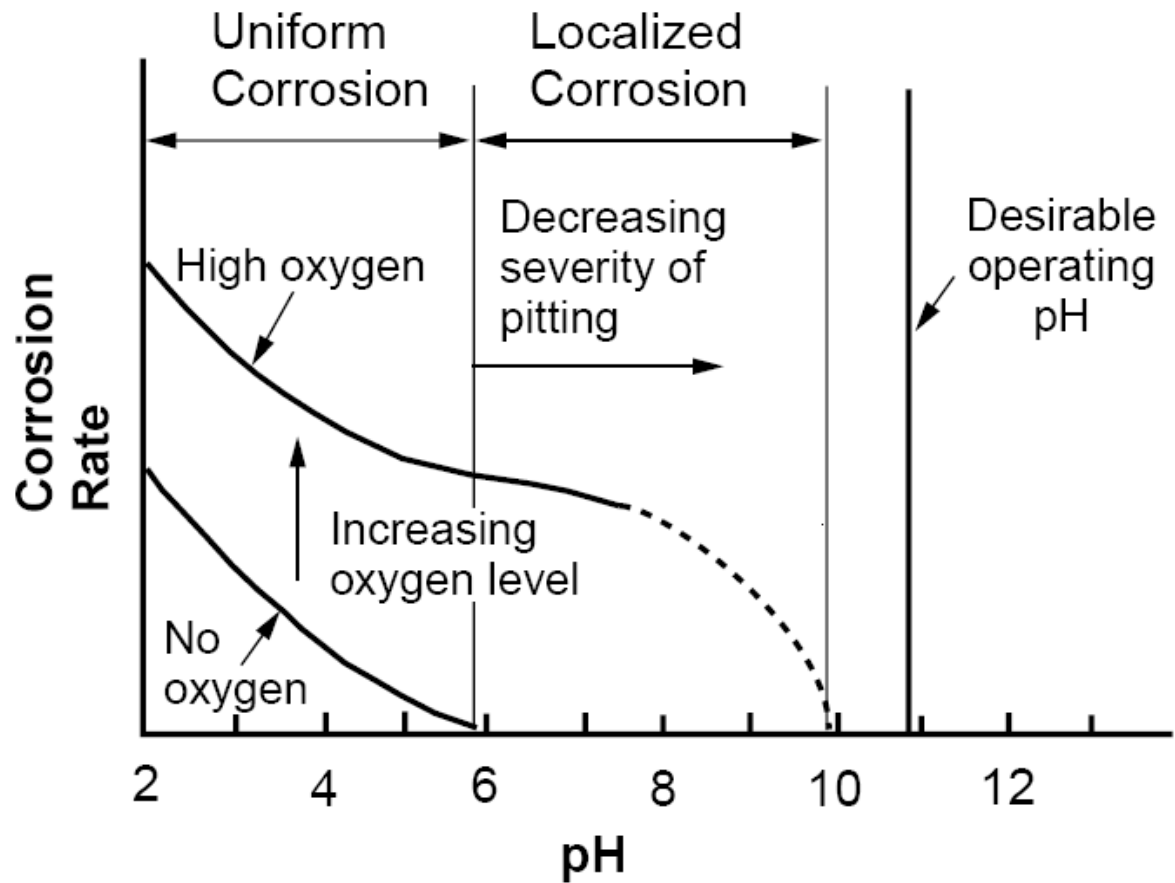

Corrosion behavior of iron in water at 25°C

Pourbaix Diagram for Iron

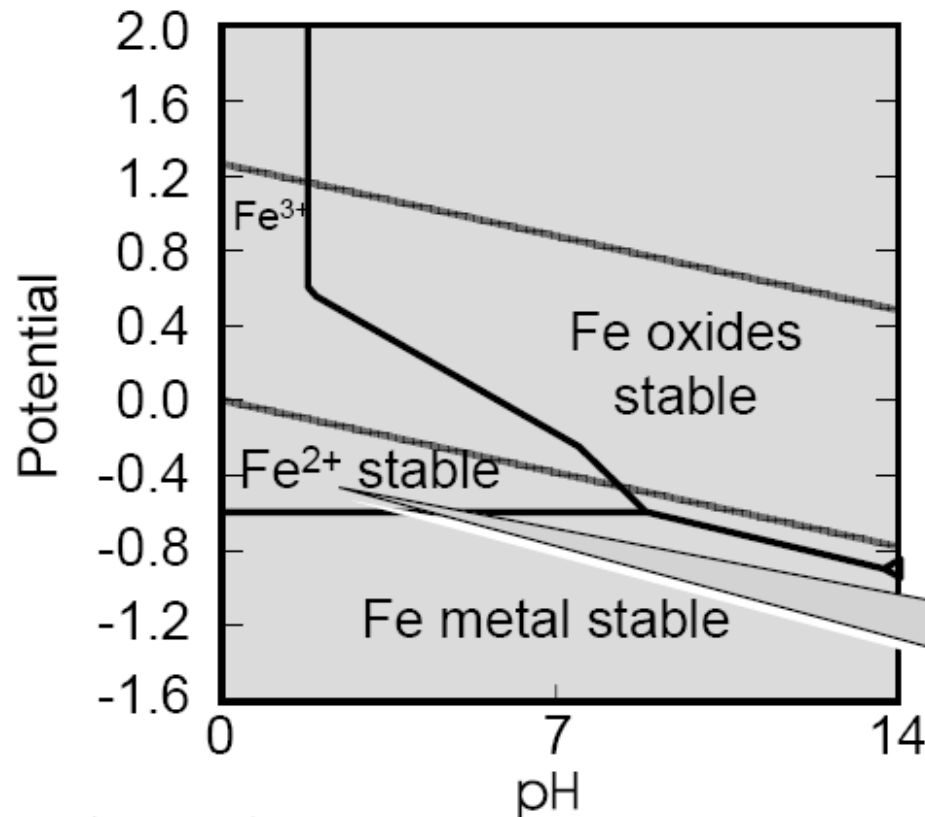

Will iron corrode in deaerated acid?

Yes - there is a reasonably wide range of potentials where hydrogen can be evolved and iron dissolved



Pourbaix Diagram for Iron

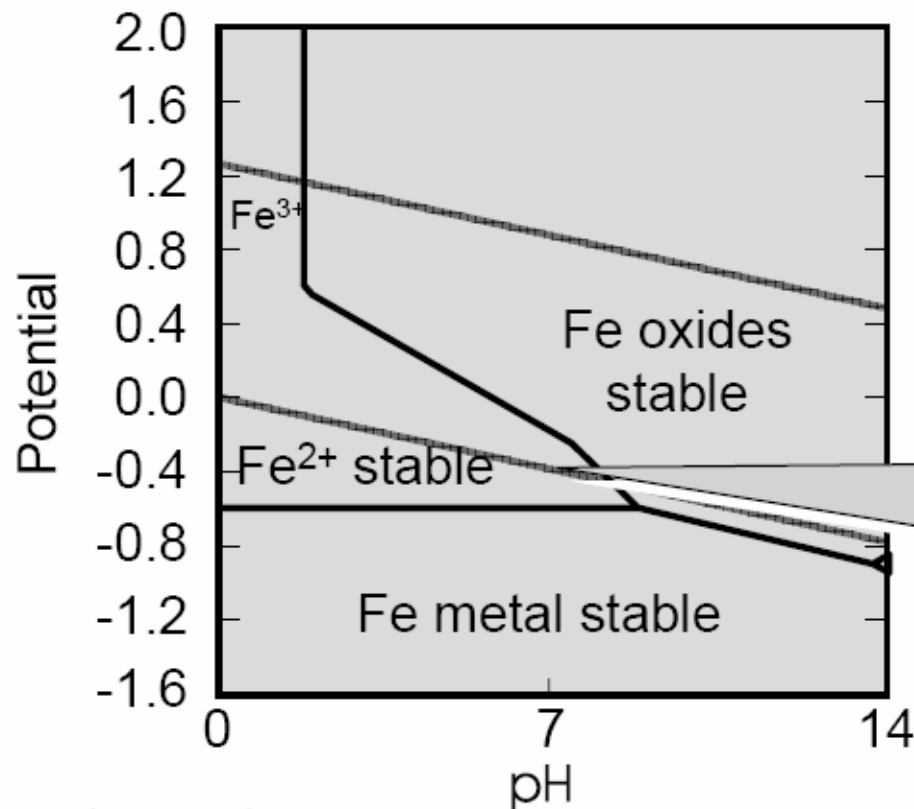

Will iron corrode in neutral waters?

Yes - although iron can form an oxide in neutral solution, it tends not to form directly on the metal, as the potential is too low, therefore it is not protective.



Pourbaix Diagram for Iron

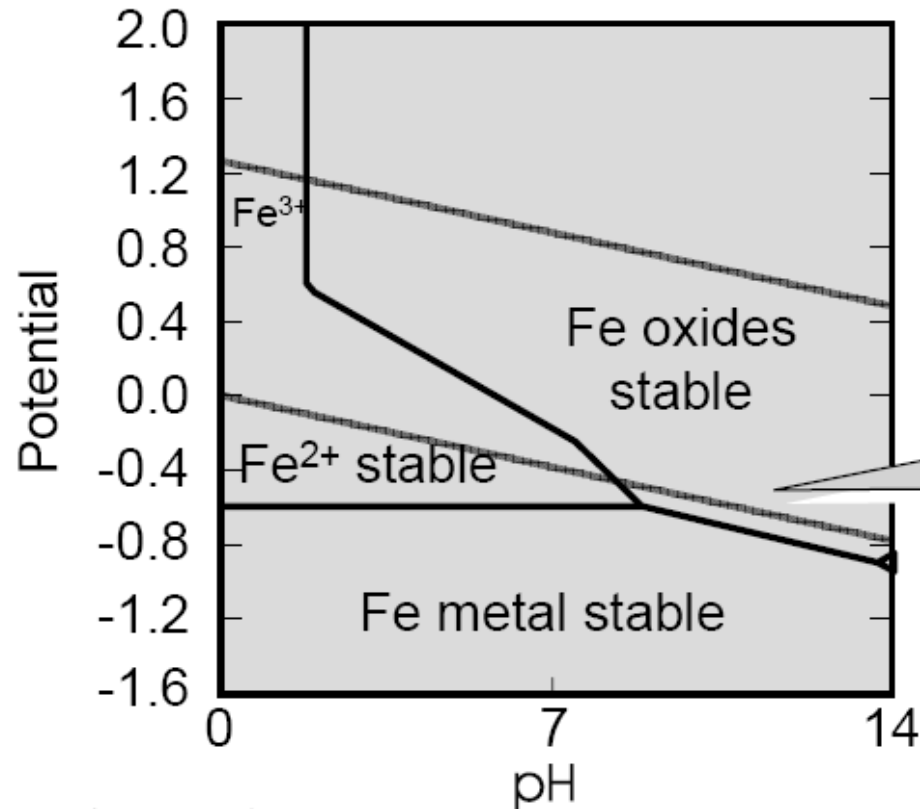

Will iron corrode in alkaline solutions?

No - iron forms a solid oxide at all potentials, and will passivate



Pourbaix Diagram for Zinc

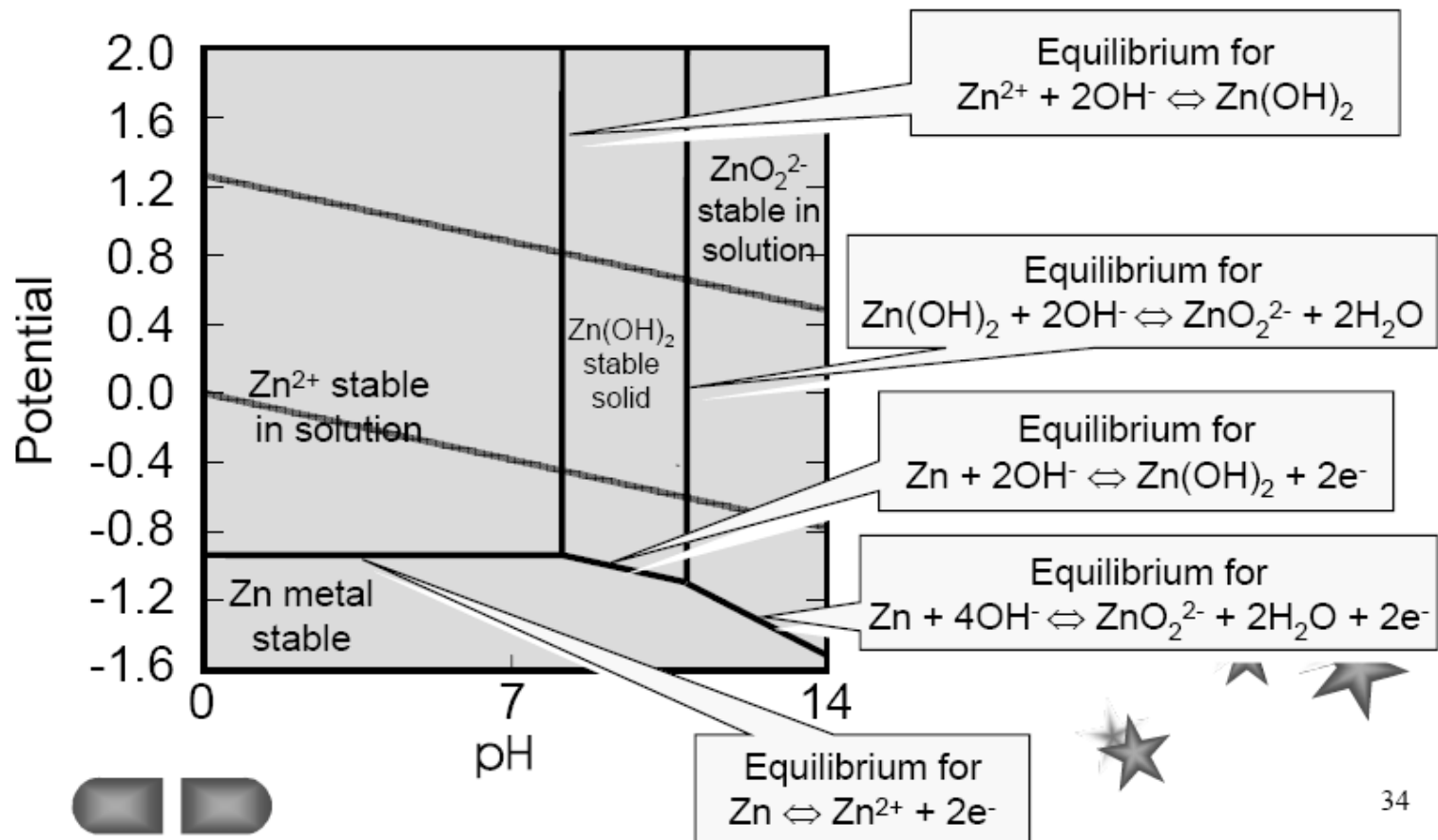

Pourbaix Diagram for Zinc

Corrosion requires strong oxidising agent

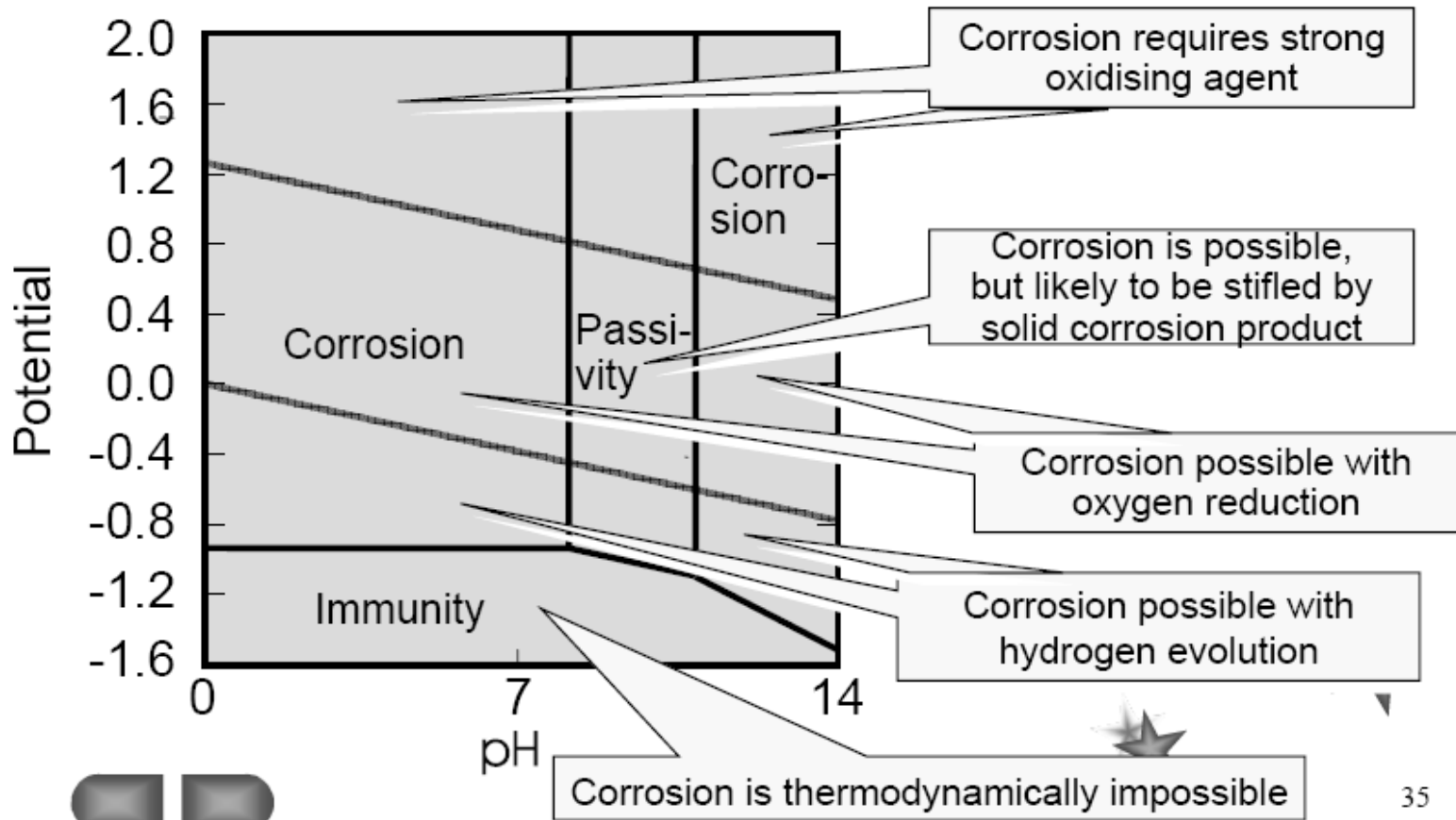

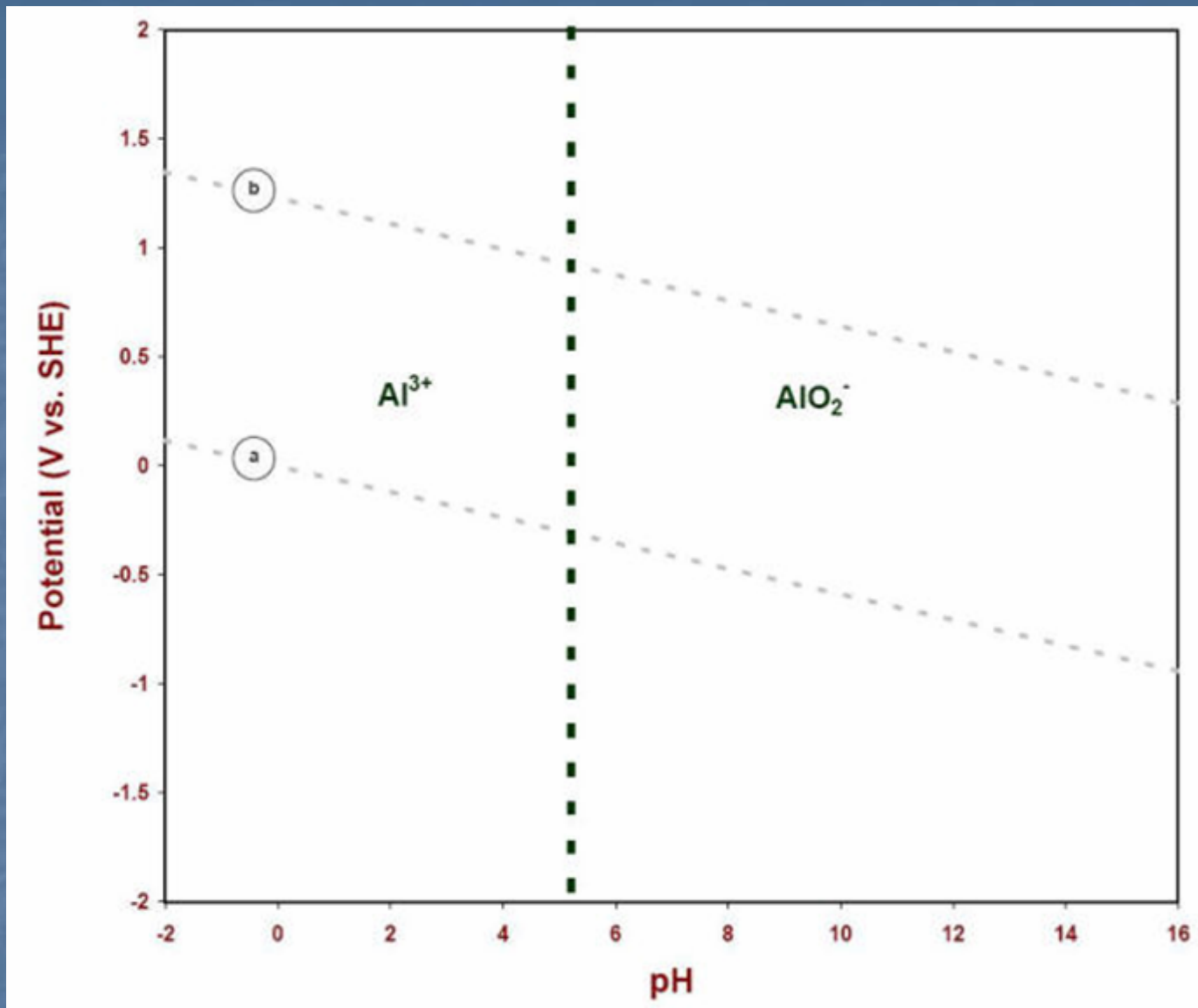

E-pH diagram showing the soluble species of aluminum in water at 25°C

Possible reactions in the Al-H₂O system

Equilibria involving aluminum metal

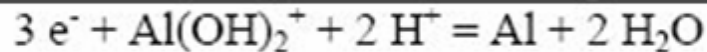
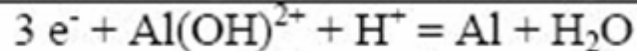
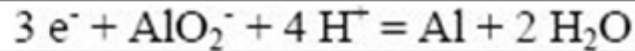
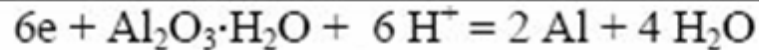
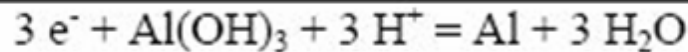

Equilibria involving solid forms of oxidized aluminum

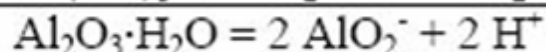
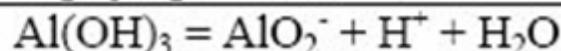
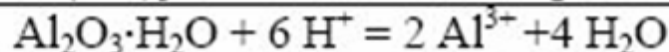
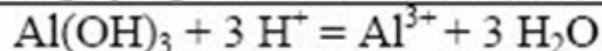
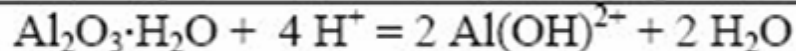
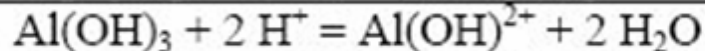
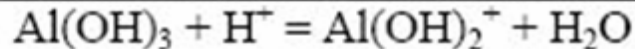

Equilibria involving only soluble forms of oxidized aluminum

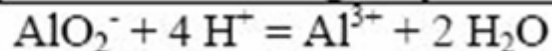

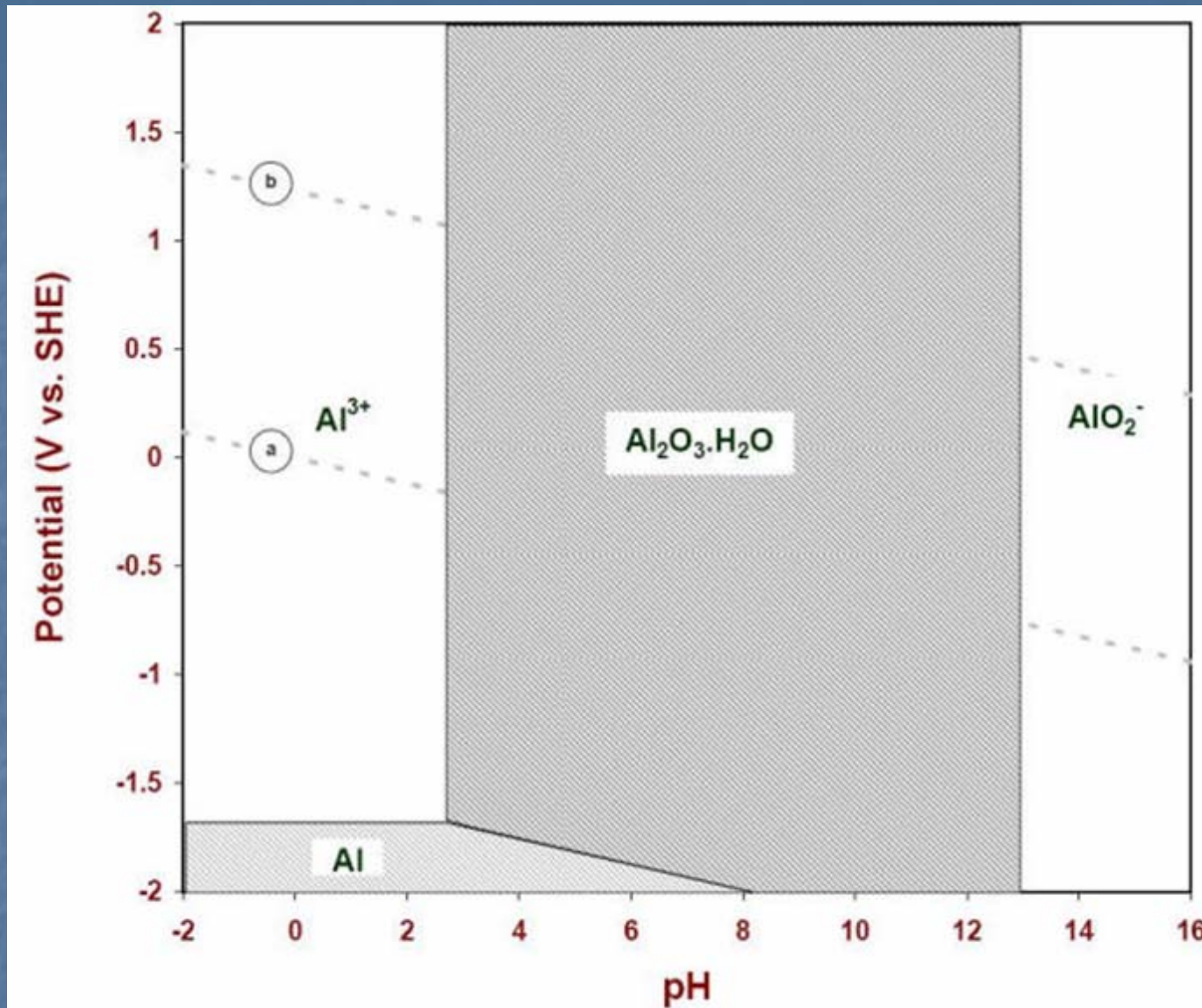

E-pH diagram of solid species of aluminum when the soluble species are at one molar concentration (25°C)

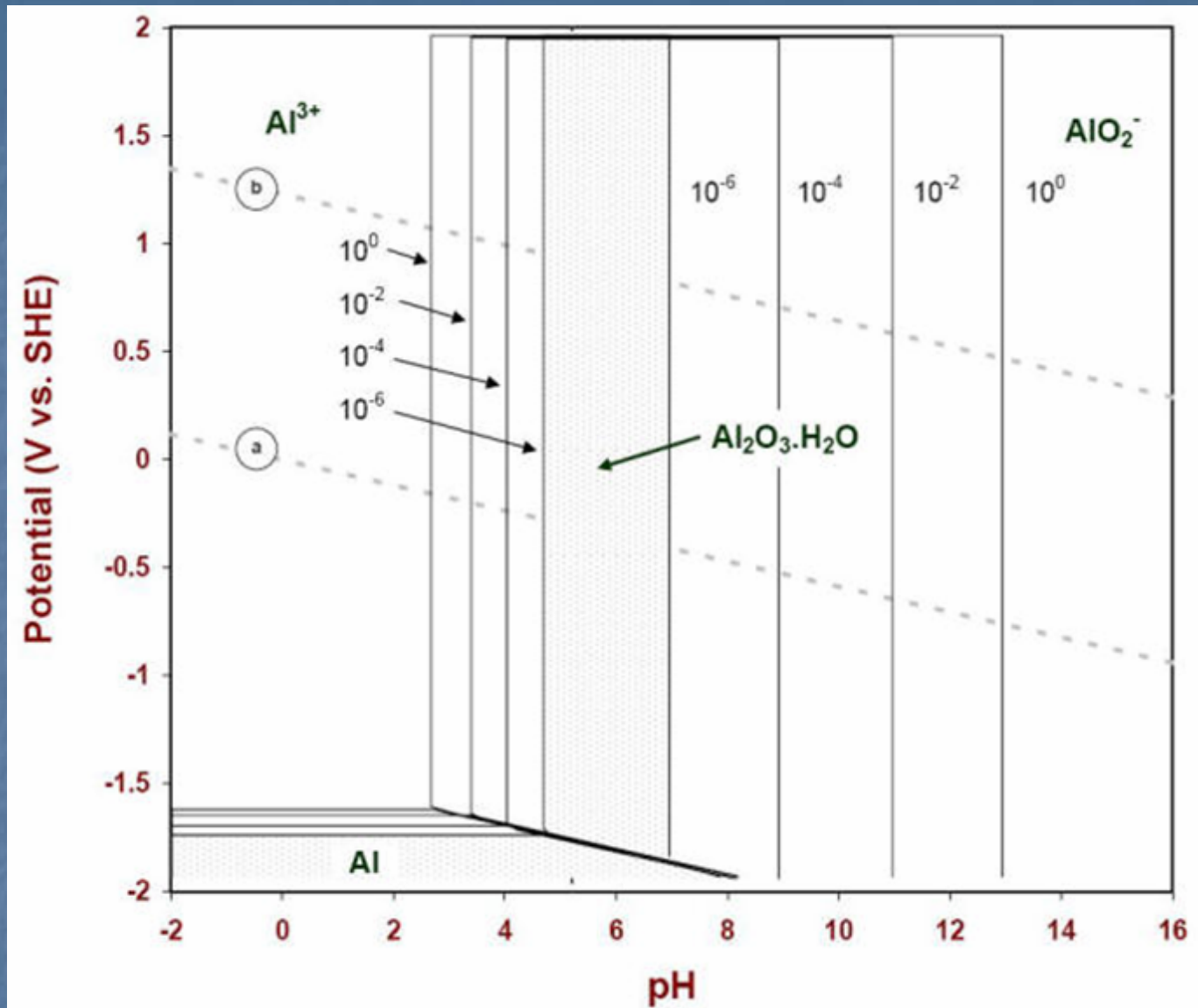

E-pH diagram of aluminum with four concentrations of soluble species (25°C)

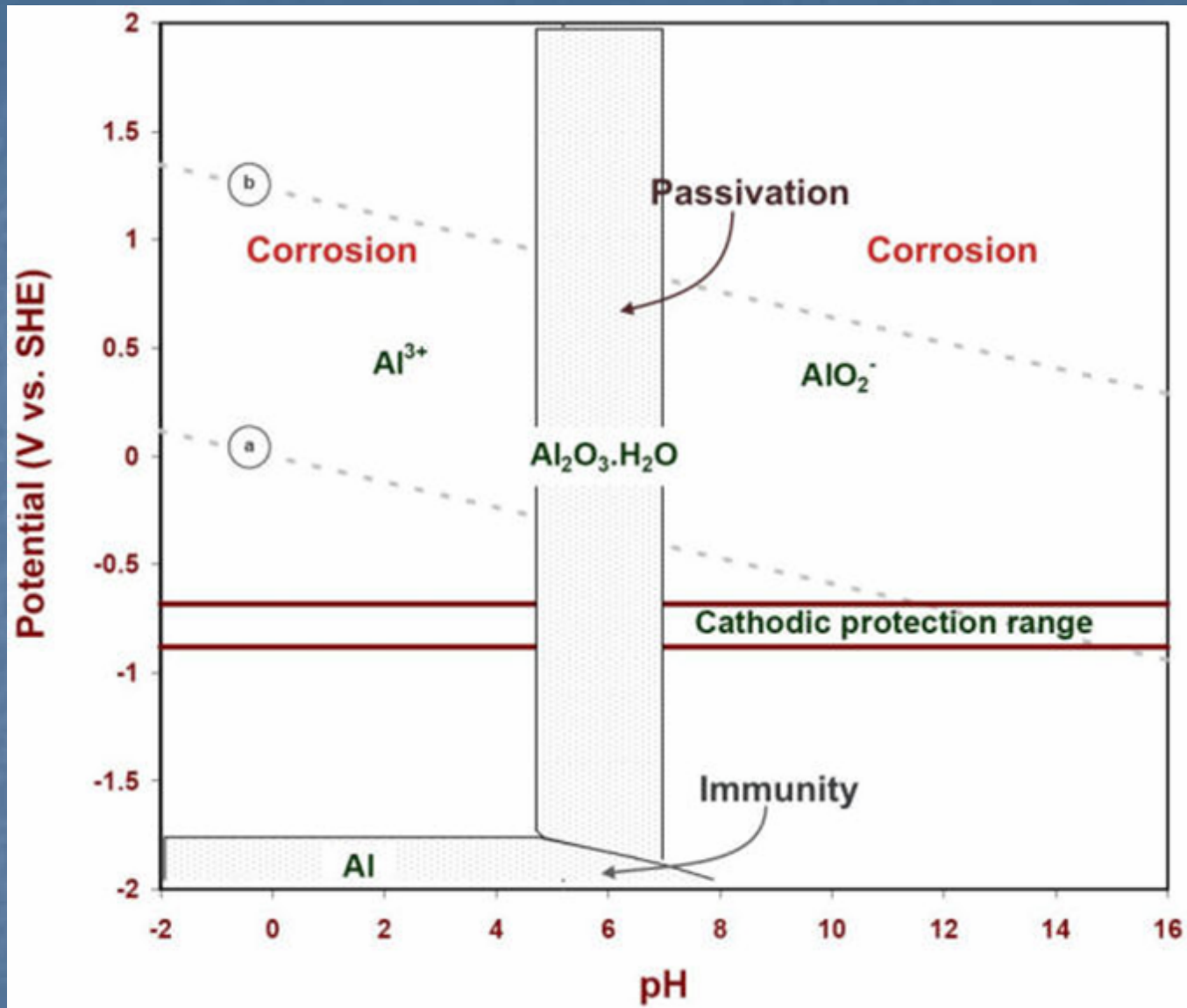

E-pH corrosion diagram of aluminum at 25°C

Pourbaix Diagram for Copper

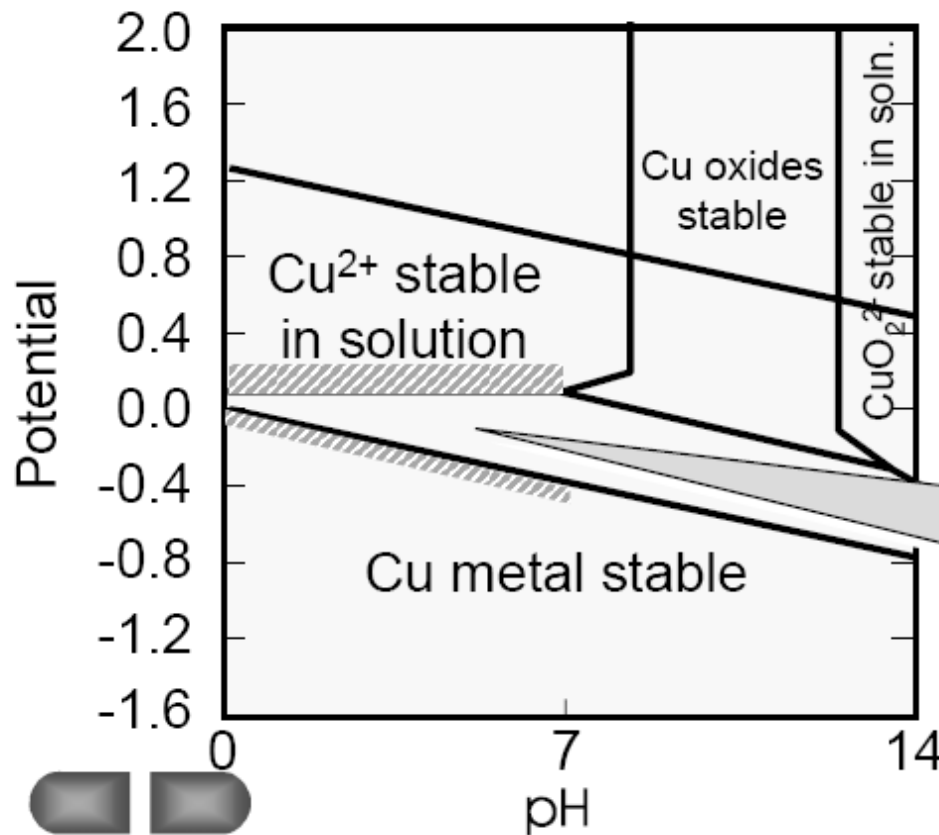

Will copper corrode in deaerated acid?

No - hydrogen evolution only occurs below the potential for copper corrosion



Pourbaix Diagram for Copper (Cont.)

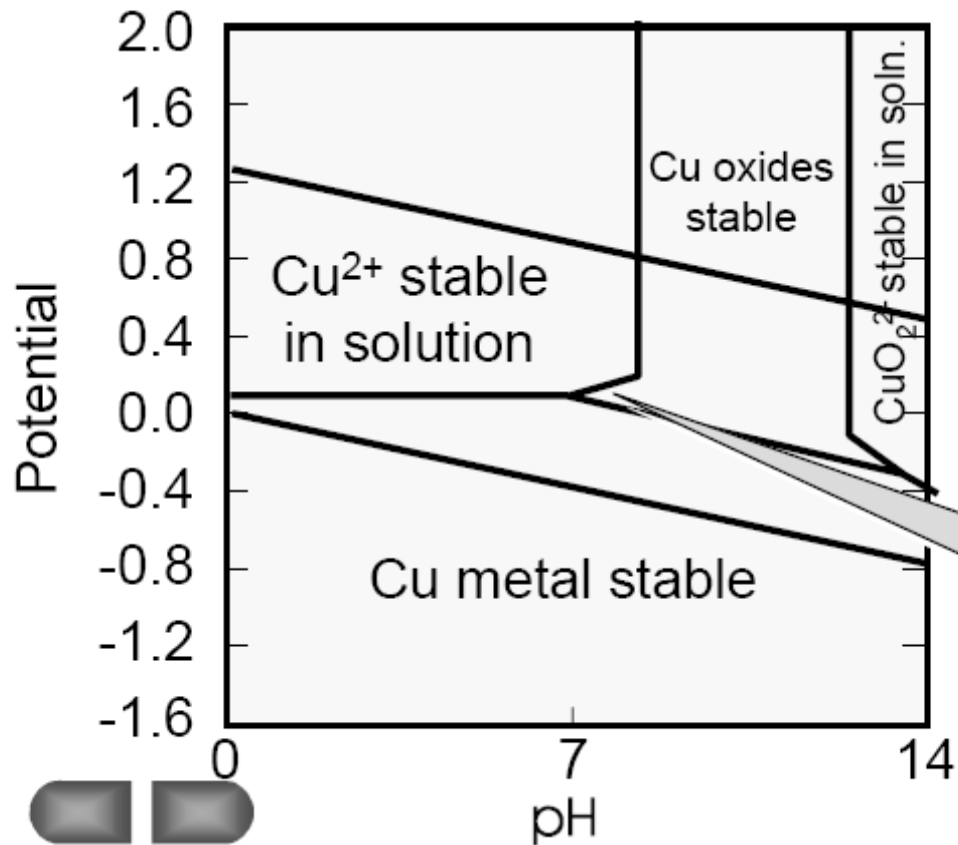

Will copper corrode in neutral aerated waters?

Usually it will just passivate, but corrosion can occur in slightly acid solutions



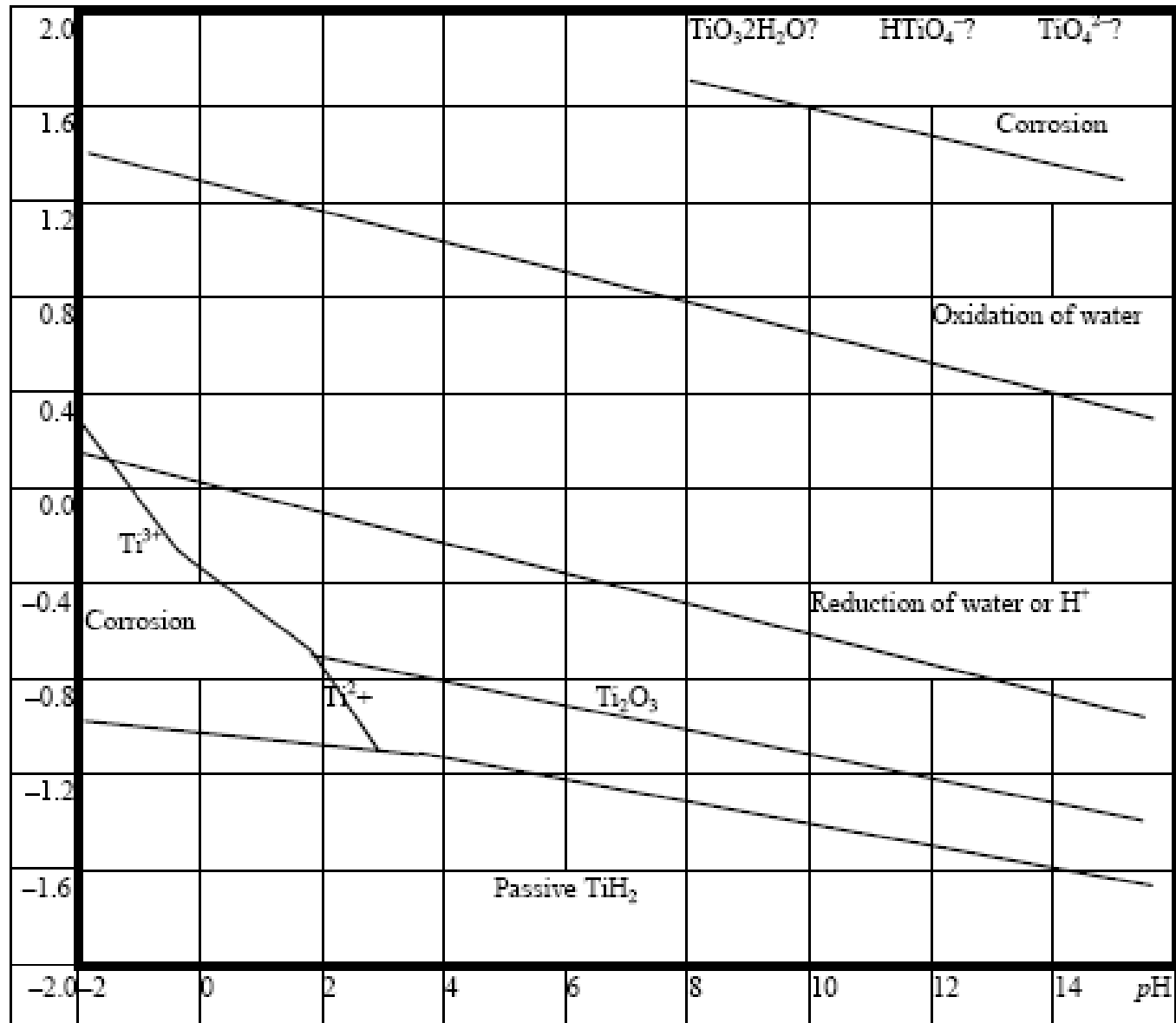

Pourbaix (potential-pH) diagram for Ti-H₂O system of 25°C

Practical Use of E -pH Diagrams

- The E -pH diagram is an important tool for understanding electrochemical phenomena
- It provides useful thermodynamic information in a simple illustration

Advantages of E-pH diagram

- E-pH diagram is proved to be useful not only in corrosion but also in many other fields such as
 - industrial electrolysis
 - Plating
 - electrowinning and electrorefining of metals
 - primary and secondary electric cells
 - water treatment
 - hydrometallurgy
- It is possible to predict whether a metal will tend to corrode or not.

Limitations of E-pH diagram

- It is not possible, however, to determine from these diagrams alone how long a metal will resist corrosion.
- Pourbaix diagrams offer a framework for kinetic interpretation, but they do not provide information on corrosion rates. They are not a substitute for kinetic studies.
- Each E -pH diagram is computed for selected chemical species corresponding to the possible forms of the element considered in the solution under study

Corrosion testing

Reasons for conducting corrosion testing?

- ✓ To provide an insight into corrosion mechanisms.
- ✓ To provide a basis for estimating service life of process equipment
- ✓ To compare the corrosion resistance of one alloy with another under standard conditions – for example in the development of new alloys with better corrosion resistance
- ✓ As a quality control test for a given heat of alloy

Immersion testing

- ❖ Most frequently conducted test for evaluating the corrosion of metals in aqueous solutions
- ❖ Immersion tests are conducted to determine the corrosion rates of metals in a given environment
- ❖ Totally immerse a test specimen in a corrosive solution for a period of time and then remove the specimen
- ❖ Factors to consider when performing immersion testing
 - ⦿ solution composition
 - ⦿ Temperature
 - ⦿ Aeration
 - ⦿ volume
 - ⦿ Velocity
 - ⦿ waterline effects
 - ⦿ specimen surface preparation
 - ⦿ method of immersion of specimens
 - ⦿ duration of test
 - ⦿ method of cleaning specimens at the end of the exposure period

Total Immersion testing

- Composition of Solution
 - Simulated solution as per standards
 - Naturally occurring solutions – sea water
 - Plant process solutions
- Aeration of Solution
 - Aeration or the presence of dissolved oxygen can influence corrosion rates profoundly
- Volume of Solution
 - The volume should be large enough to avoid any appreciable change in its corrosivity during the test
 - solution-to-specimen area ratio of 200 L/m²
- Temperature of Solution
 - Temperature is a critical factor in corrosion
 - controlled-temperature water or oil baths
- Evaporation losses
 - frequent addition to maintain the original volume within $\pm 1\%$

Intermittent Immersion testing

- ▶ Alternate immersion and emersion in a corrosive liquid
- ▶ Practical importance, because they simulate the effects of the rise and fall of tidal waters and the movements of corrosive liquids in chemical plants
- ▶ A thin film of the solution, frequently renewed and almost saturated with oxygen, can be maintained on the test specimen during most of the period of exposure
- ▶ Alternate Immersion in 3.5% NaCl - ASTM G 44
 - ▶ 1 hour test cycle
 - ▶ 10 min period of immersion in an aqueous solution of 3.5% NaCl or a substitute ocean water (without heavy metals)
 - ▶ 50 min emersion period
 - ▶ This 1 hour cycle is continued 24 h/day

Specimen Preparation and Duration of Tests

- ⦿ The type, size, and shape of specimens vary with the purpose of the test, the nature of the test materials, and the apparatus used
- ⦿ Standard practices for preparing, cleaning, and evaluating corrosion test specimens - ASTM G 1
- ⦿ Corrosion is a surface phenomenon. Surface condition of specimens is critical in determining the outcome of tests.
- ⦿ Proper selection of appropriate lengths of exposure is important for any corrosion test, and misleading results may be obtained if the time factor is not considered
- ⦿ Planned interval tests involve the accumulated effects of corrosion at several times under a given set of conditions as well as the initial rate of corrosion of fresh metal



Type of test coupons that are used for corrosion testing



Type of test coupons that are used for corrosion testing



Flat test coupons that are used for corrosion testing



Cylindrical test coupons that are used for corrosion testing

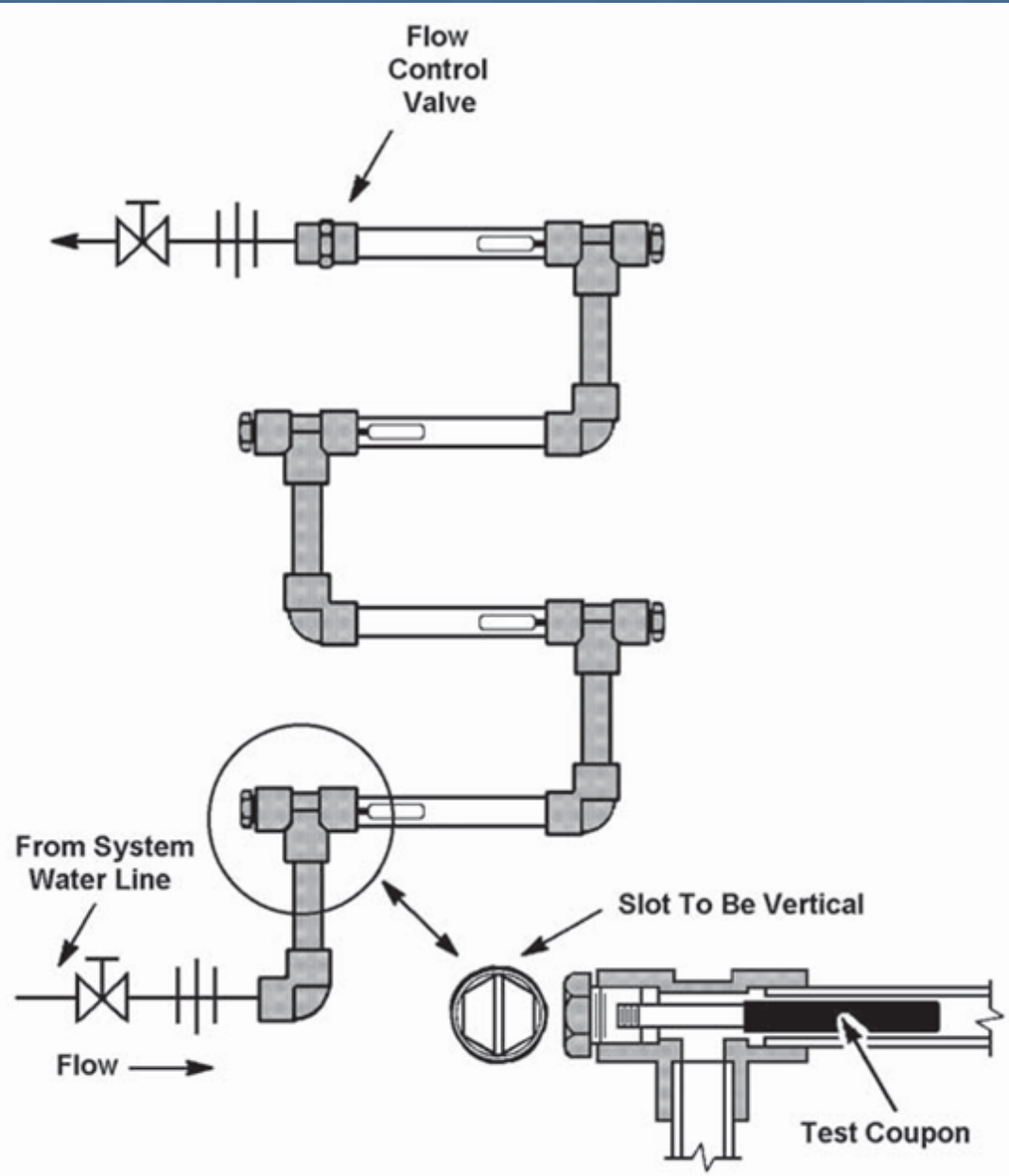

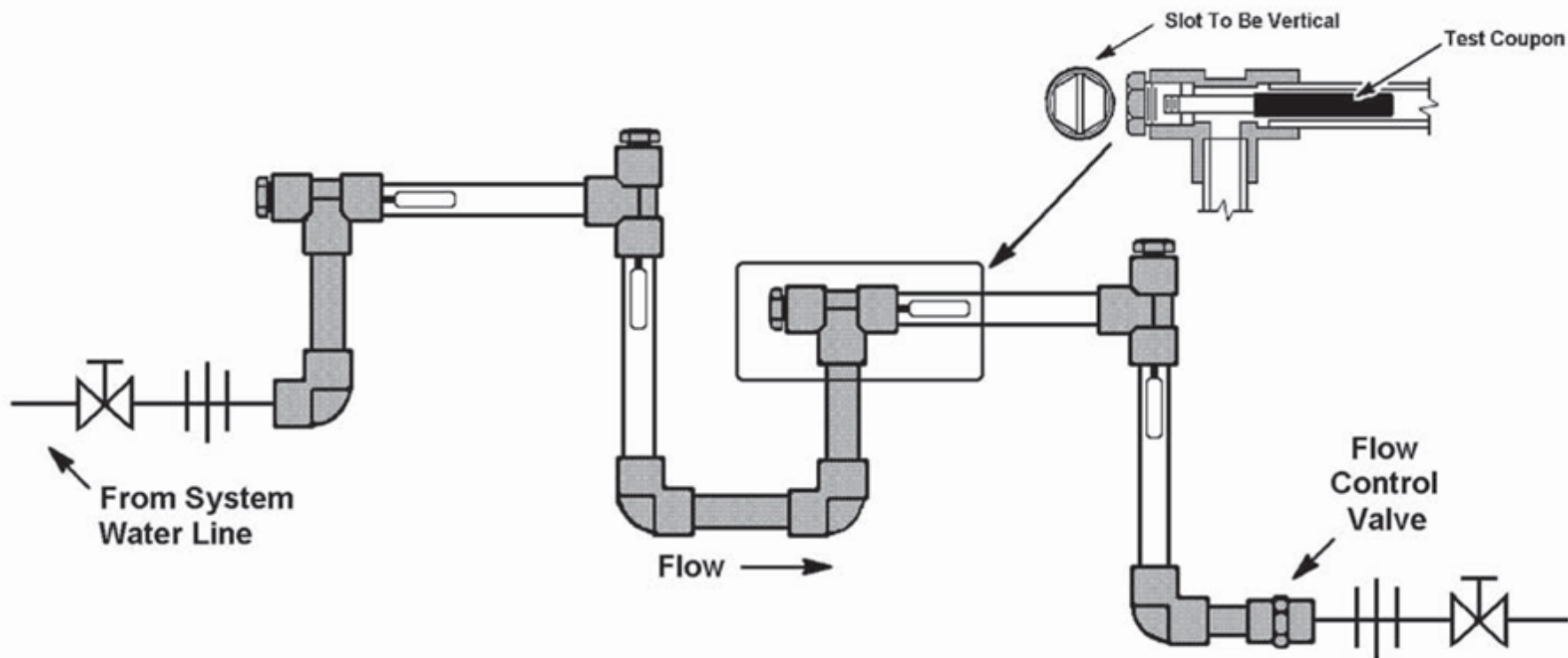



Test coupons after subjecting to corrosion testing

Cleaning Corrosion Test Specimens

- ✓ After corrosion testing, specimens should be properly cleaned to remove bulky deposits and corrosion products but not the metals
- ✓ This must be done as soon as possible, so that the measured corrosion time interval is accurate.
- ✓ Corrosion may be continuing under the damp corrosion products until they are removed.
- ✓ Various mechanical, electrolytic, and chemical cleaning methods have been developed to clean different metals and alloys

Calculation of Corrosion Rate

- ✂ The average corrosion rate may be obtained as follows:

$$\text{Corrosion rate} = (K \times W)/(A \times T \times D)$$

where K is a constant (varies with the unit)

T is the time of exposure in hours to the nearest 0.01 h,

A is the area in cm² to the nearest 0.01 cm²

W is the mass loss in grams to the nearest 1 mg

D is the density in g/cm³

- ✂ Several units are used to express corrosion rates
- ✂ Using the above mentioned units for T, A, W, and D, the corrosion rate can be calculated in a variety of units, with an appropriate value of K

Various units used to express corrosion rate

Corrosion rate	Constant, K
Mils per year (mpy)	3.45×10^6
Inches per year (ipy)	3.45×10^3
Millimeters per year (mm/yr)	8.76×10^4
Micrometers per year ($\mu\text{m}/\text{yr}$)	8.76×10^7
Milligrams per square decimeter per day (mdd)	$2.40 \times 10^6 \times D$

Atmospheric corrosion testing

Atmospheric corrosion

Atmospheric corrosion

- Atmospheric corrosion is a complicated process which involves
 - The base metal
 - Metallic corrosion products
 - The surface electrolytes
 - The atmosphere
 - Relative humidity
 - Temperature
 - Sulphur dioxide content
 - Hydrogen sulphide content
 - Chloride content
 - Amount of rain fall
 - Dew formation
 - Dust
 - Position of the exposed metal
 - Geographic locations

Dust

H₂O (humidity)

Air (O₂)

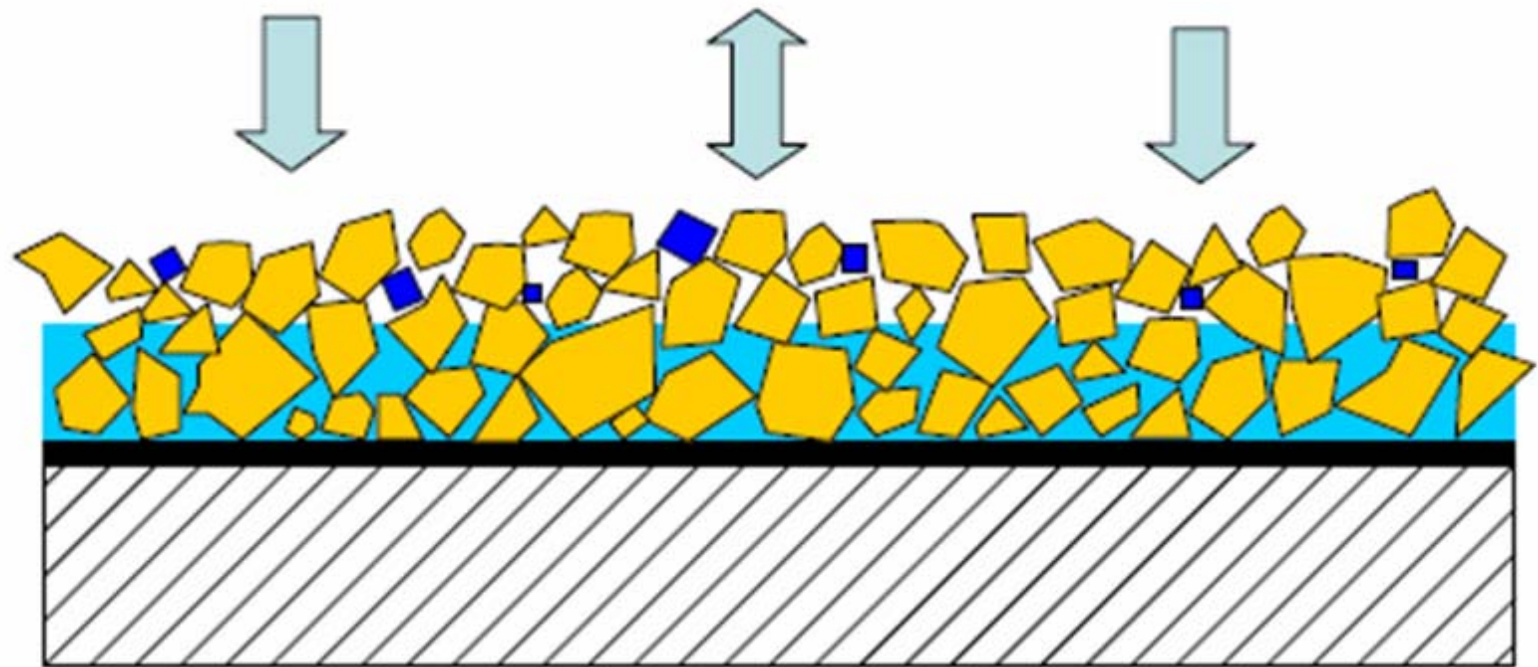

 dust

 salt

 solution

Classification based on atmospheric condition

- ❖ Based on potential corrosion rate the atmospheres are classified into the following categories
 - ❖ Rural
 - ❖ Urban
 - ❖ Industrial
 - ❖ Marine
 - ❖ Indoor

Type of atmosphere and its corrosivity

Rural

- Inland agricultural area with little or no heavy manufacturing operations
- Problems of atmospheric corrosion are relatively less

Urban

- Pollution from fast traffic – Oxides of nitrogen – oxidized to nitric acid
- Burning of fossil fuels (petroleum, coal and natural gas) – sulphur dioxide which is converted to sulphuric acid

Type of atmosphere and its corrosivity

Industrial

- Sulphur dioxide and hydrogen sulphide
- HCl, HF, HBr formed due to combustion products from burning of chemical waste
- HCl – Incineration of municipal wastes

Marine

- Chloride – fine spray of the salt solution – drying
- Amount of chloride deposition from a marine environment is directly proportional to the distance from the shore

Indoor

- Free of corrosion in clean rooms – class room
- Severe corrosion in other rooms – chemistry lab

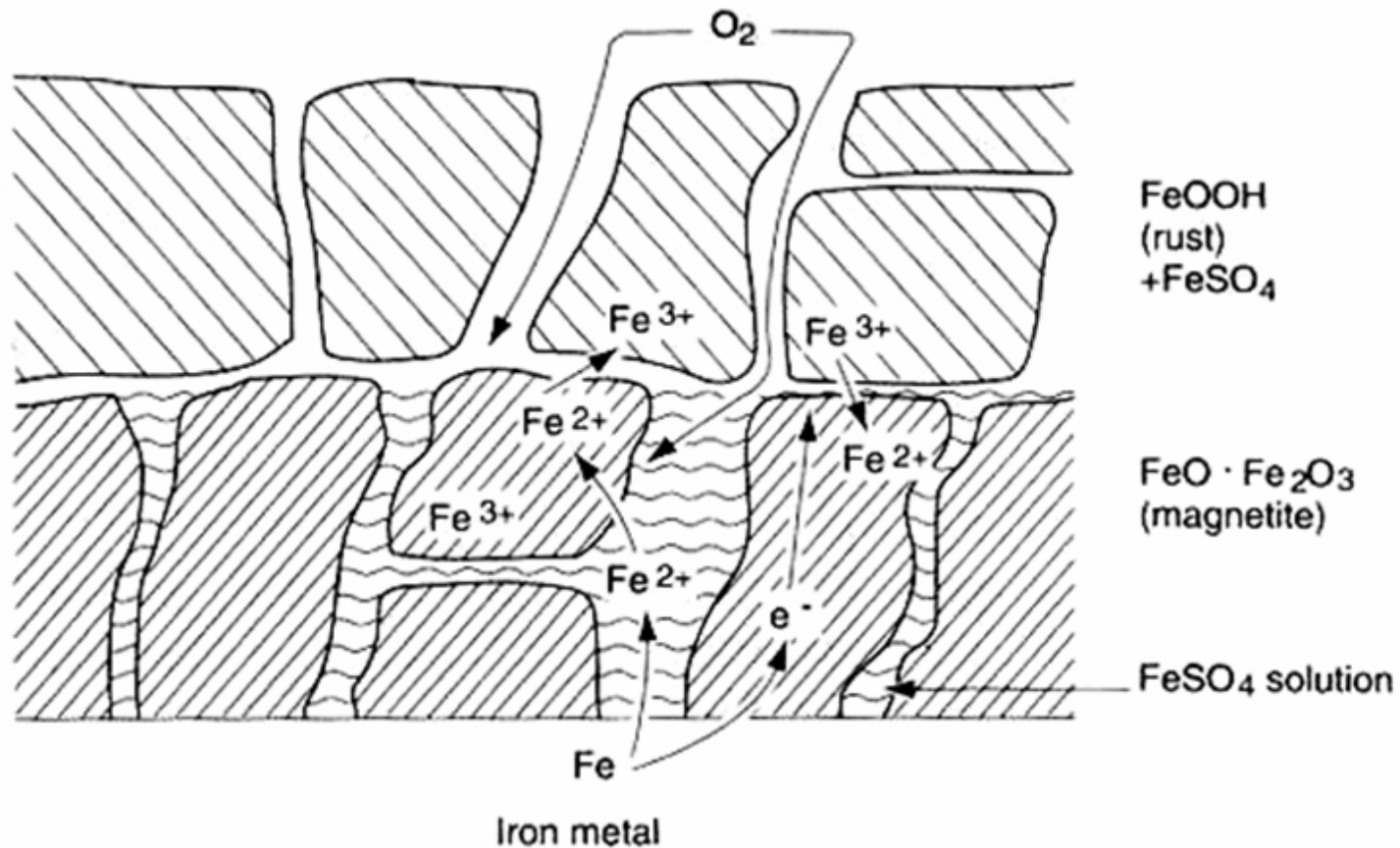

FIGURE 12.6 Schematic diagram showing electrochemical mechanism of atmospheric rusting in an SO_2 -polluted environment.

Atmospheric corrosion – wet or dry?

- ❖ The electrolyte is not always present
- ❖ Discontinuous process, unlike the wet
- ❖ Corrosion rate of atmospheric corrosion depends on
 - ❖ Total wetness
 - ❖ Composition of the electrolyte
 - ❖ Temperature

TABLE 12.1 Effect of Hygroscopic Salt Particles on Atmospheric Corrosion of Iron

Salt Used	RH _{crit}	Relative Humidity, %					
		100	90	80	70	60	50
Na ₂ SO ₄ · 10H ₂ O	93	*	o	o	o	o	o
KCl	86	*	*	×	o	o	o
NaCl	78	*	*	*	×	o	o
NaNO ₃	77	*	*	*	o	o	o
NaNO ₂	66	+	+	+	+	o	o
NaBr · 2H ₂ O	59	*	*	*	*	*	o
NaI · 2H ₂ O	43	*	*	*	*	*	*
LiCl · H ₂ O	15	*	*	*	*	*	*

- * Salt coating is moist; underlying rust and attack of the steel.
- × Salt coating colored brown at edge; underlying attack of the steel.
- + Salt coating converted to colorless solution; no corrosion.
- o Salt coating is dry; no corrosion.

From H. Kaesche, Metallic Corrosion, NACE, Houston, pp. 216-19, 1985. Reprinted by permission, National Association of Corrosion Engineers.

Rate of atmospheric corrosion – Linear?

- ❖ Atmospheric corrosion proceeds through three stages
- ❖ Induction period
 - ❖ metal is covered with a spontaneously formed oxide and aqueous layer
 - ❖ The oxide layer proved some degree of protection
- ❖ Transition period
 - ❖ The oxide layer is transforms into a fully developed corrosion product
- ❖ Stationary period
 - ❖ Surface is fully covered with corrosion products, eventually reaching a constant properties with respect to chemical composition and corrosion rate
- ❖ More aggressive the environment - the shorter will be the induction and transition periods

Carbon steel vs. weathering steel

- Carbon steels has little or no corrosion resistance against atmospheric corrosion
- Weathering steels
 - alloying carbon steel with copper, chromium, nickel, phosphorus, silicon and manganese
 - Improved corrosion resistance
 - Similar corrosion mechanism
 - Rust forms on weathering steels
 - more dense and compact
 - Effectively screen the steel from corrosive environment
 - Decreases the diffusion rate of oxygen – cathodic reaction
 - Limiting the supply of water/moisture and other anions from reaching the surface

Influence of alloying elements of weathering steel

- Weathering steels - alloying carbon steel with copper, chromium, nickel, phosphorus, silicon and manganese
- **Copper** – most pronounced effect in decreasing the corrosion rate - Increase in Cu from 0.01 to 0.40% decreases the corrosion rate by 70%
- Copper forms the basic sulphates with low solubility which precipitates within the pores of the rust layer, thereby decreasing their porosity
- Cu When added along with Cr, and Ni – Cr - 0.40 to 1.0%; Ni – up to 0.65% further increase in corrosion resistance
- Cr is enriched in the inner rust layer together with Cu and P – promote the formation of a dense layer of FeOOH – barrier layer
- Ni – forms basic sulphates with low solubility which precipitates within the pores of the rust layer
- P also helps to increase the corrosion resistance – Increase in P content from 0.01 to 1% - 20-30% improvement in corrosion resistance
- P forms insoluble phosphates – barrier layer

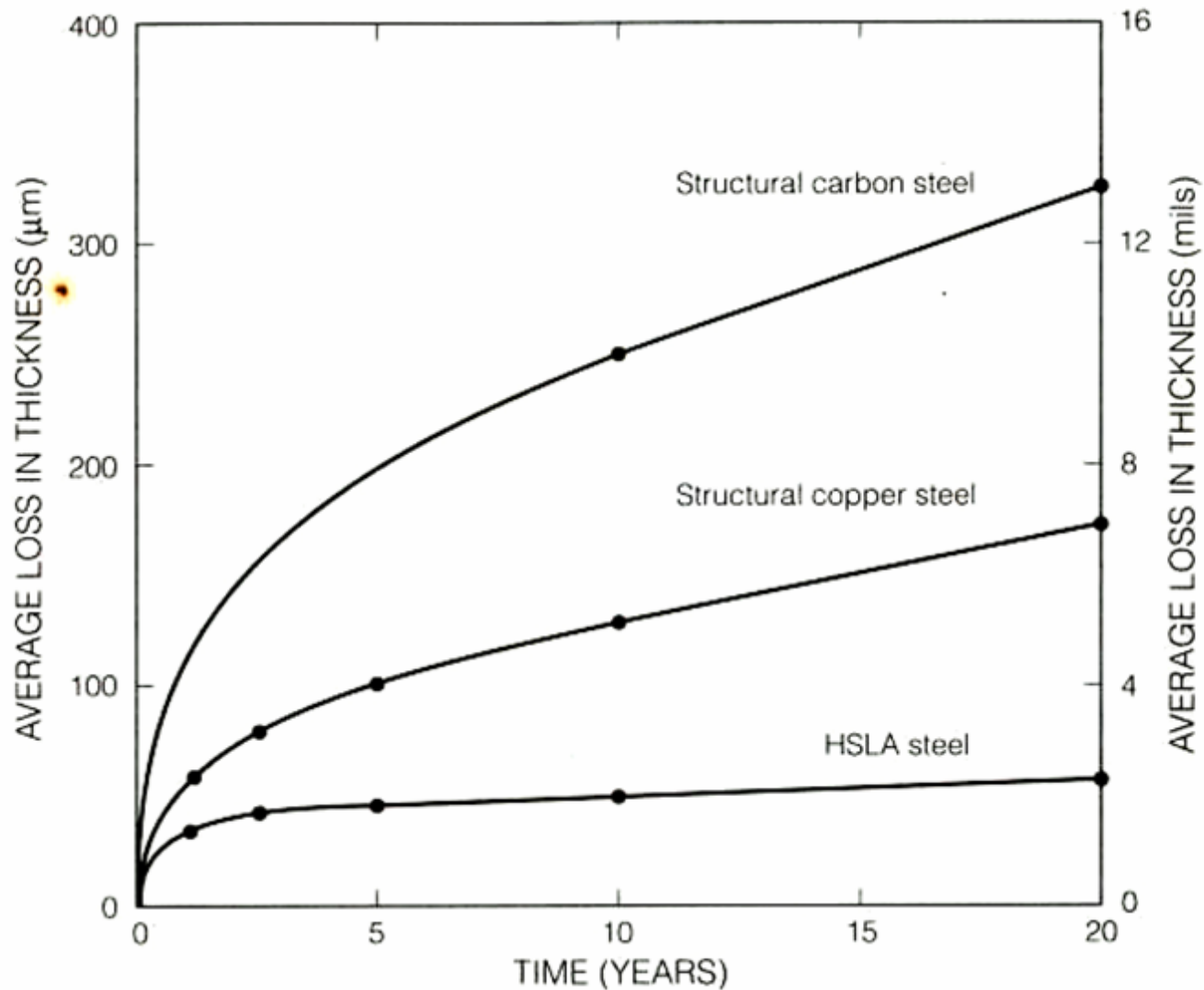

FIGURE 12.4 Effect of copper and other alloying elements on the long-term atmospheric corrosion resistance of steel. (From C. P. Larabee and S. K. Coburn, First Int. Cong. Metallic Corrosion, Butterworth, Sevenoaks, Kent, England, p. 276, 1962. Reprinted by permission, Butterworths Publishers Ltd.)

Atmospheric corrosion testing

Table 1 Typical activity ranges of SO_x and Cl⁻ measured in various atmospheres

These are average activity ranges measured over a 20–25 month period.

Type of atmosphere	mg SO _x /dm ² /d	mg Cl ⁻ /m ² /d
Industrial	0.5–2	nil
Urban	0.5–4	nil
Rural (semi)	nil–2	nil
Marine	nil–0.5	25–150

Environmental parameters often considered as influences on the atmospheric degradation of materials

Category	Parameters
Wet deposition	pH
	Conductivity
	Cations: calcium (Ca^{2+}), magnesium (Mg^{2+}), sodium (Na^+), potassium (K^+), ammonium (NH_4^+), and hydrogen (H^+)
	Anions: sulfates (SO_4^{2-}), nitrates (NO_3^-), and chlorides (Cl^-)
Dry deposition	Sulfur dioxide (SO_2)
	Nitrogen dioxide (NO_2)
	Nitric acid (HNO_3)
	Ammonia (NH_3)
	Particulate matter, sulfates, nitrates
Meteorology	Ozone
	Wind speed
	Wind direction
	Relative humidity (dewpoint)
	Temperature
	Solar radiation
	Rainfall volume and intensity
Others	Test specimen surface temperature
	Time of wetness

IS 5555:1970 - Code of procedure for conducting field studies on atmospheric corrosion of metals

- ⦿ This code deals with the procedure of conducting indoor and outdoor exposure tests on metals and alloys for collection of corrosion data.
- ⦿ Exposure site
 - ⦿ For the purpose of selection of exposure site, the country has been divided into eight climatic regions
 - ⦿ The site shall be so selected as to appropriately represent one of these climatic regions.
 - ⦿ In the location of the site care shall be taken against any obstructions to the free passage of air to the site.
- ⦿ Test panel
 - ⦿ The test panels to be exposed shall be of mild steel and zinc.
 - ⦿ Other metals like galvanized steel, copper, aluminium, tinplate and stainless steel, may also be exposed if required

Size of the specimen and exposure conditions

- ☼ Size of the panels
 - ☼ 150 × 100 mm for outdoor exposure and 150 × 50 mm for indoor exposure
 - ☼ A thickness of 1.25 mm is recommended
- ☼ Preparation of the test specimen
 - ☼ The metal panels shall be cut from a single sheet or from sheets manufactured in the same batch
- ☼ Exposure of the panels
 - ☼ All panels shall be weighed before exposure
 - ☼ The panels shall be held at an angle of 45° to the horizontal
 - ☼ Specimens shall face south and shall be exposed at 1 to 1.5 metres above the ground level
 - ☼ The panels shall be held in position by ceramic or perspex cleats
 - ☼ The panels shall be so arranged and fixed to the frame that corrosion products or leachings from one panel do not contaminate the other and minimum area of the panels is shielded during exposure.
 - ☼ Any bimetallic contact with bolts, nuts or frames shall be avoided.

INSPECTION DURING EXPOSURE

- ✓ The exposed panels shall be periodically examined for nature and extent of corrosion.
- ✓ One of the two panels in each set exposed for one year shall be weighed every month and the monthly weight increments shall be recorded.
- ✓ These panels shall be put back for continued exposure for a total period of one year
- ✓ Pitting and perforation of specimens shall be noted.



Atmospheric-corrosion test rack

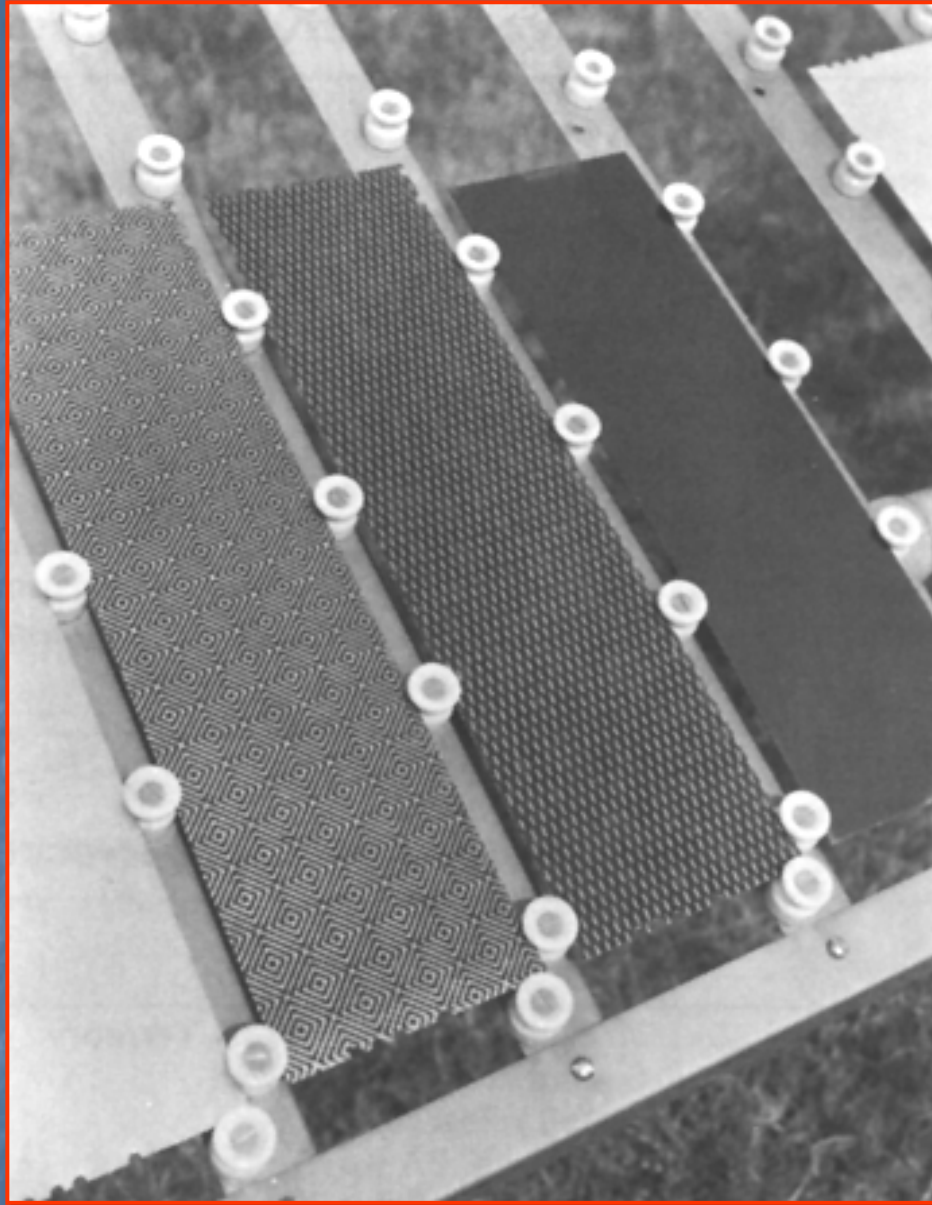

Atmospheric-corrosion test rack

Evaluation techniques for atmospheric-corrosion specimens

Technique	Value
Photographic documentation	Photographs of the specimens before and after cleaning give a permanent record of the performance of the material in the particular atmosphere.
Corrosion product analysis and surface deposits	Atmospheric-corrosion specimens usually have the corrosion product and airborne deposits on the surface at the time of removal. This adds a wealth of information to the observed behavior of the material.
Mass loss	For uniform corrosion, this is simple and can be converted to corrosion rate as $\text{g/m}^2/\text{d}$, mils per year, etc.
Pitting and localized corrosion	Yields information on the susceptibility of a material to localized attack. Pitting corrosion is often reported as average or maximum depth of attack and is usually measured with a dial depth gage or vernier microscope. Where possible, pitting data should be treated statistically with recognized methods covered in various standards. Weight loss data should not be used indiscriminately to calculate corrosion rates

Salt spray testing

Salt spray testing ASTM B 117-90 (IS 9844: 1981) (2006)

- ❖ TEST APPARATUS REQUIREMENTS ASTM B 117 -90 and IS 11864: 1988) (2006)
- ❖ A fog chamber (test cabinet) with
- ❖ a compressed air inlet
- ❖ a solution reservoir
- ❖ a solution atomizing device
- ❖ specimen supports
- ❖ temperature control equipment
- ❖ The method of construction shall be such that they shall not get corroded by the fog/spray in the chamber

Test solution, pressure and atomizer

- ❖ Test solution – NaCl – 50 g/l
- ❖ The pH of the solution - 6.0 to 7.2
- ❖ Spraying – Using a compressed air
- ❖ Pressure: 10-25 psi
- ❖ Collection volume should be measured using a measuring cylinder and a funnel
- ❖ Atomizer shall be made of inert materials - plastic
- ❖ Spray must not be aimed directly into the test pieces
- ❖ Direct the spray against a baffle or directing plate in such a way that a uniform distribution of the spray through the entire test cabinet is obtained.

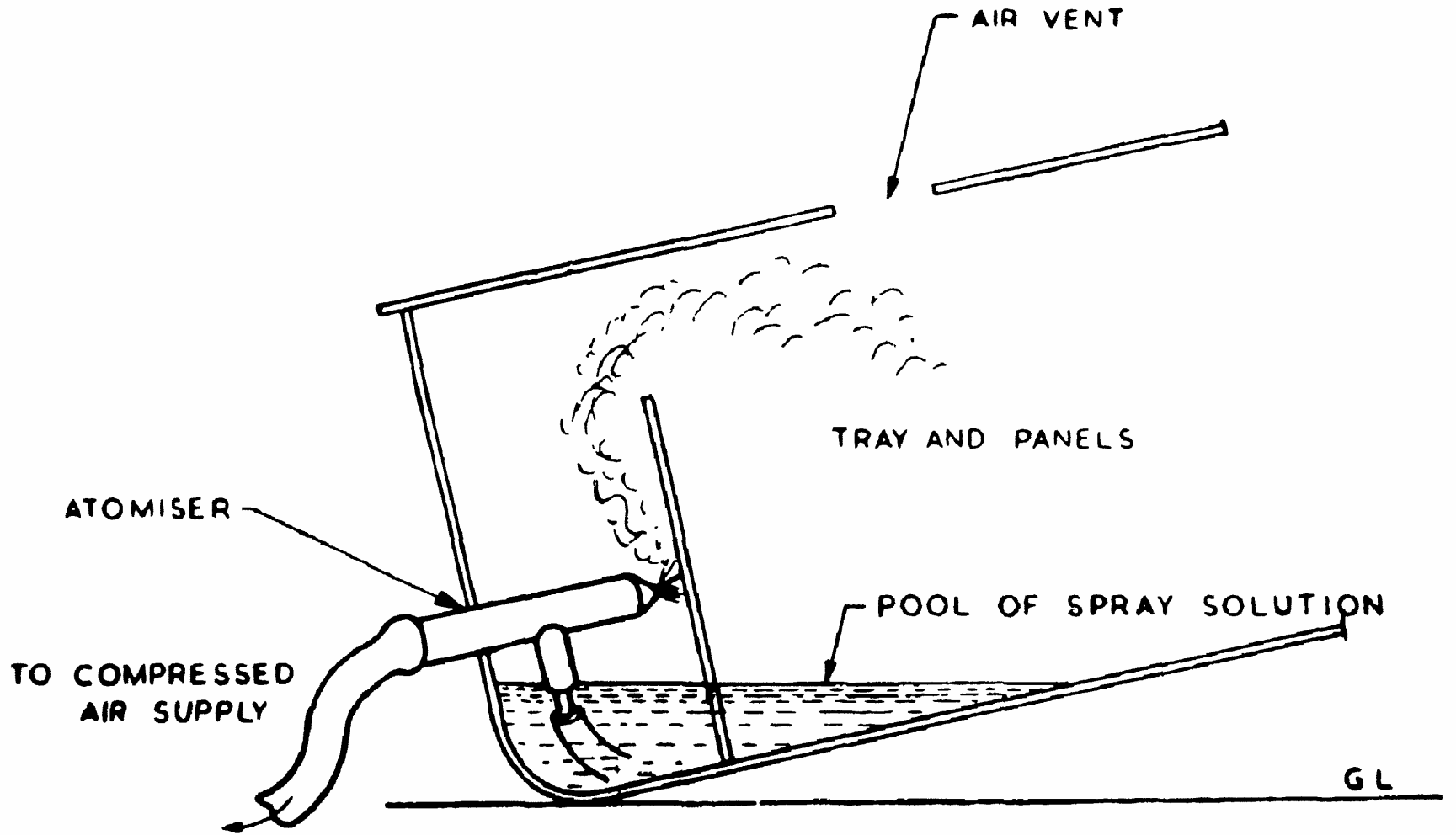

Test specimens

- ⦿ The specimens shall be thoroughly cleaned before testing
- ⦿ Care shall be taken that specimens are not re-contaminated after cleaning by excessive or careless handling.
- ⦿ the cut edges shall be adequately protected by coating them with a suitable medium, stable under the conditions of the test, such as paint, wax or adhesive tape.

Method of exposure of test specimens

- The specimens shall be so placed in the cabinet that they are not in the direct line of travel of spray from the atomizer
- Baffles may be used to prevent direct impact of the sprayed solution and the specimens
- The angle at which the sample is exposed in the cabinet is very important.
- The surface shall in principle, be flat and placed in the cabinet facing upwards at an angle as close as possible to 20° to the vertical
- This angle shall, in all cases, be within the limits 15-30°

Method of exposure of test specimens

- ❖ The specimens shall be so arranged that they do not come into contact with one another or with the cabinet and that surfaces to be tested are exposed to free circulation of spray
- ❖ Specimens may be placed at different levels within the cabinet as long as the solution may not drip from specimens or their supports at one level onto other specimens placed below.
- ❖ The support for the specimens shall be made of inert non-metallic material such as glass, plastics
- ❖ If necessary test specimens can be suspended. However, the material used shall on no account be metallic and shall be synthetic fibre, cotton thread or other inert insulating material.

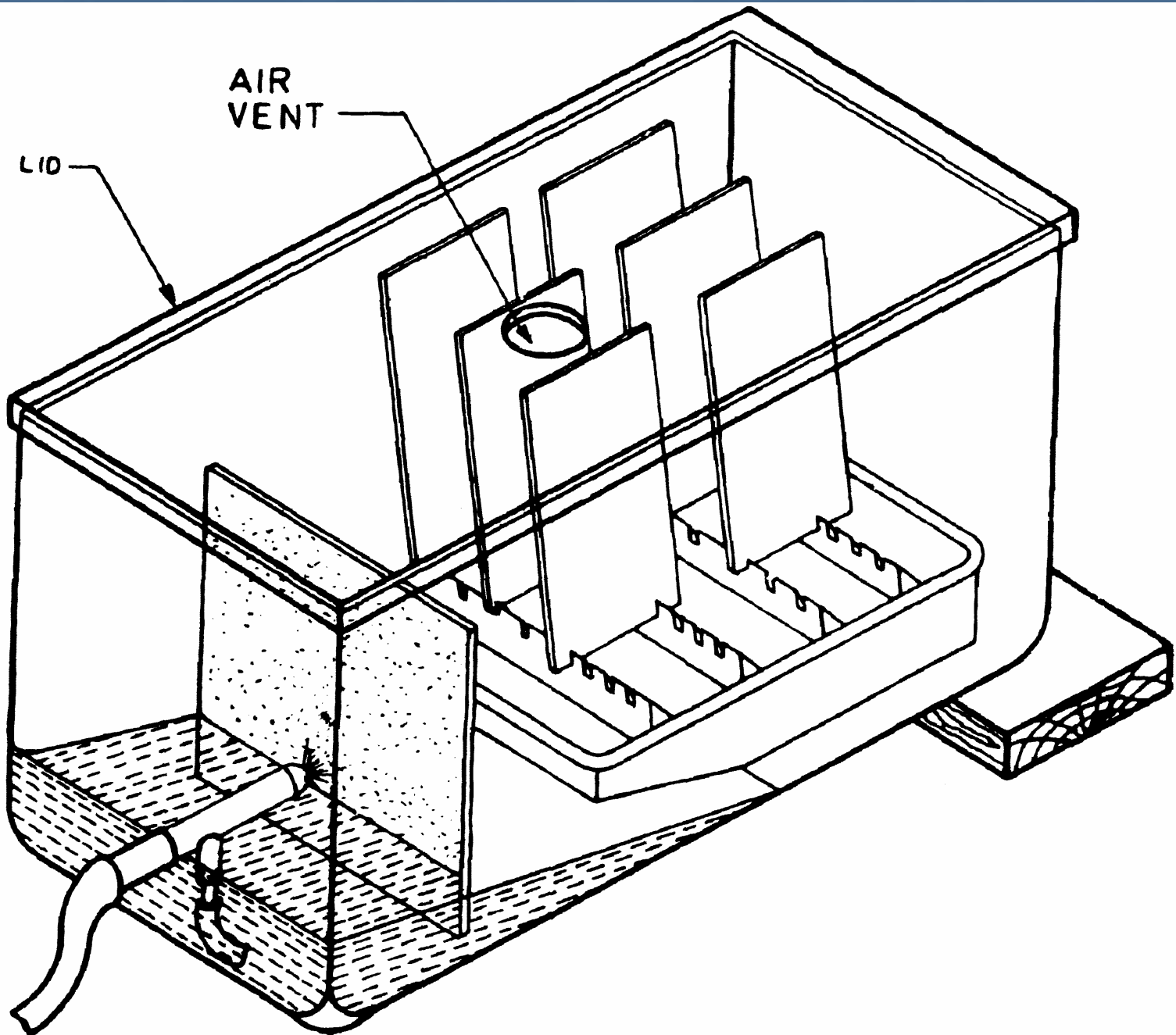



Operating conditions

- ✓ The temperature inside the spray cabinet shall be maintained at $35 \pm 2^{\circ}\text{C}$
- ✓ The solution collected in each of the collecting devices shall have a sodium chloride concentration of $50 \pm 10 \text{ g/l}$ and a pH value in the range 6.5 to 7.2
- ✓ The average rate of collection of solution in each device measured over a minimum period of 24 hours shall be 1 to 2 ml/h for a horizontal collecting area of 80 cm^2
- ✓ Test solution which has *been* sprayed shall not be reused.

Duration of tests and evaluation

- ❖ Recommended periods of exposure are 2h, 6 h, 24 h, 48 h, 96 h, 240 h, 480 h and 720 h.
- ❖ Spraying shall not be interrupted during the prescribed test period
- ❖ The cabinet shall be opened only for brief visual inspections of the test specimens in position and for replenishing the salt solution in the reservoir
- ❖ Evaluation
 - ❖ the time elapsing before the appearance of the first sign of corrosion.

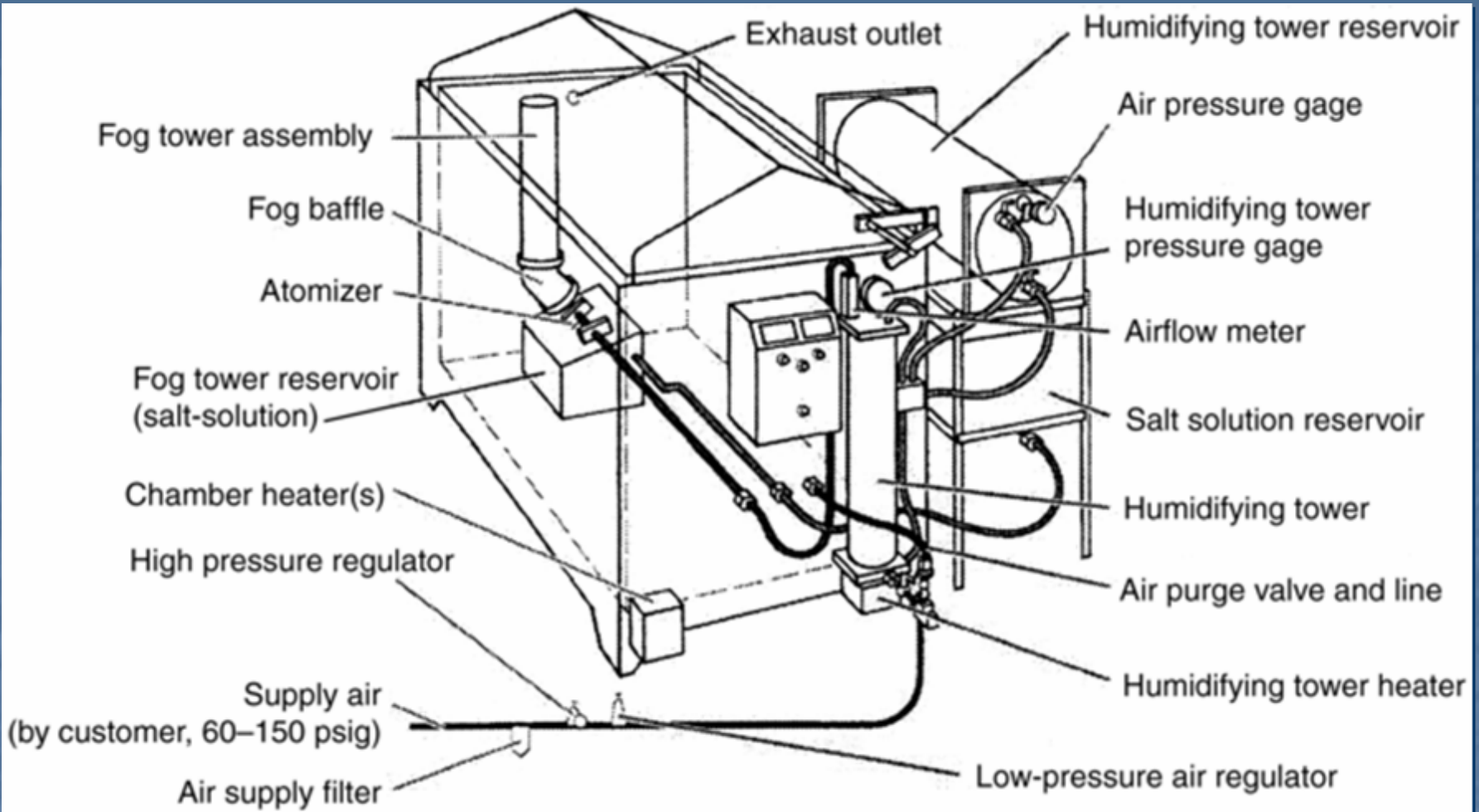

A diagram of a standard salt-fog corrosion test chamber shows key components of the environment conditioning and control systems

Extent of corrosion from the scribed region after 96 h of salt spray test



Painted steel

Phosphated and painted steel

Extent of corrosion of after 24 h of salt spray test



Visual appearance of the TMT bars before and after salt spray test as per ASTM B 117 -90



25 mm \varnothing TMT bar before NSS



After 174 h of NSS



After 440 h of NSS



After 672 h of NSS

Corrosion rate after various duration of testing and the average corrosion rate

Sample ID	Corrosion rate after 174 h ($\mu\text{m}/\text{year}$)	Corrosion rate after 440 h ($\mu\text{m}/\text{year}$)	Corrosion rate after 672 h ($\mu\text{m}/\text{year}$)	Average corrosion rate ($\mu\text{m}/\text{year}$)
8 mm \varnothing bar	350	492	443	428
12 mm \varnothing bar	362	487	451	433
20 mm \varnothing bar	358	493	450	434
25 mm \varnothing bar	364	495	451	437

Cyclic corrosion testing

Cyclic corrosion testing

- A more realistic way to perform salt spray test than the traditional steady state exposures
- Actual atmospheric exposures usually include both wet and dry conditions
- Hence, it makes sense to pattern accelerated laboratory tests after these natural cyclic conditions
- Research indicates that, with cyclic corrosion tests, the relative corrosion rates, structure and morphology are more similar to those seen outdoors
- Cyclic tests usually give better correlation to outdoors than conventional salt spray tests
- They are effective for evaluating a variety of corrosion mechanisms, including general, galvanic, and crevice corrosion.

Cyclic corrosion testing

- ❖ Any or all of the following environments may be used for cyclic corrosion testing
- ❖ Ambient Environment
- ❖ Fog (Spray) Environment
- ❖ Humid Environment
 - ❖ 95-100% Relative Humidity
- ❖ Dry-Off Environment
- ❖ Corrosive Immersion Environment
- ❖ Water Immersion Environment

Tab. 1: Cycle exposure for GM9540P/B

-	<i>Thorough Salt Mist Application</i>
90 min.	Ambient Conditions (25 °C, 30-50 % RH)
-	Thorough Salt Mist Application
90 min.	Ambient Conditions (25 °C, 30-50 % RH)
-	Thorough Salt Mist Application
90 min.	Ambient Conditions (25 °C, 30-50 % RH)
-	Thorough Salt Mist Application
210 min.	Ambient Conditions, 25 °C, 30-50 % RH)
8 hours	Humidity (95-100 % RH)
8 hours	Dry Off (60 °C, < 30 % RH)
Repeat	

Acid Rain CCT exposure conditions include:

- Solution: 5 % (wt) NaCl, 0.12 % (vol) HNO₃, 0.173 % (vol) H₂SO₄, 0.228 % (wt) NaOH;
- Solution acidity: pH of 3.5.

The Acid Rain CCT exposure cycle is:

- 2 hours fog at 35 °C;
- 4 hours dry-off at 60 °C, less than 30 % RH;
- 2 hours wet/humid at 50 °C, over 95 % RH.

Acid Rain CCT specifies transition times between environments as follows:

- Fog to dry: within 30 minutes;
- Dry to wet: within 15 minutes;
- Wet to fog: within 30 minutes.

Electrochemical corrosion testing

Electrochemical corrosion testing

- ❖ DURING CORROSION, at least two electrochemical reactions
 - ❖ An oxidation reaction (metal dissolution)
 - ❖ A reduction reaction (oxygen reduction)occur at a metal-electrolyte interface
- ❖ Corrosion is an electrochemical phenomenon and is governed by an electrochemical mechanism
- ❖ Hence, electrochemical techniques can be used to study corrosion reactions and mechanisms

Electrochemical corrosion testing techniques

- Open circuit potential measurement
- Linear polarization
- Potentiodynamic polarization
- Galvanodynamic polarization
- Potentiostatic current-time transient
- Galvanostatic potential measurement
- Electrochemical impedance
- Galvanic corrosion measurement

Basic instrumentation needed for electrochemical corrosion tests

- ✓ Test or working electrode (WE)
- ✓ One or more counter electrodes (CE)
- ✓ Reference electrode (RE)
- ✓ Test cell
- ✓ Potentiostat/galvanostat or Voltmeters and ammeters for monitoring of potential and current (optional)
- ✓ Recording devices (strip chart or *x-y* recorders) or Computer with software program and plotter
- ✓ Gas tank with nitrogen, argon, or another gas to deaerate the solution (optional)
- ✓ Thermostat with a constant temperature bath or heating mantle (optional)

Counter electrode

- ⦿ Counter Electrode – The counter electrode should be of good conductivity and should not dissolve as a result of current flow
- ⦿ Platinum is used in most experiments – expensive
- ⦿ It is desirable to use CEs with much larger area than the WE in order to reduce the current density at the CE and avoid contamination by reaction products of the electrolyte, less expensive materials, such as graphite, are often used as CEs
- ⦿ For the same reason, the CE should be placed in a separate compartment with a glass frit to the main cell. However, this precautionary measure is often neglected

Reference electrode

- ⦿ Reference Electrode - The saturated calomel electrode (SCE) is the most common RE used in studies of corrosion reactions, due to its stability and commercial availability
- ⦿ Care must be taken to avoid contamination of the test electrolyte by leakage of chloride ions from a SCE when tests are carried out in chloride ion-free test solutions
- ⦿ A mercury/mercurous sulfate electrode may be used when chloride ion contamination is not acceptable
- ⦿ Other REs: Ag/AgCl and the Cu/ CuSO₄ electrodes
- ⦿ A luggin capillary is used to minimize the ohmic drop between WE and RE

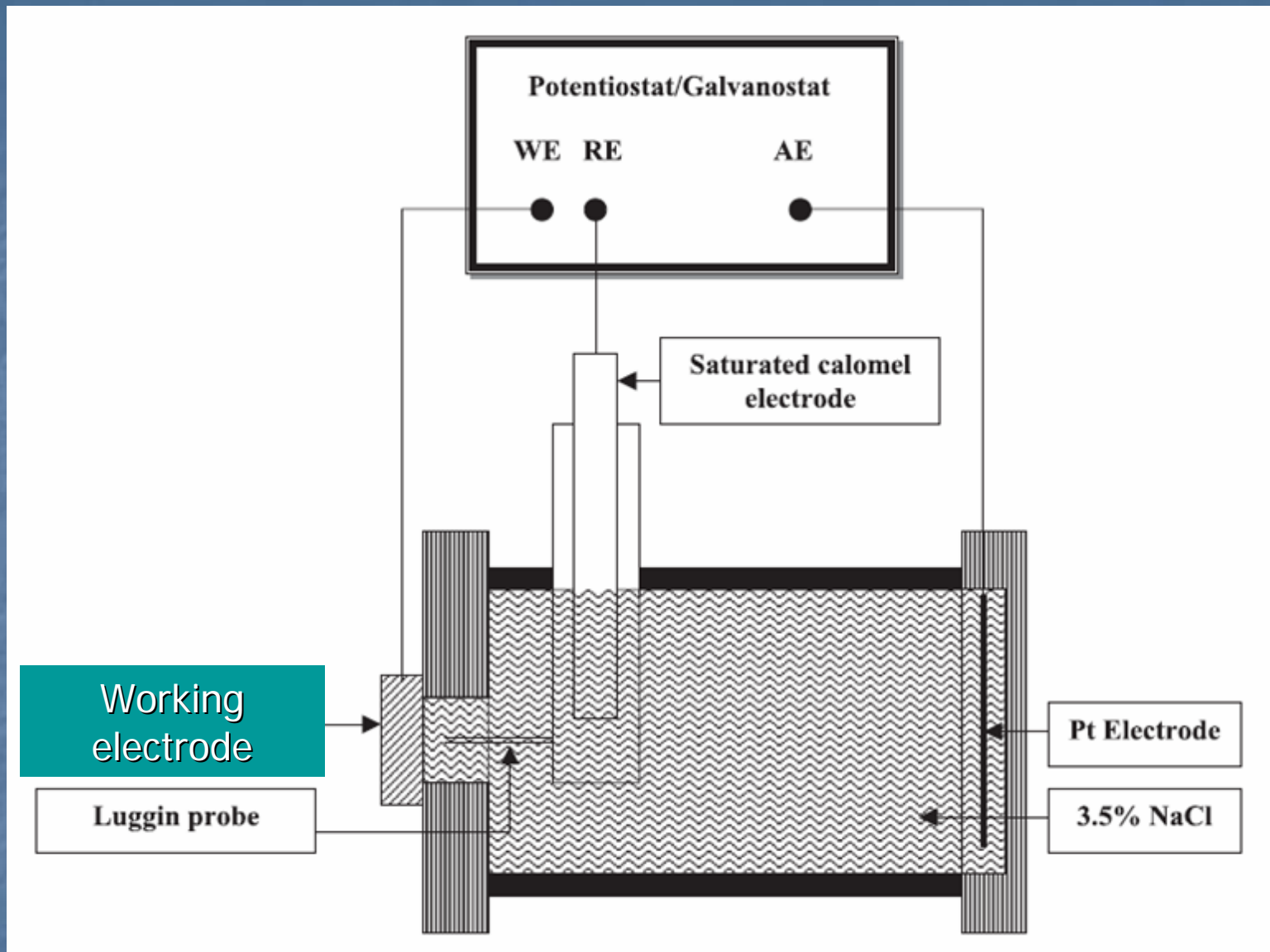

Schematic diagram of a flat cell used for evaluating the corrosion resistance

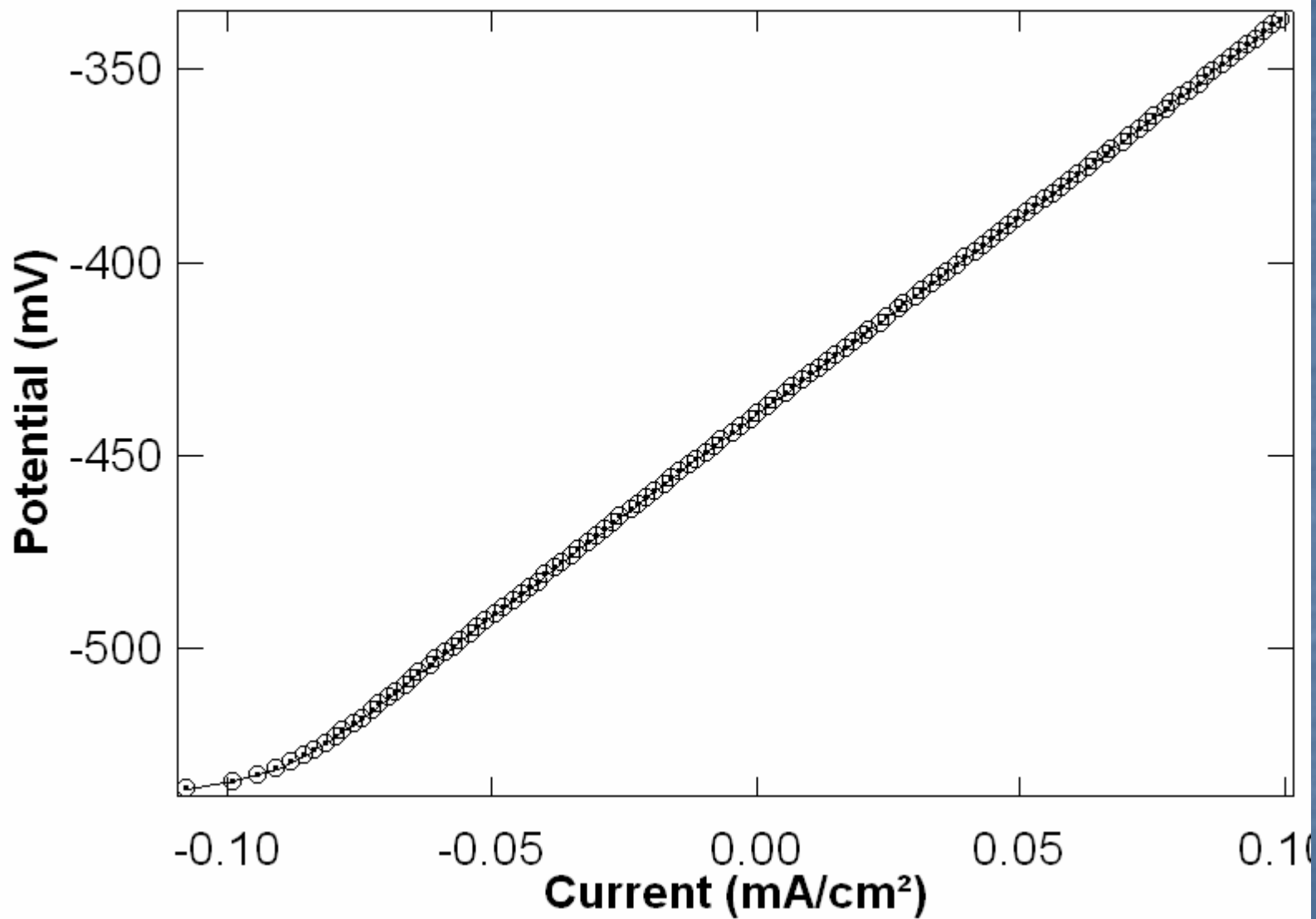

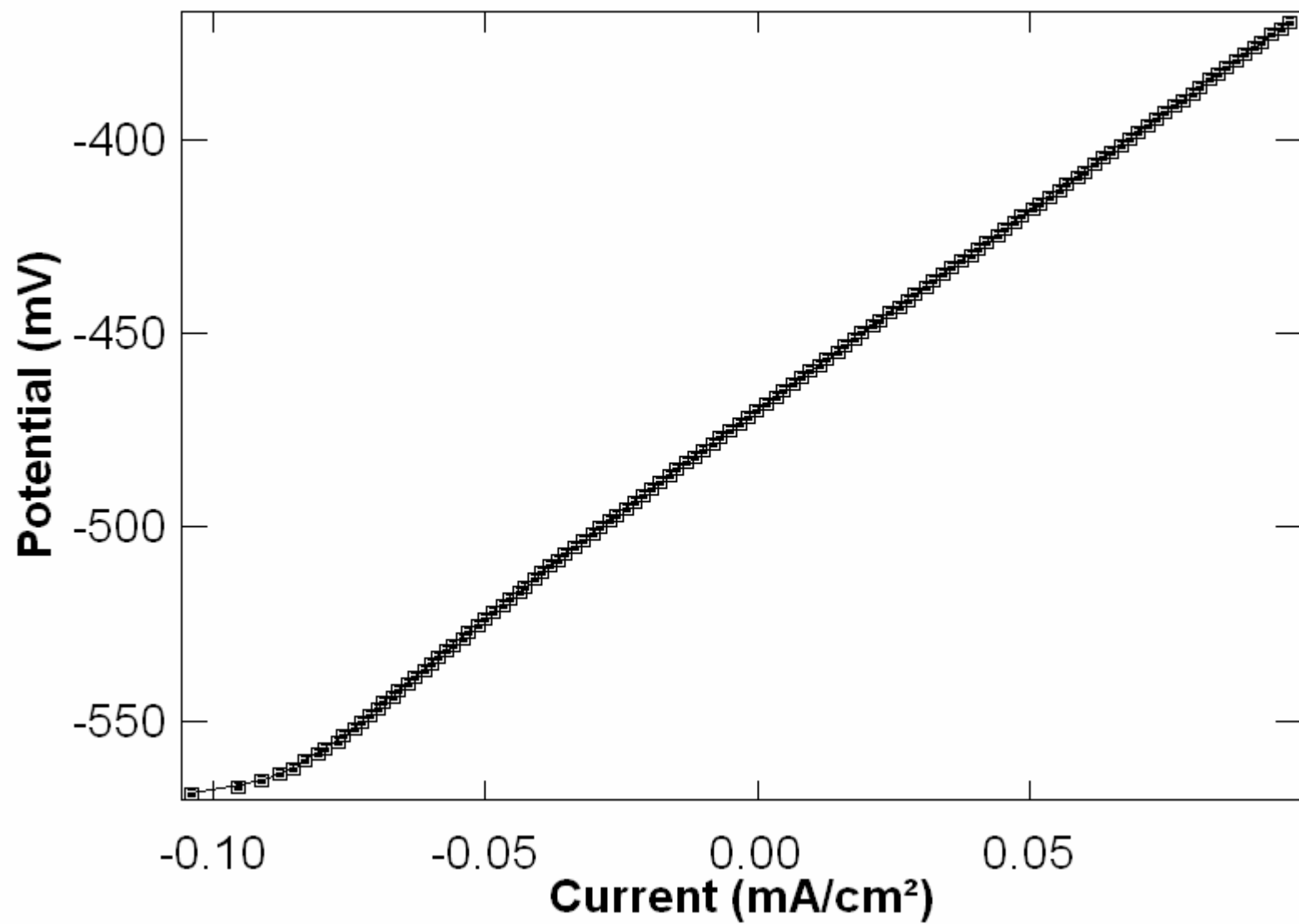

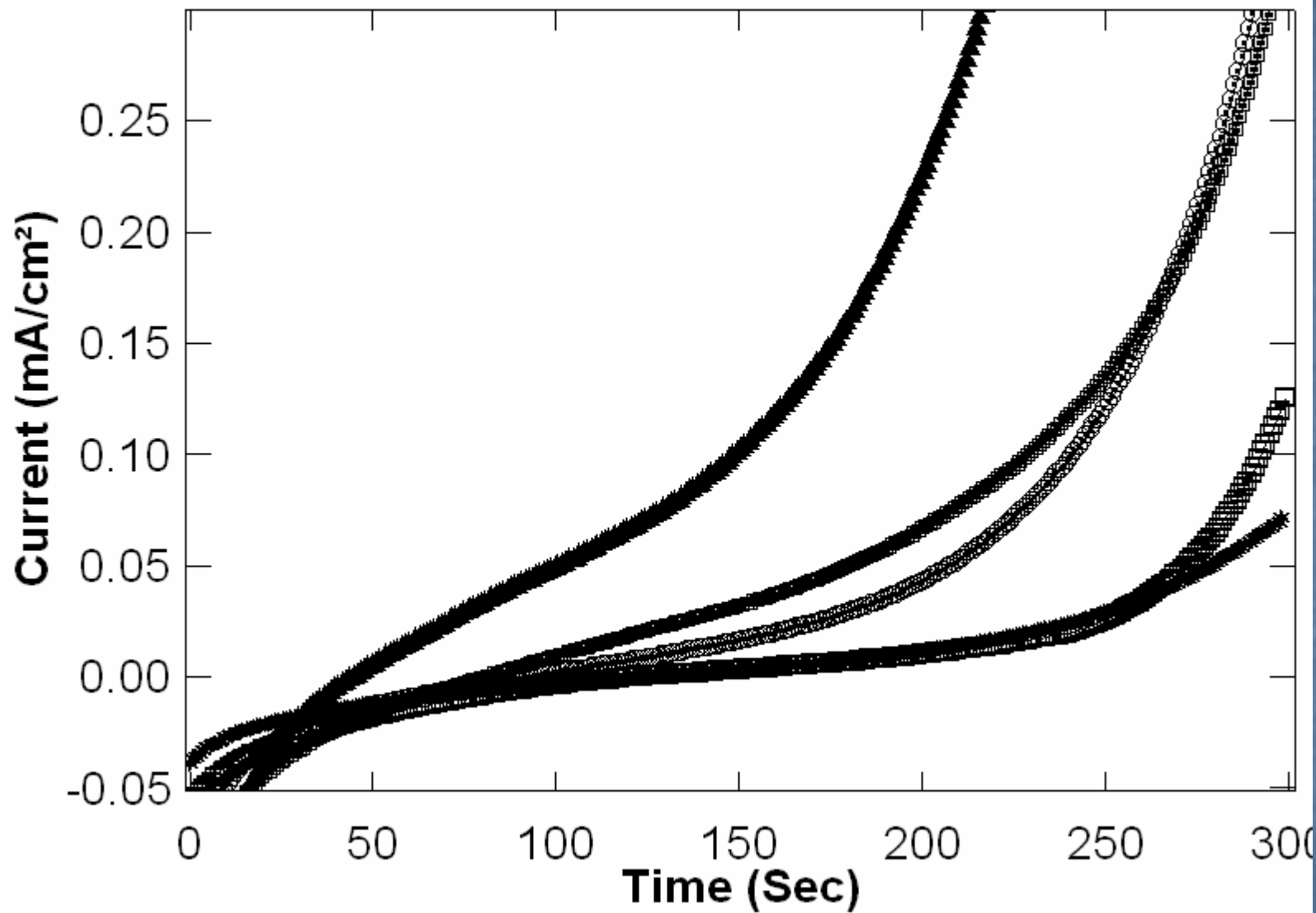

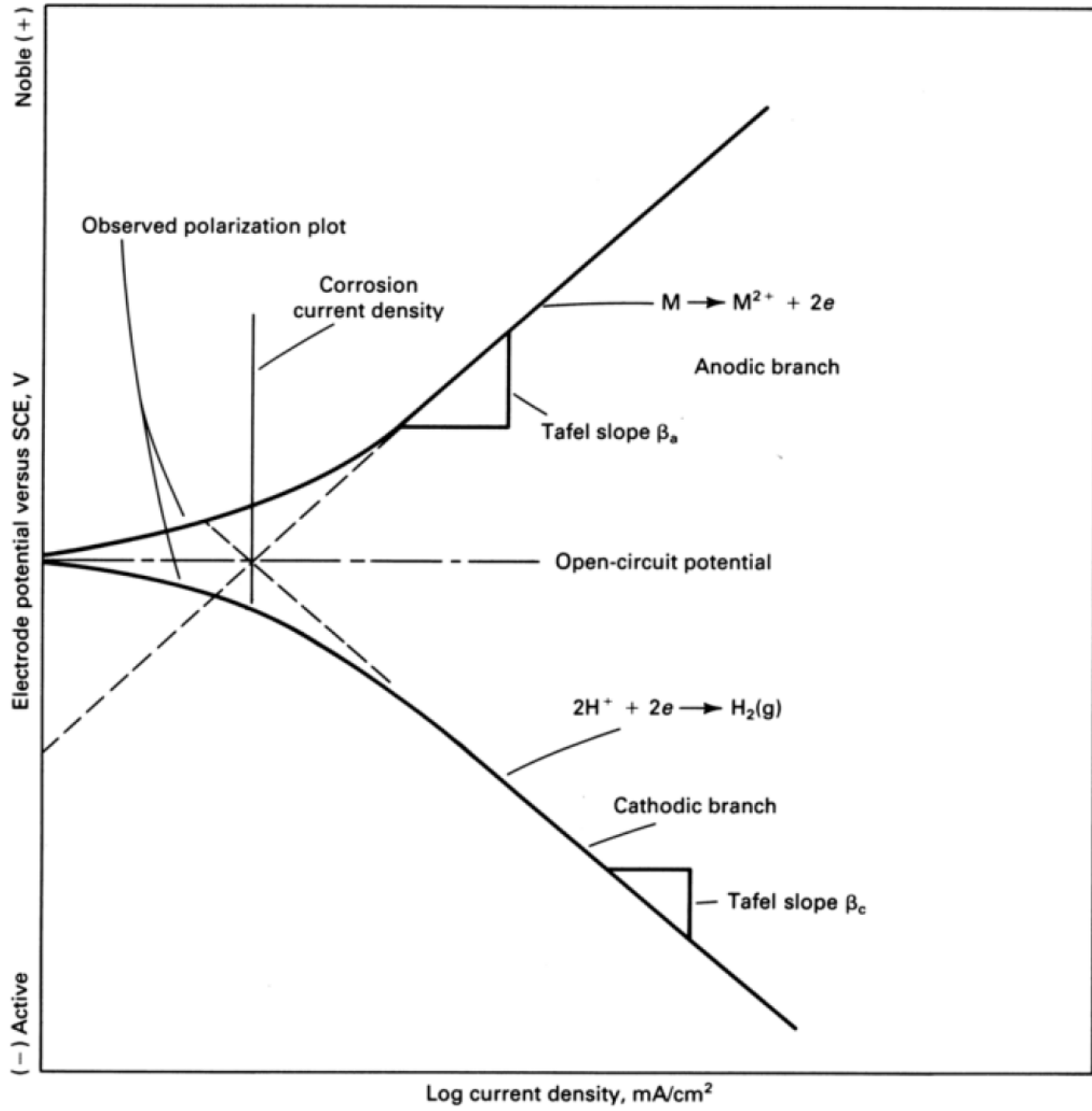

Electrode potential versus SHE, V

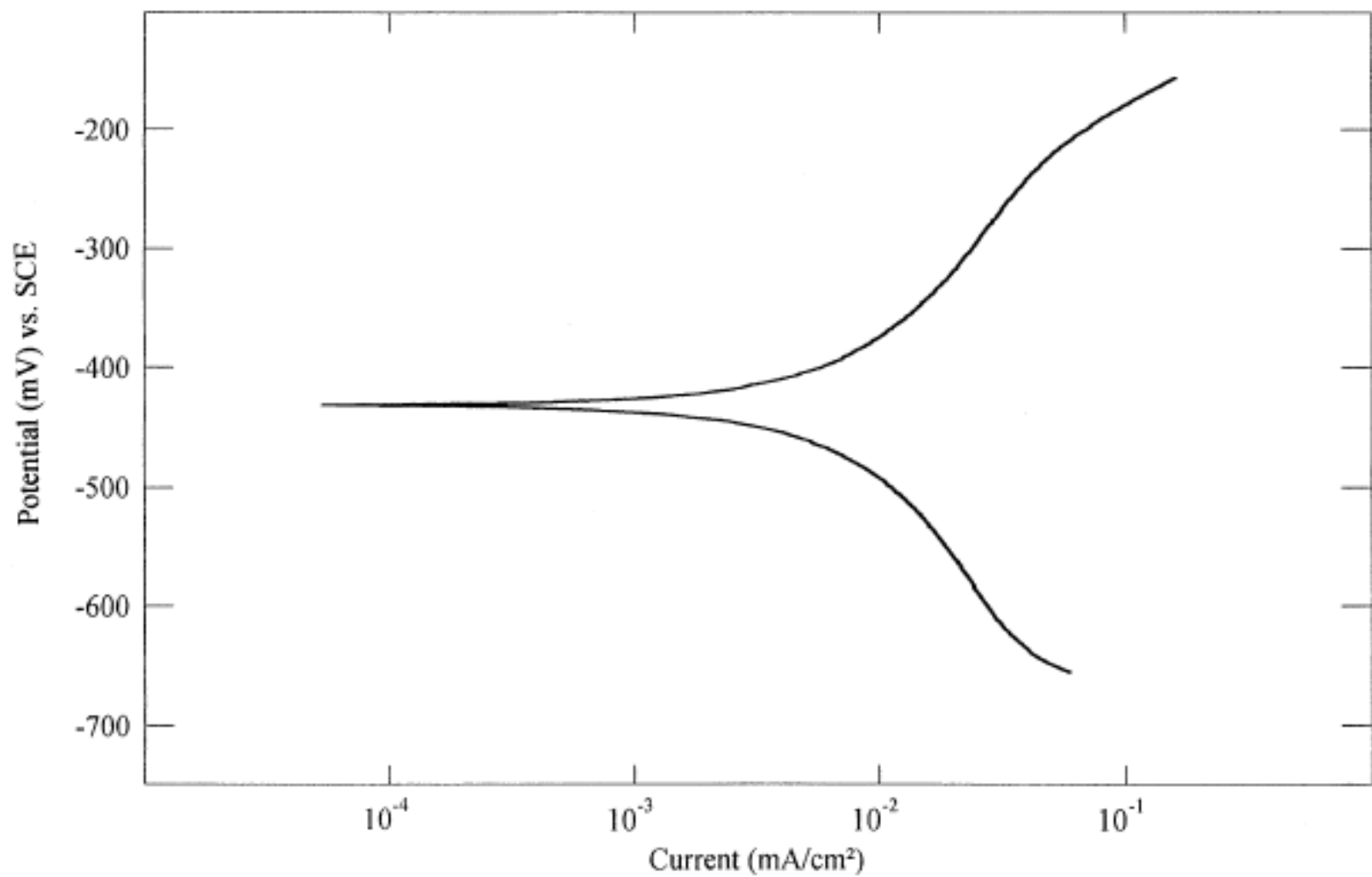

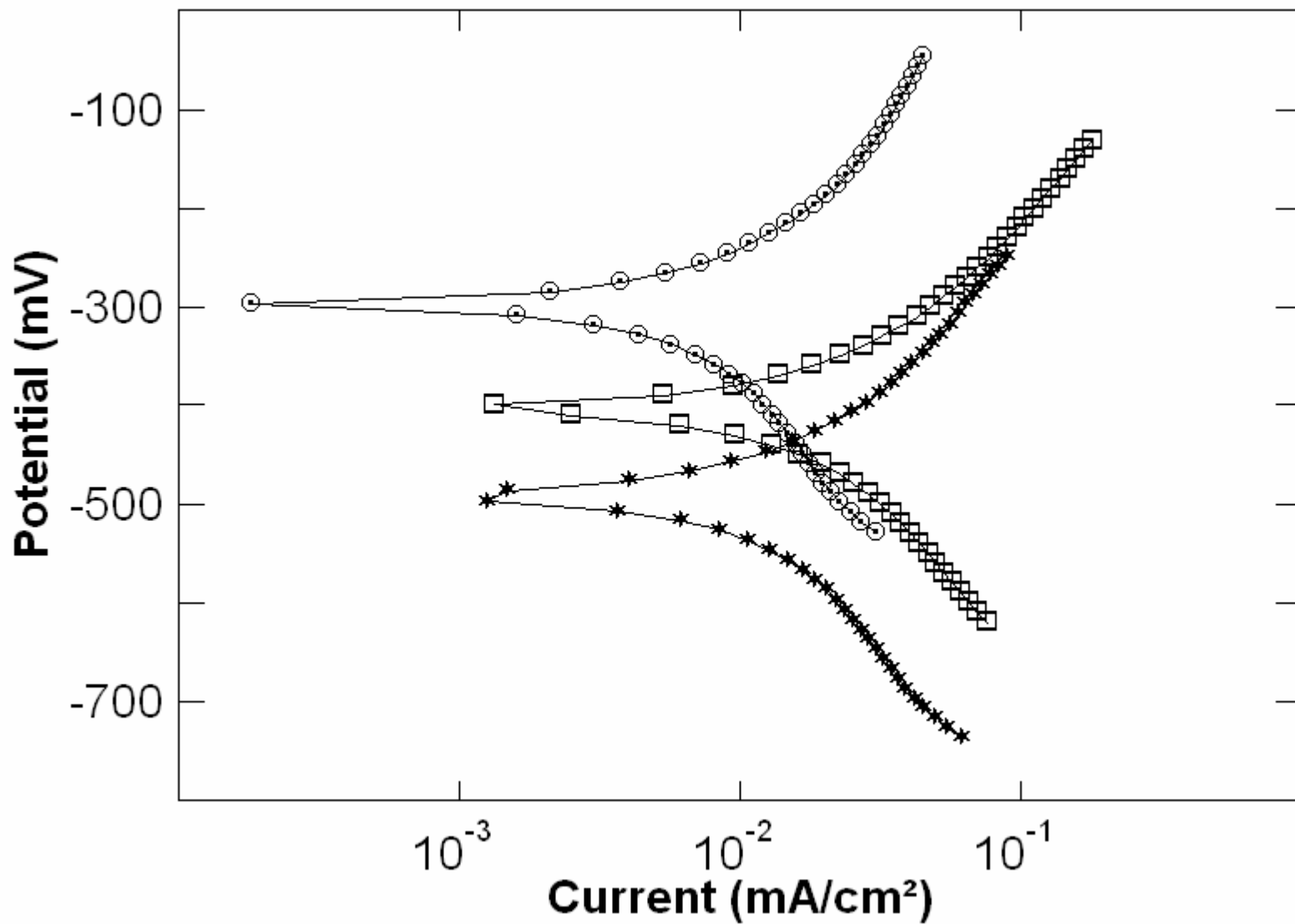

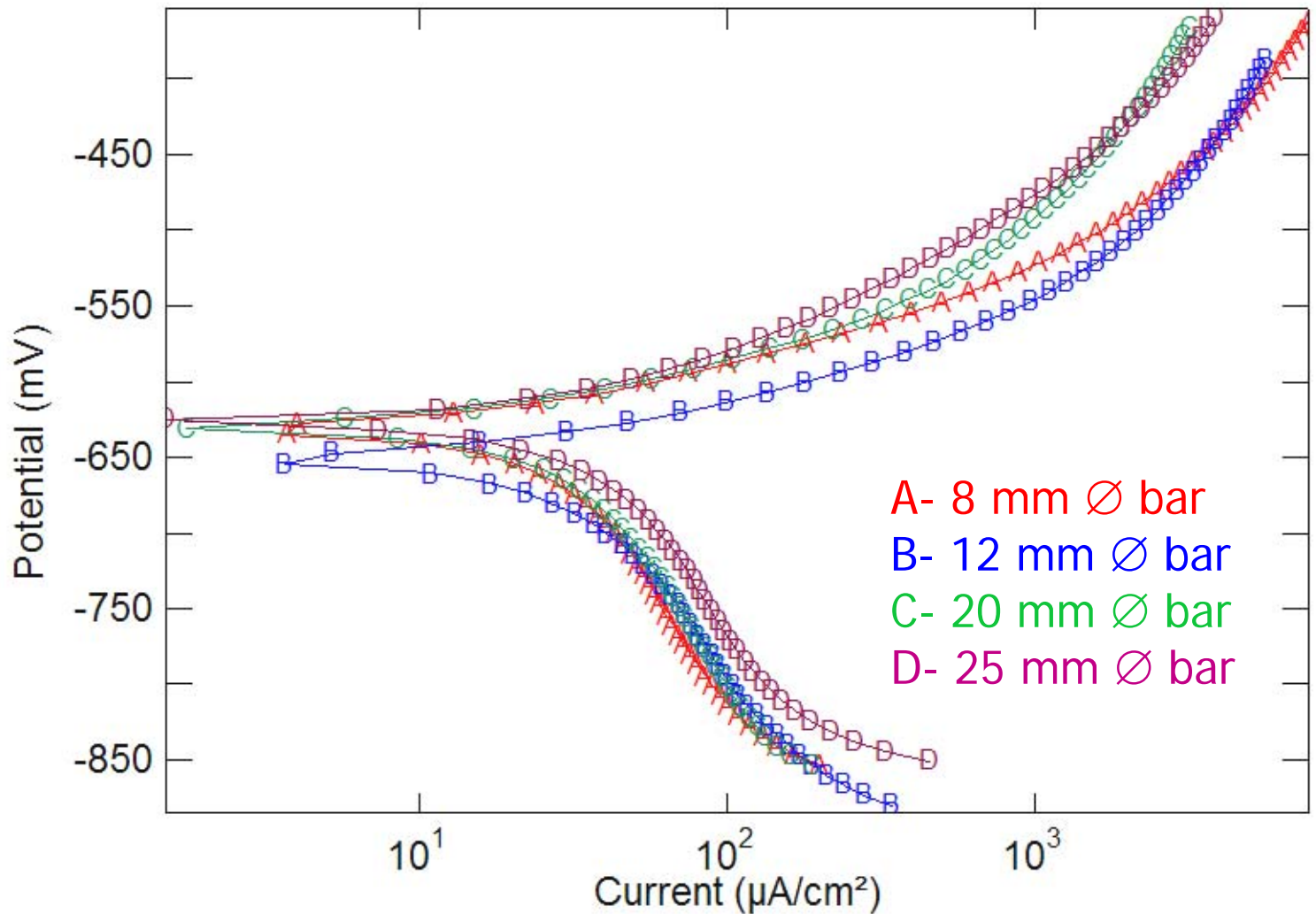

Potentiodynamic polarization curves of TMT bars in 3.5% NaCl performed as per ASTM G5-87

Corrosion potential, corrosion current density and corrosion rate of TMT bars evaluated by polarization test as per ASTM G 5 -87

Sample ID	E_{corr} (mV vs. SCE)	i_{corr} ($\mu\text{A}/\text{cm}^2$)	Corrosion rate*	
			(mils/year)	($\mu\text{m}/\text{year}$)
8 mm \varnothing bar	-630	24.11	11.00	280
12 mm \varnothing bar	-655	24.00	10.95	278
20 mm \varnothing bar	-631	24.08	10.99	279
25 mm \varnothing bar	-625	24.00	10.95	278

* Average of 3 determinations.

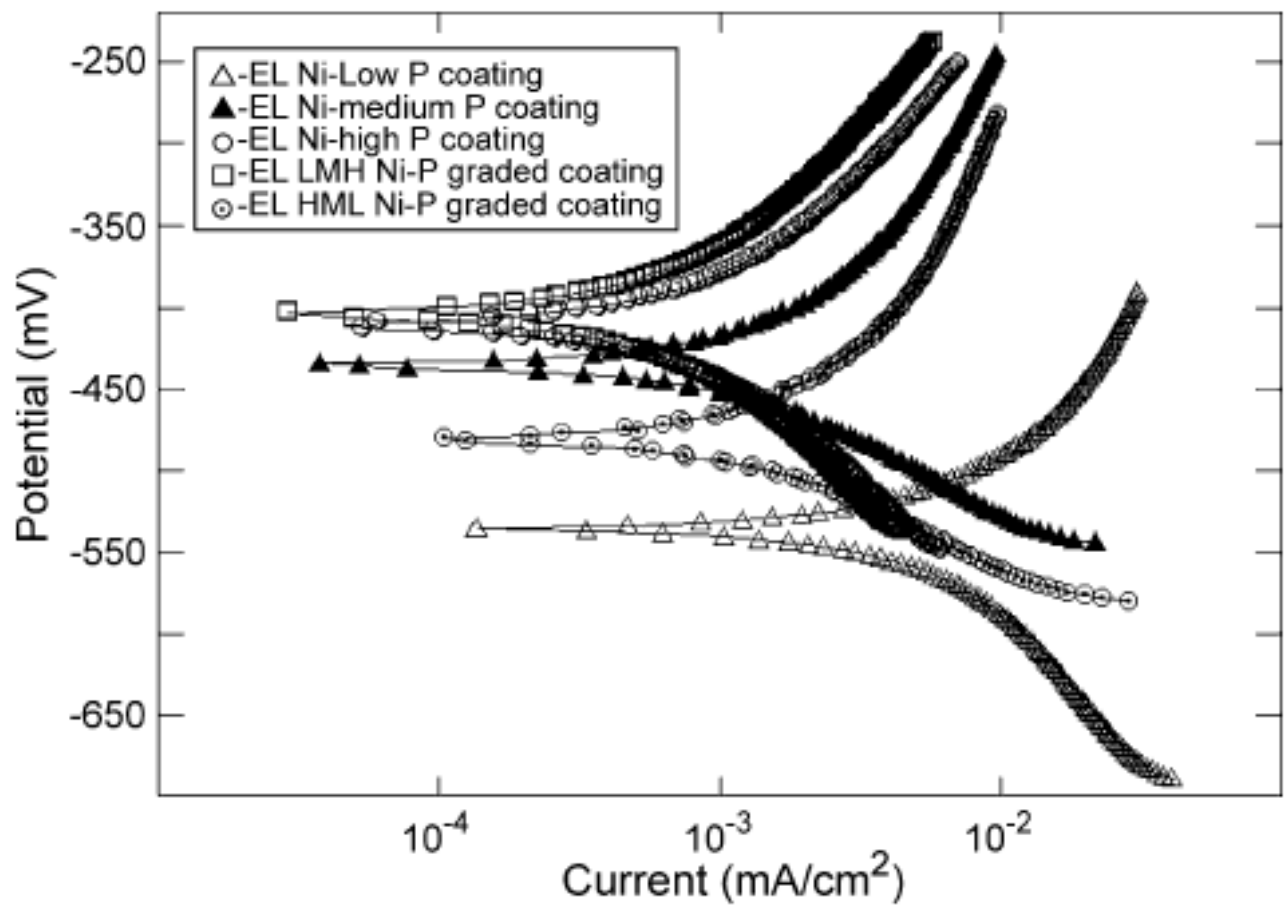

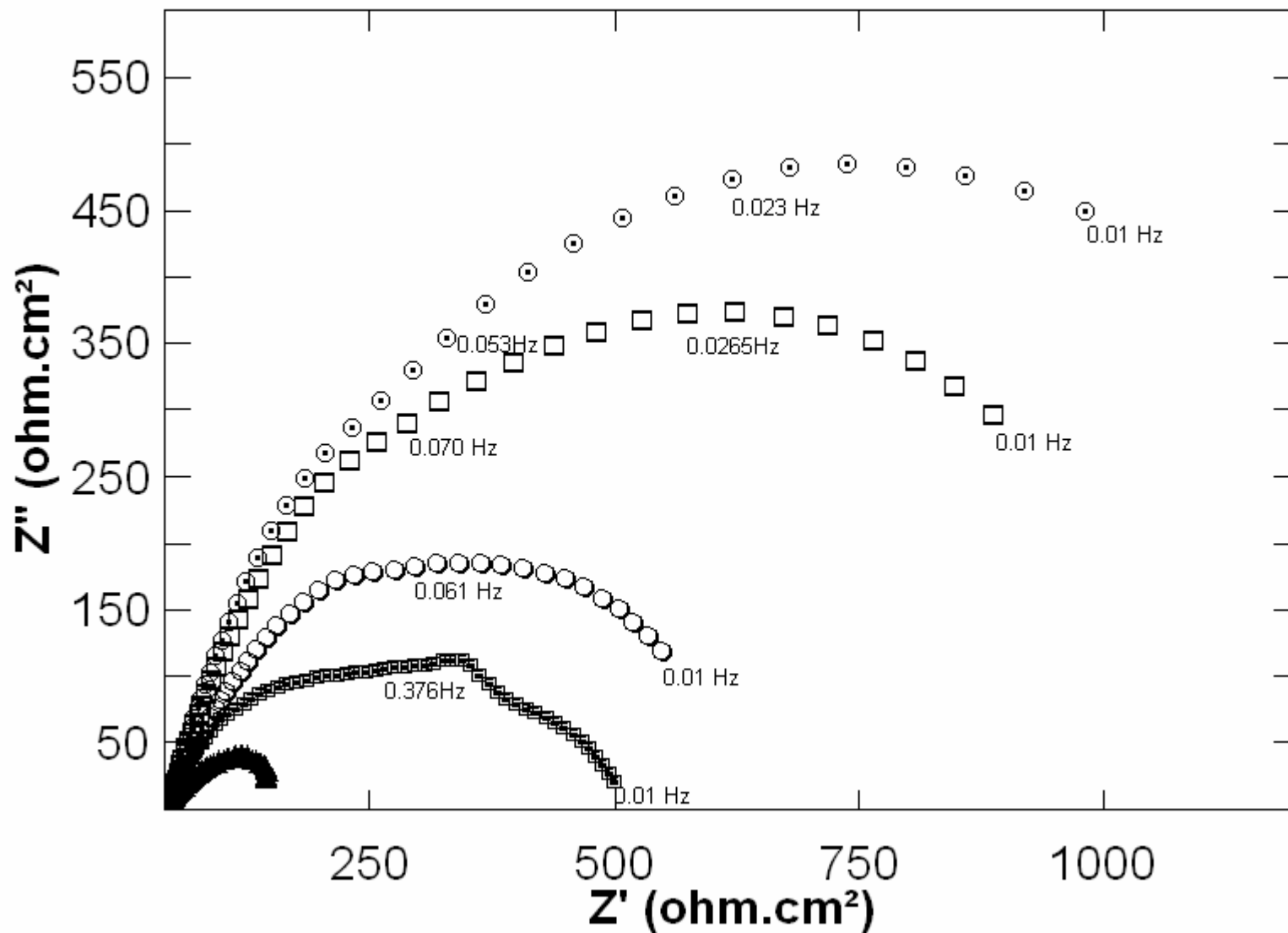

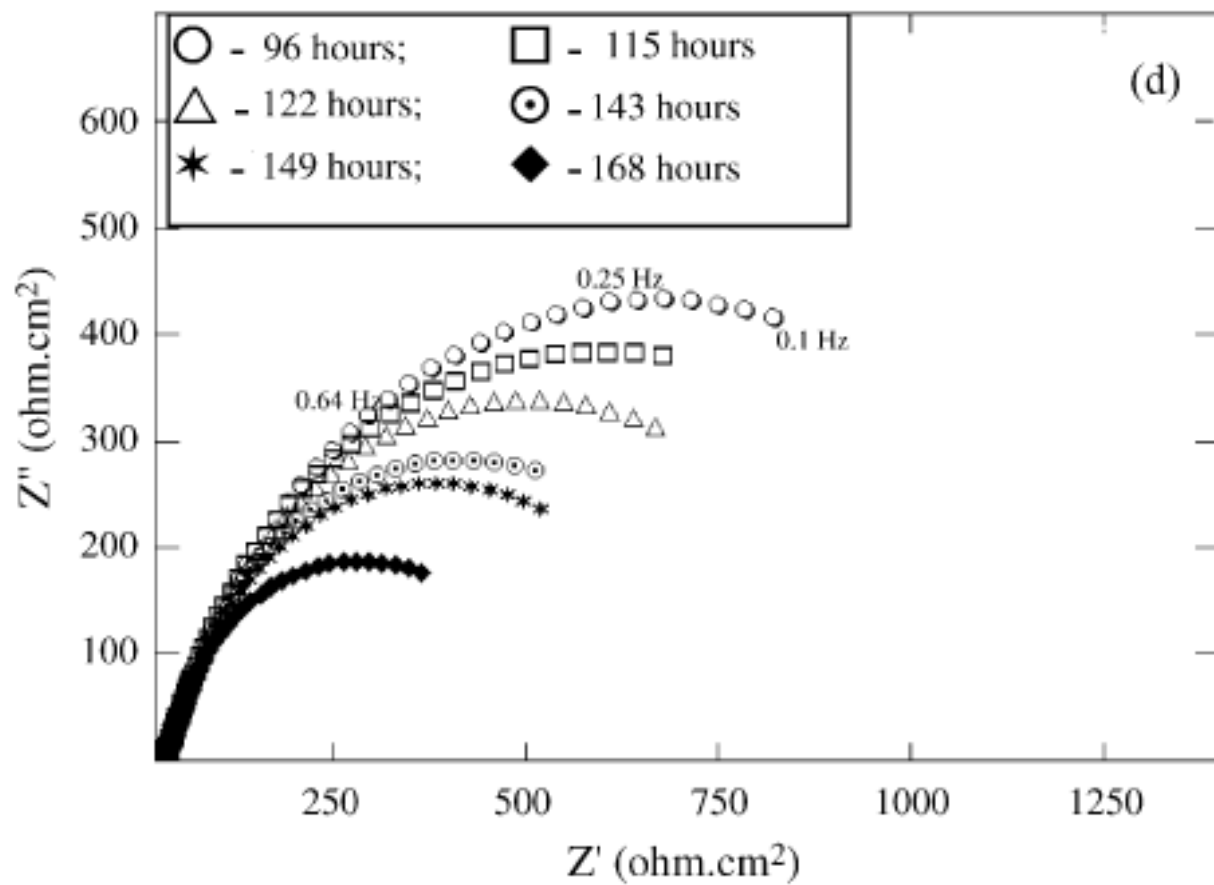

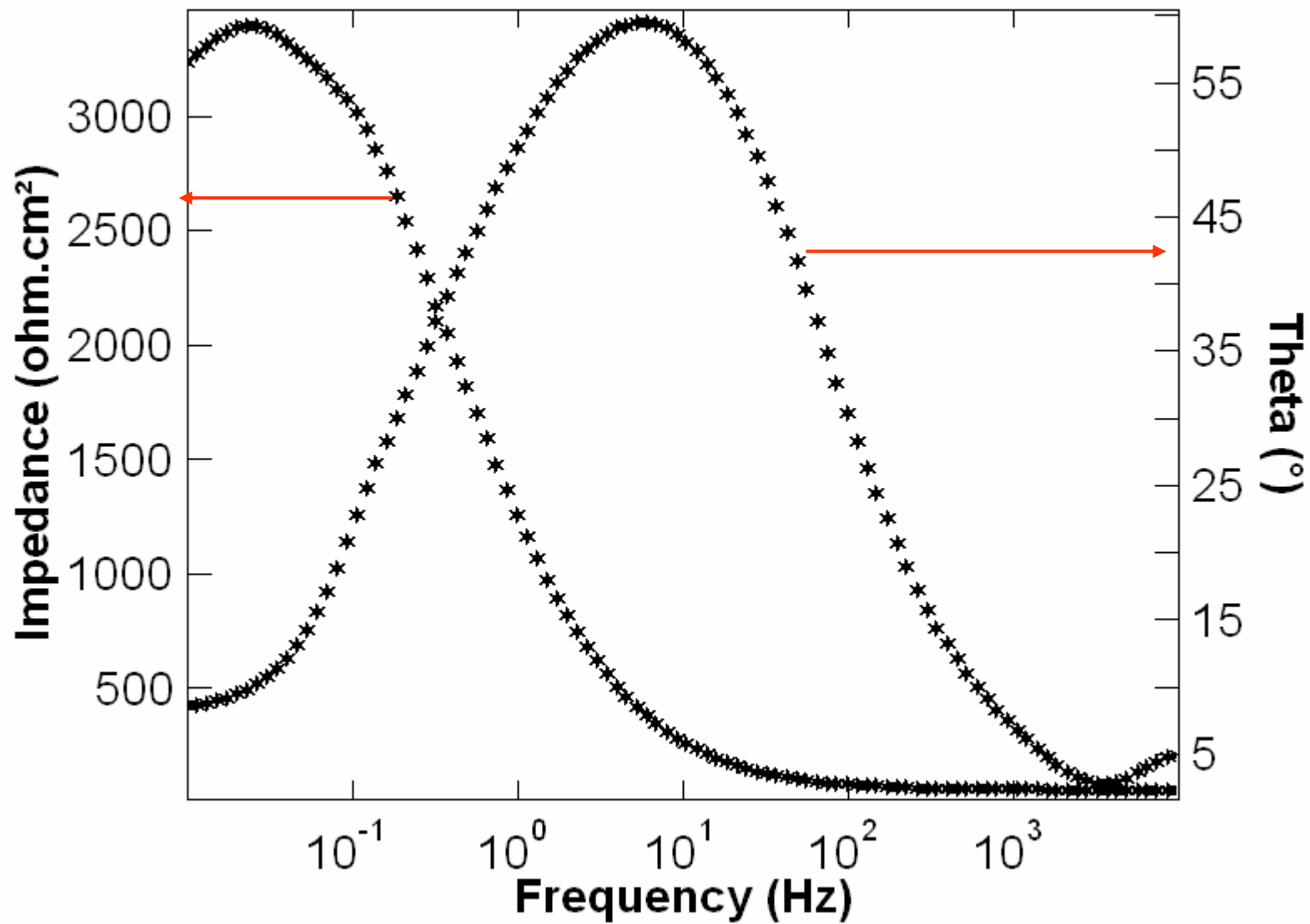

Methods of corrosion protection



Corrosion protection – choices?

- ❖ Corrosion – material and environment
- ❖ Corrosion protection
 - ❖ Modification of the environment
 - ❖ Modification of the material
- ❖ Alloying
 - ❖ Cu, Ni, Mo, Cr in steel
 - ❖ stainless steel – 304 – Ni and Cr; 316 grade – Mo
- ❖ Galvanic coupling – steel with zinc – cathodic protection
- ❖ Coatings – non-metallic, metallic and organic coatings – physical barrier between the material and the environment
- ❖ Inhibitors – chemical compounds by virtue of their adsorption modify the surface

Modification of the environment

- ✓ Rust preventive oil
- ✓ Inhibitors
 - ✓ Phosphates
 - ✓ Chromates
 - ✓ Organic compounds
 - ✓ Amines
 - ✓ Azoles - Cu alloys – MBT, MBI,
- ✓ Vapour phase corrosion inhibitors
 - ✓ Cyclohexylamine

Vapour phase corrosion inhibitors

- A VCI can be an individual chemical or combination of chemicals (mostly organic) having high vapor pressure that can prevent the reaction of the metal with the environment
- The VCI must be capable of forming a relatively stable bond at the metal interface, thus producing a protective layer that limits the penetration of corroding species
- VCI assumes significance for corrosion prevention in recent years
- Use of camphor in a gun case to protect it from corrosion was practiced in Sweden in the 19th Century

Mechanism of corrosion protection by vapour phase corrosion inhibitors

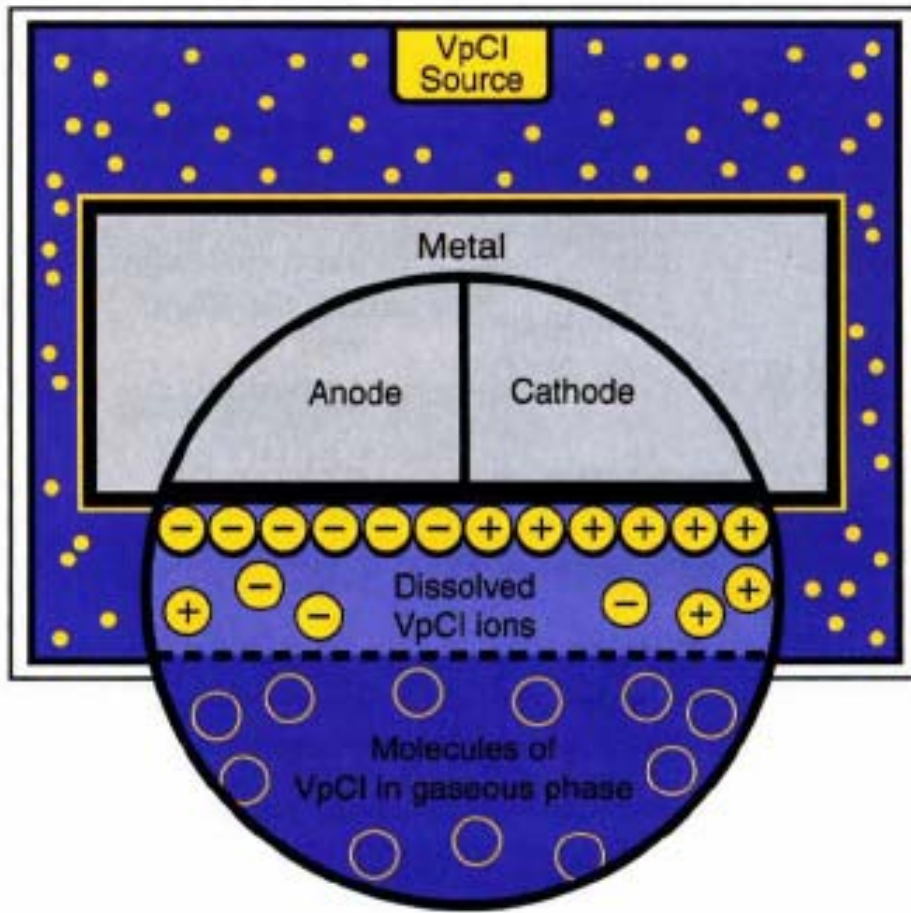

1. VCI vaporize and ionize
2. VCI vapour condenses on metal surface
3. VCI ions dissolve in the moisture
4. VCI ions migrate towards the metal - even the recessed areas and cavities
5. VCI ions form a thin protective film
6. Protective layer re-heals and self-replenishes through further condensation of the vapour

Mechanism of corrosion protection by vapour phase corrosion inhibitors

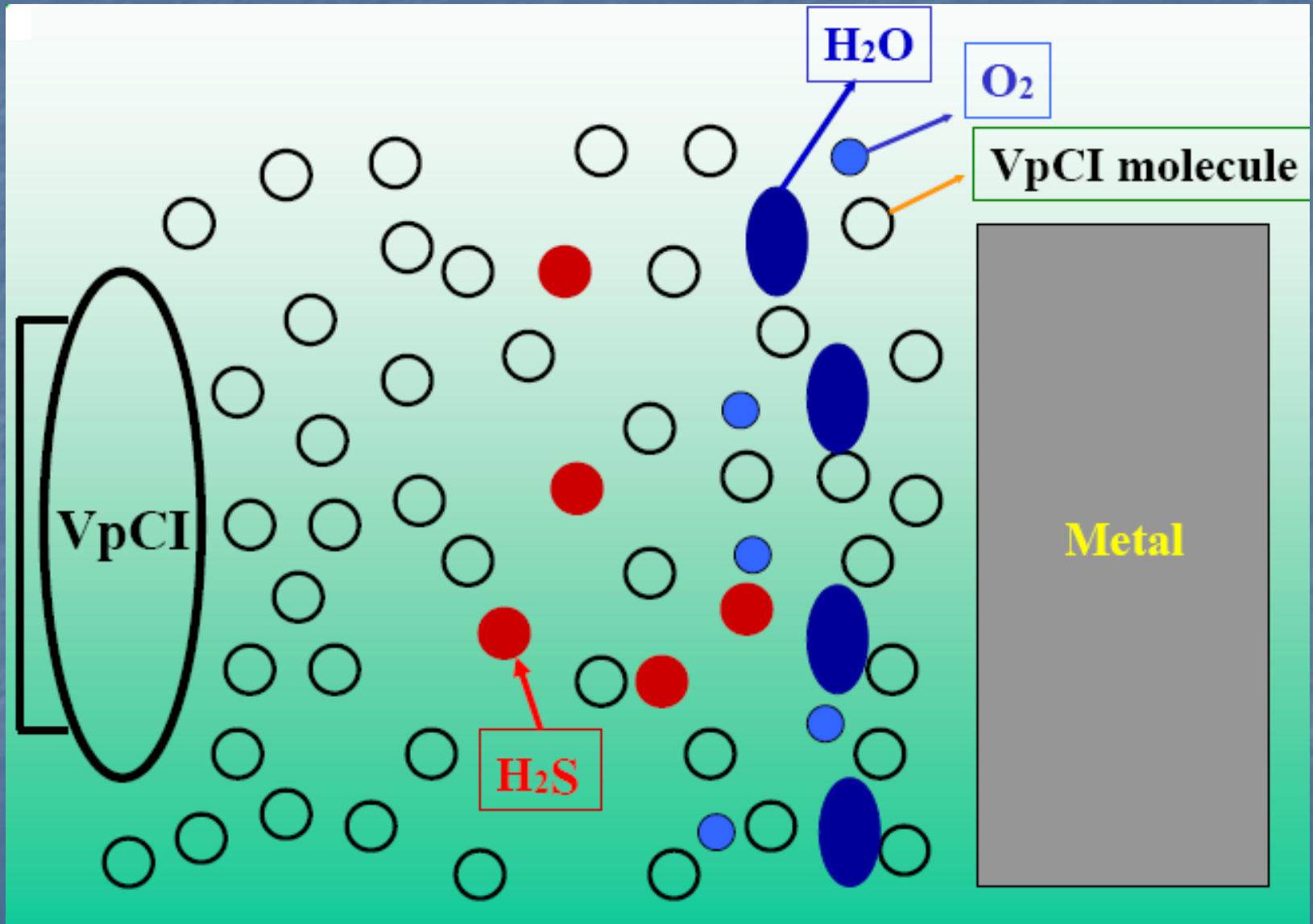

Salient feature of VCI based products

- ⦿ Offers protection to a wide range of ferrous, non-ferrous and composite metals by direct contact, as well as distant vapor phase
- ⦿ Mono - Ionic VCI layer does not affect electrical, optical, mechanical surface properties.
- ⦿ Carries sufficient load of chemicals and is self-replenishing, thereby permitting inspection and re-packing
- ⦿ Eliminates conventional messy and polluting methods

VCI papers/corrugated boxes

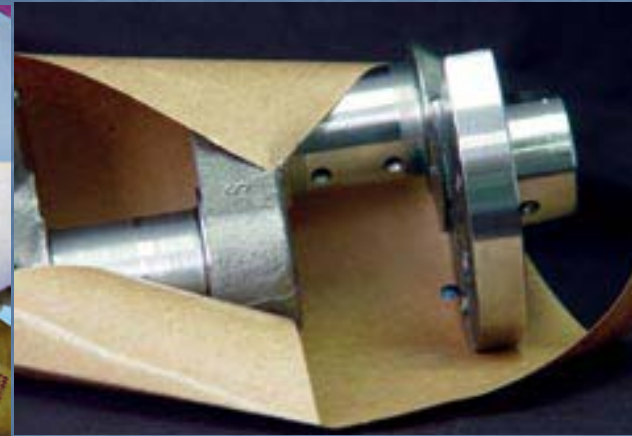

Prepared using specially matured kraft -papers impregnated with VCI to provide an extremely dry method of protection

VCI emitters



A porous device loaded with VCI

The porosity enables an easy evaporation of the VCI

They are compact, self-sticking and easy to install in closed electrical and electronic panels

VCI plastic and stretch films/pouches



A 50/100 micron thick polyethylene film impregnated with VCI to protect ferrous and non-ferrous metals from corrosion/oxidation

VCI antistatic film

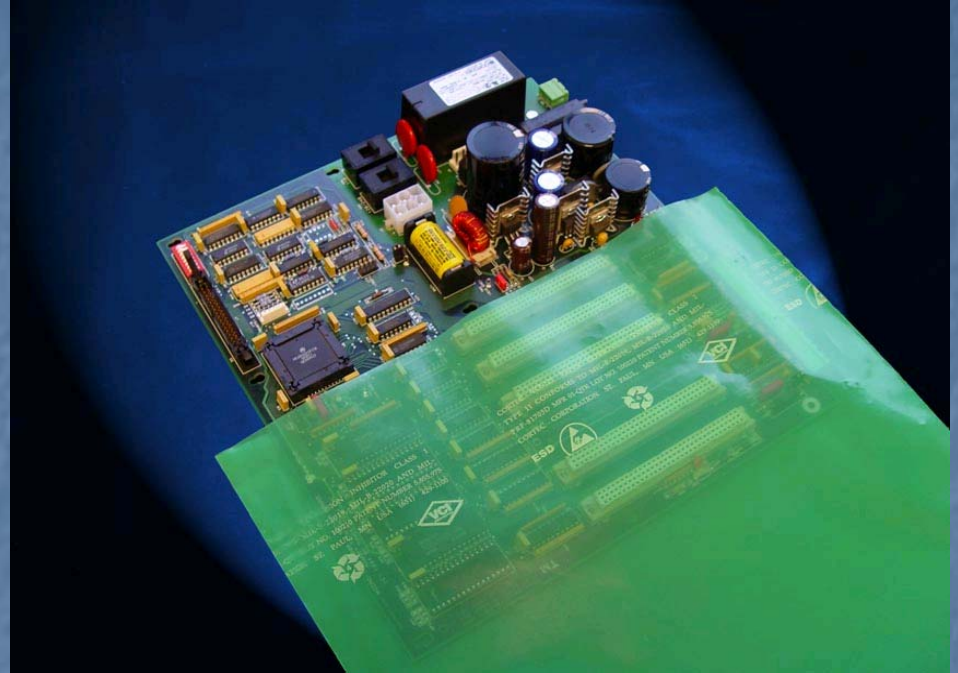

VCI antistatic film is commonly used for electrical & electronic product packing

These films are manufactured by extrusion process using high performance resin and special additives, which makes them superior to conventional packaging films

VCI oils



VCI is dispersed in an oil base

It is ideal for closed systems like fuel tanks, gearboxes, engines, engine oil sumps, hydraulics etc.

Most viable option where VCI paper, VCI Powder, VCI Tablets cannot be used

Corrosion of cold rolled steel finished with rust preventive oils and oil containing vapour phase corrosion inhibitors

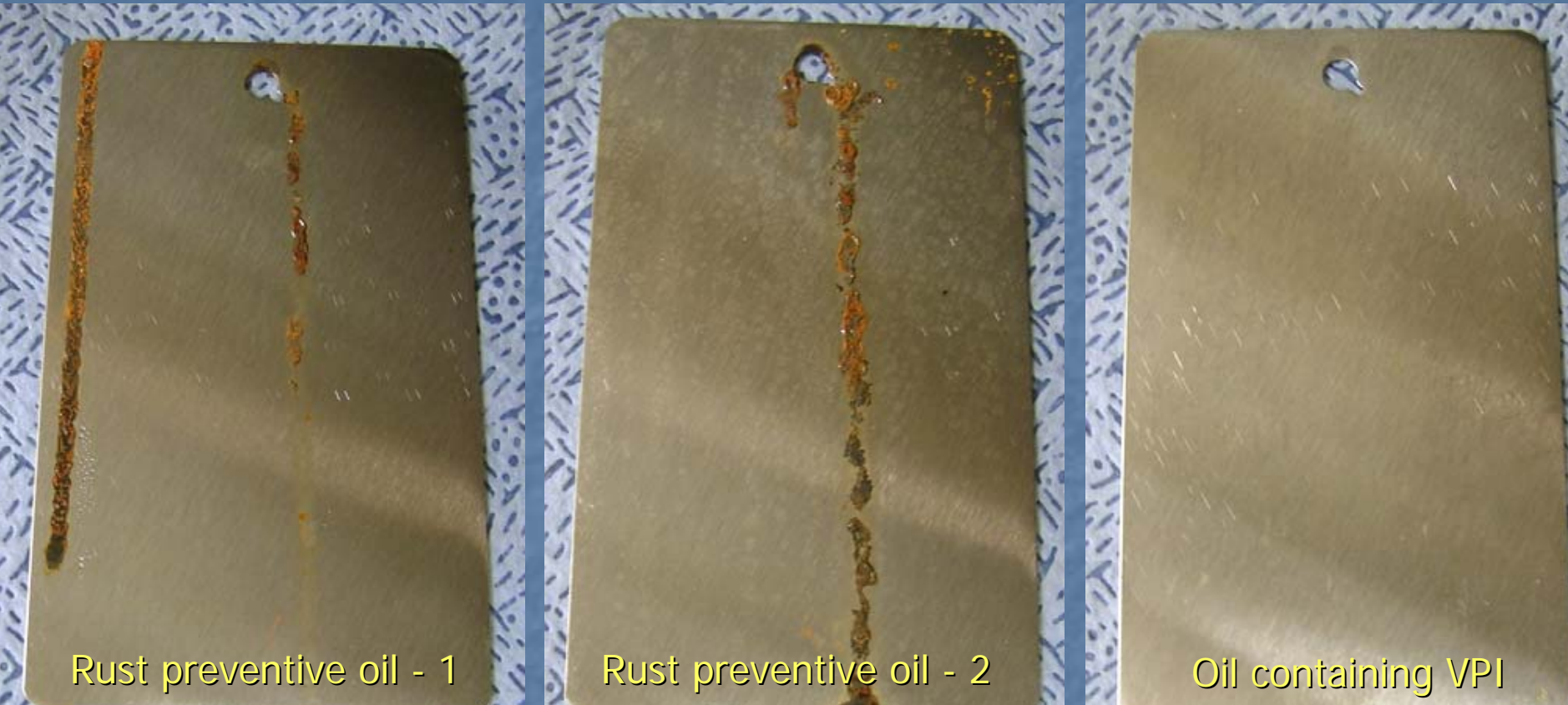

Surface appearance and extent of corrosion of cold rolled steel after 600 hours of exposure to 95 % relative humidity (as per ASTM D 1748)

Corrosion of carbon steel finished with rust preventive oils and oil containing vapour phase corrosion inhibitors



Surface appearance and extent of corrosion of cold rolled steel after 600 hours of exposure to 95 % relative humidity (as per ASTM D 1748)

VCI powders and tablets



They can be effectively used in difficult to access areas

From nuts and bolts to planes and pistols -
VCI technology will work



Intercept Technology™ for corrosion protection

- ❖ Developed by Lucent Bell Labs
- ❖ Developed by reacting solid state reactive materials into a polymer matrix.
- ❖ These reactive materials react with and neutralize all corrosive gases that contact the film

How Intercept Works?

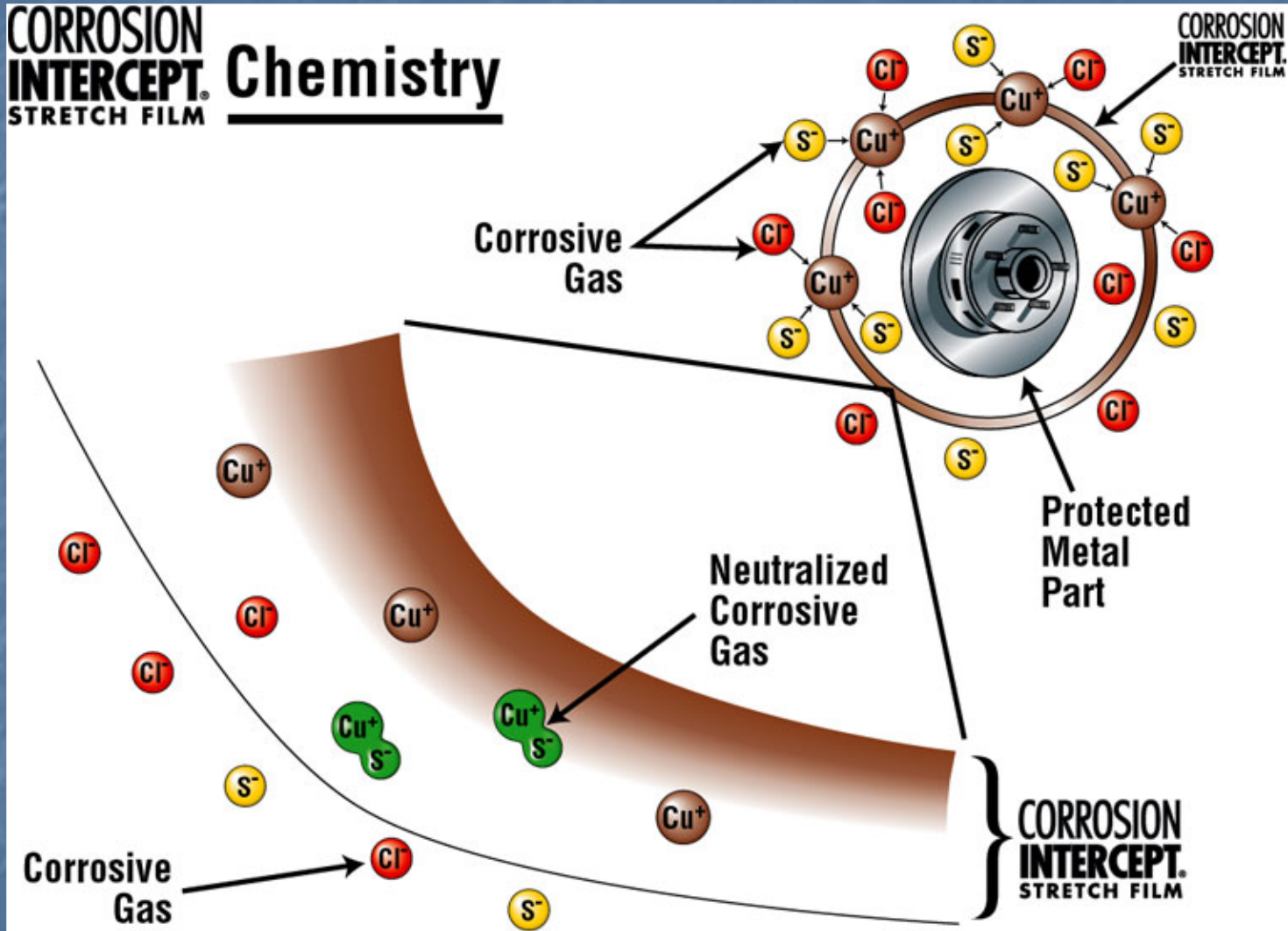

Intercept Technology™ for anti-tarnish protection of silver jewelry and articles



Other methods of corrosion protection

- Phosphate conversion coatings
- Anodizing (anodic oxidation)
- Electrodeposition
- Electroless deposition
- Cathodic and anodic protection

CONVERSION COATINGS



Chemical conversion coatings

- ❖ Adherent, insoluble, inorganic surface films, formed as an integral part of the metal surface by means of a non-electrolytic chemical reaction between the metal surface and the solution
- ❖ A portion of the base metal is converted into one of the components of the resultant protective film
- ❖ Adherent nature, high speed of coating formation and cost-effectiveness makes conversion coatings a preferred method of surface pretreatment
- ❖ Phosphating, chromating and oxalating – major classes of chemical conversion coatings



Phosphate conversion coatings

- ❖ Phosphating - defined as the treatment of a metal surface so as to give a reasonably hard, electrically non-conducting surface coating of insoluble phosphate, which is highly adherent to the underlying metal and is considerably more absorptive than the metal.
- ❖ The coating is formed as a result of a topochemical reaction, which causes the surface of the base metal to integrate itself as a part of the corrosion resistant film.



Chemistry of phosphating

- ❖ Iron dissolution is initiated at the microanodes by the free phosphoric acid present in the bath. Hydrogen evolution occurs at the microcathodic sites



- ❖ Formation of soluble primary ferrous phosphate - local depletion of free acid concentration - rise in pH at the interface - alters the hydrolytic equilibrium - rapid conversion & deposition of insoluble tertiary phosphates

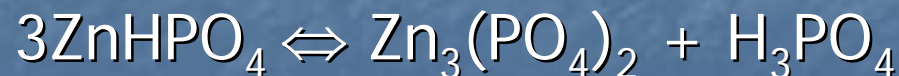

Phosphating process

- ❖ Phosphating compositions are essentially dilute phosphoric acid based solutions containing alkali metal/heavy metal ions in them besides suitable accelerators.
- ❖ Based on the nature of the metal ion constituting the major component of the phosphating solution, these compositions are classified as zinc, manganese and iron phosphating baths
- ❖ Phosphate coating could be deposited on both ferrous and non-ferrous metals. Low carbon steel - most frequently used - maraging steels, galvanized steels and stainless steels can also be coated.
- ❖ Non-ferrous metals that can be phosphated include zinc, aluminium, magnesium and cadmium.



Phosphating process

- ❖ Phosphate coating formation - spray and immersion processes - choice depends upon the size and shape of the substrate and the end use of the coating
- ❖ Spray process - preferred where the processing time is shorter - requires more floor space and special equipment for their application.
- ❖ Immersion process - relatively slower, produce uniform coatings and require less floor space - more susceptible to contamination during continuous operation
- ❖ Smaller parts can be effectively and economically phosphated by immersion process whereas spray process is more suitable for larger work pieces.
- ❖ Operating temperature range from 30-99°C- processing time varied from a few seconds to several minutes



PHASE CONSTITUTENTS OF PHOSPHATE COATING

- ❖ Determined by the type of heavy metal used in the bath and the type of material coated
- ❖ Zinc phosphate coating formed on steel consists of
 - ❖ phosphophyllite ($\text{Zn}_2\text{Fe}(\text{PO}_4)_4 \cdot 4 \text{H}_2\text{O}$) and hopeite ($\text{Zn}_3(\text{PO}_4)_4 \cdot 4 \text{H}_2\text{O}$) phases
- ❖ Phase constituents decides the quality of the coating – determined by XRD.



Coating weight

- ❖ Parameter that decides the choice of the phosphating bath - usually quantified in terms of weight per unit area (usually as g/m^2 or mg/ft^2)

IS 3618: 1966

- ❖ Class A1 – Heavy weight Mn & Fe phosphate $\geq 7.5 \text{ g/m}^2$
- ❖ Class A2 – Heavy weight Zn phosphate $\geq 7.5 \text{ g/m}^2$
- ❖ Class B2 – Medium weight Zn/Mn/Fe $\geq 4.3 \text{ g/m}^2$
- ❖ Class C2 – Light weight Zn/Mn/Fe - 1.1 to 4.3 g/m^2
- ❖ Class D – Extra light weight Fe phosphate – 0.3 to 1.1 g/m^2
- ❖ Higher coating weight does not directly relate to corrosion performance. Coating weight in relation to other characteristics - structure, homogeneity, etc.



Porosity of phosphate coating

- ❖ The layer of phosphate coating consists of numerous crystals of very different sizes - inherently implies the existence of fissures and channels through to the basis metal – porosity
- ❖ Fairly low, of the order of 0.5 - 1.5% - Decreases with increasing phosphate coating thickness
- ❖ Type of phosphate solution, treatment time, iron content of the bath and the chemical composition of the coating determines the porosity of the coating
- ❖ Detrimental effect on corrosion performance- could act as large reservoirs for oils
- ❖ A homogeneous fine-crystalline coating is desirable to improve the adhesion of a paint film



Applications of phosphate coating

- ❖ Corrosion protection, as a base for paint, to provide wear resistance and an aid in cold forming of steel.
- ❖ Provide an effective physical barrier to protect corrosion-prone metals against their environment
- ❖ Their insulating nature prevent the onset and spreading of corrosion.
- ❖ Provide an effective base for the application of paints and this constitutes the most widespread application – served as an excellent base even for electrophoretic painting and powder coating
- ❖ Reduces wear on machine elements and moving parts - function as lubricants - their ability to retain oils and soaps further enhances this action.



Applications of phosphate coating

- ❖ Deep drawing operations sets up a great amount of friction between the steel surface and the die – this will decrease the speed of drawing operation as well as the service life of tools and dies.
- ❖ Enables distribution and retention of a uniform film of lubricant, prevents metal to metal contact and makes possible the cold forming and extrusion of more difficult shapes - prevents welding and scratching of steel and decreases the rejections.
- ❖ As absorbent coatings for laser surface hardening



Phosphating as a paint base

- ❖ Uniformity, improved adhesion and ability to prevent underfilm corrosion – paint base
- ❖ Thin coating 0.3-6 g/m² – zinc phosphate
- ❖ Attributes of paint coatings – corrosion resistance and adhesion – could be modified by the application of phosphate coating
- ❖ When a paint film is damaged and the underlying steel is exposed – in presence of a corrosive medium, differential aeration results in the formation of local cathodic and anodic sites – results in corrosion of the base metal and peeling of the paint film – the insulating nature of phosphate coating prevents such a failure



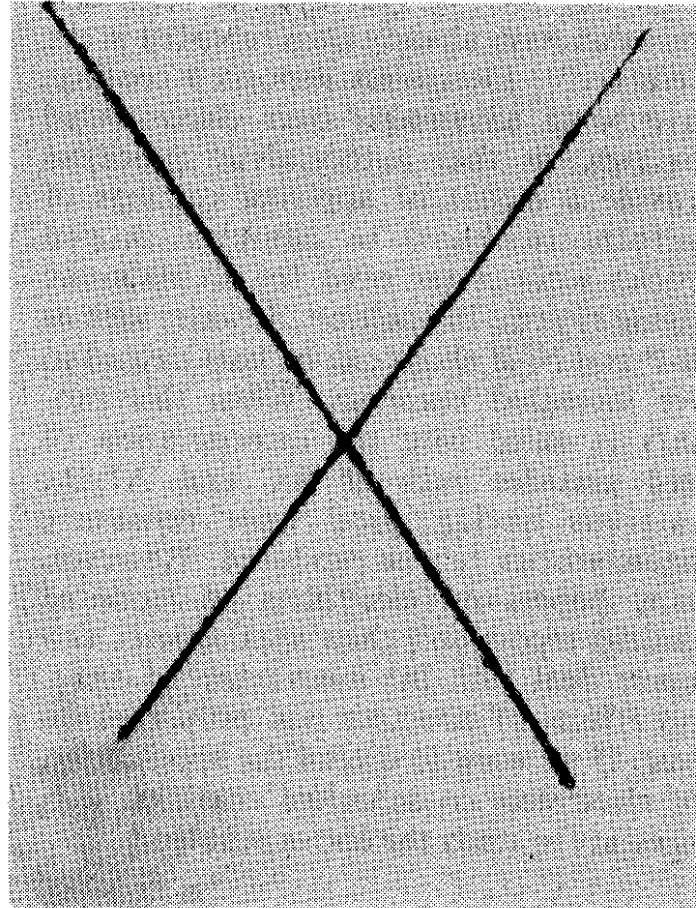

Performance in salt spray test (after 96 hours)



Pretreatment for electrocoating

- ❖ Cathodic electrocoating - finishing of automotive body panels – improves corrosion resistance of the total paint system - improved throwing power
- ❖ Compatibility of the pretreatment and cathodic electrocoating is essential to achieve the proclaimed benefit since any weak link in the system will lead to a total failure
- ❖ Is zinc phosphating adopted as a paint base is compatible with cathodic electrocoat?
- ❖ Warrants modification in the pretreatment cycle, specifically in phosphating formulations



Cathodic electrocoating

- ❖ Inherent problem of cathodic electrocoating
 - ❖ Generation of hydroxyl ions following decomposition of water
 - ❖ Causes dissolution of the phosphate coating
 - ❖ Approximately 30-40 % of the coating is dissolved resulted in greater porosity of the phosphate coating
 - ❖ Occlusion of the dissolved ions which are subsequently concentrated during paint baking affects the corrosion resistance



Cathodic electrocoating

- ❖ Changes during curing after electrocoating
 - ❖ Cathodic electrocoated panels are usually cured at 180 deg.C for 20 min.
 - ❖ Phosphate coating will undergo a definite weight loss associated with a structural change in the constituent crystals
 - ❖ Loss in weight should be restricted to less than 15%
 - ❖ Cause deterioration of the phosphate coating and a loss in corrosion resistance



Cathodic electrocoating

- ❖ Problems due to rehydration of the dehydrated phosphate coating
 - ❖ Phosphate coating crystals that are dehydrated during paint baking have the ability to revert back to its original hydrated form when subjected to humid service conditions.
 - ❖ Rehydration of the phosphate crystals induces residual stresses and reduce the phosphate-paint adhesiveness



Lessons learned from cathodic electrocoating

- ❖ Phosphate coating used as a pretreatment for cathodic electrocoating should be capable of withstanding the thermal and chemical aggressions during the process – implies that the phosphate coating should be tested for their chemical and thermal stabilities
- ❖ Numerous studies were made by researchers – all of them uniformly agree that phosphate coatings richer in phosphophyllite possess greater alkaline stability and the ability to resist rehydration during service and could serve as effective bases for cathodic electrophoretic painting.



Corrosion protection by electro- and electroless deposited coatings

Electro- and electroless plated coatings for surface engineering

- ✦ Electro- and electroless plated coatings received widespread acceptance
 - ✦ Simple, versatile and cost-effective
 - ✦ Less complex processing sequence
 - ✦ Process methodologies can be easily tailored to meet the property requirements
 - ✦ Alloying of phosphorous/boron or incorporation of second phase particles in the metal matrix enables an improvement in hardness, wear resistance and corrosion resistance
 - ✦ Offers the possibility to prepare duplex, graded and multilayer coatings to suit the end use

Electrodeposition of metals

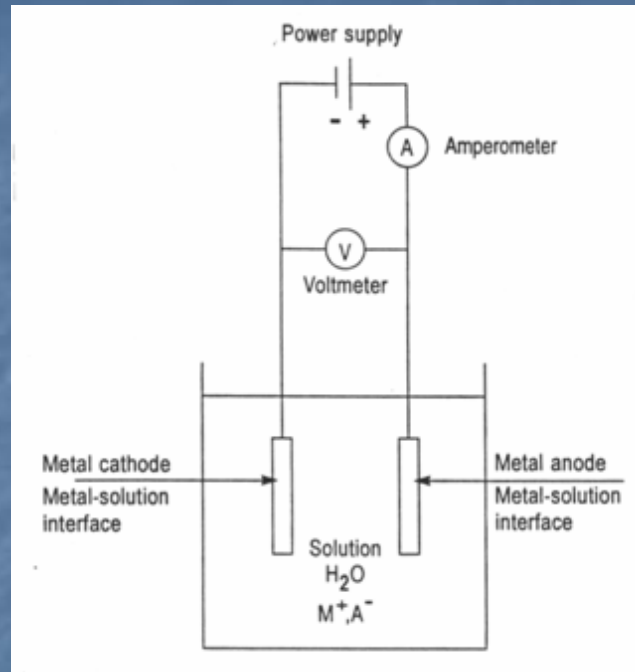

- ✚ Electrodeposition can be defined as the deposition of an adherent metallic coating for the purpose of securing a surface with properties or dimensions different from those of the base material.
- ✚ Electrodeposits are applied to metal substrates for decoration, corrosion resistance, wear resistance, electrical properties, magnetic properties, solderability, etc.

Various constituents of the electrolyte solutions used for electrodeposition of metals

Constituent	Functions	Example
Metal salt	To supply metal ions	CuSO_4 , NiCl_2
Complexant	Stabilize metal in soluble form; affect mode of ion discharge	KCN, NaOH
Complexant stabilizer	Excess complexant, acid or alkaline reagent	KCN, NaOH
Buffer salt	Stabilize pH at optimum value	H_3BO_3 , Na_2HPO_3
Anode depassivator	Smooth anode dissolution and oxide film disruption	Chloride
Addition agents	Surfactant for hydrogen bubble dispersal Brightener for bright deposits Leveler for grain refinement Stress reliever	Detergent Organic S and N containing compounds

Corrosion protection by electroplated coatings

- ✦ Electroplated coatings offer corrosion protection of substrate metals in three possible ways
 - ✦ Cathodic protection
 - ✦ sacrificial corrosion of the coating - ED Cd and Zn coatings on steel
 - ✦ Barrier action
 - ✦ use of a more corrosion resistant deposit between the environment and the substrate to be protected such as zinc alloy plated automotive parts, Cu-Ni-Cr and Ni-Cr coatings over steel
 - ✦ Environmental modification or control
 - ✦ combination with a non-impervious barrier layer - electrolytic tinfoil used in food packaging

Electroless deposition

- ✚ Electroless deposition process is an accidental discovery by Brenner and Riddell in 1946 when they tried to electroplate Ni-W alloy on the inner side of a steel tube using a citrate bath in presence of sodium hypophosphite
- ✚ Since the chemical reducing agent provides the electrons necessary to produce a metallic deposit the process was named as chemical nickel plating.
- ✚ Based on its analogy with electroplating process, William Blum coined the term as "Electroless Plating"
- ✚ Compared to electrodeposition, coatings obtained by the electroless plating process is uniform and they possess a very homogeneous distribution regardless of the substrate geometry.
- ✚ Since no current flow is involved, the rate of deposition on all areas should be equal as long as the solution conditions are maintained properly. This attribute of electroless plated coatings is beneficial when coating complex parts with critical dimensions, such as ball valves or threaded components

Various components of electroless plating bath and their functions

Component	Function
Nickel Ion	Source of Metal
Hypophosphite/Borohydride/DMAB	Reducing agent
Complexants	Stabilizes the solution
Accelerators	Activate reducing agent
Buffers	Controlling pH (longer term)
pH regulators	Regulates the pH of the solution
Stabilizer	Prevents solution breakdown
Wetting agents	Increases wettability of surfaces

Corrosion protection by electroless plated coatings

- ✦ Electroless nickel coatings
 - ✦ excellent corrosion resistance in many industrial environments
 - ✦ not susceptible to stress corrosion cracking
 - ✦ widely used either as protective or decorative coatings in many industries, such as petroleum, chemical, plastic, optics, printing, mining, aerospace, nuclear, automotive, electronics, computer, textile, paper, and food
 - ✦ corrosion protection of steel reinforcement bar
- ✦ Electroless nickel does not perform as a sacrificial coating like electrodeposited Zn or Cd on steel.
- ✦ It behaves as a true barrier coating, protecting the substrate by sealing it off from the corrosive environments. Hence, the thickness of the deposit and the absence of porosity are of great importance.

Factors that influence the corrosion resistance of electroless deposited coatings

- ✦ The most important factors that determine the corrosion resistance of electroless plated coatings are:
 - ✦ Substrate
 - ✦ Composition, structure, inclusions/imperfections, surface finish, pretreatment
 - ✦ Plating bath
 - ✦ Improper control of process parameters, contamination, ageing
 - ✦ Coating
 - ✦ Composition, porosity, thickness, internal stress, codeposition of tramp constituents
 - ✦ Post treatment
 - ✦ Passivation, annealing
 - ✦ Corrosive medium
 - ✦ Aggressiveness

Corrosion resistance of EL Ni-P coatings

- ✦ The corrosion resistance of EL Ni-P coatings is dependent on the phosphorus content of the coating
- ✦ EL Ni-high P (10-12 wt.% P) coatings are more resistant to acidic environments
- ✦ EL Ni-Low P (1-3 wt.% P) coatings are more resistant to strongly alkaline environments than EL Ni-medium P (6-8 wt.% P) and EL Ni-high P coatings
- ✦ The better corrosion resistance offered by EL Ni-high P coatings in acidic environments can be explained as follows:
 - ✦ Electroless Ni-high P coatings undergo preferential dissolution of nickel even at open circuit potential, leading to the enrichment of phosphorus at the surface layer. The enriched phosphorus surface reacts with water to form a layer of adsorbed hypophosphite anions (H_2PO_2^-). This layer in turn blocks the supply of water to the electrode surface and prevents the hydration of nickel.

Corrosion resistance of EL Ni-B coatings

- ✦ EL Ni-B coatings offer relatively lower resistance to corrosion compared to EL Ni-high P coatings.
- ✦ The difference in corrosion resistance between EL Ni-high P and EL Ni-B coatings is due to the difference in their structure.
- ✦ EL Ni-B coating is not totally amorphous. Hence, the passivation films that form on its surface are not as glassy or protective as those that form on EL Ni-high P coatings
- ✦ The phase boundaries present in EL Ni-B coatings also produce passivation film discontinuities, which are preferred sites for corrosion attack to begin.
- ✦ The inhomogeneous distribution of boron and thallium create areas of different corrosion potential on the surface, leading to the formation of minute active/passive corrosion cells and accelerate the corrosion attack.

Corrosion resistance of electro- and electroless plated composite coatings

- ✦ Corrosion resistance of ED and EL composite coatings has been a debatable issue
- ✦ The improvement or impairment of corrosion resistance of ED and EL composite coatings depends on many factors:
 - ✦ The chemical stability of the particle
 - ✦ The effective metallic area prone to corrosion
 - ✦ Structural state or microstructural feature of the coating
 - ✦ Porosity or defect size of the coating
 - ✦ Ability to prevent diffusion of chloride ions along the interface between the metal and the particle
 - ✦ Ability of the particle to prevent the corrosive pits from growing up

Electroless Ni-P/Ni-B Duplex coatings

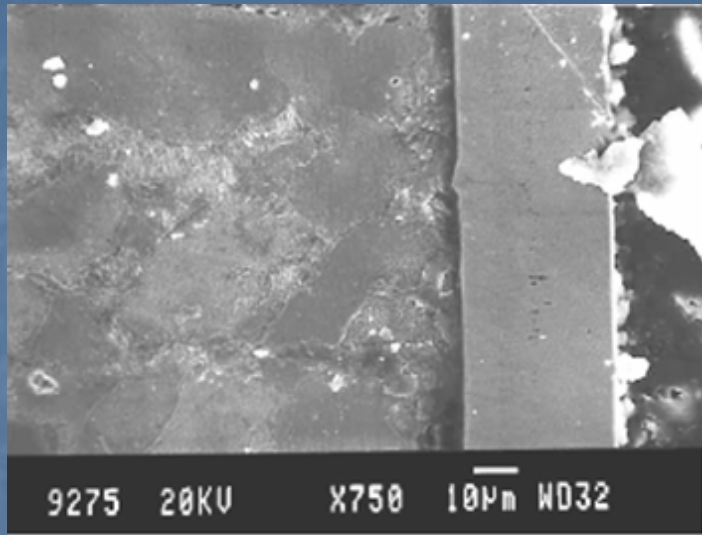

- ✚ Prepared using acidic hypophosphite- and alkaline borohydride-reduced electroless nickel baths with both EL Ni-P and Ni-B as inner layers
- ✚ The coatings are uniform and the compatibility between the layers are good
- ✚ The EL Ni-P/Ni-B duplex coatings indicate the formation of nickel, nickel phosphide and nickel borides upon heat-treatment at 450 °C for 1 hour
- ✚ The EL Ni-P/Ni-B duplex coatings will be a useful replacement for EL Ni-B and Ni-P coating, as they could provide the desirable qualities of both types of coatings

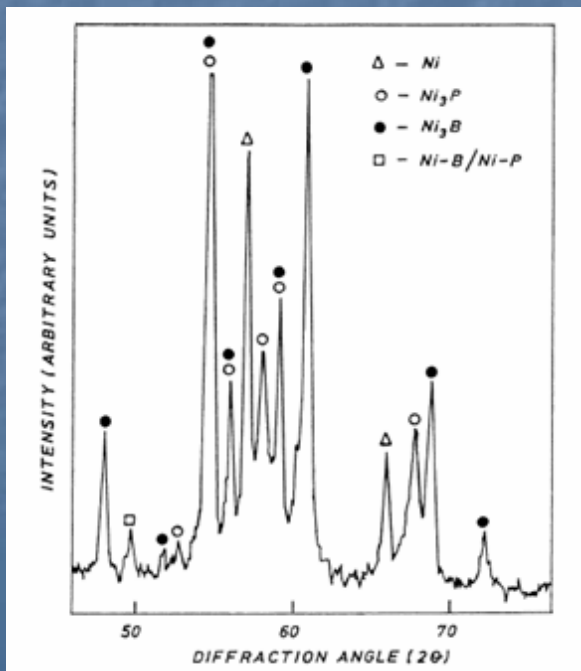

Electroless Ni-P graded coatings

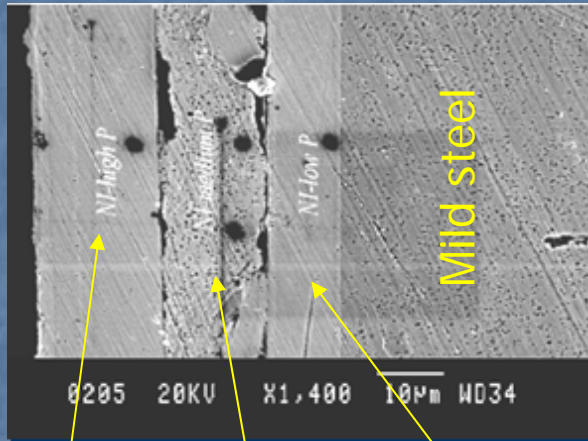

- Prepared by sequential immersion in three different hypophosphite-reduced electroless plating baths
- The graded coatings are uniform and the compatibility between the three layers is good
- The use of Ni strike between each layer is recommended
- Formation of a passive film would delay the deposition of subsequent layers. This effect is well pronounced in graded coatings with Ni-high P as the first layer (adjacent to the substrate) due to its ability to form an intact passive film
- Heat-treatment of EL Ni-P graded coatings will modify the graded layers and the gradation will be lost

Cathodic and anodic protection

Cathodic protection

- ⦿ Basic principle
 - ⦿ Through the application of a cathodic current onto a protected structure, anodic dissolution is minimized
- ⦿ The first application of CP dates back to 1824
- ⦿ Cathodic protection is often applied to coated structures, with the coating providing the primary form of corrosion protection
- ⦿ CP of buried pipelines - an important application

Electrons are supplied to the pipeline
by the dc source and the anode

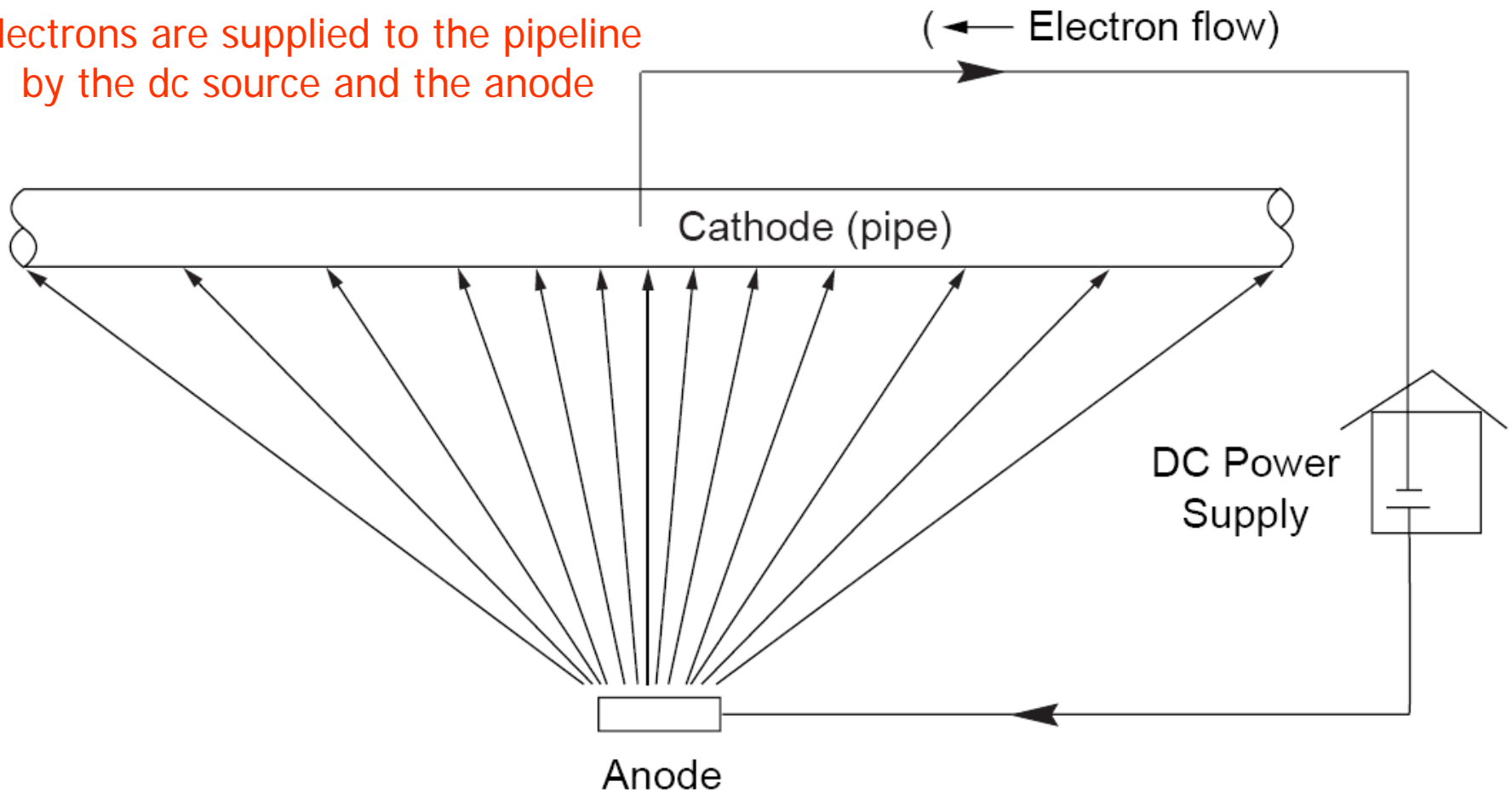

Current flow and distribution in cathodic protection of a pipeline

Relationship between Potential and Corrosion Risk for Buried Steel

Potential (V vs. Cu/CuSO ₄)	Condition of steel
-0.5 to -0.6	Intense corrosion
-0.6 to -0.7	Corrosion
-0.7 to -0.8	Some protection
-0.8 to -0.9	Cathodic protection
-0.9 to -1.0	Some overprotection
-1.0 to -1.1	Increased overprotection
-1.1 to -1.4	Increasingly severe overprotection, coating disbondment and blistering, increasing risk of hydrogen embrittlement

Selected Cathodic Protection Criteria for Different Materials

Material	CP criteria	Standard/reference
Buried steel and cast iron (not applicable to applications in concrete)	-850 mV vs. Cu/CuSO ₄	NACE Standard RP0169-83
	Minimum negative 300-mV shift under application of CP	NACE Standard RP0169-83
	Minimum positive 100-mV shift when depolarizing (after CP current switched off)	NACE Standard RP0169-83
	-850 mV vs. Cu/CuSO ₄ in aerobic environment	British Standard CP 1021:1973
	-950 mV vs. Cu/CuSO ₄ in anaerobic environment	British Standard CP 1021:1973
Steel (offshore pipelines)	-850 mV vs. Cu/CuSO ₄	NACE Standard RP0675-75
	Minimum negative 300-mV shift under application of CP	NACE Standard RP0675-75
	Minimum positive 100-mV shift when depolarizing (after CP current switched off)	NACE Standard RP0675-75
Aluminum	Minimum negative potential shift of 150 mV under application of CP	NACE Standard RP0169-83
	Positive 100-mV shift when depolarizing (after CP current switched off)	NACE Standard RP0169-83
	Positive limit of -950 mV vs. Cu/CuSO ₄	British Standard CP 1021:1973
	Negative limit of -1200 mV vs. Cu/CuSO ₄	
	Negative limit of -1200 mV vs. Cu/CuSO ₄	NACE Standard RP0169-83
Copper	Positive 100-mV shift when depolarizing (after CP current switched off)	NACE Standard RP0169-83
Lead	-650 mV vs. Cu/CuSO ₄	British Standard CP 1021:1973
Dissimilar metals	Protection potential of most reactive (anodic) material should be reached	NACE Standard RP0169-83

Cathodic protection using Sacrificial anode

- Principle of CP using sacrificial anode
 - to create a galvanic cell, with the anode representing the less noble material that is consumed in the galvanic interaction
- The structure will be protected as a result of the galvanic current flow
- Typical applications include buried tanks, underground pipelines, buried communication and power cables, water and gas distribution systems, internal protection of heat exchangers and hot water tanks, ships, and marine structures
- In practical applications a number of anodes usually have to be attached to a structure to ensure overall protection levels

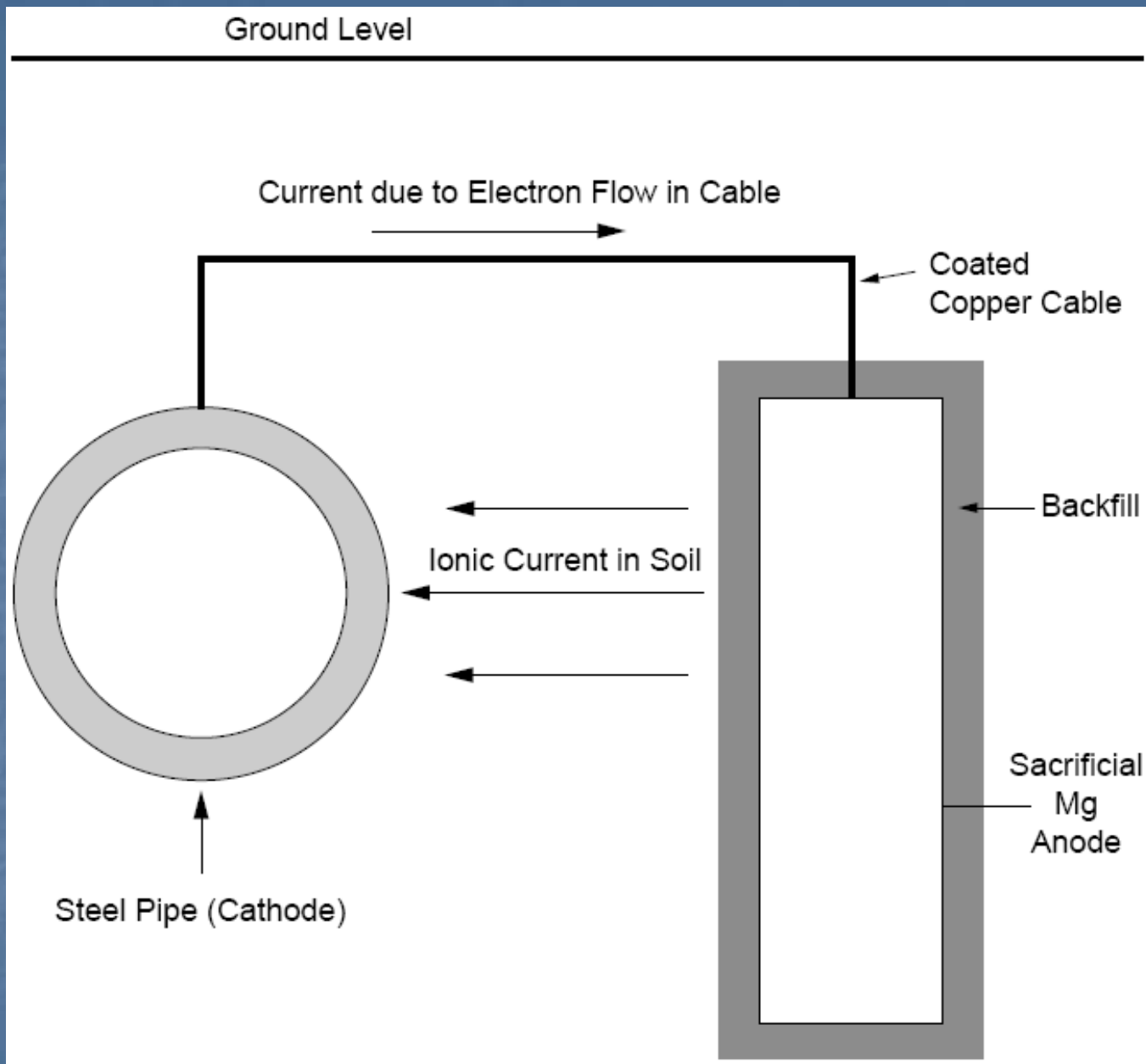

Principle of cathodic protection with sacrificial anodes

Advantages of CP using sacrificial anode

- ❖ No external power sources required.
- ❖ Ease of installation (and relatively low installation costs)
- ❖ Unlikely cathodic interference in other structures.
- ❖ Low-maintenance systems (assuming low current demand).
- ❖ System is essentially self-regulating.
- ❖ Relatively low risk of overprotection.
- ❖ Relatively uniform potential distributions

Limitations of CP using sacrificial anode

- ❖ Limited current and power output.
- ❖ High-resistivity environments or large structures may require excessive number of electrodes
- ❖ Anodes may have to be replaced frequently under high current demand.
- ❖ Anodes can increase structural weight if directly attached to a structure

Requirements of sacrificial anodes used for CP

- ❖ The anode material must be capable of providing sufficient current to adequately protect a structure
- ❖ Should be self-regulating in terms of potential
- ❖ The driving voltage - difference between the operating voltage of the anode and the potential of the polarized structure it is protecting should be high
- ❖ Over its lifetime, an anode must consistently have a high capacity to deliver electric current per unit mass of material consumed

Requirements of sacrificial anodes used for CP

- ❖ The capacity is defined as the total charge (in coulombs) delivered by the dissolution of a unit mass of the anode material.
- ❖ The theoretical capacity can be determined from Faraday's law, and the anode efficiency obtained in practice can be defined as

$$\text{Efficiency} = \frac{\text{actual capacity}}{\text{theoretical capacity}} \times 100\%$$

- ❖ Passivation of an anode is obviously undesirable
- ❖ Ease of manufacturing in bulk quantities and adequate mechanical properties are also important

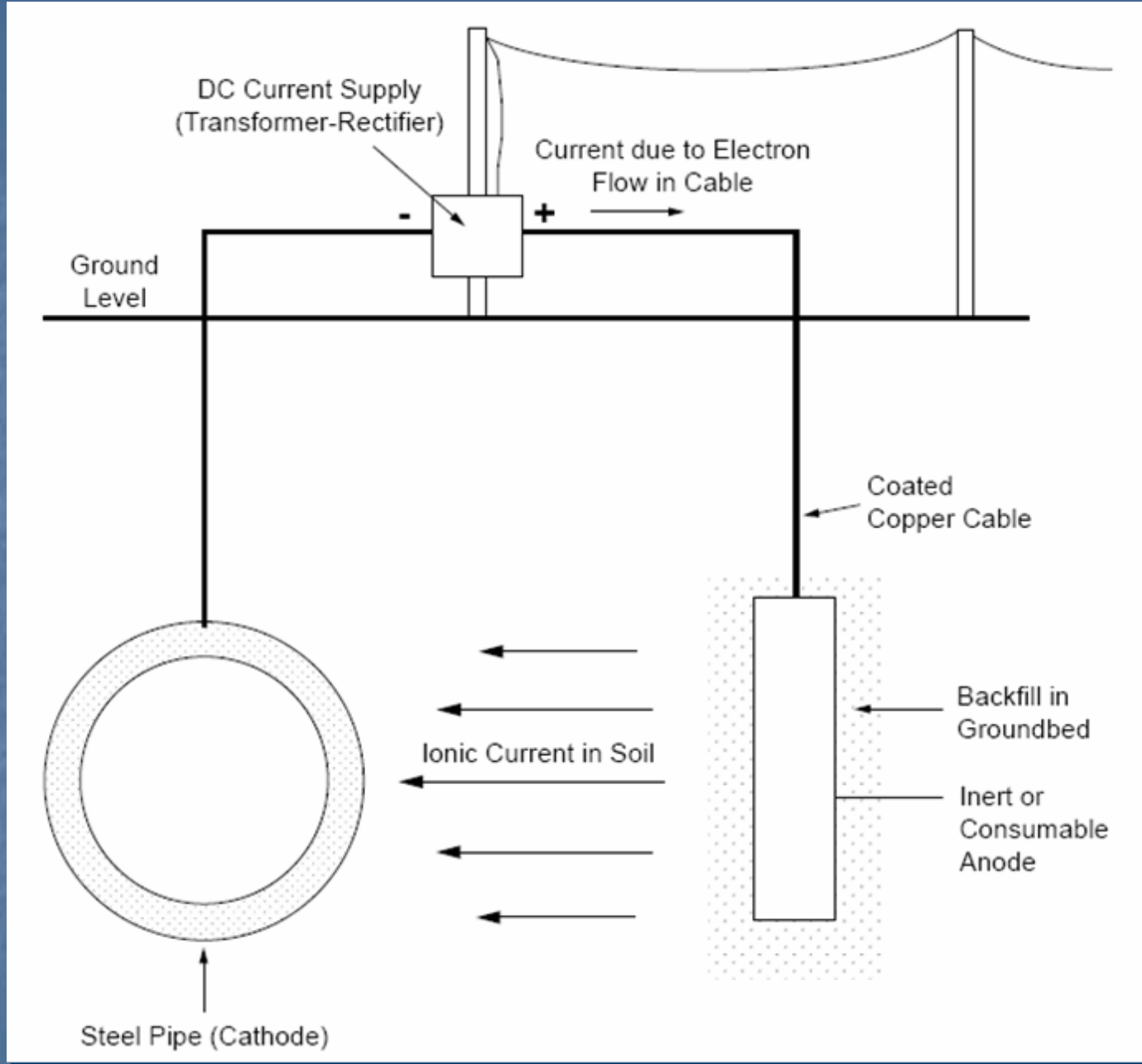

Principle of cathodic protection with impressed current

Examples of Impressed Current Anodes Used in Different Environments

Marine environments	Concrete	Potable water	Buried in soil	High-purity liquids
Platinized surfaces Iron, and steel Mixed-metal oxides graphite Zinc High-Si Cr cast iron	Platinized surfaces Mixed-metal oxides Polymeric	High-Si iron Iron and steel Graphite Aluminum	Graphite High-Si Cr cast iron High-Si iron Mixed-metal oxides Platinized surfaces Polymeric, iron and steel	Platinized surfaces

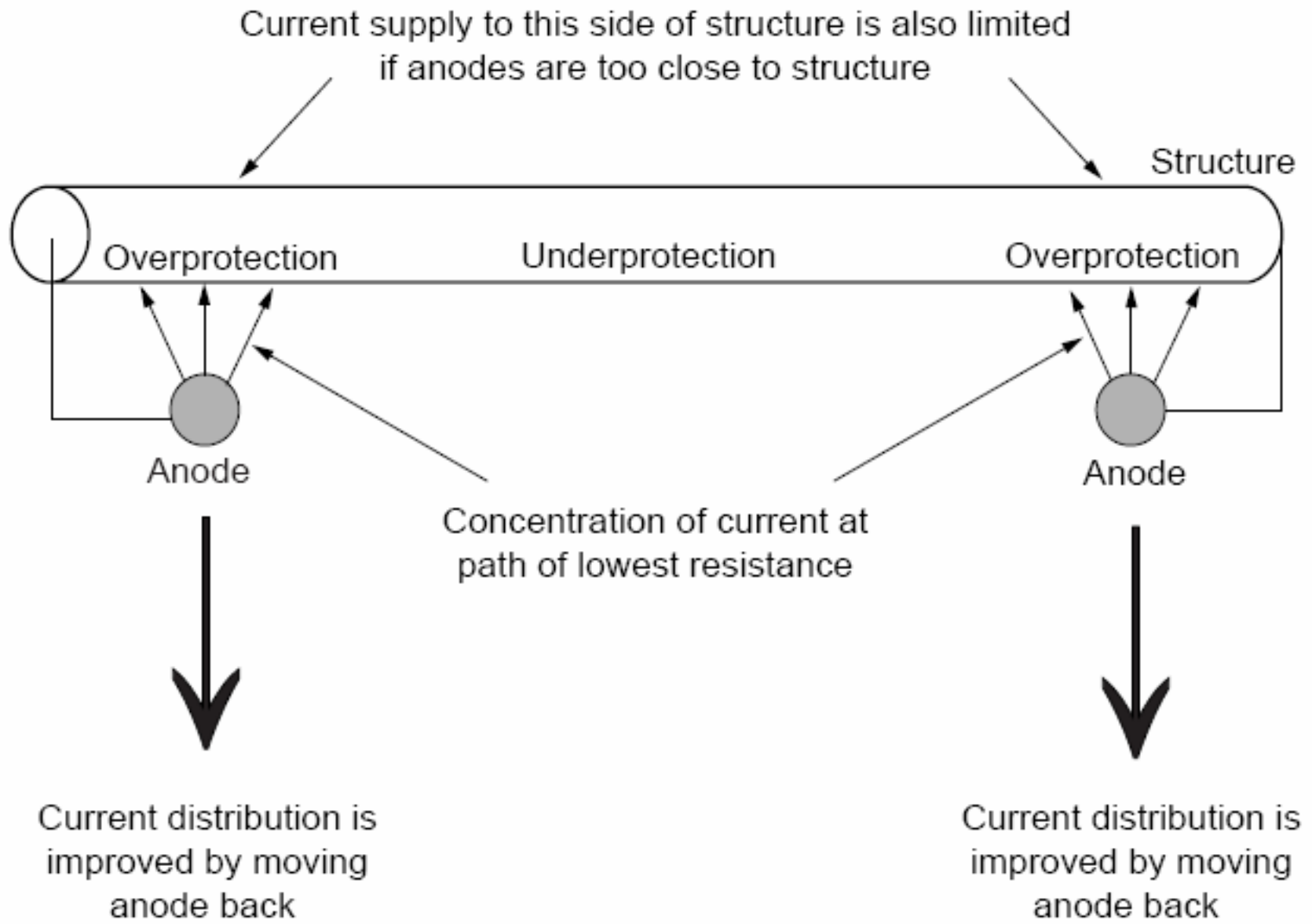

Non-uniform distribution of protective current resulting from anode positioning too close to the corroding structure

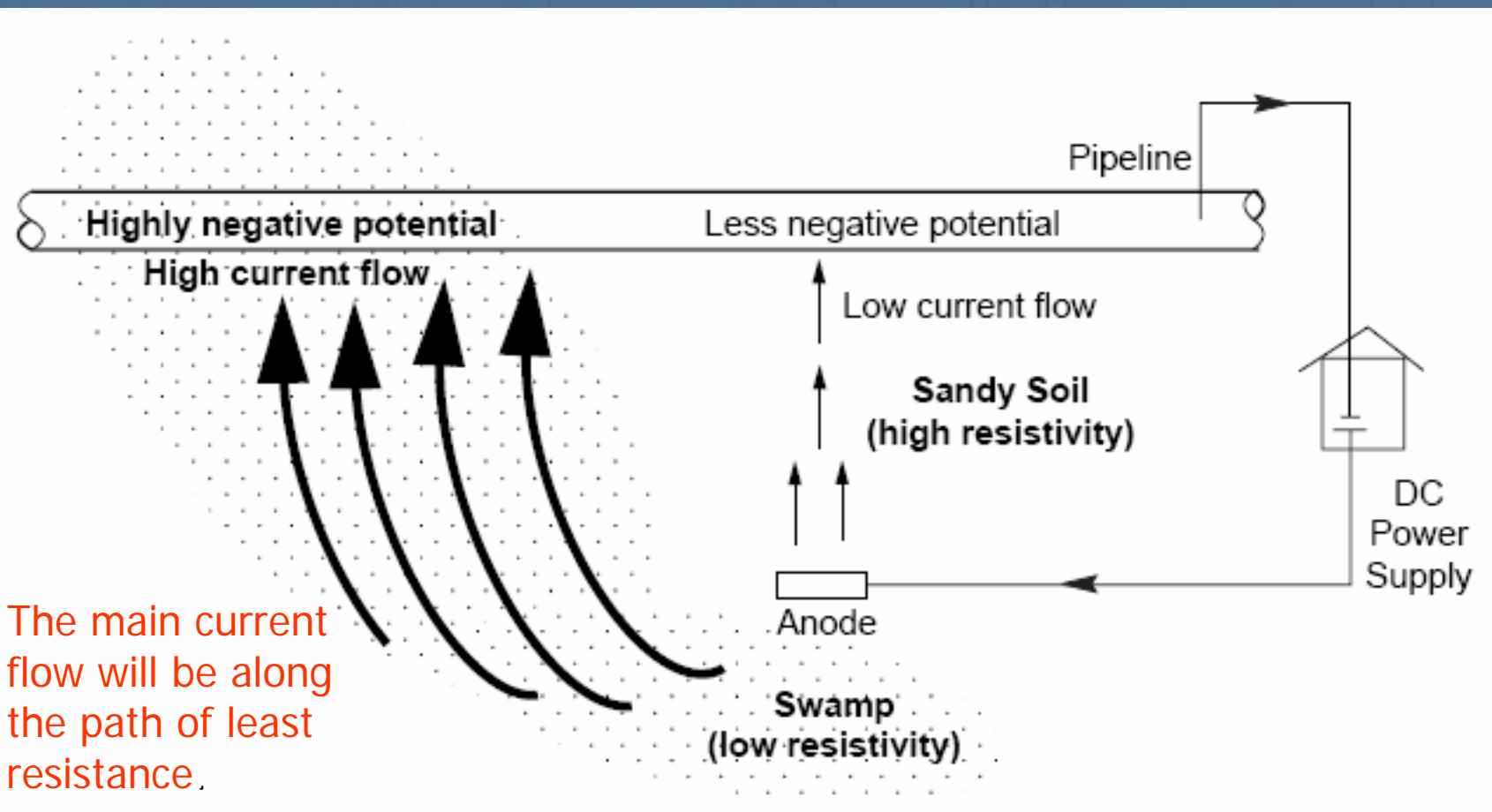

Non-uniform current distribution over a pipeline resulting from differences in the electrolyte (soil) resistivity

Resistivities of Different Electrolytes

Soil type	Typical resistivity, $\Omega\cdot\text{cm}$
Clay (salt water)	< 1000
Clay (fresh water)	< 2000
Marsh	1000–3000
Humus	1000–4000
Loam	3000–10,000
Sand	$> 10,000$
Limestone	$> 20,000$
Gravel	$> 40,000$

Anodic protection

- ❖ Anodic protection is relatively new
- ❖ Edleanu first demonstrated the feasibility of anodic protection in 1954 and tested it on small-scale stainless steel boilers used for sulfuric acid solutions
- ❖ Anodic protection is based on the formation of a protective film on metals by externally applied anodic currents
- ❖ The applied current is usually equal to the corrosion rate of the protected system
- ❖ Anodic protection not only protects but also offers a direct means for monitoring the corrosion rate of a system
- ❖ Anodic protection can decrease corrosion rate substantially

Anodic Protection of S30400 Stainless Steel Exposed to an Aerated Sulfuric Acid Environment at 30°C with and without Protection at 0.500 V vs. SCE

Acid concentration, M	NaCl, M	Corrosion rate, $\mu\text{m}\cdot\text{y}^{-1}$	
		Unprotected	Protected
0.5	10^{-5}	360	0.64
0.5	10^{-3}	74	1.1
0.5	10^{-1}	81	5.1
5	10^{-5}	49,000	0.41
5	10^{-3}	29,000	1.0
5	10^{-1}	2,000	5.3

Current Requirements for Anodic Protection

H ₂ SO ₄	Temperature, °C	Alloy	Current density	
			To passivate, mA·cm ⁻²	To maintain, μA·cm ⁻²
1 M	24	S31600	2.3	12
15%	24	S30400	0.42	72
30%	24	S30400	0.54	24
45%	65	S30400	180	890
67%	24	S30400	5.1	3.9
67%	24	S31600	0.51	0.10
67%	24	N08020	0.43	0.9
93%	24	Mild steel	0.28	23
99.9% (oleum)	24	Mild steel	4.7	12
H ₃ PO ₄				
75%	24	Mild steel	41	20,000
115%	82	S30400	3.2×10^{-5}	1.5×10^{-4}
NaOH				
20%	24	S30400	4.7	10

Advantage of anodic protection

- ✓ The primary advantages of anodic protection is its applicability in extremely corrosive environments and its low current requirements

Limitations of anodic protection

- Anodic protection is used to a lesser degree than the other corrosion control techniques, particularly cathodic protection
- This is mainly because of the limitations on metal-chemical systems for which anodic protection will reduce corrosion
- It is possible to accelerate corrosion of the equipment if proper controls are not implemented.

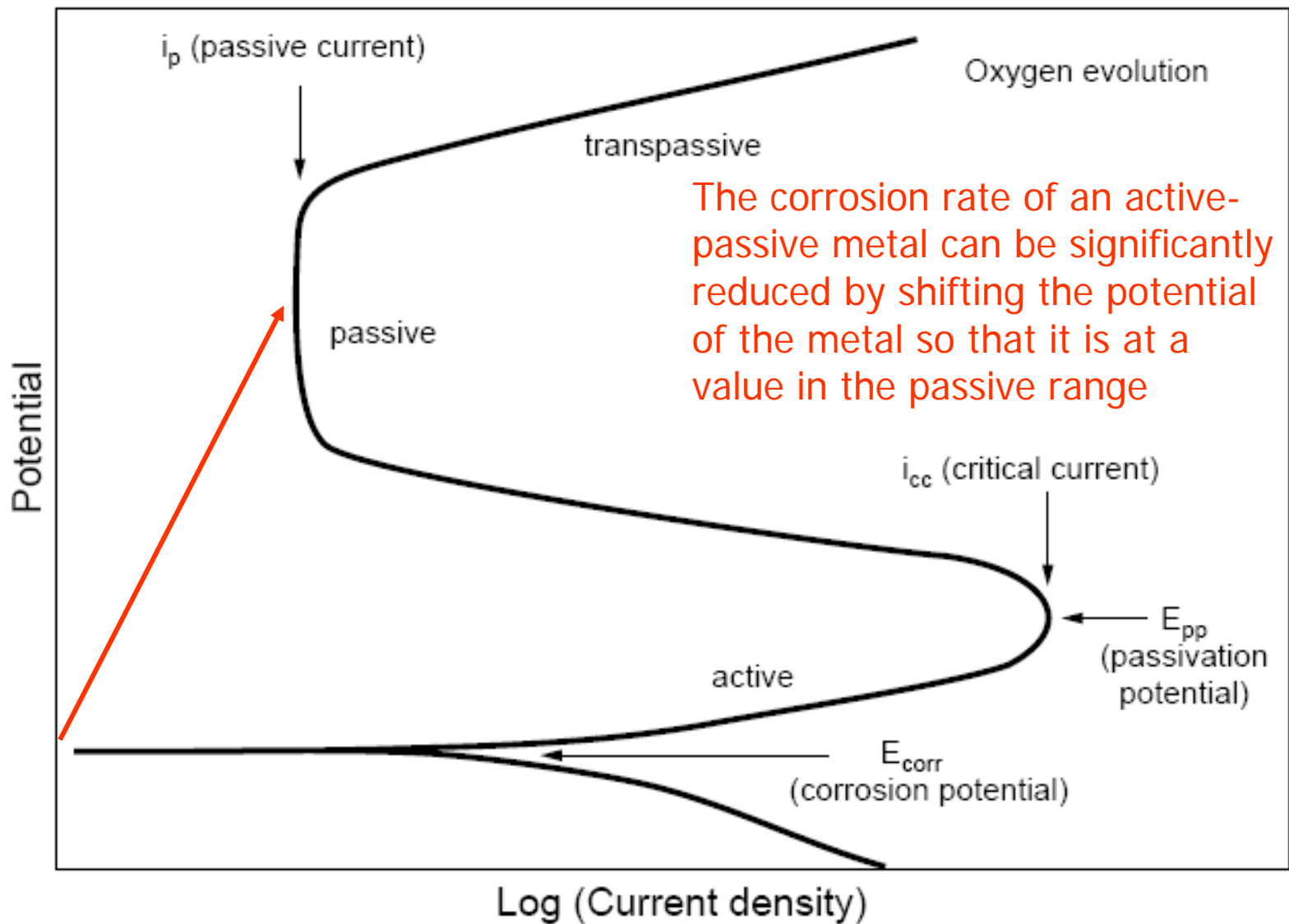

Hypothetical polarization diagram for a passivable system with active, passive and transpassive regions.

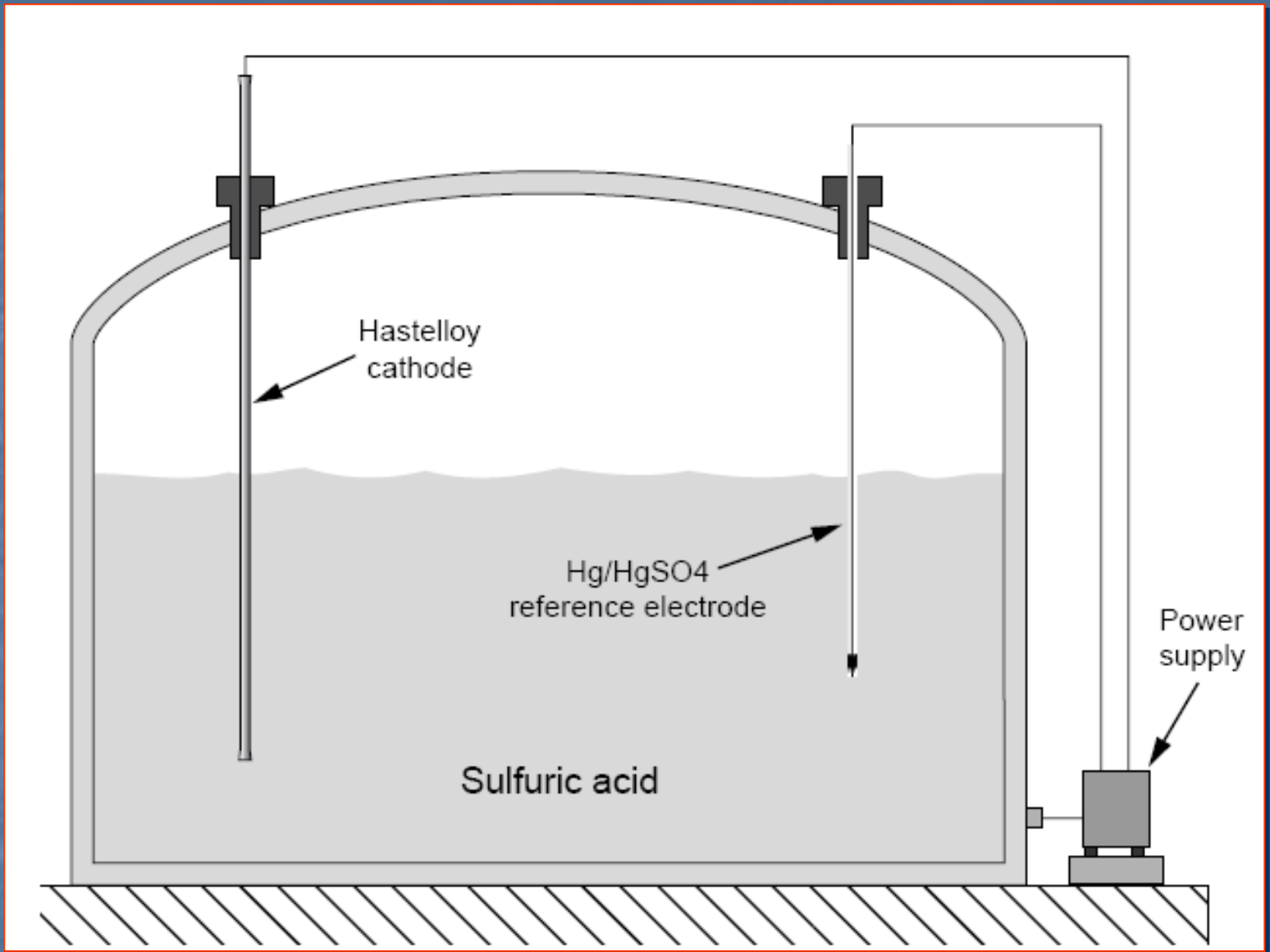

Schematic of an anodic protection system for a sulfuric acid storage vessel

Cathodes used for Anodic protection

- ✧ The cathode should be a permanent-type electrode that is not dissolved by the solution or the currents impressed between the vessel wall and electrode.
- ✧ The overall resistance is a direct function of current density, it is advantageous to use large surface area electrodes
- ✧ The electrode size is chosen to conform to the geometry of the vessel and to provide a large surface area
- ✧ The location of the cathode is not a critical factor in simple geometry, such as storage vessels, but in heat exchangers, it is necessary to extend the electrode around the surface to be protected.
- ✧ Multiple cathodes can be used in parallel to distribute the current and to decrease circuit resistance

Cathode Materials Used in Field Installations

Cathode metal	Environment
Platinum-clad brass	Sulfuric acid of various concentrations
Steel	Kraft pulping liquor
Chromium nickel steel	H ₂ SO ₄ (78–105%)
Silicon cast iron	H ₂ SO ₄ (89–105%)
Copper	Hydroxylamine sulfate
S30400	Liquid fertilizers (nitrate solutions) Sulfuric acid
Nickel-plated steel	Chemical nickel plating solutions
Hastelloy C	Liquid fertilizers (nitrate solutions) Sulfuric acid of various concentrations Kraft digester liquid

Reference electrode for AP

- Reference electrodes must be used in anodic protection systems because the potential of the vessel to be protected has to be carefully controlled
- The reference electrode must have an electrochemical potential that is constant with respect to time and that is minimally affected by changes in temperature and solution composition
- The reference electrode has been a source of many problems in anodic protection installations because of its fragile nature

Reference Electrodes Used for Anodic Protection Installations

Electrode	Environment
Calomel	Sulfuric acid of various concentrations Kraft digester
Ag/AgCl	Sulfuric acid, fresh or spent Kraft solutions Fertilizer solutions Sulfonation plant
Hg/HgSO ₄	H ₂ SO ₄ Hydroxylamine sulfate
Pt/PtO	H ₂ SO ₄
Au/AuO	Alcohol solution
Mo/MoO ₃	Sodium carbonate solutions Kraft digester Green or black liquors
Platinum	H ₂ SO ₄
Bismuth	NH ₄ OH
S31600 steel	Fertilizer solutions H ₂ SO ₄
Nickel	Fertilizer solutions Nickel plating solutions
Silicon	Fertilizer solutions

Applications of AP

- Anodic protection has been used for storage vessels, process reactors, heat exchangers, and transportation vessels that contain various corrosive solutions
- The majority of the applications of anodic protection involve the manufacture, storage, and transport of sulfuric acid, more of which is produced worldwide than any other chemicals
- A large market has developed for anodically protected heat exchangers as replacements for cast iron coolers. Shell and tube, spiral, and plate-type exchangers have been sold complete with anodic protection as an integral part of the equipment

Microbiologically influenced corrosion

Microbiologically influenced corrosion

- ❖ Microbiologically influenced corrosion (MIC) - corrosion associated with the action of microorganisms present in the system.
- ❖ MIC is an interdisciplinary subject that embraces the fields of materials science, chemistry, microbiology, and biochemistry
- ❖ MIC affects many industries, such as petrochemical, ships and marine structures, power generating, aircraft fuel systems, waste water facilities, cooling water systems, process industries, paper mills, and water supply and distribution systems.

Formation of biofilm and its consequences

- ❖ Microorganisms - bacteria, algae and fungi are present virtually at all natural environments
- ❖ The tendency of microorganisms present in water to attach to and grow on surface of a variety of materials results in the formation of a biofilm
- ❖ Microorganisms tend to settle nonuniformly on metal surfaces - they form discrete colonies

Formation of biofilm and its consequences

- ❖ The microorganisms have the ability to change the environmental variables such as pH, oxidizing power, velocity of flow, and concentration of chemical species
- ❖ The most effective strategies for controlling biofilm formation is prevention of bacterial adhesion at an initial stage in biofilm formation
- ❖ Biofilm formation causes choking of the pipe, deterioration of heat-transfer efficiency, microbiologically influenced corrosion (MIC), pitting corrosion and stress corrosion cracking

Characteristics of the microorganisms

- ❖ Length: 0.1 to $> 5 \mu\text{m}$; Width: $3 \mu\text{m}$
- ❖ Many of them are motile - they can “swim” to a favorable, or away from an unfavorable, environment.
- ❖ Because of their small size, they can reproduce themselves in a short time - a single bacterium can produce over one million microorganisms in < 7 hours
- ❖ In addition to rapid reproduction, the bacteria as a group can survive wide ranges of
 - ❖ Temperature: -10 to $>100^\circ\text{C}$
 - ❖ pH: up to 10.5
 - ❖ dissolved oxygen concentration: 0 to saturation
 - ❖ Pressure: vacuum to $>31 \text{ MPa}$, or 4500 psi; and
 - ❖ Salinity: from ppb to $\sim 30\%$.

Characteristics of the microorganisms

- ❖ A large percentage of microorganisms can form extracellular polymeric materials termed simply polymer, or slime
- ❖ The slime is involved in attaching the organisms to the surface, trapping and concentrating nutrients for the microbes to use as food, and often, in shielding the organisms from the toxic effect of biocides

Characteristics of the microorganisms

- ❖ The slime film can influence corrosion by trapping or complexing heavy-metal ions near the surface.
- ❖ Some species of microbes can produce organic acids, such as formic and succinic, or mineral acids, such as H_2SO_4
- ❖ They can oxidize sulfur or sulfides to sulfates or H_2SO_4 or they can reduce sulfates to sulfides, often producing corrosive H_2S as an end product.

Corrosion of metals

- ❖ Corrosion of metals in presence of water – electrochemical nature
- ❖ The anodic and cathodic reactions involved are shown below:

Anodic reaction



Cathodic reactions

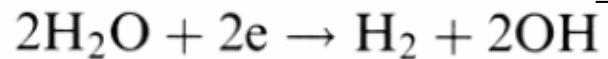
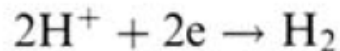
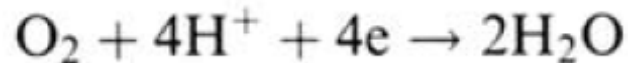
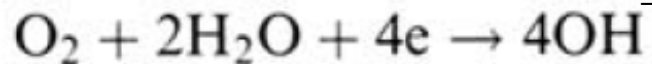

Acidic solutions

Neutral or alkaline solutions

Mechanism of MIC

- ❖ MIC of metallic materials does not involve any new form of corrosion
- ❖ The main ways in which microorganisms may enhance the rate of corrosion of metals and/or the susceptibility to localized corrosion in an aqueous environment are as follows:
 - ❖ *Formation of concentration cells at the metal surface and in particular oxygen concentration cells*
 - ❖ *Modification of corrosion inhibitors*
 - ❖ *Production of corrosive metabolites*
 - ❖ *Destruction of protective layers*
 - ❖ *Stimulation of electrochemical reactions*
 - ❖ *Hydrogen embrittlement*

Mechanism of MIC

Formation of concentration cells

- ❖ Formation of concentration cells, particularly oxygen concentration cells may occur when a biofilm or bacterial growth develops heterogeneously on the metal surface
- ❖ Certain bacteria may also trap heavy metals such as copper and cadmium within their extracellular polymeric substance, resulting in the formation of ionic concentration cells

Mechanism of MIC

Modification of corrosion inhibitors

- ❖ Certain microorganisms may destroy corrosion inhibitors
- ❖ They can transform nitrite to nitrate, or nitrate to nitrite and ammonia and N_2

Mechanism of MIC

Production of corrosive metabolites

- ❖ *T. thiooxidans* – Inorganic acids
- ❖ Almost all bacteria, algae, and fungi – organic acids
- ❖ Sulfate-reducing bacteria - sulfide
- ❖ All are corrosive to metallic materials

Destruction of protective layers

- ❖ Various microorganisms may attack organic coatings, and this may lead to corrosion of the underlying metal

Mechanism of MIC

Stimulation of electrochemical reactions

- ❖ An example of this type of action is the evolution of cathodic hydrogen from microbially produced hydrogen sulfide

Hydrogen embrittlement

- ❖ Microorganisms may influence hydrogen embrittlement on metals by acting as a source of hydrogen or/and through the production of H₂S

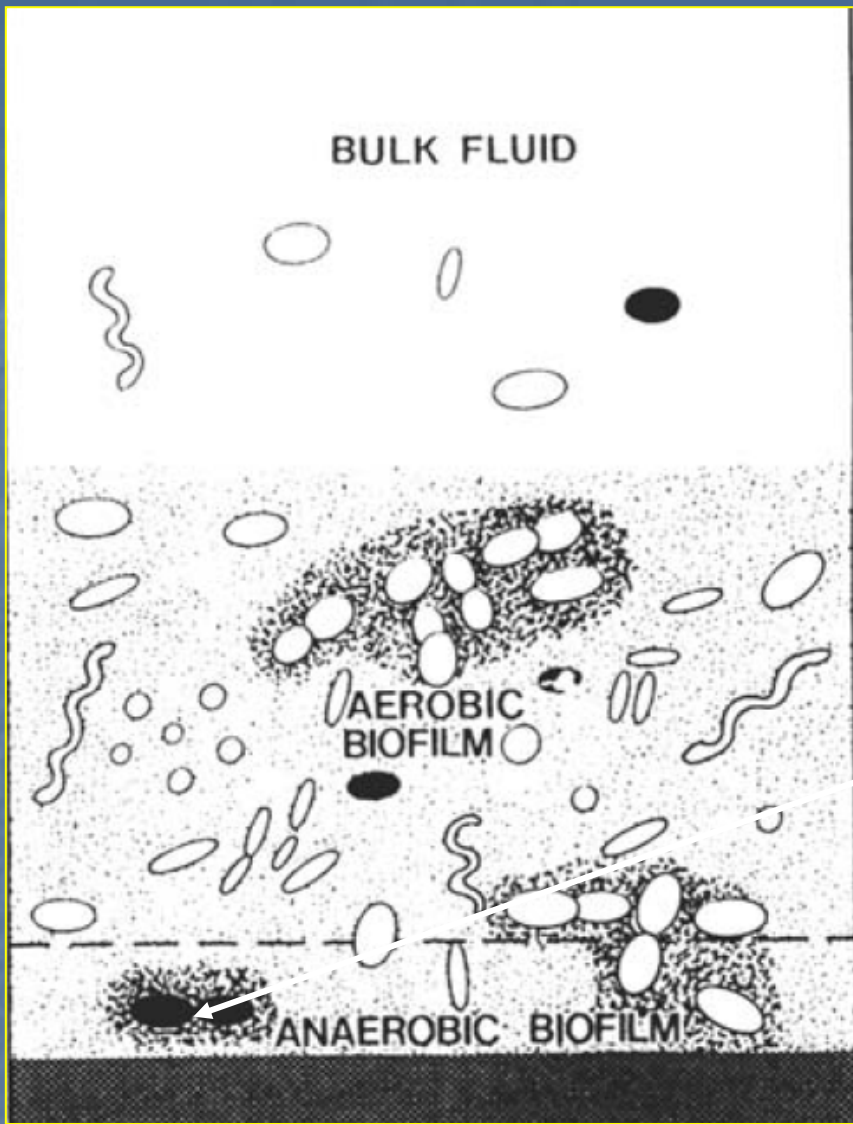

When the film becomes sufficiently thick its inner part will be anaerobic with the possible development of SRB microcolonies (black cells)

Diagrammatic representation of the formation of microbial consortia and their influence on the corrosion processes

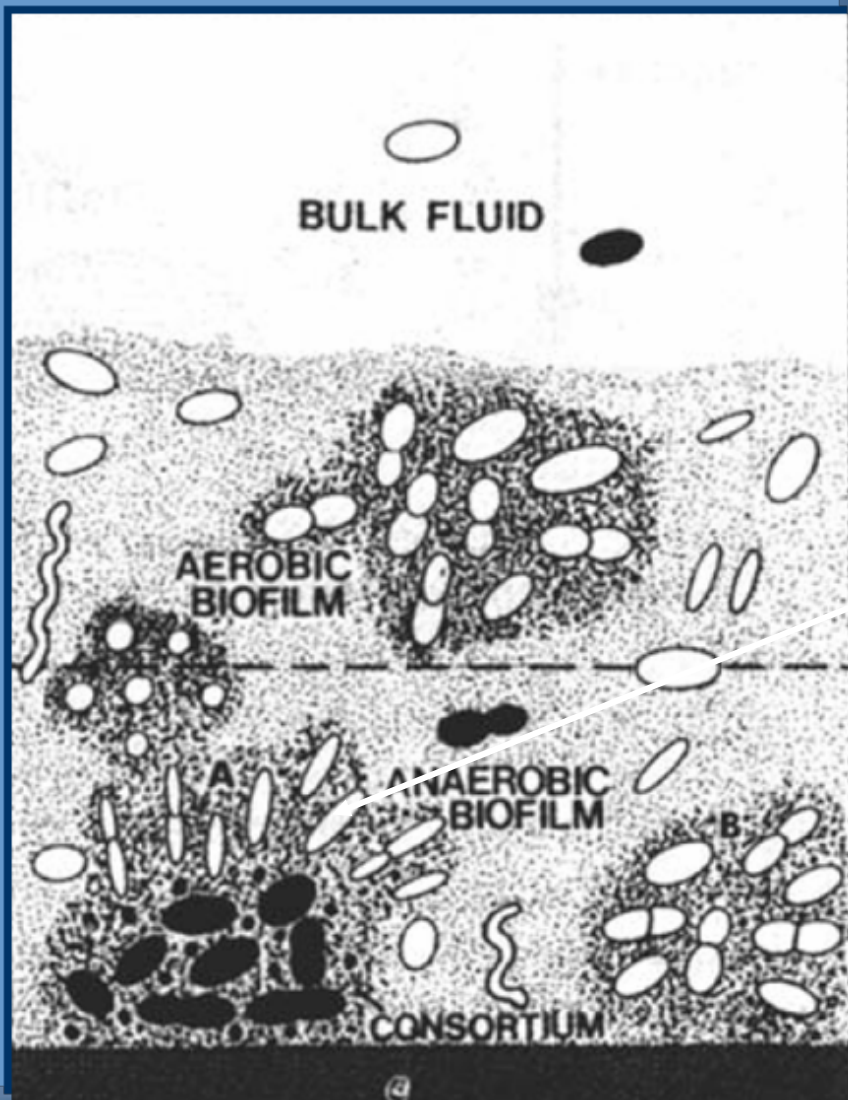

The SRB attracts secondary colonizers by its metabolic products and forms a consortium with them

Diagrammatic representation of the formation of microbial consortia and their influence on the corrosion processes

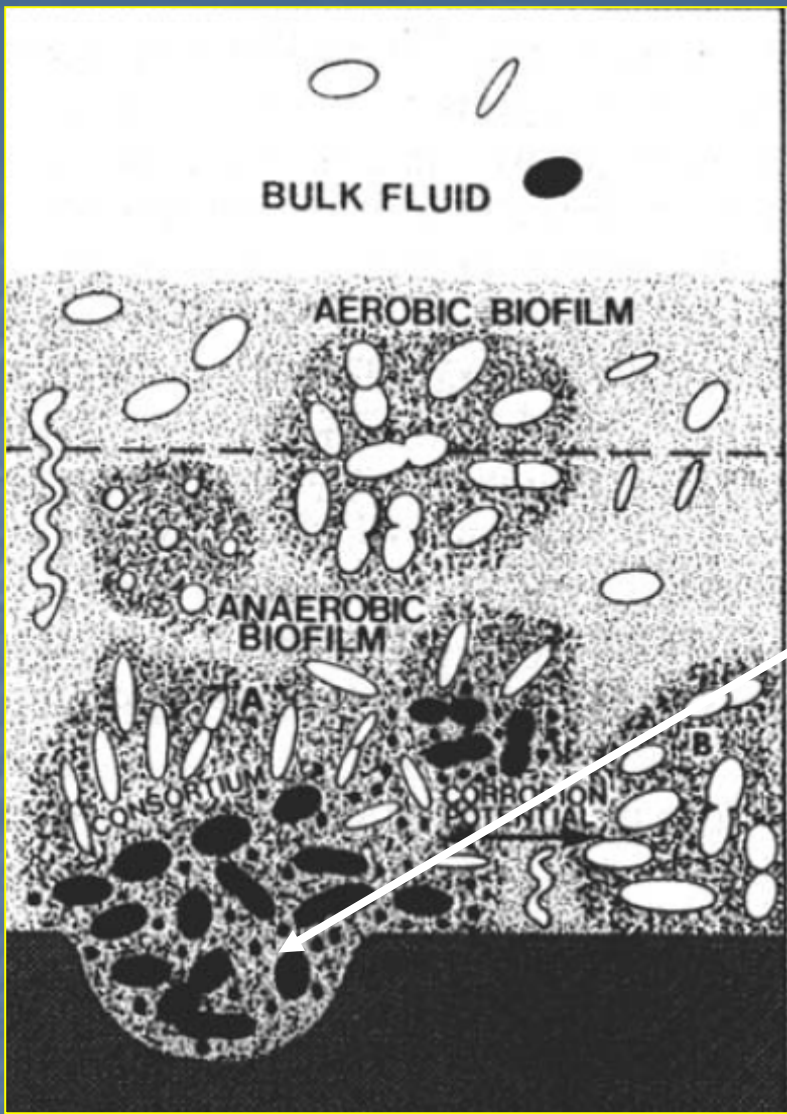

The development of local areas with varying physicochemical parameters leads to pitting corrosion.

Diagrammatic representation of the formation of microbial consortia and their influence on the corrosion processes

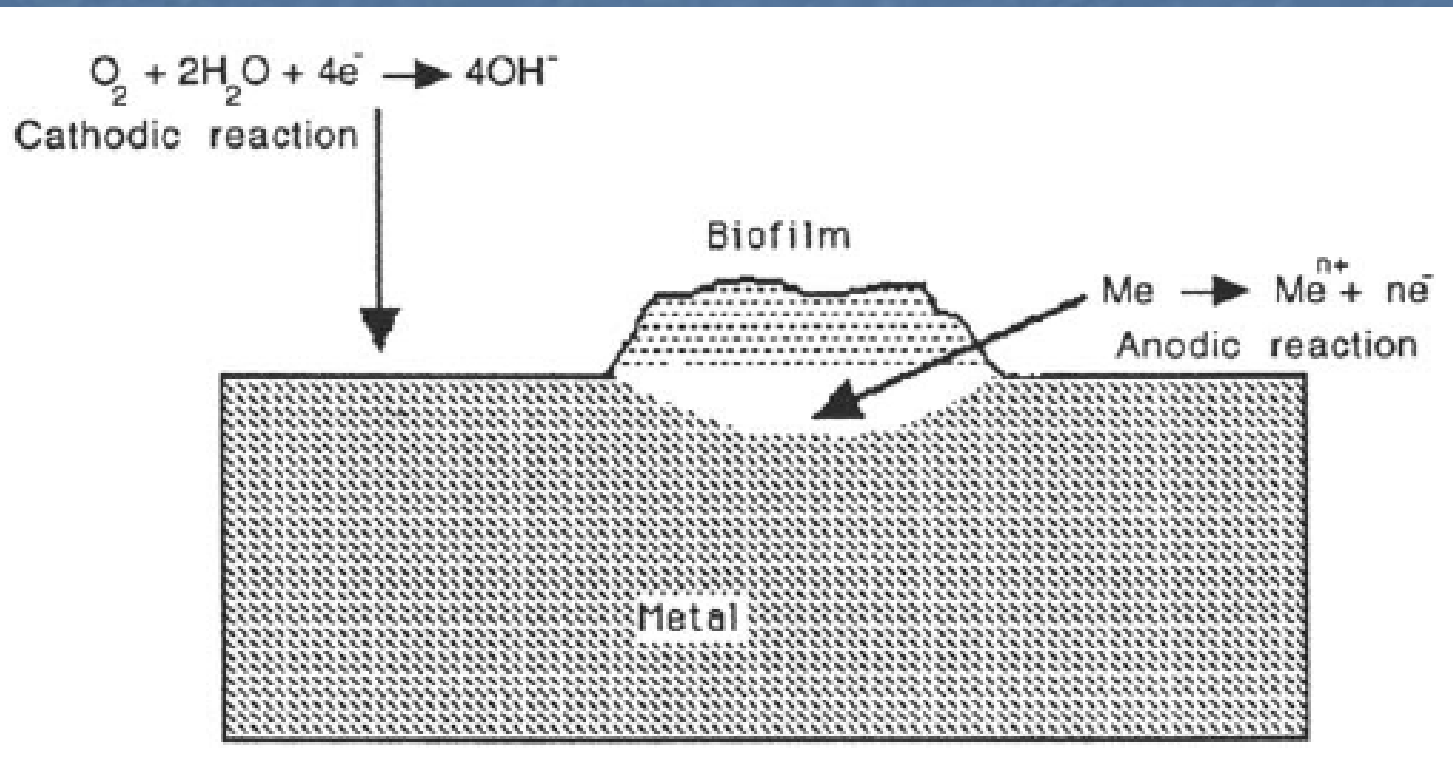

Schematic representation of the influence of biofilm
in the formation of differential aeration cells

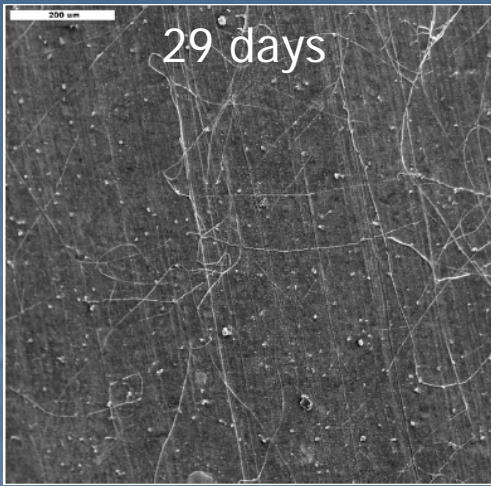

Covered by a filamentous bacterial net



Rod shaped bacterial attachment

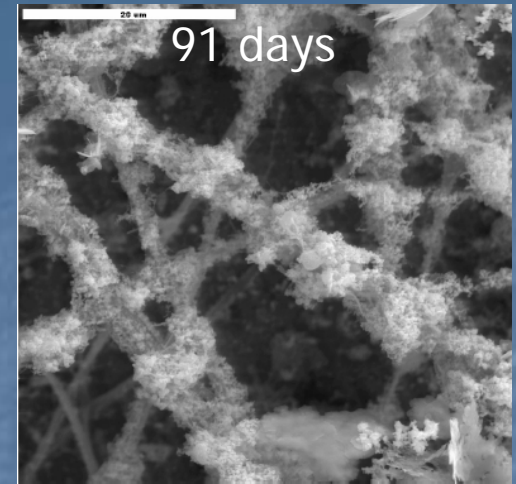

Filamentous forms covered by sulfur corrosion products - SRB

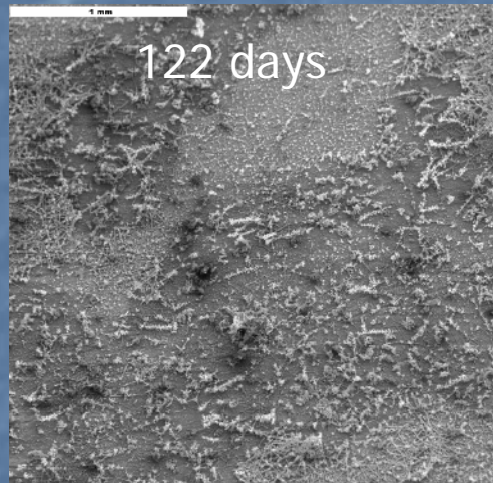

Detachment of bacterial net



Central diatoms (Stephanodiscus)

SEM micrographs of admiralty brass/fresh water system as a function of time

How it occurs?

- ❖ During initial microbial proliferation the dissolved O_2 is used up by aerobic bacteria and other microbes - the zone near the microbial growth becomes oxygen deficient and anodic
- ❖ The formation of mildly acidic organic chemicals following the oxidation accelerate corrosion
- ❖ SRB utilise the oxygen in sulphates for 'breathing' and reduce the sulphates to sulphides - H_2S is the end product of the SRB activity

How it occurs?

- ❖ Reaction of H_2S with metal ions lead to the formation of the corresponding metal sulphides, which accelerate the corrosion
- ❖ H_2S is also highly toxic and flammable and is believed to accelerate hydrogen embrittlement
- ❖ Strong acids such as sulphuric acid can be produced from sulphides by 'sulphur oxidising bacteria' when O_2 becomes available again - the strong acids will further accelerate the ongoing corrosion process

MIC of copper alloys

- ❖ The toxicity of cuprous ions toward living organisms is well known - but it does not mean that the copper-base alloys are immune to biological effects in corrosion.
- ❖ Certain microorganisms have a high tolerance for copper and they are likely to cause a substantial effect
- ❖ Thiobacillus - tolerate Cu concentrations as high as 6%
- ❖ SRB - Localized corrosion of copper alloys in estuarine environments

MIC of copper alloys

- ❖ MIC is observed at electric generating facilities using fresh or brackish cooling water
 - ❖ Cu-10Ni
 - ❖ Admiralty brass (Cu-30Zn-15Sn)
 - ❖ aluminum brass (Cu-20Zn-2Al)
- ❖ MIC - caused by the production of corrosive substances such as CO_2 , H_2S , NH_3 , and organic or inorganic acids

MIC of copper alloys

- ❖ Several million SRB were found within each pit under the deposit. It was thought that the deposit-forming organisms created an environment conducive to growth of SRB, which then accelerated corrosion by the production of H_2S
- ❖ It is quite common to have bacterial slime films on the interior of copper alloy heat-exchanger and condenser tubing

MIC of copper alloys

- ❖ Usually, these films are a problem only with heat transfer as long as the organisms are living. When they die, however, organic decomposition produces sulfides, which are notoriously corrosive to copper alloys.
- ❖ Occasionally, NH_3 -induced stress-corrosion cracking has been directly attributed to microbial NH_3 production.

Typical signs of MIC

- ❖ Clusters of pits several cm in diameter found under a cover of organic deposits, for example dirt and rust scale mixed with oil spills
- ❖ Black colouration - iron sulphides appearing during removal of cover (quickly disappearing when uncovered due to oxidation)
- ❖ Sulphidic smell, quickly disappearing after ventilation (watch out for pockets of poisonous H_2S gas)

Role of Sulfate Reducing Bacteria (SRB)

- ❖ In anaerobic conditions, SRB can reduce the sulfate ion to produce hydrogen gas and the sulfide ion
- ❖ The sulfide ion then combines with the metal ions to form the corresponding metal sulfide, leading to the dissolution of the metal
- ❖ SRB can thrive best in environments at low pH and can produce localised sulphuric acid concentrations up to 5 wt%. Thus they are capable of creating extremely corrosive conditions.

Counter measures for MIC

- ❖ Choice - depends on many factors:
 - ❖ nature of the environment in which MIC occurred (e.g., soil, cooling water, seawater)
 - ❖ type of microorganisms involved; and
 - ❖ nature of the material
- ✓ Changing or Modifying the Material
- ✓ Modifying the Environment or Process Parameters
- ✓ Organic Coatings
- ✓ Cathodic Protection
- ✓ Biocides
- ✓ Microbiological Methods
- ✓ Physical Methods

Counter measures for MIC

Changing or Modifying the Material

- ❖ The choice of a material that is not susceptible or less susceptible to bacterial degradation may be one solution
- ❖ However, this is often not possible for economic reasons

Counter measures for MIC

Modifying the Environment or Process Parameters

- ❖ The environment can be modified through, for instance, avoidance of anaerobic zones or modification of the pH in order to prevent acid accumulation
- ❖ stagnant conditions should be avoided in water systems
- ❖ an increase in water velocity in heat exchanger tubes leads to partial detachment of biofilm – not always possible – might induce erosion corrosion

Counter measures for MIC

Organic Coatings

- ❖ widely used for the protection of buried pipes, exteriors of buildings, and marine structures
- ❖ All paint coatings are more or less biodegradable
- ❖ Microorganisms may grow in the pores and voids in the organic coatings - result in a highly localized corrosion

Counter measures for MIC

Cathodic Protection

- ❖ widely used in buried steel pipes and marine structures
- ❖ The potential of the structure is depressed to at least -1 V vs. Cu/CuSO₄ instead of -0.85 V vs. Cu/CuSO₄, which is usually recommended in the absence of SRB
- ❖ Cathodic protection is often used in combination with organic coatings - efficient at defects of the coating

Counter measures for MIC

Biocides

- ❖ Commonly used in industrial water systems – Two types
 - ❖ Oxidizing agents such as chlorine, ozone, and chlorine dioxide
 - ❖ Nonoxidizing agents such as bithiocyanate, isothiazolines, acrolein, dodecylguanidine hydrochloride, formaldehyde, glutaraldehyde, chlorophenols, and quaternary ammonium salts.

Counter measures for MIC

Biocides

- ❖ Bacteria may adapt to biocides in different ways
 - ❖ production of enzymes
 - ❖ changes in the internal structure of the cell
 - ❖ changes in the composition of the cell wall
- ❖ Few biocides are efficient when the biofilm is already present - increase in dosage up to 100 times is needed
- ❖ Toxicity of biocides to higher organisms – limitation

Counter measures for MIC

Microbiological Methods

- ❖ Variation in pH, oxygen concentration, temperature, or light conditions may be used to control microbial growth
- ❖ A change in these parameters may increase the electrochemical corrosion of metals and alloys

Counter measures for MIC

Physical Methods

- ❖ Filtration of the water, mechanical removal of the biofilm, or the use of ultraviolet (UV) radiation can be used for some specific applications - less efficient and more costly than the use of chemicals

Corrosion in automobiles

Modes of corrosion

- Corrosion in motor vehicles is present in several different forms
- The most obvious form of corrosion for vehicles is **general corrosion** of the painted steel body panels
- General corrosion also affects the underside and frame of a vehicle, leading to possible floorboard perforation and weakening of the frame



General corrosion of painted steel automobile body panel

Modes of corrosion

- ❏ **Pitting corrosion** - occurs when chlorides and other chemical species are in contact with metal
- ❏ Pitting corrosion produces small cavities that can cause leaks in the radiator and in the muffler and tail pipe
- ❏ **Galvanic corrosion** - occurs between dissimilar metals
- ❏ Galvanic corrosion was a cosmetic concern when more metal was used for trim and decoration on vehicles than is used today
- ❏ Galvanic corrosion can be reduced through careful design and must be considered because of the number of different materials used in a motor vehicle
- ❏ **Crevice corrosion** - occurs when a fluid enters a tight space between two surfaces, such as between a washer and a steel beam
- ❏ This fluid can concentrate in a narrow crevice, resulting in highly accelerated corrosion in the crevice area

AREAS OF MAJOR CORROSION IMPACT

- ❖ The primary cost of corrosion in the automotive sector can be broken down into three major elements:
 - ❖ The cost of corrosion engineering and materials added into the cost of new automobiles. These costs include corrosion-resistant materials such as galvanized steel and aluminum, coatings beyond what is needed for appearance, and testing of materials and designs.

AREAS OF MAJOR CORROSION IMPACT

- ❖ The cost of repairs and maintenance due to corrosion. This includes the cost of repairing or replacing components of the car, such as radiators, exhaust systems, and electrical/electronic components, due to non-accident-related failures. This cost also includes the periodic replacement of cooling fluids, which need to be changed due to the degradation of corrosion inhibitors rather than a loss of coolant function

AREAS OF MAJOR CORROSION IMPACT

- ❖ The detrimental cosmetic effects of corrosion causes reduced resale values, which often leads to premature replacement of the automobile. Corrosion damage is not likely to necessitate the replacement of a vehicle; however, the reduced value of a vehicle due to corrosion will cause major repairs such as engine or transmission replacement, which often costs more than the car's value. This leads to scrapping of automobiles that might have been worth repairing if corrosion had not occurred

Areas that are more vulnerable for corrosion

- ❖ Automobile body
- ❖ The engine and associated systems
- ❖ Recirculating water-cooling systems
- ❖ Exhaust systems

Corrosion of auto body

- The design of an automobile body shell
 - ✓ Style – attraction
 - ✓ Weight reduction – fuel economy
 - ✓ cold-rolled low-carbon steel strip, selected from a range of tempers and gauges - 0.5, 0.7, and 2 mm
- Basic corrosion protection
 - ✓ Phosphate conversion coatings and paint coating
- Corrosion resistant coatings - should have both protective and cosmetic functions
- Choice of the protective coating
 - ✓ Must be durable but not to incur excessive costs to maintain it beyond the vehicle life expectancy, obsolescent technology and changes in fashion

Corrosion of auto body

Front and Side Panels

- ⦿ receive the most intense exposure to grit and spray
- ⦿ Electrogalvanized steel sheet (EZ steel)
- ⦿ Hot-dip galvanized steel sheet (IZ steel)
- ⦿ Galvannealed steel sheet – formation of a Zn-Fe alloy at the coating/steel interface
- ⦿ EZ steel is least expensive for gauges of 2 mm and above and IZ steel for thinner gauges

Corrosion of auto body

Wheel Arches

- ⦿ vulnerable to paint damage by road stones and grit
- ⦿ irregular contours offer traps for wheel splash that may accumulate as *mud poultices*
- ⦿ These poultices can remain damp, stimulating corrosion long after rain has fallen
- ⦿ The problem is exacerbated by the high conductivity and aggressive nature of chloride-bearing de-icing salts laid down by highway authorities in winter
- ⦿ Such poultices can be more active in a heated garage than in the cold open air
- ⦿ **Remedial measure** - deflect the splash by fitting smooth plastic internal arches over the wheels.



Photograph of poultice build-up of road contaminants in the wheel area of a bus

Corrosion of auto body

Joints

- * Various kinds of joints are there in auto body
- * These joints can act not only as water traps but also as water conduits, so that the site of corrosion may not coincide with the joint
- * Part of the difficulty is that the joints often have to be made during the shell assembly before the application of paint
- * **Remedial measure** - Apply beads of plastic sealer when the shell has received an undercoat of paint

Corrosion of auto body

Rainways

- ☞ Rainways are built into the shell to deflect rain falling on the roof clear of the doors
- ☞ Due to some unforeseen circumstance the rain can be collected and inadvertently directed into a water trap, such as the gap between the hood and bulkhead
- ☞ **Remedial measure** - This is a matter for minor modification

Corrosion of exhaust system

- ❖ Exhaust systems were formerly easily replaced when perforated by corrosion
- ❖ The advent of catalytic converters and a desire by manufacturers to give extended warranties puts them in a new category as long service items
- ❖ Abatement of noise from perforations is another factor
- ❖ Corrosion of exhaust system assumes significance

Corrosion of exhaust system

- ❖ The exhaust gas emitted from automobiles is one cause of air pollution, and various efforts have been made to prevent this problem
- ❖ The exhaust gas from a gasoline engine forms condensed water containing the ions of ammonia, sulfuric acid, chlorine, nitric acid, carbonic acid, etc. when it is cooled
- ❖ These ions are very corrosive and create a very severe environment for materials
- ❖ The whole external surface of an exhaust system must also have corrosion resistance to the deicing salts used in cold districts and to atmospheric salt in coastal districts

Corrosion of exhaust system

- ❖ The muffler of an exhaust system must have sufficient corrosion resistance to withstand the internal attack of condensed water containing these corrosive ions and external attack of these salts
- ❖ The materials mainly used for these components are low-carbon ferritic stainless steel incorporating not less than 11% chromium
- ❖ The components nearer to the engine in front of the muffler need high oxidation resistance, because they are heated to about 773K (500°C) during operation
- ❖ The exhaust manifold, which is heated to the highest temperature, must possess both high-temperature strength and resistance to thermal fatigue
- ❖ High-chromium stainless steel is now used mainly for these upstream components. As a result, the life of the exhaust system has been substantially extended

1E(2) Stainless Steels Used in Exhaust Systems

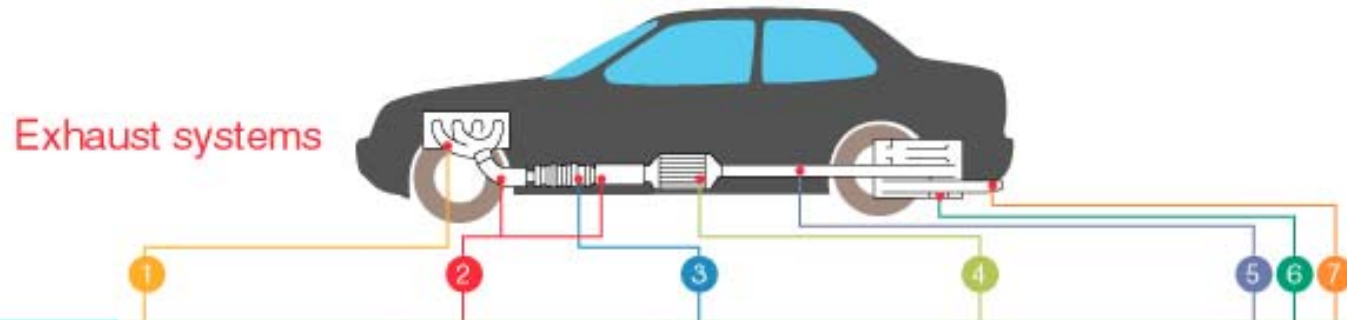

Exhaust systems	1.Exhaust manifold	2.Front pipe	3.Flexible pipe	4.Converter	5.Center pipe 6.Muffler 7.Tail pipe
Aim	Fuel saving	Cost reduction	High durability	Cost reduction	High durability
Performance	High temperature oxidation-resistance Thermal fatigue strength	High temperature oxidation-resistance High temperature corrosion-resistance	High temperature oxidation-resistance High temperature corrosion-resistance	High temperature oxidation-resistance	Corrosion-resistance to salt and condensed liquid
Materials	409L 430LX type	409L 410L	304 304 mod. 305 mod.	409L 410L 20Cr-5Al	409L 410L

$\left. \begin{array}{l} 304 \quad | \quad 18\text{Cr}-8\text{Ni} \\ 305 \quad | \quad 18\text{Cr}-12\text{Ni} \end{array} \right\}$ Austenitic stainless steels

$\left. \begin{array}{l} 409\text{L} \quad | \quad 11\text{Cr} \\ 410\text{L} \quad | \quad 12\text{Cr} \\ 430\text{LX} \quad | \quad 18\text{Cr}-\text{Nb} \end{array} \right\}$ Low C ferritic stainless steels

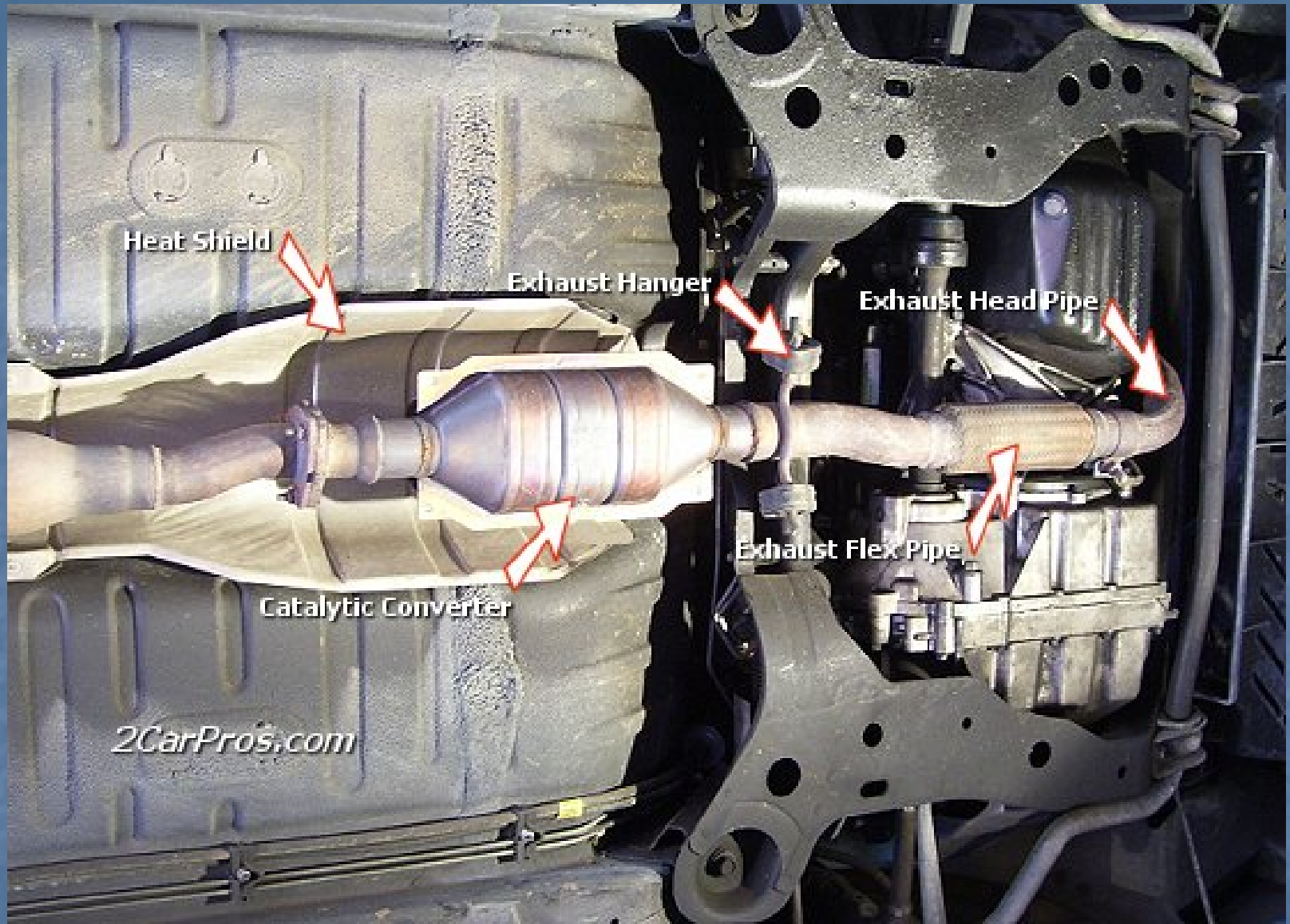

Heat Shield

Exhaust Hanger

Exhaust Head Pipe

Catalytic Converter

Exhaust Flex Pipe

2CarPros.com

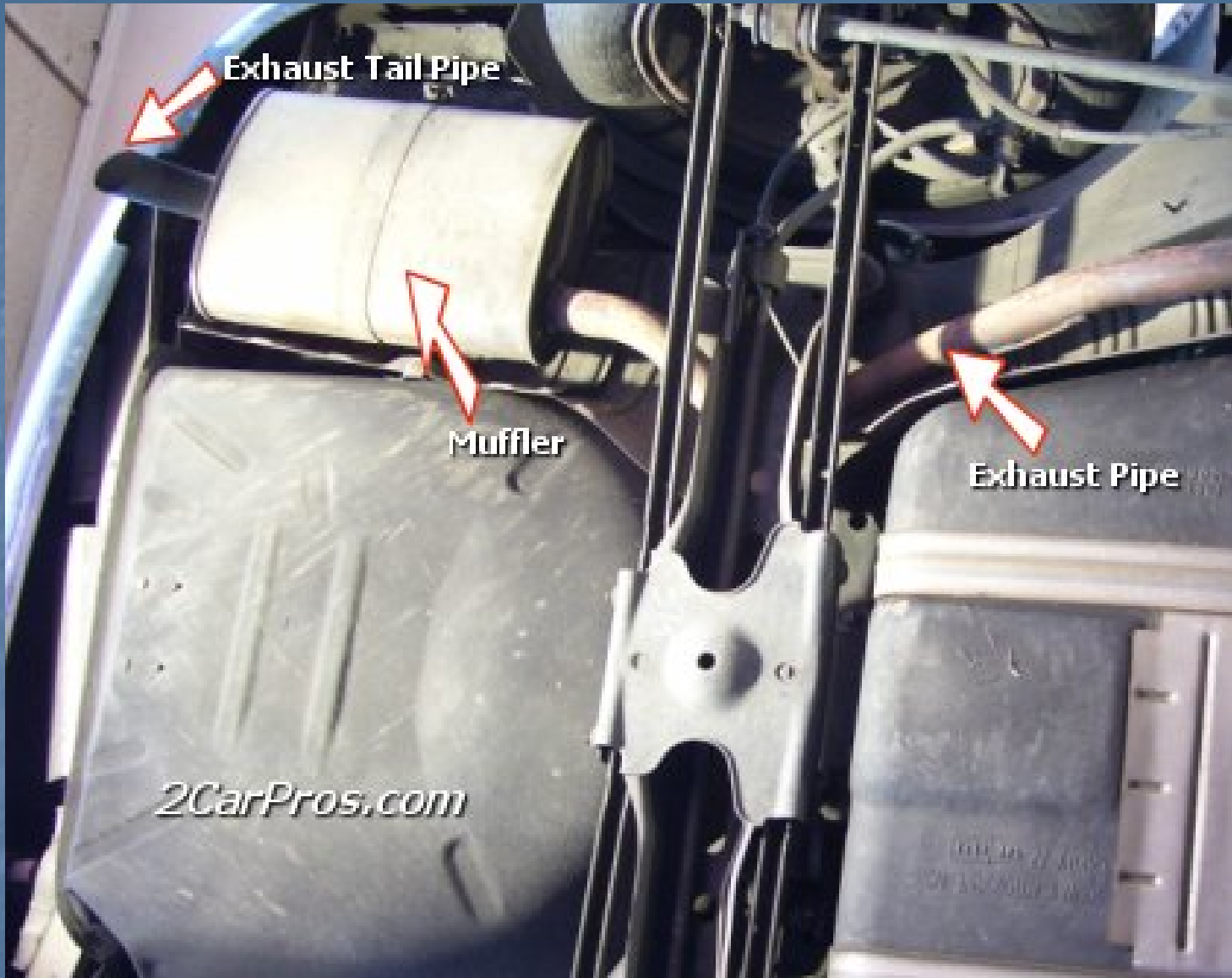

Exhaust Tail Pipe

Muffler

Exhaust Pipe

2CarPros.com

Corrosion of exhaust system

- ❖ The environment in the exhaust front section is more aggressive
 - ❖ it must run hotter to admit gases to the converter at a high enough temperature
 - ❖ the consequences of corrosion are more serious because oxide flakes can block the catalyst and perforation can allow combustion gases to bypass it
- ❖ the front end and the catalyst containment casing are formed from AISI 409 stainless steel
- ❖ During short trips, the effect of the converter increases the condensation of acidified water in the exhaust rear section and mufflers associated with it
- ❖ These items must be well protected; they are made from seam-welded mild steel protected by hot-dip aluminizing

Corrosion of aluminized low carbon steel exhaust system

- ❖ In automobiles equipped with three-way catalytic converters (TWCCs) with no secondary air, the cause of corrosion of the exhaust system has been identified to be ammonium sulfate formation
- ❖ Ammonia is formed over three-way catalysts (TWCs) under reducing conditions and reacts with sulfur trioxide, formed during lean conditions and stored on high surface area Al_2O_3 , to form ammonium sulfate
- ❖ The condensate solution of ammonium sulfate thus formed in the exhaust system reacts with the aluminized surface of the aluminized low-carbon steel, stripping it away and corroding the low carbon steel components
- ❖ A coating composition has been developed from a new phenolic-type epoxy resin and diaminodiphenyl sulfone. This coating has a softening temperature higher than $200^{\circ}C$ and is thermally stable in air up to $375^{\circ}C$

Corrosion of cooling system

- ❖ The cooling system - mixed metal system in closed circuit
- ❖ Water ways in engine block - iron or cast Al-Si alloy
- ❖ Heat exchangers - aluminum or copper sheet
- ❖ Thermostats -soldered copper bellows
- ❖ The whole system is connected by rubber hoses
- ❖ The coolant in winter is not water but an antifreeze mixture of water and typically 25% ethylene glycol
- ❖ Glycol - oxidizing inhibitors such as chromates and nitrites
- ❖ A mixture of inhibitors is needed to cope with the mixed metals system
- ❖ A common system is 1% borax, to act as a mild alkaline buffer, pH 9, to passivate iron and steel with 0.1% mercaptobenzothiazole to inhibit cuprosolvency that can deposit copper on steel causing indirect galvanic stimulation

Increase consciousness of corrosion costs and potential savings.	Total cost of corrosion in the automotive sector is \$23.4 billion.
Change perception that nothing can be done about corrosion.	Examine the cause of failure of electrical and other components. Convince the public that corrosion is still causing problems in automobiles.
Advance design practices for better corrosion management.	Increase the use of specialty metals in electrical systems and other components.
Change technical practices to realize corrosion cost-savings.	Continue to update technical practices based on new materials and design considerations.
Change policies and management practices to realize corrosion cost-savings.	Show management, through various studies, that small expenditures on corrosion can provide huge cost-benefits.
Advance life prediction models and performance assessment methods.	Assess the percentage of electronic component failures that are due to corrosion to determine the extent of the problem.
Advance technology (research, development, and implementation).	Use advanced alloys and materials from other industries for certain critical components.
Improve education and training for corrosion control.	Educate the public and technicians that not all corrosion on automobiles involves red rust.

Corrosion in Soils

Corrosion in soils

- ❖ Soil is an aggregate of minerals, organic matter, water, and gases (mostly air)
- ❖ Corrosion in soils is a major concern
- ❖ Corrosion in soils is related to
 - oil, gas, and water pipelines
 - buried storage tanks (a vast number are used by gas stations);
 - electrical communication cables and conduits;
 - anchoring systems; and
 - well and shaft casings
- ❖ Such systems are expected to function reliably and continuously over several decades

Corrosion in soils

- ∅ Corrosion in soils is a complex phenomenon, with a multitude of variables involved
- ∅ Variations in soil properties and characteristics across three dimensions can have a major impact on corrosion of buried structures

Soil parameters affecting corrosivity

- Several important variables have been identified that have an influence on corrosion rates in soil.
 - ✓ Water
 - ✓ degree of aeration
 - ✓ pH
 - ✓ redox potential
 - ✓ Resistivity
 - ✓ soluble ionic species (salts)
 - ✓ Microbiological activity.

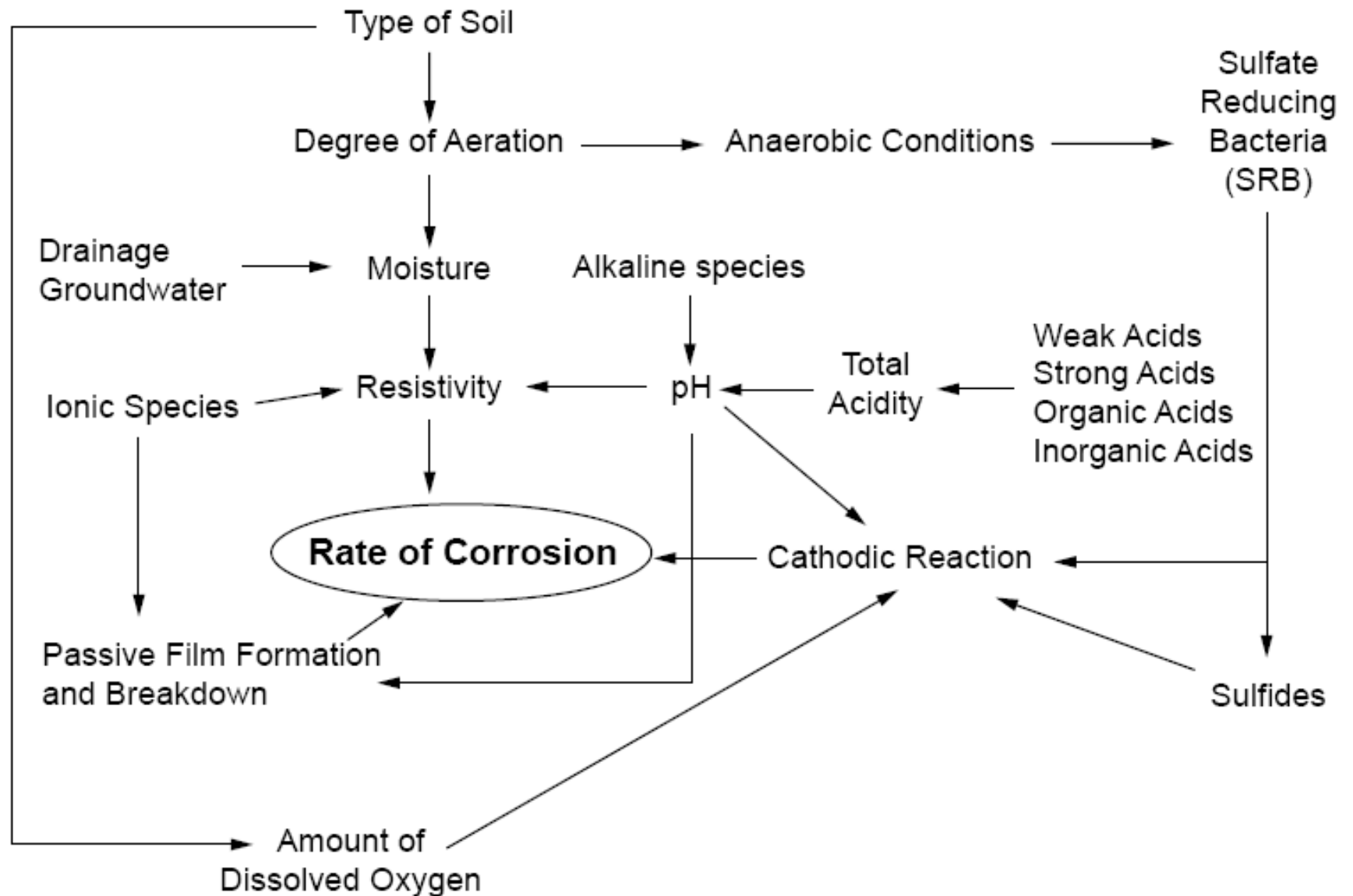

Relationship of variables affecting the rate of corrosion in soil

Degree of aeration

- Oxygen concentration decreases with increasing depth of soil
- In neutral or alkaline soils, the oxygen concentration obviously has an important effect on corrosion rate as a result of its participation in the cathodic reaction
- Oxygen transport is more rapid in coarse-textured, dry soils than in fine, waterlogged textures
- Excavation can obviously increase the degree of aeration in soil, compared with the undisturbed state
- Corrosion rates in disturbed soil with greater oxygen availability are significantly higher than in undisturbed soil

pH

- Soils usually have a pH range of 5 to 8. In this range, pH is generally not considered to be the dominant variable affecting corrosion rates
- More acidic soils obviously represent a serious corrosion risk to common construction materials such as steel, cast iron, and zinc coatings
- Soil acidity is produced by mineral leaching, decomposition of acidic plants (for example, coniferous tree needles), industrial wastes, acid rain, and certain forms of microbiological activity
- Alkaline soils tend to have high sodium, potassium, magnesium, and calcium contents.
- The latter two elements tend to form calcareous deposits on buried structures, and these have protective properties against corrosion.
- The pH level can affect the solubility of corrosion products and also the nature of microbiological activity

Soil resistivity

- ∅ Resistivity has often been used as a broad indicator of soil corrosivity.
- ∅ Since ionic current flow is associated with soil corrosion reactions, high soil resistivity will arguably slow down corrosion reactions
- ∅ Soil resistivity is by no means the only parameter affecting the risk of corrosion damage
- ∅ A high soil resistivity alone will not guarantee absence of serious corrosion
- ∅ Variations in soil resistivity along the length of a pipeline are highly undesirable, as this will lead to the formation of macro corrosion cells.
- ∅ Therefore, for structures such as pipelines, the merit of a corrosion risk classification based on an absolute value of soil resistivity is limited.
- ∅ Soil resistivity generally decreases with increasing water content and the concentration of ionic species

Redox potential

- ✧ The redox potential is essentially a measure of the degree of aeration in a soil
- ✧ A high redox potential indicates a high oxygen level
- ✧ Low redox values may provide an indication that conditions are conducive to anaerobic microbiological activity
- ✧ Sampling of soil will obviously lead to oxygen exposure, and unstable redox potentials are thus likely to be measured in disturbed soil.

Chlorides

- ❏ Chloride ions are generally harmful, as they participate directly in anodic dissolution reactions of metals
- ❏ Furthermore, their presence tends to decrease the soil resistivity
- ❏ They may be found naturally in soils as a result of brackish groundwater and historical geological sea-beds (some waters encountered in drilling mine shafts have chloride ion levels comparable to those of seawater) or come from external sources such as deicing salts applied to roadways
- ❏ The chloride ion concentration in the corrosive aqueous soil electrolyte will vary as soil conditions alternate between wet and dry.

Sulfates

- * Compared to the corrosive effect of chloride ions, sulfates are generally considered to be more benign in their corrosive action toward metallic materials
- * However, concrete may be attacked as a result of high sulfate levels
- * The presence of sulfates does pose a major risk for metallic materials in the sense that sulfates can be converted to highly corrosive sulfides by anaerobic sulfate-reducing bacteria

Microbiologically influenced corrosion

- MIC refers to corrosion that is influenced by the presence and activities of microorganisms and/or their metabolites (the products produced through their metabolism)
- Bacteria, fungi, and other microorganisms can play a major part in soil corrosion
- rapid corrosion failures have been observed in soil as a result of microbial action
- Most metallic alloys are susceptible to some form of MIC

Soil corrosivity classifications

- ❖ For design and corrosion risk assessment purposes, it is desirable to estimate the corrosivity of soils, without conducting exhaustive corrosion testing
- ❖ Corrosion testing in soils is complicated by the fact that long exposure periods may be required (buried structures are usually expected to last for several decades) and that many different soil conditions can be encountered
- ❖ One of the simplest classifications is based on a single parameter, soil resistivity
- ❖ Sandy soils are high on the resistivity scale and therefore are considered to be the least corrosive
- ❖ Clay soils, especially those contaminated with saline water, are on the opposite end of the spectrum
- ❖ The soil resistivity parameter is very widely used in practice and is generally considered to be the dominant variable in the absence of microbial activity

Corrosivity Ratings Based on Soil Resistivity

Soil resistivity, $\Omega \cdot \text{cm}$	Corrosivity rating
> 20,000	Essentially noncorrosive
10,000–20,000	Mildly corrosive
5000–10,000	Moderately corrosive
3000–5000	Corrosive
1000–3000	Highly corrosive
< 1000	Extremely corrosive

Point System for Predicting Soil Corrosivity According to the AWWA C-105 Standard

Soil parameter	Assigned points
Resistivity, Ω·cm	
< 700	10
700–1000	8
1000–1200	5
1200–1500	2
1500–2000	1
> 2000	0
pH	
0–2	5
2–4	3
4–6.5	0
6.5–7.5	0
7.5–8.5	0
> 8.5	3
Redox potential, mV	
> 100	0
50–100	3.5
0–50	4
< 0	5
Sulfides	
Positive	3.5
Trace	2
Negative	0
Moisture	
Poor drainage, continuously wet	2
Fair drainage, generally moist	1
Good drainage, generally dry	0

If the total points of a soil is 10 or higher - cathodic protection is recommended

Variables Considered in Worksheet of Soil Corrosivity

Rating number	Parameter
R1	Soil type
R2	Resistivity
R3	Water content
R4	pH
R5	Buffering capacity
R6	Sulfides
R7	Neutral salts
R8	Sulfates
R9	Groundwater
R10	Horizontal homogeneity
R11	Vertical homogeneity
R12	Electrode potential

Overall Soil Corrosivity Classification

Summation of R1 to R12 ratings	Soil classification
≥ 0	Virtually noncorrosive
-1 to -4	Slightly corrosive
-5 to -10	Corrosive
≤ -10	Highly corrosive

Corrosion characteristics of metals and alloys

- ❖ Steels are widely used in soil without additional corrosion protection – it is very vulnerable to localized corrosion damage (pitting) when buried in soil
- ❖ Such attack is usually the result of differential aeration cells, contact with different types of soil, MIC, or galvanic cells when coal particles come into contact with buried steel
- ❖ Stray current flow in soils can also lead to severe pitting attack
- ❖ A low degree of soil aeration will not necessarily guarantee low corrosion rates for steel, as certain microorganisms associated with severe MIC damage thrive under anaerobic conditions

Corrosion characteristics of metals and alloys

- ❖ The primary form of corrosion protection for steel buried in soil is the application of coatings. When such coatings represent a physical barrier to the environment, cathodic protection in the form of sacrificial anodes or impressed current systems is usually applied as an additional precaution
- ❖ This additional measure is required because coating defects and discontinuities will inevitably be present in protective coatings

Copper and galvanized steel tubes

- Copper is considered to have good resistance to corrosion in soils
- Corrosion concerns are mainly related to highly acidic soils and the presence of carbonaceous contaminants such as cinder
- Chlorides and sulfides also increase the risk of corrosion damage
- Contrary to common belief, copper and its alloys are not immune to MIC
- Cathodic depolarization, selective leaching, Under deposit corrosion, and differential aeration cells have been cited as MIC mechanisms for copper alloys
- Galvanized steel - Performance is usually satisfactory unless soils are poorly aerated

Reinforced concrete pipes

- ✓ There are three dominant species in soils that lead to excessive degradation of reinforced concrete piping
 - ❖ Sulphate
 - ❖ Chloride
 - ❖ Acidic soils
- ✓ Sulfate ions tend to attack the tricalcium aluminate phase in concrete, leading to severe degradation of the concrete/mortar cover and enable exposure of the reinforcing steel
- ✓ Mechanism of degradation - formation of a voluminous reaction product in the mortar, which leads to internal pressure buildup and subsequent disintegration of the cover

Reinforced concrete pipes

- ☞ Sulfate levels $> 2\%$ by weight in soils and groundwater reportedly put concrete pipes at risk
- ☞ Chloride ions are also harmful, as they tend to diffuse into the concrete and lead to corrosion damage to the reinforcing steel
- ☞ A common source of chloride ions is soil contamination by deicing salts
- ☞ Acidic soils present a corrosion hazard
- ☞ The protective alkaline environment that passivates the reinforcing steel can be disrupted over time
- ☞ Carbonic acid and humic acid are examples of acidic soil species

Summary

- ✱✱ Corrosion processes in soil are highly complex phenomena, especially since microbiologically influenced corrosion can play a major role
- ✱✱ Soil parameters tend to vary in three dimensions, which has important ramifications for corrosion damage
- ✱✱ The corrosion behavior of metals and alloys in other environments should not be extrapolated to their performance in soil
- ✱✱ In general, soils represent highly corrosive environments, often necessitating the use of additional corrosion protection measures for common engineering metals and alloys

Corrosion of electronics

Various electrical components and materials of construction

Component	Design	Materials
Printed Circuit Board	Metallic conductor separated by insulating materials	Copper, copper alloys, copper clad materials, epoxy, resins, ceramics, woven glass fiber, electroplate, solder, tin, lead, conformal coatings
Contacts	Electrical contact maintained by mechanical force	Base Metal - copper alloys, steels (clad) Contact Surface - gold, palladium, silver-palladium, silver, tin, tin-lead, copper
Connectors	Electrical connections between systems or boards	Spring Material - beryllium copper, stainless steels Contact Surface - gold, palladium, silver, silver-palladium, tin, tin-lead
Switches and Relays	Cyclic electrical connection	Copper alloys, steels, stainless steels, electroplate and contact surface materials
Grounding contacts	For shielding	Copper, steels, aluminum, nickel, tin, tin-lead and contact surface materials Copper, aluminum
Thermal contacts Integrated circuits	Heat sinks Small dimension complex systems	Gold, silver, aluminum, Kovar, solder, glass, ceramic, silicon, silicon dioxide, silicon nitride, tungsten

Corrosion of electronics

- ❖ Corrosion in electronic components manifests itself in several ways
- ❖ Computers, integrated circuits, and microchips are now an integral part of all technology-intensive industry products, ranging from aerospace and automotive to medical equipment and consumer products, and are therefore exposed to a variety of environmental conditions
- ❖ Corrosion in electronic components is insidious and cannot be readily detected
- ❖ Therefore, when corrosion failure occurs, it is often dismissed as just a failure and the part is replaced
- ❖ Because of the difficulty in detecting and identifying corrosion failures, the cost of corrosion is difficult to determine
- ❖ A significant part of all electric component failures may be caused by corrosion

Corrosion of electronics

- ❖ In recent years, corrosion of electronic systems has been a significant issue
 - ❖ Multiplicity of materials used is one reason limiting the corrosion reliability
 - ❖ The reduced spacing between components on a printed circuit board (PCB) due to miniaturization of device is another factor that has made easy for interaction of components in corrosive environments
 - ❖ unpredictable user environment
 - ❖ The presence of less than 1 microgram of corrosion product on the surface of a connector is in some cases a sufficient amount to interrupt the flow of electrons between mating contacts, thus rendering the component useless
 - ❖ Presently the knowledge on corrosion issues of electronics is very limited

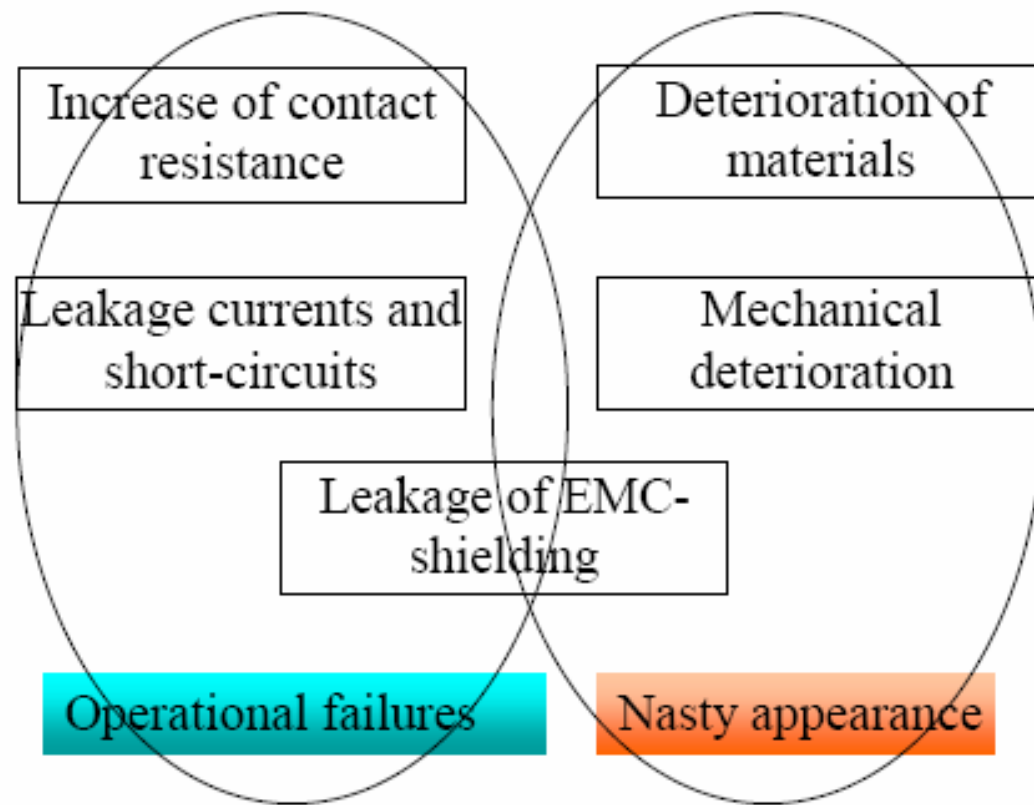

Figure 1.1. Basic problems caused by corrosion in electronics.

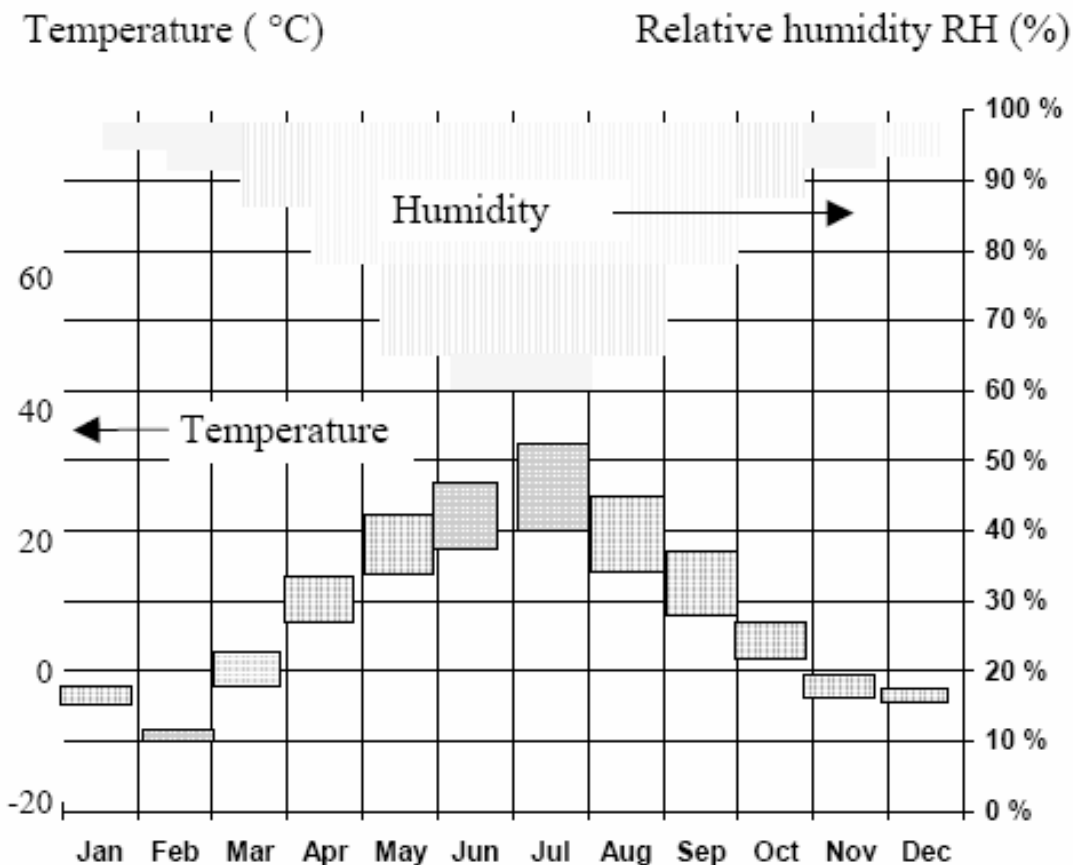

Figure 1.4. Weather averages of temperate and cold regions during various seasons (Middle Europe, Canada and northern parts of United States) [Gellerstedt 1995 and STANAG 1980].

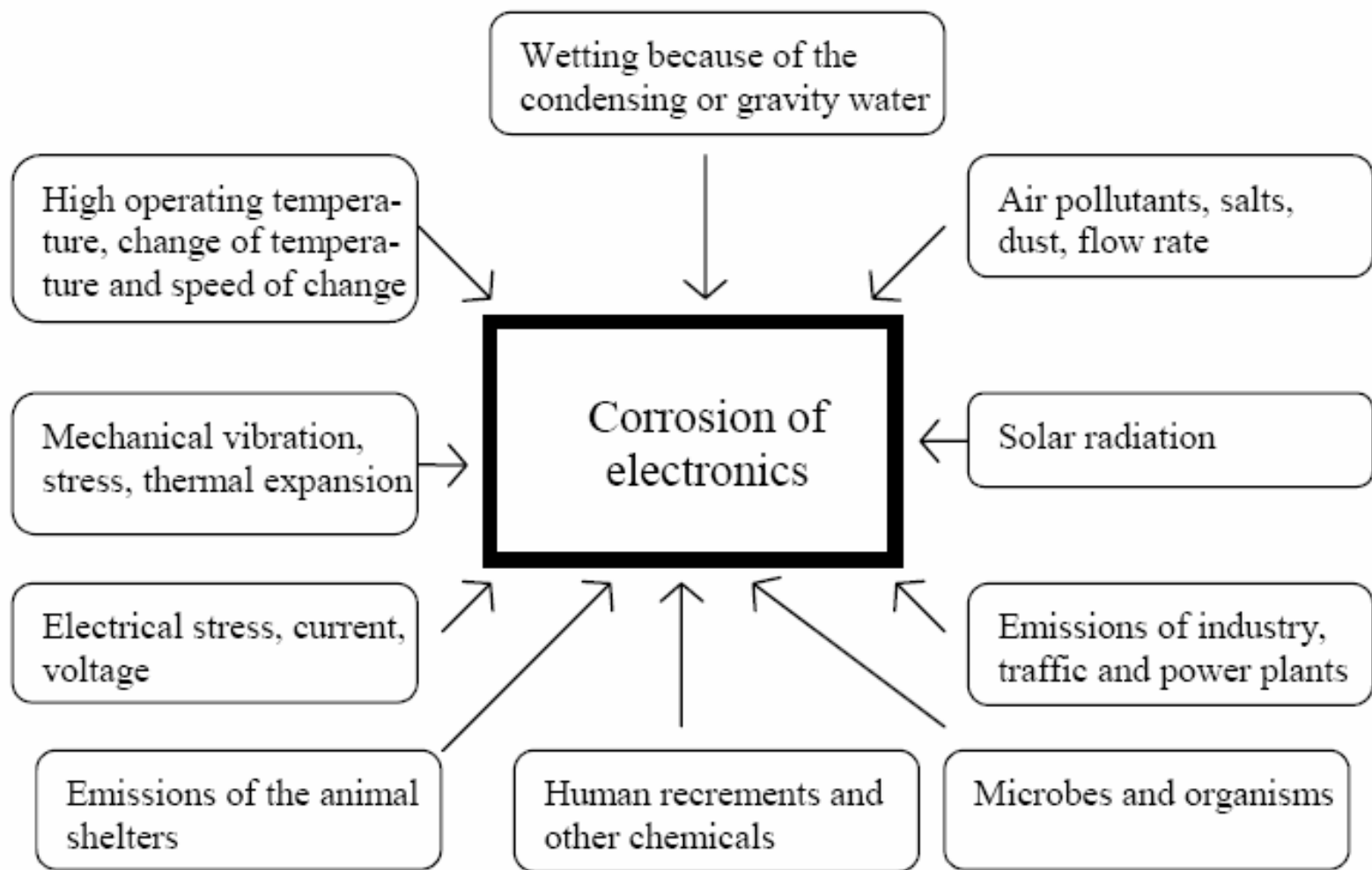

Figure 1.5. Conditions increasing the risk of corrosion.

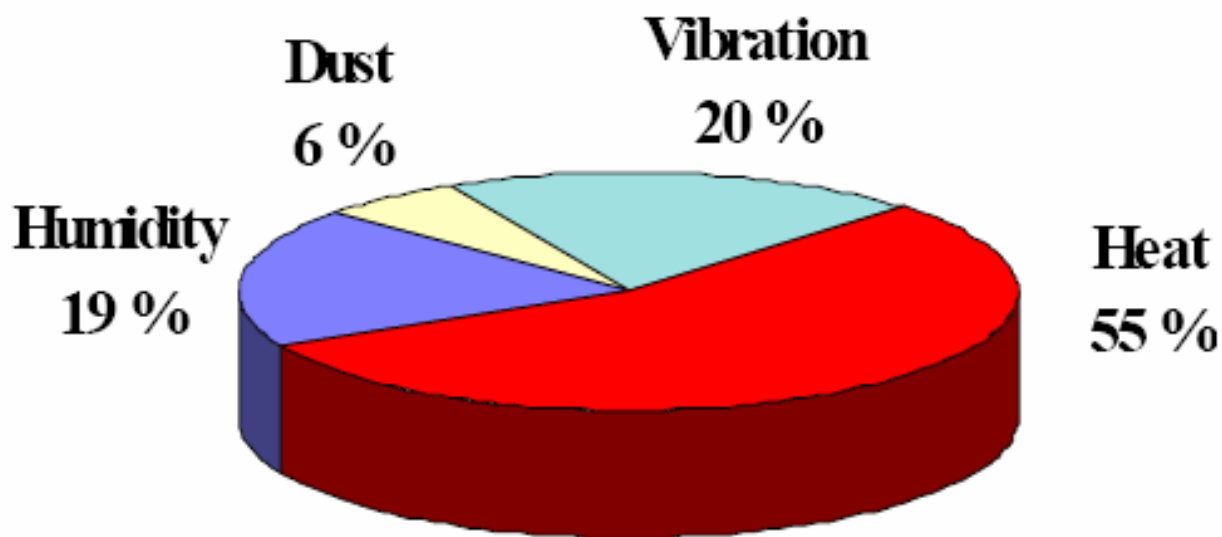

Figure 1.6. Reasons for failures of electronics in aviation (Flomerics, US Air Avionics Integrity Program, Journal of the IEST).

Bare metal surfaces

Separable connector contacts

EMC-contacts and seals

Switches and relays

Keyboards

Absorption of water in plastics

Wiring spaces and conductivity of insulation surfaces

Solder areas and wiring of PWB:s

Solder connections

Leads of components

Capillar spaces

Semi-tight boxes

Figure 1.8. Areas with corrosion risk in electronics.

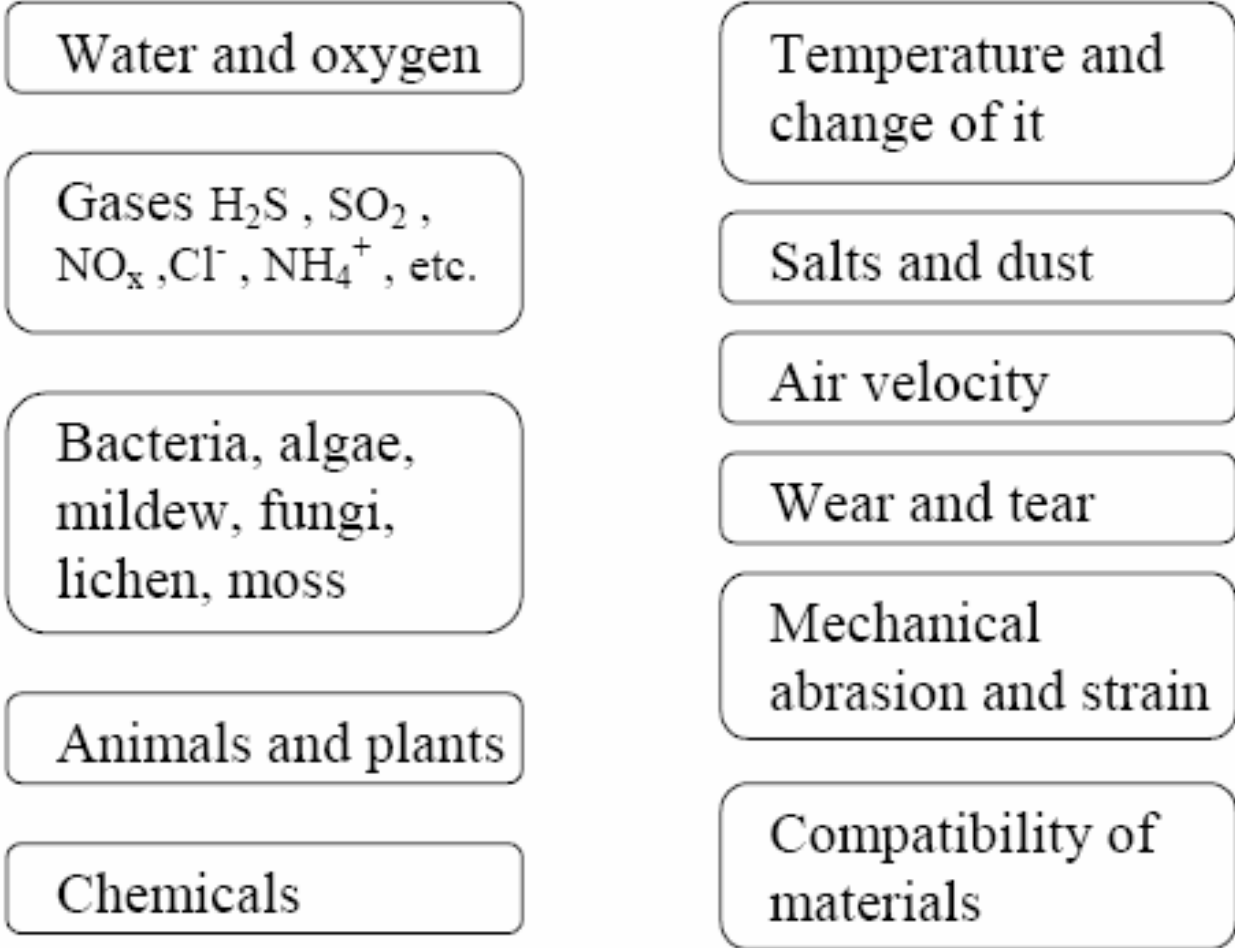

Figure 2.2. Corrosive environmental effects.

Corrosion and climatic effects

Electrical functionality	Change of series resistance in contacts Breaks of conductors Change of insulation resistance Leakage currents, soiled surfaces Short-circuits Change of dielectric constant of materials Faults of component packages Faults of component leads Breaks of cables
Mechanical functionality	Increase of friction Hindering of movement Weakening of spring Fault of contact mechanism Fault of switch mechanism Sudden breaks during heat and mechanical stresses
Mechanical strength	Break of mechanical actuator Break of supporting structure Break of solder joint
Appearance	Nusty appearance Faults in outer surface Color changes of platings Soiled surfaces Disappearance of markings
Malfunction	Intermittent failure Groundless change of new component Rejection of nearly intact device Failure of software EMC-fault, fault in electric supply or LAN

Figure 2.4. Classification of corrosion effects according to category.

Table 3.1. Effects of humidity on equipment [IEC 60068-1, table I].

Humidity	Principal effects	Typical failure
High relative humidity	Moisture absorption or adsorption Swelling Loss of mechanical strength Corrosion and electrolysis Increased conductivity of insulators Increase of dielectric constant ϵ_r	Physical breakdown, insulation failure, mechanical failure, increase of dielectric losses
Low relative humidity	Desiccation Embrittlement Loss of mechanical strength Shrinkage Abrasion of moving contacts	Mechanical failure, cracking

Electronic components that experience significant corrosion problems

- ❖ Integrated Circuits (ICs)
- ❖ Printed Circuit Board (PCB)
- ❖ Switches
- ❖ Magnetic Recording Media (Hard disc)
- ❖ Packaging and shielding parts

Major forms of corrosion
observed in electronic systems

Gas phase corrosion

- ❖ Presence of low levels of hydrogen sulphide could create severe problems in electronics
- ❖ The most susceptible material to H_2S in the electronic system is silver due to the formation of silver sulphide crystals
- ❖ The problem is well known in environments even with low concentrations of H_2S (under 50ppb), which is below the detection limit of H_2S by smell

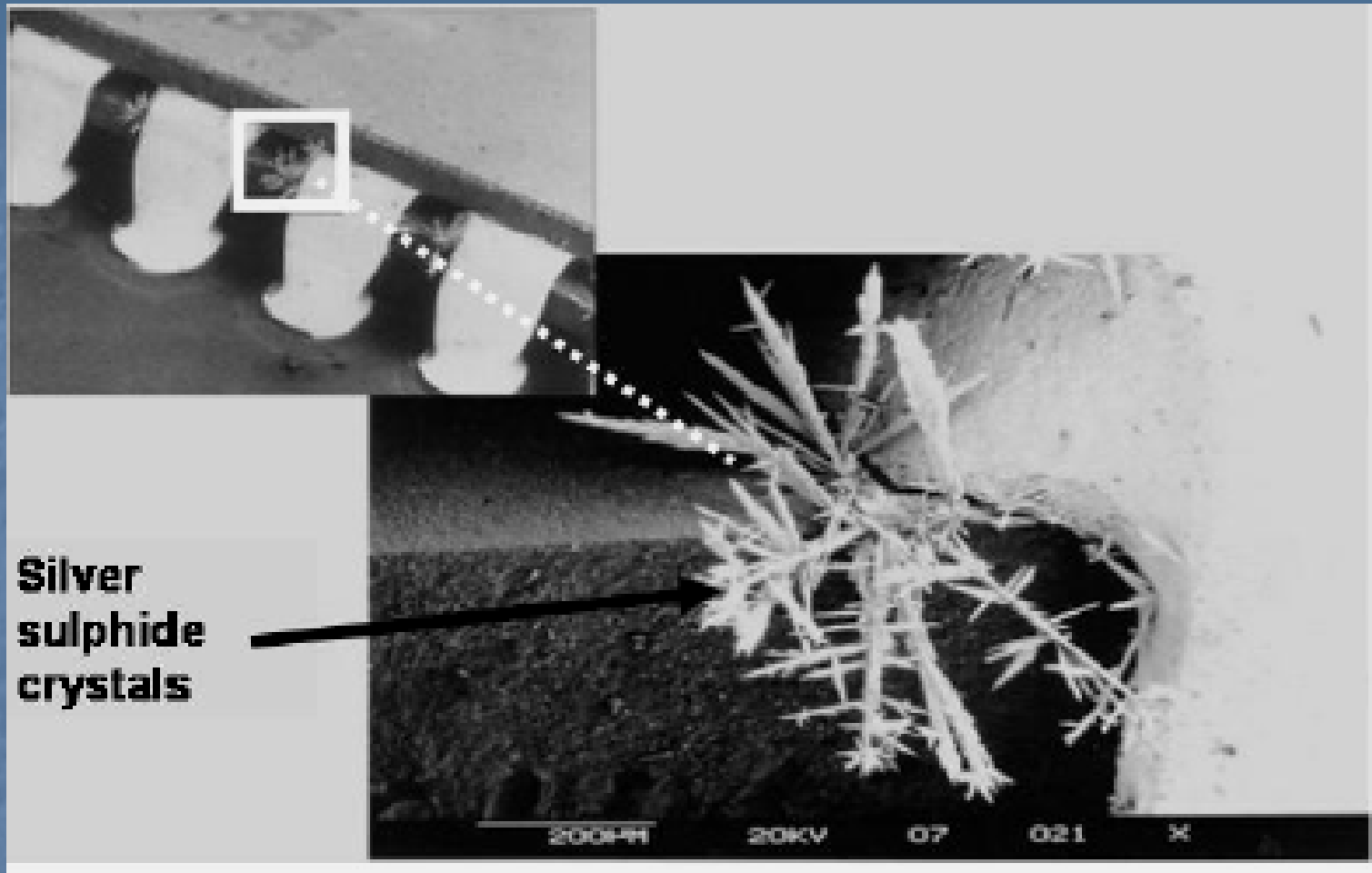

Formation of silver sulphide on a silver-palladium film on exposure to H₂S

Anodic corrosion and electrolytic metal migration

- ❖ Electrolytic migration is a typical form of corrosion found on electronic systems
- ❖ It is usually observed in equipments exposed to high magnetic or electric field
- ❖ In an electronic system, electrolytic migration occurs due to the presence of a potential gradient between two conductors connected by a thin layer of solution
- ❖ Two solder points on a PCB connected by a thin layer of liquid water
- ❖ The metal ions dissolve from the positive electrode (anode) and migrate towards the oppositely charged negative electrode (cathode) and deposit there

Anodic corrosion and electrolytic metal migration

- ❖ Only few metals are susceptible to electrolytic migration, while others just precipitate as hydroxides or other compounds
- ❖ A typical example of non-migrating metal used in electronics is aluminium. In humid environment with chlorides, aluminium dissolves and forms hydroxide (or hydroxy chlorides) instead of migrating to the cathode regions
- ❖ On the other hand metals like Cu, Ag, Sn, Pb etc. migrate upon dissolution and deposit at the cathode at least over a range of potentials and pH predicted by the Pourbaix diagram

Anodic corrosion and electrolytic metal migration

- ❖ Electrolytic metal migration is a very common form of corrosion observed for electronic systems attributed to the presence of susceptible metals such as Pb, Sn, Cu, Au, Ag etc.
- ❖ Due to electrolytic migration, dendrites grow from cathode to anode filling the gap finally leading to electric short and system failure

Anodic corrosion and electrolytic metal migration

- ❖ Electrochemical migration will become one of the most severe problems in electronic soldering for the following two reasons
- ❖ Reason 1 - The narrow conductor spacing due to miniaturization
- ❖ At constant voltage, the electric field between the conductors rises inversely with the conductor spacing, and electrochemical migration is known to be enhanced under high electric fields
- ❖ Reason 2 – the changes in the micro-soldering process
- ❖ Soldering in inert gas atmospheres using low residue fluxes and the so called no-clean fluxes that require no cleaning step have become popular.
- ❖ The change in the cleaning and soldering processes provides a higher chance for corrosion and ECM.

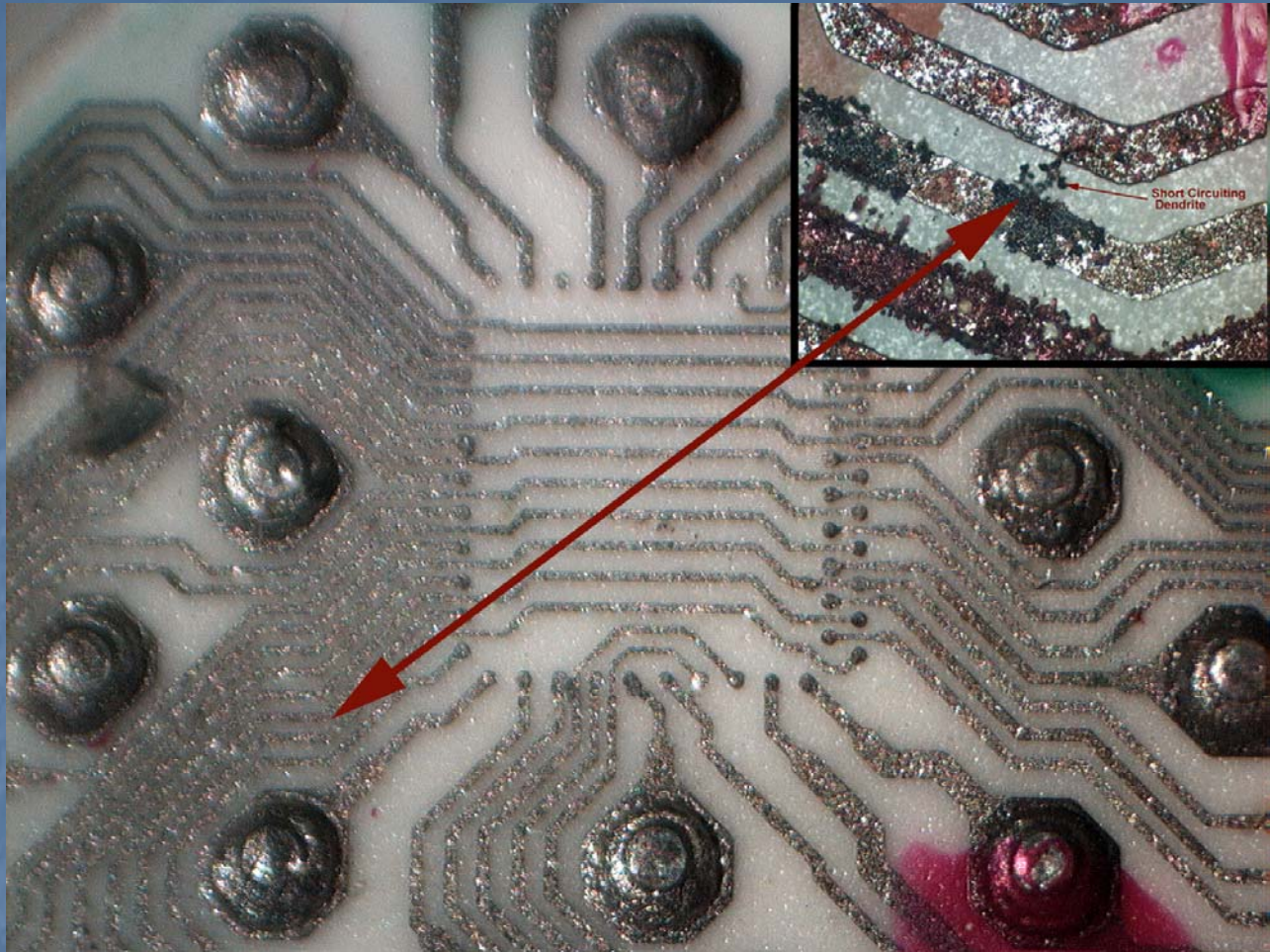

Short circuit in microelectronics due to corrosion and dendritic growth

Cathodic corrosion

- ❖ Some metals used for electronic systems are soluble in acidic and alkaline environments over a wide range of potentials and pH
- ❖ Cathode - oxygen reduction takes place, which produce OH⁻ ions.
- ❖ Production of OH⁻ ions at the cathode surface shifts the pH to alkaline values causing the metals like aluminium to dissolve
- ❖ Among the metallic materials used for electronic applications, aluminium conducting paths for IC chips are susceptible to this type of corrosion

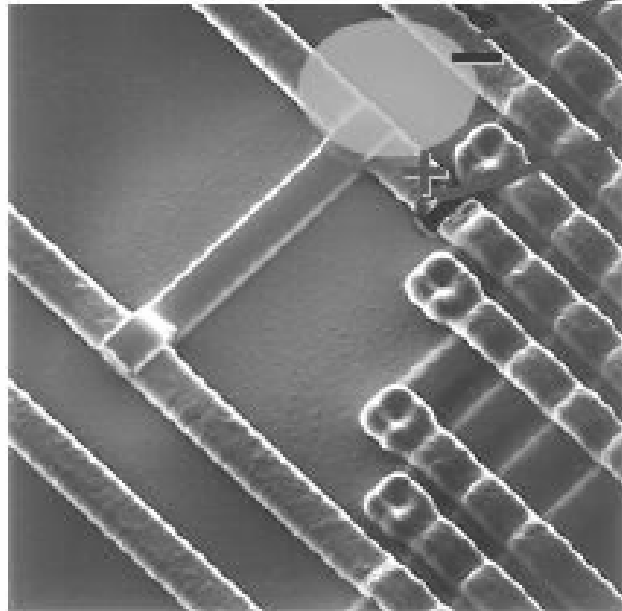

Water condensation

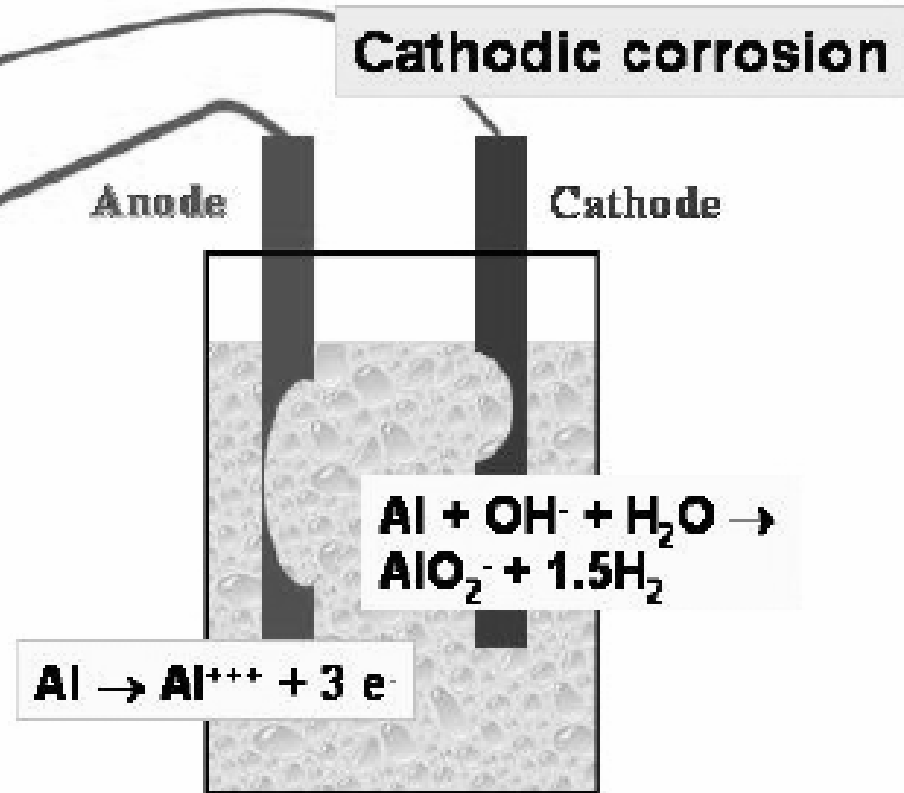

Cathodic corrosion

Anode

Cathode

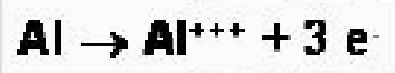
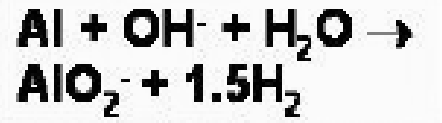

Schematic of the possible cathodic corrosion problem for aluminium conducting lines on ICs.

Galvanic corrosion

- ❖ Connectors are made of multi-layer metallic coatings
- ❖ The metallic layers have distinctly different electrochemical properties - ENIG parts on the PCB
- ❖ The immersion gold (IM Au) layer is porous that exposes part of the EL Ni layer
- ❖ The large difference in electrochemical potential between EL Ni and IM Au cause corrosion of EL Ni, while the Au layer acts as powerful cathode
- ❖ As the corrosion proceeds, pitting of EL Ni layer exposes Cu at deep pit areas
- ❖ Even in the absence of porosity on the top coating, the gap between metallic component and resist edge can be point where all the metallic layers get exposed to the solution
- ❖ Palladium - substitute for gold; Pd has faster cathodic reaction kinetics than gold - use of Pd can enhance the galvanic corrosion problems

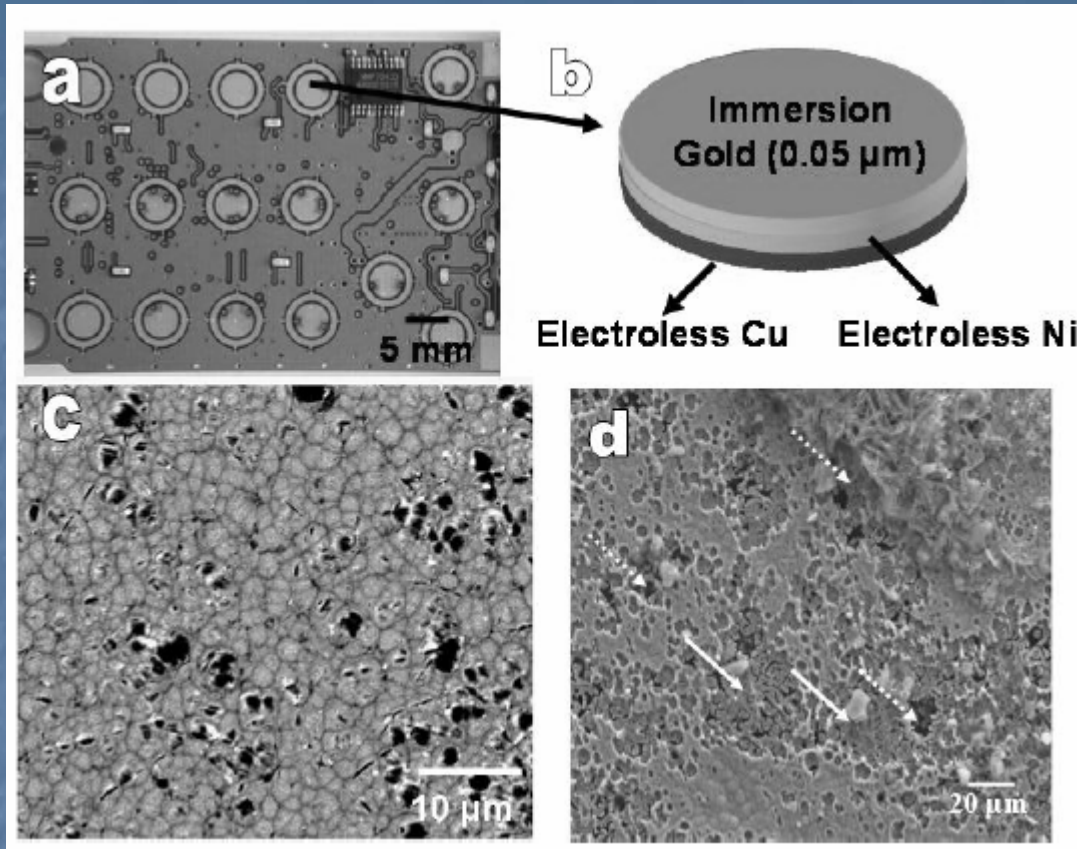

Cell phone key-pad system and galvanic corrosion
(a) key-pad, (b) schematic of the layers on key-pad
(c) microstructure of the gold layer, and (d) corrosion of the
key-pad in chloride solutions

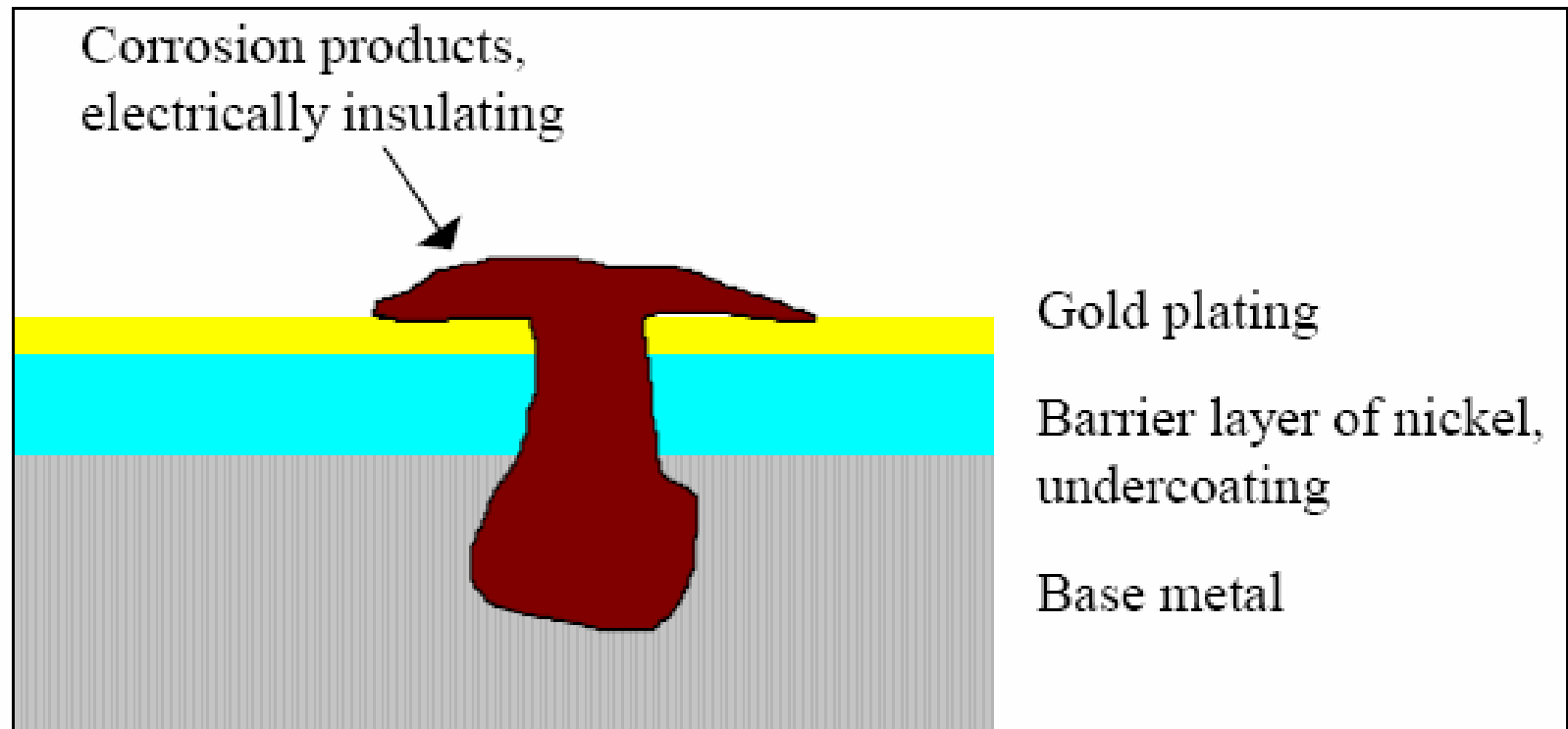
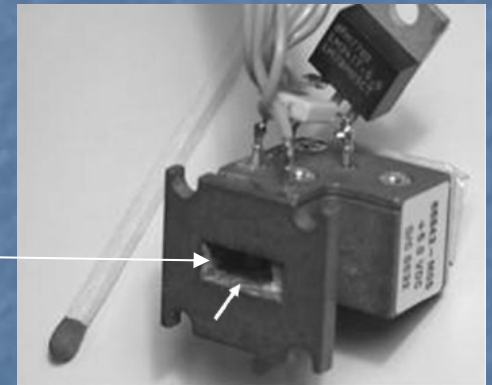

Figure 2.3. Pore corrosion on a contact [Henriksen et al. 1991].

Stray current corrosion

- ❖ Stray currents can occur if the conductors are placed in a high electric or magnetic fields.
- ❖ micro waves induce severe turbulent flow on the surface of Al, which in combination with a wet surface - there will be large eddy currents in the fluid film
- ❖ The rate of corrosion depends upon the local resistivity of the electrolyte.
- ❖ Presence of stray currents over the PCB surface can generate corrosion problems

Severe corrosion was noticed on the surface after a few hours of use



Stray current corrosion of a microwave module for 24 GHz used in a control equipment made of an aluminium-silicon die-cast alloy followed by chromate passivation

Fretting corrosion

Use fault tolerant technology

(Use large tolerances of the components in the electric design and maximize the allowed changes of series resistances and leakage currents on the signal paths.)

Minimize the gas contacts on the electronics

(Minimize the air flow and its velocity inside electronics and use mechanical protecting covers, avoid bare metal surfaces.)

Keep dry the surfaces of electronics and make sure to take off water from boxes

(Heat, isolate, ventilate, breath and prevent gravity water and condensation on the surfaces.)

Avoid excess temperature changes and vibration

(Take care of avoiding fretting of contacts.)

Use chemically (electrically) compatible materials in the electrical contacts and connectors

(Dont use very dissimilar metals in direct contact with each other to avoid bimetallic (galvanic) corrosion.)

Protect the metallic surfaces against the direct contact of the air and the water

(Use protective coatings.)

Figure 1.7. Physical basic principles of corrosion control.

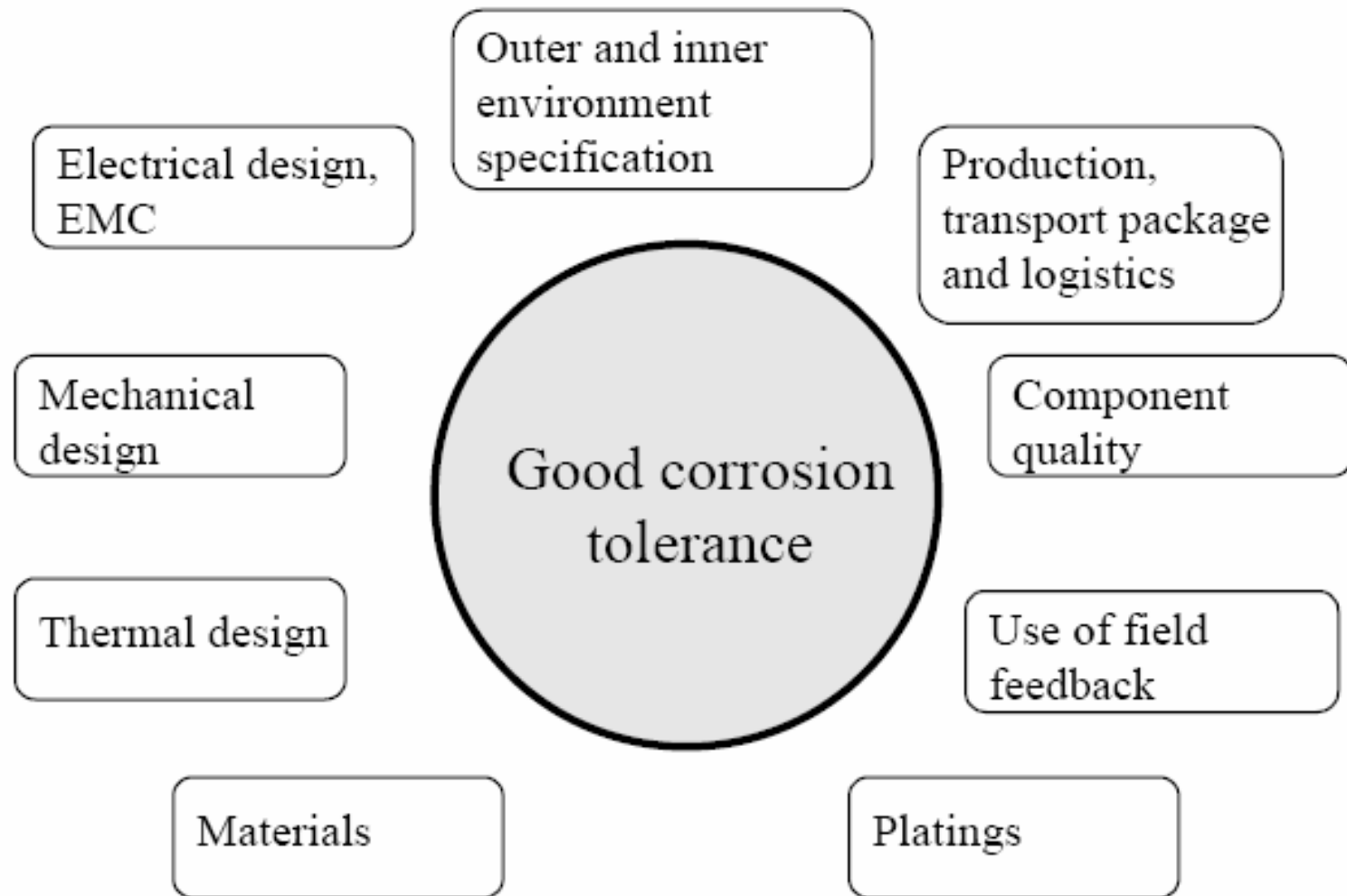

Figure 1.9. Sub-areas of the design for corrosion tolerance.

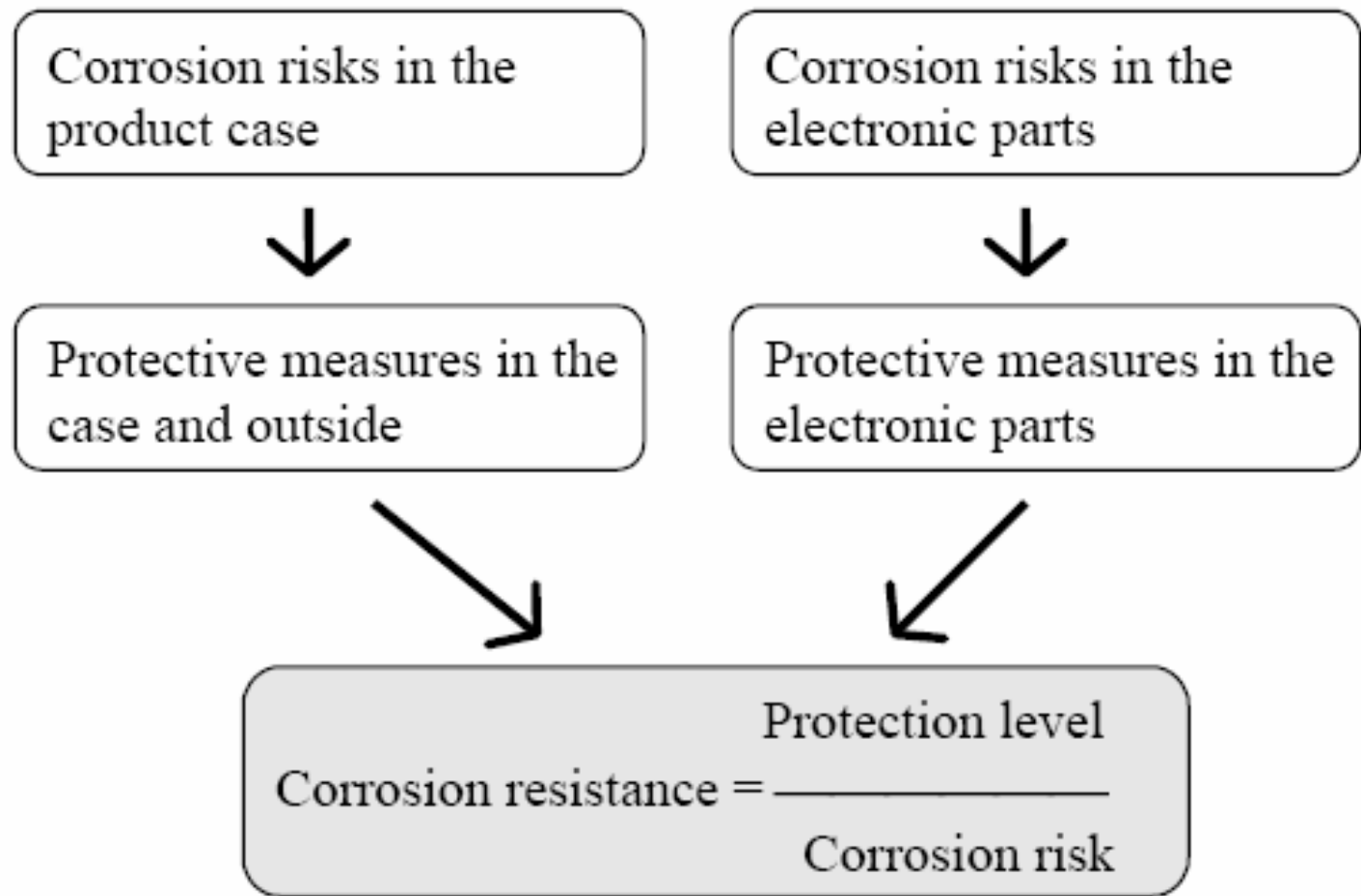

Figure 4.3. Definition of overall level of corrosion resistance.

Environmental Testing of Electronics

•Cabinet Accelerated Testing

•Thermal Cycling(-30° C to 440° C)

•Mixed Flow Gas Testing (MFG)

•Surface Contamination Studies

•Special Design Testing

•Failure Analysis Root Cause Determination

•Corrosion Testing

•Materials, Coating Selection

•Residual Gas Analysis

•Conformal Coating of Printed Circuit Boards

•Research & Development

•QUV, Humidity, Temperature, Mixed Gases

Corrosion of steel in concrete

Concrete and rebar corrosion – A preamble

- Concrete is the most widely produced material on earth
- Worldwide consumption of concrete is close to 9 billion tons and is expected to rise even further
- Concrete has low strength when loaded in tension, and hence it is common practice to reinforce concrete with steel, for improved tensile mechanical properties
- The principal cause of degradation of steel-reinforced structures is corrosion damage to the rebar embedded in the concrete
- The cost of rebar corrosion in the United States alone were estimated at \$150 to \$200 billion per year (1990)

Concrete as a structural material

- The fundamental ingredients required to make concrete are cement clinker, water, fine aggregate, coarse aggregate, and certain special additives
- The cement reacts with water to form the so-called cement paste, which surrounds the coarse and fine aggregate particles and holds the material together
- Cement paste is not a continuous solid material and it is classified as a "gel" due to its limited crystalline character and the water-filled spaces between the solid phases

Concrete as a structural material

- These microscopic spaces are also known as gel “pores” are filled with an ionic solution rather than “water.”
- Additional pores of larger size are found in the cement paste and between the cement paste and the aggregate particles
- The pores that result from excess water in the concrete mix are known as capillary pores
- Concrete is a porous material, and it is this porosity that allows the ingress of corrosive species to the embedded reinforcing steel

Pore solution and corrosivity

- ✚ The pore solution in concrete is highly alkaline - calcium hydroxide, sodium and potassium hydroxide are formed, resulting in a pH between 12.5 and 13.6.
- ✚ Under such alkaline conditions, reinforcing steel tends to display completely passive behavior, as fundamentally predicted by the Pourbaix diagram for iron
- ✚ In the absence of corrosive species penetrating into the concrete, ordinary carbon steel reinforcing thus displays excellent corrosion resistance.

Corrosion damage in reinforced concrete

- Concrete durability directly related to the strength of concrete
- Higher water-to-cement ratios in concrete lead to lower strength and increase the degree of porosity in the concrete
- low strength, more permeable concrete is less durable
- The soundness of concrete under service conditions implies freedom from cracking

Corrosion damage in reinforced concrete

- Under environmental weathering and loading effects, the permeability of the concrete gradually increases as the network of “defects” becomes more interconnected over time
- It is then that water, carbon dioxide, and corrosive ions such as chlorides can enter the concrete and produce detrimental effects at the level of the reinforcing steel.
- The buildup of corrosion products leads to a buildup of internal pressure in the reinforced concrete because of the voluminous nature of these products.
- In turn, these internal stresses lead to severe cracking and spalling of the concrete covering the reinforcing steel

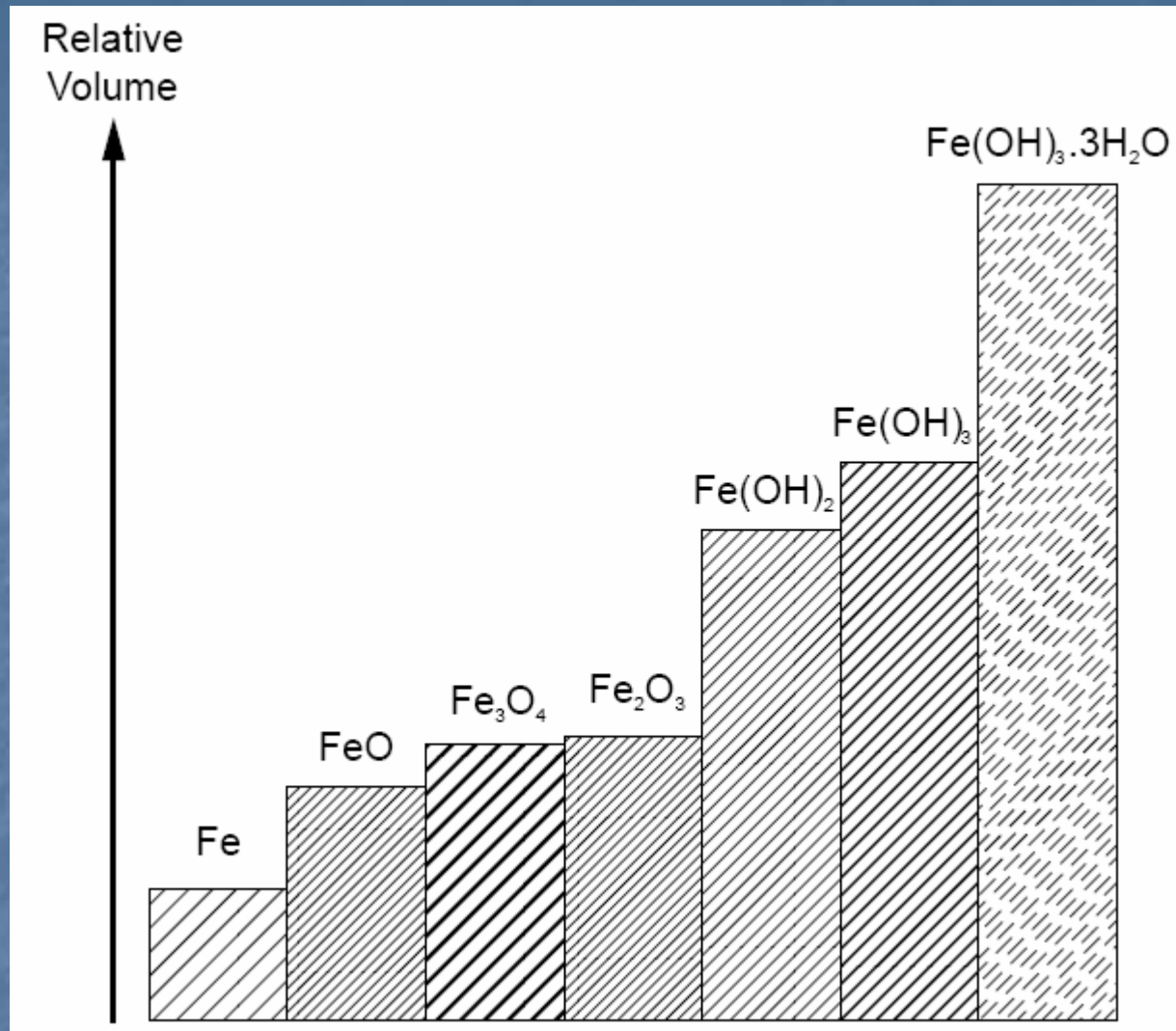

Relative volume of possible rebar corrosion products

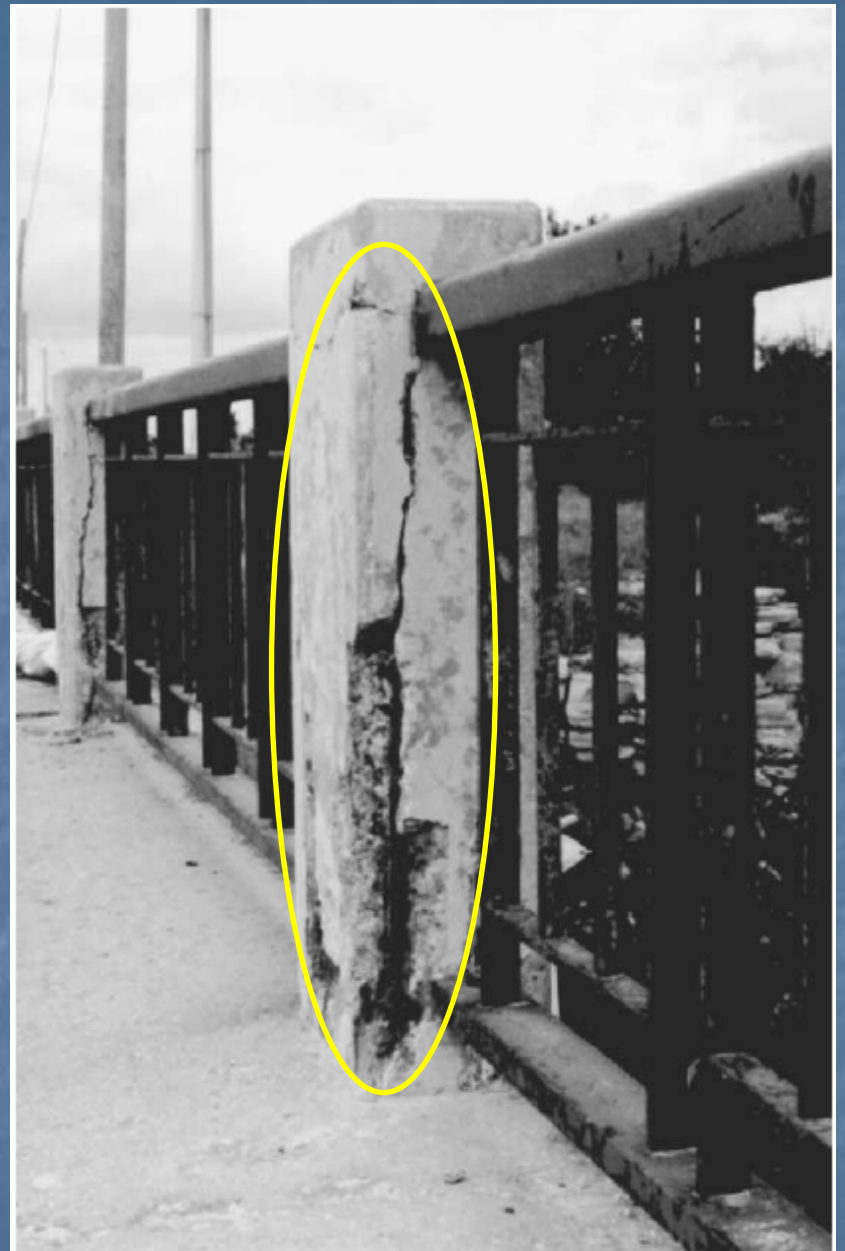
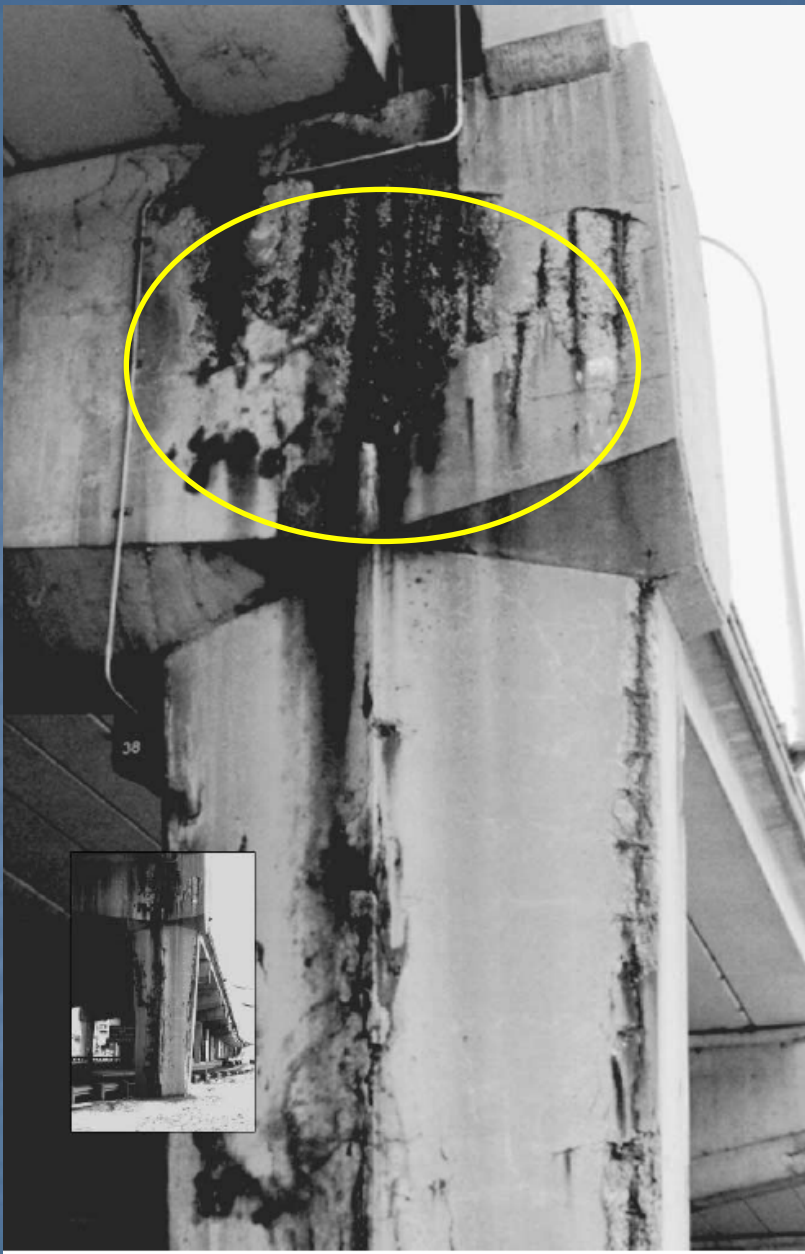

Concrete degradation caused by rebar corrosion

The role of cracks in the concrete

- ✧ The importance of concrete cracks in rebar corrosion has also been highlighted
- ✧ Both carbonation and chloride ion diffusion, two important processes associated with rebar corrosion, can proceed more rapidly into the concrete along the crack faces, compared with uncracked concrete
- ✧ Corrosion in the vicinity of the crack tip could be accelerated further by crevice corrosion effects and galvanic cell formation
- ✧ The steel in the crack will tend to be anodic relative to the cathodic (passive) zones in uncracked concrete

Corrosion mechanisms

- *
** The two most common mechanisms of reinforcing steel corrosion damage in concrete are:
 - *
** localized breakdown of the passive film by chloride ions
 - *
** carbonation, a decrease in pore solution pH, leading to a general breakdown in passivity
- *
** Harmful chloride ions usually originate from deicing salts applied in cold climate regions or from marine environments/atmospheres
- *
** Carbonation damage is predominantly induced by a reaction of concrete with carbon dioxide (CO₂) in the atmosphere

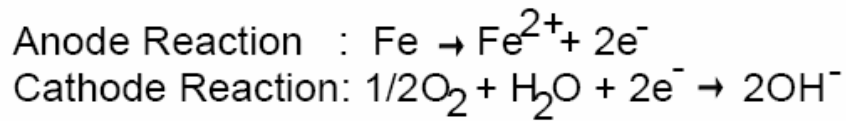

Oxygen diffuses into
the Concrete

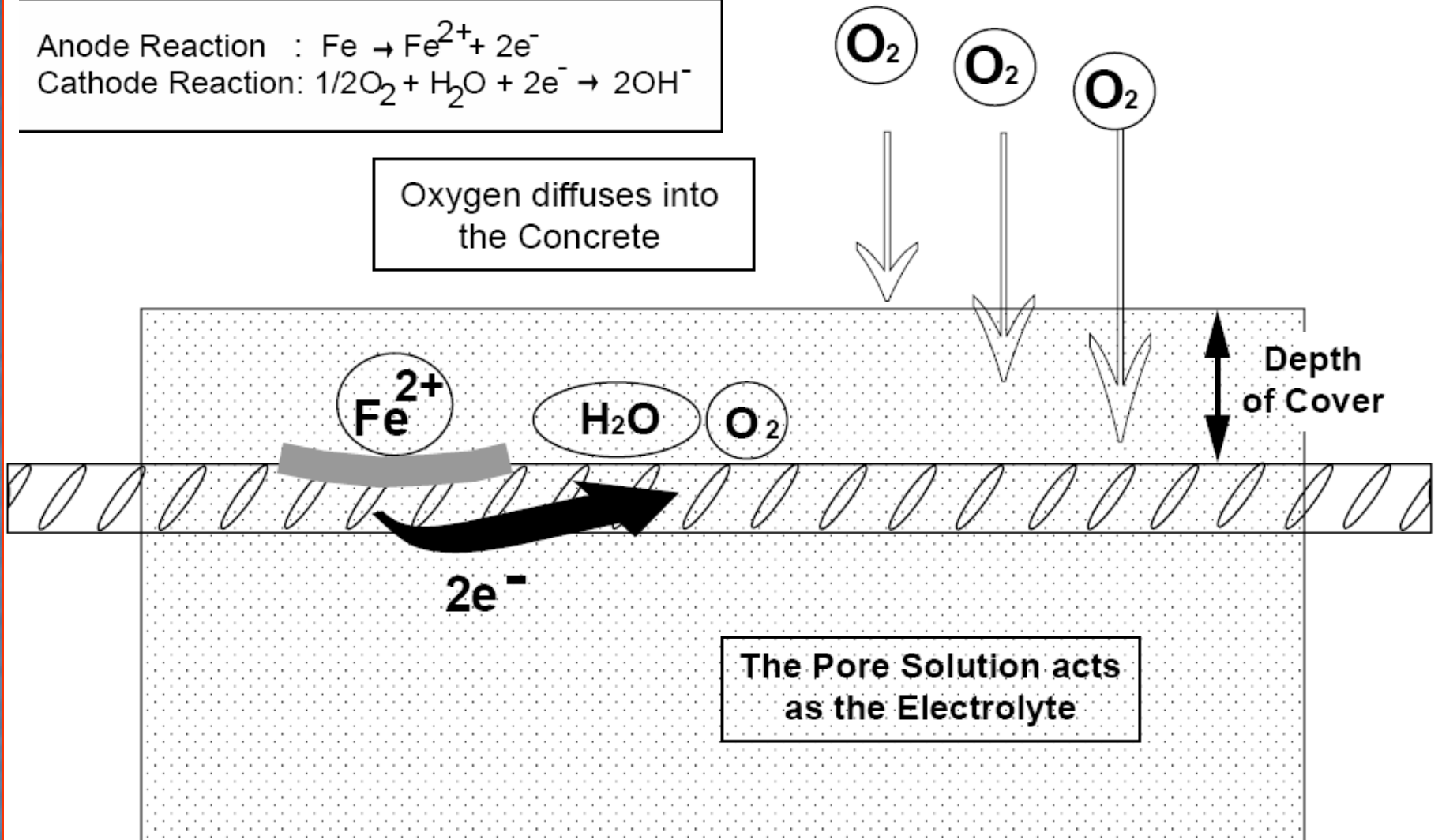

Schematic illustration of electrochemical
corrosion reactions in concrete

Chloride-induced rebar corrosion

- * Chloride ions in the pore solution, having the same charge as OH^- ions, compete with these anions to combine with the Fe^{2+} cations
- * The resulting iron chloride complexes are thought to be soluble (unstable); therefore, further metal dissolution is not prevented, and ultimately the buildup of voluminous corrosion products takes place
- * Chloride ions also tend to be released from the unstable iron chloride complexes, making these harmful ions available for further reaction with the reinforcing steel
- * As the iron ultimately precipitates out in the form of iron oxide or hydroxide corrosion products, it can be argued that the consumption of hydroxide ions leads to localized pH reduction and therefore enhanced metal dissolution

Chloride-induced rebar corrosion

- * Chloride-induced rebar corrosion tends to be a localized corrosion process, with the original passive surface being destroyed locally under the influence of chloride ions
- * Apart from the internal stresses created by the formation of corrosion products leading to cracking and spalling of the concrete cover, chloride attack ultimately reduces the cross section and significantly compromises the load-carrying capability of steel-reinforced concrete

Sources of chloride ions and diffusion into concrete

- ❏ The harmful chloride ions leading to rebar corrosion damage either originate directly from the concrete mix constituents or diffuse into the concrete from the surrounding environment
- ❏ The use of seawater or aggregate that has been exposed to saline water (such as beach sand) in concrete mixes
- ❏ Calcium chloride has been deliberately added to certain concrete mixes to accelerate hardening at low temperatures

Sources of chloride ions and diffusion into concrete

- An important source of chlorides from the external environment is the widespread use of deicing salts on road surfaces in cold climates
- Other obvious important sources of corrosive chloride ions are seawater and marine atmospheres
- Alternate drying and wetting cycles promote the buildup of chloride ions on surfaces
- Hence actual surface concentrations of chlorides can be well in excess of those of the bulk environment
- the diffusion rate of external chlorides into concrete to the reinforcing steel is very important

Types of chlorides in concrete

- ✓ Chlorides in concrete exist in two basic forms, so-called free chlorides and bound chlorides
- ✓ Free chlorides - mobile chlorides dissolved in the pore solution
- ✓ Bound chlorides - relatively immobile chloride ions that interact (by chemical binding and/or adsorption) with the cement paste
- ✓ Both bound and free chlorides are important in corrosion processes

Critical chloride level

- ∅ The determination of a critical chloride level, below which serious rebar corrosion damage does not occur is very important for design, maintenance planning, and life prediction purposes
- ∅ Unfortunately, the concept of a critical chloride content as a universal parameter is unrealistic
- ∅ Rather, a critical chloride level should be defined only in combination with a host of other parameters

Factors influencing the threshold chloride level for corrosion damage

- ◉ The pore solution pH
- ◉ Moisture content of the concrete
- ◉ Temperature
- ◉ Age and curing conditions of the concrete
- ◉ Water-to-cement ratio
- ◉ Pore structure and other “defects”
- ◉ Oxygen availability
- ◉ Presence of prestressing
- ◉ Cement and concrete composition

Carbonation-induced corrosion

- ⇒ Carbon dioxide present in the atmosphere can reduce the pore solution pH significantly by reacting with calcium hydroxide (and other hydroxides) to produce insoluble carbonate in the concrete

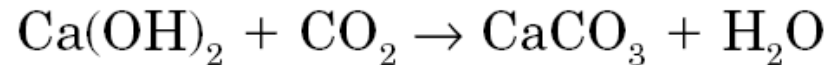

- ⇒ The passivating ability of the pore solution diminishes with the decrease in pH
- ⇒ Carbonation-induced corrosion tends to proceed in a more uniform manner over the rebar surface than chloride-induced corrosion damage
- ⇒ The rate of ingress of carbonation damage in concrete decreases with time
- ⇒ The precipitation of calcium carbonate and possibly additional cement hydration are also thought to contribute to the reduced rate of ingress

Synergistic effect of chloride and carbonation

- ✉ In many practical situations, carbonation- and chloride-induced corrosion can occur in tandem
- ✉ Research studies have shown that corrosion caused by carbonation was intensified with increasing chloride ion concentration
- ✉ Chloride attack and carbonation can act synergistically (the combined damage being more severe than the sum of its parts) and have been responsible for major corrosion problems in hot coastal areas

Remedial measures

- ✓ Repairing the damaged concrete
- ✓ Modifying the external environment
- ✓ Modifying the internal concrete environment
- ✓ Creating a barrier between the concrete and the external environment
- ✓ Creating a barrier between the rebar steel and the internal concrete environment
- ✓ Applying cathodic protection to the rebar
- ✓ Using alternative, more corrosion-resistant rebar materials
- ✓ Using alternative methods of reinforcement

Electrochemical chloride extraction

- ⇒ Electrochemical removal of harmful ions such as chloride ions – similar to cathodic protection
- ⇒ Establishing an anode and a caustic electrolyte on the external concrete surface, and impressing a direct current between the anode and the reinforcing steel, which acts as the cathode
- ⇒ Under the application of this electric field, chloride ions migrate away from the negatively charged steel and toward the positively charged external anode

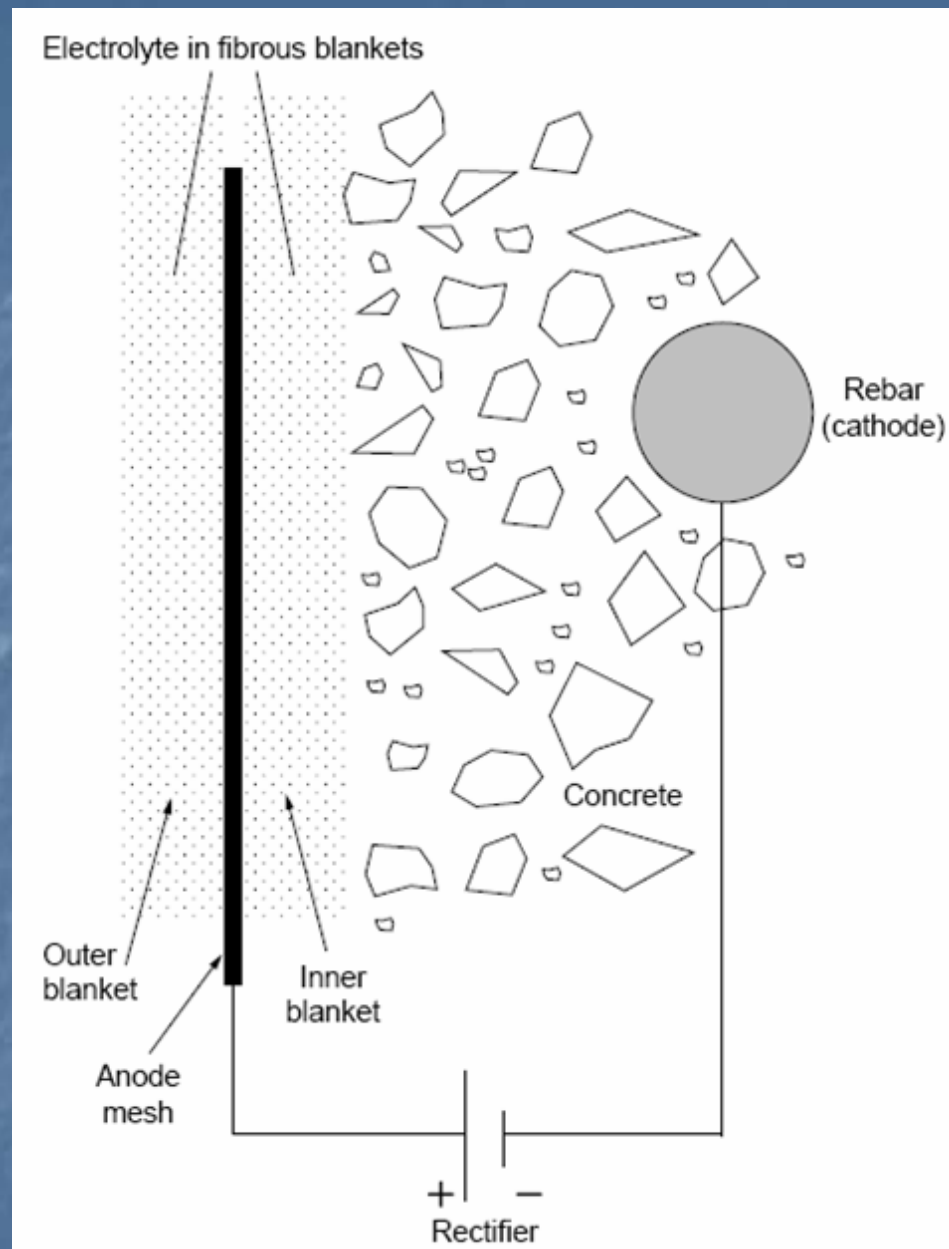

Principle of electrochemical chloride extraction and re-alkalization treatments

Limitations of the chloride extraction method

- ❖ The current densities involved are significantly higher than those used in cathodic protection
- ❖ The risk of hydrogen evolution on the rebar and subsequent hydrogen embrittlement is clearly much greater than in cathodic protection
- ❖ Further requirements are a high degree of rebar electrical continuity and preferably low concrete resistance
- ❖ Since the extraction processes require several days or even weeks using suitable current densities, the technique is more applicable to highway substructures than to bridge decks

Limitations of the chloride extraction method

- The method does not remove the chloride ions from the concrete completely. A certain percentage is removed and the balance is redistributed away from the reinforcing bars. Importantly, through the cathodic reaction on the rebar surface, OH^- ions are generated, which have an important effect in counteracting the harmful influence of chloride ions

Limitations of the chloride extraction method

- The applied current density has to be controlled. If the current magnitude is excessive, several problems such as reduction in bond strength, softening of the cement paste around the rebar steel, and cracking of the concrete could arise
- Though electrochemical chloride extraction has been applied industrially for a number of years and can be an effective control method for chloride induced corrosion of existing structures, it is a relatively complex method and requires specialized knowledge to implement it successfully

Re-alkalization

- ⇒ This treatment is applied to existing structures, to restore alkalinity around reinforcing bars in previously carbonated concrete
- ⇒ Principle is similar to electrochemical chloride extraction
 - Direct current is applied between the cathodic rebar and external anodes positioned at the external concrete surface and surrounded by electrolyte
- ⇒ The external electrolyte used in re-alkalization is a sodium carbonate solution, with a caustic pH

Re-alkalization

- ⇒ The current density applied in re-alkalization is significantly higher. Typically, the process is applied for several days to restore alkalinity in carbonated concrete
- ⇒ The potential disadvantages of re-alkalization are similar to those of chloride extraction, namely, risk of reduced bond strength, hydrogen embrittlement, alkali-aggregate reaction, and other microstructural changes in the concrete.

Differences between corrosion protection in new and repaired structures

New Structures

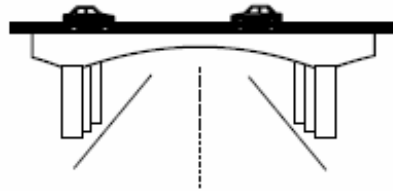

Service life includes corrosion initiation and propagation phases

Reinforcement experiences a relatively uniform internal concrete environment (at least initially)

Durability requirements are related to design life

Low permeability concrete generally offers excellent protection

Corrosive species usually penetrate from the outside into the interior, toward the rebar

Good and relatively uniform bond between rebar and concrete

Protective coatings on rebar can be applied under controlled, off-site conditions

Repaired Structures

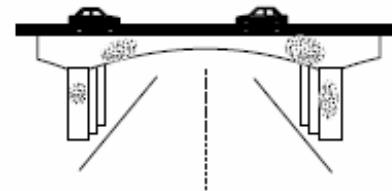

Service life involves mostly the propagation phase - corrosion is generally more severe

The internal environment affecting the rebar is very heterogeneous - corrosion macrocells can be set up

Durability requirements are related to minimizing further corrosion

Low permeability concrete in one area can lead to problems in another area

Transport effects from outside through the protective cover but also from old concrete to new concrete

Bond between rebar and concrete often weakened and variable

Existing rebar cannot be removed from site, hence surface preparation and coating application is more challenging

Repair techniques

- ❖ The removal of loose, spalled concrete, followed by further systematic removal of the concrete surrounding the corroded rebar
- ❖ The rebar and concrete surfaces are cleaned and primed before the new repair concrete is applied
- ❖ The repair procedures thus create three different material zones that interact with the reinforcing steel:
 - ❖ the old chloride-contaminated/carbonated concrete
 - ❖ the new concrete
 - ❖ the interface between the old and new concrete

Repair techniques

- ❖ The interface may represent a zone of weakness with respect to further ingress of corrosive species
- ❖ The existing concrete should be removed to a depth well below the corroded reinforcing bars. Failure to do this can easily produce a detrimental galvanic corrosion cell in the repaired area
- ❖ To avoid rebar corrosion damage in the existing concrete in this situation, more extensive removal of the old chloride-contaminated concrete is necessary

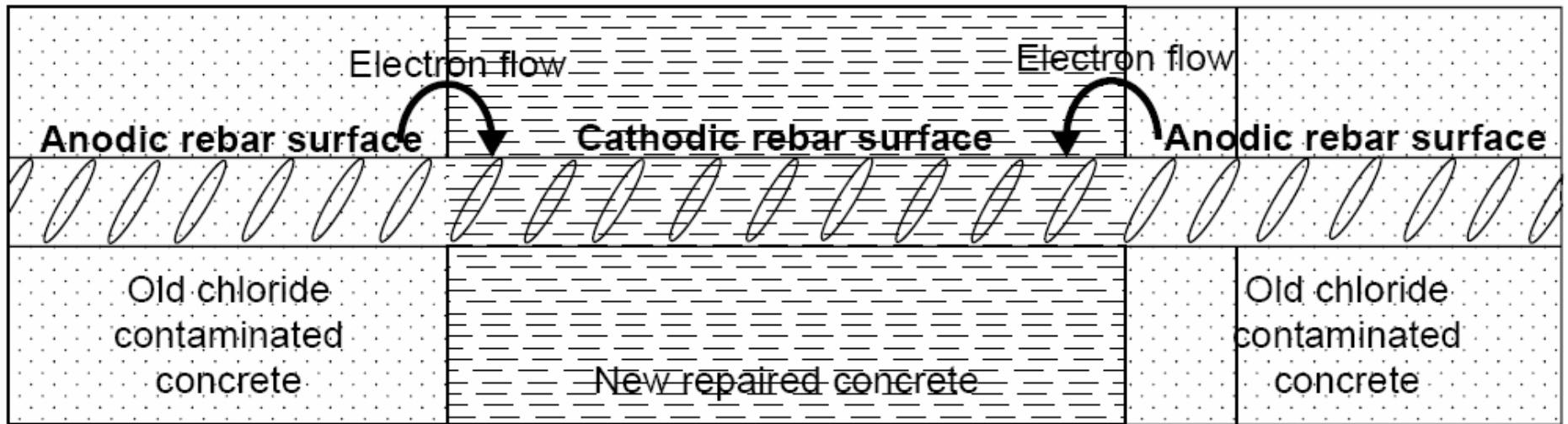
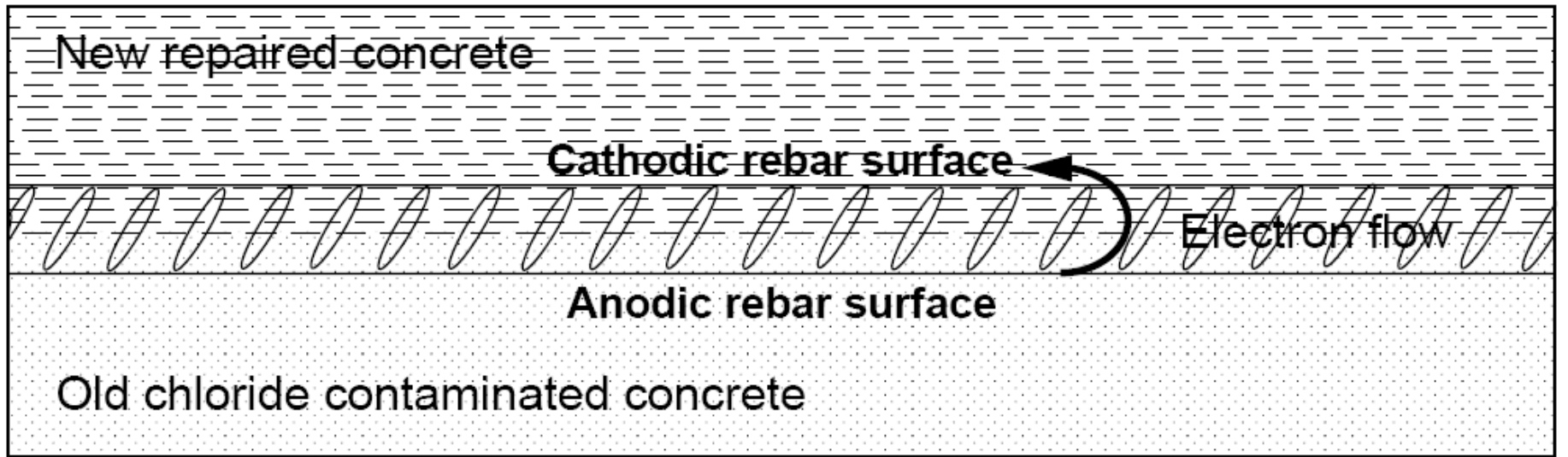

Galvanic corrosion cell in concrete repair

Epoxy-coated reinforcing steel

- ❏ Epoxy coatings provide an inert physical barrier that isolates the reinforcing steel from the corrosive environment
- ❏ The use of epoxy-coated rebar dates back more than two decades, and at present it represents the most commonly used alternative to standard reinforcing steel - ASTM A 775 and BS 7295
- ❏ Surface cleanliness and preparation, coating thickness, coating adhesion to the rebar, coating continuity, and coating thickness have to be considered for optimal corrosion resistance
- ❏ Barrier layer - the coating continuity is obviously very important - the risk of coating damage during transportation, off-loading, storage, installation on site, and concrete pouring and vibration is considerably greater.

Stainless steel rebar

- Industrial applications of stainless rebar date back more than two decades
- Several potential advantages could lead to growing interest in stainless rebars:
 - ✓ Corrosion resistance is integral to the material (this does not imply that the material is always immune to corrosive attack)
 - ✓ No coatings are involved that could chip, crack, or degrade
 - ✓ They have the capability to withstand shipping, handling, and bending
 - ✓ There are no “exposed” ends to cover or coat
 - ✓ Common rebar grades have good ductility, strength, and weldability
 - ✓ They can be magnetic or nonmagnetic, depending on grade

Stainless Steel Rebar Applications

Application	Date	Comments
Bridge deck in I-696 highway near Detroit, Michigan	1995	Type 304 rebars. Exposure to winter deicing salts.
Bridge deck in I-295 highway near Trenton, New Jersey	1985	Carbon steel rebars with type 304 cladding. Exposure to winter deicing salts. If ends of clad products are exposed, these represent a galvanic corrosion risk.
Bridge deck in 407 toll highway, near Toronto, Ontario	1996	Type 316LN rebars. Exposure to winter deicing salts.
Seafront structure restoration, Scarborough, U.K.	mid 1980s	Type 316 for replacement columns and precast beams.
Guild Hall Yard East project, London	1996	Type 304 selected for very long design life, in keeping with the famous historic buildings on the site.
Road slab of underpass, Cradlewell, U.K.	1995	Type 316.
Sydney Opera House forecourt restoration, Australia	~1990	Type 316 in a marine environment.

Galvanized rebars

- Corrosion protection of rebars by galvanizing are based on three principles
 - Zinc-coated rebar is thought to remain passive in concrete at somewhat lower pH levels than ordinary steel
 - The zinc coating represents a sacrificial anode that will tend to protect the steel cathodically. The galvanized coating is clearly consumed in the protection of rebar rather than being of the inert type, as epoxy coatings.
 - The usual corrosion product(s) of zinc occupy lower volume than the corrosion products of steel, implying lower expansive stresses

Corrosion inhibitors

- Corrosion-inhibiting admixtures are essentially designed to improve the performance of good-quality reinforced concrete
- One of the better-known corrosion-inhibitor admixtures used to control chloride-induced rebar corrosion is calcium nitrite, $\text{Ca}(\text{NO}_2)_2$
- The mechanism of inhibition involves nitrite ions competing with chloride ions to react with Fe^{2+} ions produced at the anode
- Essentially, the nitrite ions limit the formation of unstable iron chloride complexes and promote the formation of stable compounds that passivate the rebar surface

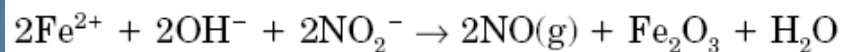

or

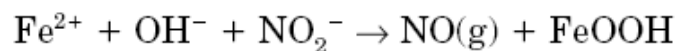

Concrete cover and mix design

- Increase the concrete cover – to decrease the diffusion of chloride and other corrosive species to the reinforcement steel
- A twofold increase in the concrete cover produces a fourfold life extension and a threefold increase in cover results in a ninefold benefit
- Higher water-to-cement ratios and lower cement content increases the porosity and allows the diffusion of chlorides
- Use of Portland cement – containing $3\text{CaOAl}_2\text{O}_3$ (C_3A) decreases the penetration of chlorides by diffusion
 - Water/cement ratio : 0.45
 - Cement content : 400 kg/m³
 - C_3A content in cement : 11% (by weight)

Concrete cover and mix design

- * Adequate curing (2 to 4 weeks' hydration) is required for the development of a dense internal texture with low porosity
- ** Addition supplementary cementitious materials
 - * *Pozzolans*, such as fly ash and silica fume, react with the cement hydration products, notably calcium hydroxide
 - ** *hydraulic materials*, such as granulated blast furnace slag, undergo direct hydration reactions
 - * these materials can improve the strength and durability of concrete

Concrete cover and mix design

- High-performance concrete (HPC) mixes with particularly low water-to-cement ratios, resulting in high compressive strengths, have been achieved with superplasticizer additives
- These additives obviously play a crucial role in ensuring satisfactory workability at the low water contents
- High density and low permeability typically characterize such mixes, which can be expected to represent an effective barrier to the ingress of corrosive species, provided the concrete is in the uncracked condition
- Certain additives also increase the electrical resistance of the cement paste, thereby retarding the kinetics of ionic corrosion reactions.

Corrosion protection of reinforcement steel: Available options and future prospects

Introduction

- ✚ Corrosion of metals costs the United States in excess of \$276 billion per year
- ✚ 40% of U.S. steel production goes to the replacement of corroded parts and products
- ✚ Corrosion is the single most important cause of damage to concrete structures
- ✚ NACE estimates the cost of corrosion damage to concrete structures (in the USA) is approximately \$ 125 Billion per year!!!

Corrosion of steel in concrete

- ✦ Concrete is a beneficial environment for steel because of its high alkalinity.
- ✦ This high alkalinity (high pH value), causes the steel to react and form a passive oxide film on its surface protecting it against corrosion.
- ✦ When the passive film is removed, the steel is subject to corrosion damage.
- ✦ Few conditions cause the passive film to be disrupted, the most common being the contamination of the concrete by chlorides.
- ✦ Chlorides penetrate the concrete through its pores and cracks and when they reach the level of the reinforcing bar in sufficient amounts, they remove the passive film from the steel.
- ✦ Another cause for the loss of passivity of the steel in concrete is carbonation.

Corrosion of steel in concrete

- ✚ Carbonation - Carbon dioxide present in the atmosphere reacts with pore moisture and forms carbonic acid.
- ✚ This mild acid solution reduces the alkalinity of the concrete surrounding the steel resulting in the loss of passivity.
- ✚ Once the passive film on the steel surface is compromised, moisture and oxygen then fuel the corrosion.
- ✚ As the steel corrodes, ferric hydroxide (rust) is produced, and its volume can be six to eight times greater than the original size of the reinforcing bar.
- ✚ The increase in volume causes stresses within the concrete of as much as 5000 lb/in.², causing cracks and spalling the concrete.

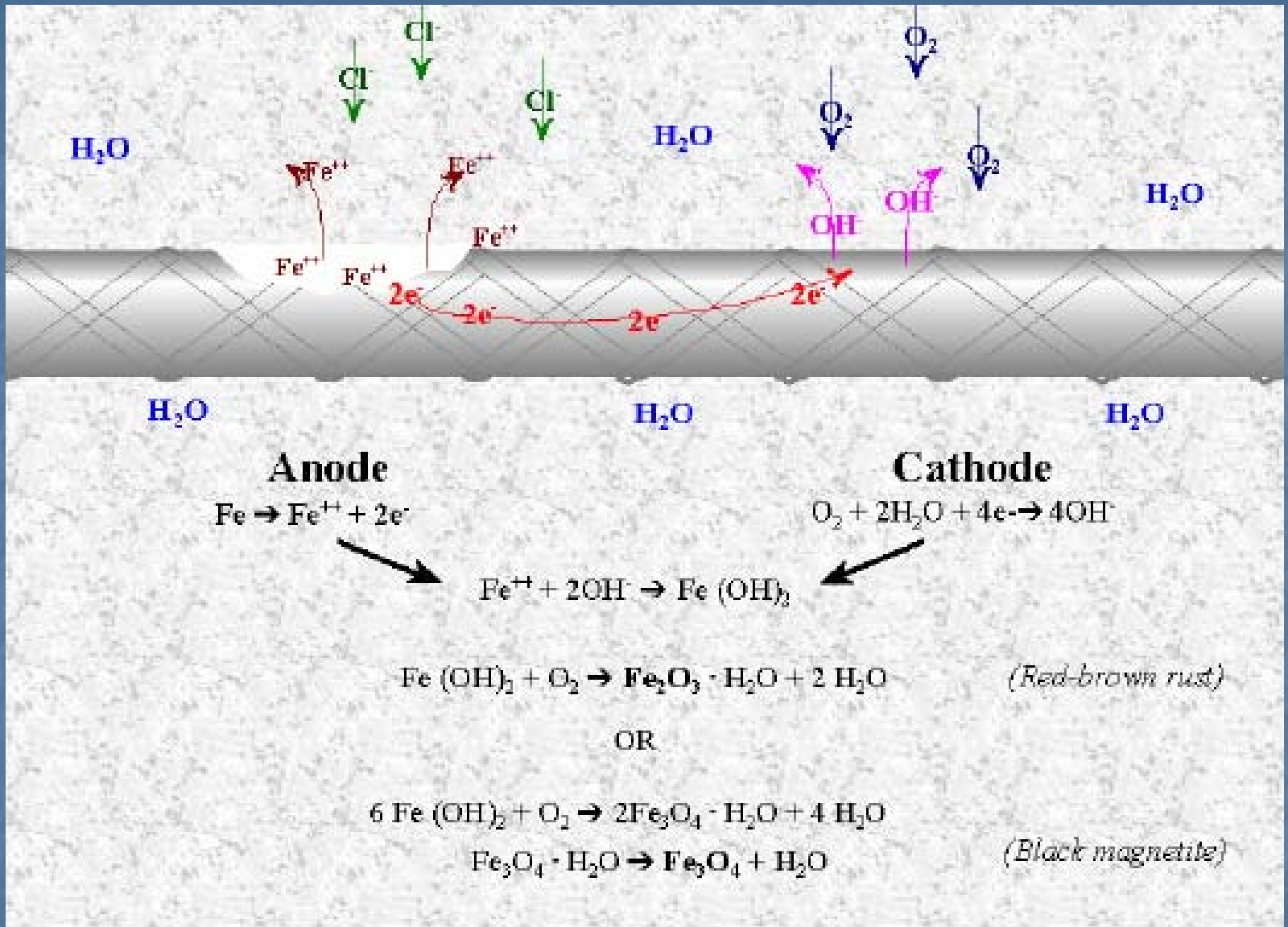

Steel Corrosion Reactions in Concrete

Corrosion protection of reinforcement steel

Available options

Addition of fly ash, BFS, Silica fume to concrete mix

Addition of corrosion inhibitors to concrete mix

Corrosion resistant coatings

Cathodic protection

Micro-alloyed steels
Stainless steels

Phosphate coating
Zinc phosphate
Primers

Galvanizing

Fusion bonded epoxy coating

Electroless Ni-P coating

Role of coatings

- ✚ Coatings - effective method for combating corrosion
- ✚ Coatings are either barrier layer or sacrificial
- ✚ Barrier layer coatings protect the metal by isolating it from the surrounding environment. It not only physically separates the metal from the environment, but also prevents current exchange between the metal and the surrounding electrolyte.
- ✚ Good barrier coatings have high dielectric strength properties and withstand exposure to ultraviolet radiation, moisture, and salt. When barrier coatings are damaged, the substrate metal is free to corrode.
- ✚ Sacrificial coatings also provide a barrier between the metal and its surrounding environment. In addition, they protect the metal where a damaged coating allows the metal to be exposed.
- ✚ Sacrificial coatings are generally metallic and are primarily produced from metals anodic to steel, such as zinc. At exposed sites, the zinc (sacrificial metal) corrodes preferentially, protecting the steel - A form of cathodic protection.

Hot Dip Galvanizing

- ✦ Immersion in molten zinc at 450°C
- ✦ Metallurgical reaction between the carbon steel and the molten zinc
- ✦ The resultant coating - Zn/Fe alloy adjacent to the steel with pure zinc layer on the top surface
- ✦ Passivation – 0.5 – 1 % sodium dichromate
- ✦ Thickness < 200 μm to avoid brittleness of the coating
- ✦ Provide barrier as well as cathodic protection
- ✦ Highly resistant to damage during transportation, storage, site handling

HDG steel in concrete environment

- ✚ Zinc is highly reactive at $\text{pH} < 6$ and $\text{pH} > 12.5$
- ✚ Freshly poured concrete $\text{pH} > 12.5 - 13$
- ✚ The outer layer of Zn reacts with the concrete mix – calcium hydroxy zincate
$$2\text{Zn} + \text{Ca}(\text{OH})_2 + 6\text{H}_2\text{O} \longrightarrow \text{Ca}[\text{Zn}(\text{OH})_3]_2 \cdot 2\text{H}_2\text{O} + 2\text{H}_2$$
- ✚ The hydrogen evolution reduces the bond strength between the HDG reinforcement steel and the concrete
- ✚ This problem occurs during the first 6-10 days

Effect of carbonation and chloride attack

- ✚ Carbonation – ingress of carbon dioxide from the atmosphere - formation of carbonic acid – reduces the pH - mild alkaline condition which is safe
- ✚ Reaction of zinc with carbonate leads to the formation of zinc carbonate - stable and protective
- ✚ Other products – ZnO and Zn(OH)₂
- ✚ The corrosion rate of HDG steel in carbonate environment is 0.5-0.8 μm/year
- ✚ A 80 μm HDG coating – 100 years
- ✚ If carbonation is the only reaction, then HDG steel will give better performance
- ✚ Penetration of chloride ions depassivate steel and promote active metal dissolution
- ✚ A combination of loss of alkalinity due to carbonation and the ingress of chloride ions affect the long term durability of HDG reinforcement steel

Epoxy coating for reinforcement steel

- ✚ Organic compound - bisphenol-amine epoxy
- ✚ Condensation of bisphenol A and epichlorohydrin
- ✚ Can be cured at ambient or elevated temperature with an amino resin
- ✚ The epoxy is a thermo-setting plastic that is resistant to solvents, chemicals and water
- ✚ Identified as a potential corrosion resistive coating for reinforcing steel
- ✚ The bisphenol amine epoxy has mechanical properties, such as high ductility, low shrinkage during curing, and heat resistance, which make it desirable for use as a reinforcing steel coating
- ✚ Applied by two methods – two part liquid or powder

Surface Preparation for epoxy coating

- ✚ Reinforcing steel surfaces to be coated should receive a thorough blast cleaning to near-white metal in accordance with SSPC SP10.
- ✚ Mill scale, rust and foreign matter shall be completely removed. The blasting media containing sufficient grit shall produce a suitable anchor pattern profile. A profile depth of 2.0 to 4.0 mils (50 μm to 100 μm) is considered to be suitable to provide an anchor pattern.
- ✚ Coating should be applied to the cleaned surface soon thereafter. In no case the application of the coating should be delayed more than $\frac{1}{2}$ hr. after cleaning

Liquid epoxy (Two Pack System)

- ✦ Liquid epoxy is commonly prepared by mixing stoichiometrically balanced proportions of a two-part system, epoxy resin and polyamine.
- ✦ The liquid epoxy is applied by brushing or spraying, or by immersing the bars to be coated.
- ✦ Brushing - most appropriate
- ✦ The liquid coatings commonly contain solvents that, upon evaporation, may result in pore formation within the cured coating.
- ✦ Shrinkage due to solvent loss and curing is also a concern with the use of liquid epoxy coatings

Fusion bonded epoxy coating system

- ✦ The material, in the form of a powder (10-100 μm) bearing an electrostatic charge, is applied to the hot, freshly blasted reinforcing steel surface
- ✦ Application temperature: 204°C to 230°C
- ✦ The electrically charged powder particles are attracted to the preheated steel, and melt to form a continuous film, then the system is quenched to form a solid coating

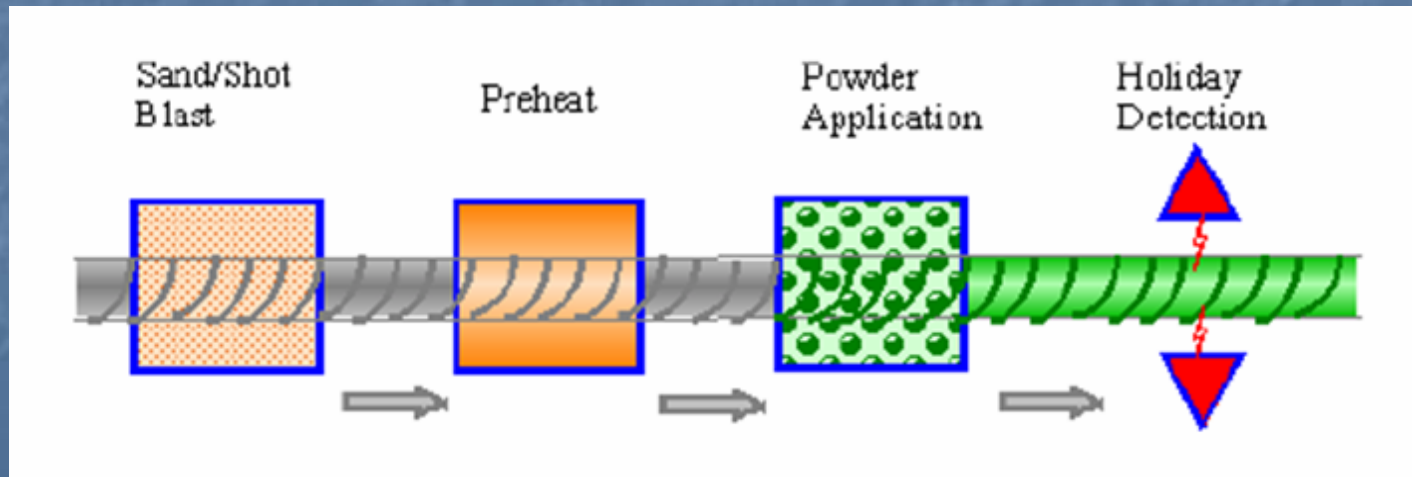

Characteristics of epoxy coatings

✚ Thickness

- ✚ ASTM A 775-89a – 127 to 305 μm (5-12 mils)

✚ Moisture uptake

- ✚ Not impermeable to moisture

✚ Adhesion

- ✚ Imperfect – heterogeneity of the coating
– weak bonded areas
- ✚ In moist environment, diffusion of moisture
– lead to wet adhesion failure – blister

Holiday detection

- ✚ Holiday detector using 67.5 V
- ✚ Handheld (wet sponge type with direct current) detector checks should be performed each production day
- ✚ No visible holes, voids, cracks, defects are permitted
- ✚ Not more than 2 holidays per 0.3 m of the coated steel bar is allowed

Bend test

- ✦ The bend test should be performed to evaluate the flexibility of the epoxy coating.
- ✦ Epoxy coated steel bars should be tested at a uniform rate, a minimum of one bar of each size every four production hours around a mandrel of a specified size within a maximum specified time period as per ASTM A775/AA775M
- ✦ No cracking or disbonding of the coating should be visible on the outside radius of the bent bar.
- ✦ Evidence of cracking or disbonding of the coating shall be considered a cause for rejection.
- ✦ The test bars shall be between 68°F and 86°F (20°C and 30°C) when tested.

Epoxy Zinc primer

Single pack epoxy shop primer with a high zinc content for protection of steel structures against corrosion during construction.

TECHNICAL PROPERTIES

Colour	Grey		
Finish	Matt		
Curing Agent	n/a		
Mix Ratio	n/a		
Specific Gravity	2.25		
Volume Solids	38%		
Recommended Film Thickness	60-90 μ m WFT / 23-34 μ m DFT		
Theoretical Spreading Rate	11-16 m ² /litre		
Application Method	Brush, Roller, Spray		
Flash Point	<12°C		
VOC	560 g/litre		
Drying Times	10°C	20°C	30°C
Touch Dry	6 minutes	3 minutes	2 minutes
Hard Dry	8 hours	4 hours	3 hours

Fast dry high build zinc phosphate primer

Description	A fast drying, high build, anti-corrosive ferrous metal primer that is non-toxic in the dry film and affords excellent protection to correctly prepared surfaces.
Recommended Use	Suitable for airless spray applications to blast cleaned structural steel etc. Provides a hard drying corrosion inhibiting base, suitable for overcoating with a wide range of single pack products.
Compliance	Complies with "the VOC in Paints, Varnishes & Vehicle Refinishing Products Regulations 2005". EU limit value for this product (cat A/i): 600g / litre (2007), (cat A/i): 500g / litre (2010)
Recommended Application Methods	Airless Spray - Tip size 0.43-0.54mm Pressure 110-150kg/sq cm Brush (small areas only)
Colour Range	Aircraft Grey, Red Oxide & Medium Buff
Physical Properties	<u>VOC Content</u> (as supplied) : max 520g / litre <u>Volume Solids</u> : 45% <u>Mass Solids</u> : 59%-62% (dependant on colour) <u>Flash Point</u> : 25°C
Drying Time @ 20°C	Surface dry - 20 mins. Hard dry - 1 hour. Do not apply when ambient temperature falls below 5°C or relative humidity exceeds 90%.
Dry Film Thickness	50 - 100 µ
Wet Film Thickness	110 - 220 µ
Theoretical Coverage Rate	6m ² per litre @ 75µ DFT <i>coverage rate can be affected by such variables as type and condition of substrate, type of application equipment and individual method of application.</i>

High durability zinc phosphate primer

An alkyd based versatile zinc phosphate anticorrosive primer, which gives a high level of protection and adhesion to steelwork. Contains no lead additives and is of low toxicity.

TECHNICAL PROPERTIES

Colour	White, Light Grey, Mid Grey, Red Oxide		
Finish	Matt		
Curing Agent	n/a		
Mix Ratio	n/a		
Specific Gravity	1.30		
Volume Solids	45%		
Recommended Film Thickness	75 - 150µm WFT / 34 - 68µm DFT		
Theoretical Spreading Rate	6 - 13 m ² /litre		
Application Method	Brush, Roller, Spray		
Flash Point	39°C		
VOC	429 g/litre		
Drying Times	10°C	20°C	30°C
Touch Dry	1 ½ hours	30 minutes	20 minutes
Hard Dry	7 hours	4 hours	3 hours

Electroless nickel coatings

- ❖ Electroless nickel coatings
 - ❖ Offers excellent corrosion resistance in many industrial environments
 - ❖ not susceptible to stress corrosion cracking
 - ❖ widely used either as protective or decorative coatings in many industries, such as petroleum, chemical, plastic, optics, printing, mining, aerospace, nuclear, automotive, electronics, computer, textile, paper, and food
 - ❖ Offers corrosion protection to steel reinforcement bar
- ❖ Electroless nickel does not perform as a sacrificial coating like electrodeposited Zn or Cd on steel.
- ❖ It behaves as a true barrier coating, protecting the substrate by sealing it off from the corrosive environments. Hence, the thickness of the deposit and the absence of porosity are of great importance.

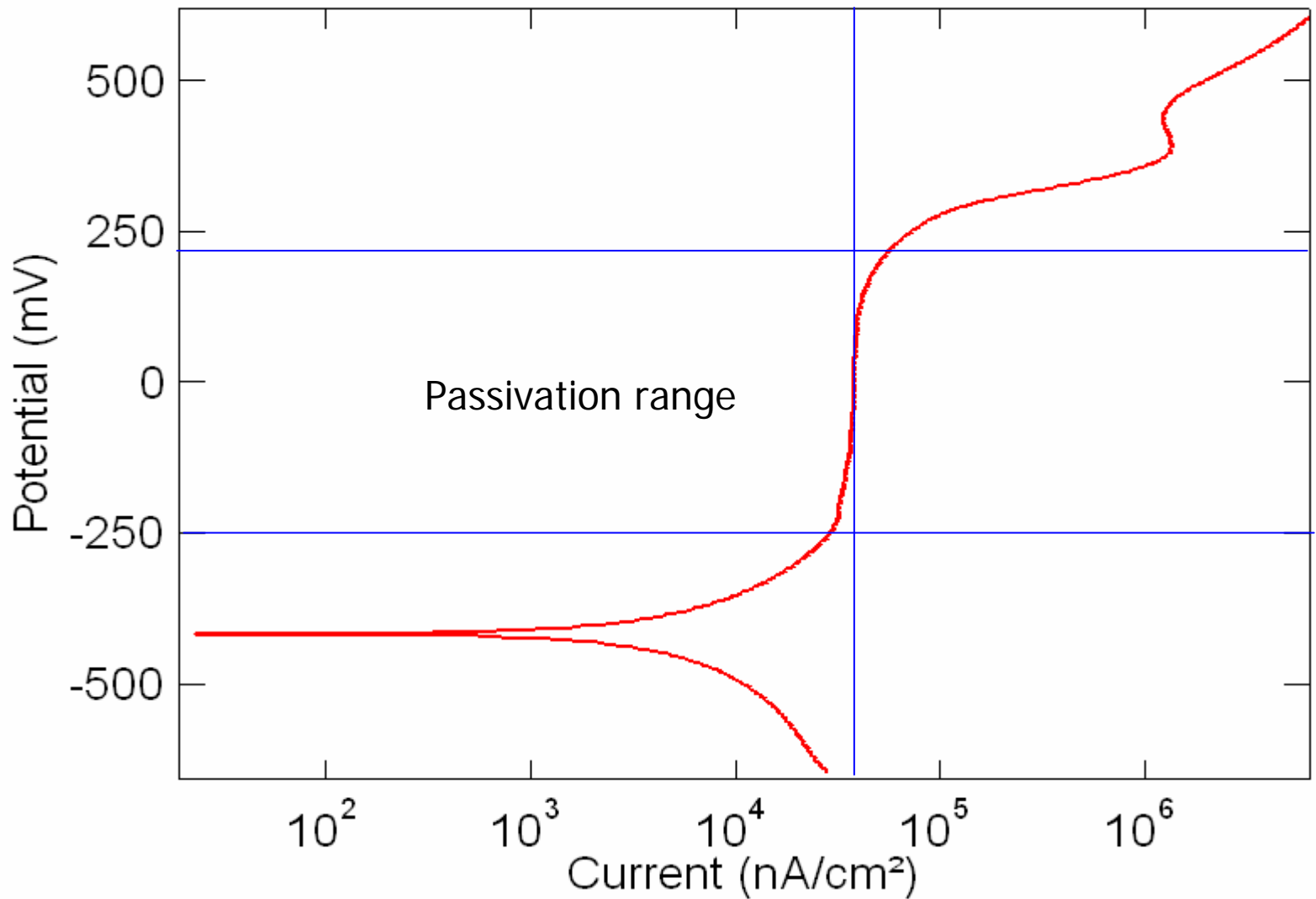

Corrosion behaviour of EL Ni-P coating in 1N NaOH

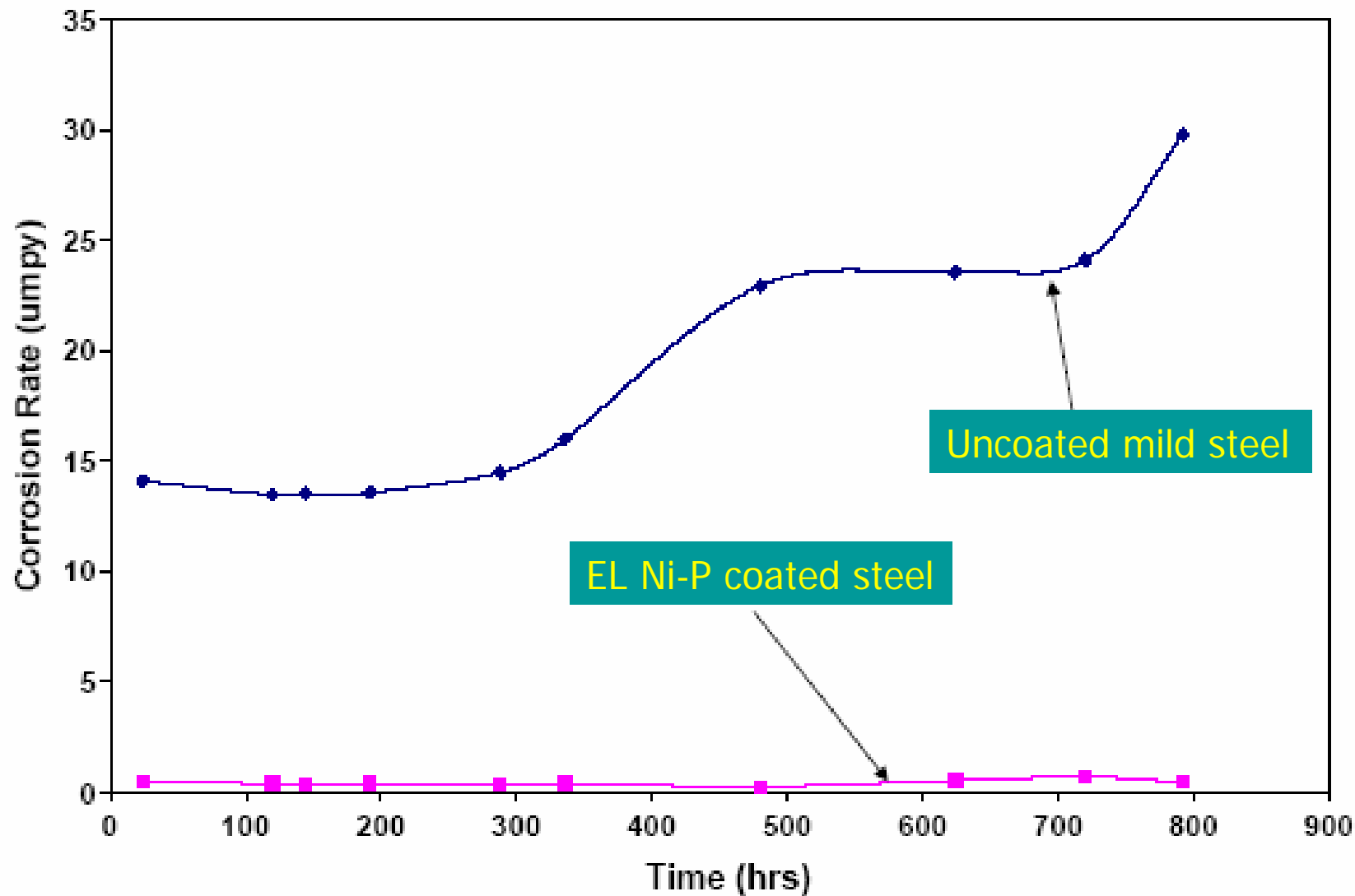

Corrosion rate of uncoated mild steel and EL Ni-P coated steel exposed in simulated pore solution +1 M Cl⁻

Concluding remarks

- ✦ Coatings - effective method for combating corrosion of reinforcement steel
- ✦ HDG coating provides barrier as well as cathodic protection.
- ✦ HDG coatings are highly resistant to damage during transportation, storage, site handling
- ✦ Epoxy coating is an effective physical barrier coating, highly resistant to chemicals and it is identified as a potential corrosion resistive coating for reinforcing steel.
- ✦ Epoxy coating is not totally impermeable to moisture and diffusion of moisture leads to wet adhesion failure
- ✦ Cracking or disbonding of the coating – during transportation, site handling and during construction – spreading of corrosion underneath the coating leading to peeling of the epoxy coating

Concluding remarks

- ✚ Phosphate coating is only a pretreatment and need to be finished with oil or paint. The use of phosphate coating as a temporary corrosion protective measure has only limited potential
- ✚ Zinc phosphate primers can be used as a temporary corrosion protective measure. They are effective in preventing corrosion during storage at the factory and at the site. Some damage might occur during transit. The corrosion will be localized only at the damaged site and will not spread underneath the coating.
- ✚ Electroless Ni-P coating is an effective barrier layer coating. It readily passivate in alkaline medium and the passive film will be intact for a longer periods of time. It is not cost-effective.

Thank you

