

# Co-channel Interference Monitoring based on Cognitive Radio Node Station

**Arief Marwanto**

Dept. of Electrical Engineering – Post  
Graduated Study,  
Faculty of Industrial Engineering  
Univ. Islam Sultan Agung  
(UNISSULA)  
Semarang – Indonesia  
arief@unissula.ac.id

**M Ulin Nuha**

Electrical Engineering Student, Faculty  
of Industrial Engineering  
Univ. Islam Sultan Agung  
(UNISSULA)  
Semarang – Indonesia  
ulin.cenx9395@gmail.com

**Jenny P Hapsary**

Dept of Electrical Engineering  
Faculty of Industrial Engineering  
Univ. Islam Sultan Agung  
(UNISSULA)  
Semarang – Indonesia  
jenny@unissula.ac.id

**Daniel Triswahyudi**

PT Polytron Electronic Indonesia Staff  
Kudus Indonesia

**Abstract**—Most of installation on wireless LAN on the building is not considering location and geographic space are which probable co-channel interference among near-far wi-fi stations. The use of the same channel which causes of receiver stations experiences of error transmission and delay among data transmission. To analyze this drawbacks, cognitive radio (CR) is adopted which able to monitoring co-channel interference on wi-fi stations. Node MCU Arduino is used to proposed cognitive radio terminal which able to analyzed and monitoring co-channel interference among wi-fi stations known as *co-channel monitoring cognitive radio (CCMCR)*. One of the CR task is ability to sensing the whole spectrum channel that operated in certainty frequency. Node MCU is sensed the energy power of the wi-fi stations and converted by analog-to-digital converter which detected power level of the received signal strength indicator (RSSI). The proposed model is examined by indoor experiments which obtained 63.8% co-channel average and adjacent-channel is 36.1%. Thus the proposed CCMCR node station is able to monitor co-channel interference and adjacent-channel as well. Therefore, the results could be used as the basic analysis for the development and installation of wi-fi stations in the building.

**Keywords:** *cognitive radio, spectrum sensing, software defined radio, co-channel interference*

## I. INTRODUCTION

Increasingly widespread use of wi-fi users that utilize the 2.4 GHz frequency, such as in offices, computer labs, and high rise buildings, resulting in negative impacts due to unlicensed band frequency of 2.4 GHz, resulting in co-channel interference between users [1]. Co-channel is a fellow radio wave signal operating on the same channel frequency, consequently the client device will encounter an error when translating the same information code [2].

Co-channel occurs when using a channel that does not have enough distance between channels. Co-channel can decrease access point performance in transmitting and receiving signals, access point will lose power and can lose database, consequently error on bits of information being sent, so that the recipient client finds error, or delay in sending data[3]. When the co-channel happens it will decrease the quality of service on the wireless LAN. Steps prevent co-channel on wireless LAN, using technological breakthroughs such as Cognitive Radio (CR) to improve the quality of service.

In [4] cognitive Radio is an intelligent wireless communication system capable of being aware of the conditions of the surrounding environment and using the "understanding-by-building" methodology to learn from the environment and adapting its internal status to statistical variations in the coming radio frequency (RF) stimulant by making changes to certain operating parameters such as transmission power, carrier frequency, or modulation strategy. While in [5] wireless network and wireless network optimization by minimizing roaming is analyzed. Examination is done by measuring bandwidth, measuring the speed and stability of data transfer during roaming. Moreover, speed and stability of transfer with wireless network system are measures. However, performance testing of each access point which is determined the quality of overall signal and co-channel is not considered. While in [6] has introduced access point interference among wi-fi networks. Interference measurement has proposed by experiencing on topology networks which setup onto bandwidth, signal and noise measurements. Unfortunately, individual measurements that officially done are not consider link budget analysis, co-channel interference, RSSI and energy signal measurements.

Research conducted by [7] explains the Bluetooth technique operates in the 2.4 GHz frequency band which is the same as IEEE 802.11b or Wi-Fi. During Wi-Fi and Bluetooth technologies are used simultaneously at the same time, the chances of interference are enormous because they operate in the same frequency band of 2.4 GHz. The method used is the measurement to determine the effect of Bluetooth interference on IEEE 802.11b WLAN performance system (Wi-Fi). The parameters used are transmission time and throughput. Based on these parameters, it is found that interference effect can affect the feasibility of a Wi-Fi network service. However, monitoring and co-channel interference are not involving in this experiments. In order to investigate the performance of the hotspot, [8] has investigate adjacent signal interference (Co-Channel Interference) which degrade the received signal quality. Interference measurement has been done through six experiments through an implementation on an infrastructure topology, interference measurements can be seen from Quality of service with three parameters such as bandwidth measurement, signal measurement, and noise measurement. Moreover, in [7] has investigate measurement analysis inside

the building has done which determined the effect Bluetooth interference with some of the IEEE 802.11b Wi-Fi parameters that expressed by throughput based on data rate changes. Based on the throughput, the value of delay and jitter are obtained. The results show that the presence of Bluetooth is very influential on Wi-fi which expressed by throughput. Whereas, the effect of throughput is the value of throughput decreases as the increase in distance among the transmitter and receiver. The constraints faced by internet service provider (ISP) in Yogyakarta was interference has been reported by [9]. Most of ISP uses uncertified wireless devices therefore, the equipment is not fully utilized on 2.4 GHz frequency. They proposed transmit power supervision which lead to monitoring the used of frequency 2.4 GHz that to operate the wireless internet network. However, depth interview methods have been used and measurements are not considering in this investigate. Moreover, [10] has proposed bandwidth analysis which perform wi-fi signal quality. The good performance has shown by bandwidth levels is not significantly differ from that leased. However, only bandwidth that measured in this work. Cognitive radio (CR) for dedicated spectrum has been investigated by [11] which discuss about how the ability of spectrum sensing using matched filter method on cognitive radio to detect the presence of user primary on FM Radio channel using three Power Spectral Density (PSD) i.e. PSD Periodogram, Welch and Thomson Multi-taper with MATLAB. However, simulation methods are used which perform spectrum sensing detection on FM radio channels

## II. CO-CHANNEL DETECTION AND SOFTWARE RADIO MODEL FOR SPECTRUM SENSING MECHANISM

One of the cognitive radio components are sensing capability to the surrounding environment. For the cognitive radio primary transmission, two capabilities of sensing and transmit are needed, therefore NodeMCU ESP8266 which acts itself as a sensor node which can be used as access point (AP) or as a station (STA) which is configured as CR primary transmission known as co-channel monitoring cognitive radio (CCMCR). One NodeMCU ESP8266 is used as a AP and a STA for this CCMCR model. As shown in Fig. 1, NodeMCU ESP8266 is connected to the PC as CR station (CCMCR). It is observed and monitoring by sending primary transmission of power and receiving any information of the power levels (RSSI level) from the surrounding environment. In the surrounding of CCMCR node, some wi-fi stations installed which continuously transmit their power levels to the surrounding nodes. The CCMCR node will received channel information based on the received power level from the surrounding wi-fi stations.

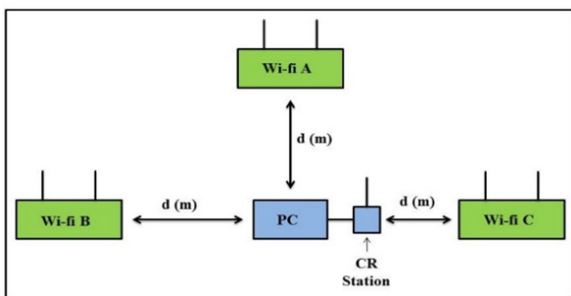

Fig. 1 Co-Channel Detection Model using CCMCR

Assumed that CCMCR is a single user primary wireless networks which observable co-channel activities on wi-fi stations. The power level of the wi-fi stations transmission is denoted by  $P_T$  [12].

$$P_T(\text{dB}) = 10 \log_{10} P_{\text{Signal}} \quad (1)$$

$P_i$  signal is the maximum allowable signal power of wi-fi in decibel (dB) for this frequency spectrum as primary user power level [13]. It is involving measurements at various distances indicates that pathloss values are random and distributed log-normal. In a single CCMCR path of the Tx - Rx, the received  $P_r$  suffered from the noise and path loss[14]. For the link budget measurement, the distance of wi-fi stations to the CCMCR station is considering path loss factor which can be obtained by [15]

$$L_{\text{CCMCR}} = 20 \log_{10} \left\{ \frac{\lambda}{4\pi d_0} \right\} - 10n \log_{10} \left\{ \frac{d_0}{d_{\text{wi-fi}}} \right\} \quad (2)$$

The received signal strength indicator (RSSI) received from wi-fi stations based on free-space path loss. The distance by Friis transmission equation for free space propagation can be found as [16]

$$d_{\text{CCMCR}} = \sqrt{\frac{P_t G_t G_r \lambda^2}{(4\pi)^2 P_r}} \quad (3)$$

Based on [17] and [12] the detection power received at CCMCR is

$$\begin{aligned} P_{R(\text{CCMCR})}(i) &= P_{T-\text{CCMCR}}(\text{dBm}) \\ &- 20 \log_{10} \left\{ \frac{(4\pi^2 * ((d_0(i) - d_{\text{wi-fi}}(i)) * 2))}{\lambda_{\text{CCMCR}}} \right\} \\ &+ \sum_{i=1}^I \left( P_{T(\text{wi-fi})}(i) \right. \\ &\left. - 20 \log_{10} \left\{ \frac{(4\pi^2 * ((d_0(i) - d_{\text{wi-fi}}(i)) * 2))}{\lambda(i)} \right\} \right) + N_i(0, \sigma)(i) \end{aligned} \quad (4)$$

Where  $P_{R(\text{CCMCR})}(i)$  is the received power;  $\lambda_{\text{CCMCR}}$  is the wavelength of CCMCR node;  $\lambda(i)$  is the wi-fi wavelength,  $P_{T-\text{CCMCR}}(\text{dBm})$  is the power transmit of the CCMCR as the primary transmission;  $d_{\text{wi-fi}}(i)$  is the radius distance between wi-fi stations and CCMCR node;  $P_{T(\text{wi-fi})}(i) \text{ dBm}$  is the power transmit of wi-fi stations;  $N(\epsilon)(i)$  is the additive white noise with noise and variance. Therefore, the detection co-channel interference among wi-fi stations at the CCMCR node given as [4]

$$\begin{aligned} P_{T(\text{co-channel Interference})}(\text{dB})(i) &= P_{T(\text{wi-fi})}(\text{dB})(i) \\ &- P_{R(\text{CCMCR})}(\text{dB})(i) \end{aligned} \quad (5)$$

In the next stage, NodeMCU digitized the received power level based on the magnitude square (FFT) and the software passed received signal strength as digitation format, as shown in Fig. 2. A piece of packets or stream data is translated from the received signal levels using ADC block module. ADC then sampled and quantized the magnitude square signal and pass it into baseband processing which are written using C#. For further processing, magnitude square

signal then digitized into FFT bins. As shown in Figure 2 which describes the software component architecture of the Node MCU- ESP8266. The Board Manager and the Arduino IDE are used to compile an Arduino C/C++ source file down to the target MCU's machine language as down-conversion processing such as modulation, signal processing and digitizing of the packets.

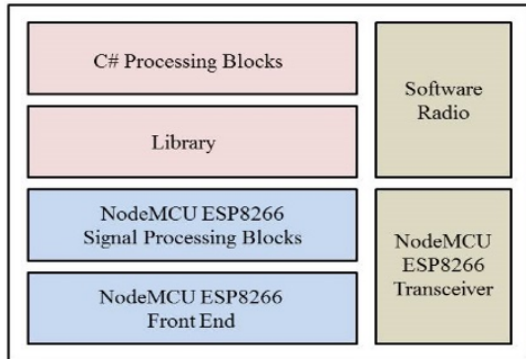

Fig. 2. Proposed of software defined radio co-channel detection monitoring cognitive radio (CCMCR) for Cognitive Radio Component

Furthermore, in Fig. 3 shown that received signal level that creates an energy change is received through radio software. The received data adjusts the software that passes the square of the magnitude of the signal strength received from the wi-fi antenna and translates into the current data packet as digitized.

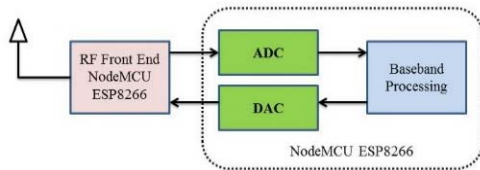

Fig. 3. Software Radio (SR) model for CCMCR node

Fig. 3 describes front end software radio architecture and develop using C# (dot Net frameworks) which consist of signal processing blocks library and communicator library in Arduino NodeMCU esp8266. Moreover, the CCMCR node consist of two main boards, the first ESP8266 and Arduino board which the specification as follows: The maximum sampling rate of NodeMCU is 2,5 kHz; Voltage: 3.3V; Wi-Fi Direct (P2P), soft-AP; Current consumption: 10uA~170mA; the clock speed: 80~160MHz; +19.5dBm output power in 802.11b mode; 802.11 support: b/g/n;

### III. POWER MEASUREMENT MODEL ON COGNITIVE RADIO STATION

Fig. 4 shows that measurement of power level at CR node station. Radiated power of the electromagnetic spectrum has been detected by antenna. Moreover, the radiated power passes through ADC for sampling level of the signals which perform magnitude square of the signals. The magnitude square form of fast fourier transform (FFT) is conversion onto information as follows: SSID, RSSI value (dB) and channel number.

The magnitude square form of fast fourier transform (FFT) is conversion onto information as follows: service set identifier (SSID), Received signal strength indicator (RSSI) value (dB) and channel number. The display is presented as numerical, potential co-channel interference and chart of the signals information.

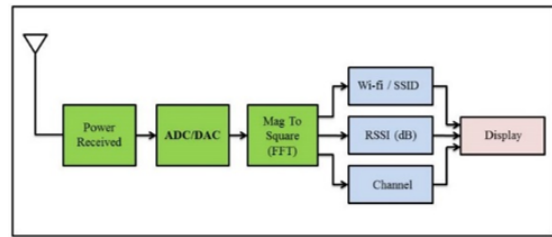

Fig. 4. Blok Diagram Power Received Measurement

### IV. SOFTWARE DEFINED RADIO FOR CCMCR SYSTEM MODEL

The proposed model is developed based on the C# software which working through back-office systems. It proceeds the computation process such as modulation, demodulation, signal processing, analog to digital conversion, digital to analog conversion, etc. It is combined with Arduino IDE C/C++ which located on front-office which represented the algorithm of the proposed model. Fig. 5 describe the proposed design of the software radio for CCMCR monitoring node station.

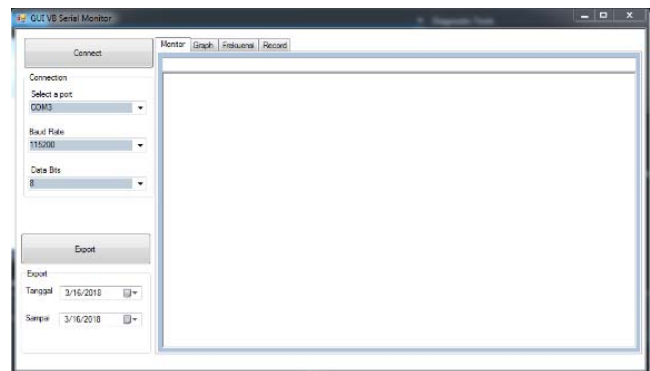

Fig. 5. Proposed GUI of software radio design for CCMCR node station.

The GUI interface consists of three groups of boxes, such as group box connection, group box export, and group box of visual.

### V. EXPERIMENTAL SETUP

Indoor testing is configured by considering attenuation of the materials and shadowing effects of the signals. Indoor testing is done with the aim of obtaining more complex signal characteristics and to know the effect of unauthorized placement of wi-fi by the administrator. Therefore, the characteristic study of received signal power level can be analyzed more deeply. Testing in the building will also be known type of wi-fi and channel is the most widely used. for further research, if the wi-fi node whose channel is accessed by many users is known by CR node, dynamic spectrum access can be applied in the future wi-fi system.

The cause of signal attenuation or pathloss is the amount of power lost in a certain distance is an important component in obtaining information about the power level received by the CCMCR station. Furthermore, the presence of shadowing is characterized by the average variation of pathloss between the transmitter and the receiver at a location which remains well known to the monitoring station.

The large number of frequencies that will lead to co-channel is an important ingredient that the monitoring system should be aware of. This test will prove how the co-channel occurs and find a solution to the bad power levels received due to co-channel, here are the outlined of floor plans and indoor test locations is shown in Figure 6.

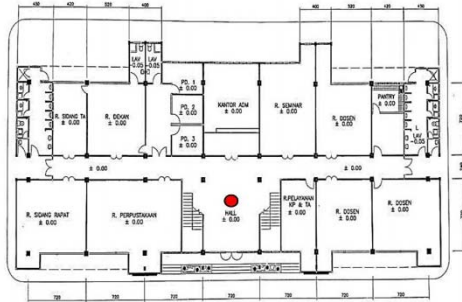

Fig. 6. 1st Floor Indoor Testing Planning

The test was conducted in the 1st floor FTI building which has an area of 4000m<sup>2</sup>. The large number of indoor access points triggers the use of frequencies on the wireless that allow co-channel to occur. To know the performance quality of wireless LAN service based on the bad power level due to the influence of co-channel. The received signal strength score indicator (RSSI) received from the transmitter emitted by wi-fi stations, so that there are some detected wi-fi based on the distance.

VI. RESULTS AND ANALYSIS

The following figures shows the results indoor testing of CCMCR monitoring.

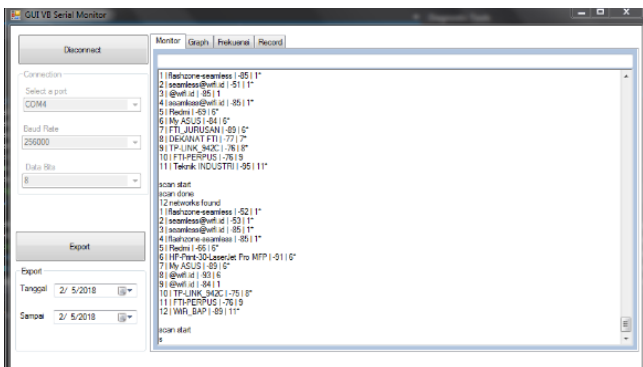

Fig. 7. GUI Monitor Indoor Testing

Fig. 7 is the result detection at FTI 1st floor building indicating the existence of co-channel in wireless LAN network, because there is no distance of channel frequency usage, as described in following table:

TABLE I. CO-CHANNEL OBSERVATION RESULTS BETWEEN THE ACCESS POINT IN THE BUILDING

No	SSID	Channel	RSSI (dBm)
1.	Flashzone-seamless	1	-85
2.	seamless@wifi.id	1	-85
3.	@wifi.id	1	-85
4.	flashzone-seamless	1	-52
5.	seamless@wifi.id	1	-53
6.	HP-Print-30-LaserJet Pro MFP	6	-91
7.	@wifi.id	6	-93

Another detection that CCMCR stations can utilize in the use of wireless LAN frequencies in addition to co-channel is the adjacent channel, which encounters signal coverage between the access points where the power from the nearest transmitter interferes with the work of the receiver when it receives the signal from the remote transmitter as a result reduce the quality of performance on the access point, the following in Table 2:

TABLE II. ADJACENT-CHANNEL OBSERVATION RESULTS BETWEEN ACCESS POINTS IN THE BUILDING

No	SSID	Ch	RSSI (dBm)
1.	HP-Print-30-LaserJet Pro MFP	6	-91
2.	@wifi.id	6	-93
3.	TP-LINK_942C	8	-75
4.	FTI-PERPUS	9	-76
5.	Wifi_BAP	11	-89

In Fig. 7, it is detected that channel 1 has shown the overlap of signal coverage because there is no spacing in the channel usage. The use of a channel combined with an RSSI value indicates that the higher the histogram indicates the received power level the better and vice versa, are outlined in Table III below:

TABLE III. STATUS INDICATOR OF OVERLAPPING CHANNELS

No	Channel	Status	RSSI (dBm)
		3 signals indicates overlapped	
1.	1	Flashzone-seamless	-85
		seamless@wifi.id	-85
		@wifi.id	-85

In Fig. 8 is the result of detection of channel frequencies used by some access points. The color indication of detected SSID indicates the use of channel on access point detected by CCMCR station and frequency value indicator, which is described in the following table:

TABLE IV. FREQUENCY AND CHANNEL OBSERVATION RESULTS ON INDOOR TESTING

Ch	SSID	RSSI (dBm)	Co-channel	RSSI (dBm)
1	flashzone-seamless	-75	flashzone-seamless	-75
	seamless@wifi.id	-74	@wifi.id	-75
	@wifi.id	-75	seamless@wifi.id	-74
	flashzone-seamless	-52	flashzone-seamless	-52
	seamless@wifi.id	-53	seamless@wifi.id	-53
6	HP-Pront-30-LaserJet Pro MFP	-90	HP-Pront-30-LaserJet Pro MFP	-90
	seamless@wifi.id	-90	seamless@wifi.id	-90

TABLE V. RECORDING AND STORAGE RESULTS ON INDOOR TESTING

No	SSID	Channels	Frequency (GHz)
1.	flashzone-seamless	1	2.412
2.	seamless@wifi.id	1	2.412
3.	seamless@wifi.id	1	2.412
4.	flashzone-seamless	1	2.412
5.	HP-Print-30-LaserJet Pro MFP	6	2.437
6.	@wifi.id	6	2.437
7.	@wifi.id	1	2.412
8.	TP-LINK_942C	8	2.447
9.	FTI-PERPUS	9	2.452
10.	Wifi_BAP	11	2.462

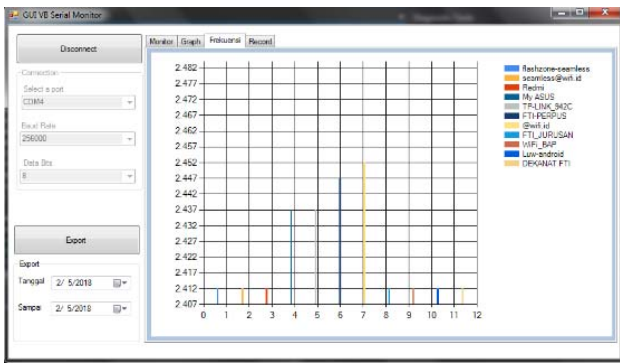

Fig. 8. Frequency and channel observation results on Indoor Testing

To avoid the occurrence of co-channel then the use of frequencies on the access point is a good on channels number of 1, 6, and 11.

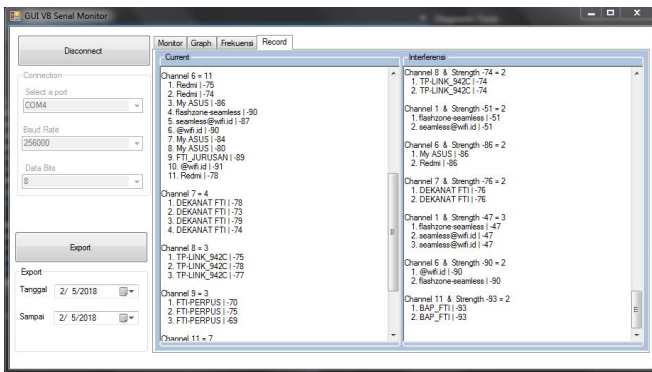

Fig. 9. Recording and storage results on Indoor Testing

In Fig. 9 there is a collection of interrelated organized letters and numbers that can be stored, manipulated and selected based on the same channel and RSSI values, it is intended to know the co-channel information process that occurs in wi-fi stations, the following is described in Table 5:

### VII. CONCLUSION

1. Prototype for co-channel monitoring has been successfully developed using NodeMCU ESP8266 and C# software.
2. This prototype is able to fulfill one of the functions of cognitive radio that is detecting the power level around it
3. Prototype development and software radio support could well detected co-channel and adjacent channel on intended wi-fi stations
4. Developed software radio can also monitor the magnitude of power levels, frequencies, interferer channels and overlap channels in monitoring area.
5. Dynamic spectrum access is recommended to optimize the performance of the access point so that the co-channel and adjacent channel do not interfere with the performance of the access point. Further research could be conducted in order to optimizing the access point performance during heavy burden traffic and occurring heavy co-channel interferer using cognitive radio systems.
6. It's good before placing the access point, power level measurement and determination of the distance is determined first, so the performance of access point can be optimal. These tools and software can be used to determine optimal access point installation.

### ACKNOWLEDGMENT

This research has been supported by Post Graduated Study, Department of Electrical Engineering, Faculty of Industrial Engineering University Islam Sultan Agung (UNISSULA) Semarang Indonesia.

### VIII. REFERENCES

- [1] S. Pedititaki, "Interference-aware adaptive spectrum management for wireless networks using unlicensed frequency bands," 2012.
- [2] H. Chen, *Next Generation Wireless Systems and*

*Networks and Networks*. 2006.

- [3] S. Haykin, "Cognitive Radio : Brain-Empowered," vol. 23, no. 2, 2005.
- [4] A. Marwanto, S. K. Syed Yusof, and M. H. Satria, "Orthogonal Frequency-Division Multiplexing-Based Cooperative Spectrum Sensing for Cognitive Radio Networks," *TELKOMNIKA (Telecommunication Comput. Electron. Control.*, vol. 12, no. 1, p. 143, 2014.
- [5] A. E. Prasetyo, M. Stefanus, A. Wiem, and A. Herusutopo, "Dengan Minimalisasi Roaming Di Binus Square," pp. 611–624.
- [6] P. Studi, T. Informatika, F. Sains, D. A. N. Teknologi, U. I. Negeri, and S. H. Jakarta, "PENGUKURAN INTERFERENSI PADA ACCESS POINT ( AP ) UNTUK MENGETAHUI QUALITY of SERVICE ( QoS ) NURMALIA," 2010.
- [7] Y. Ikawati, N. A. Siswandari, and O. Puspitorini, "ANALISA INTERFERENSI ELEKTROMAGNETIK PADA PROPAGASI Wi-Fi INDOOR," pp. 1–5, 2011.
- [8] J. Jenderal, A. Yani, and N. Palembang, "PERFORMANCE HOTSPOT UNIVERSITAS BINA DARMA."
- [9] W. Studi, K. Yogyakarta, J. Medan, M. Barat, N. Jakarta, and T. Fax, "Penggunaan frekuensi 2.4 ghz dalam keperluan internet wireless (studi kasus yogyakarta)," vol. 9, no. 2, pp. 225–244, 2011.
- [10] H. Nugroho, S. A. Siagian, A. Teknik, T. Sandhy, P. Jakarta, and A. Point, "ANALISIS BANDWIDTH JARINGAN WIFI," pp. 35–43.
- [11] S. D. Kandi and R. Fauzi, "ANALISIS KINERJA SPECTRUM SENSING MENGGUNAKAN METODE MATCHED FILTER PADA COGNITIVE RADIO," pp. 72–77.
- [12] A. Marwanto, "Software Defined Radio Design for OFDM Based Spectrum Exchange Information Using Arduino UNO and X-Bee," no. September, pp. 19–21, 2017.
- [13] X. Kang *et al.*, "Optimal Power Allocation Strategies for Fading Cognitive Radio Channels with Primary User," vol. 29, no. 2, pp. 374–383, 2011.
- [14] A. Ghasemi, C. Canada, and E. S. Sousa, "Spectrum Sensing in Cognitive Radio Networks : Requirements , Challenges and Design Trade-offs," no. April, pp. 32–39, 2008.
- [15] M. Ohta, T. Fujii, K. Muraoka, and M. Ariyoshi, "A Novel Power Controlled Sensing Information Gathering for Cooperative Sensing on Shared Spectrum with Primary Spectrum," pp. 111–115, 2011.
- [16] S. Barai, D. Biswas, and B. Sau, "Estimate Distance Measurement using NodeMCU ESP8266 based on RSSI Technique," pp. 170–173, 2017.
- [17] S. John, *Introduction of RF Propagation, 2005 John Wiley and Sons*.