

A Reconfigurable MIMO Antenna System for Wireless Communications

Evizal Abdul Kadir¹

¹Department of Information Technology, Faculty of Engineering, Universitas Islam Riau
Jl. Kaharuddin Nasution, Pekanbaru, Riau, Indonesia 28284
email: evizal@eng.uir.ac.id

Abstract — A reconfigurable antenna system is proposed to improve data throughput limitations in multiple input multiple output wireless communication systems in this investigation. The 4×4 MIMO antenna is designed to operate in the 2.4 and 2.6 GHz for Wireless Local Area Network (WLAN) and Long Term Evolution (LTE) applications. The system's radiation pattern reconfigurability is realized by using the microcontroller-driven PIN diode switching concept. Simulations and measurements exhibited good agreements for the single, 2×2 MIMO and 4×4 MIMO configurations. The antenna is operational between 2.387 to 2.628 GHz, while the simulated and measured reflection coefficients are at least -24.3 dB. All configurations produced a narrow beam forward radiation, while the envelope correlation coefficient (ECC) and diversity gain for the two MIMO configurations are below 0.5 and at least 9 dBi, respectively.

Index Terms — Antenna, MIMO, Wireless Communication, Reconfigurable

I. INTRODUCTION

Implementing reconfigurable antenna system onto wireless communication front end has significantly contributed to the improvement of wireless communication systems (WCS). Frequency, polarization, radiation pattern or their combination can be diversified to enable better WCS service delivery. Signal strength and data throughput of WCS can further be enhanced by implementing a reconfigurable system using multiple-input multiple-output (MIMO) antenna for WCS front end in such a way that antennas radiation characteristics are dynamically changed in accordance with the user's behavior such as mobility, data usage and method used to access the WCS. Hence, the introduction of the MIMO antenna system based reconfigurable front end will significantly improve the data capacity and directivity of WCSs. Researches on MIMO antenna based on frequency configurability for mobile devices are investigated in [1-6]. Previous research is done on frequency re-configurability to control or steer radiation patterns for MIMO antenna designed, furthermore in these proposed frequency configurable antenna designed is mostly to switch the antenna beam. MIMO antennas which are reconfigurable in terms of polarization and radiation are proposed in [7-13] is based on antenna design such as used slot, array antenna design or butler matrix to control radiation pattern and polarization. In these designs, it is only the receiver side that controls the radiation pattern of the antenna beam. The use of dielectric resonators as MIMO antennas for LTE band is presented in [14-16].

However, the design covers single frequency band at 700 MHz. A compact, ultra wideband MIMO antenna for mobile device proposed in [17]. The design is achieved using a printed folded monopole antenna coupled with a parasitic inverted-L element. However, similar to the previous only for receiver side for devices, although cover wideband frequency but not in 2.6 GHz spectrum.

In this paper, a dual band reconfigurable MIMO antenna for a wireless transmitter system is presented. The proposed MIMO antenna system is designed to operate at 2.4 GHz for WLAN and 2.6 GHz for LTE applications. The single element antenna can be configured to form a single 4x4 MIMO antenna, either as a two 2x2 MIMO antenna or a single 4x4 array. The microstrip line on the reverse side of the patch layer is fed coaxially and is fitted with PIN diodes to enable switching via a microcontroller module. To optimize space, an air gap is introduced between the ground and radiating elements to realize a high gain antenna. This technique proposed to control transmitter antenna radiation pattern for efficiency and reduce interference, adaptive radiation pattern achieve by control MIMO antenna configuration either 4x4 MIMO antenna or two 2x2 MIMO antenna or single antenna that all elements is combined to obtain high gain with narrow beam radiation pattern. Radiation pattern configurability for a MIMO antenna using such mechanism and producing a wide impedance bandwidth for WLAN and LTE is, to the best of our knowledge, has never been published before in open literatures.

II. RELATED WORKS

In this proposed design, individual antennas are cascaded to form the MIMO antenna system. The antenna is implemented using a low-cost FR-4 board with a relative permittivity of $\epsilon_r = 4.7$, height, $h = 1.6$ mm and loss tangent, $\tan \delta = 0.019$. The single element and 2x2 MIMO antenna is designed based on the procedure described in [18, 19] resulting in optimized structure illustrated in Figure 1. The 2x2 array yielded a narrowband, directional antenna with high gain, and hence, slots are introduced onto the antenna to widen its 10 dB impedance bandwidth.

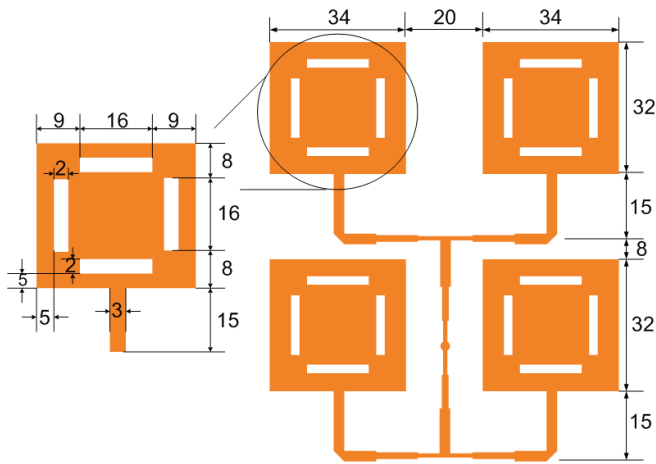

Fig. 1. Design of the single MIMO antenna (all dimensions in mm)

The antenna elements are arranged and fed using a corporate feeding scheme. PIN diodes are used to connect the desired antenna feed to the main transmission line as shown in Figure 2, every set element of MIMO antenna has transmission line to connect or disconnect to others element in order to making array element. The locations of the radiating elements (labeled as element 1, 2, 3 and 4) and diodes on the top layer is shown in Figure 2(a), while the bottom layer antenna layer comprising transmission lines is shown in Figure 2(b). A total of 6 PIN diodes are used to connect/disconnect these lines by activating/deactivating the DC power towards each PIN diode using a microcontroller unit.

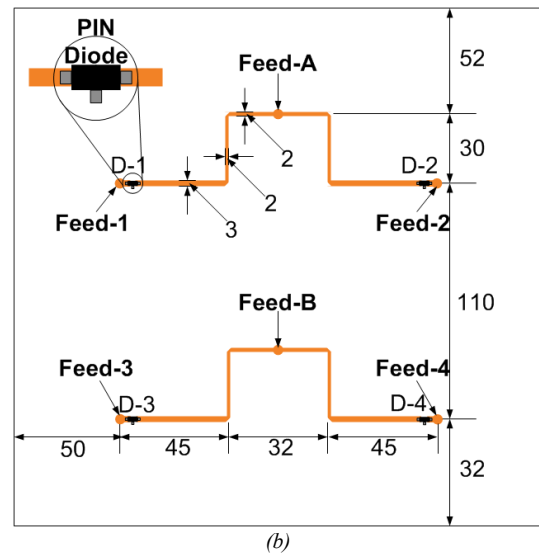

Fig. 2. Design of the single MIMO antenna (all dimensions in mm)

III. ANTENNA PERFORMANCE EVALUATION

The MIMO antenna system is fabricated and integrated with a microcontroller unit to enable its reconfigurable feature. Its prototype is shown in Figure 4. The antenna performance is first evaluated using a vector network analyzer and radiation pattern measurement system in an anechoic chamber. Experimental evaluation of the overall system is then performed in the Wireless Communication Centre (WCC) UTM, to validate its accuracy and limitation.

A. Evaluation of the MIMO Antenna

To properly evaluate the antenna reflection coefficient, radiation pattern and antenna gain, each ports are evaluated individually while the rest are terminated. Since there are four single antennas, the reflection coefficient for each port is labeled S_{11} , S_{22} , S_{33} and S_{44} . The isolations between the antenna ports are denoted as S_{mn} . Meanwhile, the ports for the 2x2 MIMO are indicated as ports A and B. Their reflection coefficients are designated as SAA and SAB, while the isolations between ports are labeled as SAB and SBA. Port A is measured when only diodes D-1 and D-2 are activated, while port B when D-3 and D-4 are activated. Figure 3 show fabricated antenna for both sides.

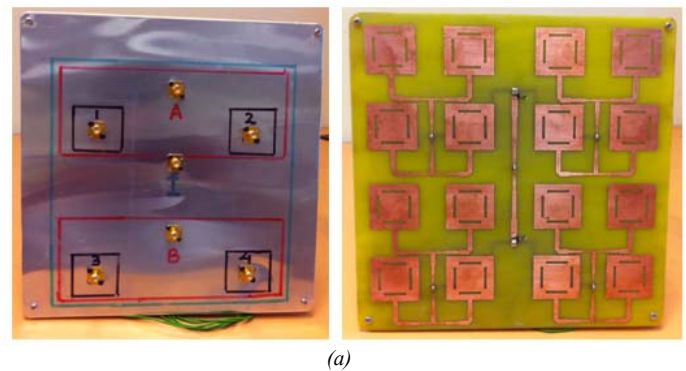
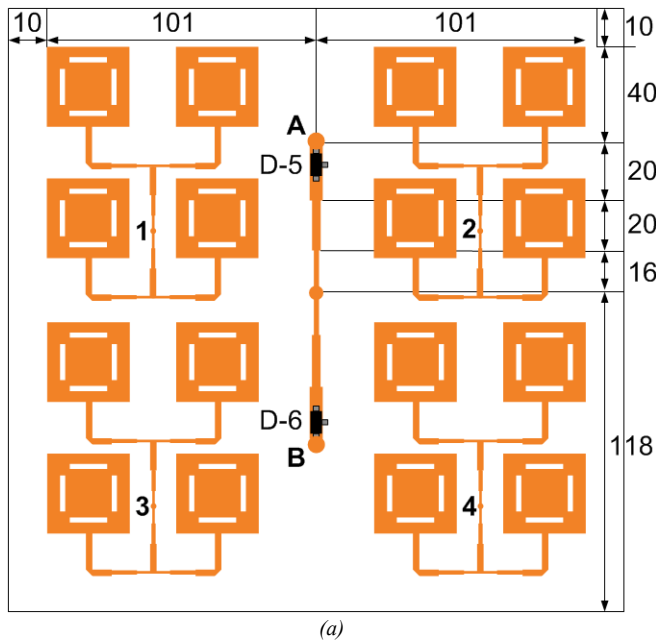

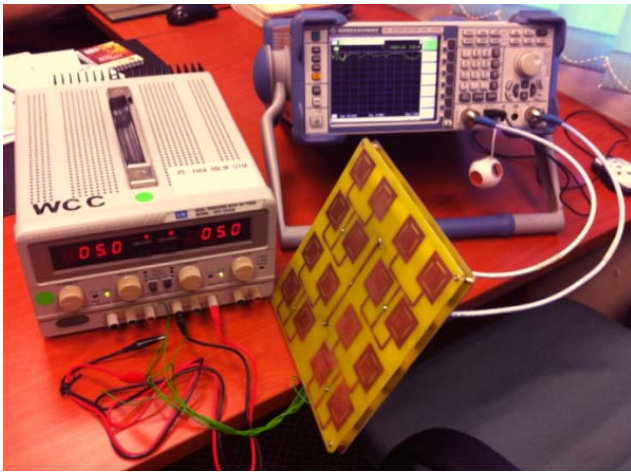

(b)

Fig. 3. The prototype of the MIMO antenna system: (a) top and bottom views (b) measurement setup.

B. Field Testing

The proposed MIMO system is then implemented as an access point for Wireless Local Area Network (WLAN). User types (whether it is a laptop, smart phone, etc) accessing the internet is determined before their data throughput and radio unit is assessed. The use of the WLAN architecture in this section simplifies the assessment procedure due to its availability compared to when LTE devices are used. Figure 4 shows the WLAN access point using the developed MIMO antenna system, consisting of 3 set of Mikrotik R52 radio units and Mikrotik Router Board 133. A microcontroller model Microchip PIC16F877 is used to control the activation of PIN diodes for the MIMO system. The seven MIMO antenna ports are connected to the radio unit via coaxial cables and standard SMA connector.

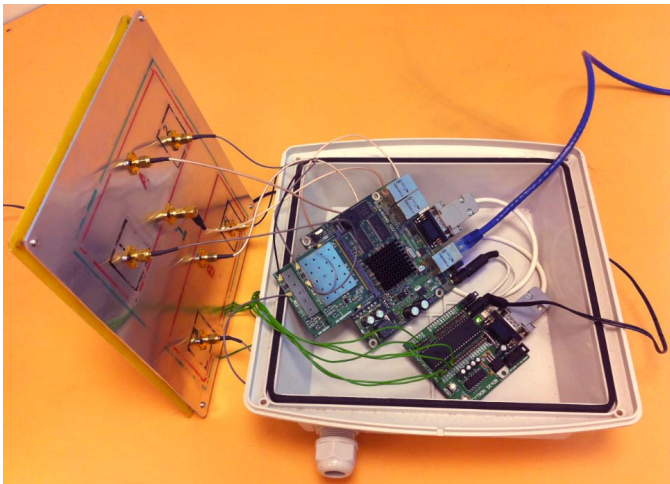

Fig. 4. Configuration of MIMO antenna system in the WLAN access point

IV. RESULTS AND DISCUSSION

The single MIMO antenna evaluated indicated a satisfactory agreement between simulation and measurement. Its measured reflection coefficient indicated operation from 2.387 to 2.628 GHz for WLAN and LTE bands see Figure 5. Simulations produced a minimum S11 of -27.8 dB at 2.45 GHz whereas the optimal measured S11 of -24.36 dB at a slightly higher frequency of 2.5 GHz.

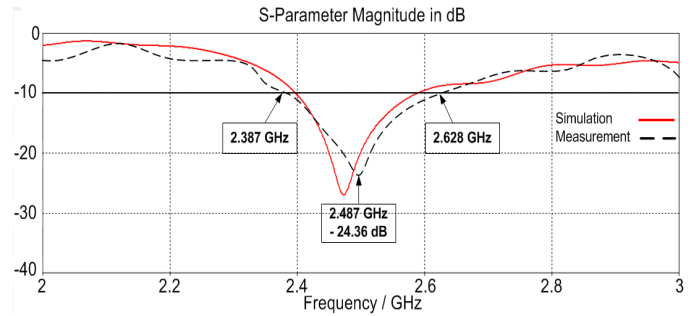

Fig.5. Simulated and measured reflection coefficient of the single MIMO antenna.

Isolation between the antenna ports for this antenna is also assessed and summarized in Figure 6, indicating the maximum isolation of at least 15 dB.

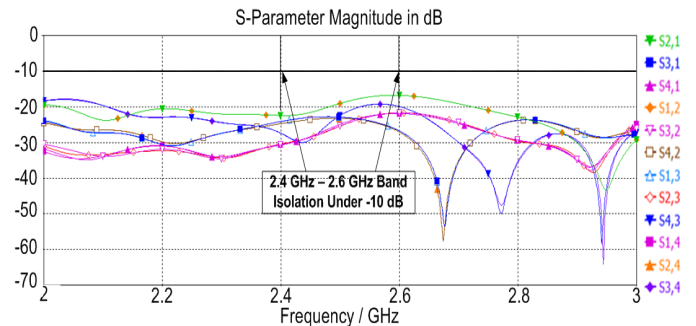

Fig.6. Isolation between different ports of the MIMO antenna.

The radiation pattern of the first configuration, the 4x4 MIMO antenna are simulated and measured at 2.5 GHz, as shown in Figure 7 indicating a good agreement. A directional forward beam is generated for the E- and H-planes with minimal side lobes.

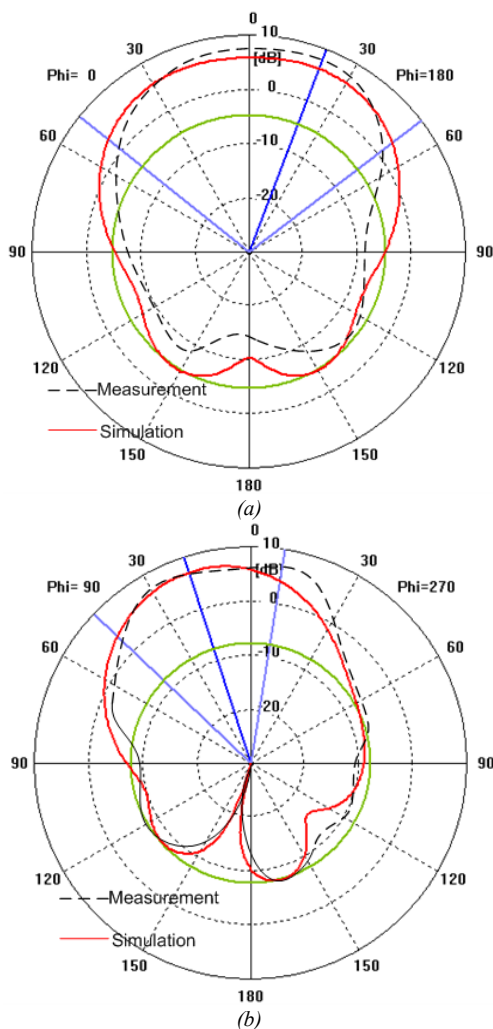

Fig.7. Radiation pattern of a single antenna (a) E-field (b) H-field

V. CONCLUSION

A reconfigurable MIMO antenna system for WLAN and LTE standards has been proposed, consisting of rectangular slotted microstrip antenna elements. They form an array antenna which can either be configured as a 2x2 or 4x4 MIMO antenna system, or can also be used as a conventional high gain directional array. Pattern configurability is achieved via the switching of six PIN diodes located on the microstrip transmission line. Measurements confirmed that the antenna is operational from 2.387 to 2.628 GHz, agreeing well with simulations with optimal reflection coefficients of -27.8 dB at 2.4 GHz and -24.3 dB at 2.6 GHz, respectively. The proposed system is then integrated within a WLAN access point and further evaluated in a practical environment.

REFERENCES

[1] L. Jong-Hyuk, J. Zhe-Jun, S. Chang-Wook, and Y. Tae-Yeoul, "Simultaneous Frequency and Isolation Reconfigurable MIMO PIFA Using PIN Diodes," *Antennas and Propagation, IEEE Transactions on*, vol. 60, pp. 5939-5946, 2012.

[2] L. Haitao, S. Gao, and L. Tian Hong, "Compact MIMO Antenna With Frequency Reconfigurability and Adaptive Radiation Patterns," *Antennas and Wireless Propagation Letters, IEEE*, vol. 12, pp. 269-272, 2013.

[3] A. N. Kulkarni and S. K. Sharma, "Frequency Reconfigurable Microstrip Loop Antenna Covering LTE Bands With MIMO Implementation and Wideband Microstrip Slot Antenna all for Portable Wireless DTV Media Player," *Antennas and Propagation, IEEE Transactions on*, vol. 61, pp. 964-968, 2013.

[4] Z. J. Jin, J. H. Lim, and T. Y. Yun, "Frequency reconfigurable multiple-input multiple-output antenna with high isolation," *Microwaves, Antennas & Propagation, IET*, vol. 6, pp. 1095-1101, 2012.

[5] M. S. a. S. M. H. R. Karimian, "Tri-band four elements MIMO antenna system for WLAN and WiMAX application," *Journal of Electromagnetic Waves and Applications*, vol. 26, pp. 2348-2357, 2012.

[6] R. V. Janne Ilvonen, Jari Holopainen and Ville Viikari, "Multiband Frequency Reconfigurable 4G Handset Antenna with MIMO Capability," *Progress In Electromagnetics Research*, vol. Vol. 148, pp. 233-243, 2014.

[7] B. A. Cetiner, E. Akay, E. Sengul, and E. Ayanoglu, "A MIMO System With Multifunctional Reconfigurable Antennas," *Antennas and Wireless Propagation Letters, IEEE*, vol. 5, pp. 463-466, 2006.

[8] K. Z. Shuai Zhang, Bangguo Zhu, Zhinong Ying, and Sailing He, "MIMO Reference Antennas with Controllable Correlations and Total Efficiencies," *Progress In Electromagnetics Research*, vol. Vol. 145, pp. 115-121, 2014.

[9] Q. Pei-Yuan, Y. J. Guo, A. R. Weily, and L. Chang-Hong, "A Pattern Reconfigurable U-Slot Antenna and Its Applications in MIMO Systems," *Antennas and Propagation, IEEE Transactions on*, vol. 60, pp. 516-528, 2012.

[10] R. Gierlich, J. Huttner, A. Ziroff, R. Weigel, and M. Huemer, "A Reconfigurable MIMO System for High-Precision FMCW Local Positioning," *Microwave Theory and Techniques, IEEE Transactions on*, vol. 59, pp. 3228-3238, 2011.

[11] L. Zhengyi, D. Zhengwei, and G. Ke, "Compact Reconfigurable Antenna Array for Adaptive MIMO Systems," *Antennas and Wireless Propagation Letters, IEEE*, vol. 8, pp. 1317-1320, 2009.

[12] J. Sarrazin, Y. Mahe, S. Avrillon, and S. Toutain, "Pattern Reconfigurable Cubic Antenna," *Antennas and Propagation, IEEE Transactions on*, vol. 57, pp. 310-317, 2009.

[13] J. B. Yan and J. T. Bernhard, "Implementation of a Frequency-Agile MIMO Dielectric Resonator Antenna," *Antennas and Propagation, IEEE Transactions on*, vol. 61, pp. 3434-3441, 2013.

[14] A. B. N. M. S. Sharawi, and D. N. Aloï, "Isolation improvement in a dual-band dual-element MIMO antenna system using capacitively loaded loops," *Progress In Electromagnetics Research*, vol. Vol. 134, pp. 247-266, 2013.

[15] B. K. H. Wi, W. Jung, and B. Lee, "Multiband handset antenna analysis including lte band MIMO service," *Progress In Electromagnetics Research*, vol. Vol.138, pp. 661-673, 2013.

[16] Y. L. S. Cui, W. Jiang, S. X. Gong, Y. Guan & S. T. Yu, "A Novel Compact Dual-Band MIMO Antenna with High Port Isolation," *Journal of Electromagnetic Waves and Applications*, vol. 25, pp. 1645-1655, 2011.

[17] L. Jae-Min, K. Ki-Baek, R. Hong-Kyun, and W. Jong-Myung, "A Compact Ultrawideband MIMO Antenna With WLAN Band-Rejected Operation for Mobile Devices," *Antennas and Wireless Propagation Letters, IEEE*, vol. 11, pp. 990-993, 2012.

[18] C. A. Balanis, *Antenna Theory: Analysis and Design*: John Wiley & Sons, 2005.

[19] E. S. Evizal, T. A. Rahman, S. K. A. Rahim and S. L. Rosa, "Multiple Bands Antenna with Slots for Wireless Communication System," *Advances in Robotics, Mechatronics and Circuits*, pp. 173-177, 2014.