

Renewable Energy Inclusion on Economic Power Optimization using Thunderstorm Algorithm

A.N. Afandi

Electrical Engineering Department
Universitas Negeri Malang
Malang, Jawa Timur, Indonesia
an.afandi@um.ac.id, an.afandi@ieee.org

Yunis Sulistyorini

Department of Math
IKIP Budi Utomo
Malang, Indonesia
yunis.sulistyorini@gmail.com

Goro Fujita, Nguyen Phuc Khai

Electrical Engineering and Computer Science
Shibaura Institute of Technology
Tokyo, Japan
gfujita@sic.shibaura-it.ac.jp, na14502@shibaura-it.ac.jp

Nedim Tutkun

Electrical Engineering Department
Duzce University
Duzce, Tukey
nedimtutkun@gmail.com

Abstract—This paper presents an economic operation considered renewable energy which is optimized using thunderstorm algorithm. The problem is constrained by an emission standard and various technical limits implemented on the 62-bus system model. Simulations showed that the renewable energy inclusion penetrates to the unit commitment of generating units with strongly approach for the computational solution. This inclusion also affects to the individual power production in accordance to the fuel cost and pollutant discharge.

Keywords—economic operation; pollutant emission; renewable energy; thunderstorm algorithm

I. INTRODUCTION

Nowadays, a power system becomes a complex network constructed using physical components on the based technical requirements for generation, distribution and transmission systems [1-2]. This integrated structure is used to provide a high quality and reliable system to meet a power demand [1-5]. Operationally, the demand leads to energy usages at customers. The increase in energy consumption also due to the power management covered the energy security and the power stock of the system. This condition forces to explore potential primary energy sources, such as wind, solar and others. Technically, the renewable energy integration (REI) is depended on applied current technologies and role on the power penetration [6-10]. Recently, this mitigation becomes one of the most issues in the energy procurement for providing power outputs of the alternative generating system.

Presently, the power production covers clean energy and considers a global warming caused by pollutant discharges in various types like CO, CO₂, SO_x and NO_x. These environmental requirements have been forced by the Clean Air Act Amendments of 1990 subjected to reduce an air contaminant [8], [11-15]. Meanwhile, a power system operation is not the conventional energy production only but it also explores renewable energy sources and controls the

pollutant contribution. Thus, the operation becomes more complex required by the environmental protection, renewable energy inclusion, and technical constraints. It should be managed economically to obtain the balanced running charge of the operation while producing energy in the lowest pollution.

Practically, one of common strategies is an economical cost used to operate and decide a unit commitment of various energy producers. This strategy treats the optimal operating cost considered fuel and pollutant fees for the existed power plant connected to the grid [3], [12]. The fuel cost is approached using an economic load dispatch (ELD) whereas a pollutant discharge (PD) covers contaminant producers [2], [4-5], [8], [11-12], [14], [16]. In addition, the REI leads to the committed power producers to meet the individual power portion. By involving the ELD, PD, and REI problems, the committed power output is defined as a single objective function (SOF) of the optimization problem.

A couple of years, numerous methods have been proposed and applied to solve related optimization problems in the power system operation. These approaches categorized into classical and evolutionary methods. Classical methods are supported by mathematical programs whereas evolutionary methods are developed based on optimization techniques. Presently, evolutionary techniques are common used to solve the optimization problem in the power system [1-2], [4-5], [8], [13-19]. Many methods have been advanced and developed in various improved names of the evolutionary algorithm for increasing each ability based on own inspirations, hierarchies and procedures. As a novel approach, this paper explores thunderstorm algorithm (TA) to carry out the SOF considered the REI, ELD and PD problems. The solution will be desired within various technical constraints on the 62-bus system model.

II. THUNDERSTORM ALGORITHM

In principles, TA has been inspired by a natural process. In nature, many phenomena become curious inspirations to recognize natural processes. Many mechanisms have been also selected and used to develop evolutionary algorithms. Moreover, TA has been constructed based on the natural inspiration of thunderstorm mechanisms associated with natural steps in terms of the charge separation, leader formation, and discharge channel. In particular, studies of thunderstorms have been advanced rapidly towards for understanding the multiple lightning, thunderstorm mechanisms, and related consequences [20].

Based on thunderstorm mechanisms, TA presented in 2016 which was covered for multiple lightning's developments in terms of the charge separation, leader formation, and discharge channel. It introduced early on March 2016 conducted to the striking process, channeling, and avalanche for draining the cloud. Its pseudo-codes are consisted of Cloud Phase, Streamer Phase and Avalanche Phase [18-19]. Cloud Phase can be charged using possibility mechanisms of the forward cloud charge, expanded cloud charge, and reverse cloud charge. Streamer Phase is used to select the prior streamer and striking directions whereas Avalanche Phase evaluates channels and updates the streaming track. In detail, the hierarchies of pseudo-codes are depicted in Figure 1 and Figure 2 illustrates cloud developments in three mechanisms.

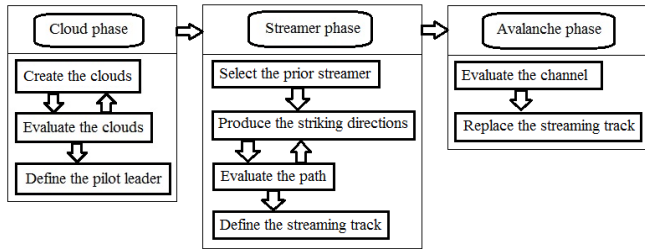

Fig. 1. Hierarchy processes of thunderstorm algorithm

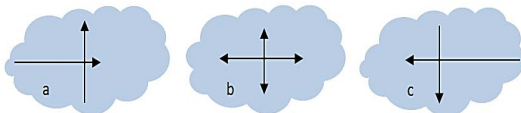

Fig. 2. Cloud's mechanisms (a. forward mechanism, b. expanded mechanism, and c. reverse mechanism)

In general, the Cloud can be developed throughout three ways, but in these works, Cloud Phase is generated using the forward cloud charge mechanism. Mathematically, this algorithm is presented in the following main statements:

$$\text{Forward mechanism: } Q_j^s = Q_j^{\min} + u \cdot Q_j^{\text{del}}, \quad (1)$$

$$\text{Cloud size: } CS_j^s = cn_j^s \cdot a_j^s \cdot h_j^s, \quad (2)$$

$$\text{Striking path: } D_{j,n}^s = Q_{\text{dep},n}^s \cdot b \cdot h, \quad (3)$$

$$\text{Probability charge: } \text{prob}Q_j^s \begin{cases} \frac{Q_{j,m}^s}{\sum Q_m^s} & \text{for } m \\ \frac{Q_{j,n}^s}{\sum Q_n^s} & \text{for } n \end{cases}, \quad (4)$$

where Q_j^s is the current charge, Q_j^{del} is the distance charge, u is the random number within $[0, 1]$, Q_j^{\min} is the minimum charge, s is the streaming flow, $j \in (1, 2, \dots, a)$, a is the number of variables, CS_j^s is the cloud size, cn_j^s is the number of charges, $D_{j,n}^s$ is the striking charge's position, $Q_{\text{dep},n}^s$ is the deployed distance, n is the striking direction of the h^{th} , h is the hazardous factor, b is the random within $(1-a)$.

III. PROBLEM STATEMENT

In general, the ELD considers a total demand while deciding a unit commitment of various power plants forced by the environmental requirement for decreasing disposal pollutants through the PD problem. The ELD and PD problems are also acceptable in the SOF which is penetrated by the REI on the balanced power production. The SOF is targeted for determining the cheapest operating cost corresponded to the lowest emission [8], [11-12], [16]. In principle, the PD is controlled by an emission standard (EmiStd). The EmiStd is used to measure the allowed emission from the burning of fossil fuels which is discharged in air [1-3], [11-14].

By considering the ELD, PD, and REI, the SOF includes penalty and compromised factors [8], [18-19]. The compromised factor sets on the contribution of ELD and PD problems and the penalty factor transfers the emission into a financial compensation. In these works, the penalty factor is approached using a dominant penalty factor as detailed in [8]. The REI gives a power penetration to the selected injection bus on the grid. In particular, the power system is operated under technical limitations related to the SOF of the power system optimization. Operationally, a total transmission loss, power limits, voltage levels, a power transfer capability are also frequent used to evaluate the solution. In these studies, the problem is formulated using following mathematical statements:

$$\text{ELD} = \sum_{i=1}^{\text{ng}} (c_i + b_i \cdot P_i + a_i P_i^2), \quad (5)$$

$$\text{PD} = \sum_{i=1}^{\text{ng}} (\gamma_i + \beta_i \cdot P_i + \alpha_i P_i^2), \quad (6)$$

$$\text{SOF} = (1 - w) \cdot (\text{ELD}) + w \cdot h \cdot (\text{PD}), \quad (7)$$

$$\sum_{i=1}^{\text{ng}} P_i + \sum_{k=1}^{\text{nw}} P_k^{\text{rei}} = D + \text{PL}, \quad (8)$$

$$PG_p + P_p^{\text{rei}} = PD_p + V_p \cdot \left[\sum_{q=1}^{\text{nBus}} V_q (G_{pq} \cdot \cos(\theta_{pq}) + B_{pq} \cdot \sin(\theta_{pq})) \right], \quad (9)$$

$$QG_p = QD_p + V_p \cdot \left[\sum_{q=1}^{\text{nBus}} V_q (G_{pq} \cdot \sin(\theta_{pq}) - B_{pq} \cdot \cos(\theta_{pq})) \right], \quad (10)$$

$$P_i^{\min} \leq P_i \leq P_i^{\max}, \quad (11)$$

$$Q_i^{\min} \leq Q_i \leq Q_i^{\max}, \quad (12)$$

$$V_p^{\min} \leq V_p \leq V_p^{\max}, \quad (13)$$

$$S_{pq} \leq S_{pq}^{\max}, \quad (14)$$

where ELD is the total fuel cost of generating units (\$/h), P_i is the power output of the i^{th} generating unit (MW), ng is the number of generating units, a_i , b_i , c_i are fuel cost coefficients of the i^{th} generating unit, PD is the total pollutant production of generating units (kg/h), α_i , β_i , γ_i are emission coefficients of the i^{th} generating unit, SOF is the objective function of the combined dispatch (\$/h), the h is a penalty factor (\$/kg), w is a

compromised factor, D is the demand (MW), PL is the total transmission loss (MW), P_k^{rei} is the power output of the k^{th} of the REI, PG_p and QG_p are power injections of load flow at bus p (MW and MVar), P_p^{rei} is the power injections of the REI at bus p (MW), PD_p and QD_p are load demands of load flows at bus p (MW and MVar), V_p and V_q are voltages at bus p and q (kV), P_i^{min} and P_i^{max} is the minimum and maximum power outputs (MW), of the i^{th} generating unit, Q_i^{max} and Q_i^{min} are maximum and minimum reactive power outputs (MVar) of the i^{th} generating unit, Q_i is the reactive power output of the i^{th} generating unit (Mvar), V_p^{max} and V_p^{min} are maximum and minimum voltages at bus p , S_{pq} is the power transfer between bus p and q (MVar), S_{pq}^{max} is the limit of the power transfer between bus p and q (MVar).

IV. PROCEDURES OF IMPLEMENTATION

As detailed in [18-19], TA is guided by following steps in terms of Cloud Phase, Streamer Phase and Avalanche Phase. These phases are conducted to the certain hierarchies using its parameters for determining the optimal solution through the sequencing order as given in Figure 1 and Figure 4.

By considering TA's procedures, programming structures are developed and run in 100 of the streaming flow to solve the SOF using 1 of the avalanche, 50 of the cloud charge, 4 of the hazardous factor, and 200 of the cloud size. This execution considers a 62-bus system as a sample model. Technically, this model has 62 buses; 89 lines; 32 load buses, and 19 generating units as depicted in Figure 3. This model is modified to locate the REI at the selected bus. In particular, system's parameter of these works are listed in Table I for the power limits and Table II for the individual coefficients.

TABLE I. GENERATING UNIT'S POWER LIMITS

Gen	MW		MVar	
	P_{min}	P_{max}	Q_{min}	Q_{max}
G1	85.0	300.0	0	450
G2	63.0	450.0	0	500
G3	63.0	450.0	-50	500
G4	20.5	100.0	0	150
G5	85.0	300.0	-50	300
G6	63.0	450.0	-50	500
G7	87.5	200.0	-50	250
G8	72.5	500.0	-100	600
G9	70.5	600.0	-100	550
G10	74.5	100.0	0	150
G11	65.0	150.0	-50	200
G12	10.0	150.0	0	75
G13	15.0	300.0	-50	300
G14	10.5	150.0	-50	200
G15	10.5	500.0	-50	550
G16	20.0	150.0	-50	200
G17	15.0	100.0	0	150
G18	85.0	300.0	-50	400
G19	65.5	600.0	-100	600

TABLE II. GENERATING UNIT'S COEFFICIENTS

Gen	Fuel cost			Emission		
	α	β	γ	a	b	c
G1	0.0070	6.80	95	0.018	-1.81	24.30
G2	0.0055	4.00	30	0.033	-2.50	27.02
G3	0.0055	4.00	45	0.033	-2.50	27.02
G4	0.0025	0.85	10	0.014	-1.30	22.07
G5	0.0060	4.60	20	0.018	-1.81	24.30
G6	0.0055	4.00	90	0.033	-2.50	27.02
G7	0.0065	4.70	42	0.013	-1.36	23.04
G8	0.0075	5.00	46	0.036	-3.00	29.03
G9	0.0085	6.00	55	0.040	-3.20	27.05
G10	0.0020	0.50	58	0.014	-1.30	22.07
G11	0.00450	1.60	65	0.014	-1.25	23.01
G12	0.00250	0.85	78	0.012	-1.27	21.09
G13	0.00500	1.80	75	0.018	-1.81	24.30
G14	0.00450	1.60	85	0.014	-1.20	23.06
G15	0.00650	4.70	80	0.036	-3.00	29.00
G16	0.00450	1.40	90	0.014	-1.25	23.01
G17	0.00250	0.85	10	0.014	-1.30	22.07
G18	0.00450	1.60	25	0.018	-1.81	24.30
G19	0.00800	5.50	90	0.040	-3.00	27.01

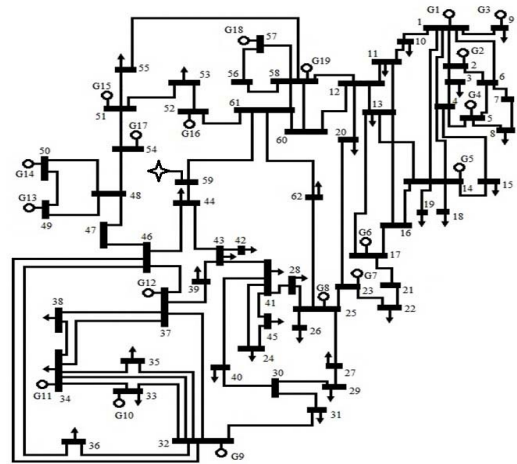

Fig. 3. The 62-bus system model with the REI

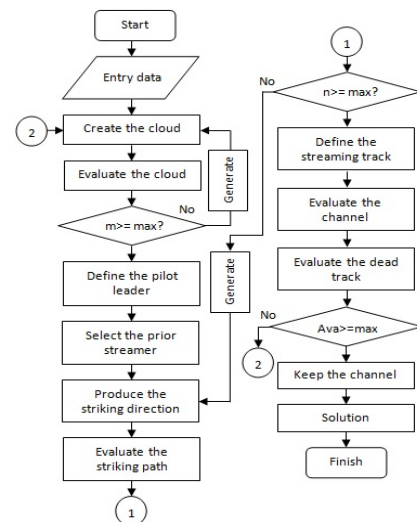

Fig. 4. Sequencing orders of the computation

Furthermore, in these works, the performances are also conditioned by suitable ranges for each unit commitment through a load flow analysis based on $\pm 5\%$ of voltage violations, and 95% of the power transfer capability. In addition, the problem is focused on the economic power optimization due to the SOF considered 0.5 of the compromised factor, upper and lower power limits, 0.85 kg/MWh of the EmiStd, and the percentage penetration of the REI.

V. RESULTS AND DISCUSSIONS

These works are addressed to solve the SOF problem considered the penetration of the REI based on the ELD and PD problems. By considering the emission standard and technical requirements, TA has been used to determine the optimal solution using its parameters to cover Cloud Phase, Streaming Phase, and Avalanche Phase. The obtained results on the 62-bus system model included selected buses of the wind energy as the REI are given in following figures and tables presented in numerical results and graphical performances.

In this section, a running test for 20% of the REI, the execution considered this penetration is used for feeding 1,305.5 MW of the demand as detailed in Figure 5 and Figure 6, but the other results are depicted and illustrated within 10%-50% of the REI. By considering 20% of the REI, a set population is shown in Figure 5 for the cloud charge which is initiated for 200 series of unit commitments considered 19 power producers in random combinations. These candidate solutions have been explored in 100 streaming flows to get the optimal solution as performed in Figure 6. Figure 6 shows the speed of the computation for determining the optimal computing speed. This speed illustrates a computational characteristic for TA.

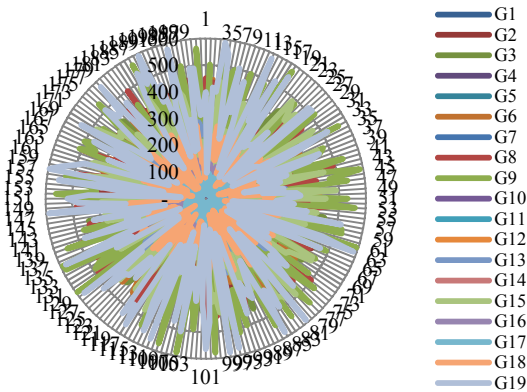

Fig. 5. Cloud charges of TA on the 20% of the REI

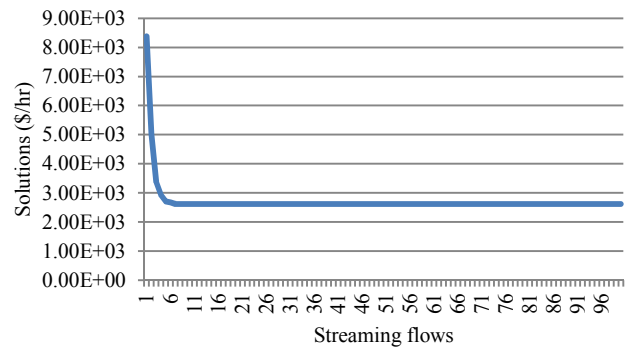

Fig. 6. Speeding performances of TA on the 20% of the REI

TABLE III. GENERATING UNIT'S POWER PRODUCTION

Gen (MW)	Percentage of Renewable Energy Inclusion				
	10%	20%	30%	40%	50%
G1	115.0	85.0	85.0	85.0	85.0
G2	63.0	63.0	63.0	63.0	63.0
G3	87.3	63.0	63.0	63.0	63.0
G4	20.5	89.2	79.2	20.5	20.5
G5	85.0	85.0	85.0	85.0	85.0
G6	63.0	63.0	63.0	63.0	63.0
G7	87.5	87.5	87.5	87.5	87.5
G8	72.5	72.5	72.5	72.5	72.5
G9	120.5	70.5	70.5	70.5	70.5
G10	74.5	94.5	100.0	85.0	74.5
G11	65.0	65.0	65.0	65.0	65.0
G12	10.0	50.0	10.5	10.0	10.0
G13	15.0	15.0	15.0	15.0	15.0
G14	76.5	10.5	24.2	10.5	10.5
G15	84.5	90.5	10.5	10.5	10.5
G16	20.0	20.0	20.0	20.0	20.0
G17	75.8	85.0	85.0	20.0	15.0
G18	85.0	105.0	85.0	85.0	85.0
G19	125.5	65.5	65.5	65.5	65.5
Total	1,346.1	1,279.7	1,149.4	996.5	981.0

TABLE IV. TOTAL OPERATING COSTS OF GENERATING UNITS

Gen (\$/h)	Percentage of Renewable Energy Inclusion				
	10%	20%	30%	40%	50%
G1	994.8	723.8	723.8	723.8	723.8
G2	304.1	304.1	304.1	304.1	304.1
G3	464.2	319.1	319.1	319.1	319.1
G4	29.0	112.4	95.1	29.0	29.0
G5	454.6	454.6	454.6	454.6	454.6
G6	364.1	364.1	364.1	364.1	364.1
G7	503.3	503.3	503.3	503.3	503.3
G8	448.3	448.3	448.3	448.3	448.3
G9	1,005.0	520.4	520.4	520.4	520.4
G10	106.7	132.7	141.1	119.5	106.7
G11	188.2	188.2	188.2	188.2	188.2
G12	96.3	248.0	97.0	96.3	96.3
G13	103.7	103.7	103.7	103.7	103.7
G14	239.9	107.9	127.4	107.9	107.9
G15	538.7	583.0	130.8	130.8	130.8
G16	121.5	121.5	121.5	121.5	121.5
G17	89.6	104.9	104.9	28.7	25.9
G18	193.7	257.9	193.7	193.7	193.7
G19	1,037.0	485.6	485.6	485.6	485.6
Total	7,282.5	6,083.2	5,426.4	5,242.3	5,226.7

By considering the REI throughout the wind energy penetration, power productions are provided in Table III for each power plant. According to this table, the total power is generated around 981-1,346.1 MW to feed the load. These committed power plants are affected by the REI associated with percentage portions. In addition, the participation of the REI is given in several values as its contribution on the existing system which are 130.5 MW (10%), 261.1 MW (20%), 391.6 MW (30%), 522.2 MW (40%), and 652.7 MW (50%).

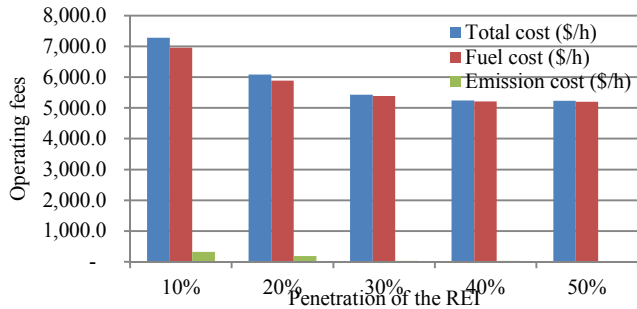

Fig. 7. Operating fees of the unit commitment

TABLE V. POLLUTANT DISCHARGES OF GENERATING UNITS

Gen (kg/h)	Percentage of Renewable Energy Inclusion				
	10%	20%	30%	40%	50%
G1	54.2	0.5	0.5	0.5	0.5
G2	0.5	0.5	0.5	0.5	0.5
G3	60.3	0.5	0.5	0.5	0.5
G4	1.1	14.3	4.4	1.1	1.1
G5	0.5	0.5	0.5	0.5	0.5
G6	0.5	0.5	0.5	0.5	0.5
G7	0.5	0.5	0.5	0.5	0.5
G8	0.8	0.8	0.8	0.8	0.8
G9	222.3	0.3	0.3	0.3	0.3
G10	0.7	20.7	28.1	9.8	0.7
G11	0.5	0.5	0.5	0.5	0.5
G12	20.5	260.1	21.1	20.5	20.5
G13	1.2	1.2	1.2	1.2	1.2
G14	13.2	12.0	2.2	12.0	12.0
G15	32.5	52.3	1.5	1.5	1.5
G16	3.6	3.6	3.6	3.6	3.6
G17	1.7	9.8	9.8	1.5	5.6
G18	0.5	32.7	0.5	0.5	0.5
G19	280.5	2.1	2.1	2.1	2.1
Total	695.5	413.4	79.0	58.3	53.3

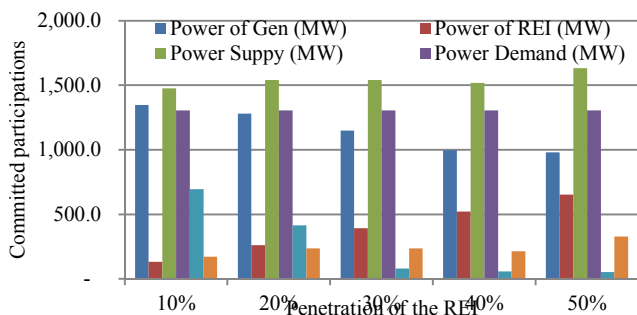

Fig. 8. Total participations on the economic power operation

In particular, Table III also shows spatial individual power outputs of generating units with different capacities even

several plants are operated constantly. Economically, this operation spends the budget as listed in Table IV covered for own operated power stations and total operating costs. This table also informs that the total cost is used for generating units to keep the existing system spent for the fuel consumption and the pollutant compensation. In detail, the operating cost is 5,226.7 \$/h to 7,282.5 \$/h associated with 10%-50% of the REI for the fuel procurement and pollutant compensation as detailed in Figure 7.

TABLE VI. OPTIMAL SCHEDULED OPERATION

Targets	Renewable Energy Inclusion				
	10%	20%	30%	40%	50%
Power of Gen (MW)	1,346.1	1,279.7	1,149.4	996.5	981.0
Power of REI (MW)	130.6	261.1	391.7	522.2	652.8
Power Supply (MW)	1,476.7	1,540.8	1,541.1	1,518.7	1,633.8
Demand (MW)	1,305.5	1,305.5	1,305.5	1,305.5	1,305.5
Power Loss (MW)	171.2	235.3	235.6	213.2	328.3
Fuel cost (\$/h)	6,958.4	5,890.5	5,389.6	5,215.2	5,201.9
Emission cost (\$/h)	324.1	192.6	36.8	27.2	24.9
Total cost (\$/h)	7,282.5	6,083.2	5,426.4	5,242.3	5,226.7
Pollutant (kg/h)	695.5	413.4	79.0	58.3	53.3

Moreover, as the environmental effects, the discharged pollutant on this operation is presented in Table V. According to this table, it is known that each generator produces in a different portion of the pollution. In total, the produced pollutant will be decreased when the REI is rose up. Based on the scenarios of the REI in 10%-50%, the pollution is released within 53.3 kg/h to 695.5 kg/h. In total, the unit commitment has many impacts in the economic operation as illustrated in Figure 8. Mainly, this figure presents participations and impacts of the economic operation such the REI, power production, demand, loss, and pollution. Then, final results of the optimal condition considered the REI are given in Table VI. This table compares all performances based on the theme of 10%-50% of the REI. Various results are given in the power, loss, cost and pollutant.

VI. CONCLUSIONS

These works are addressed to solve the SOF considered penetrations of the REI based on the ELD and PD problems. By considering an environmental protection and operation limitations, simulation results demonstrated application of TA to the 62-bus system model. The REI affected to the unit commitment of power plants which spending different fees on fuel consumptions and pollutant compensations. The REI also penetrated to the total power production, the operating cost, and the produced pollution. In addition, by considering TA's parameters, the convergence speed is quick to select the optimal solution. From these studies, the effectiveness application on the real sample system is important for future investigations and evaluations associated with existed power systems and various comparisons to previous algorithms.

REFERENCES

[1] Sunil Kumar Soni, Vijay Bhuria, "Multi-objective emission constrained economic power dispatch using differential evolution algorithm", *International Journal of Engineering and Innovative Technology*, vol. 2, no. 1, pp. 120-125, July 2012.

- [2] N Visali, M Surendranatha Reddy, M Satish kumar reddy, "Economic load dispatch of thermal power plants using differential evolution neglecting transmission losses", *International Journal of Engineering Science and Innovative Technology*, vol. 2, no. 6, pp. 145-151, November 2013.
- [3] Qin Wang, Aimin Yang, Fushuan Wen, Jihong Li, "Risk-based security-constrained economic dispatch in power systems", *J. Mod. Power Syst. Clean Energy*, vol. 1, no. 2, pp. 142-149, August 2013.
- [4] A.N. Afandi, Hajime Miyauchi, "Solving combined economic and emission dispatch using harvest season artificial bee colony algorithm considering food source placements and modified rates", *International Journal on Electrical Engineering and Informatics*, vol. 6, no. 2, pp. 266-279, June 2014.
- [5] D. C. Huynh and N. Nair, "Chaos PSO algorithm based economic dispatch of hybrid power systems including solar and wind energy sources," *2015 IEEE Innovative Smart Grid Technologies - Asia (ISGT ASIA)*, Bangkok, 2015, pp. 1-6.
- [6] H. Gangammanavar, S. Sen and V. M. Zavala, "Stochastic Optimization of Sub-Hourly Economic Dispatch With Wind Energy," in *IEEE Transactions on Power Systems*, vol. 31, no. 2, pp. 949-959, March 2016.
- [7] Z. Hasan and M. E. El-Hawary, "Economic dispatch incorporating wind energy by BH, BBO and DE," *2016 IEEE Canadian Conference on Electrical and Computer Engineering (CCECE)*, Vancouver, BC, 2016, pp. 1-6.
- [8] Afandi, A.N., "Optimal scheduling power generations using hsabc algorithm considered a new penalty factor approach", in *IEEE Conference on Power Engineering and Renewable Energy*, Bali, Indonesia, pp. 13-18, December 2014.
- [9] N. Yan, Z. X. Xing, W. Li and B. Zhang, "Economic dispatch analysis of wind power integration into power system with energy storage systems," *2015 IEEE International Conference on Applied Superconductivity and Electromagnetic Devices (ASEMD)*, Shanghai, 2015, pp. 141-142.
- [10] Srikanth Reddy K, L. K. Panwar, B. K. Panigrahi and R. Kumar, "Optimal scheduling of uncertain wind energy and demand response in unit commitment using binary grey wolf optimizer (BGWO)," *2016 IEEE Uttar Pradesh Section International Conference on Electrical, Computer and Electronics Engineering (UPCON)*, Varanasi, 2016, pp. 344-349.
- [11] Anurag Gupta, K.K. Swarnkar, Dr. S. Wadhvani, Dr.A.K.Wadhvani, "Combined economic emission dispatch problem of thermal generating units using particle swarm optimization", *International Journal of Scientific and Research Publications*, vol. 2, no. 7, pp. 1-7, July 2012.
- [12] A.N. Afandi, Fadlika I., Sulistyorini Y., "Solution of dynamic economic dispatch considered dynamic penalty factor". *The 3rd IEEE Conference on Power Engineering and Renewable Energy*, Yogyakarta, Indonesia, pp. 241 - 246. Nov 20-30, 2016.
- [13] C. Shao, X. Wang, M. Shahidehpour, X. Wang and B. Wang, "Power System Economic Dispatch Considering Steady-State Secure Region for Wind Power," in *IEEE Transactions on Sustainable Energy*, vol. 8, no. 1, pp. 268-278, Jan. 2017.
- [14] A.N. Afandi, "Optimal solution of the EPED problem considering space areas of HSABC on the power system operation." *International Journal of Engineering and Technology*, vol. 7, no. 5, pp. 1824-1830, May 2015.
- [15] M. R. Andervazh and S. Javadi, "Emission-economic dispatch of thermal power generation units in the presence of hybrid electric vehicles and correlated wind power plants," in *IET Generation, Transmission & Distribution*, vol. 11, no. 9, pp. 2232-2243, July 2017.
- [16] H. Chen, R. Zhang, G. Li, L. Bai and F. Li, "Economic dispatch of wind integrated power systems with energy storage considering composite operating costs," in *IET Generation, Transmission & Distribution*, vol. 10, no. 5, pp. 1294-1303, April 2016. [13] A.N. Afandi, Irham Fadlika, Andoko, "Comparing performances of evolutionary algorithms on the emission dispatch and economic dispatch problem", *Telkomnika*, vol 13, no 4, pp. 1187-1193, December 2015.
- [17] Bishnu Sahu, Avipsa Lall, Soumya Das, T. Manoj Patra, "Economic load dispatch in power system using genetic algorithm", *International Journal of Computer Applications*, vol. 67, no. 7, pp. 17-22, April 2013.
- [18] Afandi, A.N. "Thunderstorm algorithm for assessing thermal power plants of the integrated power system operation with an environmental requirement", *International Journal of Engineering and Technology*, vol. 8, no. 2, pp. 1102-1111, April 2016.
- [19] Arif Nur Afandi, Yunis Sulistyorini, "Thunderstorm algorithm for determining unit commitment in power system operation", *J. Eng. Technol. Sci.*, vol. 48, no. 6, pp. 743-752, 2016.
- [20] C. Barthe, M. Chong, J.-P. Pinty, C. Bovalo, and J. Escobar, "Updated and parallelized version of an electrical scheme to simulate multiple electrified clouds and flashes over large domains", *Geosci. Model Dev.*, vol. 5, no. 1, pp. 167-184, January 2012.