

Propagation speed of evanescent modes

A. Pablo L. Barbero,^{1,2} Hugo E. Hernández-Figueroa,^{1,*} and Erasmo Recami^{3,4,†}

¹*DMO, FEEC, Universidade Estadual de Campinas, Campinas, SP, Brazil*

²*TET, CTC, Universidade Federal Fluminense, RJ, Brazil*

³*CCS and DMO/FEEC, Universidade Estadual de Campinas, SP, Brazil*

⁴*Facoltà di Ingegneria, Università Statale di Bergamo, Dalmine, BG, Italy and INFN, Sezione di Milano, Milan, Italy*

(Received 23 July 1999; revised manuscript received 6 March 2000)

The group velocity of evanescent waves (in undersized waveguides, for instance) was theoretically predicted, and has been experimentally verified, to be superluminal ($v_g > c$). By contrast, it is known that the precursor speed in vacuum cannot be larger than c . In this paper, by computer simulations based on Maxwell equations only, we show the existence of both phenomena. In other words, we verify the actual possibility of superluminal group velocities, without violating the so-called (naive) Einstein causality.

PACS number(s): 03.50.De, 84.40.Az, 41.20.Jb, 73.40.Gk

I. INTRODUCTION

A series of recent experiments, performed at Cologne [1], Berkeley [2], Florence [3], and in other places [4], revealed that evanescent waves seem to travel with a superluminal group velocity ($v_g > c$). This originated a lot of discussion, since it is known, on the other hand, that the speed of the precursors cannot be larger than c . For instance, the existence of Sommerfeld's and Brillouin's precursors (the so-called first and second precursors) has been recently stressed in Refs. [5], while studying the transients in metallic waveguides.

In this paper we would like to address simultaneously both such problems, relevant for the understanding of the propagation of a signal; namely, the question of the (superluminal) value of v_g in the evanescent case, and the question of the arrival time of the transients (which implies a nonviolation of the so-called Einstein causality).

From a historical point of view, let us recall that for a long time the topic of the electromagnetic wave propagation velocity was regarded as already settled down by the works of Sommerfeld [6] and Brillouin [7]. Some authors, however, studying the propagation of light pulses in anomalous dispersion (absorbing) media both theoretically [8] and experimentally [9], found their envelope speed to be the group velocity v_g , even when v_g exceeds c , equals $\pm\infty$, or becomes negative. In the meantime, evanescent waves were predicted [10] to be faster-than-light just on the basis of special relativistic considerations.

But evanescent waves in suitable ("undersized") waveguides, in particular, can be regarded also as tunnelling photons [11], due to the known formal analogies [12] between the Schrödinger equation in presence of a potential barrier and the Helmholtz equation for a wave-guided beam. And it was known since long that tunneling particles (wave packets) can move with superluminal group velocities inside opaque barriers [13]; therefore, even from the quantum theoretical point of view, it was expected [13,11,10] that evanescent waves could be superluminal.

In Sec. II of this paper we shall first show how the first electric perturbation, reaching any point P , always travels with the speed c of light in vacuum, *independently of the medium*. Some comments will be added about the instant of appearance, and the behavior in time, of the Sommerfeld's and Brillouin's precursors. The results of a computer simulation will be presented for free propagation in a dispersive medium, with the precursors arriving before the (properly said) signal.

In Sec. III, however, we shall deal by further computer simulations (always based on Maxwell equations only) with evanescent guided waves, showing their group velocity to be superluminal.

Finally, in Secs. IV and V we shall deal with the transients associated with superluminal evanescent waves: a study that, to our knowledge, was not carried on in the past.

II. PRECURSORS AND CAUSALITY

Every perturbation passes through a transient state before reaching the stationary regime. This happens also when transmitting any kind of wave. In the case of electromagnetic waves, such a transient state is associated with the propagation of precursors, arriving before the principal signal. This fact seems to be enough to satisfy the requirements of the naive "Einstein causality."

In particular, when investigating the *free* propagation of an electromagnetic wave, in a dispersive medium with resonances in correspondence with some discrete angular frequencies ω_j , we can easily observe the arrival of the first and second precursors, followed by the arrival of the properly said signal. Let us consider for instance the motion in the z direction of a harmonic beam, such that at $z=0$ one has

$$f(0,t) = \frac{1}{2\pi} \int_{\gamma-i\infty}^{\gamma+i\infty} \frac{e^{i\omega t}}{s+i\omega} ds = e^{i\omega t} \quad \text{for } t \geq 0 \quad (1)$$

and $f(0,t)=0$ for $t < 0$; where s is the complex integration variable, and $\gamma > 0$ in order that the function be transformable. Let us then consider a dispersive medium whose dielectric constant ε (electric permittivity) as a function of ω is

*Email address: hugo@dmo.fee.unicamp.br

†Email address: recami@mi.infn.it

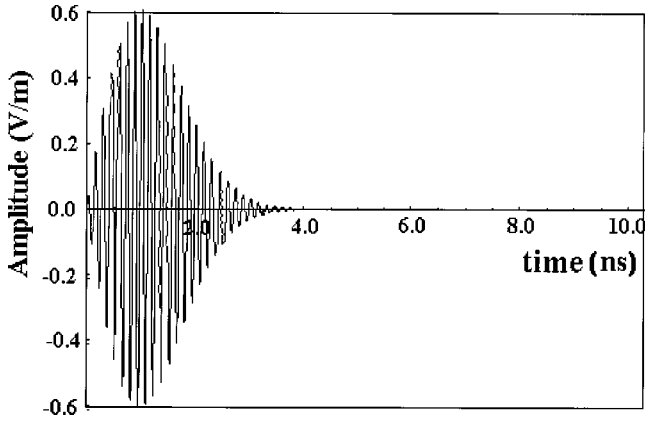

FIG. 1. The electric field at $z=0$ as a function of time (in ns), for $\omega=7$ GHz (see the text).

$$\varepsilon(\omega) = 1 + \sum_{j=0}^N \frac{a_j^2}{s^2 + sg_j + \bar{\omega}_j^2}. \quad (2)$$

In the present model (initially proposed by Maxwell himself) a_j is proportional to the number of oscillators per unit volume, g_j is the dissipation constant (due to molecular collisions) and $\bar{\omega}_j^2 \equiv \omega_j^2 - (1/3)a_j^2$, quantity ω_j being the j th resonant angular frequency [14]. The wave equation

$$\frac{\partial^2 f}{\partial z^2} - \frac{\varepsilon}{c^2} \frac{\partial^2 f}{\partial t^2} = 0$$

admits solutions of the form $\exp[s(t - \beta z/c)]$, with $\beta = \beta(\omega) = \sqrt{\varepsilon(\omega)}$, so that we can write (for γ and t positive)

$$f(z, t) = \frac{1}{2\pi} \int_{\gamma - i\infty}^{\gamma + i\infty} \frac{\exp[s(t - \beta z/c)]}{s + i\omega} ds. \quad (3)$$

Since $\beta(\omega) \rightarrow 1$ when $s \rightarrow \pm\infty$, one has to distinguish the case $t - z/c < 0$ from the case $t - z/c > 0$. In the former, the integration path in the complex plane can be closed along an infinite-radius semicircle on the right side, where no singularities exist, and the integral yields zero. In other words, one gets $f(z, t) = 0$ for $t < z/c$, in agreement with Einstein causality. In the latter case, to look for the mentioned precursors, one has to evaluate expression (3) for $t - z/c > 0$; this can be accomplished by applying the stationary phase [15] method (which provides an illuminating under-

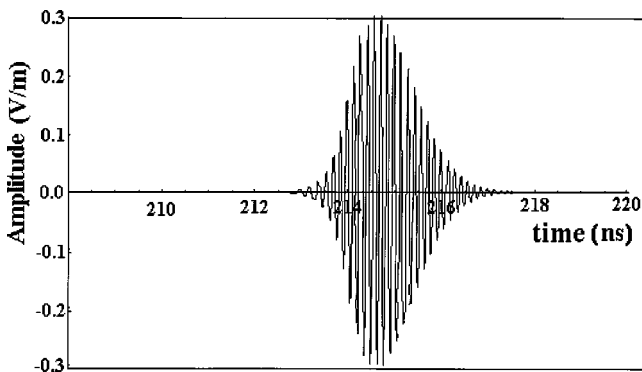

FIG. 2. The same electric field considered in Fig. 1, after having traveled 63 m in a medium characterized by Eq. (2').

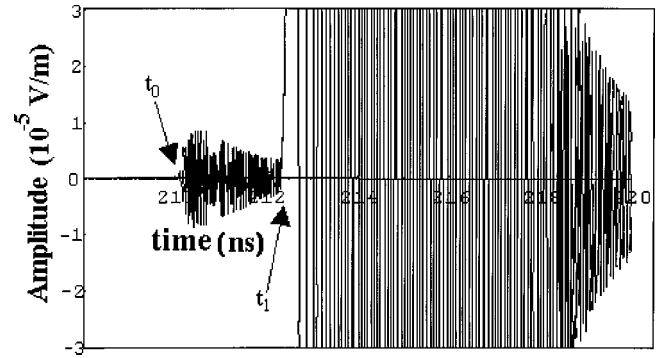

FIG. 3. Same as Fig. 2, with the vertical scale magnified by a factor 10^4 . The Sommerfeld and Brillouin precursors start arriving at times t_0 and t_1 , respectively.

standing of the question), following, e.g., Brillouin's [7] and Jackson's [16] books. For example, the first precursor starts arriving at $t = z/c$ as a very high frequency disturbance which grows in amplitude but decreases in frequency with time. Its amplitude, after the maximum, decreases till the arrival of the second precursor, which, when there is only a resonance ($j=0$) at $\omega = \omega_0$, and $g=0$, starts at time $t = z\sqrt{(\bar{\omega}_0^2 + a^2)/\bar{\omega}_0^2}/c$, reaches a maximum, and then decreases, while the oscillation angular frequency tends to the initial excitation angular frequency ω which enters Eq. (1). The properly said signal arrives afterwards (independently of the medium).

If we go on to consider, however, nonfree propagation (in the vacuum) inside a wave guide, when a cutoff angular frequency ω_c enters the play, the stationary phase method application is restricted by the fact that the propagation constant $\beta(\omega) = \omega\sqrt{1 - (\omega_c/\omega)^2}/c$ becomes imaginary for $\omega < \omega_c$. Nevertheless, if the beam contains also above-cutoff spectral components, then the first precursor evaluation, which depends only on the highest frequencies, are still possible, as shown, e.g., by Stenius and York [5]. We shall discuss such problems in the next section.

Here, let us just simulate the free propagation of an electromagnetic field in a medium described by Eq. (2) with $j=0$, i.e., described by

$$\varepsilon(\omega) = 1 + \frac{a_0^2}{\bar{\omega}_0^2 - \omega^2 - i\omega g_0}, \quad (2')$$

with $a_0 = 2.2 \times 10^{10}$, $\omega_0 = 4.4\pi \times 10^{10}$, and $g_0 = -10^9$. Let us assume the electric field at $z=0$ to be $f(0, t)$

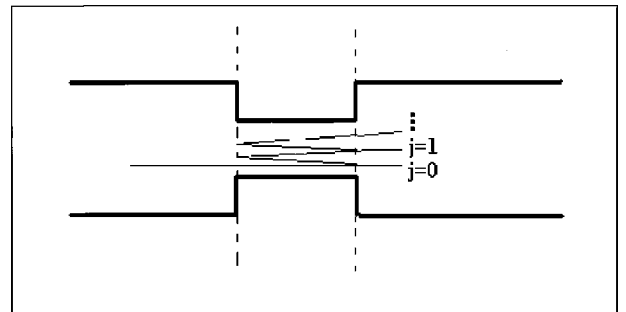

FIG. 4. A waveguide with a segment of "photonic barrier," i.e., of undersized waveguide (evanescence region).

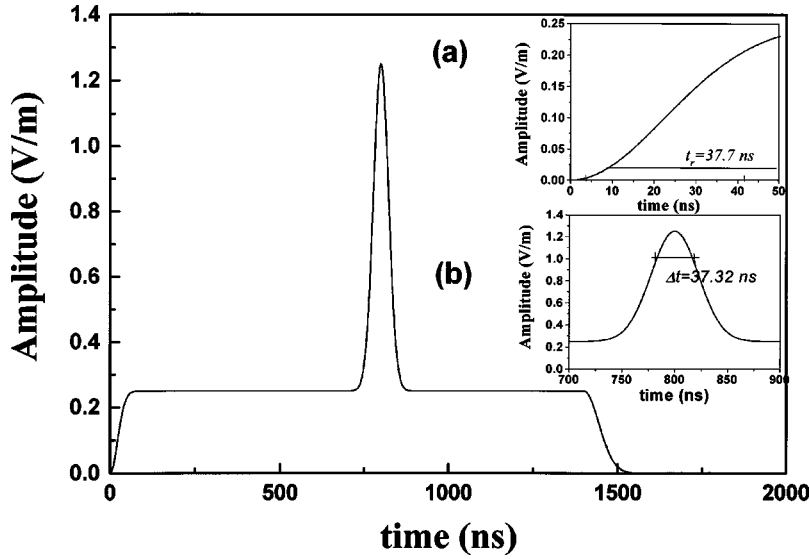

FIG. 5. Envelope of a Gaussian signal (centered at $t_m = 800.00$ ns, with width $\Delta t = 37.32$ ns) obtained by amplitude modulation of a carrier wave. We assume the carrier wave to be switched on at time $t = 0$; inset (a) shows the rise time, $t_r = 37.70$ ns, of the carrier amplitude (for increasing from 10% to 90% of its stationary value).

$= At \exp[-at^2] \sin(\omega t)$ with $A = 10^9$ and $a = 5 \times 10^{17}$. Figure 1 shows such a function of time (in ns) for $\omega = 7$ GHz. The calculations then yield, for $z = 63$ m, the electric field in Fig. 2. For evidencing the Sommerfeld and Brillouin precursors, it is necessary to magnify the vertical scale by a factor 10^4 : see Fig. 3, where the horizontal axis is still the time axis (in ns). Figure 3 shows that the electric perturbation starts at $t = 210$ ns, corresponding to the time needed to travel 63 m with speed c , when the first precursor starts arriving at z as a very high frequency field [in fact, the stationary phase method expects that immediately after $t = z/c$ only the highest frequency components contribute to the integral (3)]. The second precursor starts reaching z at $t \approx 212.6$ ns, in perfect agreement, again, with the stationary phase solution. Afterwards, the field angular frequency tends to $\omega = 7$ GHz (stationary regime) and the properly said signal starts arriving.

III. PROPAGATION BELOW THE CUTOFF FREQUENCY

Let us come to the point we are more interested in, i.e., to the propagation in waveguides of pulses obtained by amplitude modulation of a carrier wave endowed with an under-cutoff frequency; and let us recall that the experiments, for instance, in Refs. [1–4], did actually detect in such a case a superluminal group-velocity, $v_g > c$ (in agreement with the classical [10] and the quantum [13] predictions).

For example, the work in Refs. [1,17] put in particular evidence the fact that the segment of “undersized” (operating with under-cutoff frequencies) waveguide provokes an attenuation of each spectral component, without any phase variation. More precisely, the unique phase variation detectable is due to the discontinuities in the waveguide cross section (cf. also Refs. [13]). Mathematically [18], the spectrum leaving an undersized waveguide segment (or *photonic barrier*) is simply the entering spectrum multiplied by the transfer function $H(\omega) = \exp[i\beta L]$, with $\beta(\omega) = \omega \sqrt{1 - (\omega_c/\omega)^2}/c$. For $\omega > \omega_c$, the propagation constant $\beta(\omega)$ is real, and $H(\omega)$ represents a phase variation to be added to the outgoing spectrum. However, for $\omega < \omega_c$, when $\beta(\omega)$ is imaginary, the transfer function just represents an additional attenuation of the incoming spectrum.

In a sense, the two edges of a “barrier” (undersized waveguide segment: see Fig. 4) can be regarded as semi-mirrors of a Fabry-Pérot configuration. The consequent negative interference processes can lead themselves to superluminal transit times. These points have been exploited, e.g., by Japha and Kurizki [19] (who claimed the barrier transit mean-time to be superluminal provided that the coherence time τ_c of the entering field $\psi_{in}(t)$ is much larger than L/c).

IV. OUR NUMERICAL EXPERIMENTS

As already mentioned, to investigate the interplay between Einstein causality and the fact that $v_g \gg c$ when a signal is transported in a metallic waveguide by a carrier wave with $\omega_w < \omega_c$, one has to examine simultaneously the effects mentioned in Secs. II and III.

Let us consider a signal obtained by a pulse-shaped amplitude modulation of a carrier-wave with frequency f_w (in Fig. 5 the envelope of the wave is shown). Let us assume that the carrier-wave is switched on at time $t = 0$, so that at the (undersized) waveguide entrance ($z = 0$) the field will be $f(0, t) = 0$ for $t < 0$. The amplitude of the carrier wave will reach a stationary state soon after the rise-time instant, t_r (here defined as the time requested for the carrier amplitude to increase from 10% to 90% of its stationary value). A (smoothly prepared) Gaussian pulse, with width Δt , is centered at $t = t_m$, ($t_m > t_r$). At time $t = t_d$, ($t_d > t_m + \Delta t$), the carrier wave is switched off (and its amplitude will decrease

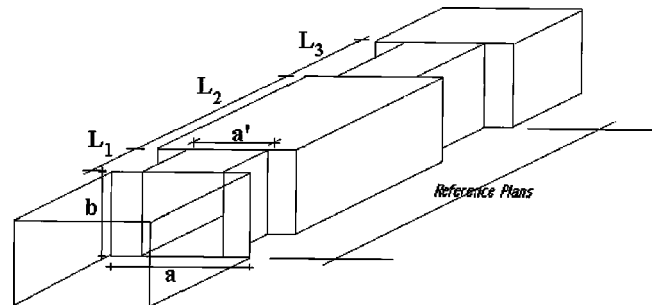

FIG. 6. The second experimental setup considered for our simulations.

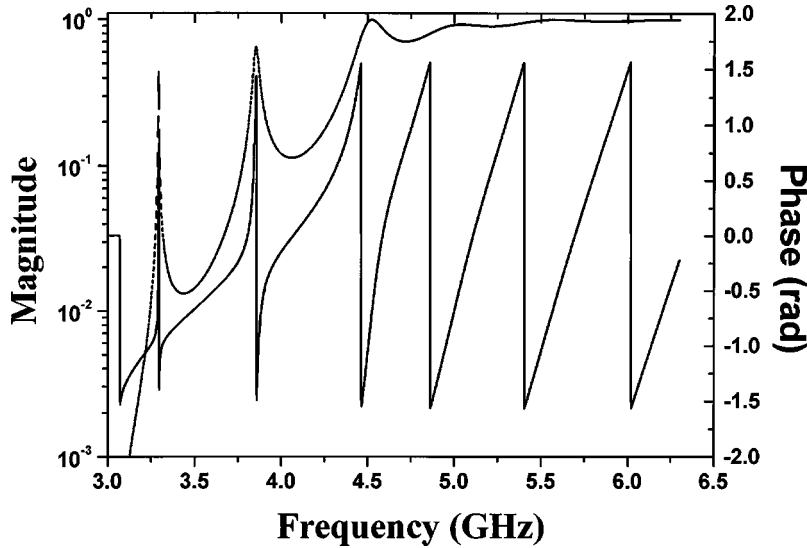

FIG. 7. The transfer function corresponding to the setup in Fig. 6. Its magnitude and phase are represented by the pointed and solid lines, respectively. Notice that the intervals in which the phase derivative is lower coincide with the dips of the magnitude.

in a time of the order of t_r). Wishing to reveal the precursors too, it is important to use values of t_r smaller than 100 ps (so to excite the higher frequency components with enough power). It is important, as well, to use a spectrally narrow pulse ($\Delta\omega \ll \omega_w$), so that one can go on calculating the group velocity via the standard relation $v_g = \partial\omega/\partial\beta$.

A spectrally narrow pulse, moreover, allows us to examine the *double barrier* experiment [20], i.e., the most interesting configuration, without making recourse to external filters. The setup is shown in Fig. 6; the *two* photonic barriers are segments of undersized waveguide 25 and 50 mm long, respectively, with cross section $23.45 \times 34.85 \text{ mm}^2$ and cutoff frequency 4.304 GHz. Between them, there is another segment, 101 mm long, of “normal-sized” waveguide, with cross section $23.45 \times 48.85 \text{ mm}^2$ and cutoff frequency 3.07 GHz. The transfer function, illustrated in Fig. 7, was calculated by using a Fortran program [21] based on the method of moments (MoM), while the mode decomposition was performed in terms of even modes TE_{m0} , with m an odd number. As usual, the outgoing spectrum was evaluated by multiplying the incoming spectrum (Fig. 5) by the transfer function, that is to say by use of the inverse Fourier trans-

form (within the software package MATHEMATICA 2.2.3). It was chosen a carrier-wave with frequency $f_w = 3.574 \text{ GHz}$, corresponding to a minimum of $\partial\phi/\partial\nu$, where ϕ is the transfer-function phase. Let us recall that the magnitude of the transfer function for this frequency is the attenuation suffered by the electromagnetic wave along the two photonic barriers. The outgoing electric signal is shown in Fig. 8; in its inset (a) one can see the exact arrival time $t = 0.5812 \text{ ns}$, at the exit interface, of the *first* electric disturbance (such an instant differing of about 1% from the one, $t = L/c \approx 0.587 \text{ ns}$, predicted in Sec. II, since in our simulation we had of course to use a finite “sample interval,” of 15.26 ps, corresponding to a subdivision of our 2000 ns numerical time window into 131 072 steps). In inset (b) we see the entering Gaussian pulse, initially modulated and centered at $t = 800 \text{ ns}$.

In Fig. 9(a) the pulse peak is represented in more detail. From its arrival time, $t \approx 800.24 \text{ ns}$ we can derive the (*superluminal*) group-velocity $v_g = (176/0.24) \text{ mm/ns} \approx 7.33 \times 10^8 \text{ m/s} \approx 2.44c$. If we want to evaluate the group-velocity by the relation $v_g = \partial\omega/\partial\beta$, we get (all the derivatives being evaluated at the frequency f_w of the carrier wave)

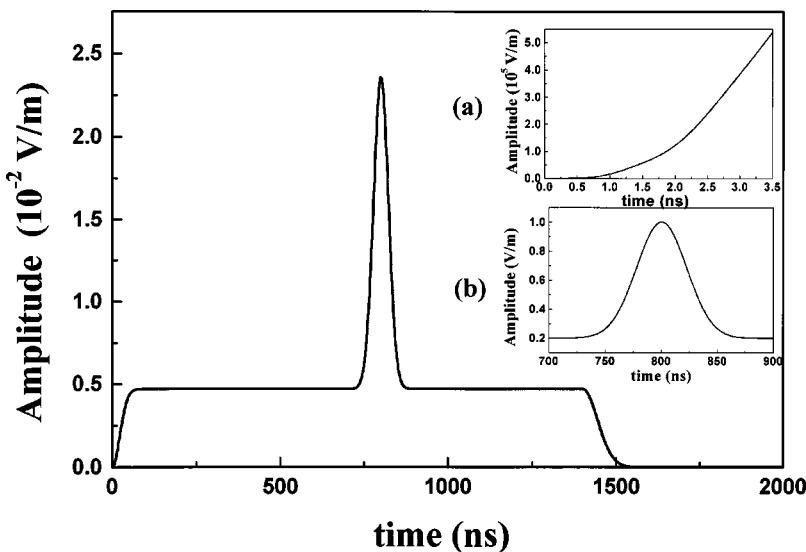

FIG. 8. Aspect of the signal in Fig. 5, after having propagated through the setup in Fig. 6. Inset (a) shows the arrival time of its initial part.

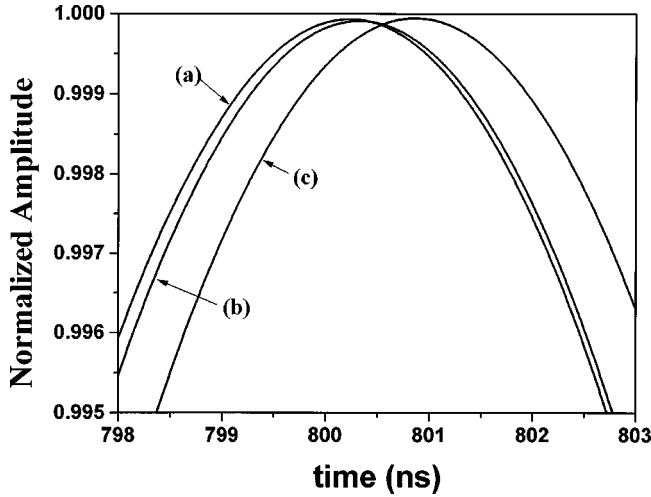

FIG. 9. Detailed representation of the signal peak, after propagation through the setup in Fig. 6 with different lengths L_2 of the intermediate (“normal-sized”) waveguide and with different carrier frequencies f_w : (a) $L_2=101$ mm, and 5.574 GHz; (b) $L_2=501$ mm, and 3.5795 GHz; (c) again $L_2=101$ mm, but $f_w=5.58945$ GHz.

$$v_g = \left. \frac{\partial \omega}{\partial \beta} \right|_{f_w} = 2\pi \left. \frac{\partial \nu}{\partial \beta} \right|_{f_w} = \frac{2\pi}{\frac{1000}{176} \left. \frac{\partial \phi}{\partial \nu} \right|_{f_w}} \approx 2.48 c, \quad (4)$$

in very good agreement with the previous value (their difference being smaller than 2%). In the previous simulation we used a pulse half-width $\Delta \nu=12$ MHz, so that, as required, $\Delta \nu/f_w \approx 0.0034 \ll 1$.

Notice that the 0.24 ns spent by the pulse inside the setup of Fig. 6 is due to the wave phase variation caused by the geometric discontinuities existing between the different waveguide segments which compose the analyzed setup (mainly the leading edges of the barriers): we shall come back to this point. One can therefore expect [22] such a transit time to be *independent* not only of the length of the barriers (Hartman effect: see Refs. [13]), but even of the length of the “normal” waveguide inserted between the two

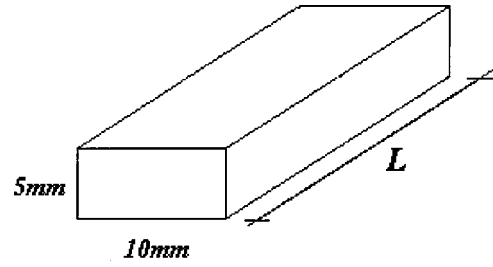

FIG. 10. The new (indefinite) *undersized* waveguide considered in our final simulations, when eliminating any geometric discontinuity in its cross section. We chose $L=32.96$ mm.

barriers. This has been experimentally verified [20], and constitutes the most interesting fact revealed by Refs. [1,17,20]. We repeated our computer simulation for the same setup depicted in Fig. 6, when inserting between the undersized waveguides (barriers) a segment of “normal” waveguide 501 mm (instead of 101 mm) long; with a new, suitable choice of the carrier frequency ($f_w=3.5795$ GHz). The new pulse can be seen in Fig. 9(b). The delay (transit time) resulted to be 0.336 ns, corresponding to a *higher (superluminal)* group-velocity, $v_g=(576/0.336)$ mm/ns $\approx 17.14 \times 10^8$ m/s $\approx 5.71c$. Again, by using the standard definition, we obtain the very close value

$$v_g = \left. \frac{\partial \omega}{\partial \beta} \right|_{f_w} \approx 5.91 c, \quad (4')$$

their difference being less than 3.4%. Let us notice that the considered setup (Fig. 6) works as a Fabry-Pérot filter, so that, when the length L_2 of the intermediate (“normal-sized”) waveguide increases, the usable band width decreases. Of course, if we had chosen a carrier frequency outside the suited intervals, e.g., $f_w=5.58945$ GHz (*nonevanescence* case), we would have got a subluminal group velocity. In fact, our calculations yield in this case that the outgoing pulse [see Fig. 9(c)] is centered at $t=0.977$ ns, corresponding to the group-velocity $v_g=(176/0.977)$ mm/ns $\approx 0.6c$.

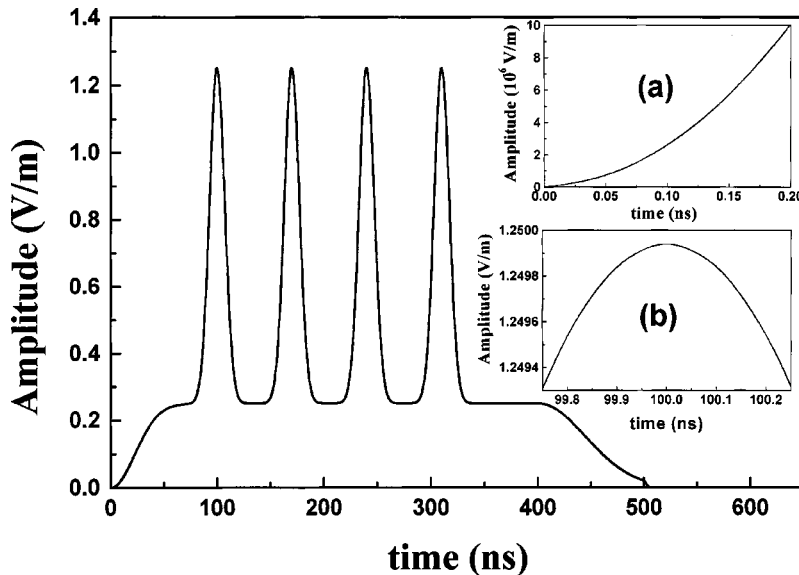

FIG. 11. Envelope of the initial signal, considered in our simulation for signal propagation through the new setup in Fig. 10. Inset (a) shows in detail the initial part of this signal as a function of time, while inset (b) shows the Gaussian pulse peak centered at $t=100$ ns.

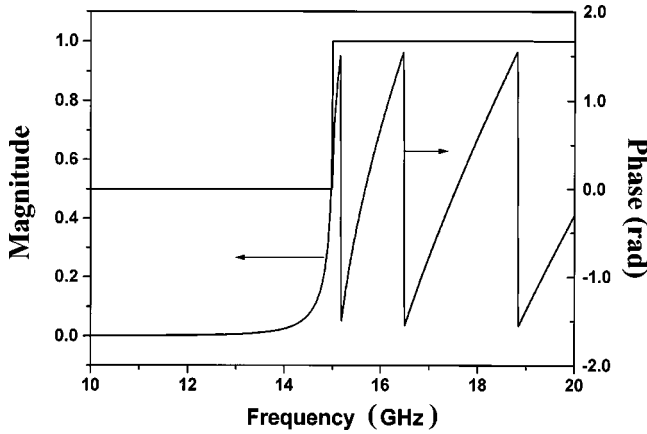

FIG. 12. The transfer function corresponding to the new setup in Fig. 10. Its magnitude and phase are represented by lines associated with the left-pointing and the right-pointing arrow, respectively.

V. THE CASE OF AN INFINITE UNDERSIZED WAVEGUIDE

Let us stress once more that all the delays (nonzero transit times) found above, in our simulations of experiments, depend only on the phase variation suffered by the wave because of the geometric discontinuities in the waveguide. Actually, as already mentioned, the propagation constant $\beta(\omega)$ is imaginary for the under-cutoff frequencies, so that the transfer function $H(\omega)$ works only as an attenuation factor for such (evanescent) frequencies. However, the higher (non-evanescent) frequencies will be phase shifted, in such a way that $\beta(\omega)$ will tend to its free-space value ω/c for $\omega \rightarrow \infty$. In other words, the higher spectral components travel with speed c ; they are responsible both for the finite speed of the evanescent beams, and for the appearance of the precursors. [In the (theoretical) case in which a pulse has been constituted by under-cutoff frequencies only, the situation could therefore be rather different.]

Anyway, let us eliminate the effect of the geometric discontinuities just by considering an electromagnetic *signal* which is already propagating inside an undersized waveguide, and traveling between two parallel cross sections separated by the distance L . The waveguide size is 5

$\times 10 \text{ mm}^2$, and $L = 32.96 \text{ mm}$ (cf. Fig. 10). The entering signal envelope is shown in Fig. 11 as a function of time; the (smoothly prepared) Gaussian pulses are centered at $t_m = 100, 170, 240,$ and 300 ns , respectively. In inset (a) the initial part (in time) of the mentioned envelope is shown, while in inset (b) one can see the peak of the Gaussian pulse centered at 100 ns . After having traveled the considered distance L through the undersized waveguide (characterized by the transfer function depicted in Fig. 12), the evanescent signal arrives with the envelope shown in Fig. 13. The shape is essentially the same [cf. also inset (b) of Fig. 13], even if the amplitude is of course reduced. In inset (a) of Fig. 13 one can see the *initial* part (in time) of the transmitted signal, arriving after 109.87 ps , which is exactly the time needed to travel 32.96 mm with the speed c of light in vacuum. However, by comparing insets (b) of Figs. 11 and 13, one deduces that the pulses traveled with *infinite* group velocity, since the transmission of the pulse peaks required zero time (instantaneous transmission).

It is interesting also to analyze the spectra of the entering (Fig. 14) and arriving (Fig. 15) signal. Figure 14 shows the Fourier transform of the signal presented in Fig. 11, when it modulates in amplitude a carrier wave with frequency 14.5 GHz . In the insets of Figs. 14 and 15, we show the signal spectrum after magnifying the vertical scale by a factor 3×10^4 ; we can notice that the arriving signal possesses a spectral component (approximately centered at 15 GHz) that was not present in the entering spectrum: such a new component corresponds to the waveguide cutoff value, 15 GHz in this case. After the transients, the real signal arrives, with a superluminal (even infinite) group velocity.

VI. CONCLUSIONS

At this point, one can accept that a signal is really carried (not by the precursors, but) by well-defined amplitude bumps, as in the case of information transmission by the Morse alphabet, or the transmission of a number, e.g., by a series of equal (and equally spaced) pulses. In such a case, we saw above that the signal can travel even at infinite speed, in the considered situations. It is important also to notice, when comparing Fig. 13 with Fig. 11, that the width of the

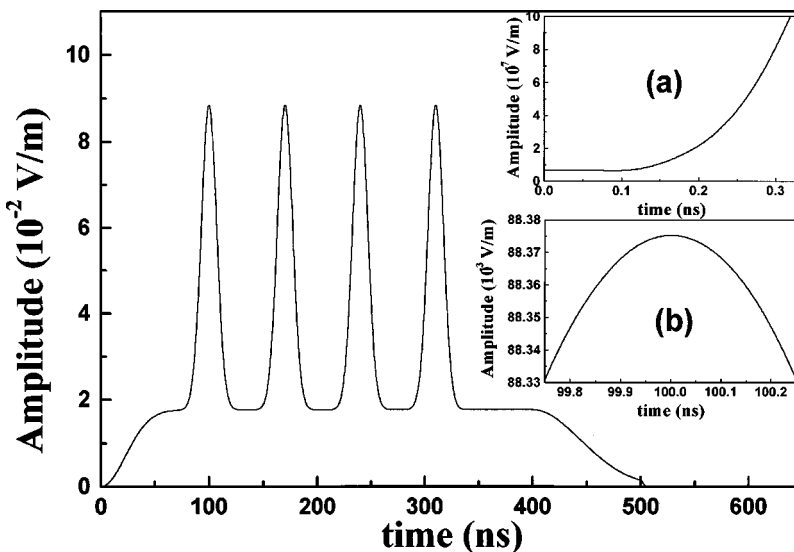

FIG. 13. Envelope of the signal in Fig. 11 after having propagated through the undersized waveguide in Fig. 10. Inset (a) shows in detail the initial part (in time) of such arriving signal, while inset (b) shows the peak of the Gaussian pulse that had been initially modulated by centering it at $t = 100 \text{ ns}$ (one can see that its propagation took *zero* time).

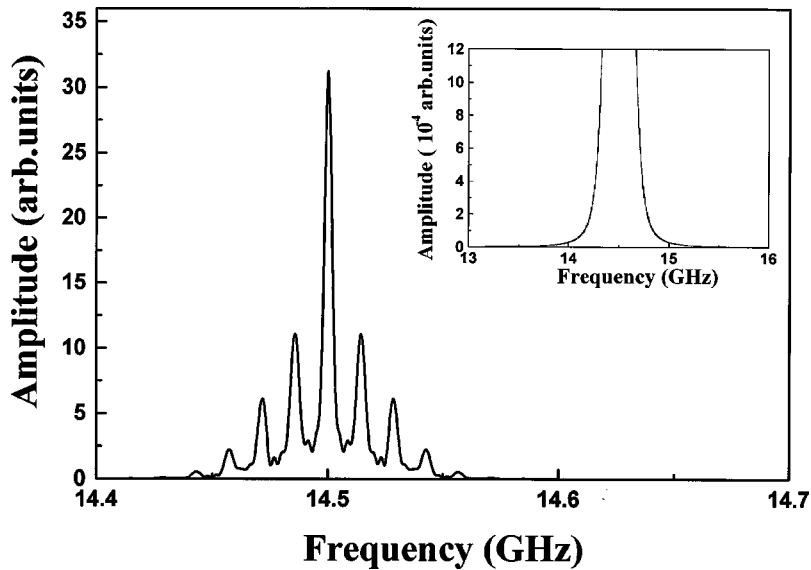

FIG. 14. Spectrum of the entering signal. In the inset, the vertical scale was magnified 3×10^4 times.

arriving pulses does not change with respect to the initial ones. The signal, however, cannot overcome the transients, “slowly” traveling with speed c .

Even if the AM signal were totally constituted by under-cutoff frequencies, when the experiment is started (e.g., by switching on the carrier wave) one does necessarily meet a transient situation, which generates precursors.

One might think, therefore, of arranging a setup (permanently switched on) for which the precursors are sent out long in advance, and waiting afterwards for the moment at which the need arises of transmitting a signal with superluminal speed (without violating the naive “Einstein causality,” as far as it requires only that the precursors do not travel at speed higher than c). Some authors, as the ones in Refs. [1,17,20], do actually claim that they can build up (smooth) signals by means of under-cutoff frequencies only, *without generating further precursors*: in such a case one would be in presence, then, of superluminal information transmission.

However, on the basis of our calculations (which imply the existence also of above-cutoff frequencies in any signal: cf. the inset of Fig. 14) this does not seem to be true in

practice. If, in reality, to start sending out a signal means to create some discontinuities (i.e., to generate new precursors), and if the signal cannot bypass the precursors (even when the carrier was switched on long in advance), then information could not be transmitted faster than light by the experimental devices considered above, in spite of the fact that evanescent signals travel with Superluminal group velocity.

Such critical issues deserve further investigation, and we shall come back to them elsewhere (for instance, a problem is whether one must already know the whole information content of the signal when *starting* to send it; in such a case, it would become acceptable the mathematical trick of representing any signal by an analytical function [23]). But we have seen that, in any case, the evanescent modes travel for some distance with faster-than-light speed; and at least in three further sectors of experimental physics superluminal motions *might* have been already observed [24]. Therefore, it is worthwhile to recall here, in this regard, that special relativity *itself* can, and was, extended [25] to include also superluminal motions on the basis of its *ordinary* postulates; solving seemingly also the known causal paradoxes [26] associated in the past with tachyonic motions.

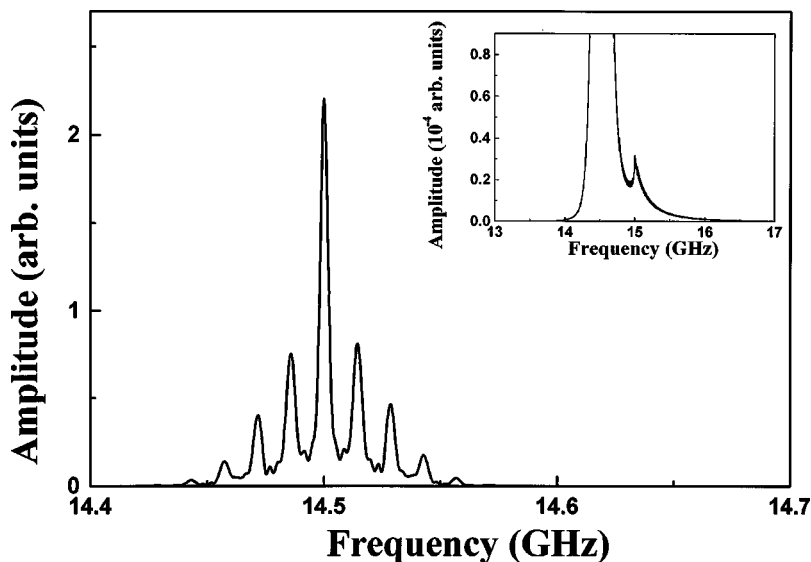

FIG. 15. Spectrum of the arriving signal. From the inset, where the vertical scale was again magnified by the factor 3×10^4 , one can notice the appearance of a new spectral component at 15 GHz.

ACKNOWLEDGMENTS

We thank the Antennas Group of the Telebrás Research Center in Campinas, SP, Brazil, for allowing us to use their MoM code. For stimulating discussions, we are grateful to F. Bassani, C. Becchi, R. Bonifacio, R. Chiao, R. Colombi, A. Del Popolo, F. Fontana, R. Garavaglia, D. Jaroszynski, L. C.

Kretly, G. Kurizki, G. Marchesini, G. Nimtz, R. Petronzio, M. Pignanelli, G. Privitera, A. Shaarawi A. Steinberg, J. W. Swart, J. Vaz, and M. Zamboni-Rached; and, for kindly providing us with constant computer assistance, we thank also Professor Y. Akebo and Rodrigo L. Anami, Adriano Domingos, Víталy F. Rodrigues, and Janette Toma. This work was partially supported by CAPES, and by INFN, MURST, and CNR.

-
- [1] A. Enders and G. Nimtz, *J. Phys. I* **2**, 1693 (1992); **3**, 1089 (1993); *Phys. Rev. E* **48**, 632 (1993); G. Nimtz, A. Enders, and H. Spieker, *J. Phys. I* **4**, 1 (1994); W. Heitmann and G. Nimtz, *Phys. Lett. A* **196**, 154 (1994); G. Nimtz, *Phys. Bl.* **49**, 1119 (1993); in *Tunneling and its Implications* (World Scientific, Singapore, in press); G. Nimtz and W. Heitmann, in *Advances in Quantum Phenomena*, edited by E. G. Beltrametti and J.-M. Lévy-Leblond (Plenum, New York, 1995), p. 185; *Prog. Quantum Electron.* **21**, 81 (1997); H. Aichmann and G. Nimtz (unpublished). See also Refs. [20]. [Nimtz *et al.* also made some computer simulations (on the basis of Maxwell equations), well reproducing the related experimental results: see Ref. [17].]
- [2] A. M. Steinberg, P. G. Kwiat, and R. Y. Chiao, *Phys. Rev. Lett.* **71**, 708 (1993); R. Y. Chiao, P. G. Kwiat, and A. M. Steinberg, *Sci. Am.* **269**(2), 38 (1993). Cf. also A. M. Steinberg and R. Y. Chiao, *Phys. Rev. A* **51**, 3525 (1995); P. G. Kwiat *et al.*, *ibid.* **48**, R867 (1993); E. L. Bolda *et al.*, *ibid.* **48**, 3890 (1993).
- [3] A. Ranfagni, P. Fabeni, G. P. Pazzi, and D. Mugnai, *Phys. Rev. E* **48**, 1453 (1993). Cf. also *Appl. Phys. Lett.* **58**, 774 (1991).
- [4] Ch. Spielmann, R. Szpoc, A. Stingl, and F. Krausz, *Phys. Rev. Lett.* **73**, 2308 (1994); Ph. Balcou and L. Dutriaux, *ibid.* **78**, 851 (1997); V. Laude and P. Tournois, *J. Opt. Soc. Am. B* **16**, 194 (1999).
- [5] See, e.g., P. Stenius and B. York, *IEEE Antennas Propag. Mag.* **37**, 39 (1995). Cf. also S. L. Dvorak, *IEEE Trans. Microwave Theory Tech.* **42**, 2164 (1994).
- [6] A. Sommerfeld, *Z. Phys.* **8**, 841 (1907).
- [7] L. Brillouin, *Ann. Phys. (Leipzig)* **44**, 203 (1914); *Wave Propagation and Group Velocity* (Academic, New York, 1969).
- [8] C. G. B. Garrett and D. E. McCumber, *Phys. Rev. A* **1**, 305 (1970).
- [9] S. Chu and S. Wong, *Phys. Rev. Lett.* **48**, 738 (1982). See also M. W. Mitchell and R. Y. Chiao, *Phys. Lett. A* **230**, 133 (1997).
- [10] Cf., e.g., pp. 158, and 116–117, in E. Recami, *Riv. Nuovo Cimento* **9**(6), 1 (1986), and references therein; see also E. Recami, F. Fontana, and R. Garavaglia, *Int. J. Mod. Phys. A* **15**, 2793 (2000), where, e.g., the group velocity of evanescent waves is properly defined.
- [11] S. Bosanac, *Phys. Rev. A* **28**, 577 (1983).
- [12] See, e.g., Th. Martin and R. Landauer, *Phys. Rev. A* **45**, 2611 (1992); R. Y. Chiao, P. G. Kwiat, and A. M. Steinberg, *Physica B* **175**, 257 (1991); A. Ranfagni, D. Mugnai, P. Fabeni, and G. P. Pazzi, *Appl. Phys. Lett.* **58**, 774 (1991). See also A. M. Steinberg, *Phys. Rev. A* **52**, 32 (1995).
- [13] See V. S. Olkhovsky and E. Recami, *Phys. Rep.* **214**, 339 (1992), and references therein; in particular, T. E. Hartman, *J. Appl. Phys.* **33**, 3427 (1962); J. R. Fletcher, *J. Phys. C* **18**, L55 (1985); F. E. Low and P. F. Mende, *Ann. Phys. (N.Y.)* **210**, 380 (1991); V. S. Olkhovsky, E. Recami, F. Raciti, and A. K. Zaichenko, *J. Phys. I (France)* **5**, 1351 (1995); D. Mugnai *et al.*, *Phys. Lett. A* **209**, 227 (1995).
- [14] See, e.g., A. Stratton, *Electromagnetic Theory* (McGraw-Hill, New York, 1941), p. 322.
- [15] E. P. Wigner, *Phys. Rev.* **98**, 145 (1955).
- [16] D. Jackson, *Classical Electrodynamics* (Wiley, New York, 1975).
- [17] H. M. Brodowsky, W. Heitmann, and G. Nimtz, *Phys. Lett. A* **222**, 125 (1996).
- [18] M. Schwartz, *Information Transmission, Modulation and Noise* (McGraw-Hill, New York, 1970).
- [19] Y. Japha and G. Kurizki, *Phys. Rev. A* **53**, 586 (1996). Cf. also G. Kurizki, A. Kozhekin, and A. G. Kofman, *Europhys. Lett.* **42**, 499 (1998); G. Kurizki, A. E. Kozhekin, A. G. Kofman, and M. Blaauboer, presented at the VII Seminar on Quantum Optics, Raubichi, BELARUS, 1998 (unpublished).
- [20] G. Nimtz, A. Enders, and H. Spieker, *J. Phys. I* **4**, 565 (1994); in *Wave and Particle in Light and Matter—Proceedings of the Trani Workshop, Italy, 1992*, edited by A. van der Merwe and A. Garuccio (Plenum, New York, 1993); A. Enders and G. Nimtz, *Phys. Rev. B* **47**, 9605 (1993).
- [21] Numerical code developed by the Antennas Group of the Telebrás Research Center, Campinas, SP, Brazil.
- [22] J. Jakiel, V. S. Olkhovsky, and E. Recami, *Phys. Lett. A* **248**, 156 (1998); V. S. Olkhovsky, E. Recami, and J. Jakiel (unpublished); V. S. Olkhovsky and A. Agresti, in *Tunneling and its Implication*, edited by D. Mugnai, A. Ranfagni, and L. S. Schulman (World Scientific, Singapore, 1997), pp. 327–355; V. S. Olkhovsky, *Fiz. Zhivogo (Physics of the Alive)* **5**, 19 (1997); V. S. Olkhovsky, E. Recami, and G. Salesi, LANL Report No. INFN/FM-00/02, eprint quant-ph/0002022.
- [23] Cf., e.g., F. E. Low (private communication).
- [24] See, e.g., E. Recami, *Physica A* **252**, 586 (1998), and references therein. See also E. Recami *et al.*, “Some information about the four experimental sectors of physics in which Superluminal motions seem to appear,” Report INFN/FM-97/01 (INFN, Frascati, 1997), printed in *Causality and Locality in Modern Physics*, edited by G. Hunter, S. Jeffers, and J.-P. Vigiér (Kluwer, Dordrecht, 1998), p. 113.
- [25] See, e.g., E. Recami, *Riv. Nuovo Cimento* **9**(6), 1 (1986), and references therein.
- [26] See, e.g., E. Recami, *Found. Phys.* **17**, 239 (1987).