

A study on the damping ratio of the viscous fluid dampers in the braced frames

Mohammad Reza Arefi

Department of Civil Engineering, Payam Noor University, Tehran, Iran

E-mail: arefi.mr@gmail.com

Received for publication: 30 July 2014.

Accepted for publication: 17 December 2014.

Abstract

The main task of a structure is to bear the lateral loads and transfer them to the foundation. Since the lateral loads imposed on a structure have a dynamic nature, they cause vibrations through the structure. In order to have resistant structures to the seismic vibrations, two viewpoints have been suggested. According to the first viewpoint, the resistance of the structure results from providing non-elastic shapeable capacity and resistance for the structural members. To achieve this purpose, different structural components such as shear walls, braced frames, moment frames, diaphragms, and trusses should be provided and combined to form a resistant system to the lateral loads. The present paper intends to study the optimal damping ratio of the viscous fluid dampers (VFD) in the braced frames. In order to reach the purposes of the present paper, the library studies, and proper software have been used to analyze data and make a conclusion.

Keywords: damping, braced frames, viscous fluid dampers

Introduction

Though over the recent years heavy costs have been paid for accurate recognition of force of an earthquake in the research institutes of the world with the purpose of decreasing its damage, the increasing need for more research studies on the effects resulted from the earthquake is felt in the theoretical and laboratorial scales (quoted from Mehdizadeh Sari, 2008). Over the last fifty years, the earthquakes are categorized into two groups of near-field earthquakes and far-field earthquakes based on the distance of the place of recording the earthquake from the fault. Later, this definition was modified and other factors also influenced this categorization. Over the recent years, the research studies concentrated on the study of impacts of ground motion in the near-field earthquake on the structural performance. The devastating effects of the recent earthquakes such as Northridge earthquake (1994), Kobe earthquake (1995), and Taiwan earthquake (1999) on the buildings of the cities adjacent to fault, and with regard to the close location of many of the cities of Iran to the active faults indicate the significance of the research.

The viscous fluid dampers (VFD) are the more applied tools for controlling responses of the structures. These tools are applied based on different construction technologies in order to decrease the structural responses to the seismic excitation.

Research hypotheses

The methodology is the basic stage of a research study and it refers to the method and tools that help the researcher reach answers for his questions. However, the answers form based on the research hypotheses (Fadami, Gholamreza, 2007). A problem cannot be solved based on a scientific method, unless there is at least one temporary answer (a hypothesis). Generally, the problem is only

a question and it is the answers (hypotheses) to the question which are tested. Here, the research hypotheses will be presented.

1. Regarding the energy dissipation, installing VFD in the braced steel frames could improve the seismic performance of the braced steel frames subjected to the near-field earthquakes.
2. The viscous damper with the 10 to 30 percent of damping ratio has a desirable impact on the improvement of the seismic performance of the braced frame.
3. Damping ration over 50 percent does not considerably improve the performance of frames

The viscous fluid damper is designed based on the viscous damping resulted from the motion of a moving object within a fluid. A damper structure includes a cylinder and a piston which is made from a stainless steel and a perforated bronze cap. The damper cylinder should bear the load pressure imposed on the volume of a cylinder made from the stainless steel. However, the damper cylinder welding is impossible as a result of the residual stress. The cylinders are designed so that they could bear 1.5 magnitude earthquakes. Moreover, the cylinders should not sink as a result of the compressive force. The liquid within the cylinder is the silicone oil, it is non toxic and non-flammable, moreover, it lasts for a long period of time. The basis of the damper activity is the energy dissipation via the liquid passing with high pressure through the pore placed within the cap of the piston. When the pressure is imposed on the damper, the liquid flows from the container 2 to the container 1. In contrast, when damper is in tension the liquid flows the container 1 to the container 2. The passing of the liquid with high pressure through the pore of the piston causes the pressure difference at both sides of the piston cap and produces damping force. The liquid flowing continues up to the point that the pressure is equally imposed on both sides of the piston. The liquid compressibility might cause an elastic return force. To prevent it, a control valve provides the possibility of the liquid flowing to the container3 known as the accumulator or the storage container.

The relation between force and velocity for this type of damper is written as follows:

$$F = CV^n$$

F stands for the damper force, V for relative velocity of piston, and C for the damping coefficient. Damping coefficient is a fixed number which is determined based on the diameter of the damper and pore surface. N is the function of velocity and it could have a value varying from 0.3 to 1.95. The value of n for the structural applications is suggested between 0.3 up to 1 (Haskell, G. and Lee, D., 2006). A damper with n=1 is called a linear viscous damper that makes a larger damping force for a small relative velocity. The hysteresis loop of the linear viscous damper is a complete form of an oval. The lack of the more hardness of a damper equalizes the natural frequency of the structure and the damper. As a result, designing a structure with linear viscous dampers will be simplified. The applying of these dampers in the structure caused phase difference of the depreciatory viscous force in comparison with other structural forces. As a result, the storeys will experience the maximum displacement and the viscous force of the damper will be equal to zero. Therefore, applying dampers for retrofitting the buildings prevents the compressive failure of the weak columns. Moreover, the dampers could be designed so that they could be insensitive to the temperature changes (Imami and Sabetahd, 2011).

The first research studies in the field of near-field earthquakes approximately began from a half century ago. At that time, the earthquakes were categorized to the near-field and far-field earthquakes regarding the distance between the record location and the fault location. However, the definition was gradually modified and other factors also entered the categorization. For Benioff reported the first near-field earthquake in 1955. His record was the result of recording Kern County California in 1952. He indicated that the spread of fault failure as a moving resource could cause two different types of vibration in two ends of the failure area. He also indicated the schematic

moving resource in the form of a straight line in order to study its effect on the amplitude and the wave form. Over the recent years, the near-field earthquakes have caused much devastation. The earthquakes that occurred in Landers (1992), Northridge (1994), Kobe (1995), Taiwan (1999), and Bam which is located in Iran (2003) were all samples of the near-field earthquakes. After the occurrence of the Northridge and Kobe earthquakes and with regard to its damage and death rate in the urban regions whose structures were designed based on the modern seismic regulations, the issue of the near-field earthquakes were considered for the second time and the studies affected the new edition of documents such as Applied Technology Council 40 (ATC) (1996), Federal Emergency Management Agency 273 (FEMA) (1997), Uniform Building Code 97 (UBC) (1997), and FEMA 302 (1998). For the first time, the structural response to a large pulse was studied by Mahin and Bertero after the San Fernando earthquake (1971). They declared that Olive View Medical Center was badly damaged as a result of a severe pulse excitation which was one of the characteristics of the near-field earthquakes. They noticed that the damage resulted from a few number of displacement cycles with high amplitude (near-field earthquake) was more than the damage resulted from the higher number of cycles with low amplitude (far-field earthquake). Moreover, special considerations were needed for designing short-period structures which were designed based on the available seismic regulations and in the area with 20 to 60 km far from the active faults. Hall and colleagues (1995) applied the theory of wave propagation for investigating a shear structural response which was influenced by the pulse excitation. They highlighted the devastating effects of the near-field earthquakes and the inadequacy of the available regulations. Also, Iwan applied the elastic structures to reach the spectrum of the base isolation as a criterion of the seismic need for the multi-degree of freedom structures influenced by the near-field records. Iwan indicated that even for structures with elastic behavior, it is impossible to reach the near-fault effect merely via multiplying a coefficient to the design base shear such as UBC97.

There are many studies associated with decreasing the effects of near-field earthquakes for improving the structural performance. In these studies, the effect of base isolation via different damping mechanisms has been studied in order to protect the structures against pulse-type excitations. Though the results seem to be positive, there are many problems for displacements of the structure by the severe pulse excitations. Anderson and colleagues studied steel and retrofitted concrete high-rise structures which had been retrofitted by shear wall and bracing. They concluded that long-period structures influenced by severe pulse-type motions make the common methods of retrofitting such as the increase of strength or resistance via adding shear walls or bracings out of use. In fact, the increase of strength decreases the period and increases it through the high velocity range.

Saeedi and Samroel (2005) investigated the effects of the near-field earthquake on the columns designed based on the code 1.3 of Caltrans v. Both of the sample concrete columns with the main periods of $T_{MN} = 1.5s$ and $T_{MN} = 0.66$ had the same material properties. They were tested by the records of the near-field earthquakes. These studies indicated that the records influenced by effects of directivity had caused permanent deformations on the columns.

Anderson and Bertero (1987) studied the structural behavior under pulse-motions of the ground. In their study, a ten-storey steel structure with three spans was subjected to the Imperial Valley earthquake (1979). It was concluded that the increase of the ratio of the pulse period of the ground motion to the natural period of the structure and also the increase of the ratio of the ground acceleration to the structural yield strength would lead to the increase of non-linear response of the structure and the damage imposed on it. According to their studies, the concentration of deformations in the lower floors of the building whose columns bear much axial load will lead to the applying of P- Δ effect in the lower floors. Therefore, the damage resulted from the strike-motions

of the ground will be accumulated in the lower floors of the building. Moreover, the near-field earthquakes will increase the need of formability for the rigid structures. Haul (1995) designed structures based on the common codes and studied their behavior through the near-field earthquakes. It was concluded that the energy imposed on the flexible and long-period structures or even the isolated structures considerably exceeded their capacity.

Chui, Kim, Chun, and Su (2005) investigated a three dimensional four-storey frame with the main period equal to the main period of the nuclear power plant structures on the vibrating table to study the safety of the Korean nuclear power plant.

According to their study, a pre-stressed dome-shaped structural plane with the main frequency of 4.7Hz was tested. Therefore, a steel frame with a similar frequency was applied to study the effect of frequency content of the near-field earthquake. The thickness of the roofs and the hardness of the columns were determined so that the initial period of the structure would equal 4.7 Hz. The results indicated that the earthquake inputs which were effective in several directions would not cause a larger response in the normal structures. Moreover, the acceleration response of the steel sample indicated that the near-field earthquakes would not necessarily cause a larger response. The observation of the acceleration response indicated a relation between the frequency content of the earthquake and the main frequency of the structures as a main factor for the response of the structures. It seemed that the effect of the near-field earthquakes on the atomic power plant structures in the linear or elastic limitation would be negligible (In-Kil Choi et al, 2005).

The studies reveal that the frequency of the large and heavy structures of the atomic power plant is between 4 to 10 Hz. Therefore, if a structure is resulted from a large displacement in the non-linear limit, the structural frequency would decrease and the displacement response would considerably increase. It is because of the strike- type and long-period characteristics of the near-field earthquakes that occur in a short period of time. This vibration will cause a great damage in the long-period structures. In fact, the structures with high frequency which are located in a linear limit will not cause large responses as a result of being influenced by the near-field earthquakes that have short frequency content. However, if the structures go toward the non-linear area, their frequency will decrease and their period will increase. In this condition, they will be vulnerable to the near-field earthquakes. Moreover, the vulnerability of the materials installed on each level of the roof influenced by the acceleration response spectrum of each level indicates that the high frequency earthquakes could affect the safety of equipment installed on each building. As a result, the near-field earthquakes will not damage the equipment with high natural frequency (In-Kil Choi et al, 2005).

Materials and methods

The present paper investigates the seismic performance of the braced steel frames with and without fluid viscous dampers (VFD) in the near-field earthquakes. The analysis of the non-linear response history of the braced frames used in the under-study buildings with VFDs is done to determine the effect of damping ratio on the seismic performance of the frames. MATLAB software and OpenSEES software are used to model VFD and do dynamic analyses of the non-linear response history.

The energy dissipation has weakened the seismic performance of the braced steel frames without viscous dampers. Moreover, they are sensitive to the pulse period of the near-field ground motion as a result of the effects of the brace buckling. However, the seismic performance of the frames is improved via installing damper. The viscous damper with the damping ratio of 10 to 30 percent has a desirable impact on the improvement of the seismic performance of the braced frames.

In the non-linear statistical analysis method, the response of the multi- degree of freedom structure influenced by the seismic motion of the ground is determined by its equivalent response of the one degree of freedom system. According to this method, the structure is modeled by considering the non-linear behavior of the elements. In the next stage, the gravitational loads will be applied on the structural model. In the next stage, a lateral loading with a certain pattern in the height that indicates the inertia forces of the structure created by the ground excitation will be imposed on the structure. The lateral forces will increase up to the yielding of the structural members. The structural model will be improved for applying the decreased stiffness of the yielded members; however, the lateral forces will be increased for a second time to cause the yielding of the other members. This process continues up to the point that the displacement of the control node reaches a certain value of the target displacement. The base shear curve is drawn versus the displacement of the control node; consequently, the structural capacity curve will be obtained. The calculated forces and deformations in the displacement of the target will be used as the demand for the resistance and inelastic displacement; they should be compared to the allowed capacities for the performance control. This method enables the user to study the stages of the structural yielding, member failure, and progress of the structural capacity curve.

The simplicity of this method, its considerable estimation for determining the seismic response compared with the non-linear dynamic analysis method, and determining the structural performance by considering the non-linear behavior of the member are the advantages of this method. On the other hand, the non-linear statistical analysis method is an empirical method and its main disadvantage is that it cannot indicate all of the changes of the non-linear dynamic characteristics of the structures. Therefore, these methods have an ineffective performance for predicting the needs of non-linear deformation and the local forces of the members with higher vibrational modes.

Results and discussion

Techniques of flowing shock absorber method

Reducing seismic dynamics of structure is the objective of this method. It enables the structure to have linear and elastic state during earthquake event. Viscous shock absorber fluid and damper results in decreasing intensification level in earthquake response spectrum. Adding fluid damper to structure will not result in a change in time span of answer. It increases structural damping from 5% to a number between 20% to 30% or more. Sticky shock absorber fluid is capable of designing for new structures and made structures. According to small size of these pieces when adding to structure, they do not change shape of the structure. sticky fluid dampers are installable by different methods as diagonal or be tied to attic wind bracings .figure 1 shows method of connecting a diagonal connected to column beam of a flexible frame with beam of beside column. This connection is carried out by shock absorber by sticky fluid technology. These kinds of connections are applicable both for manufacturing structures and manufacturing structures. This work has been done in ckbton city hall 860 structure. Details of this special reconfiguration are shown in figure 2. Another kind of connection between diagonals and damper by sticky fluid technology is shown in figure 3. In this connection, 2 dampers are connected to each diameter element, one works in pressure another works in tension. This configuration has been used in pacific bell 911 building.

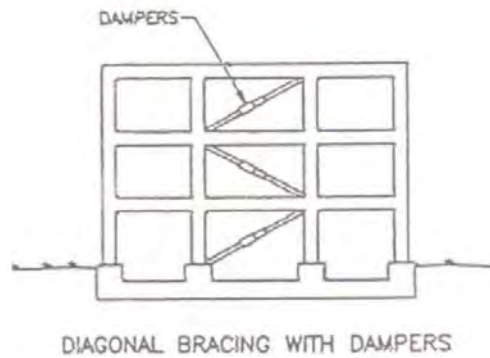

Figure 1. Method of connecting a diagonal connected to column beam of a flexible frame with beam of beside column

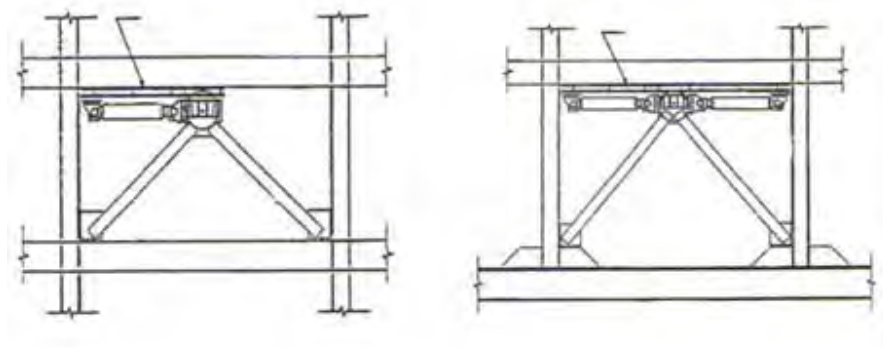

Figure 2 Details of special reconfiguration

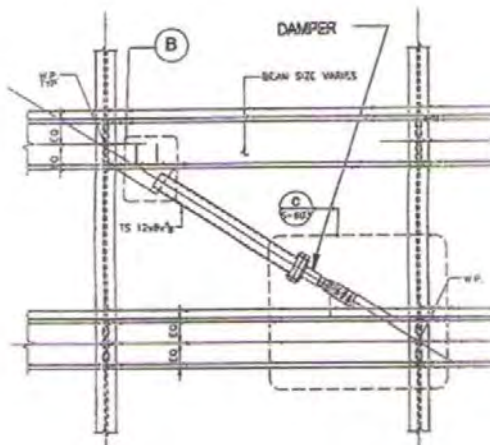

Figure 3 Connection between diagonals and damper by sticky fluid technology

In figure 4, details of damper including sticky fluid is shown. It is possible to use deformed wind bracing too. Damper is used for both wind bracings beams. Rolled support or cripples are used in both of the beams for transfer. Figure 3 shows this kind of transfer. In this case, one end of damper is rolled support, the other end is beam flange which is attached to diagonal.

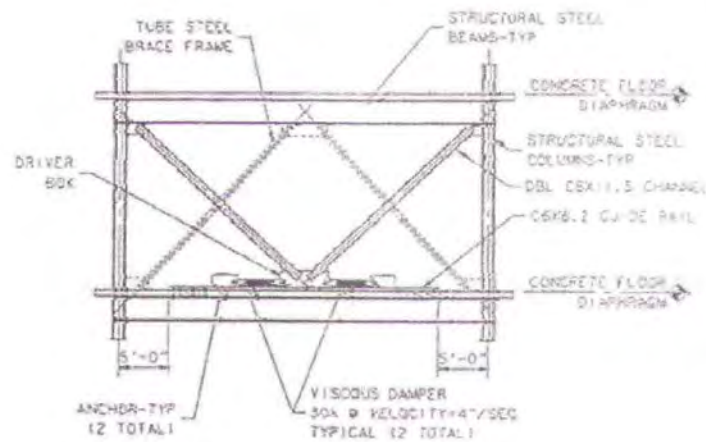

Figure 4 Details of damper including sticky fluid

Analysis design methods for fluid dampers with high viscosity

The methods which are used for placing damper in a ready-to-use structure are applied based on the hypothesis that the lateral forces in a resistant system remain in the linear and elastic state at the time of earthquake activity. It means that there is no durability deformation in the members of the structure, therefore, no repairs is needed after an earthquake. The analyses of the response history of a lateral system are needed for designing bumper and dissipating systems. The analyses determine the velocity of interior storeys where the velocity needs the performance of fluid bumpers.

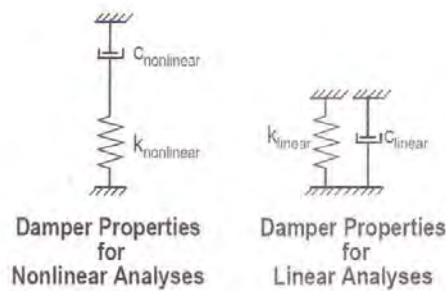

Figure 5: The model of a viscous damper

If the response history analysis is used, the minimum value of three velocities in the response history of the under-study structure should be given to the analyst (person or computer). The mentioned minimum value is determined by the geotechnical studies. The program of Guidelines Company was provided by the engineers of the sub-branch of energy in the structure section of the north California University in 1993. The program forced the engineer to apply the worst case among the three cases. The worst case had the highest stress and deformation. When the internal velocity of the storeys is determined, the engineer could estimate the needed power and damper characteristics with regard to the lateral force which is estimated between 3 to 5 percent of the structure weight. First, the engineer calculates values of the maximum velocity and the accurate value of the force; he

also estimates the exact size of the damper with the viscous fluid content. Second, the computer determines the initial force level and the value of velocity in the storeys so that the engineer could understand the new value of displacement in the interior storeys. The interior storeys determine the amount of displacement for the performance of dampers. In this stage, the engineer of the structure is aware of the total amount of force, velocity, and the impact of dampers imposed on each level of the structure, and these are the issues that the constructor needs for estimating the value of the product and offering the damper (Keivani and RahimiAsl, 2011).

The impact of damping on the structural response

The increase of damping leads to the decrease of the structural response (velocity and displacement). The increase of damping at short- periods (close to zero) does not affect the spectrum, moreover, at the longer-periods; it hardly affects the response velocity. The following figures indicate the maximum effect of damping increase at the time periods of 2.5 and 0.3 seconds.

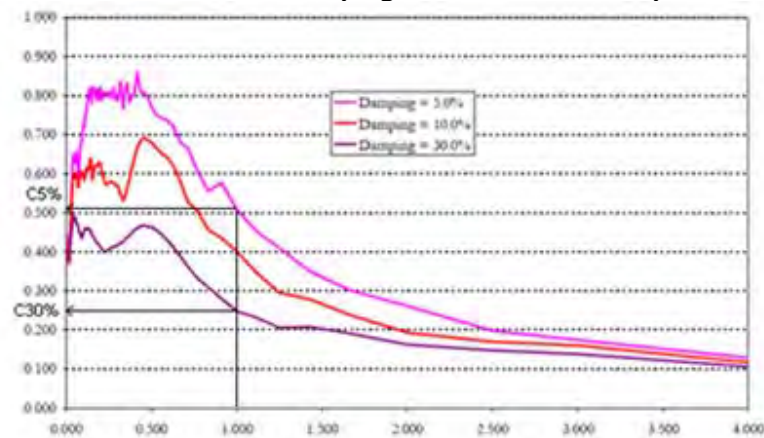

Figure 6: The effect of damping on the spectrum of velocity response

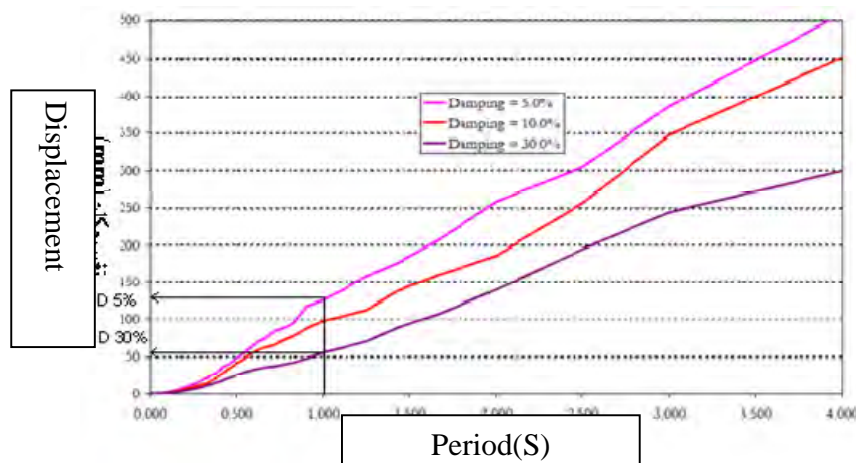

Figure7: The effect of damping on the spectrum of displacement response

The attachment of dampers to the structure

1. Connecting dampers to the floor and/or the foundation (based on the seismic isolation method)
2. Connecting dampers to the chevron bracing.

3. Connecting dampers to the diagonal brace.

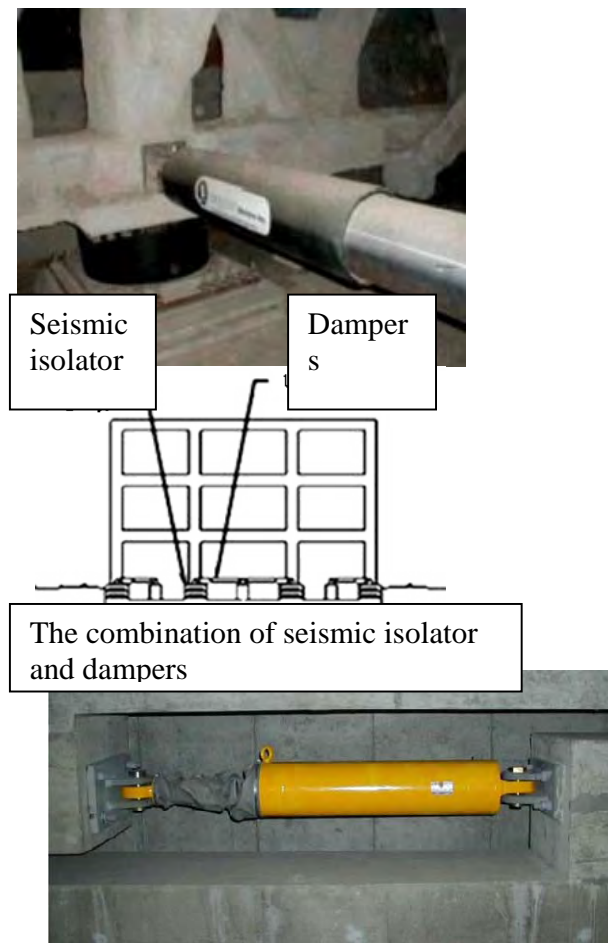

Figure 8: The connection of viscous dampers to the floor and foundation of the structures

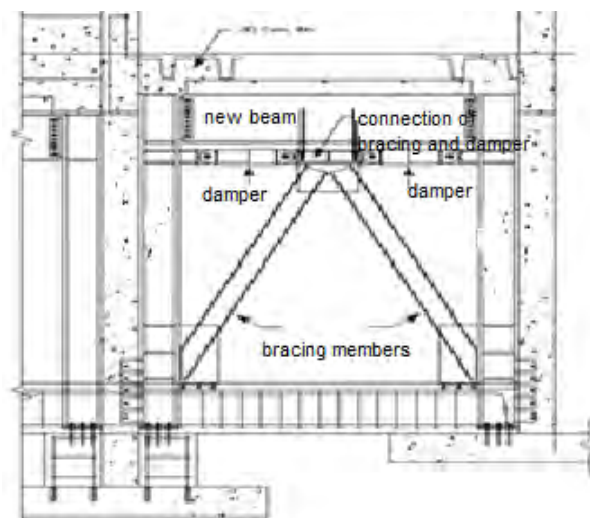

Figure 9: The use of viscous dampers in the chevron bracing

The combination of dampers and isolators could be used in the connection of dampers to the floor and/or the foundation of the structures.



Figure10: The use of viscous dampers in diagonal braces

Characteristics of the near-field earthquakes

The strike fault and the high value of the maximum velocity are observed in the near-field records. One of the characteristics of the near-field records is the distance from the seismic source which approximately equals 15 kilometers; however, it might reach 60 kilometers. In the near-field area, the ground motion is influenced by factors such as ruptures, the progress of ruptures, and the probability of the ground displacement forever as a result of the fault slip.

The mentioned parameters lead to effects which are known as rupture direction. The progressive rupture occurs as a result of the rupture progress and the fault slipping toward the structure. This phenomenon results from the velocity of the fault rupture which is usually close to the velocity of the shear wave of the rocks close to the source (approximately 80 percent of the shear velocity). If the rupture progresses from the center of the earthquake forward and backward of the structure, the energy will be accumulated in front of the rupture where the slip of fault has progressed. The progressive wave formed at the beginning of the record will enter as a large pulse and will be polarized vertically. The mentioned pulse has large amplitude in a long period and short time length. If the structure is close to the epicenter, the rupture progress and the seismic waves will reach the site on time. The pulse of the record is influenced by the location of the fault slip, and the location of the record device regarding the fault. This effect is known as the directivity effect. The characteristics of the near-field records should be expressed as follows (Alirezaei and Shakib, 2009):

1. In comparison with the far-field records, the near-field records have larger values of PGA and PGV.
2. The strike motion with the long period is observed at the beginning of the record and it is more observable in the component perpendicular to the fault.
3. PGV value for the component perpendicular to the fault is more than that of the parallel component of the fault.
4. The released energy in the front of the rupture is more than that of the other parts as a result of the accumulation of the effects of the shear waves in the progressive path of the rupture and the pulse-typemotion. In other words, the presence of pulse at the beginning of the record indicates the release of a huge kinetic energy in a short period of time resulted from the fault rupture.

The horizontal motion is the dominant motion for faults whose main displacement is done in a horizontal surface. As a result, single or double pulses might emerge. These characteristics depend on the type, length, and complexity of the fault. The period of the main strike fault might be equal to

0.5 up to 5 seconds depending on the type, length, and characteristics of the fault. The high length of the strike period occurs for two reasons. The first reason refers to the intervention of the dynamic shake as a result of the fault rupture, and the second reason refers to the dependence of the ground motion on the ground sustainable deformations. The direction dependence of these two states results from the elastic return of the fault rupture. In other words, it occurs as a result of the very fast ground motion at the time of an earthquake (Hashemi, 2005). As a result, a seismic resistant design is needed.

Though the fault rupture is close to the site, the velocity is approximately fixed and the seismic energy is released from the fault rupture in a short time interval. For the sites close to the fault, the fault is normal and their velocity spectrum is greater than a velocity spectrum resulted from a parallel fault. In the earth quake that previously occurred in Turkey (1999) and Taiwan, the time period was observed in the pulse waves. Moreover, the amplitude of the recorded frequency depends on the spatial geometry of the epicenter and wave angle. The recorded frequency of the earthquake that occurred in Imperial Valley of California in October of 1979 resulted from a seismic source with a horizontal fault. The following figure indicates two recorded frequencies in different directions in comparison with the fault direction. Also, the velocity of them has been recorded. The figures reveal that the record in the fault rupture direction has a velocity figure with more strike motions (Alirezaei and Shakib, 2009).

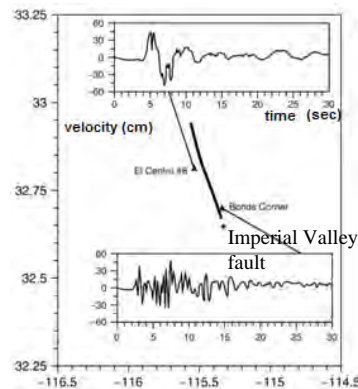

Figure 11: The relation between the spatial geometry of the epicenter and the wave angle

Conclusion

After the Imperial Valley earthquake (1979), Anderson and Bertero declared that the sensitivity of inelastic response of the structure affected by the near-field earthquake was a function of its resistance and also the ratio of the structural period to the dominant period of the available pulse in the record. Moreover, the progress of the failure was one of the factors that affected the structural behavior. Their study on multi-degree of freedom structures indicated that in the lower floors with high axial force, the increase of formability leads to the increase of the significance of P- Δ effects. Also, they suggested that the form of design spectrum in the limit of long-period structures should be improved against the pulse-type earthquakes. The near-field earthquakes have velocity pulse with severe strike waves, long-periods, and permanent deformation of the ground. The velocity pulses occur in the horizontal components perpendicular to the surface of the fault motion and they result from the directivity of the fault rupture. The pulse characteristics such as the velocity record in the near-field earthquakes causes the uncommon behavior of the response spectrum in the

pulse period. Moreover, the imposed energy on the structure within a short period of time by these pulses leads to the absorption of the earthquake energy in the first joints instead of the development of non-linear behavior and plastic joints in the high part of the structure. As a result, the development of the non-linear behavior is not observed. The near-field earthquakes have a higher velocity and with limited frequency content at higher frequencies compared with the far-field earthquakes. Recording such earthquakes especially when there are influenced by the fault propagation will have long-period pulses with a large amplitude. The effect of the fault propagation direct results from the propagation of the fault toward the considered site. In this condition, the fault velocity approximately equals the velocity of the shear wave. Iran seismic code (IS 2800) has not considered the near-field earthquakes and its spectrum is close to the response spectrum of the far-field earthquakes. Three buildings with 3, 8, and 12 storeys have been modeled based on the out-of-center bracings and the spectral analysis and non-linear dynamic analysis have been performed on these models.

References

- Alirezayi, Mahdi, Shakib, Hamzeh (2010), Six-component evaluation of Near-fault earthquake records. 8th international congress of civil engineering, Shiraz university.
- Bozorgnia, Yousef (2004). Earthquake Engineering: From Engineering Seismology to Performance-Base Engineering, Published by CRC Press LLC.
- Bruce, A. Bolt (2002). Seismic input motions for nonlinear structural analysis, Journal of Earthquake
- Chrysostomou, C. Z.(2003). Validation of the 2000 NEHRP, Provisions Equivalent Lateral Force and Midal Analysis Procedures for Buildings with Damping Systems, Earthquake Spectra, 19 (4), 981-999.
- Douglas, A. Foutch and Scung-Yul Yun, Modeling of steel moment frames for seismic loads, Journal of Constructional Steel Research, 58.
- Emami, Kamal, Sabet, Ahd Rasoul(2012), Seismic Control of Structures with the incorporation of passive viscous dampers by using non-linear time history analysis. The first conference of earthquake disaster Management and vulnerability of vital places and roads.
- Fadami, Farhad (2007). Evaluation of viscous fluid dampers in Control the response of structures to earthquake excitation, Master's thesis, Sharif University press.
- Farzad, Naeim (ed). The Seismic Design Handbook. 2nd Edition.
- Galal, K., Ghobarah, A. (2006). Effect of near-fault earthquakes on North American nuclear design spectra, Nuclear Engineering and Design, Elsevier.
- Ghaderi, Peyman (2006), Evaluation of effect of near-field earthquakes on Seismic behavior of Structures with high periods . Master's thesis, Sharif University press
- Gerami, Mohsen, Vaseghi, Akbar, Abdollah Zadeh, Davoud (2009). Studying behavior of structures under Near-field earthquakes. 4th national congress of civil engineering, Tehran University
- Hadidi, Mhammad Hesam (2005) buffer and damper performance method in buildings . 11th conference of student civil conference of country, Hormozgan university.
- Hashemi, Shaker (2006) Effect of Real and synthetic records near fault on steel buildings with Hybrid system of flexible frame and coaxial Bracing. Guidance by Dr. Shakib, Master's thesis, Tarbiyat Modares university, Faculty of Engineering
- In-Kil Choi, Min Kyu Kim, Young-Sun Choun, and Jeong-Moon Seo (2005). Shaking table test of steel frame structures subjected to scenario earthquakes, Journal of the Nuclear Engineering and Technology, 37(2).

- John, F. Hall (1997). Seismic response of steel frame buildings to near-fault ground motions, A report of the California Institute of Technology, Report No.EERL 97-05, Pasadena, California.
- Masrou, Shalmani Armin (2009). Studying Behavior of Steel structure fitted with RBS braces, Master's thesis, Sharif University press.
- Monzavi Mohammad (2007). Performance of RBS semi-active bridging piece in Steel Frames. Master's thesis, Sharif University press
- Mahdi Zadeh, Sari Alireza (2009) Seismic behavior of Coax Braced Frames in Near-field fault earthquakes with Progressive orientation effect . Master's thesis, Sharif University press
- Ramirez, O. M.; Constantinou, M. C.; Whittaker, A. S.; Kircher, C. A.; Johnson, M. W.; and Technology (2004). Paper No.448.
- Regulation of building construction against earthquake, standard 2008 Iran, 2006, 3rd edition.
- Tehrani, Zadeh Mohsen, Rahim, Labaf Zadeh, Mohammad ,Saleh (2005), Effective parameters of structures responses in horizontal actions near tremor-maker source. Journal of Civil Society of Iran, No.23
- Sabet Ahd Rasoul, Lotfolahi Yaghin Mohammad Ali. Agha Mohammad Zadeh Farokg (2012). Performance Evaluation of viscous dampers in earthquakes of Nearby Areas by Non-linear dynamic analysis. 6th international conference of Seismology and Earthquake Engineering.
- Saiidi, M., Somerville, P. (2005). Bridge seismic analysis procedure to address near-fault effects, A report of Nevada University (Reno).
- Shakib, Hamzeh, Alirezayi, Mehdi (2010) Six-component evaluation of Near-fault earthquake records. 8th international congress of civil engineering, Shiraz university
- Shakib, Hamzeh, Alirezayi, Mehdi (2012) Three-dimensional response of structures under six components of earthquake near and far of fault Scientific –Civil of school Research journal, 11 (2)