

# Vehicle dynamic effects in the course of passing over turnouts

J. Zelenka<sup>a,\*</sup>, A. Hába<sup>a</sup>, M. Kohout<sup>a</sup>

<sup>a</sup>Jan Perner Transport Faculty, University of Pardubice, Studentská 95, 532 10 Pardubice, Czech Republic,

Received 10 September 2007; received in revised form 10 October 2007

---

## Abstract

For the quantification of vehicle dynamic effects at passing over turnouts at a higher speed there was developed a methodology for evaluating of acceleration measured on vehicle axle boxes in the year 2003. The methodology is based on statistical evaluation of lateral and vertical acceleration measured values at passing over both critical parts of a turnout (tongue, frog). The created methodology was used for investigation of vehicle dynamic effects by running at speed up to 230 km/h in the year 2004 in terms of high-speed tests of tilting-body unit class 680 CD. There was found relatively high values of dynamic effects already at a speed 160 km/h. In terms of tilting-body unit class 680 tests at a higher speed in curves of chosen track lines of 1st and 2nd corridor of Czech Railways there was carried out also verification of curved turnouts state according to methodology mentioned above with a view to possibility of speed increasing at curved throats of chosen stations. Lateral vehicle dynamic effects at passing over a curved turnout frog area were evaluated. There were carried out simulation calculations of vehicle passing over a turnout based on measured geometric parameters of wheelset as well as chosen turnouts. Results of the calculations were compared with measurements. The increased vehicle dynamic effects found in pulsed beats character influence negatively the turnouts part (not only wheel contacting parts) as well as operating life all unsuspended parts of vehicles.

© 2007 University of West Bohemia. All rights reserved.

*Keywords:* dynamic effects, turnout, acceleration, measurement, railway, simulation, high-speed

---

## 1. Introduction

In the year 2000 started in Czech Republic an operation in speed up to 160 km/h in some sections of the 1st corridor. Whereas the corridor rails are mounted more accurately opposite to mounting rails of older technology in condition of running at a speed 160 km/h in corridor track dynamic effects by far they do not reach as high values as in condition of older design technology tracks. This fact is not concerned with turnouts – passing over a turnout tongue area and especially over a turnout frog area in straight direction is attended by increased dynamic forces in the wheel-rail interaction, which results in the increased wear of some turnout parts. This fact is concerned with unmovable frog turnouts placed in through tracks of corridor stations which are operated at a speed 160 km/h.

Methodology [1] was created in order to detect and evaluate dynamic effects of railway vehicles in the course of passing over turnouts. The principle is explained in the next chapter.

## 2. Methodology of the railway vehicle dynamic effects detection in the course of passing over a turnout

There was chosen an acceleration measuring on wheelset axle boxes as an input quantity for detecting vehicle dynamic effects. Wheelset axle box has a close mechanical connection

---

\* Corresponding author. Tel.: +420 465 533 006, e-mail: jaromir.zelenka@upce.cz.

with the wheelset and it is also friendly to installation of measurements (sensors, cable connections).

Acceleration is recorded by sampling frequency 1200 Hz and with regard to a natural frequency of used sensors the records are filtered. An example of filtered records of vertical and lateral accelerations measured on axle boxes of the same wheelset in the course of passing over station throat is in fig. 1. There are marked sections by shadowing in the charts when a wheelset passes over a turnout tongue areas (light shadowing) and turnout frog areas (dark shadowing). The shadowed sections of acceleration records (always of length 20 m) are also the input data for evaluating the vehicle dynamic effects in the course of passing over a turnout.

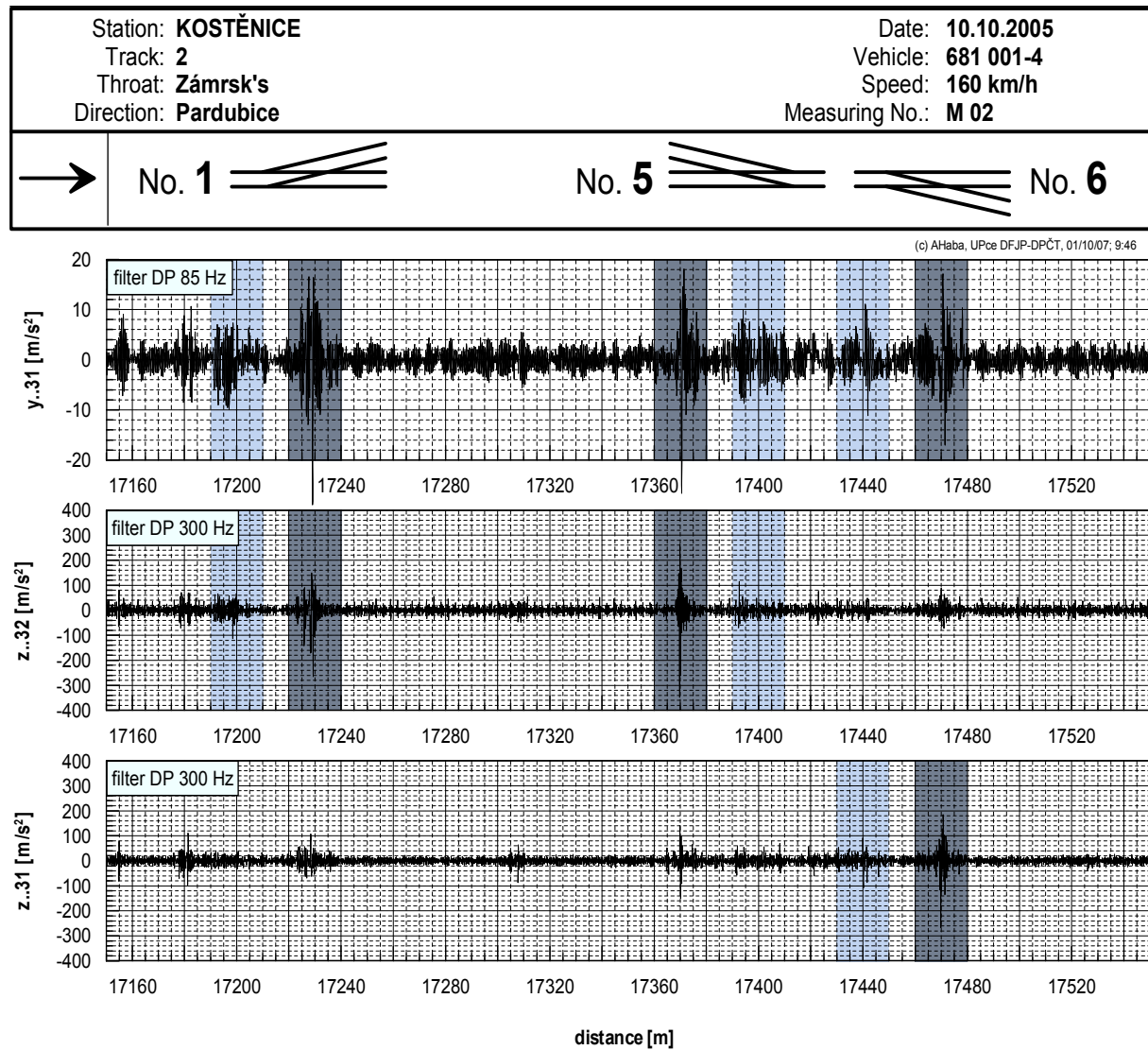

Fig. 1. Filtered records of vertical and lateral acceleration measured on axle boxes of the same wheelset in the course of passing over a station throat.

There are noted the increased values of acceleration measured on the axle boxes in the lateral and especially in the vertical direction in the course of passing over a turnout frog areas. Comparing of the both vertical acceleration records (quantities z..32 and z..31) and the scheme of turnouts position in the station's throat in headline of all graphs higher acceleration values are noted on axle box of that wheel which directly contacts a frog tongue in the course of

passing over a turnout frog area. Hence the sections of acceleration record measured on axle box of the opposite wheel aren't shadowed and they aren't evaluated below.

The evaluation of dynamic effects extension in the course of passing over a turnout is based upon the measured filtered acceleration records in particular sections represented tongue and frog areas of various turnouts as it was figured above. There are computed two important statistical characteristics – 0.15% quantil and 99.85% quantil (analogous to evaluation of running behavior according to UIC 518 and EN 14363).

One of the graphical both statistical characteristics processing is comparison of the particular turnouts with each other in the same conditions as it was figured above. There is a column chart in fig. 2 where each column represents the turnout tongue or frog. Bottom column level comes up to 0.15% quantil value of acceleration and top column level comes up to 99.85% quantil value of acceleration. There are 5 sections which represent running out of turnouts in the same conditions like passing over turnouts on the right part of this graph. The speed was the common criterion here for the comparison, so all turnouts (sections out of turnouts included) were passed at the same speed. Generally the speed isn't sufficient for common criterion in the course of vehicle dynamic effects evaluation in case curved turnouts. It is necessary to take into account also another factors influencing dynamic effects like e.g. cant deficiency, turnout type (single sided, double sided) or curve radius.

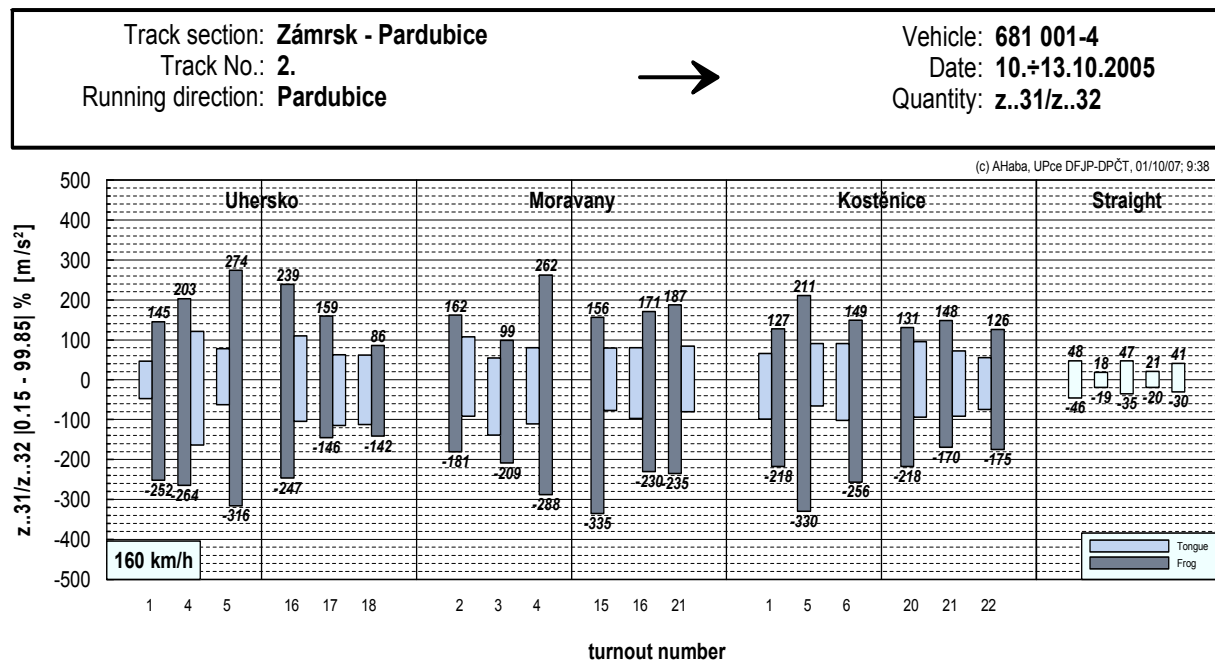

Fig. 2. Vehicle dynamic effects comparison in the course of passing over all turnouts in that track section running out of turnouts including at a same speed.

There is a possibility to detect turnouts which show the increased dynamic effects in comparison with others in that type of graphical data processing. However it is impossible to decide about growth extension of vehicle dynamic effects due to growing speed of passing over a turnout.

The next type of the graphical processing of both chosen statistical characteristics is vehicle dynamic effects comparison of passing over the same turnout at a different speed and the different running direction – see fig. 3. Graphical processing of both statistical characteristics is analogous to previous case.

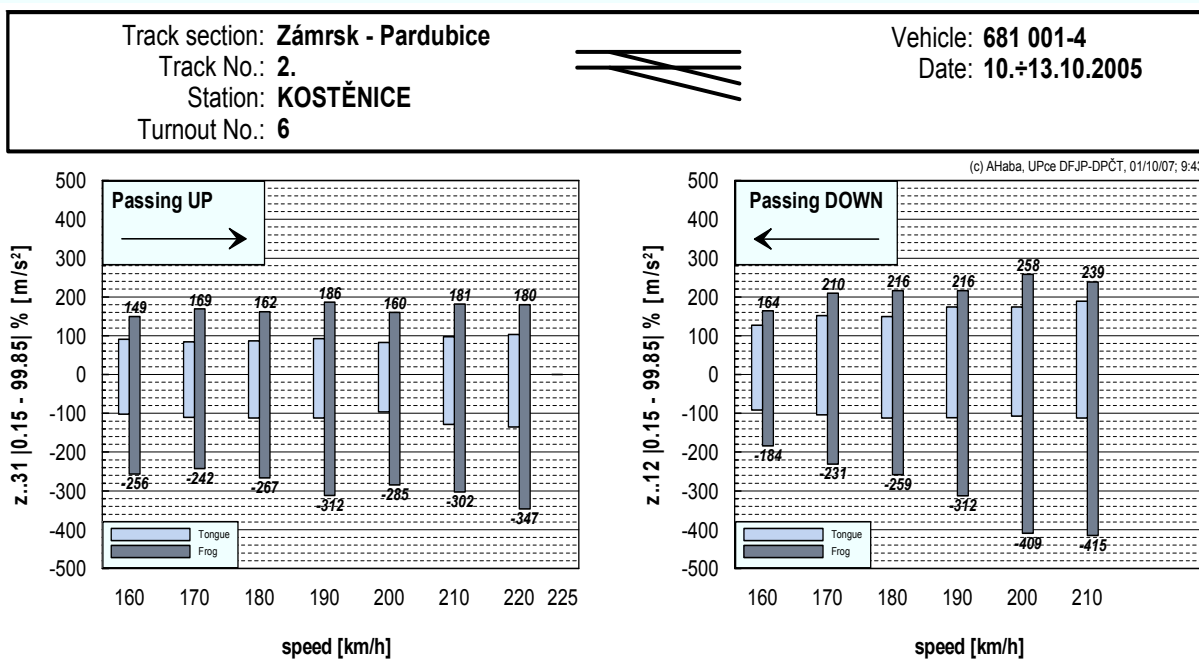

Fig. 3. Dynamic vehicle effects in the course of different passing speed over a turnout.

Although it is impossible to compare vehicle dynamic effects in the course of passing over several turnouts between each other in that type of graphical data processing, but there is a possibility to monitor the dynamic effects growth due to growing speed of passing over a turnout, but only separately for the turnout.

The mentioned above method of railway vehicle dynamic effects detecting in the course of passing over a turnouts were use in years 2004-2006 in terms of two high-volume research projects. The first was concerned to vertical vehicle dynamic effects detecting in the course of passing over straight turnouts at high speed. The second project was concerned to lateral vehicle dynamic effects detecting in the course of passing over curved turnouts at increased speed. Principle aims and detected results of both projects are introduced in the next chapter.

### 3. Executed measurements and their results

In the year 2004 were carried out high-speed tests of unit class 680 between stations Břeclav and Hrušovany u Brna. The maximum reached speed was 230 km/h. There were also executed measurement of acceleration on axle boxes of unit 680 head car 681 001-4 in order to vertical vehicle dynamic effects detection in the course of passing over the chosen turnouts at the increased speed in the terms of this tests [2], [4].

There is a displayed size of vehicle dynamic effects in the course of passing over turnouts in stations Podivín, Zaječí and Šakvice at a speed 160, 200 and 220 km/h in fig. 4.

It is clearly visible in fig. 4, that the particular turnouts show its dynamic effects of the different size at the speed 160 km/h. Increased dynamic effects are shown especially at Šakvice's turnouts and next also some turnouts of station Podivín. Contrariwise relatively low dynamic effects are shown at turnout No. 2 and 3 of station Zaječí even at the speed 200 km/h.

There was detected a reason of increased vehicle dynamic effects after mentioned above evaluation of vehicle dynamic effects of some turnouts. For that purpose KŽV, s.r.o. corporation measured lateral profiles of chosen turnouts frog area rails [3]. There was chosen turnout No. 6 of station Podivín and turnout No. 2 of station Zaječí for the comparison. There are dis-

Track section: <b>Břeclav - Brno</b>	Vehicle: <b>681 001-4</b>
Track No.: <b>2.</b>	Date: <b>16.-19.11.2004</b>
Running direction: <b>Brno</b>	Speed: <b>-</b>

(c) AHaba, UPce DFJIP-DPČT, 09/08/07, 13:42

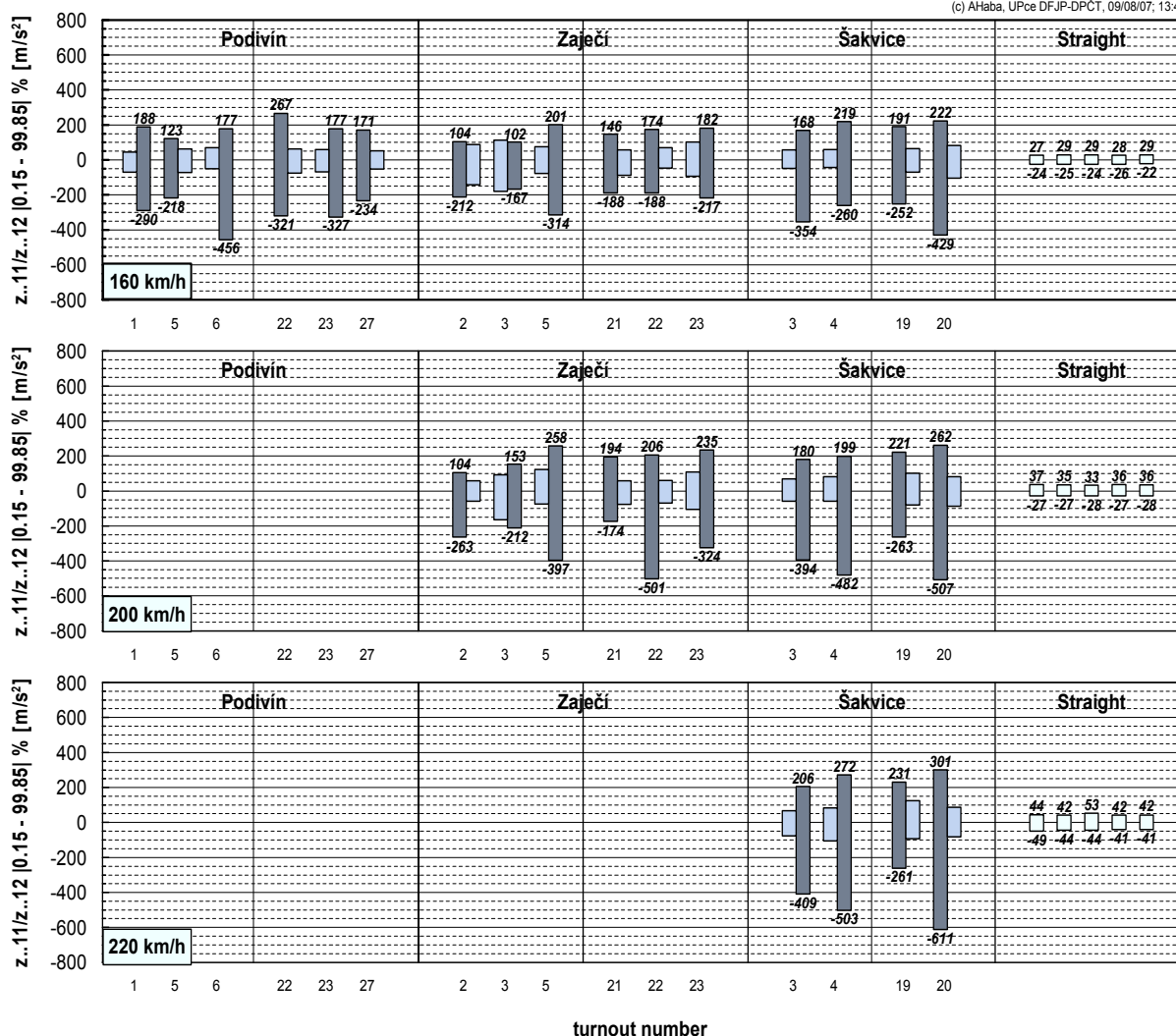

Fig. 4. Vertical dynamic effects of vehicle 681 001-4 in the course of passing over turnouts of 2nd track line at track section Břeclav – Hrušovany u Brna.

played measured frog area rail profiles of both mentioned turnouts in fig. 5 and 6. There are displayed the profiles as a unproportional spatial model in the top part of both figures, there are displayed the profiles through each other in the bottom part.

There is possible to take cognizance of clear wing rail elevation in fig. 5, which is typical for frog type “Insert”. It stands to reason, that the mentioned elevation was the reason of increased vehicle dynamic effects in the course of passing over frog area of that turnout.

There is possible to take cognizance that wing rail surface as well as frog toe is in the same level and therefore a wheelset doesn't have to do fast movement in the vertical direction in the course of passing over frog area, which should results in increased dynamic effects like in the previous case.

In the year 2005 there was carried out next high-speed tests between stations Pardubice and Zámrsk. Maximum reached speed was 230 km/h as well as in the previous tests. There



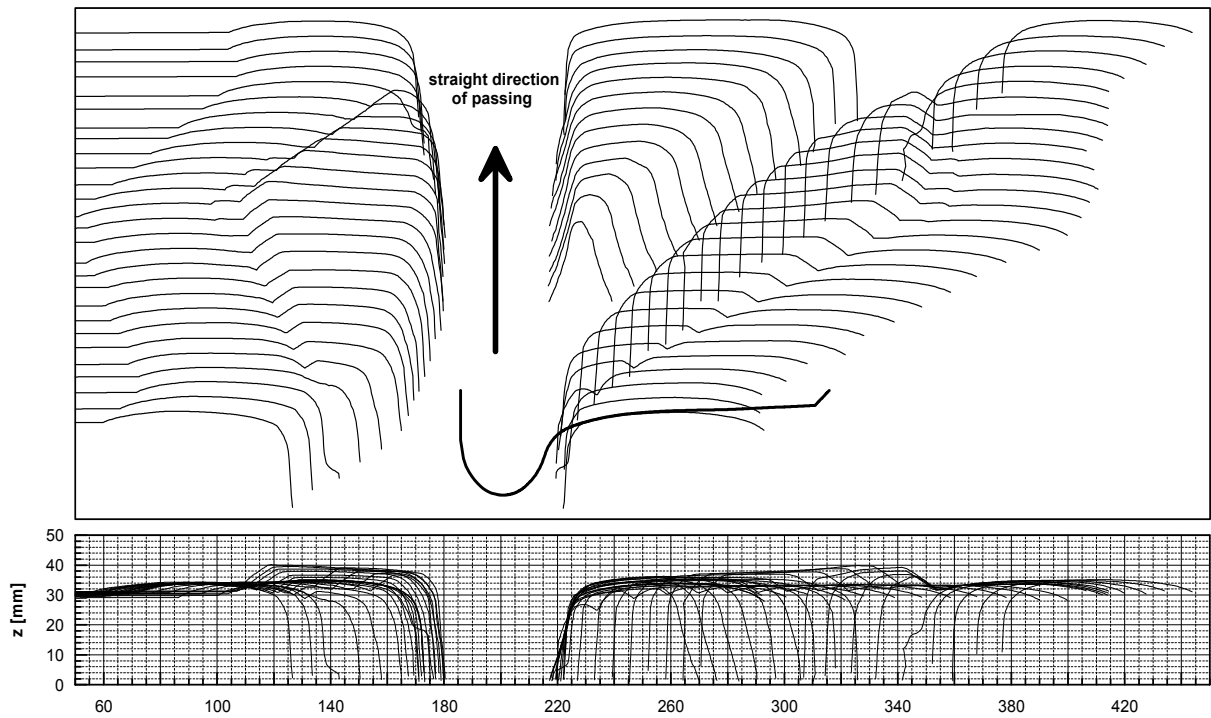

Fig. 5. Frog area lateral profiles of Podivin's turnout No. 6.

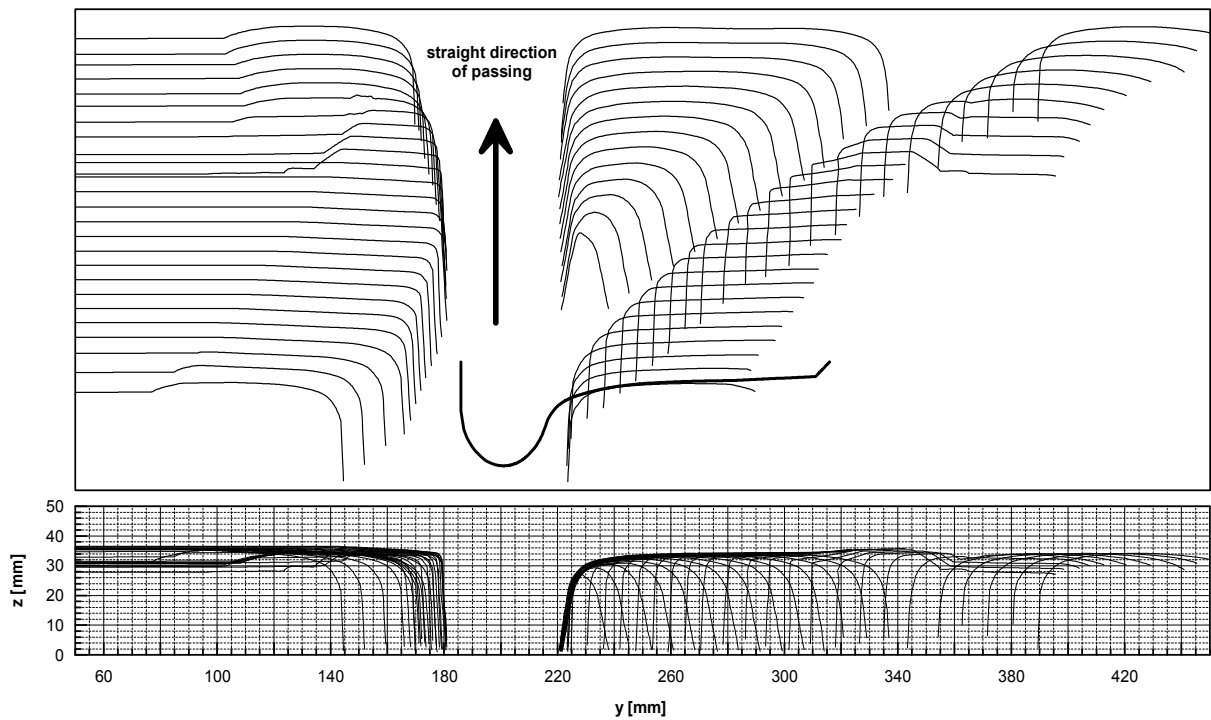

Fig. 6. Frog area lateral profiles of Zaječí's turnout No. 2.

was executed detecting of vehicle dynamic effects in the course of passing over turnouts at a speed 160 km/h in terms of measuring of traction equipment on the base of experience of previous high-speed tests and results of vehicle dynamic effects detecting in the course of

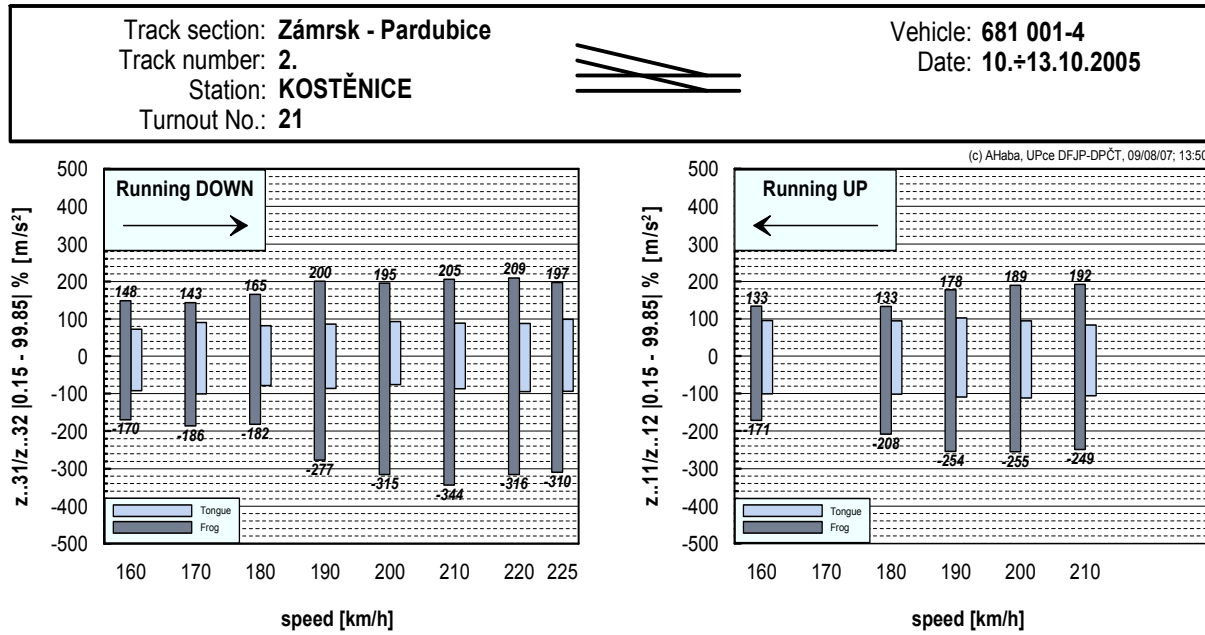

Fig. 7. Dynamic effects of unit 680 head coach 681 001-4 in the course of passing over Kostěnice's turnout No. 21 at a different speed.

passing over turnouts in order to detect a critical turnouts showing increased vehicle dynamic effects. Then there weren't registered increased dynamic effects in the course of passing over turnouts at an increased speed at high-speed tests [6]. Contrariwise some turnouts show even stopping of dynamic effects growth with growing with regard to passing speed namely at a speed about 200 km/h (see fig. 7).

In the year 2006 there was carried out a verification of the chosen 2nd corridor track section regarding operation of unit 680 at an increased speed in curves with using tilting body technology. There were also detected dynamic effects of the unit head coach in the course of passing over curved turnouts of chosen stations throats in terms of the tests with a view to the possibility to prospective increasing of passing speed over those throats. Lateral vehicle dynamic effects were evaluated in the course of running over curved turnouts. There are displayed lateral dynamic effects of unit 680 head coach 681 001-4 in the course of passing over chosen curved turnouts in fig. 8. There was set a cant deficiency as a criteria for comparison [5].

There is noticeable in fig. 8 that none of the turnouts shows the increased vehicle dynamic effects in the course of cant deficiency 120÷122 mm. In addition vehicle dynamic effects level in lateral direction in the course of passing over turnouts is comparable in size to dynamic effects in the course of running on track of older design technology (identified as "old track" in the right graph part) and namely moreover in the course of lower cant deficiency. However cant deficiency is nowhere only factor influencing size of vehicle dynamic effects in the course of passing over a curved turnout. Also passing speed acts indispensable role which is partly confirmed by fig. 8 where vehicle dynamic effects are lower in the course of passing over Hoštejn's throat of station Třebovice v Čechách than in the course of passing over both Krasíkov's throats at a higher speed but in the course of same cant deficiency.

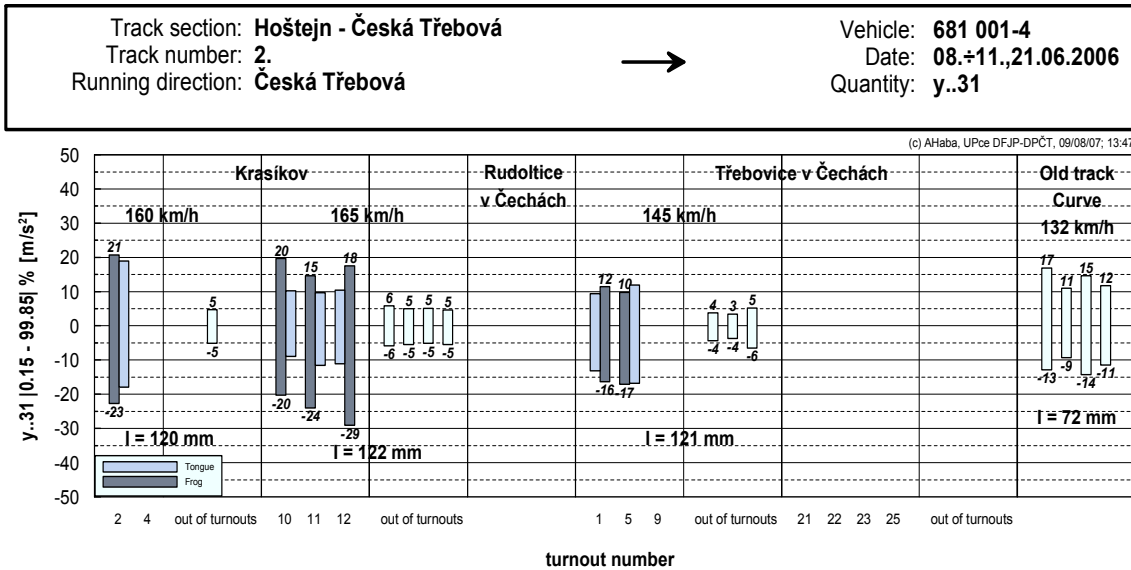

Fig. 8. Dynamic effects of unit 680 head coach 681 001-4 in the course of passing over 2nd track line curved turnouts of station Krasíkov and Třebovice v Čechách.

#### 4. Comparison of simulation calculation with measurement

The aim of a computer modeling of a railway vehicle running is solving of a dynamic response time proceeding of a vehicle mechanical system to running on a suspended track, which have vertical and lateral irregularities. A dynamical model of a vehicle generates system of rigid bodies connected by suspension and damping elements. Track is modeled such as two rails – bodies of reduced mass, which are connected to underbed by suspension and damping elements in vertical and lateral direction. System of vehicle-track is connected by kinematical and adhesion connection wheelset-track where act the main role contact geometry and adhesion characteristics.

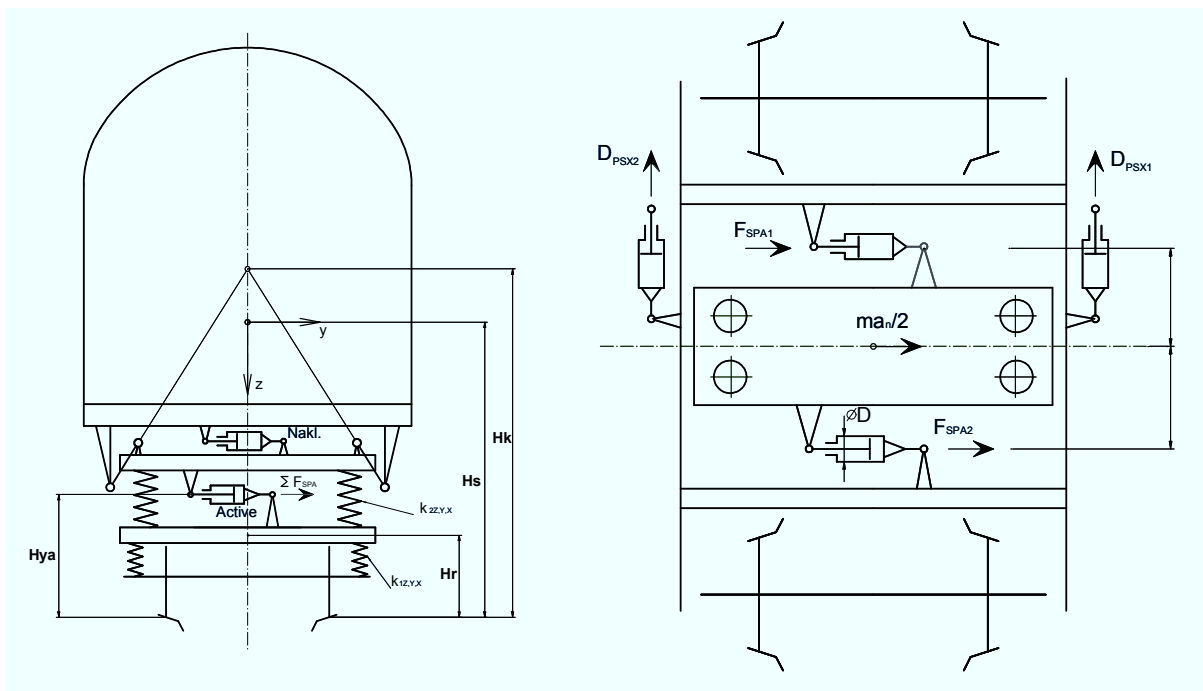

Fig. 9. Model of tilting body system and lateral suspension of unit class 680.



Measured rail profiles track geometric parameters, wheel profiles and suspension and damping elements characteristics used in vehicle construction are used such as inputs for simulation calculations.

Dynamical model which is due to kinematical and force characteristics nonlinear is subsequently solved by finite differences method.

System of vehicle running is at Rail Vehicles section of Transport Means Department developed since 1993. This system were used e.g. for verification of train backing movement or running behavior modeling of unit class 680 before their shipping with the view of vehicle-track interaction and operation of a body tilting system.

Presently some elements of the model is edited with the aim of coming close to real measurements in the course of solving vehicle-track interaction tasks especially in high speeds (vehicle passing over a turnout, modeling of railhead wavelike irregularities, etc.)

There is shown vertical acceleration signal on an axle box record of unit class 680 in the course of passing over turnout frog area and its comparison with simulation calculation in fig. 10.

The passing over a turnout was modeled simply such as running on theoretical track with lateral irregularity accordant with a measured trajectory of a turnout frog area.

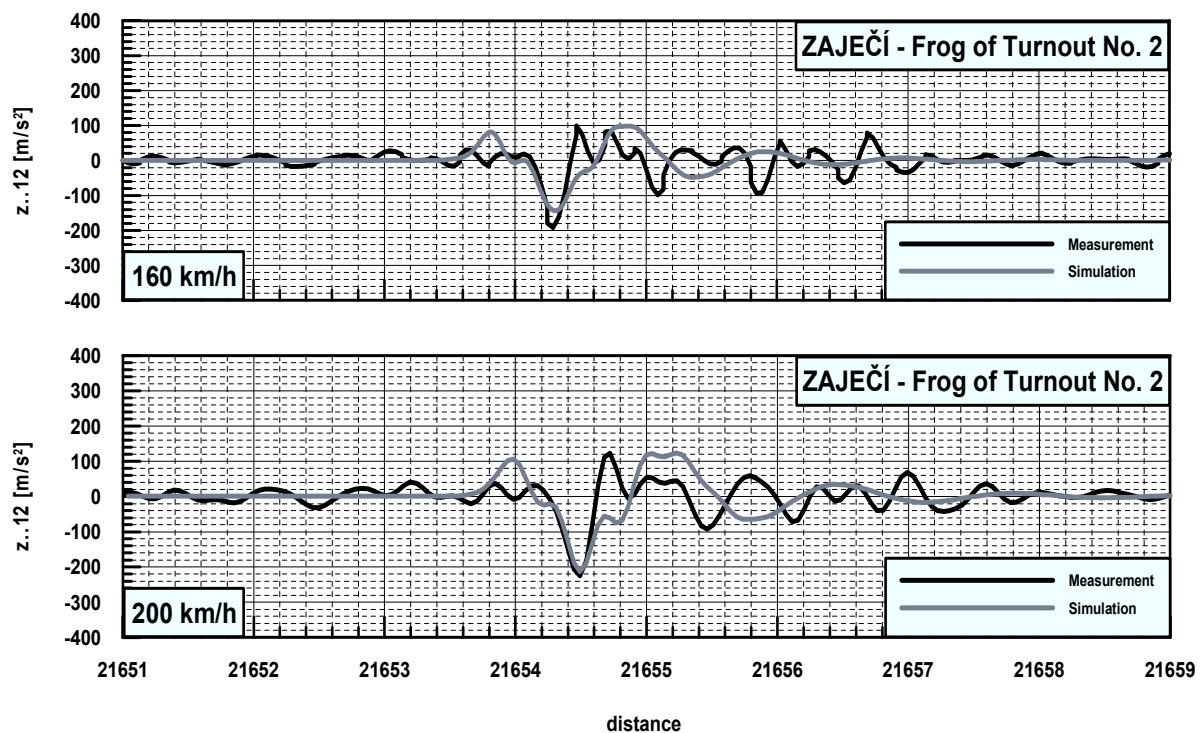

Fig. 10. Measurement and simulation calculation comparison in the course of passing over a turnout frog area.

## 7. Conclusion

Vehicle dynamic effects in the course of passing over a turnout in straight direction in high speed are greatly influenced by lateral rail profiles in the frog area. Unsuitable geometry results in higher stress of turnout's parts as well as especially unsuspended vehicle parts. An extensive research activity proved that increasing of vehicle dynamic effects caused by turnout frog area unsuitable geometry is shown up to speed 160 km/h. Verification of turnout's state in lower speed is not arguable.

## **Acknowledgements**

This contribution was supported also by project of MŠMT No. 1M4977751302 – Research centre of Rail vehicles.

## **References**

- [1] A. Hába, J. Zelenka, Possibilities of experimental checkout of turnouts operational durability, Proceedings of 4th International Scientific Conference – Challenges in Transport and Communication, Pardubice, University of Pardubice, pp. 1241-1246.
- [2] A. Hába, J. Zelenka, M. Musil, Determination of Railway Vehicle Dynamic Forces Running Through Switches at I. Corridor of ČD, Proceedings of 21th International Colloquium - Advanced Manufacturing and Repair Technologies in Vehicle Industry, Balatonfüred, BME, 2004, pp. 134-138.
- [3] J. Zelenka, Geometrical interaction of railway wheelset by passing through turnouts of Czech Railways corridor tracks, Proceedings of 5th Specialized Conference on Welding in Railway Transport, Česká Třebová, University of Pardubice, 2003, pp. 79-86.
- [4] J. Zelenka, A. Hába, M. Musil, Measuring of acceleration on vehicle 681 001-4 axle boxes in track line Břeclav – Hrušovany u Brna, Measurements report ZL AL DFJP, University of Pardubice, 2004.
- [5] J. Zelenka, A. Hába, M. Musil, M. Kohout, Measuring of acceleration on vehicle 681 001-4 axle boxes in track line Česká Třebová – Hoštejn, Measurement report ZL AL DFJP, University of Pardubice, 2006.
- [6] J. Zelenka, A. Hába, M. Musil, M. Kohout, S. Vitoušová, Measuring of acceleration on vehicle 681 001-4 axle boxes in track line Zámorsk – Pardubice, Measurements report ZL AL DFJP, University of Pardubice, 2005.