

A compact size microstrip five poles hairpin band-pass filter using three-layers structure for Ku-band satellites application

Qazwan Abdullah¹, Nor Shahida Mohd Shah², Nabil Farah³, Waheb A. Jabbar⁴,
Noorsaliza Abdullah⁵, Adeeb Salh⁶, Jameel A. A. Mukred⁷

^{1,2,5,6,7}Faculty of Engineering Technology, Universiti Tun Hussein Onn Malaysia, Pagoh, Muar, Johor, Malaysia

⁴Faculty of Engineering Technology, University Malaysia Pahang, Gambang, Pahang, Malaysia

³Faculty of Electrical Engineering, Universiti Teknikal Malaysia Melaka, Melaka, Malaysia

Article Info

Article history:

Received May 23, 2019

Revised Nov 24, 2019

Accepted Dec 21, 2019

Keywords:

Band-pass

Filter

Multi-layer hairpin

Reduced size

Size reduction

ABSTRACT

This paper presents a reduced size microstrip five poles hairpin band-pass filter using three-layers structure for Ku-band satellites application. The three-layers structure shows a substantially reduced filter size and enlarged bandwidth. The filter has been designed based on five-pole resonators at 12.475 GHz and bandwidth of 550 MHz. This filter is designed on Rogers RO3003 substrate having relative permittivity (ϵ_r) of 3. The proposed band-pass filter has been designed with the help of Computer Simulation Technology (CST) software. Comparison analyses between the simulated insertion loss and reflection coefficient of RO3003 and FR4 substrates have been carried out in order to show the efficiency of the proposed filter design. Based on the obtained results, the proposed filter design achieves significant filter size reduction compared to other band-pass filters.

This is an open access article under the [CC BY-SA](https://creativecommons.org/licenses/by-sa/4.0/) license.



Corresponding Author:

Qazwan Abdullah,
Faculty of Engineering Technology,
Universiti Tun Hussein Onn Malaysia,
86400 Parit Raja, Johor, Malaysia.
Email: gazwan20062015@gmail.com

1. INTRODUCTION

In recent decades, the requirement for compacted size and high-efficiency microwave filters is increasing rapidly in different communication applications [1-6]. Reliable theoretical designing and structure of microwave filters are satisfying recent and exciting difficulties to realize extraordinary requirements and applications [7, 8]. Filtering technology entails high-performance, compact size, lightweight and less cost [9, 10]. In order to satisfy these requirements, numerous types of planar microstrip filters, like resonator filters, open-loop resonator filters, and stepped impedance resonator filters were introduced [11, 12]. But, planar microstrip filters are applied on a single microstrip substrate layer that usually comprises a big size [13]. Multilayer band-pass structure solves this problem [14, 15]. For the last decade, the subject concerned significant interest and multilayer structure methods have been introduced in order to reduce the size and increase the bandwidths of the microstrip filters [16-24].

This study proposes a design of two-port network band-pass filter operating at 12.475 GHz for satellites Ku band applications. The band-pass filter limits the pass-band between certain lower and upper-frequency limits, in which the signal is attenuating whether lower (band-pass) or higher (band-stop) in comparison to remaining frequency bands [25, 26]. The microstrip design approach is selected in which

the parallel coupling lines model is used to show the behavior of the filter on the multilayer substrate. A $\lambda/4$ impedance transformer was used to connect each pair of parallel coupled lines.

The basic principles of microwave filters, design arrangements and performance evaluations were studied in this research. The outcome of this study has a sharp frequency response, lower insertion loss and decent reflection loss compared to previous works. The paper is organized as follows: the calculation of filter dimension as showed in section two, filter design configuration and methodology are presented in section three. EM simulation results are discussed and analyzed in the fourth section and finally, the conclusion of the work is drawn in section four.

2. SYSTEM DESIGN

Explaining Filter calculation starts by converting low pass to bandpass filter prototype. A microstrip hairpin bandpass filter is built to obtain a fractional bandwidth (FBW) = 0.044 at a mid-band frequency $f_0 = 12.475$ GHz. A five poles ($n = 5$) Chebyshev low-pass system with pass-band ripples of 0.1 dB is selected. The low-pass system parameters are provided for scaled low-pass cut off frequency which are; $\Omega c = 1$, $g_0 = 1.0$, $g_1 = g_5 = 1.1468$, $g_2 = g_4 = 1.3712$, and $g_3 = 1.9750$. The subsequent step in designing the filter is finding the dimensions of coupled microstrip lines that emulate the required characteristics as shown in Table 1. For the first coupling section

$$\frac{J_{01}}{Y_0} = \sqrt{\frac{\pi \text{ FBW}}{2 g_0 g_1}} \quad (1)$$

for intermediate coupling section

$$\frac{J_{k+1,k}}{Y_0} = \frac{\pi \text{ FBW}}{2} \frac{1}{\sqrt{g_k g_{k+1}}} \quad k = 1 \text{ to } n - 1 \quad (2)$$

for final coupling section

$$\frac{J_{n,n+1}}{Y_0} = \sqrt{\frac{\pi \text{ FBW}}{2 g_n g_{n+1}}} \quad (3)$$

to find even-and odd mode impedances

$$(Z_{0e})_{j,j+1} = \frac{1}{Y_0} \left[1 + \frac{J_{j,j+1}}{Y_0} + \left(\frac{J_{j,j+1}}{Y_0} \right)^2 \right] \quad j = 0 \text{ to } n \quad (4)$$

$$(Z_{0o})_{j,j+1} = \frac{1}{Y_0} \left[1 - \frac{J_{j,j+1}}{Y_0} + \left(\frac{J_{j,j+1}}{Y_0} \right)^2 \right] \quad j = 0 \text{ to } n \quad (5)$$

Table 1. Even-mode and odd-mode characteristics impedances

j	$\frac{J_{j,j+1}}{Y_0}$	$Z_{0e_{j,j+1}}$	$Z_{0o_{j,j+1}}$
0	0.468	85.93	39.6092
1	0.287	65.16	43.37
2	0.173	58.1839	46.88

The aid of computer design ADS (advanced Design System) can be used to calculate the dimensions of each resonator using the odd and even mode values in Table 1. The characteristic impedance Z_0 typically is assumed as 50 Ohms. Each stage of length is chosen to be guided wavelength (λg) where it corresponds to an electrical length (Eeff) as 90° . From the schematic design using the special function "LineCalc", the dimensions of each stage are calculated, for materials RO3003. The calculated dimensions are then used to design and simulate using CST software as shown in Figure 1 and Figure 2.

2.1. Design the proposed band-pass filter

The three-layer architecture of the reduced size band-pass filter primarily consists of a core material (RO3003), ground plane and epoxy material which is used to fill the spacing between the core material and the ground. The physical structure for proposed multilayer filter construction is presented as in Figure 3. Using three layers printed circuit board (PCB), the multilayer construction is created as follows: The first

layer is copper foil followed by the second layer which is made of epoxy material. Finally, the core material that contains the upper and lower resonators is constructed as the third layer of the PCB board.

A three-layer hairpin filter structure is designed based on parallel-coupled line microstrip filters. The key concept is obtaining good coupling effects via folding the resonators out of a parallel-coupled transmission line. To accomplish robust coupling between resonators, adjacent resonators are overlapped on different layers. The filter dimensions are optimized for response improvement. The length of hairpin resonators become very short because the filter is operating at high frequency, thus, hairpin structure is the optimum shape for designing this filter [19]. The framework of the resonators is illustrated in Figure 3, where resonators 1, 3 and 5 are located on the surface of the third layer dielectric, while resonators 2 and 4 are positioned on the reverse surface of the dielectric. Adjacent resonators lines are located on a different variation of overlapping because the resonators are implemented in a two-layer structure to achieve filter design requirements. The filter design specifications are summarized in Table 2 comparing them with simulation values.

The filter core material is realized by using Rogers (RO3003) substrate having relative permittivity (ϵ_r) of 3. The dimensions of the core material of the filter have been optimized several times to obtain the required response that fulfills the design specifications. Figures 4 (a) and (b) shows the optimized physical layout of the upper and bottom resonators of the filter. The total dimensions for the filter are $9.585 \times 14.935 \times 1.155 \text{ mm}^3$. Table 3 shows the physical dimensions of the filter after the optimization process.

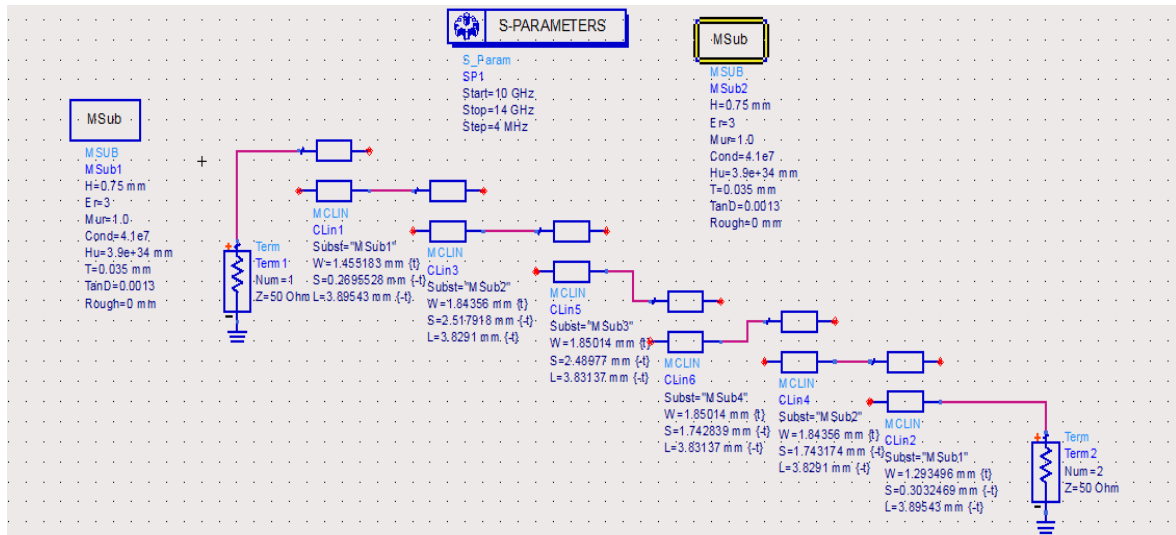

Figure 1. the calculation of filter dimensions in ADS

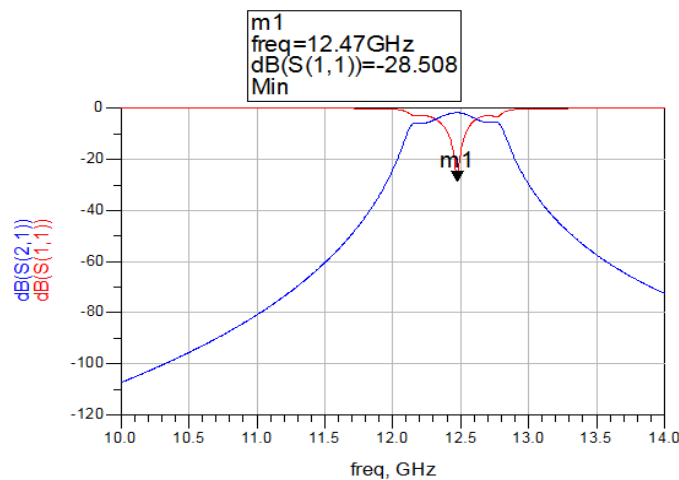

Figure 2. The response of filter dimensions in ADS

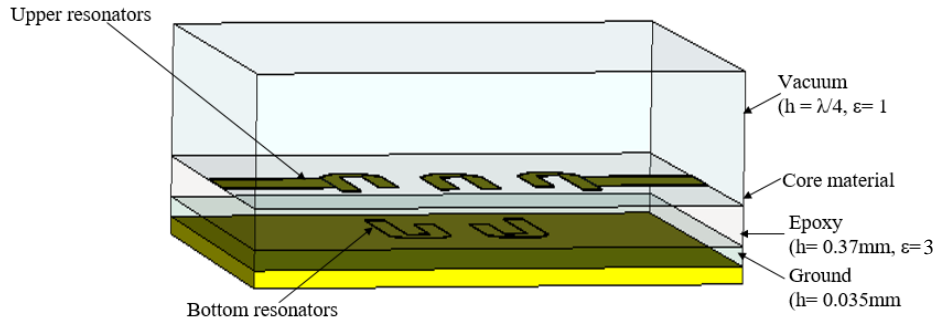

Figure 3. Multilayer construction of the proposed band-pass filter

Table 2. Simulation results using CST and filter design specifications

Parameters	Simulation Values	Filter Specifications
Lower cut-off frequency (fC), GHz	12.206	12.2
Upper cut-off frequency (fL), GHz	12.629	12.75
Insertion loss (S21), dB	-2.297	> -3
Return loss (S11), dB	-21.51	< -20
Bandwidth, MHz	429	550
Center frequency	12.449	12.475

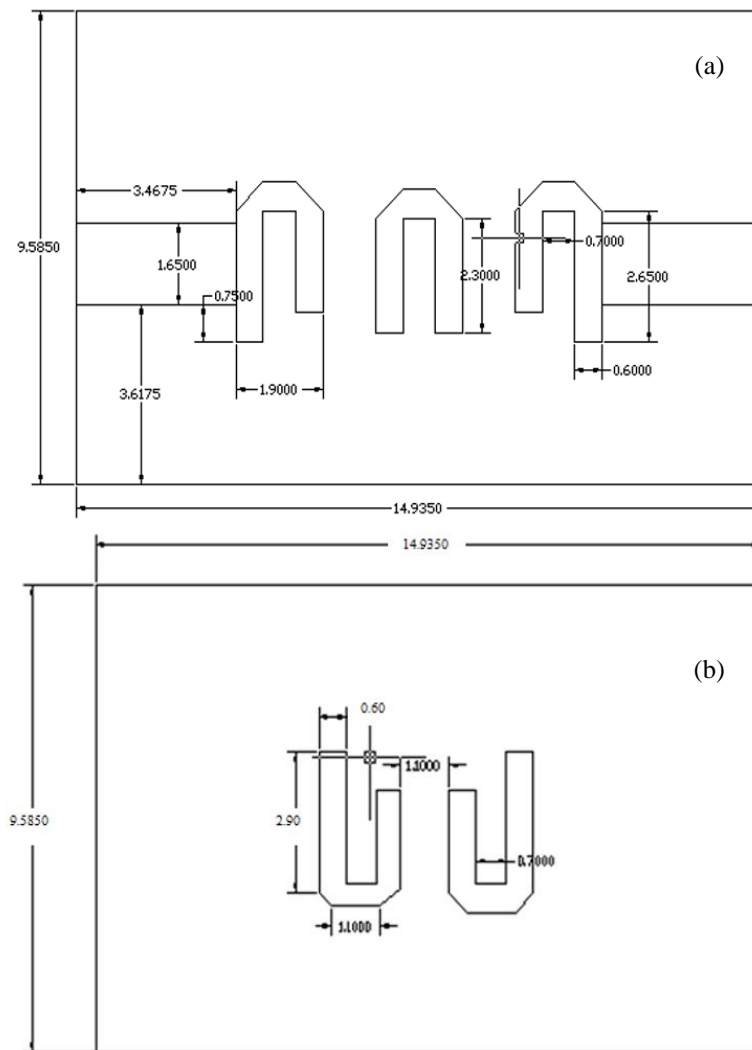

Figure 4. The physical structure of: (a) the upper resonators, (b) bottom resonators

Table 3. Physical dimension after optimization

Parameter	Value (mm)
Feeder length, lf	3.4675
Feeder width, wf	1.65
Width of resonator, w	1.50
Gap between resonators on top layer, gt	1.15
Gap between resonators on inner layer, gi	1.1

3. RESULTS AND ANALYSIS

The filter model is designed and modeled with the help CST Microwave Studio (CST MWS) simulator. For achieving the target specification as tabulated in Table 2, the filter scattering parameters were computed. The simulated multilayer hairpin band-pass filter exhibits low insertion loss of -2.3 dB and a reflection coefficient of better than -21 dB as depicted in Figure 5. Some further dimension optimization is needed to achieve a better reflection coefficient and the exact bandwidth. Other factors that may contribute to simulation errors are due to the material loss, substrate loss tangent and the adhesive epoxy that is used to join the filter layers. However, regarding the design specifications and multilayer filter structure discrepancies, the achieved S-parameter results are still acceptable.

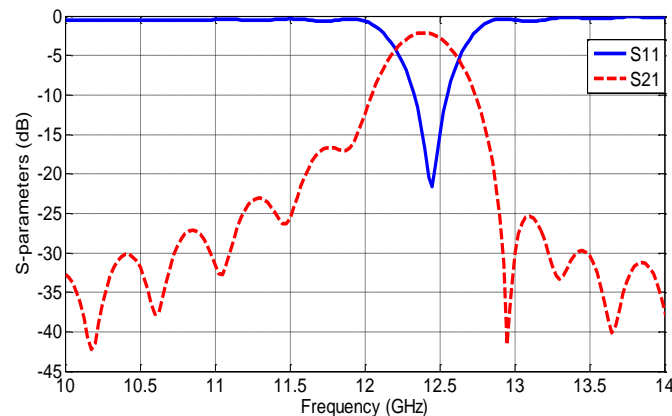

Figure 5. Simulated S-parameters of the filter using R03003 substrate

3.1. Parametric studies

This band-pass filter design has several adjustable parameters that need to be studied. This provides a further study of the filter behavior and comprehension of its functionality and performance. Therefore, this section will introduce some parametric studies and analyses that have been carried out using the sweep parametric function of the electromagnetic simulation software CST Microwave Studio.

For the aim of performance comparison, a Flame Retardant 4 (FR4) substrate with dielectric parameter (ϵ_r) of 4.6 is also utilized as the core material of the filter. Changing the core material of the multilayer hairpin filter from RO3003 substrate to FR4 substrate had affected the filter behavior. Figure 6 shows the S-parameter comparison of the two dielectric substrates as the core material of the filter. By comparing the simulation results of the design using RO3003 and FR4, it can easily be observed the advantage of using a substrate with lower dielectric constant and loss tangent. Rogers RO3003 substrate performed better than FR4 substrate by improving the filter response (lower insertion loss and higher reflection coefficient).

The effect of increasing the resonator length (L) on the filter S-parameters and bandwidth performance is thoroughly examined. The lengths of the resonators are varied from the original length (L) to $L+0.2$ and $L+0.3$ while the resonators widths (W) are kept constant. By increasing the length of the resonators, the bandwidth response of the filter shifts to the left and vice versa. Figures 7 and 8 illustrate the effect of increasing the lengths of the resonators on the location of the bandwidth. It can be observed from Figure 9 that the reflection coefficient response of the filter decreases, and the insertion loss drops when the resonator lengths are increased.

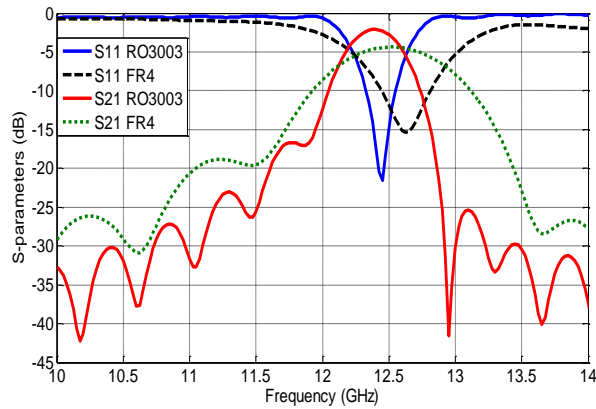

Figure 6. Performance comparison of simulated S-parameters of the filter using RO3003 and FR4 substrates as core materials

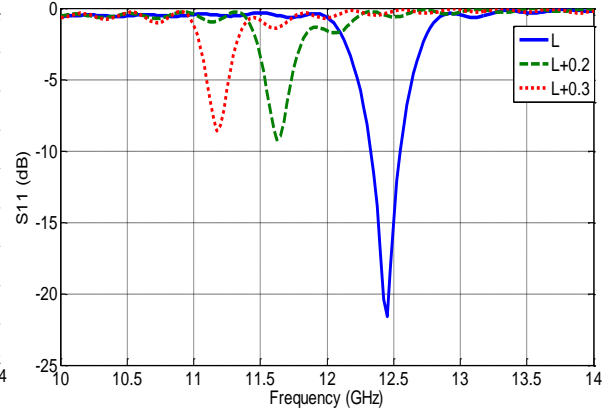

Figure 7. Reflection coefficient shifting (S11) by varying the length of the resonator using RO3003 substrate

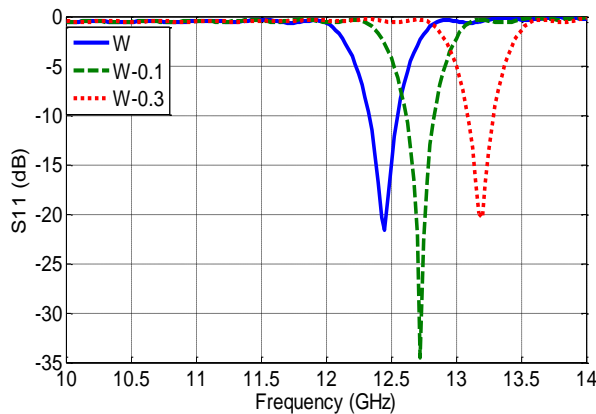

Figure 8. Reflection coefficient shifting (S11) by varying the width of the resonator using RO3003 substrate

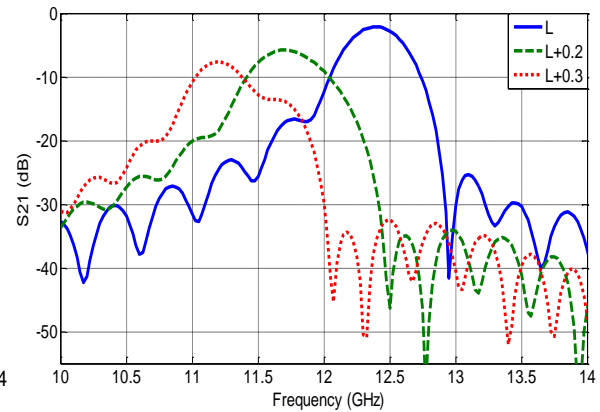

Figure 9. Insertion loss shifting (S21) by varying the length of the resonator using RO3003 substrate

For assessing the impacts of the resonator width on scattering parameter behavior of the filter, the widths of the resonators were varied and each time the simulated results were computed. Similar to the resonator length, the widths of the resonators are varied from the original width (W) to $W-0.1$ and $W-0.3$ while the resonators lengths (L) are kept constant. By decreasing the width of the resonators, the bandwidth of the filter shifts to the right and vice versa.

The simulated results in Figures 8 and 10 reveals that the effect of increasing the width of the resonators on the location of the bandwidth. However, increasing the resonator widths will not cause much effect on reflection coefficient (S_{11}) and insertion loss (S_{21}) performance, but only causes bandwidth shift to the right.

By increasing the wavelength (λ), the physical size of the filter will increase because it has been considered that the length of the feeders is $\lambda/4$ and the distance between the resonators and the edge of the filter on the upper and the bottom sides is $\lambda/4$ as well. Another effect of increasing the wavelength is to decrease the magnitude of the return loss (S_{11}) and not much change in the value of the insertion loss (S_{21}). Figures 11 and 12 show the effect of increasing the wavelength and its effect on both the return loss and the insertion loss respectively. All these analyses have been done by using the sweep parameter function in the simulation software (CST) to ease the study of the effectiveness of changing one of the parameters of the filter rather than using the normal method (change the dimension one at a time and simulate).

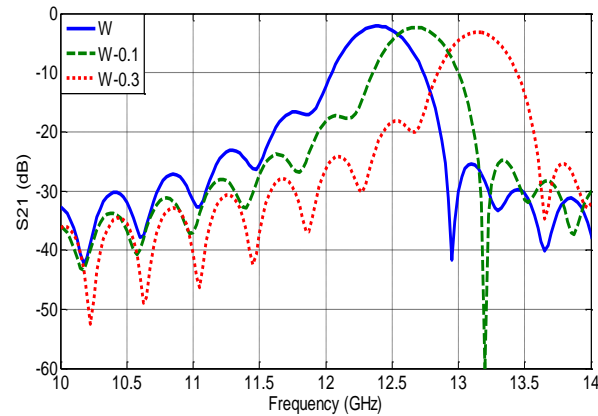

Figure 10. Insertion loss shifting (S_{21}) by varying the width of the resonator using RO3003 substrate

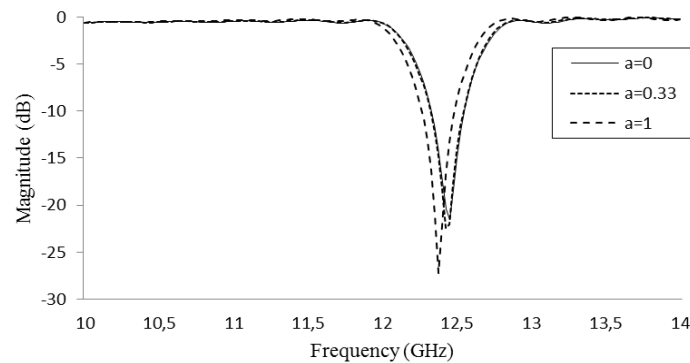

Figure 11. Return loss (S_{11}) by varying the wavelength (λ)

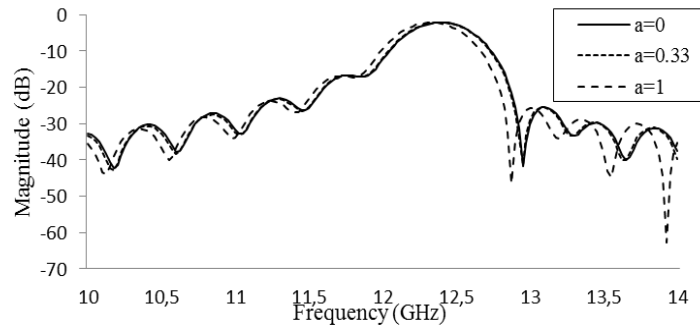

Figure 12. Insertion loss (S_{21}) by varying the wavelength (λ)

4. CONCLUSION

In this paper, a compact multilayer hairpin microstrip band-pass filter based on parallel-coupled line resonators for Ku-band applications is designed and modeled with the help of CST microwave studio software. The multilayer hairpin filter introduced a significant size reduction and better performance compared to other band-pass filters namely, combine filter, inter-digital filter, and parallel-coupled line filter. The simulated insertion loss and reflection coefficient results show a good match with the required specifications of this study. Using the sweep parameter function of the CST software, significant analysis and parametric study of the filter was performed. The proposed filter design achieves a good filter size reduction and the parametric studies introduce a simple technique of controlling the behavior and analyzing the performance of the filter.

ACKNOWLEDGMENTS

The authors would like to acknowledge the funding support provided by Universiti Tun Hussein Onn Malaysia (UTHM) under the Multidisciplinary Research (MDR) grant vot H470 and part by Universiti Malaysia Pahang (UMP) under the Fundamental Research Grant from the Ministry of Education Malaysia (MOE) No. FRGS/1/2018/TK04/UMP/02/11 (RDU190133).

REFERENCES

- [1] I. C. Hunter, et al., "Microwave filters-applications and technology," *IEEE Transactions on Microwave Theory and Techniques*, vol. 50, no. 3, pp. 794-805, Mar 2002.
- [2] J. Ni, "Development of tunable and miniature microwave filters for modern wireless communications," Ph.D. diss., Engineering & Physical Sciences, Heriot-Watt University, 2014.
- [3] M. K. Alkhafaji, et al., "Design of a selective filter-antenna with low insertion loss and high suppression stopband for WiMAX applications," *International Journal of Sensor Networks and Data Communications*, vol. 5, no. 3, pp. 1-7, 2016.
- [4] S. E. Jasim and M. A. Jusoh, "Design Broad Bandwidth Microwave Bandpass Filter of 10 Ghz Operating Frequency Using Hfss," *Proceedings of 119th The IIER International Conference, Putrajaya, Malaysia*, pp. 31-34, Sep 2017.
- [5] D. Marpaung, et al., "Low-power, chip-based stimulated Brillouin scattering microwave photonic filter with ultrahigh selectivity," *Optica*, vol. 2, no. 2, pp. 76-83, 2015.
- [6] I. Azad, et al., "Design and performance analysis of 2.45 GHz microwave bandpass filter with reduced harmonics," *International Journal of Engineering Research and Development*, vol. 5, no. 11, pp. 57-67, Feb 2013.
- [7] R. J. Cameron, et al, "Microwave Filters for Communication Systems: Fundamentals, Design, And Applications," 2nd ed., John Wiley & Sons, Inc, 2018.
- [8] L. T. Phuong, et al, "Research, design and fabrication of a microwave active filter for nanosatellite's receiver front-ends at s-band," *TELKOMNIKA Telecommunication Computing Electronics and Control*, vol. 17, no. 1, pp. 23-31, Feb 2019.
- [9] J. Zaidi, et al., "High-Performance Compact Microwave Filters for Space Applications," *Proceedings of 2012 9th International Bhurban Conference on Applied Sciences & Technology (IBCAST)*, pp. 379-382, 2012.
- [10] Y. X. Ji, et al., "Compact and high-performance bandpass filter based on an improved hybrid resonator using beeline compact microstrip resonator cell (BCMRC)," *Journal of Electromagnetic Waves and Applications*, vol. 25, no. 11, pp. 1525-1535, Jan 2011.
- [11] D. M. Pozar, "Microwave Engineering," 4th ed. John Wiley & Sons, Inc., Nov 2011.
- [12] K. Gupta, "Review of Planar Microstrip Filters For wireless communication," *International Journal of Scientific Research Engineering & Technology (IJSRET), EATHD 2015 Conference Proceeding*, pp. 77-83, 2015.
- [13] R. E. Collin, "Foundations for Microwave Engineering," 2nd Edition, Wiley-IEEE Press, Jan 2001.
- [14] M. H. Weng, et al., "Miniaturized multilayer hairpin bandpass filter with tunable transmission zeros," *Microwave and Optical Technology Letters*, vol. 41, no. 1, pp. 53-55, Feb 2004.
- [15] D. Tošić and M. Potrebić, "Compact Multilayer Bandpass Filter with Modified Hairpin Resonators," *Journal of Microelectronics, Electric Components and Materials*, vol. 42, no. 2, pp. 123-130, 2012.
- [16] Y. Jen and M. Lin, "Design and Fabrication of a Narrow Bandpass Filter with Low Dependence on Angle of Incidence," *Coatings*, vol. 8, no. 7, pp. 231-238, Jun 2018.
- [17] H. Oraizi and N. Azadi-tinat, "Optimum Design of Novel UWB Multilayer Microstrip Hairpin Filters with Harmonic Suppression and Impedance Matching," *International Journal of Antennas and Propagation*, vol. 2012, Sep 2012.
- [18] X. Gu, et al., "A Compact Hairpin Bandpass Filter Using Multilayer Stripline Folded Quarter-Wavelength Resonators," *Microwave and Optical Technology Letters*, vol. 54, no. 11, pp. 2627-2629, Nov 2012.
- [19] H. Adam, et al., "X-band miniaturized wideband bandpass filter utilizing multilayered microstrip hairpin resonator," *Progress in Electromagnetics Research*, vol. 93, pp. 177-188, 2009.
- [20] K. Vidhya and T. Jayanthi, "Performance Enhancement of Microstrip Hairpin Band Pass Filter Using Dumbbell DGS and Split Ring Resonator DGS," *International Journal of Information and Electronics Engineering*, vol. 1, no. 1, pp. 59-64, Jul 2011.
- [21] S. Majidifar and M. Hayati, "New approach to design a compact triband bandpass filter using a multilayer structure," *Turkish Journal of Electrical Engineering & Computer Sciences*, vol. 25, no.5, pp. 4006-4012, Jan 2017.
- [22] B. A. Belyaev and V. V. Tyurnev, "Multilayer bandpass filter with extended lower and upper stop bands," *Optics letters*, vol. 40, no. 18, pp. 4333-4335, 2015.
- [23] T. Firmansyah, et al., "Bandwidth and Gain Enhancement of MIMO Antenna by Using Ring and Circular Parasitic with Air-Gap Microstrip Structure," *TELKOMNIKA Telecommunication Computing Electronics and Control*, vol. 15, no. 3, pp. 1155-1163, Sep 2017.
- [24] T. Rahim and J. Xu, "X-band Band-pass Frequency Selective Surface for Radome Applications," *TELKOMNIKA Indonesian Journal of Electrical Engineering*, vol. 16, no. 2, pp. 281-285, Nov 2015.
- [25] C. Bowick, "RF Circuit Design," 2nd ed., Elsevier, Oct 2007.
- [26] L. Maloratsky, "Passive RF and Microwave Integrated Circuits," 1st ed. Elsevier, Nov 2003.

BIOGRAPHIES OF AUTHORS

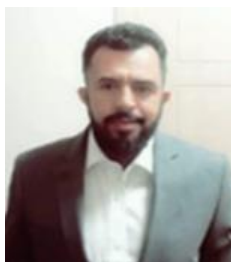

Qazwan Abdullah was born in Taiz, Yemen and received his bachelor's degree in Electrical and electronic engineering from Universiti Tun Hussein Onn Malaysia (UTHM) in 2013. He also received his Master of Science in Electrical and Electronic Engineering in 2015 from the same university. Currently, he is a Ph.D. student with research interests of control system, wireless technology and microwaves.



Nor Shahida. Mohd Shah. She received a Bachelor of Electrical and Electronics Engineering from Tokyo Institute of Technology, Japan in 2000. She then received MSc. in Physics from University of Malaya, Malaysia in 2003. She received a PhD in Electrical, Electronics and System Engineering from Osaka University, Japan in 2012. She is currently a Senior Lecturer in the Communication Engineering Department, Universiti Tun Hussein Onn Malaysia. Her research interests are optical and wireless communication.



Nabil Farah was born in Yemen in 1990. He has received a bachelor's degree in electrical engineering (power electronics and drives) from Universiti Teknikal Malaysia Melaka in 2015. And received a master's degree in electrical engineering in the same university. Currently, he is enrolled as a PhD student in electrical engineering also at the same university. Current research interest is the self-tuning fuzzy logic controller of AC Motor drives and predictive control of induction motor drives.



Waheb A. Jabbar received the B.Sc. in Electrical Engineering from the University of Basrah, Iraq, in 2001, the M.Eng. in Communication & Computer and the Ph.D. in Electrical, Electronics, and System Engineering from Universiti Kebangsaan Malaysia (UKM), Bangi, Selangor, Malaysia, in 2011 and 2015 respectively. He is currently a Senior Lecturer in the Faculty of Engineering Technology, Universiti Malaysia Pahang (UMP), Gambang, Pahang, Malaysia. His research interests include Routing Protocols in Ad Hoc Networks, Mobile Communications and Wireless Networking. He also has a keen interest in Internet of Things applications and Smart City.



Noorsaliza Abdullah received B. Eng. and M. Eng. degrees in Electronics and Telecommunications from Universiti Teknologi Malaysia (UTM), Malaysia, in 2003 and 2005, respectively, and her PhD degree from Shizuoka University, Shizuoka, Japan, in 2012. In 2003, she joined Universiti Tun Hussein Onn Malaysia (UTHM), Malaysia, as a Tutor and awarded a scholarship to further her M.Eng. and PhD degrees. Her research interest includes array antenna, adaptive beamforming, and mobilecommunications.



Adeeb Salh Currently a Ph.D. student at Faculty of Electrical and Electronic Engineering, Universiti Tun Hussein Onn Malaysia, Received the Bachelor of Electrical and Electronic Engineering, IBB University, IBB, Yemen (2007), and the Master Of Electrical and Electronic Engineering, University Tun Hussein Onn Malaysia, Malaysia (2014).



Jameel A. A. Mukred was born in Aden, Yemen and received his Bachelor's degree in Telecommunication and Electronics Engineering from Industrial Technical Institute, University of Aden (1978-1983). Received his Special License Degree (M.E.E), Electrical Engineering, Power Electronics, University of Aden (1983-1987). Received his Master of Electrical Engineering (M.E.E) – Mechatronics & Robotics, UTM, Johor, Malaysia (1996–1999) and finally received his Doctor of Electrical Engineering (Ph.D.) Mechatronics & Robotics, UTM, Johor, Malaysia (2008–2014). He was a Lecturer in UTM Johor (2004-2016), currently, he is a Lecturer in Universiti Tun Hussein Onn Malaysia (May 2019).