

H-infinity controller with graphical LMI region profile for liquid slosh suppression

Mohd Zaidi Mohd Tumari^{*1}, A. Shamsul Rahimi A. Subki², Mohd Shahrivel Mohd Aras³,
Mohammad 'Afif Kasno⁴, Mohd Ashraf Ahmad⁵, Mohd Helmi Suid⁶

^{1,2,3,4}Centre for Robotics and Industrial Automation (CeRIA),

Faculty of Electrical and Electronic Engineering Technology, Universiti Teknikal Malaysia Melaka,
Hang Tuah Jaya, 76100 Durian Tunggal, Melaka, Malaysia

³Faculty of Electrical Engineering, Universiti Teknikal Malaysia Melaka,
Hang Tuah Jaya, 76100 Durian Tunggal, Melaka, Malaysia

^{5,6}Faculty of Electrical and Electronics, Universiti Malaysia Pahang, 26600 Pekan, Pahang, Malaysia

*Corresponding author, e-mail: mohdzaidi.tumari@utem.edu.my

Abstract

This paper presents a H-infinity synthesis with pole clustering based on LMI region schemes for liquid slosh control. Using LMI approach, the regional pole placement known as LMI region combined with design objective in H-infinity controller guarantee a fast input tracking capability and very minimal liquid slosh. A graphical profile of the transient response of liquid slosh suppression system with respect to pole placement is very useful in giving more flexibility to the researcher in choosing a specific LMI region. With the purpose to confirm the design of control scheme, a liquid slosh model is considered to represent the lateral slosh movement. Supremacy of the proposed approach is shown by comparing the results with hybrid model-free fuzzy-PID controller with derivative filter. The performance of the control schemes is examined in terms of time response specifications of lateral tank tracking capability and level of liquid slosh reduction.

Keywords: H infinity, liquid slosh control, LMI region

Copyright © 2019 Universitas Ahmad Dahlan. All rights reserved.

1. Introduction

Normally, the uncontrolled free surface of liquid has an inclination to undergo large excursions, even for a very small movement of the container. Consequently, liquid sloshing has been a serious problem in many cases. For example, in the ship industries, the dynamic behavior of a vessel at sea is alarmingly troubled by the dynamics of moving partly filled tanks carried onboard [1]. However, controlling liquid slosh still faces plentiful degrees of difficulties that need to be considered before they can be used in much in everyday real-life applications. Feedback control or closed-loop control, which is well known to be less sensitive to disturbances and parameter variations, has been implemented for reducing the liquid slosh. These include active force control (AFC) [2], PID control [3-5], H-infinity control [6], sliding mode control [7], Variable Gain Super-twisting Algorithm (VGSTA) for output feedback control [8], hybrid fuzzy-PID controller [9], single input fuzzy logic controller [10] and data-driven PID tuning using SPSA algorithm [11].

In this study, H-infinity synthesis with pole clustering based on LMI techniques is used to control the liquid tank so that it can reach a desired position or track a prescribed trajectory accurately with minimum sloshing of liquid. The reason for choosing H-infinity synthesis is because of its good performance in handling with various types of control objectives such as disturbance cancellation, robust stabilization of uncertain systems, input tracking capability or shaping of the open-loop response. Nevertheless, the weakness of H-infinity controller is in handling with transient response behavior and closed-loop pole location instead of frequency aspects [12]. As we all know, a good time response specifications and closed-loop damping of liquid tank system can be achieved by forcing the closed-loop poles to the left-half plane. Moreover, many literatures have proved that H-infinity synthesis can be formulated as a convex optimization problem involving linear matrix inequalities (LMI) [13-15]. In this case, the normal Riccati equation with inequality condition was used. This behavior will give wide range of

flexibility in combining several constraints on the closed loop system. This flexible nature of LMI schemes can be used to handle H-infinity controller with pole placement constraints. In this work, the pole placement constraints will refer directly to regional pole placement [16]. It is slightly difference with point-wise pole placement, where poles are assigned to specific locations in the complex plane based on specific desired time response specifications. In this case, the closed-loop poles of liquid slosh model are confined in a suitable region of the complex plane. This region consists of wide variety of useful clustering area such as half-planes, disks, sectors, vertical/horizontal strips, and any intersection thereof [16]. Using LMI approach, the regional pole placement known as LMI region combined with design objective in H-infinity controller should guarantee a fast input tracking capability with very minimal liquid slosh.

H-infinity controller has been proven to be robust and tremendously beneficial in many linear and non-linear applications such as [17-23], however, for liquid slosh suppression are still lacking. The objective of the design is to actuate the system to a certain cart position with minimal slosh angle. The brief outline of this paper is as follows. In section 2, the liquid slosh model is described. In section 3, the H-infinity with LMI region method is explained. Simulation results and discussion are presented in section 4. Finally, some concluding remarks are given in section 5.

2. Liquid Slosh Model

A liquid slosh model in [24] that performing rectilinear motion as shown in Figure 1 is considered. Herein, a sloshing liquid modeled by a simple pendulum having a slosh mass, m and length, l is considered. Pendulum angle, θ represents the slosh angle. The system is like a moving rigid mass coupled with a simple pendulum as shown in Figure 2.

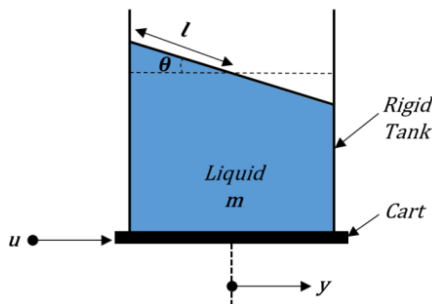

Figure 1. Liquid slosh motion

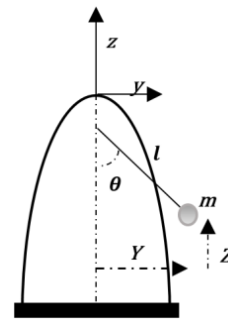

Figure 2. Slosh mass modeled by pendulum

The system parameters are as follows:

- M : mass of the tank and liquid
- m : mass of pendulum (slosh mass)
- l : hypotenuse length of the slosh (length of pendulum)
- u : force applied for translational motion
- y : displacement of rigid tank
- Y : displacement of m in the horizontal direction
- Z : displacement of m in the vertical direction
- θ : pendulum angle (slosh angle)
- g : gravity
- d : damping coefficient

The Euler-Lagrange equations in y and θ , which produce dynamic equations of the system, is given by

$$M\ddot{y} + ml\cos\theta\ddot{\theta} - ml\dot{\theta}^2\sin\theta = u, \quad (1)$$

$$ml\cos\theta\ddot{y} + ml^2\ddot{\theta} + d\dot{\theta} + mgl\sin\theta = 0, \quad (2)$$

Therefore, the control objective is to suppress the slosh angle θ in a moving tank while achieving a desired position y . The system parameters are depicted in Table 1. Note that these parameters depend on the liquid fill ratio, tank geometry and liquid characteristics. These parameters have been identified using a quick-stop experiment as reported in [25].

Table 1. Parameters of Liquid Slosh Model

| Parameter | Value | Unit |
|-----------|-------------------------|-----------|
| M | 6.0 | kg |
| m | 1.32 | kg |
| l | 0.052126 | m |
| g | 9.81 | m/s^2 |
| d | 3.0490×10^{-4} | kgm^2/s |

In (1) and (2) can be express in state space representation as follow [7]:

$$\dot{x} = Ax + Bu \quad (3)$$

$$y = Cx \quad (4)$$

where

$$x = [y \quad \dot{y} \quad \theta \quad \dot{\theta}]^T \quad (5)$$

$$A = \begin{bmatrix} 0 & 1 & 0 & 0 \\ 0 & 0 & 0 & 0 \\ 0 & 0 & 0 & 1 \\ 0 & 0 & -153.8447 & -0.0850 \end{bmatrix} \quad (6)$$

$$B = \begin{bmatrix} 0 \\ 1 \\ 0 \\ -9.5921 \end{bmatrix} \quad (7)$$

$$C = [1 \quad 0 \quad 0 \quad 0] \quad (8)$$

3. Design of H-infinity Controller with LMI Region

In this study, an integral state feedback control is used as a platform to design the proposed controller. The block diagram of integral state feedback control is shown in Figure 3.

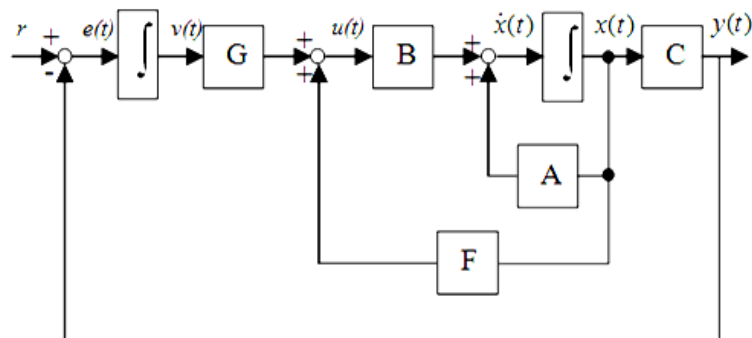

Figure 3. Block diagram of integral state feedback control

The main objective of the proposed controller is to find the gain parameter matrix, F and G such that it fulfills the design requirement. From the block diagram of Figure 3, the control input of the system is derived as follow:

$$u(t) = Fx(t) + Gv(t) \quad (9)$$

where $v(t) = \int_0^t e(\tau) d\tau$ and $e(t) = r - y(t)$ using new state variable $x_e = [x^T \ v]^T$ and (9) the representation of state space equation can be rewrite as

$$\begin{aligned} \begin{bmatrix} \dot{x}(t) \\ \dot{v}(t) \end{bmatrix} &= \begin{bmatrix} A & 0 \\ -C & 0 \end{bmatrix} \begin{bmatrix} x(t) \\ v(t) \end{bmatrix} + \begin{bmatrix} B \\ 0 \end{bmatrix} u(t) + \begin{bmatrix} 0 \\ 1 \end{bmatrix} r \\ e(t) &= r - Cx(t) \end{aligned} \quad (10)$$

next, at the steady state condition as $t \rightarrow \infty$, the state space equation can be written in the following form

$$\begin{aligned} \begin{bmatrix} 0 \\ 0 \end{bmatrix} &= \begin{bmatrix} A & 0 \\ -C & 0 \end{bmatrix} \begin{bmatrix} x(\infty) \\ v(\infty) \end{bmatrix} + \begin{bmatrix} B \\ 0 \end{bmatrix} u(\infty) + \begin{bmatrix} 0 \\ 1 \end{bmatrix} r \\ 0 &= r - Cx(\infty) \end{aligned} \quad (11)$$

by subtracting (10) to (11), the state space form is converted to

$$\begin{aligned} \dot{\tilde{x}}_e(t) &= \tilde{A}\tilde{x}_e(t) + \tilde{B}_2\tilde{u}(t) \\ \tilde{e}(t) &= \tilde{C}_1\tilde{x}_e(t) \end{aligned} \quad (12)$$

where

$$\begin{aligned} \tilde{A} &= \begin{bmatrix} A & 0 \\ -C & 0 \end{bmatrix}, \tilde{B}_2 = \begin{bmatrix} B \\ 0 \end{bmatrix}, \tilde{x}_e = \begin{bmatrix} \tilde{x} \\ \tilde{v} \end{bmatrix} = \begin{bmatrix} x - x(\infty) \\ v - v(\infty) \end{bmatrix} \\ \tilde{C}_1 &= [-C \ 0], \tilde{e}(t) = e - e(\infty) \end{aligned}$$

then, the new control input function is described as follow

$$\tilde{u}(t) = F\tilde{x}(t) + G\tilde{v}(t) = K\tilde{x}_e(t) \quad (13)$$

finally, a closed loop state space equation with controller gain, K can be obtained below

$$\begin{aligned} \dot{\hat{x}}_e(t) &= \tilde{A}_{cl}\tilde{x}_e(t) + \tilde{B}_1w \\ \tilde{y}(t) &= \tilde{C}_1\tilde{x}_e(t) + \tilde{D}_{11}w + \tilde{D}_{12}u \end{aligned} \quad (14)$$

where

$$\tilde{A}_{cl} = (\tilde{A} + \tilde{B}_2K), \tilde{B}_1 = [0 \ 0 \ 0 \ 0 \ -1], \tilde{D}_{11} = 1, \tilde{D}_{12} = 0$$

and w is exogenous input disturbance or reference input to the system. Let $G_{yw}(s)$ denote the closed loop transfer function from w to y under state feedback control $u = Kx$. Then, for a prescribed closed loop H-infinity performance $\gamma > 0$, our constrained H ∞ problem consists of finding a state feedback gain K that fulfil the following objectives:

- The closed loop poles are required to lie in some LMI stability region D contained in the left-half plane
- Guarantees the H ∞ performance $\|G_{yw}\|_{\infty} < \gamma$

The advantages of placing the closed loop poles to this region are the liquid slosh response ensures a minimum decay rate λ , a minimum damping ratio $\zeta = \cos \theta$, and a maximum undamped natural frequency $\omega_d = r \sin \theta$ [10]. In this study, the entire LMI problem is solved using well known LMI optimization software which is *LMI Control Toolbox*.

4. Results and Analysis

In this section, the proposed control scheme is implemented and tested within simulation environment of the liquid tank system and the corresponding results are presented. The simulation results are considered as the system response under liquid tank motion control and will be used to evaluate the performance of the proposed control scheme. The performances of the control schemes are assessed in terms of input tracking capability and liquid slosh suppression in time domain. Zero initial conditions were considered with a step input of 0.5 meter.

The parameter of conic sectors and disk that fulfil the design requirement is at $r = 2.5$, $\lambda = -1.5$ and $\theta = 28^\circ$. Then, the state feedback gain, K is obtained as followed:

$$K = [-0.5657 \quad -0.5433 \quad -11.8487 \quad -0.9802 \quad 0.2378]$$

with $\gamma = 27.742$. This state feedback gain also guarantees the H_∞ performance $\|G_{yw}\|_\infty < \gamma$. The result shows that the location of poles has been confined in the selected LMI region as shown in Figure 4 with the value of -2.2062 , $-2.3100 \pm j0.7825$ and $-1.6022 \pm j0.4701$. As a comparative assessment, the proposed control scheme is compared with hybrid model-free fuzzy-PID controller with derivative filter reported in the previous literature [9].

The simulation response of cart position, slosh angle, slosh rate and control input are depicted in Figures 5-8 respectively. Figure 5 shows that the tank settles to the desired position (0.5 m) in about 5.5s for H-infinity controller while for fuzzy-PIDF is 7.5s. As we can see, the rise time for H-infinity controller and fuzzy-PIDF controller is 2.6s and 3.5s, respectively. It is noted that, no overshoot occurred for both controllers. However, a noticeable amount of liquid slosh occurs during the movement of the cart.

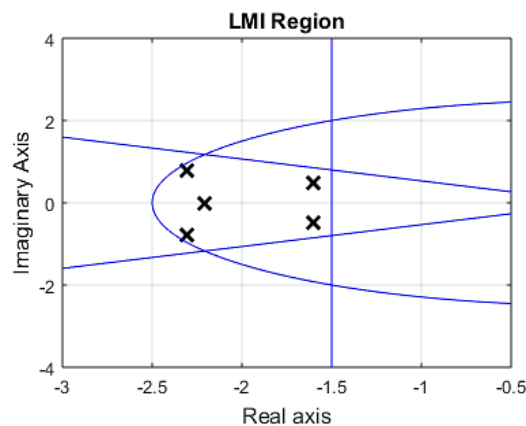

Figure 4. Location of poles in selected LMI region

Slosh is regulated nicely, as shown in Figure 6 and Figure 7 for both controllers. The slosh is settles within 6 s for H-infinity controller while for fuzzy-PIDF controller, the slosh is settles within 8s. Fuzzy-PIDF has a bigger slosh with a maximum residual of ± 0.1 radian compared to H-infinity with only ± 0.012 radian as shown in Figure 6. From the Figure 7, H-infinity controller has a better slosh rate with maximum residual ± 0.021 radian/sec as compared to fuzzy-PIDF with ± 1.1 radian/sec. Figure 8 shows the necessary control efforts. The control signal overshoots for a very short period (0.5s) when there is a step change in the command signal. The H-infinity has a less overshoot with 0.19 Newton compared to fuzzy-PIDF with 12.5 Newton and both control inputs are settles at 4s. Hence, we can confirm that the H-infinity with LMI region has a good potential in reducing the liquid slosh while maintaining the desired cart position. The control performance for both controllers is summarize in Table 2.

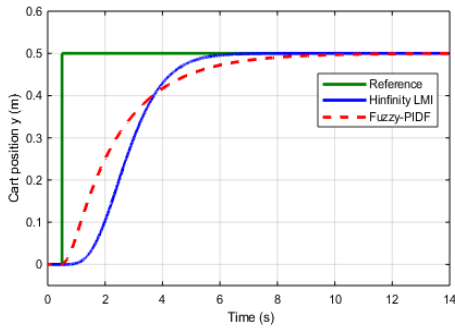

Figure 5. Cart position response

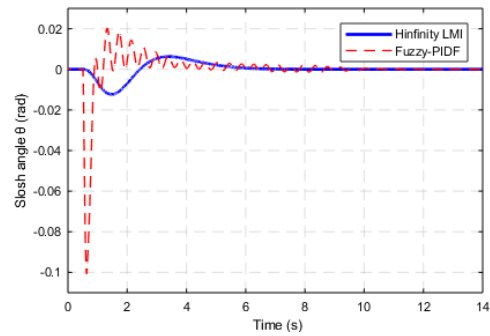

Figure 6. Slosh angle response

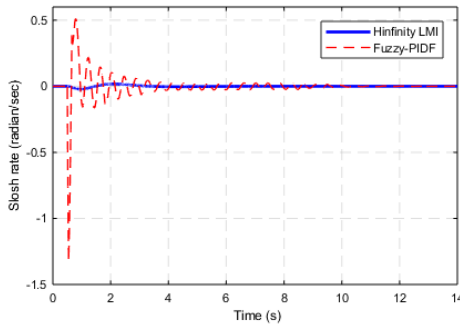

Figure 7. Slosh rate response

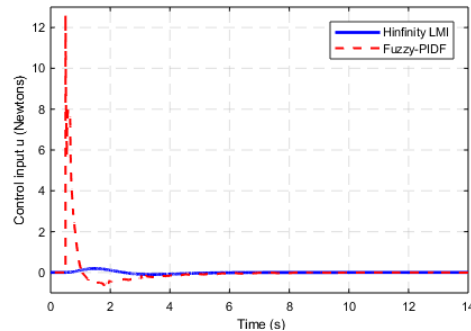

Figure 8. Control input response

Table 2. Time Response Specifications of Liquid Slosh System

| Controller | Settling Time, Ts (s) | Rise Time, Tr (s) | Percentage Overshoot, % OS (%) | Steady State error | Maximum Slosh angle, θ (radian) | Maximum Slosh rate (rad/sec) | Control input Overshoot (N) |
|-------------------|-----------------------|-------------------|--------------------------------|--------------------|--|------------------------------|-----------------------------|
| Hybrid Fuzzy-PIDF | 7.5 | 3.5 | 0 | 0 | 0.100 | 1.110 | 12.50 |
| H-infinity LMI | 5.5 | 2.6 | 0 | 0 | 0.012 | 0.021 | 0.19 |

5. Conclusion

In this study, the development of H-infinity synthesis with pole clustering based on LMI region schemes for liquid slosh suppression has been presented. The proposed method has been tested to liquid slosh model. To show the superiority of proposed control scheme, results are compared with hybrid fuzzy-PIDF controller. It is noted that significant improvements are obtained with H-infinity with LMI region controller. The simulation results demonstrate that the proposed control approach yields a minimal liquid slosh while achieving the desired cart position. From above analysis and discussion it is assured that the proposed control technique may become a suitable controller for solving the liquid slosh problem in aforementioned industries. Further investigation and experimentation for an online technique might be investigate using a motor-driven liquid slosh experimental rig.

Acknowledgment

This work was supported by Faculty of Electrical & Electronics Engineering Technology, Universiti Teknikal Malaysia Melaka under research grant PJP/2018/FTK(10B)/S01610 and FRGS/1/2017/ICT02/UMP/02/2.

References

[1] Krata P. Linear Characteristics of the Sloshing Phenomenon for the Purpose of On-Board Ship's Stability Assessment. *Journal of Theoretical and Applied Mechanics*. 2009; 47(2): 307-320.
 [2] Purnomo DS, Anom Besari AR, Darojah Z. Control of Liquid Sloshing Container using Active Force Control Method. *IOP Conf. Series: Materials Science and Engineering*. 2017; 190: 1-8.

- [3] Ahmad MA, Rohani MA, Raja Ismail RMT, Mat Jusof MF, Suid MH, Nasir ANK. *A Model-Free PID Tuning to Slosh Control using Simultaneous Perturbation Stochastic Approximation*. IEEE International Conference on Control System, Computing and Engineering (ICCSCE). George Town. 2015: 331-335.
- [4] Abdul SNS, Ahmad MA, Mohd Tumari MZ. *Data-driven PID Tuning based on Safe Experimentation Dynamics for Control of Liquid Slosh*. IEEE 8th Control and System Graduate Research Colloquium (ICSGRC). Shah Alam. 2017: 62-66.
- [5] Ahmad MA, Mustapha NMZA, Nasir ANK, Mohd Tumari MZ, Raja Ismail RMT, Ibrahim Z. *Using normalized simultaneous perturbation stochastic approximation for stable convergence in model-free control scheme*. IEEE International Conference on Applied System Invention (ICASI). 2018: 935-938.
- [6] Robu B, Baudouin L, Prieur C, Arzelier D. Simultaneous H-infinity vibration control of liquid/plate system via reduced-order controller. *IEEE Transactions on Control Systems Technology, Institute of Electrical and Electronics Engineers*. 2012; 20(3): 700-711.
- [7] Kurode S, Spurgeon SK, Bandyopadhyay B, Gandhi PS. Sliding Mode Control for Slosh-Free Motion Using a Nonlinear Sliding Surface. *IEEE/ASME Transactions on Mechatronics*. 2013; 18(2): 714-724.
- [8] Mishra JP, Kurode SR. *Robust Output-Feedback Control for Container-Slosh System using Variable Gain Super-Twisting Algorithm*. 13th IEEE Workshop on Variable Structure Systems. Nantes. 2014: 1-6.
- [9] Mohd Tumari MZ, Abd Rashid WN, Ab Hadi NA, Ahmad MA, Suid MH, Ghazali MR. Liquid Slosh Suppression by using Hybrid Model-Free Fuzzy-PID Controller with Derivative Filter. *Journal of Advanced Research in Dynamical and Control Systems*. 2018; 10 (Special Issue): 1423-1433.
- [10] Mohd Tumari MZ, Saat S, Johal MS, Bahari MF, Ahmad MA. Single Input Fuzzy Logic Controller for Liquid Slosh Suppression. *International Journal of Electrical Engineering and Applied Sciences*. 2019; 2(1): 45-52.
- [11] Mustapha NMZA, Mohd Tumari MZ, Suid MH, Raja Ismail RMT, Ahmad MA. Data-Driven PID Tuning for Liquid Slosh-Free Motion Using Memory-Based SPSA Algorithm. *Lecture Notes in Electrical Engineering*. 2019. 538: 197-210.
- [12] Chilali M, Gahinet P. H^∞ design with pole placement constraints: an LMI approach. *IEEE Transactions on Automatic Control*. 1996; 41(3): 358-367.
- [13] Gahinet P, Apkarian P. A linear matrix inequality approach to H^∞ control. *Int. J. Robust Nonlinear Control*. 1994; 4: 421-448.
- [14] Iwasaki T, Skelton R. All controllers for the general H^∞ control problem: LMI existence conditions and state-space formulas. *Automatica*. 1994; 30: 1307-1317.
- [15] Packard A. Gain scheduling via linear fractional transformations. *Syst. Contr. Lett.* 1994; 22: 79-92.
- [16] Chilali M, Gahinet P, Apkarian P. Robust pole placement in LMI regions. *IEEE Transactions on Automatic Control*. 1999; 44(12): 2257-2270.
- [17] Mohd Tumari MZ, Saealal MS, Ghazali MR, Abdul Wahab Y. *H^∞ controller with graphical LMI region profile for Gantry Crane System*. The 6th International Conference on Soft Computing and Intelligent Systems. Kobe. 2012: 1397-1402.
- [18] Mohd Tumari MZ, Saealal MS, Ghazali MR, Abdul Wahab Y. *H-infinity with pole placement constraint in LMI region for a buck-converter driven DC motor*. IEEE International Conference on Power and Energy (PECon). Kota Kinabalu. 2012: 530-535.
- [19] Prayitno A, Indrawati V, Arron C. H-Infinity Control for Pitch-Roll AR. Drone. *Telecommunication, Computing, Electronics and Control*. 2016; 14(3): 963-973.
- [20] Fard JM. Robust Multi-Objective Control of Power System Stabilizer Using Mixed H_2/H^∞ and μ Analysis. *International Journal of Electrical and Computer Engineering (IJECE)*. 2018; 8(6): 4800-4809.
- [21] Mohd Tumari MZ, Saealal MS, Abdul Wahab Y, Ghazali MR. H-Infinity Controller with LMI Region Schemes for a Lab-Scale Rotary Pendulum Crane System. *Int. J. System Signal Control Eng. Application*. 2012; 5(1): 14-20.
- [22] Zhao J, Mili LA. Theoretical Framework of Robust H-Infinity Unscented Kalman Filter and Its Application to Power System Dynamic State Estimation. *IEEE Transactions on Signal Processing*. 2019; 67(10): 2734-2746.
- [23] Waki H. Positive Definiteness in Linear Matrix Inequality Problem for H-Infinity Output Feedback Control Problem. *IEEE Control Systems Letters*. 2019; 3(2): 446-451.
- [24] Abramson HN. Analytical representation of lateral sloshing by mechanical models. NASA, Washington, DC, NASA Rep. SP-106. 1996: 199-224.
- [25] Joshi K. Modelling and analysis of fluid slosh under translation and pitching excitation. *M. S. Thesis*. Bombay: Indian Institute Technology. 2006.