

## Research of Driving Circuit in Coaxial Induction Coilgun

Yadong Zhang, Jiangjun Ruan, Yuanchao Hu\*, Ruohan Gong, Weijie Zhang, Kaipei Liu

School of Electrical Engineering, Wuhan University

Luo-jia-shan Wuchang, Wuhan, Hubei Province, P.R.China

\*Corresponding author, e-mail: huyuanchao3211@126.com

### Abstract

Catu daya merupakan peralatan penting dalam peluncur kumparan induksi koaksial. Konfigurasi rangkaian pengemudi mempengaruhi secara langsung efisiensi peluncur kumparan. Makalah ini memberikan analisis rinci tentang sifat konstruksi rangkaian pengemudi berbasis sumber kapasitor. Tiga topologi dari rangkaian pengemudi dibandingkan, meliputi rangkaian osilasi, crowbar dan setengah gelombang. Hal ini membuktikan bahwa rangkaian yang memiliki efisiensi yang lebih baik tergantung pada parameter rinci percobaan, terutama resistansi crowbar. Resistor crowbar tidak hanya mengatur efisiensi sistem, tetapi juga kenaikan suhu kumparan. Daya elektromagnetik (EMF) diterapkan pada armatur akan problem lain yang mempengaruhi kondisi layanan sirkuit pengemudi. Rangkaian osilasi dan crowbar seharusnya diterapkan pada peluncur kumparan induksi sinkron dan tak-sinkron. Rangkaian setengah gelombang kadangkala digunakan dalam percobaan. Meskipun efisiensi rangkaian setengah gelombang sangat tinggi, kecepatan armaturnya rendah. Sebuah rangkaian setengah gelombang independen sederhana diusulkan pada makalah ini. Secara umum, sifat komprehensif rangkaian crowbar adalah yang paling praktis pada tiga rangkaian khas tersebut. Simpulannya, makalah ini dapat memberikan pedoman praktis untuk rangkaian pengemudi.

**Keywords:** EML, coil launcher, power supply, efficiency, crowbar, circuit

### Abstract

Power supply is crucial equipment in coaxial induction coil launcher. Configuration of the driving circuit directly influences the efficiency of the coil launcher. This paper gives a detailed analysis of the properties of the driving circuit construction based on the capacitor source. Three topologies of the driving circuit are compared including oscillation, crowbar and half-wave circuits. It is proved that which circuit has the better efficiency depends on the detailed parameters of the experiment, especially the crowbar resistance. Crowbar resistor regulates not only efficiency of the system, but also temperature rise of the coil. Electromagnetic force (EMF) applied on the armature will be another problem which influences service condition of the driving circuits. Oscillation and crowbar circuits should be applied to both of the synchronous and asynchronous induction coil launchers, respectively. Half-wave circuit is seldom used in the experiment. Although efficiency of the half-wave circuit is very high, the speed of the armature is low. A simple independent half-wave circuit is proposed in this paper. In general, the comprehensive property of crowbar circuit is the most practical in the three typical circuits. Conclusions of the paper could provide guidelines for practice.

**Keywords:** EML, coil launcher, power supply, efficiency, crowbar, circuit

### 1. Introduction

A coaxial induction coil launcher use the Lorentz ( $\mathbf{J} \times \mathbf{B}$ ) force to accelerate a projectile with a conducting armature. Compared with conventional weapon, coil launcher has advantages of high efficiency, low cost, perfect control property and wide applicability [1]. At present, impulse capacitor is widely used as storage power equipment whose energy density, size and weight determine whether coil launcher could be used or not. Driving circuit configuration can also influence the launch efficiency, temperature rise and sustained repetition rate directly. However, people do not pay enough attention to the research of driving circuit than fire control and optimizations [2]. Some articles reach the opposite conclusions which puzzled a lot of people [3-5]. This paper gives a detailed analysis of the properties of the driving circuit construction based on the capacitor source.

Generally speaking, there are three typical driving circuits that have applied to coil launcher system, including oscillation circuit, crowbar circuit and half-wave circuit, which are shown in Figure 1, where,  $L$  is the self inductance of the coil;  $R_S$ ,  $R_C$ ,  $R_D$  are resistances of the system, the coil, the crowbar resistor respectively.

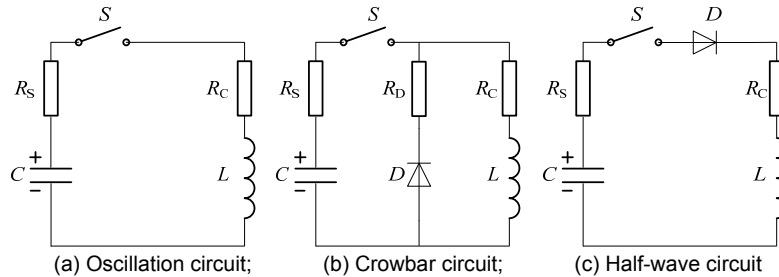

Figure 1. Three typical driving circuits

Oscillation circuit is a simple RLC circuit whose coil and capacitor suffers damped oscillation current (alternating current). Capacitors keeps charging and discharging until energy exhausting which will influence the service lifetime of capacitor. Alternating field in the bore will induce the alternating eddy current in the armature and propel the armature out of the barrel. In Figure 1(b), capacitor is shorted by crowbar diode when it releases the energy completely and voltage falls to zero. And then, driving coil and the crowbar diode make up a RL circuit. Thus, in the crowbar circuit, the current and flux in the coil will not change direction. When coils of the barrel are fed in sequence by a set of capacitor driven circuits, the coil launcher can be seen as the cylinder reconnection gun. Crowbar circuit could increase the service life of the capacitor and control the flow of current by crowbar resistor which is widely used not only in coil launcher but also in rail launcher. If the RLC circuit connects a diode in series, the oscillation circuit will turn to be half-wave circuit as shown in Figure 1(c). The capacitor will suffer high reverse voltage after discharge. The energy delivered to the armature is very limited which result in less use in practice. But half-wave circuit is very useful in some special situation, such as the research of sustained repetition launch.

## 2. Comparison of Oscillation Circuit and Crowbar Circuit

### 2.1. Simulation Models

With regard to oscillation circuit and crowbar circuit, reference [3] thought that oscillation circuit gain higher efficiency of energy transformation and muzzle velocity. In contrast, reference [4] argued that, under the same conditions, higher efficiency can be achieved from crowbar circuit rather than oscillation circuit. In order to verify which circuit is better, a simple single stage coil launcher is constructed as Figure 2. To fit the actual operational environment, the solid aluminum cylinder armature is assigned to an original velocity of 50m/s. The copper strand coil is powered by different external circuits which are shown in Figure 1(a) and Figure 1(b). All the driving circuits have the same capacitance (1.2 mF) and initial voltage (6 kV). The resistance of the circuit includes three parts as follows: system resistance  $R_S$  of 10 m $\Omega$  (includes internal resistance of the capacitor), coil resistance  $R_C$  of 10 m $\Omega$  and crowbar resistance  $R_D$  (just relative to crowbar circuit). Normally,  $R_S$  and  $R_C$  are the same and  $R_D$  is the major difference between the two circuits which influence the downtrend of the current. To research the influence of the crowbar branch circuit,  $R_D$  is changed from 0 to 100 m $\Omega$  every 25 m $\Omega$ . The models are calculated under transient solver in Ansoft Maxwell which has been widely used in coil launcher studies [6-8].

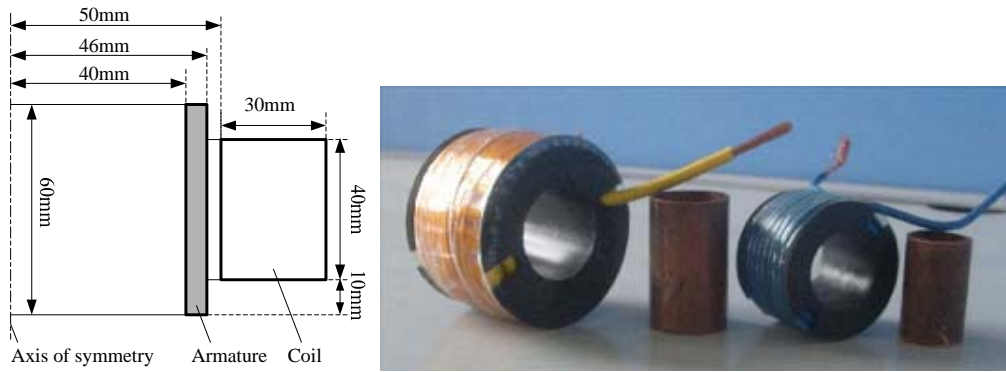

Figure 2. Geometry parameters of the single stage coil launcher

**2.2. Simulation Results**

Simulation results of the current in the coil and speed of the armature are shown in Figure 3 and Figure 4. It is shown that in a crowbar circuit, current and speed will decrease with the increase of the crowbar resistance. The greater the resistance is, the less the reduction of the speed and current will be. Figure 4 shows that if crowbar resistance is small enough, the muzzle speed and efficiency of the crowbar circuit will higher than that of the oscillation circuit. When there is no resistor in the crowbar branch, the crowbar circuit will gain the highest efficiency.

According to the above analysis result, reference [3] is more likely to choose a large crowbar resistance in the experiment whose current damped quickly and armature suffered great breaking force. The efficiency of the crowbar circuit is less than that of the oscillation circuit. In reference [4], the crowbar resistance is 0 which is one of the reasons why the efficiency of the crowbar circuit is higher. Another important reason is that coil resistance  $R_C$  is 0 in the simulation, which might be unreasonable in practice.

Thus, which circuit has the better efficiency depends on the detailed parameters of the experiment, especially the crowbar resistance.

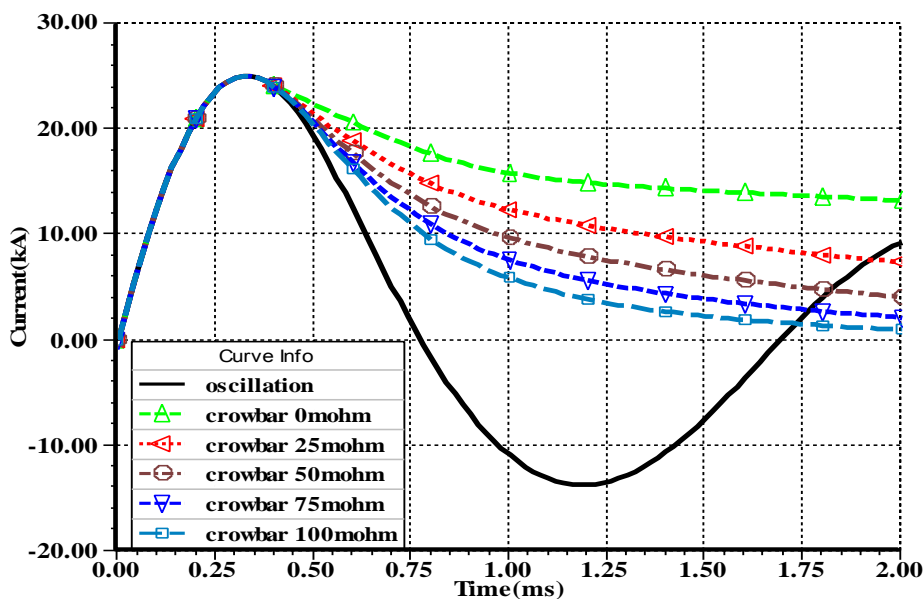

Figure 3. Current curves of the different driving circuits

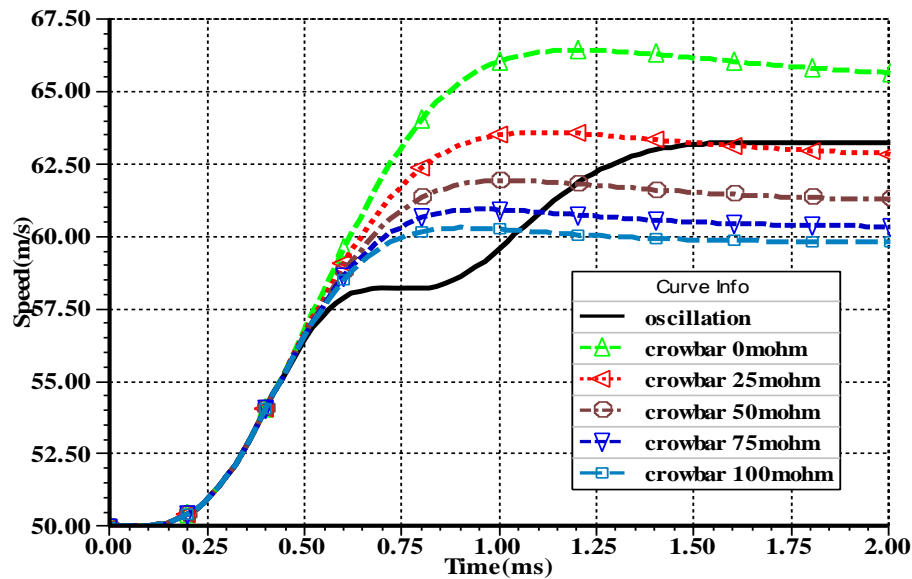

Figure 4. Speed curves of the different driving circuits

### 3. Temperature Rise and Electromagnetic Force of the Circuit

Besides efficiency, other important properties should also be considered, such as temperature rise and electromagnetic force.

#### 3.1. Temperature Rise

Different topological structure will influence the temperature rise of the coil greatly [6, 9]. Energy stored in the capacitor ( $E_C$ ) will translate into muzzle kinetic energy ( $E_K$ ) the armature gained and heat energy ( $E_R$ ) expended on the resistor. Assuming the oscillation circuit and crowbar circuit has the same  $E_C$  and  $E_K$ , and efficiencies of the two models are equal. The energy dissipated in the form of heat  $E_h$  of the armature in each section is given by Equation 1.

$$E_h = E_K \frac{S_{av}}{1 - S_{av}} \quad (1)$$

Where  $S_{av} = (S_0 + S_1)/2$  is the average slip in each section [10].

Since the transit time of the projectile through the barrel is only a few milliseconds, the heat transfer into the surrounding space is negligible. Therefore, the temperature rise of the armature in a section could be written as Equation 2.

$$\theta = \frac{1}{c \cdot G} E_h \quad (2)$$

Where,  $c$  and  $G$  are the specific heat and weight of the armature.

Due to the launcher has the ability to provide magnetic pressure to projectiles which results in near constant acceleration. And  $S_{av}$  in every section is almost the same. Then,  $\theta \propto E_h \propto E_K$ . In this case, the residual energy is consumed by the resistance of the driving circuit. Temperature rise of the coil is determined by the percentage of the coil resistance in the whole damping resistance. In the oscillation circuit, the ratio of the energy loss on the coil will not change which could be written as Equation 3.

$$\eta_{oscillation} = \frac{R_C}{R_C + R_S} \quad (3)$$

However, crowbar circuit has no distinction to oscillation circuit until the capacitor voltage decrease to zero (at 0.38ms in this model). Then, crowbar resistance  $R_D$  will replace the system resistance  $R_S$  and damping resistance will changed from  $(R_S + R_C)$  to  $(R_D + R_C)$ . The ratio of energy loss on the coil could be written as Equation 4.

$$\eta_{crowbar} = \frac{R_C}{R_C + R_D} \quad (4)$$

If  $R_D = R_S$ , coils in the two driving circuits will have the same resistance loss and temperature rise. And  $\eta_{oscillation} = \eta_{crowbar}$ .

If  $R_D < R_S$ ,  $\eta_{oscillation} < \eta_{crowbar}$ , and vice versa.

Thus, crowbar resistor regulates not only efficiency of the system, but temperature of the coil will rise in the same time.

By the same reason, when  $R_C$ ,  $R_S$  and  $E_C$  of the two systems are equal, if  $R_D = R_S$ , so does efficiency of the two models. In Fig.4, if  $R_D = R_S = 10 \text{ m}\Omega$ , the speed of the crowbar circuit should be equal to that of the oscillation circuit. In this model,  $10 \text{ m}\Omega$  could be seen as the watershed of the crowbar resistor that the efficiency is almost the same with the oscillation circuit.

### 3.2. Electromagnetic Force

Electromagnetic force (EMF) applied on the armature will be another question which influence service condition of the driving circuits. Just as shown in Figure 5, EMF in crowbar circuit will not oscillate which is beneficial for adjusting the interior ballistics performance. If power excitation of each stage is synchronized with the position of projectile, magnetic field will be linked along the barrel which is well known as synchronous induction coil gun (or cylinder reconnection gun). In contrast, oscillation circuit will results in oscillating axial EMF which is difficult to form a smooth accelerating force with the synchronous method as described above. It is bad for mechanical properties of the armature. But it does not always do so. Based on the operation principle of the straight line motor, researchers make several oscillating currents with adjusting firing time to be a multiphase (usually three multiphase) circuit which will produce a continuous traveling wave magnetic field with certain velocity. Magnetic traveling wave can propel the armature smoothly in the barrel which is called asynchronous induction coil launcher. Due to current attenuation, efficiency of the asynchronous induction coil launcher is not very high except replace the capacitor to pulsed alternator [11].

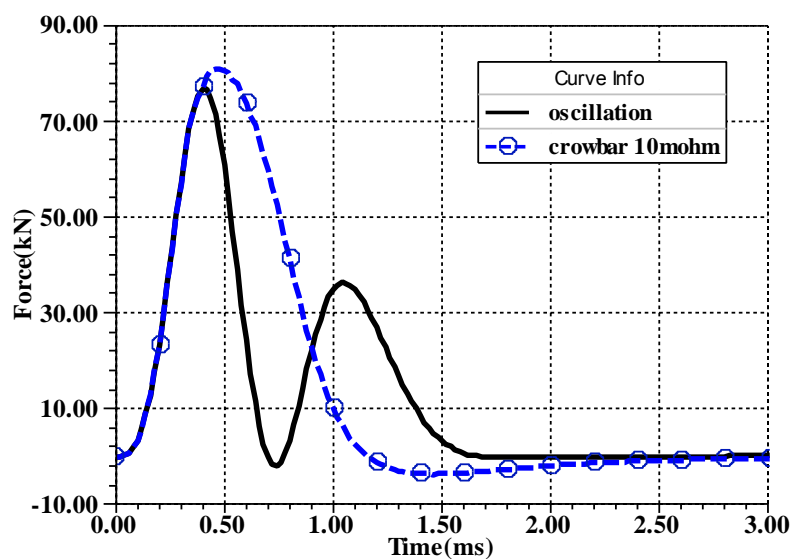

Figure 5. Force curves of the different driving circuits

4. Half-wave Circuit

4.1. Half-wave Circuit

As shown in Figure 1(c), the diode makes the circuit to be a half wave rectifier which works just during the first half-period of the oscillation circuit. The current flows only in a direction until zero. Great residual energy will be stored in the capacitor with negative voltage. Only part of energy of the capacitor is transferred to the coil. Although efficiency of the half-wave circuit is very high, speed of the armature is very low. It could also be seen in Figure 6 and Figure 7. Speed of the half-wave circuit is the lowest in the four circuits. Thus, half-wave circuit is seldom used in the experiment.

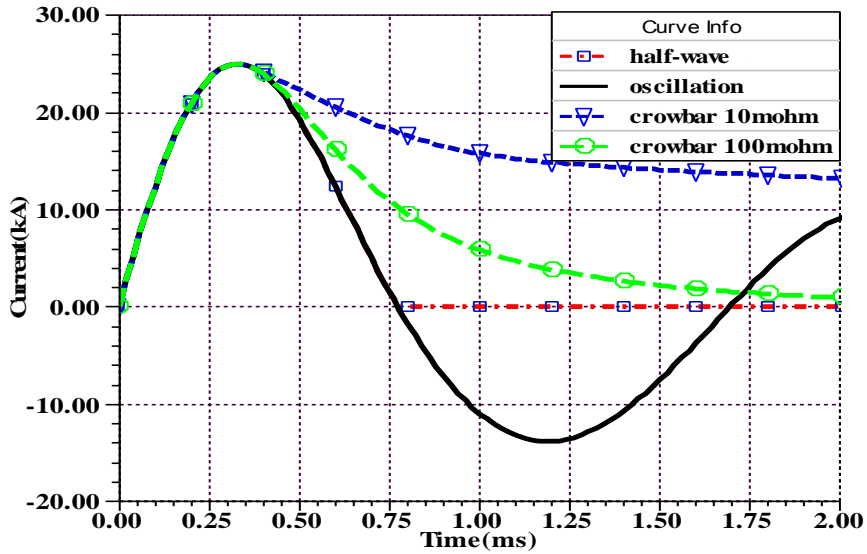

Figure 6. Current curves of the different driving circuits

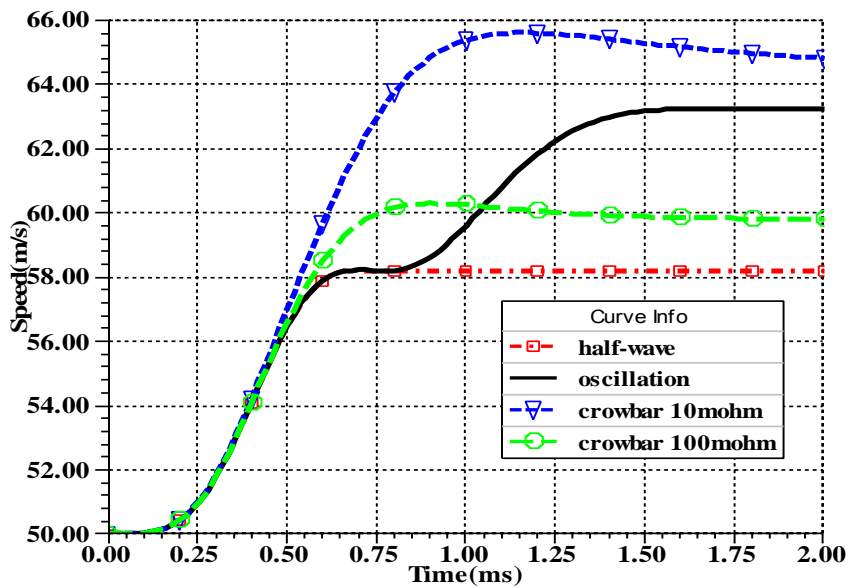

Figure 7. Speed curves of the different driving circuits

#### 4.2. Sustained Firing Mission

However, in recent years, sustained firing mission has been paid attention to in EML field which requires the capacitor to recharge after each launch [12]. It gives the half-wave circuit much space to play. In oscillation circuit and crowbar circuit, capacitors have to be recharged from zero. While the half-wave circuit will be recharged from a certain high voltage which will improve the sustained firing rate greatly.

Reference [10] suggested a novel power conditioner equivalent circuit whose capacitors interconnect from breech to muzzle in one phase. It could not only enhance the utilization ratio of the energy, but also provide the current to the stages with gradually narrowed pulse width. But disadvantage of this special circuit is very clear. First, it is only applicable for the asynchronous induction coil launcher. Topology structure of the circuit is too complex to control in charge and discharge process. Second, utilization rate of the capacitors will decrease from the first stage to the last stage in one phase which results in the different service life of the capacitors. The later, the longer. Third, all the capacitors have to be used in a launch. Malfunction of any capacitor will cause the whole system stopping service. Last, all the capacitors could not be charged until the last stage is discharged. Sustained firing rate will be low.

This paper proposes a simple independent half-wave circuit which can be applied in the sustained firing synchronous induction coil gun. Two thyristors ( $T_1$  and  $T_2$ ) are used to control the discharge of the capacitor as shown in Figure 8.

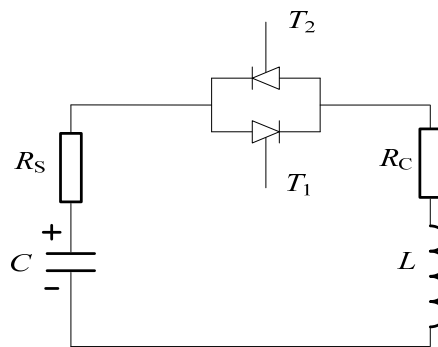

Figure 8. Force curves of the different driving circuits

The thyristors operate one after another matching with the different discharge electrode of the capacitor. This circuit has the following advantages: All the driving circuits are independent. Capacitor and coil of each stage could be adjusted as needed which is good for modular design. Charge and discharge of each capacitor is not influenced by other capacitors which could improve the sustained firing rate. Residual energy will be reused to improve efficiency. Moreover, service life of each capacitor will be the same. Thus, this independent half-wave circuit is suggested in the sustained firing system. It is worth mentioning that if crowbar resistance is chosen properly, launching properties of the half-wave circuit could be achieved through the crowbar circuit as shown in Figure 7. Thus, the comprehensive properties of crowbar circuit is the most excellent in the three typical circuit.

#### 5. Conclusion

This paper gives a detailed analysis of the properties of the driving circuit construction based on the capacitor source. Driving circuit configuration could influence the efficiency of the coil launcher directly. Three topologies of the driving circuit are compared. It is proved that which circuit has the better efficiency depends on the detailed parameters of the experiment, especially the crowbar resistance. Crowbar resistor regulates not only efficiency of the system, but also temperature rise of the coil. If crowbar resistance is equal to the system resistance, resistance loss and temperature rise of the crowbar circuit and the oscillation circuit will be the same. Electromagnetic force (EMF) applied on the armature will be another question which

influence service condition of the driving circuits. Oscillation circuit and crowbar circuit should apply to the asynchronous induction coil launcher and synchronous induction coil launcher, respectively. Half-wave circuit is seldom used in the experiment. Although efficiency of the half-wave circuit is very high, speed of the armature is very low. Sustained firing mission gives the half-wave circuit much space to play. A simple independent half-wave circuit is suggested in this paper. Generally speaking, the comprehensive properties of crowbar circuit is the most excellent in the three typical circuits. Researchers can choose the proper circuit based on their purpose and experimental conditions.

## References

- [1] W Ying, RA Marshall, C Shukang. Physics of Electric Launch. Beijing, China: Science Press, 2004.
- [2] RJ Kaye. Operational requirements and issues for coilgun electromagnetic launchers. *IEEE Transactions on Magnetics*. 2005; 41(1): 194–199.
- [3] Shun-Shou Gao, Cheng-Wei Sun. The Test and Analysis of a 3-Stage Reconnection Coilgun. *IEEE Transactions on Magnetics*. 1999; 35(1): 142 – 147.
- [4] Zhao Keyi, Cheng Shukang, Zhang Ruiping. *Influence of Driving Current's Wave on Accelerative Performance of Induction Coil Launcher*. Electromagnetic Launch Technology, 14th Symposium. Victoria, BC. 2008: 1-4.
- [5] Munir Achmad, Bharata Endon, Self oscillating mixer with dielectric resonator for low noise block application. *TELKOMNIKA*. 2011; 9(2): 351-356.
- [6] Yadong Zhang, Jiangjun Ruan, Ying Wang, Yujiao Zhang, Bao Shouliu, Armature Performance Comparison of an Induction Coil Launcher. *IEEE Transactions on Plasma Science*. 2011; 39(1): 471–475.
- [7] Yadong Zhang, Jiangjun Ruan, Ying Wang, Zhiye Du, Shoubao Liu, and Yujiao Zhang. Performance Improvement of a Coil Launcher. *IEEE Transactions on Plasma Science*. 2011; 39(1): 210–214.
- [8] Yadong Zhang, Jiangjun Ruan, Ying Wang. Capacitor-driven Coil gun Scaling Relationships. *IEEE Trans on Plasma Science*. 2011; 39(1): 220-224.
- [9] Tao, Huang Jiangjun Ruan, Yujiao Zhang. Winding of a multi-phase induction machine magneto-structural coupling field analysis on the end. *TELKOMNIKA*. 2012; 10(5): 933-939.
- [10] Z Zabar, Y Naot, L Birenbaum, E Levi, PN Joshi. Design and power conditioning for the coil-gun. *IEEE Transactions on Magnetics*. 1989; 25(1): 627- 631.
- [11] A Balikci, Z Zabar, L Birenbaum, D Czarkowski. On the Design of Coilguns for Super-Velocity Launchers. *IEEE Transactions on Magnetics*. 2007; 43(1): 107-110.
- [12] BD Skurdal, RL Gaigler. Multimission Electromagnetic Launcher. *IEEE Transactions on Magnetics*. 2009; 45(1): 458–461.