

OPEN ACCESS

Comparison of different methods for liquid level adjustment in tank prover calibration

To cite this article: D A Garcia *et al* 2015 *J. Phys.: Conf. Ser.* **575** 012017

View the [article online](#) for updates and enhancements.

Related content

- [Bilateral comparison of radiated emission measurements](#)
M S Dias, M F Barbosa, A G F Junior *et al.*
- [Determining camera parameters for round glassware measurements](#)
F O Baldner, P B Costa, J F S Gomes *et al.*
- [Hydrophone's sensitivity calibration based on its complex transfer function](#)
E G Oliveira, J C Machado and R P B Costa-Felix



IOP | ebooks™

Bringing you innovative digital publishing with leading voices to create your essential collection of books in STEM research.

Start exploring the collection - download the first chapter of every title for free.

Comparison of different methods for liquid level adjustment in tank prover calibration

D A Garcia, E C Farias, P C Gabriel, M H Aquino, R S E Gomes and
V Y Aibe

Inmetro, Fluid Dynamics Metrology, Rio de Janeiro, Brazil

E-mail: dinam@inmetro.gov.br

Abstract: The adjustment of the liquid level during the calibration of tank provers with fixed volume is normally done by overfill but it can be done in different ways. In this article four level adjustment techniques are compared: plate, pipette, ruler and overfill adjustment. The adjustment methods using plate and pipette presented good agreement with the tank's nominal volume and lower uncertainty among the tested methods.

1. Introduction

Tank provers are essential instruments used as transfer standards for liquid volume quantity. There are two common types of tank provers: fixed volume and graduated volume type, as presented in figure 1.

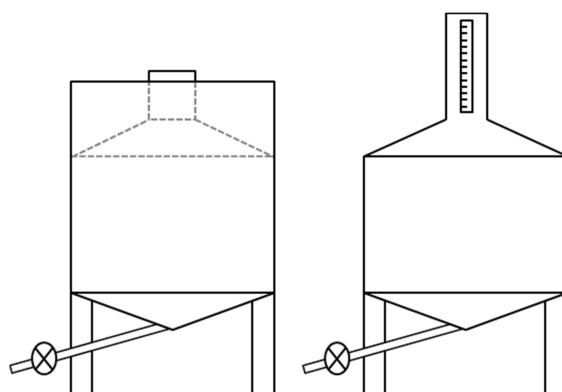

Figure 1. Common types of tank provers (left: fixed volume type; right: graduated volume type).

The calibration of a fixed volume tank prover is done generally by overfilling the tank with liquid and the meniscus volume on the edge of the tank's neck depends on the liquid surface tension and other external influences. The tank's volume can be determined either by the gravimetric or volume transfer method. The calibration results are very dependent on the meniscus level adjustment (figure 2). This adjustment can be done by many methods, depending on the tank prover installation facilities and the calibration uncertainty requirements.

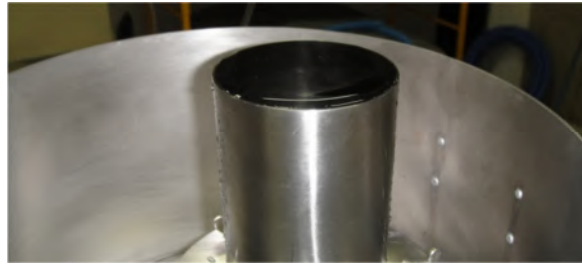

Figure 2. Liquid meniscus in a fixed volume tank's neck.

2. Objective

This study aims the comparison of different methods commonly used for the liquid level adjustment during the calibration of fixed volume tank provers. The adjustment was done using the following methods: plate, pipette, ruler and overflow levelling. The calibration results are compared in terms of cost-benefit ratio (uncertainty achieved versus convenience of execution).

3. Methodology

In this study a fixed volume tank prover with 50dm³ was used. The calibration of the tank prover was done by the gravimetric method, using a balance with 150kg capacity and 1g of resolution. The balance was calibrated using F1 class calibration weights. The tank was calibrated with filtered water and the water density was determined by means of a digital densimeter. The calibration facilities are presented in figure 3.

The tank prover was levelled over a platform, through its adjustable feet. Once filled, the liquid temperature was measured and the liquid level was adjusted in the tank. The liquid in the tank was then transferred to a container by means of a plastic pipe. The liquid transfer was done by opening smoothly the valve in the tank's bottom part. The assembly (container + liquid + pipe) was then moved to the balance platform to measure its mass. After the weighing, the container was emptied and the empty assembly (container + pipe) was also weighed.

Hereafter, the four methods used for the liquid level adjustment during the calibration are described.

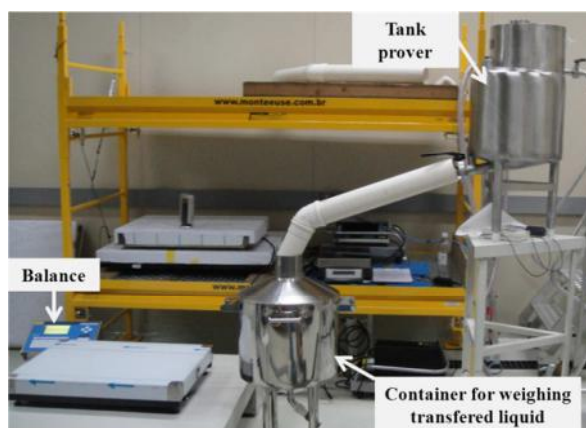

Figure 3. Calibration facilities.

3.1. Plate adjustment

In this method, the meniscus was adjusted by means of an acrylic plate, as presented in figures 4 and 5.

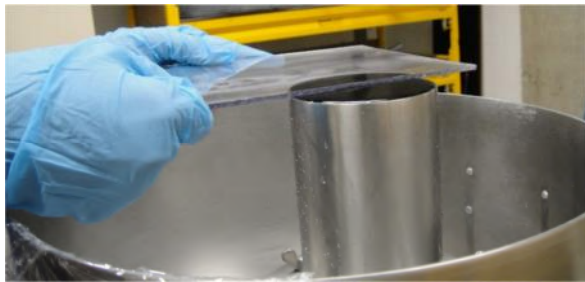

Figure 4. Meniscus adjustment using an acrylic plate

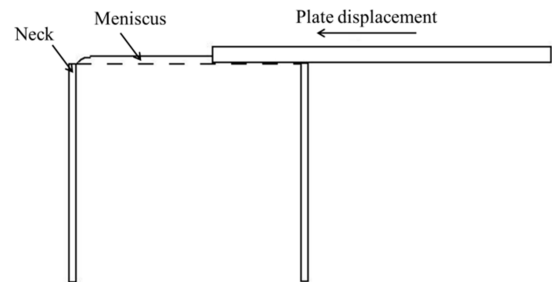

Figure 5. Scheme of the meniscus adjustment using an acrylic plate

The tank was filled and then the neck was overfilled until the formation of a meniscus. The meniscus was adjusted by moving slowly the acrylic plate, tangential to the neck's surface. An acrylic plate was chosen as it allows the view of air bubbles entrapped in the meniscus.

3.2. Pipette adjustment

This method consists of adjust the liquid level in the tank's neckedge by means of a pipette, as presented in figure 6 and 7. The tank was filled and the liquid level was then adjusted with the aid of a pipette, until it was visually at the neck's edgelevel (no meniscus is formed).



Figure 6. Meniscus adjustment using a pipette.

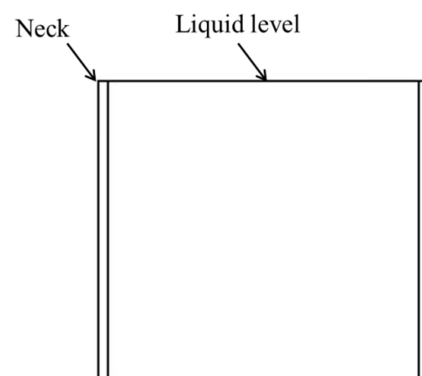

Figure 7. Scheme of the meniscus adjustment using a pipette.

3.3. Ruler adjustment

In this method, a metallic ruler was used to adjust the liquid meniscus, as presented in the figure 8 and 9.



Figure 8. Meniscus adjustment using a ruler.

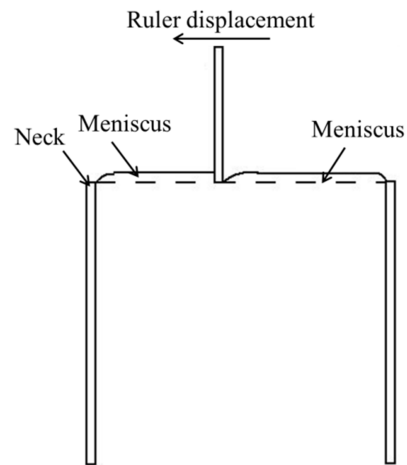

Figure 9. Scheme of the meniscus adjustment using a ruler.

The tank was filled and then the neck was overfilled until the formation of a meniscus. The meniscus was adjusted by moving the ruler, in the vertical position, tangential to the neck's surface.

3.4. *Overflow adjustment*

In this method, the meniscus was adjusted by pouring water in the tank's neck with the aid of a beaker, as presented in the figure 10. The liquid was poured from the beaker to the tank until the meniscus rupture.



Figure 10. Meniscus adjustment by pouring water with a beaker.

4. **Mathematical model**

The mathematical model used for determine the tank volume through the gravimetric method is presented below:

$$V_L(T_r) = \frac{M_{a1} - M_{a2} + M_E}{(\rho_L(T_L + \delta T_L) - \rho_A)} \cdot \left(1 - \frac{\rho_{ab}}{\rho_b}\right) \cdot (1 - \alpha_V \cdot (T_d - T_r)) + \delta M + \delta V \quad \text{Eq.1}$$

Where:

- $V_L(T_r)$ is the tank prover volume at its reference temperature $T_r = 20^\circ\text{C}$;
- M_{a1} is the apparent mass of the full container, after the transference of liquid;
- M_{a2} is the apparent mass of the empty container, before the transference of liquid;
- M_E is the apparent mass of the evaporated liquid;

- $\rho_L(T_L)$ is the liquid density in the tank prover, at the temperature T_L ;
- ρ_A is the air density during the apparent water mass measurement;
- ρ_{ab} is the air density during the balance calibration;
- ρ_b is the density of the standard weight used in the balance calibration;
- α_V is the thermal expansion volumetric coefficient of the tank prover;
- T_d is the tank prover temperature;
- δM is the error due to meniscus volume variation;
- δV is the random error due to repeatability of volume measurement.

Note: the apparent mass is the mass indicated by the balance display corrected by its calibration certificate data.

5. Results

The results obtained for each method are presented in the table 1 and figure 11, in terms of the measurand and its expanded measurement uncertainty.

Table 1. Tank calibration results.

Meniscus Adjustment Method	Calculated Volume (dm ³)	Expanded Uncertainty (dm ³)	Coverage Factor $k_{95\%}$	Relative Expanded Uncertainty (%)
Plate	50.0000	0.0032	2.000	0.0064
Pipette	50.0009	0.0032	2.010	0.0063
Ruler	50.0110	0.0033	2.000	0.0065
Pour	50.0197	0.0044	2.000	0.0088

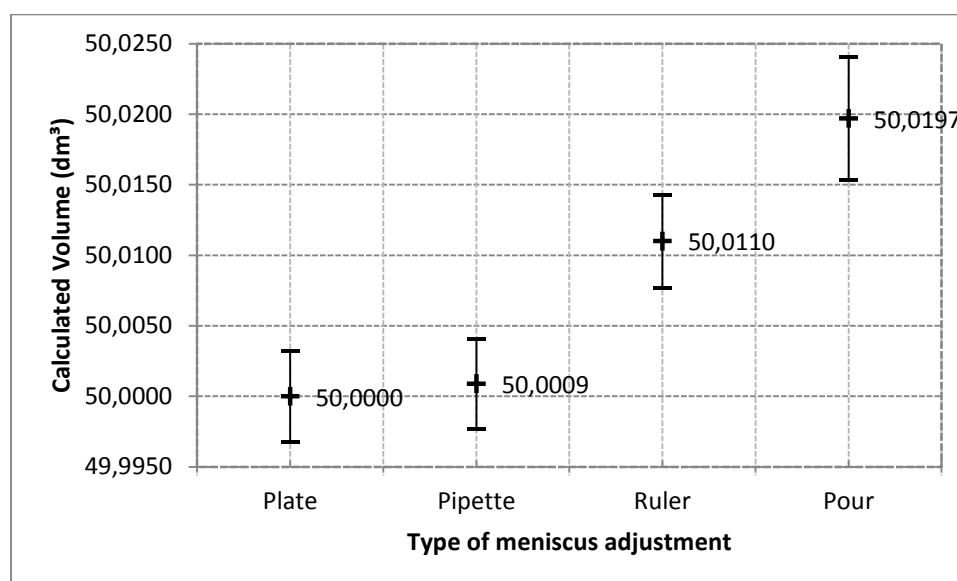

Figure 11. Results for the various meniscus adjustment methods

6. Conclusions

The tank's calibration results presented in the previous section show that the lower uncertainty levels were achieved using both the pipette and plate methods. Also, the calibration results were strongly affected by the calibration method due to contained volume variation.

For all tested methods, the contribution of the random error due to repeatability of the volume (δV) was one of the main sources of uncertainty. The ruler and overfill methods presented also an additional uncertainty source, the random error due to meniscus volume variation (δM), which has increased the uncertainty for these methods.

According the results, the plate method is the most recommended method for an interlaboratory comparison because it is a method of simple and fast execution and it is independent on the visual criteria used by the calibration personnel for the liquid volume adjustment. Besides, the execution of the plate method was easier than the pipette method (time of execution, easiness and convenience), with the best cost-benefit ratio.

Laboratory experience prove that the overfill method is most convenient method to be executed for fixed volume tank calibration. In cases where the uncertainty requirements are narrow, other calibration method can be chosen.

The tests carried out in this study denote also the dependency of the calibration results on the calibration method. Therefore, special care should be given upon the calibration method versus the utilization method of the tank. Both methods should be the same or the results will not be compatible.

7. References

BEAN, V. E.; ESPINA, P. I.; WRIGHT, J. D.; HOUSER, J. F.;SHECKELS, S.D.; JOHNSON, A. N. March 24, 2006. *NIST Calibration Services for Liquid Volume*.NIST Special Publication 250-72.