



MODELLING AND VISUALIZING THE SPATIAL PATTERNS IN ACCESS MODE
CHOICE AND THE POTENTIAL FOR BICYCLE IN ACCESS TRIPS IN RIO DE
JANEIRO

Flavia Carvalho de Souza

Tese de Doutorado apresentada ao Programa de Pós-graduação em Engenharia de Transportes, COPPE, da Universidade Federal do Rio de Janeiro, como parte dos requisitos necessários à obtenção do título de Doutor em Engenharia de Transportes.

Orientadores: Romulo Dante Orrico Filho

Martin van Maarseveen

Rio de Janeiro

Novembro de 2017

MODELLING AND VISUALIZING THE SPATIAL PATTERNS IN ACCESS
MODE CHOICE AND THE POTENTIAL FOR BICYCLE IN ACCESS TRIPS IN RIO DE
JANEIRO

Flavia Carvalho de Souza

TESE SUBMETIDA AO CORPO DOCENTE DO INSTITUTO ALBERTO LUIZ
COIMBRA DE PÓS-GRADUAÇÃO E PESQUISA DE ENGENHARIA (COPPE) DA
UNIVERSIDADE FEDERAL DO RIO DE JANEIRO COMO PARTE DOS REQUISITOS
NECESSÁRIOS PARA A OBTENÇÃO DO GRAU DE DOUTOR EM ENGENHARIA DE
TRANSPORTES

Examinada por:

Prof. Romulo Dante Orrico Filho, Dr. Ing

Dr. Glaydston Mattos Ribeiro., Ph.D.

Dr. Hostilio Xavier Ratton Neto, Ph.D.

Dr. Yaeko Yamashita, Ph.D.

Prof. Martin van Maarseveen, Ph.D.

Prof. Enilson Medeiros dos Santos, D.Sc.

RIO DE JANEIRO, RJ - BRASIL

NOVEMBRO DE 2017

Souza, Flavia Carvalho de

Modelling and visualizing the spatial patterns in access mode choice and the potential for bicycle in access trips in Rio de Janeiro / Flavia Carvalho de Souza. – Rio de Janeiro: UFRJ/COPPE, 2017.

XII, 99 p.: il.; 29,7 cm.

Orientadores: Romulo Dante Orrico Filho

Martin van Maarseveen

Tese (doutorado) – UFRJ/ COPPE/ Programa de Engenharia de Transportes, 2017.

Referências Bibliográficas: p. 91-97.

1. Viagens de acesso. 2. Potencial para uso da bicicleta. 3. Transporte Publico. I. Orrico Filho, Romulo Dante *et al.* II. Universidade Federal do Rio de Janeiro, COPPE, Programa de Engenharia de Transportes. III. Título.

DEDICATÓRIA

Aos meus pais, pelo apoio incondicional, sempre.

“Nunca deixe que lhe digam que não vale a pena

Acreditar no sonho que se tem

Ou que seus planos nunca vão dar certo

Ou que você nunca vai ser alguém

...

Se você quiser alguém em quem confiar

Confie em si mesmo

Quem acredita sempre alcança!”

- Renato Russo -

AGRADECIMENTOS

Eu não poderia começar agradecendo a outras pessoas se não meus pais! Meus pais que estão sempre ao meu lado e que me apoiam incondicionalmente em todas as decisões que tomo! Pai e mãe, obrigada por tudo, para mim todo dia é dia de vocês!

Estendo minha gratidão a meu marido, que ao longo dos últimos anos não somente me apoiou como me incentivou nesse caminho. Foi compreensivo e paciente quando não pude estar presente em vários momentos.

Romulo Orrico e Milena Bodemer tiveram papéis fundamentais! Milena, que começou como minha orientadora, mas sempre foi muito mais do que isso! Sempre me orientou, inspirou e aconselhou! Certamente sem ela não teria conseguido. Romulo generosamente me acolheu como orientando quando Milena se aposentou. Ele sempre com seu bom humor e otimismo! Aprendi com ele muito mais do que redes de transporte!

Aos meus orientadores da Universidade de Twente: Martin van Marseveen e Mark Brussel, agradeço pela orientação e pelo longo caminho que percorremos juntos. Mark Zuidgeest foi fundamental em meus primeiros anos. Lissy la Paix (mi angel!), também da Universidade de Twente, chegou aos 47 do segundo tempo e desempenhou papel fundamental, me dando todo o suporte para os modelos. Ainda no ITC/Universidade de Twente, um agradecimento especial a Petra, que sempre fez tudo acontecer!

Aos meus amigos do ITC/Universidade de Twente, sem eles certamente essa jornada teria sido mais dura, os invernos mais frios e os almoços mais pacatos! Razieh, Sara, Divyani, Fangyang, KB, Abhi, Andrés, Alby e tantos outros, obrigada por fazer de Enschede “home away from home”!

Aos colegas dos Cycling Academic Network, os “CANers” Janice, Himani, Alphonse, Eddie and Deepthi, obrigada pela troca ao longo do caminho! Aprendi demais com vocês!

No PET, agradeço especialmente ao apoio de Jane, Dona Helena, Lucia e Barbara por estarem sempre dispostas a ajudar no que for preciso! Não posso deixar de mencionar Marcello Victorino e Gabriel Stumpf pela amizade e suporte.

No núcleo Enschede, recebi ainda imenso apoio dos amigos do HMI e do DesignLab que torceram por mim e me apoiaram dia-a-dia! Igualmente importantes,

foram minhas amigas da máfia latina Irene, Ivettinha, Manu, Vale e Patri e da comunidade brasileira Luci, Luis Olavo, Giovane, Juliana, Diego e por ai vai.

Finalmente, impossível não mencionar meus amigos de fé que sempre acreditaram em mim e certamente fizeram esses anos de dedicação mais doces: Rê, Cake, Nanda, Vá, Fabi, Liliam, Flavinha, Vivi, Kikinha, Timoteo, Gui entre tantos outros.

Resumo da Tese apresentada à COPPE/UFRJ como parte dos requisitos necessários para a obtenção do grau de Doutor em Ciências (D.Sc.)

MODELO E VISUALIZAÇÃO ESPACIAL DA ESCOLHA DE MODO DE ACESSO AO
TRANSPORTE PÚBLICO E DO POTENCIAL PARA O USO DE BICICLETA COMO
MODO DE ACESSO

Flavia Carvalho de Souza

Novembro/2017

Orientadores: Romulo Dante Orrico Filho

Martin van Maarseveen

Programa: Engenharia de Transportes

Este trabalho desenvolve um modelo estatístico para identificar os principais fatores que afetam a escolha do meio de transporte em viagens de acesso ao transporte público. Um outro modelo estatístico apresenta as principais barreiras e fatores motivadores para o uso da bicicleta quando integrada ao transporte público. Finalmente, utilizando sistema de informações geográficas, este trabalho possibilita a visualização de padrões espaciais das viagens de acesso ao transporte público e das barreiras e fatores motivadores para o uso da bicicleta quando integrada ao transporte público. Os resultados apresentam semelhanças com estudos desenvolvidos em outros países, mas também apresentam particularidades da realidade local.

Abstract of Thesis presented to COPPE/UFRJ as a partial fulfillment of the requirements for the degree of Doctor of Science (D.Sc.)

MODELLING AND VISUALIZING THE SPATIAL PATTERNS IN ACCESS MODE
CHOICE AND THE POTENTIAL FOR BICYCLE IN ACCESS TRIPS IN RIO DE
JANEIRO

Flavia Carvalho de Souza

November/2017

Advisors: Romulo Dante Orrico Filho

Martin van Maarseveen

Department: Transportation Engineering

The present study presents statistical models which identify the main factors affecting access mode choice and the barriers and motivators for the use of bicycle in integration with public transport. Additionally, this study enables the visualization of the spatial patterns of both access mode choice and the potential for bicycle in access trips. Some results are in line with studies conducted in other countries, but also other results show some particularities from the local context.

SUMMARY

1	INTRODUCTION	1
1.1	The role of access trips in public transport trips	2
1.2	Bicycle as a sustainable transport alternative and its potential as access mode	3
1.3	Brazilian overview: transport supply and demand	6
1.4	Problem statement	8
1.5	Objectives	8
1.5.1	General objective	8
1.5.2	Specific objective 1: Model access mode choice	8
1.5.3	Specific objective 2: Model the potential for bicycles in access trips	9
1.5.4	Specific objective 3: Identify spatial patterns	9
1.6	Methodology	9
1.6.1	The city of Rio de Janeiro and the selection of study areas	9
1.6.2	The selection of study areas	10
1.6.3	Data collection	11
1.6.4	Data analysis	14
1.7	Thesis structure	15
2	MODELLING ACCESS MODE CHOICE TO BUS, TRAIN AND METRO IN RIO DE JANEIRO	16
2.1	Rio de Janeiro's transport system and travel dynamics	20
2.2	Case study areas	21
2.3	Dataset and methodology	22
2.4	Survey results	24
2.5	Model estimation and results	26
2.5.1	Analytical framework	26
2.5.2	Results	28
2.5.3	Forecasting	30
2.5	Conclusions and recommendations	31
3	MODELLING THE POTENTIAL FOR CYCLING IN ACCESS TRIPS TO BUS, TRAIN AND METRO IN RIO DE JANEIRO	35
3.1	The access trip to public transport	35
3.2	Previous studies on bicycle use and behaviour	37
3.3	Overview of Rio de Janeiro and the case study areas	41

3.3.1	Rio de Janeiro: brief overview	41
3.3.2	Case study areas.....	42
3.4	Data collection	45
3.4.1	Sample description	47
3.5	Model estimation and results	50
3.5.1	Sample characteristics.....	50
3.5.2	Results.....	51
3.6	Conclusions and recommendations	54
4	USING GIS TO VISUALIZE SPATIAL PATTERNS IN ACCESS MODE CHOICE AND THE POTENTIAL FOR BICYCLE IN ACCESS TRIPS IN RIO DE JANEIRO	57
4.1	Methodology.....	60
4.1.1	Overview: Rio de Janeiro	61
4.1.2	Overview: case study areas.....	61
4.2	Data analysis	64
4.3	Spatial analysis	67
4.3.1	Spatial patterns in access mode travel behavior	67
4.3.2	Spatial patterns in access mode travel behavior potential for bicycle in access trips: barriers and motivators	76
4.4	Conclusion and recommendations	82
5	SINTHESIS.....	85
5.1	Summary and discussion of the results	85
5.1.1	Access mode choice	85
5.1.2	Potential for bicycle in access trips.....	85
5.1.3	Spatial patterns in access mode choice attributes and barriers and motivators of cycling in access trips	87
5.2	Reflections.....	88
5.2.1	Main Contribution.....	88
5.2.2	Limitations and recommendations for future research.....	89
6	BIBLIOGRAPHY	91
	ANEXO A	98

LISTA DE FIGURAS

Figure 1: Multimodal trip representation.....	3
Figure 2: Rural x Urban population growth in Brazil.....	6
Figure 3: Rio de Janeiro Public Transport Network	10
Figure 4: Case study location.....	11
Figure 5: Data collection framework.....	12
Figure 6: Data analysis framework.....	15
Figure 7: Rio de Janeiro Public Transport Network	20
Figure 8: Access modal split	21
Figure 9: Study Cases location	23
Figure 10: Access mode share per distance range.....	25
Figure 11: Distribution of origins in Colegio (a) and in Santa Cruz (b).....	26
Figure 12. Planning Areas in Rio de Janeiro.....	41
Figure 13: Case study locations	43
Figure 14: Distribution of job densities	44
Figure 15: Data collection.....	47
Figure 16: Access mode share per distance range.....	48
Figure 17: Distribution of trip origins in Colegio	49
Figure 18: Distribution of trip origins in Santa Cruz.....	49
Figure 19: Representation of grid cells and centroids.....	60
Figure 20: PT network in the city of Rio de Janeiro	61
Figure 21: Study Cases location (a) and concentration of job positions (b)	62
Figure 22: Distribution of origins in Colegio (a) and in Santa Cruz (b).....	63
Figure 23: Data analysis framework.....	65
Figure 24: Access mode share in Colegio (a) and Santa Cruz (b)	68
Figure 25: Spatial distribution of IT choice attributes in Santa Cruz	69
Figure 26: Spatial location of captive IT users in Santa Cruz	69
Figure 27: Spatial distribution of walking attributes of choice in Colegio (a) and in Santa Cruz (b)	71
Figure 28: Spatial distribution of bus attributes of choice in Colegio (a) and Santa Cruz (b)	73
Figure 29: Spatial distribution of “frequency” attribute in Colegio (a) and Santa Cruz (b)	74
Figure 30: Spatial distribution of “travel time” attribute in Colegio (a) in Santa Cruz (b).....	75
Figure 31: Share of respondents who consider/do not consider biking to the station/stop in Colegio (a) and Santa Cruz (b).....	77
Figure 32: Share of barriers for biking to station/stop in Colegio (a) and Santa Cruz (b)	78
Figure 33: Share of motivators for biking to station/stop in Colegio (a) and Santa Cruz (b).....	80
Figure 34: Share of respondents who mentioned that “nothing” would make them cycle Colegio (a) and Santa Cruz (b)	81

LISTA DE TABELAS

Table 1: Comparison case study areas characteristics	11
Table 2: Transport system characteristics	20
Table 3: Sample's descriptive statistics	24
Table 4: Access trips distances.....	25
Table 5: Explanatory variables definition	27
Table 6: MNL analysis of access mode choice to bus stops, train and metro stations.....	28
Table 7: Access trips modal share variations.....	31
Table 8: Share of bicycle trips (%) as access mode to PT	38
Table 9: Descriptive statistics of the survey sample	47
Table 10 List of variables	51
Table 11: Binary logit models of propensity to use bicycle in access trips to PT.....	53
Table 12: Sample's descriptive statistics	64
Table 13: Variables overview and definition.....	65

1 INTRODUCTION

The increasing concentration of people in urban areas has a great impact on the dynamics of cities, as people need to engage in all sorts of activities. Motorization levels have never been so high. This holds true also for developing countries that historically have shown lower car ownership levels than developed countries. The number of cars in Brazil has doubled from 2001 to 2012 (RODRIGUES, 2013), whereas for example in India it has increased by 10 times over the past decades (TIWARI, 2002).

The expansion of vehicle ownership in developing countries has important implications for transport and environmental policies (DARGAY; GATELY; SOMMER, 2007). Congestion, air and noise pollution, energy consumption and deterioration of natural landscapes are some of the negative effects of the unbalanced use of private motorized transport (CHEN et al., 2011; GROTENHUIS; WIEGMANS; RIETVELD, 2007; VAN EXEL; RIETVELD, 2009).

The need for sustainable alternatives to mitigate the impact of the current highly motorized individual mobility is pressing. Sustainable transport is a key element in planning modern cities (CHEN et al., 2011; MAARSEVEEN, 2000). Increasing the share of public transport (PT) use is acknowledged by many authors as a sound strategy towards sustainability (DIANA; MOKHTARIAN, 2009; GROTENHUIS; WIEGMANS; RIETVELD, 2007; HENSHER, 2007; JIANG; CHRISTOPHER ZEGRAS; MEHNDIRATTA, 2012; KENNEDY, 2002; KRYGSMAN; DJIST; ARENTZE, 2004; MURRAY et al., 1998). Non-motorized transport (NMT), such as bicycle and walk, is also indicated as a key to achieve sustainability in transport (BAKKER et al., 2017; LAWSON; MCMORROW; GHOSH, 2013; MASSINK et al., 2011; MAT YAZID; ISMAIL; ATIQ, 2011; PLAUT, 2005).

Cycling is mainly regarded as a mode of transport at a local scale (CURTIS, 2008), however when properly integrated with the PT system, the bicycle can achieve a broader scale. The integration of bicycle and PT improves travel potential for both modes, as it combines the individual benefits of each mode (ADVANI; TIWARI, 2006a): PT cannot have the network penetration of cycling and the bicycle cannot serve or be as fast as PT for longer distance. The combination of both modes leverages the overall experience.

This research examines the factors affecting the choice of access mode for public transport trips, the barriers and motivators for the potential of bicycle use in the

access leg of the trip as well as the spatial patterns influencing these multimodal trips. Not only socioeconomic factors are investigated but also transport, behavioural and spatial aspects.

1.1 The role of access trips in public transport trips

In order to engage in activities and to reach destinations, individuals make trips from an origin to a destination. Trips made by PT are multimodal in their nature, as at least a walking to/from the PT system is required. There is no consensus on the definition of multimodal trips or a transport chain since nuances can be found in different definitions. According to Nes (2002) a multimodal trip is “when two or more different modes are used for a single trip for which in between the traveller has to make a transfer”. Hoogendoorn-Lanser et al (2006) present another definition: a multimodal trip is “a trip when it involves at least one transfer between – not necessarily different – mechanized modes”. Even though it is not explicit in his definition, Nes (2006) assumes in his study that walking is a universal component at both the start and end of any trip and therefore a trip in which walking is the access and egress mode is not considered a multimodal trip. In the same line, Hoogendoorn-Lanser et al (2006) only consider mechanized modes in their study neglecting not only walking but also cycling as potential parts of multimodal trips.

Walking is not only a mode of transport in itself, but it is also an important complementary mode of all motorized modes. In many developing countries people walk long distances and this mode has a high share in modal split, like in Brazil, for instance (INSITUTO PEREIRA PASSOS, 2006; VASCONCELLOS, 2001). Vasconcellos (2001) indicates that even private modes require people to walk to their vehicles and every PT trip requires an average of 500m of walking at each end.

For the purpose of this study, a multimodal trip is a PT trip composed of a sequence of (at least) three stretches: an access trip, a main trip and an egress trip, requiring (at least two) transfers and made by any combination of motorized and non-motorized modes. An illustration of the simplest form of a multimodal trip is presented below (Figure 1). The main trip is the longest trip of the sequence, whereas the access trip is the one from origin (home, in the case of the present study) to the main mode. Egress trip, in turn, is the last stretch from the last PT mode to the destination (work/study, in the case of this research). Access trips can be made by NMT modes, i.e. walking or cycling, but also by motorized modes such as bus or car, whereas egress trips are predominantly walking trips.

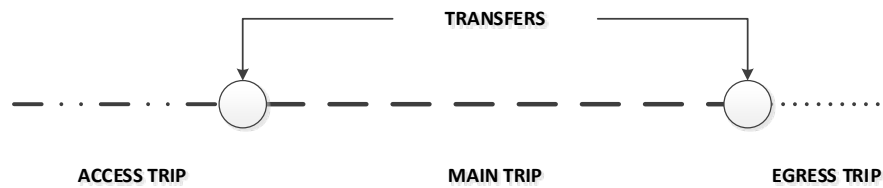

Figure 1: Multimodal trip representation

An attractive PT trip offers seamless connections between modes so that the inconvenience of the transfer is minimized: access trips, main trips and egress trips are smoothly linked (GIVONI; RIETVELD, 2007a). On the other hand, if the access and egress trip take a larger part of total travel time then the propensity to use PT is lower as alternative modes can be more attractive, and faster. For instance, for trips where walking distances are over 10 minutes, at both origin and destination, PT become increasingly unattractive (HINE; SCOTT, 2000).

Multimodal trips can capitalize the strengths and avoid the weakness of each individual mode (NES, 2002). In addition, it provides opportunities for individuals that do not own a motorized vehicle, thereby creating a more equitable transport alternative. It can be a faster option, particularly in congested networks and over long distances, and it has a better environmental and energy performance (KEIJER; RIETVELD, 2000).

The importance of access trips for improving the overall quality of PT journeys and increasing the use of PT services has been acknowledged by many authors (BRONS; GIVONI; RIETVELD, 2009; BRUSSEL; ZUIDGEEST; DE SOUZA, 2011; GIVONI; RIETVELD, 2007a; KEIJER; RIETVELD, 2000; MURRAY et al., 1998). According to (KRYGSMAN; DJIST; ARENTZE, 2004), much of the effort associated with public transport trips relates to how easy the system and the final destination can be reached. Despite its relevance, access trips and access mode choice have not been the topic of many studies in literature, especially in developing countries.

1.2 Bicycle as a sustainable transport alternative and its potential as access mode

The benefits associated with the use of bicycle as a mode of transport have been widely acknowledged (ADVANI; TIWARI, 2006a; MARTENS, 2004, 2007; ORTÚZAR; IACOBELLI; VALEZE, 2000; RIETVELD, 2000a). Especially for low income groups, cycling permits individuals to circulate and reach their destinations within short distance with a non-polluting and affordable mode, which enables them to take part in

more activities, since transport no longer represents a monetary cost. The bicycle is still a door to door transport alternative, its infrastructure has a very high spatial penetration (if shared traffic is considered), and since it is a flexible and straight mode it does not require schedule and waiting times as PT modes do, and , along with walking, it is an essential element in multimodal trips (RIETVELD, 2001). Cycling is not only an environmental friendly mode of transport, but it is also a healthy way of traveling, it demands less public space than other alternatives and - even more important for developing countries - it is almost a costless mode. Once the individual owns a bicycle, there are barely any costs involved in its maintenance (ADVANI; TIWARI, 2006a).

The insertion of the bicycle in transport systems can improve the city's quality of life, affect the environmental conditions positively and optimize public investments in the long term. The change from motorized modes to the bicycle would result in a better traffic flow as the number of motorized vehicles would drop. The need of public space assigned to car parking lots would decrease and those areas could be used to accommodate other public facilities. Since this mode of transport can be accommodated using less space than other motorized alternatives, public spaces can be used for parks, square and sport courts and other social purposes encouraging the use of public space to socialize and seize the city. In addition, the current road system could be less overloaded with cars and the circulation improved. The more intense the use of bicycle is the larger will be the positive impacts in the city and peoples' quality of life.

The use of the bicycle in integration with public transport presents its own advantages. When combined with public transport, the use of continuous modes such as walking and cycling influences positively the way the impedances in such trips are perceived (RIETVELD, 2000a). The average speed of cycling is three times faster than walking; consequently, the use of the bicycle in access trips increases significantly the catchment area of a given public transport service. From the users' perspective it means savings in travel time. In addition, Advani & Tiwari (2006) stress that the combination of bicycle and PT improves the travel potential for both modes, since it provides benefits that each mode alone is not able to provide, as PT cannot have the capillarity of cycling and the bicycle cannot be as fast as PT for longer distance.

The modal share of bicycle in some European countries is above 10% of the total trips made, such as in Netherlands, Denmark and Germany, to name a few (PUCHER; BUEHLER, 2008). On the other hand, in developed countries such as Australia, Canada and the USA the bicycle modal share is very low. This can be

attributed to the longer trip distances in these countries as compared to European countries and also to the lack of dedicated bicycle infrastructure. In order to attract higher bicycle volumes and modal share, it is crucial to offer bicycle infrastructure (BEUKES et al., 2013). However these national averages can hide significant differences in bicycle modal share amongst cities, even within the same country.

In Brazil, this is also the case. The use of the bicycle in the country differs considerably depending on the size of the city. In cities with up to 50 thousands inhabitants, bicycle and walk are the main mode of transport whereas in big cities, where public transport is largely available and the road network is more dense and aggressive, the use of bicycle is very limited (MINISTÉRIO DAS CIDADES, 2007). In the city of Rio de Janeiro the modal share of the bicycle is 2.4% (SETRANS-RJ, 2013), however discrepancies can be found throughout the city. It is estimated that in the peripheral west zone of Rio de Janeiro one fifth of the inhabitants uses the bicycle as a transport mode (MINISTÉRIO DAS CIDADES, 2007).

Despite the low bicycle share of bicycle on the national level, Brazil is the third bicycle producer in the world, responsible for 4% of the international bicycles' production and is the fifth consumer market for this mode of transport. The Brazilian Association of Bicycle Manufacturers (ABRACICLO) estimates that for the year 2005 the national fleet was some 60 million bicycles (MINISTÉRIO DAS CIDADES, 2007).

Acknowledging the importance of the bicycle in an equitable and efficient transport system, both the state of Rio de Janeiro and the municipality of Rio have launched programs to encourage and facilitate this mode of transport. The objective of the state program "Rio – Estado da Bicicleta" (Rio – State of the bicycle) is to encourage the use of bicycle especially for those who currently walk and also to access PT by supporting the municipalities to improve bicycle infrastructure. In the city level, the municipality developed the program "Rio, Capital da Bicicleta" (Rio, Capital of the bicycle) that aims to improve PT and urban mobility and to diminish GHG emissions by continuous efforts to incorporate the bicycle in the transport system and promoting its use in educational campaigns.

In spite of being an almost costless, healthier and greener alternative to motorized modes, the bicycle is not yet a sizable travel mode in the city of Rio de Janeiro. Moreover, the practice of using the bicycle as a feeder mode to public transport is still incipient. Therefore, identifying and understanding the current hindrances and potential motivators for this practice is crucial.

1.3 Brazilian overview: transport supply and demand

The world is facing an urbanization process, in particular in developing countries. In Brazil, it is not different (Figure 2). In 1960, the country had a population of 70.9 million of which 45% lived in urban areas. In the following decade the urban population outnumbered the rural and ever since its difference has only been growing. According to the last national census, the urban population reached 160 million, corresponding to 85% of the total number of inhabitants in the country (IBGE, 2010).

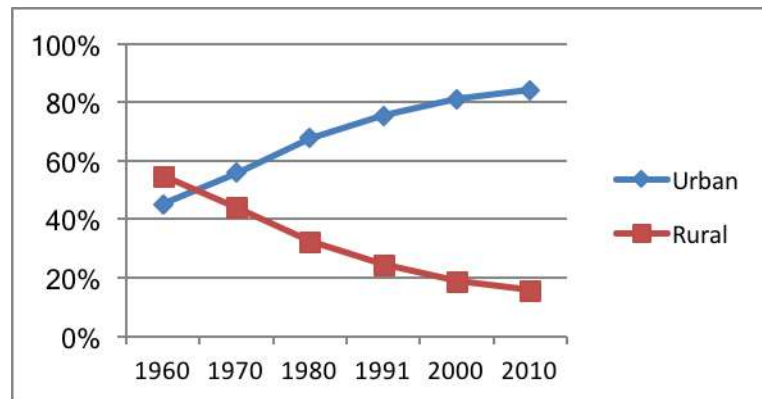

Figure 2: Rural x Urban population growth in Brazil

This urbanization process associated with urban sprawl induces the use of the private car to those who can afford, since the car offers a high level of personal mobility, flexibility, and it is more comfortable, particularly for long distances within the urban area. Low income groups, who cannot afford a private vehicle, are forced to live far from central areas, where most jobs and facilities are located, due to the high housing costs in these areas. The urban poor have to traverse long distances imposed by the perverse urban expansion process; it means that they depend on PT, that in turn in a lot of areas is scarce and of low quality.

Car ownership in Brazil has reached levels never seen before. The number of cars rose from 24.5 million in 2001 to 50.2 million in 2012. The average motorization level in Brazilian Metropolitan Regions is 33.8 cars per 100 inhabitants (RODRIGUES, 2013). Even though private vehicles are increasingly affordable for a larger group of people, it is still not for a considerable part of the population who depend on PT or NMT. According to the National Household Survey in 2008 45% of the households owned a private vehicle and this share increased to 54% in 2012; for the first time more than half of the Brazilian households owns a private vehicle. The car is the most popular private vehicle and 45% of the urban residences have one, whereas this share drops to 28% in rural areas (IBGE, 2012).

Public transport supply in Brazil is mainly based on road alternatives, such as bus and informal transport. A railway network is almost non-existent for passengers, both at urban and regional scale; rail is more intensively used for freight transportation. The inter- and intracity bus network in Brazil has a total length of 210 thousands km, whereas at national scale the total length of railways is merely 854 km (ANTP, 2006) . NMT plays an important role in the urban transport matrix, however its share varies considerably across city sizes. For instance, in cities with a population of more than 1 million inhabitants, the share of walking trips is 26% and bicycle trips 1% whereas in cities with a population between 60 to 100 thousand inhabitants these numbers go up to 49% and 9%, respectively (ANTP, 2006).

In Brazil, the average travel time and travel distance are, respectively, 10.7km and 35.2 minutes. For cities over 3 million inhabitants, the average travel time increases to 46.2 minutes. When it comes to modal share, the bus is the most used mode of transport, and it is responsible for 45% of the urban trips in the country. Car and walking are the second and third most used mode with 22% and 21%, respectively (CONFEDERACAO NACIONAL DO TRANSPORTE, 2017). Data from the same report also show that the higher the income the lower is the share of NMT (non-motorized transport) which indicates that paid alternatives are less affordable for low income people.

Transport expenses represent the third highest expense in the Brazilian household budget. However, when it comes to different income levels, it is clear that the percentage spent by wealthier families is double the percentage of lower income groups, suggesting higher mobility levels for wealthy individuals while transport expenses constrain mobility for the poorer (IBGE, 2010). The impact of transport expenses on the household budget is confirmed by a survey conducted under PT users in Rio de Janeiro. When asked how often they walk to save transport fare costs, 8% of the respondents answered every day or almost every day, 28% occasionally and 13% seldom (FETRANSPOR, 2004).

Considering this Brazilian urban context, where travel distances are often long, where a considerable part of the population cannot afford a private car and therefore depends on PT, where walking may not be an option although it is a costless mode, this study focusses on the integration of bicycle and PT. The possibility to substitute walking by cycling, and in particular its integration with the PT system, cannot only improve overall transport efficiency and quality, but also improve low income groups'

mobility levels, since except for the purchase cycling is costless, it is faster than walking and it has a wider reach.

1.4 Problem statement

Given the increasing levels of motorization worldwide, the only way to go for more sustainable urban transport systems is to focus on PT and NMT. In particular the integration of NMT and PT is considered a sustainable option because of the complementary advantages of both modes: NMT for shorter and PT for longer distances. Improving NMT access to the PT system has the potential to increase PT ridership and to improve satisfaction levels of PT experiences.

Access mode choice studies usually focus on trip, transport and/or built environment characteristics but rarely take into account users' preferences. It is too simple thinking to assume that only factors such as travel time, distance, cost or urban form affect mode choice. People do not behave similar, have different needs and opportunities, live in different conditions, and therefore they think and choose differently. Understanding why people choose a certain mode and what the barriers and motivators are for a more sustainable alternative, i.e. the bicycle, is essential to provide more appropriate transport infrastructure and options. By incorporating the spatial aspect, it is not only possible to meet the demand needs, but also to prioritize investments by knowing what is needed and where.

To bridge these gaps, this study aims to investigate the factors affecting access mode choice as well as the barriers and motivators for bicycle use in access trips. In addition, we examine the existence of spatial patterns in such choices in two neighborhoods in Rio de Janeiro.

1.5 Objectives

1.5.1 General objective

The main objective of this study is to identify and to understand the main factors underlying the access mode choice to PT stations, the main factors affecting the potential for bicycle use in access trips, both in a positive as well as negative sense, and to identify associated spatial patterns in these findings.

1.5.2 Specific objective 1: Model access mode choice

The first specific objective is to model access mode choice and to identify the main factors affecting the choice of an access mode.

1.5.3 Specific objective 2: Model the potential for bicycles in access trips

The second specific objective is to identify the main barriers and motivators for the potential use of bicycle in access trips to train and metro stations as well as to bus stops

1.5.4 Specific objective 3: Identify spatial patterns

The third and last specific objective is to detect spatial patterns in access mode choice attributes and in the main barriers and motivators for the potential use of bicycle in access trips to train and metro stations as well as to bus stops.

1.6 Methodology

1.6.1 The city of Rio de Janeiro and the selection of study areas

Rio de Janeiro has over 6 million inhabitants and is divided in 161 neighborhoods (IBGE, 2011). Differences can be found across to neighborhoods when it comes to population density, area and income. The average density of the city is 52 inhabitants/ha, however the highest density is 483 inhabitants/ha. In terms of area size, the smallest neighborhood is 16ha and the largest neighborhood almost 14,000 ha. According to the Census 2010, the average income for the city of Rio de Janeiro is R\$1,996/month (1US\$ = R\$1.66, in December 2010), however there is a large divide between income levels per neighborhood. The lowest average income per neighbourhood is equal to R\$571/month whereas the highest one is R\$8,286/month (Armazem dos Dados, 2014).

The public transport system of the city consists of a metro system (2 lines with 33 stations), an urban train system (5 corridors with 71 stations) and a vast network of bus lines, including 2 Bus Rapid Transit (BRT) lines (Figure 3). According to an Origin Destination (OD) survey conducted in 2013 (SETRANS/RJ, 2014), approximately 22 million trips are made per day in the Metropolitan Region of Rio de Janeiro. From all these trips, 63% are made by motorized modes whereas the remaining fraction is made by non-motorized modes. The modal split indicates a higher share of PT among the motorized modes and a concentration of walk trips among the non-motorized modes. The PT share is divided among the different public modes, with a strong dominance of urban bus followed by informal transport. Metro, train and other modes (tram, boat and charter transport) play a minor role.

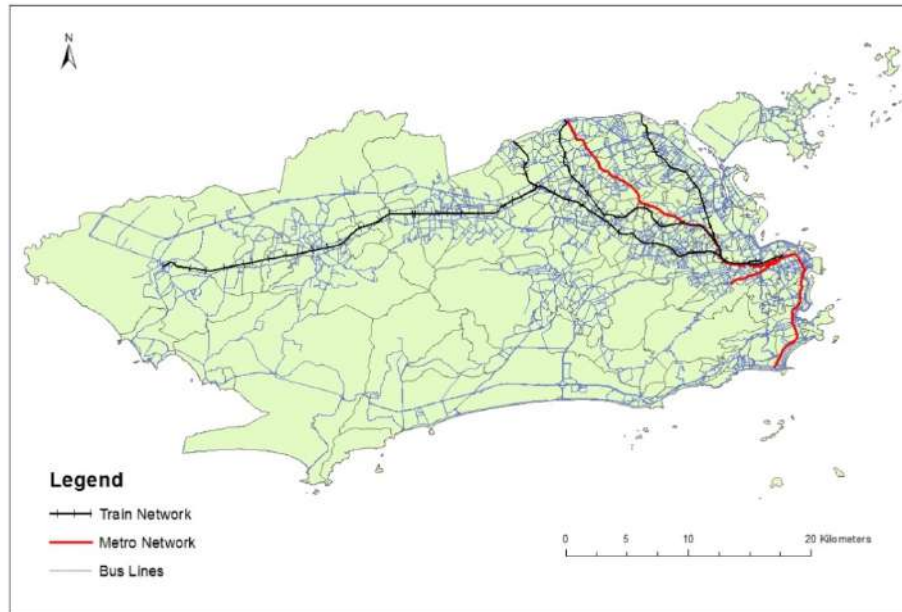

Figure 3: Rio de Janeiro Public Transport Network

1.6.2 The selection of study areas

The criteria used to select the case study areas were: income, current bicycle share, current bicycle infrastructure, PT supply and spatial and demographic characteristics. For the income it was decided to focus solely on low income areas, as these areas tend to suffer more with PT issues and would benefit more from (potential) improvements in the transport system and specifically in the (potential) bicycle infrastructure.

As for the other criteria, the idea was to have areas with different characteristics. Therefore, for this thesis, field work was conducted and data was collected in two neighborhoods of Rio de Janeiro: Colégio and Santa Cruz (Figure 4). These two neighborhoods share one characteristic: both are low income areas. Nevertheless, Colégio has an average per capita monthly income slightly higher than Santa Cruz (R\$1037 as compared to R\$941).

Santa Cruz is located in the western part of the city, it presents one of the lowest population densities of Rio, and the formal public transport provision is scarce, with areas being not served by bus lines. Land use is highly mixed, with both commercial and residential buildings, especially in the centre of the neighborhood. In addition, Santa Cruz attracts residents from longer distances, including adjacent neighborhoods, as it has a train station and final end bus stops of many lines that lead to the city centre and other areas of the city.

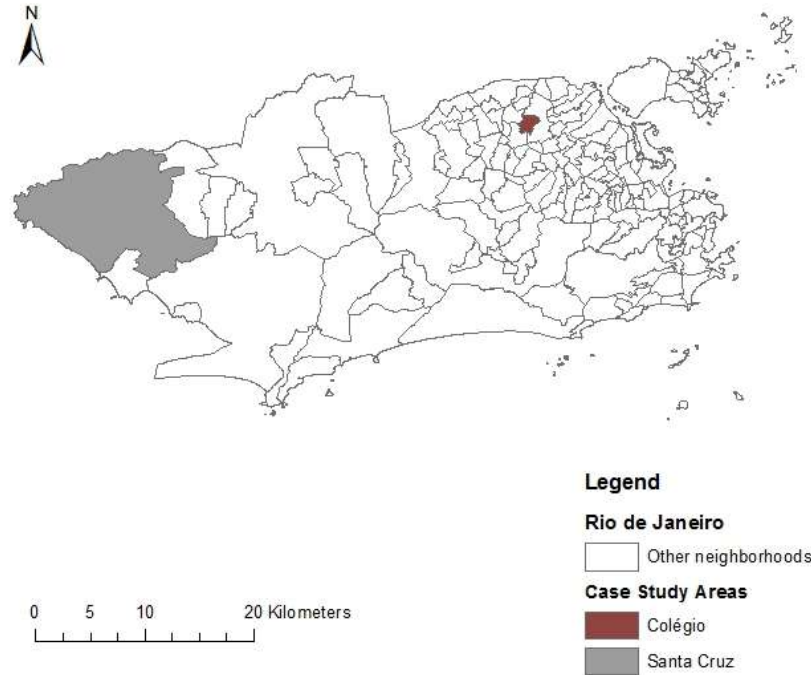

Figure 4: Case study location

On the other hand, Colégio is located in the northern part of the city, presents a high population density and it counts on a good PT supply, with plenty of bus lines available and a metro station. The land use mix is low, being mainly a residential neighborhood. Table 1 depicts the main characteristics of each case study area.

Table 1: Comparison case study areas characteristics

	Neighborhood	
	Colégio	Santa Cruz
Income	Low	Low
Transport Characteristics	Metro and dense bus network	Train, informal transport, scarce bus network
Density	High	Low
Access trip distance to PT	Short	Long
Bicycle use level	Low	High
Bicycle infrastructure	No bicycle infrastructure, apart from 10 spots in the metro station	Availability of (not enough) public and private bicycle parking, some cycleways and cycle paths

1.6.3 Data collection

The data collection methodology applied in this study is composed of several steps, including qualitative methods (expert group, focus group and in-depth

interviews) followed by quantitative methods (selection of frequent PT users and telephone interviews). Figure 5 shows the data collection framework.

In the first phase, qualitative methods were used to understand the behavior of PT users regarding access trips and the use of bicycle in integration to PT. Since this practice of integrating bicycle and PT and the access trip behavior are not yet well known in Brazil, an exploratory data collection stage was necessary.

In Santa Cruz bicycle users were approached in a private bicycle parking facility close to the train station and bus stops when they were coming to collect their bicycle. These participants were currently using the bicycle in the access trip to the bus or the train. They were invited and agreed on joining a focus group. In Colegio metro users who were using the bicycle as feeder mode were also approached and invited to join a focus group. Since in Colegio it was not possible to gather all potential focus group participants at the suggested day and time, it was decided to conduct in-depth telephone interviews with those users. For both methods used (focus group and in-depth interview), the same script of questions was used. Finally, in order to add a perspective different than the users' one, an expert group was implemented. The experts' group was composed by representatives of various mode operators as well as a representative from academia. The outcome from this phase was used as input for designing the questionnaire to be applied in the next step of data collection.

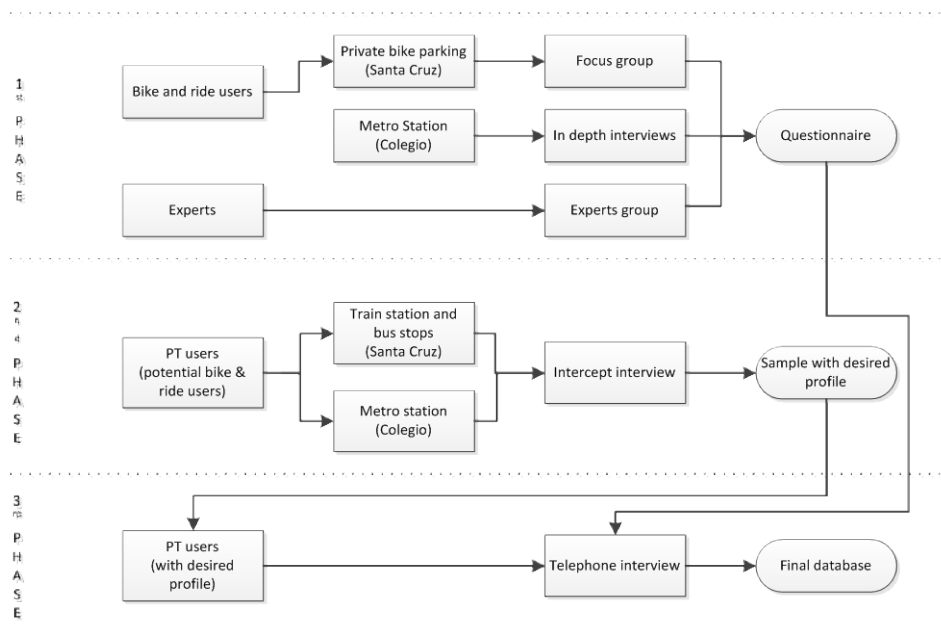

Figure 5: Data collection framework

The results of the qualitative data collection together with an extensive literature review on the topic were the basis for the questionnaire design. The final questionnaire was imported to handheld computers using the freeware CyberTracker, in order to have an electronic data collection.

For the next phase of data collection the interviewers used handheld computers and the PT users were approached in the main mode boarding points. Potential interviewees were approached in bus stops and the train station in Santa Cruz and in the metro station of Colégio. Filter questions were asked to check whether the user fits the desired profile. The desired profile consisted of people living within the city of Rio de Janeiro borders and having the destination also within these borders; people making trips to work or study (compulsory trips) and people who use the same transport mode(s) on a daily basis. If the person matched these conditions, the surveyors invited the interviewee to take part in a longer interview to be performed by telephone and the call would be made at an appropriate time and date indicated by the person. The filter interview takes a maximum duration of 1 minute.

The final phase of the data collection was the telephone interviews and again handheld computers were used. The telephone interview took, on average, 5 minutes. The questions were related to four main categories and captured the following information:

- Transport data: access mode (bus line when applicable), main mode (bus line when applied), complementary mode (bus line when applied), extra complementary mode (bus line when applied)
- Spatial data: origin and destination locations, as well as transfer locations
- Behavioral data: attributes of choice related to all individual components of the multimodal trip
- Socioeconomic data: gender, age, income, car and bicycle ownership and availability, ability to ride a bicycle

A total of 505 valid surveys were used for the analysis of the results. Incomplete questionnaires were excluded from this study. And so were cases of people whose access mode choice were too few and therefore would not be of significance in the analysis (car, car passenger and bicycle).

In order to enable spatial analysis, it was necessary to geo-reference the locations involved in this study (residence locations and PT boarding points). The first step was to divide the city of Rio de Janeiro into square grid cells measuring 800m x 800m. Using this grid cell size as the unit of analysis means that the average intra-grid cell trip distance is of approximately 450m which is reasonable considering the proposed analysis and the scales of the trip and the areas. Each grid cell has one centroid. The next step was to use the information about locations collected with the questionnaires and use it to populate the centroids with the residence locations of the interviews, as well the boarding points. As the base map is geo-referenced, all the information derived from this map are, consequently, also geo-referenced. For the analysis, all distances considered are the network distances between centroids.

1.6.4 Data analysis

The final database derived from the data collection (Figure 6) was used as the input for all chapters in this thesis. In the second chapter an access mode choice to bus, train and metro stations model is presented. Socioeconomic and trip characteristics as well as spatial information and users' self-reported reasons served as explanatory variables in a multinomial logit. The outputs for this chapter are the main factors affecting access mode choice.

In the third chapter a model to identify the propensity of current PT users to shift to the bicycle in access trips to bus stops, train and metro stations is presented. Two binary logit models were estimated to predict the main barriers and motivators affecting the propensity to use a bicycle as feeder mode to PT.

Finally, the outputs from chapters 2 and 3 were the inputs for chapter 4. The main factors affecting access mode choice and the barriers and motivators for bicycle use in integration with PT are then spatially analysed.

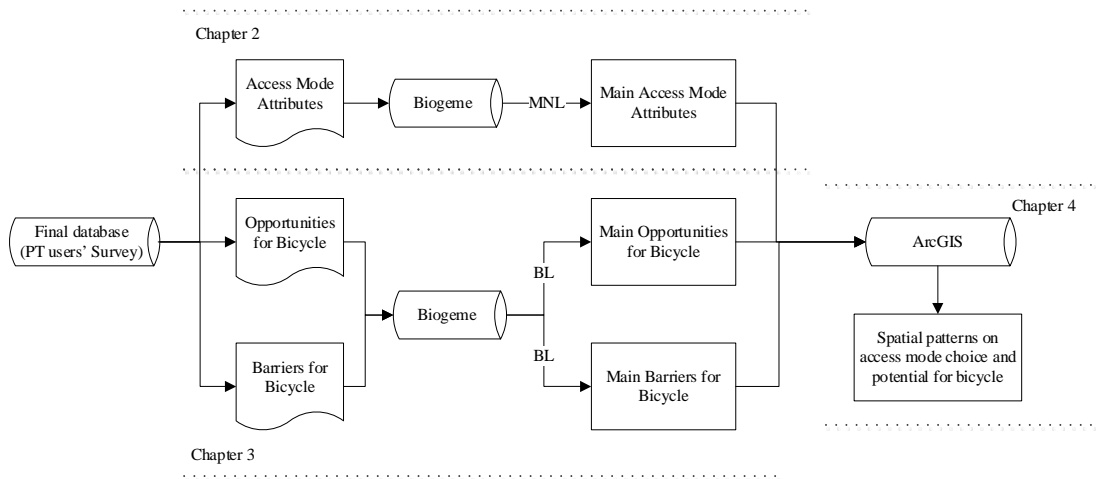

Figure 6: Data analysis framework

1.7 Thesis structure

This thesis is structured following an international trend of a collection of papers. This means that each paper needs to be independent from each other. Due to that, when all the papers (here as chapters) are placed in a sequence, there might be a repetition in content, specially when it comes to the introduction and methodology sessions, as these are common to all Chapters from this thesis.

In **Chapter 2** the main factors affecting access mode choice to bus, metro and train are presented. Subsequently, in **Chapter 3**, the potential for the use of bicycle in access trips is modelled and the main barriers and motivators are described. Then, in **Chapter 4** the results from previous chapters are spatially analyzed. Finally in the **Chapter 5** the main conclusions and recommendations are discussed in an integrated manner.

2 MODELLING ACCESS MODE CHOICE TO BUS, TRAIN AND METRO IN RIO DE JANEIRO

The world is facing an increasing urbanization process, mainly in developing countries, as in developed countries this process is already consolidated. In Brazil, in 1960 45% of the population lived in urban areas. In the following decade the urban population outnumbered the rural and according to the last national census, the urban population corresponds to 85% of the total inhabitants in the country (IBGE, 2010). The growing share of urban population worldwide has a big impact on the environment, as cities are responsible for up to 70% of the anthropogenic GHG emissions and transportation is one of the main sources (UN HABITAT, 2011). In Rio de Janeiro, Brazil, more than 40% of the CO₂ emissions are generated by the transport industry (SMAC; COPPE, 2013).

Congestion, air and noise pollution, energy consumption and deterioration of natural landscapes are some of the negative effects of the unbalanced use of private motorized transport (CHEN et al., 2011; GROTENHUIS; WIEGMANS; RIETVELD, 2007; VAN EXEL; RIETVELD, 2009). In Brazil the number of cars has doubled from 2001 to 2012, whereas the metropolitan regions present even higher rates (RODRIGUES, 2013). The expansion of vehicle ownership in developing countries has important implications for transport and environmental policies (DARGAY; GATELY; SOMMER, 2007).

Transport alternatives which are more socially, economically and environmentally sustainable become urgent. Many authors suggest increasing the share of PT use as a good strategy to achieve sustainability (Diana & Mokhtarian, 2009; Grotenhuis et al., 2007; Hensher, 2007; Jiang, Christopher Zegras, & Mehndiratta, 2012; Kennedy, 2002; Krygsman, Dijst, & Arentze, 2004; Murray, Davis, Stimson, & Ferreira, 1998). PT minimizes environmental impacts while not holding back level of services to support economic development (DIANA; MOKHTARIAN, 2009). Findings of a study conducted in India show that improving bus and NMT infrastructure in all mega, large and medium size cities leads to a significant decrease in CO₂ emissions. In addition, it was concluded that for megacities, both bus and non-motorized transport infrastructure needs to be improved in order to accommodate access and egress trips (JAIN; TIWARI, 2016).

Improving quality of PT services is crucial both to prevent potential car users to shift from PT as well as to provide a good alternative for individuals who do not own a private vehicle.

Even though PT is widely considered a sustainable alternative, it still attracts mostly the captive users in developing countries, those with no other option for their daily trips, and it is considered as a slow option when the entire journey is accounted for (BRUSSEL; ZUIDGEEEST; DE SOUZA, 2011).

Public transport trips require an access trip from the origin (for example home, in the case of a home-based trip) to the PT system, which can be made by different transport modes, and an egress trip from the alighting point to the final destination, which is usually made by walking. An attractive PT trip offers seamless connections between modes so that the inconvenience of the transfer is minimized: access trips, main trips and egress trips are smoothly linked (GIVONI; RIETVELD, 2007a).

The relation between the choice of main mode and feeder mode can be strong. For instance, in The Netherlands, the access mode share when the train is the main mode presents the bicycle as the most used mode (37%), followed by walking and PT (with the same share of approximately one quarter each) and the car with only 11% (KEIJER; RIETVELD, 2000). Slow modes (trams and local buses) attract fewer bicycles as feeder mode than faster modes (inter-city buses and trains). Also the distance travelled to access both modes is different: for slower modes people tend to cycle 2-3km and for faster modes 4-5km (MARTENS, 2004). For trips where the train is the main mode, the bicycle is the main feeder mode (35%) followed by walking and PT (but, tram, metro and taxi), both with 27%. Car is not that expressive when associated with train and it represents only 11% of all access trips (RIETVELD, 2000a).

Travel time is a relevant factor for access mode choice and for trips where walking distance is over 10 minutes, at both origin and destination, PT becomes increasingly unattractive (Hine & Scott, 2000). Krygsman et al (2004) state that not only the absolute access and egress time should be considered, but instead the relative share of these in the total trip time. The access and egress trip should not represent a significant part (time and distance) of the whole trip. If the access and egress trip correspond to a large part of the total travel time than the propensity to use PT is lower as a unimodal alternative can be more attractive, and faster. Distance is also relevant for access and egress trips and it is strongly related to travel time. The longer the trip, the lesser is the negative effect of access and egress trips (KRYGSMAN; DJIST; ARENTZE, 2004; RIETVELD, 2000a).

The percentage of walking trips falls significantly in distances longer than 3km in access trips to train stations in The Netherlands (Givoni & Rietveld, 2007). Also in The Netherlands, Keijer & Rietveld, (2000) and Rietveld (2000) found out that the

preferred access mode to train stations is walking for distances up to 1.2km, then the bicycle for distances between 1.2 and 3.7km and finally PT (bus and tram) for longer distances.

The average access distance to bus stops in India is shorter and 90% of the access trips are shorter than 1km (ADVANI; TIWARI, 2006a). This might be explained by the fact that distances between bus stops are smaller than metro or train and the Indian study focused on access journeys to bus stops only. Jiang et al (2012) researched walking trips to BRT stations in China. They concluded that the average distance walked to terminal stations is more than double the one walked to a non-terminal station.

Density has been reported by many authors as an important factor affecting transport use. Kim et al (2007) state that density matters to public transport as density is often correlated to ridership and it is confirmed by Kennedy (2002) who suggested that the provision of PT can be economically difficult to be provided in low density areas. Krygsman et al (2004) reported that as density increases, access trip time decreases up to an inflection point, when density reaches a certain level that causes pedestrian and cyclist congestion as people converge to a single station, resulting in longer times.

The availability of other modes of transport can influence the access mode choice. Givoni & Rietveld (2007) found out that the availability of bicycle and car did influence the choice of access mode to train stations in The Netherlands and Schwanen, Dieleman, & Dijst (2001) concluded that car ownership leads to less use of non-motorized transport and PT, even though this study was not specific for access trips.

Socio-demographic variables are not too significant for access trips. Individuals with children have shorter access time, probably because of the burden to have to accompany kids, they seem to choose the closer transport option (KRYGSMAN; DJIST; ARENTZE, 2004). Low income individuals walk longer than the average in China (JIANG; CHRISTOPHER ZEGRAS; MEHNDIRATTA, 2012) and in Brazil, people walk longer to replace one PT leg in order to save money (FETRANSPOR, 2004)

The importance of access trips for improving the overall PT journey and also for increasing the use of PT services has been acknowledged by many authors (BRONS; GIVONI; RIETVELD, 2009; BRUSSEL; ZUIDGEEST; DE SOUZA, 2011; GIVONI; RIETVELD, 2007a; KEIJER; RIETVELD, 2000; MURRAY et al., 1998). However, the

existing literature on access mode choice is mainly based on developed countries experiences. Many studies were conducted in The Netherlands and looked at access trips to railway stations (BRONS; GIVONI; RIETVELD, 2009; DEBREZION; PELS; RIETVELD, 2009; GIVONI; RIETVELD, 2007a; KEIJER; RIETVELD, 2000; RIETVELD, 2000a). Wu & Hine (2003) have looked at access trips to the bus network in Northern Ireland and Kim et al (2007) have focused mainly on access trips to train or light rail in the US. The work developed by Advani & Tiwari (2006) explored the bicycle as access mode to bus service in India whereas the study conducted by Jiang et al (2012) focused on the walk trip to BRT in China.

Understanding access mode choice is also crucial for transport operators, as a good accessibility to stops and stations can increase patronage. Brons et al (2009) found out that not only improving the quality of the access journey to the station is likely to increase rail use, but also that this measure is more important than facilitating the transfer between the access mode and the rail through better parking facilities at the station. Keijer & Rietveld (2000) also ratify the importance of local accessibility of train stations as a determinant of train use.

Access trips studies often look at socioeconomic, trip and land use characteristics to explain mode choice; on the other hand, users' preferences towards the access mode choice as a subjective factor in mode choice are not part of such studies. It is too restrictive to assume that only factors such as travel time, distance, cost or urban form affect mode choice. According to (P. Goodwin, 1995 apud (VAN EXEL; RIETVELD, 2009)) there is one simple but extremely important proposition for travel behavior analysis: people differ. Different users have different perceptions (JENSEN, 1999) and different perceptions can lead to different choices.

By looking at access trips to train as well as to bus and metro in Rio de Janeiro, Brazil, this study will bridge the gap both of a lack of studies looking at access trips to modes other than trains and also the lack of studies in developing countries. In addition, apart from the aspects commonly accounted for in access trips studies, this work also incorporates users' self-reported reasons for choosing access mode choice. The aim of this study is to investigate the main factors affecting the access mode choice to PT (for the main modes train, metro and bus) based on surveys carried out in two low income areas of Rio de Janeiro, Brazil and looking at socioeconomic characteristics of the users, trip characteristics, spatial characteristics and users' preferences.

2.1 Rio de Janeiro's transport system and travel dynamics

Rio de Janeiro has over 6 million inhabitants and is divided in 161 neighborhoods (IBGE, 2011). The average density of the city is 52 inhabitants/ha, and the highest density can be found in Rocinha, 483inh/ha. The area of the neighborhoods also varies substantially: the smallest neighborhood is 16ha and the largest neighborhood is almost 14,000 ha. According to the Census 2010, the average income for the city of Rio de Janeiro is R\$1,996/month (1US\$ = R\$1.66, in December 2010), however there is a large divide between the highest and lowest income per neighborhood: the lowest average income can be found in Grumari and is equal to R\$571/month whereas the highest average income of R\$8,286/month can be found in Lagoa (Armazem dos Dados, 2014). The characteristics of the transport system in the city of Rio de Janeiro are shown in Table 1 and the transport system in the city of Rio de Janeiro is illustrated in Figure 3.

Table 2: Transport system characteristics

	Extension	Stations/Stops
Metro	48km, divided in 2 lines	35 stations
Train*	149.9km of urban trains, divided in 5 corridors	71 stations
BRT**	56km, 1 line	74 stations and 9 integration terminals
Road network	3357km of roads	

* within the borders of the municipality of Rio de Janeiro. The train network exceed the borders of Rio de Janeiro and therefore the total extension of the train network and number of stations are larger than those mentioned here

** the operation of the BRT Transoeste started after the present survey was conducted

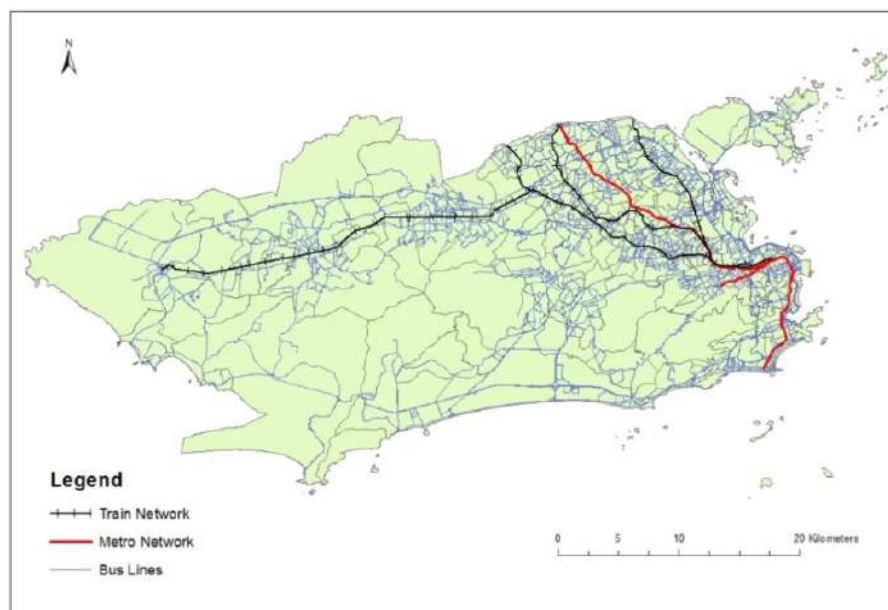

Figure 7: Rio de Janeiro Public Transport Network

According to the results of the last Origin-Destination (OD) survey conducted in 2012, almost 51% of the trips generated in the Metropolitan Region of Rio de Janeiro (MRRJ) to the city of Rio de Janeiro are made by PT, followed by walking trips and individual motorized trips. It is important to mention that more than 60% of the trips originated in the city itself, the remainder in the other municipalities of the MRRJ (SETRANS/RJ, 2013).

One particularity of the transport habits in Rio is that the significant share of walking is mainly due to financial reasons, since transport is a substantial expense in the household budget (IBGE, 2004), especially for low income groups, and walking is a mode which involves no cost. When asked how often they walk in order to save the money used to pay the transport fare, 11% of the respondents answered that they walked every day or almost every day, 35% occasionally and 18% seldom (FETRANSPOR, 2004)

As for access mode choice, there is no official data available. However, Figure 8 provides an overview of the access modal choice for the three main modes (train, metro and bus) considered in the present study, based on our survey responses.

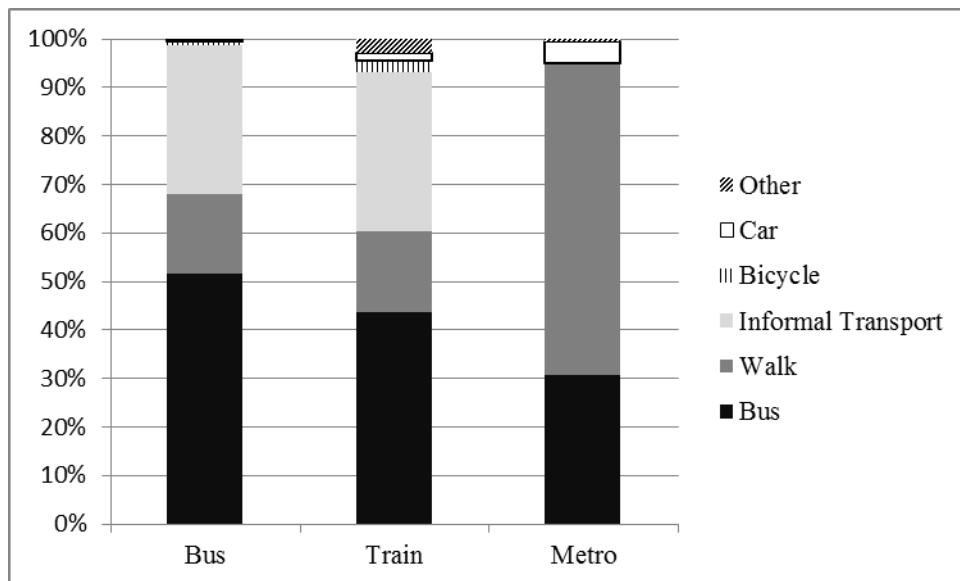

Figure 8: Access modal split

2.2 Case study areas

Two areas were selected for the case study: Santa Cruz and Colegio, as illustrated in Figure 9. Colegio is a neighborhood located in the North Zone of Rio de Janeiro with an area of 226ha and a density of 129 inh/ha, i.e. it has a high density and a small area. The average income of this neighborhood is below the average of the city of Rio, with R\$1,037. As for transport supply, Colegio is served by a metro station and

also by bus lines. Since Colegio is a small neighborhood with a high density and served by buses and the metro, the access trips to PT are short.

Santa Cruz is located in the West Zone of Rio de Janeiro and it is the second biggest neighborhood of the city, with an area of 12,504ha. Its density is one of the lowest in the city: 17inh/ha. Santa Cruz has an average income slightly lower than Colegio (R\$941). Santa Cruz is served by train, buses and informal transport (IT). The Santa Cruz train station is the final station of the train line, attracting passengers also from adjacent neighborhoods. Since the neighborhood is immense and the transport facilities serve also neighboring areas, the average access trip to PT is long.

The presence of IT in Santa Cruz and absence in Colegio can be explained by different factors. As mentioned above, the density of Santa Cruz is very low and its area is very large, which means that there are residential areas, with few people located far from the central area of the neighborhood where the train and buses depart to where the jobs are situated. As a consequence of the low density in the residential areas, there are not many bus lines serving these zones. This gap in the provision of formal PT fostered the appearance of IT operators in the region. Contrarily, in Colegio the density is high and the bus network is dense enough to meet the demand for PT.

2.3 Dataset and methodology

Passengers were approached at bus stops and at the train station in Santa Cruz and at the metro station in Colegio during peak hours of work days. PT users were the target group. In the first stage of the survey, the interviewers were asking filter questions to make sure the interviewees had the desired profile: the trip should be for work or study, it should be performed with the same combination of modes every day, the origin and destination should be in the city of Rio de Janeiro. If all these requirements were met, the interviewer asked if the PT user was interested in taking part in a telephone survey, and if so s/he would contact the user again by phone at the most suitable day and time declared by the respondent.

The complete survey could take from 5 to 10 minutes, and conducting it on the spot could jeopardize the completion of the survey before the bus/metro/train would arrive. The telephone interview was then the best alternative to complete the full survey.

For both the preliminary intercept survey and the telephone survey handheld computers were used by interviewers to capture the data. The use of such tool avoided

the possibility of introducing errors in transcribing the data and also sped up this process, as the data were automatically loaded to digital sheets.

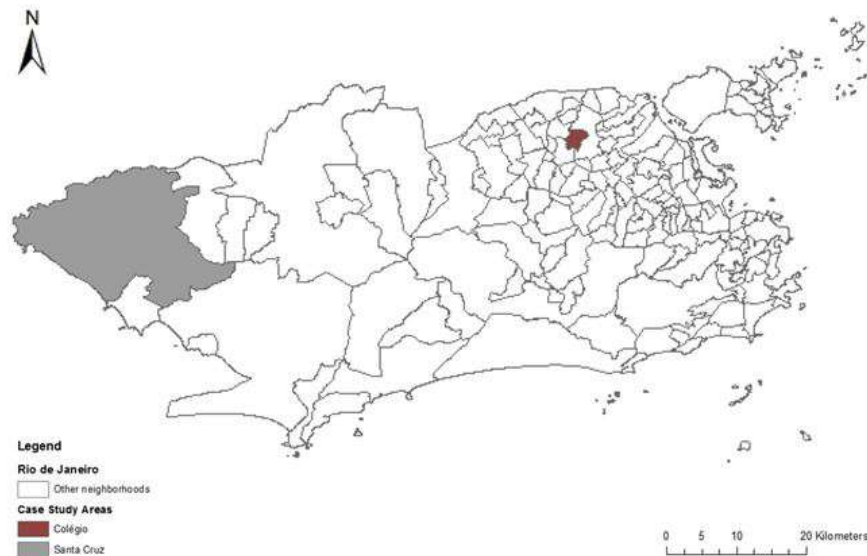

Figure 9: Study Cases location

The telephone interviews were finalized on January 2010. The questionnaire encompassed questions about:

- Socioeconomic characteristics: gender, age, income level, car ownership
- Transport chain: all modes used from origin to destination
- Behavioral aspects: reasons for choosing modes and boarding points; the respondents revealed why a certain mode was chosen
- Location: origin, destination as well as embarking and disembarking locations when changing modes

In order to enable spatial analysis, it was necessary to geo-reference the locations involved in this study (residence locations and PT boarding points). The first step was to divide the city of Rio de Janeiro into square grid cells measuring 800m x 800m. Each grid cell has one centroid. Using this grid cell size as the unit of analysis means that the maximum intra-grid cell trip distance is of approximately 565m (if you consider the distance from the corner of the square to the centroid) which is reasonable considering the proposed analysis and the scales of the trip and the areas. The next step was to use the information about the location of the survey to populate the centroids with the residence locations of the interviewees, as well the boarding points. For the analysis, all distances considered are the network distances between centroids.

2.4 Survey results

A total of 505 valid surveys were used for the analysis of the results. Incomplete questionnaires were excluded from the analysis. Also access modes with few cases which would not be of significance in the analysis were excluded (car, car passenger and bicycle). Table 2 provides an overview of the descriptive statistics on PT users in both case study areas.

When it comes to access mode shares, a substantial difference can be noted amongst locations. In Colegio 80% of the trips are made by walking, due to the short distances while in Santa Cruz this percentage drops to 20%. Here the bus and the informal transport (IT) are almost equally used (42% and 38%, respectively). The higher use of motorized modes in Santa Cruz can be justified by the longer distance and the presence of IT as explained above.

Table 3: Sample's descriptive statistics

		Access Mode			
		Bus (%)	IT (%)	Walk (%)	Total (%)
Neighborhood	Colegio	18.1	0.0	81.9	27.3
	Santa Cruz	42.2	38.1	19.6	72.7
Gender	Female	34.0	32.4	33.7	61.2
	Male	38.3	20.4	41.3	38.8
Age Range	Up to 34 years	35.7	26.0	38.4	51.1
	35 to 54 years	36.9	29.4	33.6	42.4
	Older than 55 years	27.3	30.3	42.4	6.5
Income	up to 1 MW	33.1	28.2	38.7	28.1
	1.01MW - 2 MW	38.6	30.5	31.0	41.6
	2.01 MW - 3 MW	38.6	26.5	34.9	16.4
	> 3.01 MW	28.6	20.0	51.4	13.9
Car Availability	Yes	32.2	28.0	39.7	42.4
	No	38.1	27.5	34.4	57.6
Bicycle Availability	Yes	35.9	30.4	33.7	64.6
	No	35.2	22.9	41.9	35.4
Density TAZ	Low (up to 7500h/km ²)	41.9	38.4	19.7	72.3
	Medium (7500 to 15000h/km ²)	16.9	0.0	83.1	24.6
	High (More than 15000h/km ²)	28.6	0.0	71.4	2.8
Access Trip	up to 1km	5.3	7.9	86.8	15.0
	1.01km to 2km	19.8	3.3	76.9	18.0
	2.01km to 5km	40.9	37.5	21.6	41.2
	> 5km	56.2	40.8	3.1	25.7

In terms of socioeconomic characteristics, there are few striking differences between both areas: the bicycle availability is higher in Santa Cruz, which can be

explained by the better bicycle infrastructure combined with a low density and scarce PT provision. In addition, the share of the upper income range is higher in Colegio than in Santa Cruz.

The share of access mode per distance range is presented in Figure 10. Walking is the preferred mode for short distances (up to 3km) followed by a steep drop for trips longer than 3 km. On the other hand, bus and IT are the most used mode after 3km and its relevance increases as distance also increases.

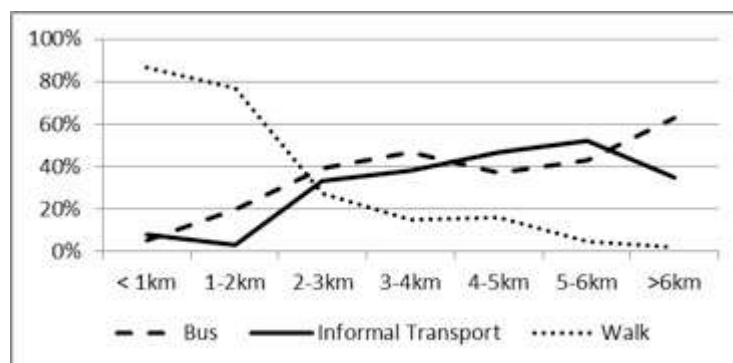

Figure 10: Access mode share per distance range

When it comes to distance of access mode per main mode, there is no significant difference between the average distances travelled by motorized access modes (bus and informal transport). As for motorized modes versus non-motorized mode (walking), there is a considerable variation, as expected. The maximum distance is greater for access trips in Santa Cruz than in Colegio (Table 4).

Table 4: Access trips distances

	Trip lengths (m)								
	Santa Cruz						Colegio		
	Bus			Train			Metro		
	Average	Min	Max	Average	Min	Max	Average	Min	Max
Informal Transport	4335	939	9607	4670	939	13535			
Bus	4822	936	13278	4924	936	14360	2862	1314	6783
Walk	2133	0	6043	2248	0	5735	1052	0	6857

Figure 11 shows the distribution of origins (respondents' home) for both locations: in Colegio the respondents are more concentrated than in Santa Cruz, where they are more spread.

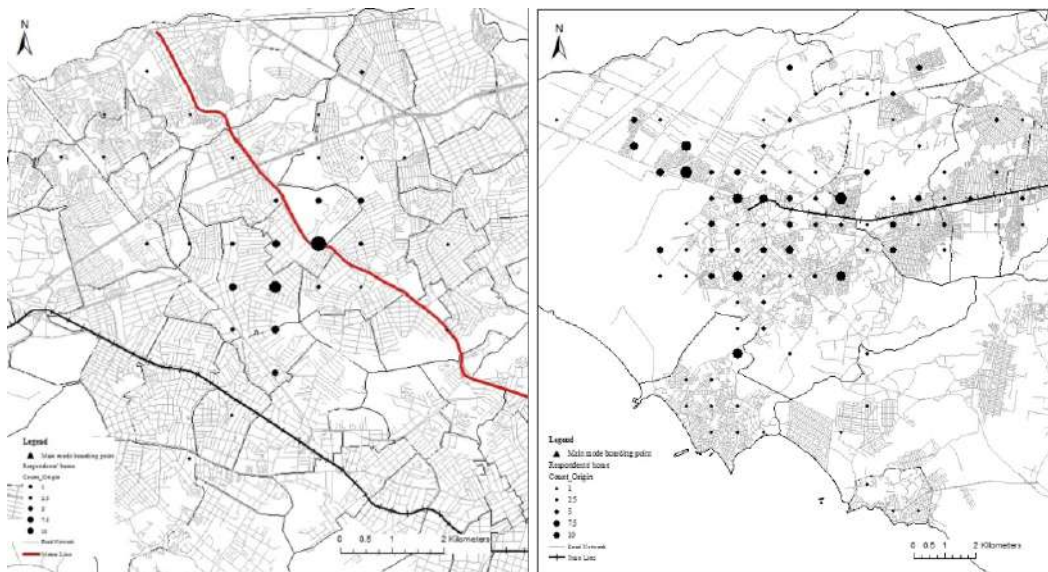

Figure 11: Distribution of origins in Colegio (a) and in Santa Cruz (b)

2.5 Model estimation and results

2.5.1 Analytical framework

For the present study we are looking at modelling the mode choice in access trips to PT. The access trip is the first stretch of a public transport trip. In this particular case, it starts necessarily at the origin (individuals' residence) and it ends at the main mode boarding point (bus stop, train or metro station).

Discrete choice models are used to describe decision-maker's choices among alternatives (TRAIN, 2003). These models have been increasingly adopted in transport research in order to gain a better understanding on travel behavior (KOPPELMAN; BHAT, 2006). Logit models have been extensively used in travel behavior and mode choice analysis (CHERCHI; CIRILLO, 2010; CHERRY; CERVERO, 2007; DEBREZION; PELS; RIETVELD, 2009; EWING; SCHROEER; GREENE, 2004; KIM; ULFARSSON; TODDHENNESSY, 2007; LARSEN; EL-GENEIDY, 2011; RODRÍGUEZ; JOO, 2004; SMART, 2010).

A multinomial logit model (MNL) was estimated in order to identify the main factors affecting the choice of access modes. The MNL is a well-known structure among the discrete choice models (TRAIN, 2003), where the probabilities of alternatives is calculated via the following function:

$$P_{ni} = \frac{e^{\lambda V_{ni}}}{\sum_{j \in C_n} e^{\lambda V_{nj}}}$$

The dependent variable is access mode choice. The respondents were asked which mode of transport they used from home to the main mode boarding point. The bus is the reference category, so the coefficients measure the change in walking and informal transport (IT) in relation to the choice of the bus. Socioeconomic, trip and spatial variables as well as users' preference were entered in the model.

Table 5 presents the list of variables and descriptions included in the model.

Table 5: Explanatory variables definition

Variable	Description	Value
Socioeconomic variables		
Age	in the survey form the age of the respondent was asked, but for the model the age variable was separated into discrete categories and each category was transformed into dummy variables	<24 years: yes = 1; otherwise 0 25 to 34 years: yes = 1; otherwise 0 35 to 44 years: yes = 1; otherwise 0 >45 years: yes = 1; otherwise 0
Gender		if female =1 if male =0
Users' perceptions		
Proximity from home	if the proximity from home is the reason revealed by the respondent for having choosing a certain mode.	yes = 1; otherwise 0
Captivity	if the reason why the respondent used the mode is because it is perceived as the only option available for the trip	yes = 1; otherwise 0
Cost	if the cost of the chosen mode is the reason revealed by the respondent for having choosing a certain mode	yes = 1; otherwise 0
Travel Time	if the reason why the respondent used the mode is because it is perceived as fastest option for the trip	yes = 1; otherwise 0
Frequency	if frequency cost of the chosen mode is the reason revealed by the respondent for having choosing a certain mode	yes = 1; otherwise 0
Transport supply variable		
Availability of alternative access mode	if this trip could have been made by another transport alternative	yes = 1; otherwise 0
Spatial variables		
Access trip distance	the network distance of the access trip (i.e. from home to the main mode boarding point (bus stop, metro or train station)	distance in km
Density	the density of the origin's TAZ	inhabitants/km ²

2.5.2 Results

The MNL access mode choice model was estimated using Biogeme (BIERLAIRE, 2009a). The best-fit model is presented in Table 5. The convergence of the MNL model was found to be satisfactory.

Table 6 shows that young people (younger than 24 years) are less likely to choose informal transport (IT) than individuals from other age ranges whereas age seems not to influence the choice of walking as access mode. The fact that age does not influence the choice of walking as an access mode can be surprising as it is expected that youngsters would walk more. However, this might not be true in this case due to the low income nature of the areas studied. Previous works have shown that low income individuals tend to walk more regardless of their age (ADVANI; TIWARI, 2006a; FETRANSPOR, 2004; JIANG; CHRISTOPHER ZEGRAS; MEHNDIRATTA, 2012).

Table 6: MNL analysis of access mode choice to bus stops, train and metro stations

	IT		Walk		
	Coeff	St. Err.	Coeff	St. Err.	
Age =<24	-0.529	0.389			
Female	0.552	0.3		*	
Proximity from home			3.43	0.441	**
Frequency	1.52	0.334			**
Captivity	-0.966	0.345			**
Cost	2.38	0.477			**
Travel time	0.58	0.314			*
Bus as alternative access mode	-3.43	0.385	-3.35	0.617	**
Walking as alternative access mode	-1.55	0.37			**
Density			0.00625	0.00324	*
Access trip distance			-0.864	0.141	**
Constant	0.316	0.362	1	0.519	
Likelihood ratio test (14df): 638.95					
Cte log-likelihood: -551.074					
Final log-likelihood: -235.324					
Adjusted rho-square: 0.551					

Note: reference mode is bus
 Number of observations = 505
 * Significant at a 90% level
 ** Significant at a 99% level

Surprisingly, being a woman increases the probability of choosing this mode as compared to men. During qualitative data collection, users reported that IT vehicles often present poor maintenance and it is not uncommon that they break down during a trip. Since IT is perceived as unsafe, it was presumed that women would avoid this mode. However, it might be the case that, since IT also was perceived as a higher frequency option than the bus, women prefer to take the first option. Age has no influence on the choice for walking, which is unexpected. The youngsters are expected to be more likely to walk due to an assumedly better physical condition.

Users' self-reported attributes of access mode choice appeared as relevant parameters in the model. Those who choose the mode due to the short distance to the stop/station or due to price (cost) are more likely to walk, as expected, since walking is a free mode and it is suited for short distance trips. The high coefficients of both parameters highlight their importance.

Captivity has a negative effect on IT choice, indicating that the users' who indicated captivity as their attribute of choice are less likely to use IT as compared to bus, which means that bus is perceived as their only option available.

When it comes to travel time and frequency, respondents who are concerned about it are more likely to take IT than bus, which shows that IT is perceived as a faster option. This can be explained by the fact that its capacity is smaller (small vehicles, usually up to 18 passengers, approximately) and when it reaches its full capacity, it does not need to stop to get more passengers and also it has flexible itinerary, allowing for shortcuts. And also IT does not necessarily follow a formal schedule as bus and therefore is more flexible and can deviate from traffic jams or take detours in order to save time in the itinerary.

The ration between frequency and travel time parameters, show that frequency is three times as important as travel time, for informal transport users (IT). Similarly, analyzing the cost parameter in 'walk' alternative, it is clear that some people prefer to walk, as mean to save cost, and cost was not a significant parameter for IT. Furthermore, the marginal utility of 'proximity from home' is significantly higher than cost for walking trips.

The availability of an alternative access mode is also an important parameter in the model. Respondents were asked whether this access trip could have been made by other transport mode and for affirmative answers, which mode could have been

used. Results show that the existence of an alternative access mode (bus or walk) has a negative influence on the choice of both IT and walk for access trips.

Access trip distance has a negative impact on walking, unsurprisingly. As distance increases, the probability of walking decreases. As shown in Figure 10, the share of walking trips drops drastically for trips longer than 3km, confirming the findings from studies conducted in The Netherlands (Givoni & Rietveld, 2007; Keijer & Rietveld, 2000; Rietveld, 2000). The average walking distance to bus stops in Santa Cruz is 2.1 km which is longer than the one presented in the Indian case for bus stops (ADVANI; TIWARI, 2006a) and in the Chinese case for BRT terminals (JIANG; CHRISTOPHER ZEGRAS; MEHNDIRATTA, 2012). The higher distance walked in Santa Cruz can be explained by its low density and consequent low density PT network.

Finally, density is also a relevant factor. Higher density is associated with a higher number of walking trips. Comparing the walking distance in both areas analyzed in this study, as illustrated in Table 3, the average distance traveled in Santa Cruz is much longer than in Colegio, where the density is higher, which is in consonance with studies indicating that higher density areas tend to present fewer km travelled (CERVERO; KOCKELMAN, 1997; MAAT; WEE; STEAD, 2005; VAN WEE, 2002).

It is important to mention that some parameters did not enter the model due to statistical insignificance. They are: income, car ownership, car availability (if the person has access to a car even though s/he does not own one), bicycle ownership, bicycle availability, frequency of alternatives (as a preference variable), and main mode used. The insignificance of the variables related to income (car and bicycle ownership/availability and income itself) can be explained by the fact that both case study areas are low income areas and there is not much variation of income levels. The main mode used subsequently to the access mode also does not play a role, probably because in this case the boarding point (bus stops and train and metro stations) were located in the same place. Maybe if there were distinct boarding point locations, this could be influenced differently.

2.5.3 Forecasting

The forecasting capability of the model can be very useful to predict the effect of possible changes in some parameters on access trip modal share. For this study, three possible changes were tested: 30% increase in access trip distance, 30% decrease in access trip distance and finally an increase of 10 times in density in Santa Cruz. Since the density in this area is amongst the lowest in the city, the increase of it in 10 times,

even though unrealistic in terms of an actual urban intervention, seems rather possible when compared with other higher density areas in the city.

Each change was tested separately, and once at a time so that the effect of each one could be evaluated. The results are shown in Table 6. The predicted modal share represents the probability of the mode being chosen considering the suggested change in one parameter (density or distance). The variation in modal share (elasticity) is the increase/decrease of modal share compared to the base model.

The growth of the density of 10 times in Santa Cruz causes an increase of more than 13% in the walking modal share. This is in line with the knowledge that areas with higher density lead to more non-motorized trips due to on average shorter trips.

Table 7: Access trips modal share variations

	Bus modal share		IT modal share		Walk modal share	
	Predicted	Variation	Predicted	Variation	Predicted	Variation
Forecast base model	35.64%		27.72%		36.63%	
Increase in 10 times the density in Santa Cruz	32.21%	-9.63%	26.24%	-5.37%	41.55%	13.43%
Increase 30% in walk access trip distance	37.69%	5.76%	29.09%	4.91%	33.22%	-9.32%
Decrease 30% in walk access trip distance	33.15%	-7.01%	25.90%	-6.58%	40.96%	11.80%

As expected, the effect of a decrease of 30% in access trip distance leads to a growth in walking modal share and a consequent drop in the motorized modes (bus and IT) shares. Contrarily, an increase of 30% in access trip distance results in a decrease of almost 10% in the walking trips modal share. Whereas a smaller impact on the motorized access modes (namely IT and bus) occurs for each mode, with an increase of approximately 5%. The walking modal share was the most affected by all the hypothetical changes. This can be justified by the fact that walking is an active means of transport and therefore it is very susceptible to travel distance.

2.5 Conclusions and recommendations

This study analyzed the access mode choice to bus stops, metro and train stations in two low income areas in Rio de Janeiro, Brazil. Most of the studies that look at access trips are conducted in developed countries and the few studies available in developing countries focus mainly on access trips to one specific main mode. It is necessary to investigate access trips in cities where the urban form, transport provision, urban dynamics and other factors differ from those present in developed countries. Furthermore, looking at access trips to different main modes in the same city enables the comparison and possible identification of differences which can inform policy response.

Results show that gender, age, individuals' self-reported reasons for choosing a mode, availability of an alternative access mode, distance and density play a role in access mode choice.

The fact that informal transport seems to be perceived as a faster mode than bus increases its chance of being chosen over the bus as access mode. This can be valuable information for bus operators, as they can work to optimize their itineraries and provide faster routes to attract more users.

The effect of main mode on access mode choice seemed to be not significant, as could be expected. This contradicts studies conducted in The Netherlands where there is a strong relation between access mode and main mode choice (KEIJER; RIETVELD, 2000; MARTENS, 2004; RIETVELD, 2000a). However, a limitation of this study is the fact that the surveys were conducted in only one metro station (Colegio), one train station (Santa Cruz) and two bus stops (Santa Cruz). As a result, the insignificant impact of main mode on the access mode choice cannot be generalized.

Both in Santa Cruz and Colegio the availability of other modes of transport (bicycle and car) has no significant effect on access mode choice, contrarily to the findings from Givoni & Rietveld (2007), Schwanen, Dieleman, & Dijst (2001) for the Dutch case. The fact that the car is not used for access trips despite the availability can be explained by the high cost of use associated to lack of parking places in the surroundings of the stations. As for the non-use of the bicycle, even though it is available, this can be due to the fact that the lack of parking facilities can hinder its use and in many cases, as mentioned, the distances to be covered can also be too long for this mode (DE SOUZA et al., 2010). Also in Brazil the bicycle is associated to leisure and a way of exercising and not always as a mode of transport.

Consistent with MURRAY *et al* (1998) in Santa Cruz it was found that captivity is an important factor affecting access mode choice as distances are long to be walked and the bus is perceived as the only alternative. Some trips could be made by bicycle, mainly those up to 5 km, if proper infrastructure is provided.

The results of this chapter point on the importance of level of service in access modes. Consistent with Hale (2011) who highlights that transit agencies are responsible for the access and they need to not only assess the level of service for access by different modes, but also to assist in the identification of design and infrastructure improvements on the access to PT.

Furthermore, by encouraging the use of bicycle, travel time for walking trips would decrease as the bicycle is three times faster than walking (ADVANI; TIWARI, 2006a). Improving bicycle parking around the stations and stops and also the pro-bicycle infrastructure (bicycle paths, signaling, and lighting) may enable people who currently walk to shift to this faster but equally sustainable mode.

As policy recommendations, transport and urban planners have to look at the transport system as a whole and identify the particularities of some location and tackle it accordingly. For instance, low density areas require large investments in PT to generate a substantial improvement in PT quality .

Furthermore, by adopting the forecasting functionality, this study confirmed the positive effect of higher density areas and shorter distance on non-motorized modes, in this case, walking. This capability of the model provides an insightful tool for urban and transport planners to test the effect of possible changes in the transport system, the built environment and urban development on transport patters. This tool can assist decision makers in prioritizing investments and possible changes.

As future research, a complementary survey can extend the study areas to different income levels. Such extension would prove (potential) differences, which were not possible to show in the present paper because both locations surveyed are low income areas.

Similarly, this chapter shows that walking is an important access mode regardless the area and the main mode. Improving the quality of those trips is also important. The built environment plays a major role in walking trips to PT (JIANG; CHRISTOPHER ZEGRAS; MEHNDIRATTA, 2012), and therefore it is worthy to have further studies looking into the built environment effects on walking trips not only to

improve the quality of current walkers, but also to attract mode PT users to access stations and stops by this sustainable mode.

Finally, future research can look at multiple boarding points (stations and stops) for each main mode which would give more indication on the (potential) effect of main mode on the access mode choice.

3 MODELLING THE POTENTIAL FOR CYCLING IN ACCESS TRIPS TO BUS, TRAIN AND METRO IN RIO DE JANEIRO¹

3.1 The access trip to public transport

The increasing concentration of people in urban areas has a great impact on the dynamics of cities, as people need to engage in all sorts of activities. Motorization levels have never been so high. This is also happening in developing countries with traditionally lower car ownership levels. For instance, the figures from Brazil show that the number of cars has doubled from 2001 to 2012 (RODRIGUES, 2013), whereas in India it has been increased with 10-15% per year (TIWARI, 2002).

The highly motorized cities have a large negative impact on the quality of life of their residents. Congestion, noise and air pollution, time loss and energy consumption are some of the undesirable impacts of the increasing motorization levels. A shift from this individual and motorized paradigm to a more sustainable, active and collective perspective is urgent.

The use of public transport (PT) has been greatly acknowledged as a sustainable alternative (Diana and Mokhtarian, 2009; Grotenhuis et al., 2007; Hensher, 2007; Jiang et al., 2012; Kennedy, 2002; Krygsman et al., 2004; Murray et al., 1998). Public transport trips necessarily require an access leg from the origin to access the boarding point of the public transport (PT) system and an egress leg to access the destination. This access trip can be done by different modes, either motorized or non-motorized, private or public, and the more seamless and smooth this sequence of modes is, the more attractive the PT trip will be. Bicycle use when properly integrated with the public transport system is an efficient option as it combines the benefits of the non-motorized modes (NMT) with the strengths of PT.

The benefits of bicycle use as a mode of transport have been widely acknowledged (Advani & Tiwari, 2006; Martens, 2004, 2007; Ortúzar et al., 2000; Rietveld, 2000b). Especially in short trips the bicycle is attractive, not only for its environmental performance but also for its intrinsic characteristics such as low cost and

¹ This chapter was published as Carvalho de Souza, F., La Paix Puello, L. C., Brussel, M. J. G., Orrico, R., & van Maarseveen, M. F. A. M. (2017). Modelling the potential for bicycle in access trips to bus, train and metro in Rio de Janeiro. *Transportation research. Part D: Transport and environment*, 56, 55-67. DOI: 10.1016/j.trd.2017.07.007

high speed (Rietveld, 2000a). Cycling is not only environmentally friendly, but also a healthy way of traveling, it demands less public space than alternative modes and - even more important for developing countries - it is a low-cost mode. Once the individual owns a bicycle, there are barely any costs involved in its maintenance (ADVANI; TIWARI, 2006a).

Additionally, the bicycle is a door-to-door transport alternative, as it can make use of the same dense network used for motorized vehicles and pedestrians. Furthermore, it does not require waiting times as PT modes do, and it is, along with walking, an essential element in multimodal trips (Rietveld, 2001).

The use of non-motorized modes such as walking and cycling in access trips influences the way impedances in multimodal trips are perceived positively (Rietveld, 2000a). The average speed of cycling is three times faster than walking; consequently, bicycle use in access trips significantly increases the catchment area of a public transport service. From the users' perspective it means savings in travel time. Advani & Tiwari (2006) stress that the combination of bicycle and PT improves the travel potential for both modes, since it provides benefits that each mode alone is not able to provide, as PT cannot have the network penetration of cycling and the bicycle cannot be as fast as PT over longer distances.

Despite the potential of the bicycle as an access mode to PT, there is still a lot unknown about it. The role of NMT in transport systems is underestimated (Jones and Buckland, 2008; Quarshie, 2007) and there is a lack of information on trip and user characteristics and on the factors affecting such a trip (Martens, 2004). Some authors blame the lack of information about access trips on the fact that trips are usually reported based on the main mode (Martens 2004; Rietveld 2000a).

Many of the studies about integration of bicycle and PT focus on the Dutch case, where bike and ride is extensively used (Keijer and Rietveld, 2000; Martens, 2007; Rietveld, 2000a, 2000b). Studies in other countries (e.g. Latin America) are not common. The few that can be found are in Japan (REPLOGLE, 1992), Sweden (RYSTAM, 1996), New Zealand (Ensor and Slason, 2011) and the USA (HARTWIG, 2013). In addition Martens (2004) provides figures on bicycle use as a feeder mode to PT in three countries: Germany, UK and Denmark. Even though there are some self-contained studies in developing countries (Advani and Tiwari, 2006; Bechstein, 2010; Quarshie, 2007), there is still a lack of deep understanding on the potential for bicycle and PT integration, in particular on the integration of bicycle with other modes than train. Moreover, there is a lack of studies that incorporate behavioral factors such as

attitudes, motives and preferences, when analyzing and modeling choice behavior (Puello and Geurs,2015).

This paper aims to fill these gaps: first, by adding to the current body of literature a developing country perspective on the topic; second, by incorporating behavioral factors in the model (self-reported barriers and motivators) and third, by looking at bicycle potential in access trips not only for train stations, but also for metro stations and bus stops. The objective of this study is to model the main factors affecting the propensity of current PT users to use bicycle as an access mode to PT in two low-income areas of Rio de Janeiro. Socio-economic, transport and spatial characteristics as well as behavioral factors are analyzed. These factors are divided in self-reported barriers and motivators for bicycle use in access trips. Different sets of factors are entered in two binary logit models. The use of logit models has become more popular in travel behavior and mode choice analysis (Cherchi and Cirillo, 2010; Cherry and Cervero, 2007; Debrezion et al., 2009; Ewing et al., 2004; Kim et al., 2007; Larsen and El-Geneidy, 2011; Rodríguez and Joo, 2004; Smart, 2010). Discrete choice models to describe potential bicycle demand have also been reported (Bachand-Marleau et al., 2012; Nkurunziza et al., 2012; Ortúzar et al., 2000; Parkin et al., 2008).

3.2 Previous studies on bicycle use and behaviour

Bicycle share in PT access trips varies significantly over cities/countries and also depends on the next main PT mode used in the trip (Table 7). Bus and metro appear to attract fewer cyclists than train or express bus. Even when the bicycle is used to access the same transport service, such as regional trains, differences can be noticed across locations: the share in the UK is significantly lower than in The Netherlands or Sweden.

In Montreal, Canada, 43% of the public bicycle system users make a multimodal trip, from which 30% use it as access or egress to/from metro and 12% in similar way for bus (BACHAND-MARLEAU; LEE; EL-GENEIDY, 2012). Unfortunately, figures on bicycle share in access trips for developing countries have not been found, except for the Indian case earlier mentioned.

According to Martens (2007), "(...) the barriers for changing travel behavior in access trips may be substantially lower than those that prevent overall mode change", indicating that it can be easier to tackle the feeder modes specifically. There is a large potential for cycling to substitute this part of the trip, especially in large cities, where the

main mode usually covers long distances and the access trip tends to be relatively short. Trip makers can choose from different multimodal chains or combinations of modes (Keijer and Rietveld, 2000), which means that influencing access trips can positively influence overall multimodal trips experience.

When used in integration with PT, the benefits of the bicycle are even more visible. The bike and ride practice reduces the energy use, air and noise pollution, congestion levels and the need of car parking spaces. It can also strengthen the economic performance of certain PT lines/corridors, by increasing patronage, for example attracting additional users. In addition, it is important from a perspective of social justice, as it is a high-quality alternative for those who cannot afford the car (MARTENS, 2004), or are PT captives.

When regarding the factors affecting bike use, socio-economic characteristics matter. Men tend to cycle more than women, and so do youngsters (Dill and Voros, 2008; Stinson and Bhat, 2004). Car ownership can also influence ridership, but available studies reveal that it is not a determinant (Martens, 2004; Parkin et al., 2008; Puello and Geurs, 2015). In developing countries, owning a car is a proxy of income level, since not everyone can afford to have one. Therefore, in many cases, bicycle use is seen as transport mode for the poor (Bechstein, 2010; Pochet and Cusset, 1999).

Table 8: Share of bicycle trips (%) as access mode to PT

City/Country	Regional	Suburban	Express	Bus	Metro
	Train	Train	Bus		
The Netherlands*	30		14	6	1
Munich, Germany*	16	10		4	5
UK*	3			4	
Copenhagen, Denmark*	25	22	12	4	
Tokyo Region**		13			
Malmohuslan, Sweden***	30-55				
Delhi, India****				<1	

*(Martens 2004)

**(Replogle 1993)

***(Rystam 1996)

****(Advani & Tiwari 2006)

Equally, trip purpose and the combination of modes and distance play a role. Frequent trips, such as to work and study, are the majority of bike-PT trips in The Netherlands. Slow modes (trams and local buses) attract fewer bicycles as feeder

mode than faster modes (inter-city buses and trains). Also the distance travelled to access both modes is different: for slower modes people tend to cycle 2-3 km and for faster modes 4-5km (MARTENS, 2004). Other Dutch studies confirm the relation between distance and access trip distance showing that the preferred access mode to train stations is walking for distances up to 1.2 km, then the bicycle for distances between 1.2 and 3.7 km and finally PT (bus and tram) for longer distances (Givoni and Rietveld, 2007; Keijer and Rietveld, 2000; Puello and Geurs, 2015; Rietveld, 2000b).

Population density has an influence as well on access trips. Krygsman et al. (2004) found out that for access trips, as density increases, travel time decreases up to an inflection point. However, when density reaches a certain level that causes pedestrian and cyclist congestion, it results in longer travel times.

The origin location is also important, since stops/stations located in suburban areas tend to attract more cyclists than those located in central areas (MARTENS, 2004). Other factors that have a positive impact on bicycle use for short-distance trips, and the integration with PT are: compact development patterns, a high quality PT system, high costs associated with private car use, low rates of bicycle thefts and crime, and significant investments in bicycle infrastructure and traffic calming measures (REPLOGLE, 1992).

The size of the city can also have an influence on bicycle usage. The National Association for Public Transport (ANTP) developed a report on urban mobility in Brazil. The report provides an overview of the role of the bicycle in urban mobility. Bicycle use in Brazil increases as the size of the city decreases. For small cities with a population size between 60 and 100 thousand, the bicycle accounts for 13% of the total trips and this share drops to 1% in cities with more than 1 million inhabitants (ANTP, 2012).

Weather also affects bicycle use. In northern countries a warmer climate has a positive effect on the level of cycling (MARTENS, 2004; PARKIN; WARDMAN; PAGE, 2008), whereas in (sub)tropical areas people tend to cycle more during winter time when outside temperatures do not reach high levels (NKURUNZIZA et al., 2012).

Different studies reveal that infrastructure problems and safety are the most commonly mentioned barriers for bicycle use. Heinen et al (2011) acknowledged that safety-related issues such as lack of bicycle infrastructure or traffic conflicts can be problematic in countries where cycling is not as safe and common as in the Dutch case. In Dar-es-Salaam public safety, lack of bicycle parking facilities, lack of cycle paths and showers at the work place are the main barriers for cycling commuting, as

well as social status (NKURUNZIZA et al., 2012). In South Africa, the lack of cycling facilities does not prevent current cyclists to use the bike but it does not motivate potential users (BECHSTEIN, 2010). Motorized traffic intensities, lack of bike lanes and safety are the main barriers for cycling in major US cities (Dill and Carr, 2003). In Madrid, exogenous restrictions such as danger, vandalism and facilities are the most relevant factors that determine attitudes towards cycling (Fernández-Heredia et al., 2014).

On the other hand, the bike also has some characteristics that captivate current users and could attract new users to this mode of transport. Its convenience (flexible, efficient) was mentioned in Madrid (FERNÁNDEZ-HEREDIA; MONZÓN; JARA-DÍAZ, 2014), its price and quality in Dar-es-Salaam (NKURUNZIZA et al., 2012), its relatively low costs and associated physical activity in South Africa (BECHSTEIN, 2010) and its fast, flexible and healthy nature as well as again low costs in Rio de Janeiro (de Souza et al., 2011). In the Netherlands, a study revealed that improvements in the quality of unguarded bicycle parking facilities at train stations increases the number of train users cycling to the station (Puello and Geurs, 2015). In South Africa, in order to boost bicycle use the provision of safe and segregated bicycle infrastructure and traffic education are some of the measures that recommended (BECHSTEIN, 2010).

As discussed above, a variety of factors and conditions influence bicycle use as an access mode to PT. These factors are context specific, and comprise a mix of socio-economic conditions, bike-PT system facilities and performance, characteristics of the built environment and socio-cultural aspects. Whereas a number of factors are found to be generally valid in developed countries, others are not, and little is known about factors that apply in a developing country context, with completely different socio-economic and cultural realities. It emphasizes the complexity in understanding and further developing the role of the bicycle as access mode to PT in the latter context.

To this end, a broad approach has been pursued to identify the importance of factors for bike-PT trip making in the context of Rio de Janeiro, Brazil. A revealed preference survey has been conducted to identify the barriers and motivators for bicycle use as access mode. In the next sections, the case study areas are presented followed by the data collection methodology and the results.

3.3 Overview of Rio de Janeiro and the case study areas

3.3.1 Rio de Janeiro: brief overview

The population of Rio de Janeiro is over 6 million inhabitants (IBGE, 2011) and its average population density is 52 inhabitants/ha, although huge differences in density exist between neighborhoods. When it comes to income, a large divide can be seen between the highest and lowest income per neighborhood: the lowest average monthly income equals R\$571 whereas the highest average monthly income is R\$8,286. The overall average income per month for the city is R\$1,996 (1US\$ = R\$2.65, in December 2014) (Armazem dos Dados, 2014).

The city of Rio de Janeiro is divided in five Planning Areas (AP) in order to ease urban planning solutions for areas with neighborhoods with similar characteristics (Figure 12). AP1 is where the CBD (Central Business District) is located; it contains the largest share of jobs. In AP2 most high-income neighborhoods can be found as well as a substantial number of jobs. The neighborhoods in AP3 are small in size and have a high population density. AP4 has larger neighborhoods and population density is considerably lower than in the other APs. The lower-income neighborhoods are concentrated in AP3 and AP4, whereas AP4 consists of higher-income neighborhoods close to the coast and lower-income neighborhoods in its inner area. Finally, AP5 is the vastest in area, and its neighborhoods are large with the lowest population densities recorded in the city.

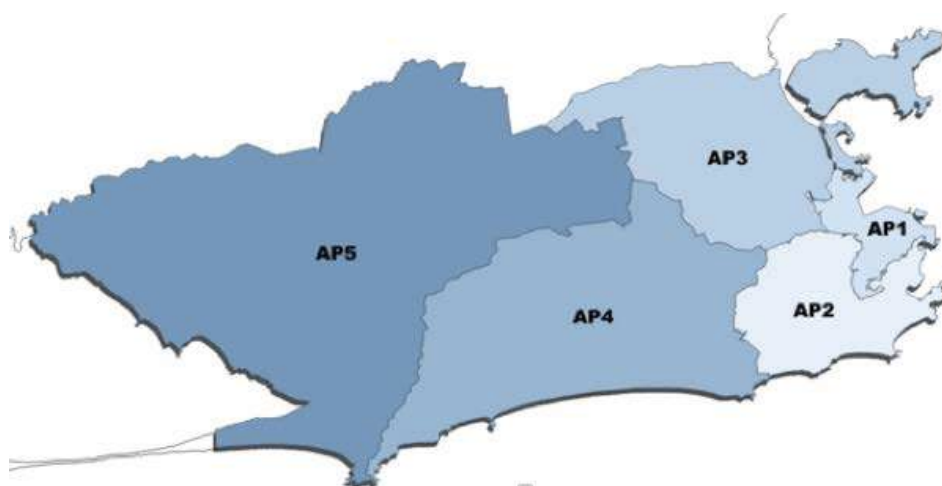

Figure 12. Planning Areas in Rio de Janeiro

The transport system of Rio de Janeiro includes 2 metro lines with a total length of 48 km and 35 stations that cover part of AP1, AP 2 and AP3. There are 5 metropolitan train lines with a total length of 150 km and 71 stations (within the borders of the municipality of Rio de Janeiro). The train network goes beyond municipal borders, so its length and number of stations is larger than mentioned here. The train lines run over parts of AP 1, AP3 and AP 5. The road network is over 3000 km long. Currently, there are two BRT lines in operation with a total length of 95 km and with 101 stations.

Almost half of all the trips generated (for all trip purposes) in the Metropolitan Region of Rio de Janeiro (MRRJ) to (and within) the city of Rio de Janeiro is made by PT, followed by walking and private motorized modes. More than 60% of the trips have its origin in the city itself and the remainder in other municipalities of the MRRJ. Work/study purpose trips correspond to 74% of all trips generated in the MRRJ (SETRANS/RJ, 2013). The significant share of walking is mainly due to financial constraints, as transport is relatively expensive considering the household budget (IBGE, 2004), in particular for low-income groups. A survey conducted among PT users by a transport operator in Rio de Janeiro revealed that the practice of walking in order to save money is well established in the city, as 11% of the respondents answered that they walked every day or almost every day, 35% occasionally and 18% seldom (FETRANSPOR, 2004).

The share of non-motorized transport (NMT) has dropped from 2003 to 2012. Bicycle use fell from 3.2% in 2003 to 2.4% in 2012 (SETRANS/RJ, 2014). Even though the bicycle share looks very low, it is worth noticing that bicycle and train have virtually the same modal share in 2012 (2.4% against 2.5%, respectively).

3.3.2 Case study areas

Two case study areas have been selected that differ in a number of relevant aspects to ensure variability in the analysis: Colegio (AP3) in the northern zone and Santa Cruz (AP5) in the western zone (Figure 13). Even though both of them are low-income neighborhoods, they differ in population density, bicycle use, public transport service provision and topography. As mentioned earlier, population density plays a role in bicycle use in general. Topography is also widely acknowledged as an important factor affecting bicycle use (DILL; VOROS, 2008; HEINEN; VAN WEE; MAAT, 2010; RIETVELD; DANIEL, 2004). Funding constraints allowed the choice of two neighborhoods only. In AP3 three neighborhoods (i.e. stations) were considered with

the same profile (Colegio, Irajá and Pavuna); the latter being close to the border with many users from outside the city, and the other two being quite comparable, Colegio was chosen. In AP5 Santa Cruz, Bangu and Campo Grande, all with similar characteristics, have been considered, and the first one was selected because it had the highest level of bicycle use.

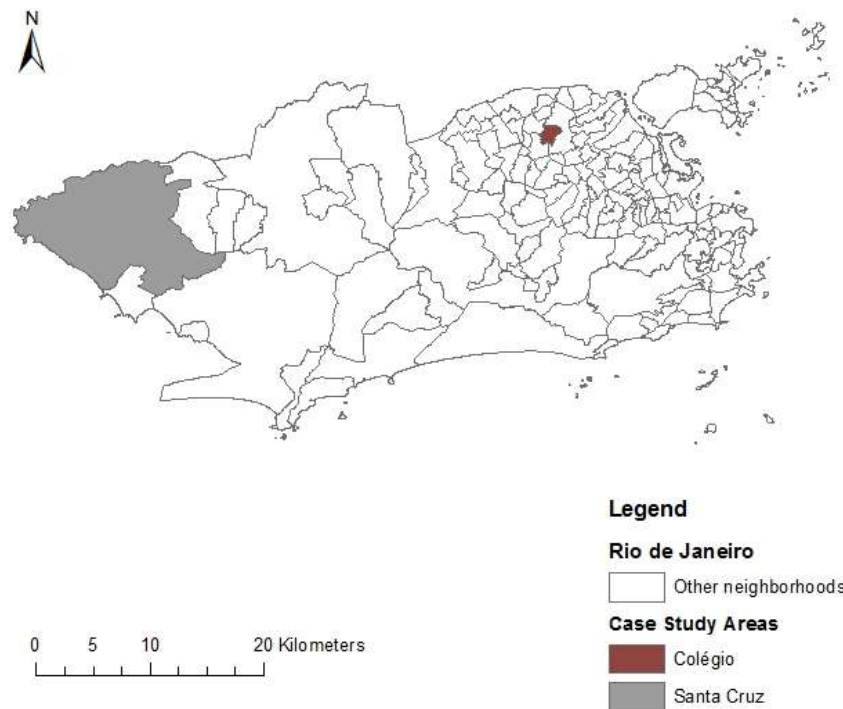

Figure 13: Case study locations

Colegio is a neighborhood with a small size (226.11 ha) and a high density (129 inhabitants per ha). Its average income (R\$1,037) is below the average of the city. As for transport supply, Colegio is served by a metro station and by bus lines. Since its size is small, access trips to PT are short. Colegio and its surroundings are partly hilly and partly flat and there is hardly any bicycle infrastructure, neither cycle lanes nor dedicated bicycle parking facilities.

Santa Cruz is the second largest neighborhood of the city, (area of 12.504 ha) and its density is one of the lowest in the city (17 inhabitants per ha). The average income for this neighborhood (R\$941) is slightly lower than in Colegio. Santa Cruz is served by train, buses and informal transport (IT). The Santa Cruz train station is the end-of-the-line station and it attracts passengers from adjacent neighborhoods too. Due to its immense size as well as the end-of-the-line nature of train and bus services, the average access trip to PT is long. The Santa Cruz area is quite flat and due to the

low density and scarce PT transport service, it is the area with the highest percentage of bicycle use in the whole city. The neighborhood has some cycle lanes and bicycle parking facilities; the latter are concentrated in the center of Santa Cruz, in the vicinity of the train station.

Figure 14 elicits the distribution of jobs over the city of Rio de Janeiro, with the highest concentrations highlighted in the two circles.

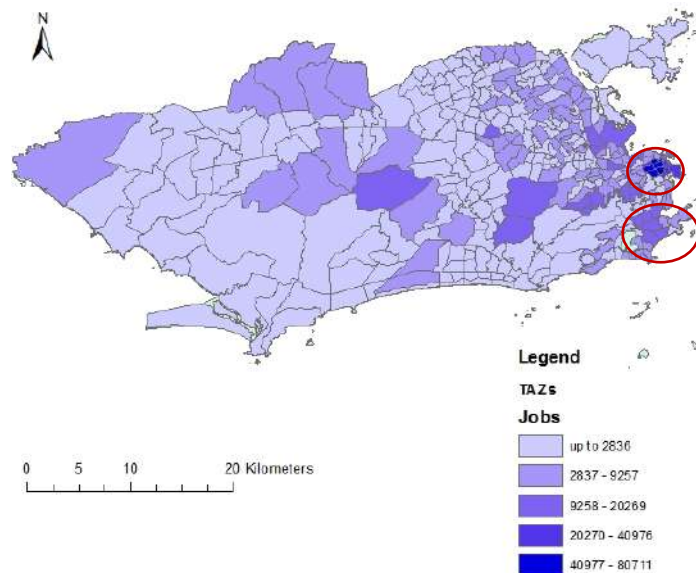

Figure 14: Distribution of job densities

Informal transport is present in Santa Cruz but not in Colegio. Apart from its large size and low density, trains and buses in Santa Cruz depart only from the central area where most of the jobs are located. As a consequence of the low residential density and the larger distance to the central area, there are no bus lines serving large parts of the neighborhood. This gap in provision of formal PT fostered the appearance of IT operators in the region. Contrarily, in Colegio population density is high and the bus network is dense enough to meet the demand for PT.

Informal transport is provided by individuals who see a business opportunity in the lack of official bus lines and offer the service. Usually the vehicle used is a van with approximately 10 to 14 places. They do not follow a formal itinerary nor have a fixed schedule with an established frequency, and do not have to obey to formal bus stops, even though they often take in passengers at bus stops. They have the freedom to pick up and drop passengers anytime, anywhere. Once they are full they do not stop to pick up passengers, only to drop them.

3.4 Data collection

Since the integration of bicycle and PT in Brazil is almost non-existent, an exploratory data collection stage was considered necessary to better understand such travel behavior (phase 1).

First, a focus group meeting was held with 4 participants that used the bicycle as access mode to PT in Santa Cruz. They were approached in a private bicycle parking facility close to the train station and bus stops when they were coming to collect their bicycle and then they were invited to join the focus group at a given date and time. For their convenience, the focus groups took place in the parking facility. These participants were currently using the bicycle as access mode to PT.

In Colegio metro users who were using the bicycle as feeder mode were approached in the parking facility of the metro operator. Since it appeared impossible to bring these people together, in-depth telephone interviews with them were held instead. For both survey techniques (focus group and in-depth interview), the same script of questions was used.

In addition, in order to incorporate other views than from multimodal bike-PT users, an expert group meeting was conducted with academics, policy makers and transport operators. In the exploratory stage the set of barriers and motivators for bicycle use in access trips to PT was established using the results of the literature review, and the outcome of this stage was used for the design of the main survey.

As one of the aims of the survey was to identify and understand the potential for bicycle use in access trips to PT, public transport users were the target group. The second phase of the data collection was to identify the PT users with the desired profile: people making trips to work or study, using the same transport mode(s) every day, for trips with origin and destination within the city of Rio de Janeiro. If these conditions were matched, the respondent was invited to take part in a longer interview to be performed by telephone at an appropriate time and date indicated by the person. This 'approach interview' was conducted at bus stops and a train station (in Santa Cruz), and in a metro station (in Colegio) in peak hours during weekdays. The data were collected using a handheld computer and each interview lasted no more than 1 minute. The use of such an electronic device is easy and efficient; it saves time in data collection and processing and minimizes errors in digitizing data.

Restricting the sample to people travelling from/to neighborhoods in the city of Rio de Janeiro has been done for practical reasons: data quality and completeness for neighboring municipalities is not as good as for the municipality of Rio de Janeiro. In addition, as mentioned in section 3.2, more than 60% of all trips in the MRRJ are made within the city, and three quarters of the trips are work/study trips. Confining the sample to intra-city work/study trips purposes resulted in a homogeneous yet sizeable and representative data set.

The use of telephone interviews may bias a sample in general, and in particular in developing countries. However, since the survey consisted of two steps, approaching people first at PT stops/stations and the same people later through telephone calls, this bias is absent. Moreover, the sample consisted of workers and students in Rio de Janeiro, who all appeared to have a telephone (mobile, at home or at work). The final question in the approach interview was about the willingness to participate in the longer telephone interview; 13% of the respondents preferred not to take part in this data collection stage.

In the third phase the telephone interview was conducted, again with the help of the handheld device, using the questionnaire designed with the outcome of the first stage. The telephone interview took some 5 to 10 minutes and the survey contained questions regarding socio-economic characteristics, modes used as well as modal preferences in multimodal trips, perceived barriers, opportunities for the bicycle as access mode, and, last but not least, information on trip locations (origin, destination, embarking and disembarking locations when changing mode). Figure 15 illustrates the various phases and linkages in the data collection process.

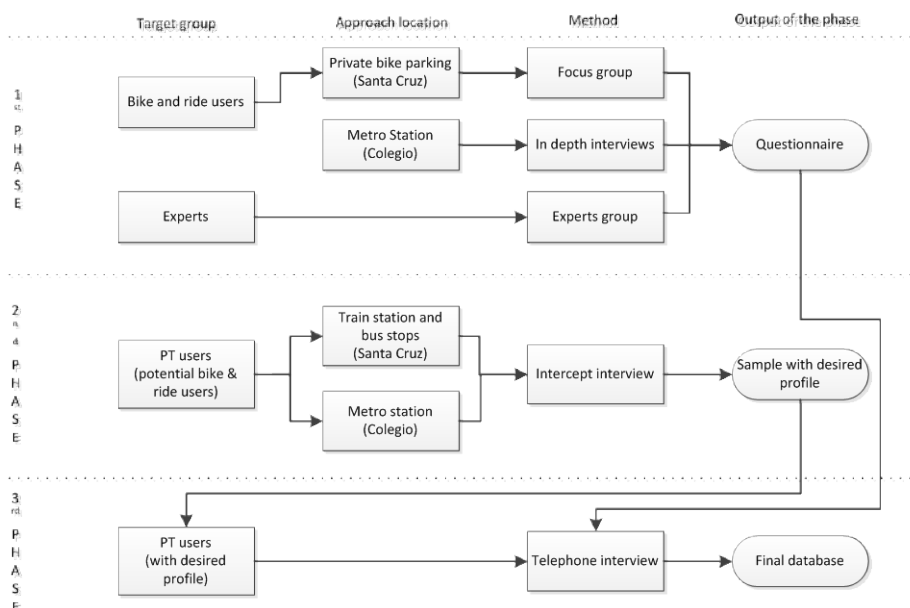

Figure 15: Data collection

The location information enables a spatial analysis, for example to determine trip distance. For this purpose, all location points (residence location, destination and PT boarding points) were geo-referenced. Therefore, the city of Rio de Janeiro was overlaid with a raster of 800m x 800m square grid cells. All location information from the questionnaire was assigned to the centroid of the corresponding cell. Cell size choice was considered appropriate, the average intra-grid cell trip distance is approximately 450m, given trip lengths and area sizes. In the analysis, trip distances are calculated between cell centroids over the transport networks.

3.4.1 Sample description

A total of 505 valid cases remained after the removal of incomplete questionnaires. And so were cases of people whose access mode choices were too few and therefore would not be of significance in the analysis (car, car passenger and bicycle). Table 2 provides an overview of the respondents' profile and some spatial characteristics of both case study areas.

Regarding socio-economic characteristics, few differences between areas can be noticed: the bicycle availability is higher in Santa Cruz, which can be explained by the scarce PT provision and better bicycle infrastructure. The share of the upper-income range in the sample appears to be higher in Colegio than in Santa Cruz, even though both areas are considered low-income.

Table 9: Descriptive statistics of the survey sample

		Neighborhood		Total (%)
		Santa Cruz (%)	Colegio (%)	
Access Mode	Informal Transport	38.1	0	27.7
	Bus	42.2	18.1	35.6
	Walk	19.6	81.9	36.6
Gender	Female	61.6	60.1	61.2
	Male	38.4	39.9	38.8
Age Range	Up to 34 years	49.3	55.8	51.1
	35 to 54 years	43.9	38.4	42.4
	Older than 55 years	6.8	5.8	6.5
Income	up to 1 MW	28.9	26.1	28.1
	1.01MW - 2 MW	45.5	31.2	41.6
	2.01 MW - 3 MW	16.3	16.7	16.4
	> 3.01 MW	9.3	26.1	13.9
Car Availability	Yes	43.6	39.1	42.4
	No	56.4	60.9	57.6
Bicycle ownership	Yes	51.0	36.2	46.9

Bicycle Availability	No	49.0	63.8	53.1
	Yes	70.3	49.3	64.6
Ride bicycle	No	29.7	50.7	35.4
	Yes	80.4	86.2	82.0
Density TAZ	Low (up to 7500h/km ²)	99.7	0.7	72.6
	Medium (7500 to 15000h/km ²)	0.3	89.1	24.7
	High (More than 15000h/km ²)	0	10.1	2.8
Access Trip Distance	up to 1km	12.9	52.2	23.7
	1.01km to 2km	15.6	35.5	21.1
	2.01km to 5km	54.8	10.9	42.7
	> 5km	16.7	1.4	12.5

*bicycle availability: if a person does not own a bicycle but has one available from family or a neighbor

**ride bicycle: is the ability of riding a bicycle

***1MW (minimum wage)=R\$510 monthly in 2010

As expected, a substantial difference in access modal split can be seen between the two case study areas. Due to the short distances, in Colegio 80% of the trips are made by walking while in Santa Cruz this percentage is only 20%. Here bus and informal transport (IT) have an almost equal share (42% and 38%, respectively). The bigger use of motorized modes in the access trips in Santa Cruz is coherent with the longer distances and the presence of IT.

Figure 16 depicts the current relation between access mode and access trip distance. Walking is most widely used for trips up to 2 km. Motorized alternatives, i.e. informal transport and bus, are dominant over distances longer than 3 km.

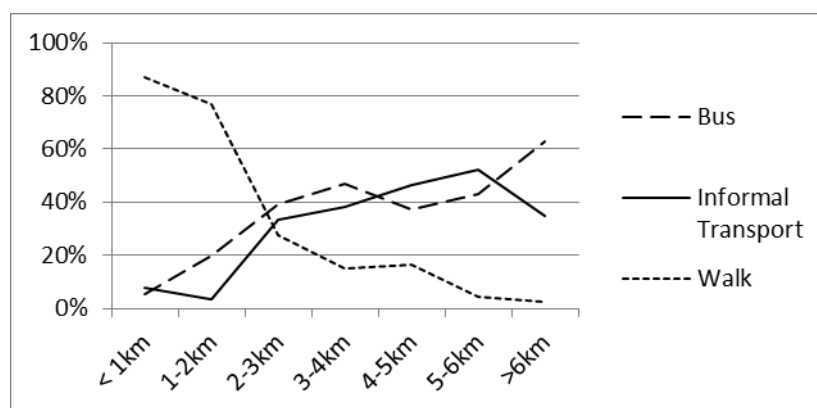

Figure 16: Access mode share per distance range

Figure 17 and Figure 18 show the distribution of trip origins (i.e. home locations of respondents) for both case study areas: in Colegio the concentration of respondents' home locations is somewhat higher than in Santa Cruz.

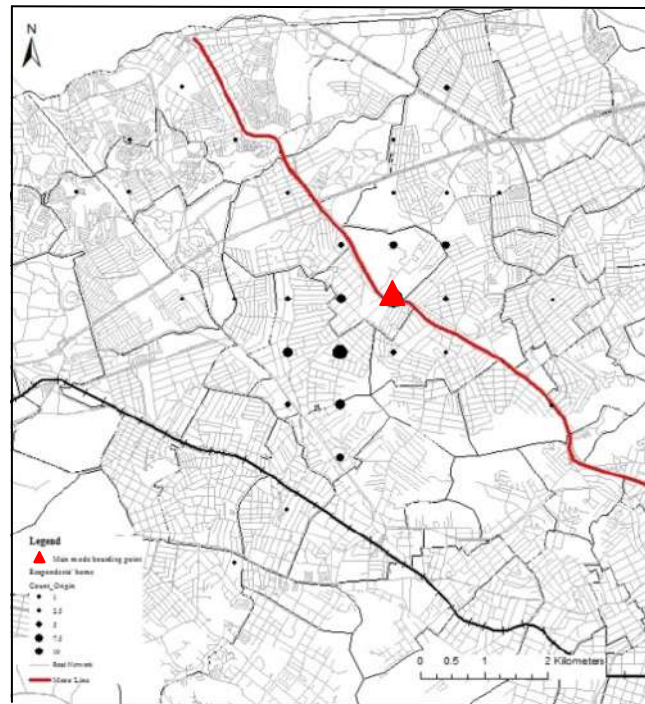

Figure 17: Distribution of trip origins in Colegio

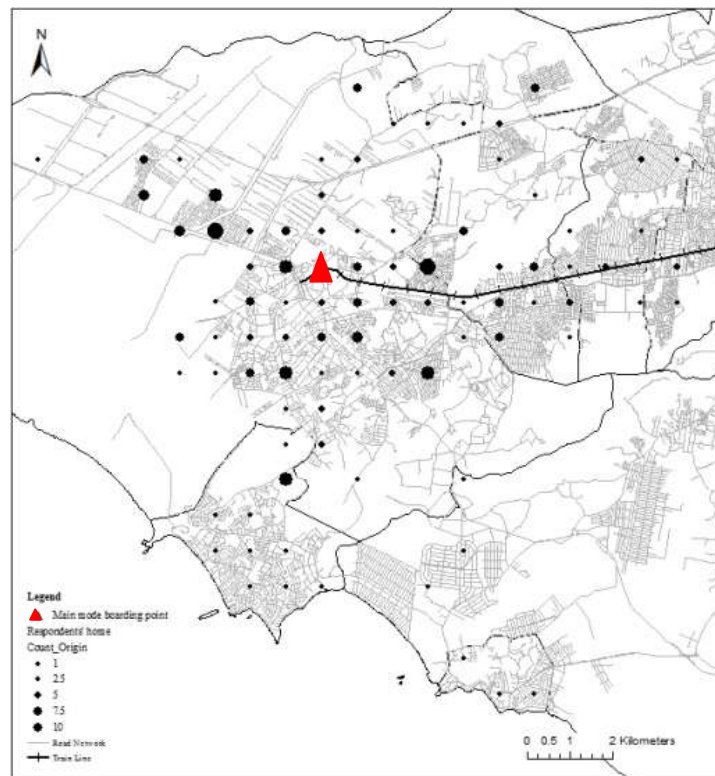

Figure 18: Distribution of trip origins in Santa Cruz

3.5 Model estimation and results

3.5.1 Sample characteristics

The access trip is the first part of a PT journey and in this study it always starts at the home location and it ends at the station/stop where the respondent boards the main mode. The objective of this study is to model the bicycle potential for access trips to PT. So the aim is to model the propensity of the respondent to use the bicycle for the access trip that currently is done by another mode.

In the analysis, logit modelling is used based on the random utility theory. This theory assumes that individuals choose the travel alternative that maximizes their utility (MCFADDEN, 1974). The random utility function can be expressed as:

$$U_{ni} = V_{ni} + \varepsilon_{ni}$$

where U_{ni} represents total utility of individual n to choose alternative i , V_{ni} is the observable part of the function and ε_{ni} a random component that contains all relevant aspects of the phenomenon that are not explicitly known by the modeler.

Two binary logit models were estimated to identify the main factors affecting the potential for cycling as access mode: the first model incorporates the main motivators for bicycle use in the access trip as reported by the respondents, and the second model in a similar way the main barriers.

The dependent variable in both models is the propensity to cycle in the access trip. The respondents were asked if they had considered bicycle use instead of the current PT access mode (when answering “yes” they are considered pro-bike and if “no” as non-bike). The reference category is the non-bike group, so the coefficients measure a change in pro-bike in relation to the non-bike category. The independent variables in the models are socio-economic, transport and spatial characteristics, as well as motivators and barriers for bike use respectively (what needs to be done for respondents to persuade them to cycle (motivators) and what prevents them from cycling now (barriers)). Table 9 presents the list of variables included in the models and their descriptions.

Table 10 List of variables

Socioeconomic variables		
Age	continuous variable	age stated by the respondent
Bicycle ownership		yes = 1; otherwise 0
Car ownership		yes = 1; otherwise 0
Gender		if female =1 if male =0
Respondents' self reported motivator for bicycle use		
Change home location	if changing the home location is the motivator factor which would potentially make user cycle to PT	yes = 1; otherwise 0
Cycleways	if the presence of cycleways is the motivator factor which would potentially make user cycle to PT	yes = 1; otherwise 0
Have a bike	if having a bicycle is the motivator factor which would potentially make user cycle to PT	yes = 1; otherwise 0
Park infrastructure	if the presence of suitable parking infrastructure is the motivator factor which would potentially make user cycle to PT	yes = 1; otherwise 0
Respondents' self reported barrier for bicycle use		
Live too close	if living too close to PT boarding point is the revealed reason why respondent does not currently cycle	yes = 1; otherwise 0
Current parking conditions	if the current parking conditions are the revealed reason why respondent does not currently cycle	yes = 1; otherwise 0
Personal constraints	if personal constraints (health conditions, feel too old, dressed up) are the revealed reason why respondent does not currently cycle	yes = 1; otherwise 0
Public safety	if public safety is the revealed reason why respondent does not currently cycle	yes = 1; otherwise 0
Transport variable		
Access mode - bus	if the bus is the current mode used for access trip	yes = 1; otherwise 0
Spatial variables		
Density	the density of the origin's TAZ	inhabitants/km ²

3.5.2 Results

The two binary logit models to estimate the propensity for bicycle use in access trips to PT were estimated using Biogeme (BIERLAIRE, 2009b). The convergence of the models was found to be satisfactory and the best fit for the motivators' model as well as the barriers' model is presented in Table 10 (adjusted rho-square of 0.232 and 0.215 respectively).

Some parameters were tested but did not appear in the final models due to statistical insignificance: neighborhood, income, ability to ride a bicycle, main mode,

self-reported barriers (live far from PT, lack of respect from drivers, not owning a bicycle, personal preferences) and self-reported motivators (knowing how to cycle and improved safety). Some other factors, such as bicycle characteristics (e.g. flexibility, free mode, health) or external factors (e.g. topography, weather) were potential answers in the questionnaire but respondents did not mention them as motivators or barriers for cycling, and therefore they were not tested in the model.

The socio-economic variables for both motivators and barriers model show that people who own a bicycle are more prone to use it in access trips, whereas car owners and women are less likely to cycle in feeder trips. As age increases, the willingness to cycle decreases. The models confirmed the higher likelihood of men and youngsters to cycle in feeder trips, as earlier reported by Dill and Voros (2008) and Stinson and Bhat (2004). The explanation might be that women feel more vulnerable and the elderly lack the energy. Car ownership decreases the propensity to cycle in access trips in Rio de Janeiro, which is comparable to findings in developed countries (MARTENS, 2004; PARKIN; WARDMAN; PAGE, 2008). The magnitude of the effect of these variables is similar in both models, with the exception of bicycle ownership, which seems to be more significant in the motivators model. Bicycle availability has a positive effect on the likelihood for cycling in access trips. It suggests a predisposition for bicycle use, showing a positive attitude towards this mode.

Population density is negatively associated with the propensity to cycle in both models with similar impacts. As population density increases, the willingness to cycle declines. It is consistent with findings in the Netherlands (Puello and Geurs, 2015), which show that the number of bicycle trips to a train station is higher in low-density areas. Access trip distance is only significant for the barriers model where it has a negative impact on the likelihood to cycle. It matches Dutch studies in which the bike is the main mode in access trips for distances between 1.2 and 3.7 km, while for longer distances PT is preferred and for shorter distances walking (Keijer and Rietveld, 2000; Rietveld, 2000b).

Unexpectedly, respondents who currently use the bus as feeder mode to PT are more likely to cycle. The expectation was that people who currently walk would be more prone to shift to the bike, as both are human-powered modes with the advantage of the bike to be faster. However, the likelihood of bus users to shift might be because they live in a “cycleable” distance range, as in the Dutch case, whereas those who walk might live too close to the PT boarding point. The self-reported barrier parameters all appear to be relevant in the barriers model. These are the most significant parameters

to explain the likelihood for cycling in access trips, and have the largest coefficient values, compared to the socio-economic, spatial and transport parameters. Living too close to the PT station/stop is the second most important factor in the model with a negative impact. It confirms again that people who live too close to PT walk and are not willing to shift to the bicycle. Only for access distances over 1 km people prefer to cycle, as found in Dutch studies (Givoni and Rietveld, 2007; Keijer and Rietveld, 2000; Puello and Geurs, 2015; Rietveld, 2000b). Contrarily, current bicycle parking conditions, personal constraints and public safety have a positive impact on the propensity to cycle in access trips. Even though they are barriers, the explanation might be that these can be overcome and that people who pointed at these barriers are more likely to cycle.

Table 11: Binary logit models of propensity to use bicycle in access trips to PT

	Motivators model			Barriers model		
	Coeff	t-test		Coeff	t-test	
Socioeconomic parameters						
Age	-0.0337	-3.48	*	-0.0399	-4.13	*
Female	-0.569	-2.47	*	-0.596	-2.61	*
Bicycle ownership	0.995	4.15	*	0.612	2.8	*
Car ownership	-0.878	-2.72	*	-0.799	-2.56	*
Motivators parameters						
Change home location	-2.98	-2.66	*			
Cycleways	1.03	3.42	*			
Have a bicycle	1.68	4.7	*			
Parking infrastructure	0.698	2.22	*			
Barriers parameters						
Live too close				-2.07	-1.96	*
Current parking conditions				0.556	1.79	**
Personal constraints				3.1	2.9	*
Public safety				1.29	3.57	*
Spatial parameters						
Access trip distance				-0.0648	-1.32	
Density	-0.00916	-4.08	*	-0.00774	-3.21	*
Transport parameter						
Bus as access mode	1.44	6.14	*	1.16	4.98	*
Constant	0.263	0.56		1.14	2.36	
Likelihood ratio test (df)	184.639 (10)			174.427 (11)		
Cte log-likelihood	-338.183			-338.183		
Final log-likelihood	-257.72			-262.826		
Adjusted rho-square	0.232			0.215		

Note: reference mode is non-bike

Number of observations = 505

* Significant at a 99% level

** Significant at a 90% level

Similarly, for the motivators' model, the self-reported motivator revealed to be the most important parameter in the logit model calibration with again the largest coefficient values.

Changing a persons' home location has the largest coefficient with a negative impact on the propensity to cycle. This finding can be understood by looking at the survey in more detail. Respondents were first asked about the barriers to cycle to the station/stop and subsequently about the motivators. Questions were formulated as: "why don't you cycle to the station/stop?" and "what could make you cycle to the station/stop?". A substantial number of respondents replied that they live too close to bike to the station/stop, as seen in the barrier model. The succeeding answer of these people to the second question is a change of home location, meaning that if they lived further away from the station/stop they might consider bicycle use. So, it means that "change home location" is a hypothetical motivator: it does not mean that people consider moving further away.

Having a bicycle is the second most significant parameter, and it suggests that owning a bike would be a strong motivator to use it in access trips. The implementation of cycle ways is another important motivator, and to a somewhat lesser extent the improvement in bicycle parking facilities.

These findings confirm the negative impact that a lack of appropriate cycling infrastructure has on revealing the potential for this transport mode as reported by studies in African countries (BECHSTEIN, 2010; NKURUNZIZA et al., 2012), in the US (Dill and Carr, 2003) and in Madrid (FERNÁNDEZ-HEREDIA; MONZÓN; JARA-DÍAZ, 2014).

The effect of the main mode (bus, train or metro) on the potential for bicycle use in access trips to PT appeared not to be relevant for bike and ride in the case study areas, which contradicts with Dutch findings (MARTENS, 2004). However, caution should be taken to draw general conclusions in this respect since only one metro station, one train station and two bus stops were included in this research.

3.6 Conclusions and recommendations

This study analyzed the propensity of current PT users to use the bicycle in access trips to PT stations/stops in two low-income areas of Rio de Janeiro, Brazil. The majority of studies that examine bicycle access trips are carried out in developed countries, predominantly access trips to train stations in the Netherlands, as this is common practice in this country. Therefore, there is a need to study the potential for

the bicycle as feeder mode to PT modes in developing countries, too, and explore the differences in mobility patterns. Moreover, it is important to incorporate behavioral factors in the analysis, in particular self-reported barriers and motivators.

The results of this paper show that socio-economic, transport and spatial characteristics, as well as the self-reported barriers and motivators are relevant to explain the propensity (or potential) of cycling in access trips to PT modes.

The need to study cyclist behavior in developing countries is justified by different behavioral patterns, when it comes to bicycle use and infrastructure. These patterns influence decision making and policy implementation. For example, the problem with perceived unsafety in Brazil is a factor that is not mentioned in developed countries, where safety is not an issue. In the Netherlands, the bicycle network is widespread. Even where bicycle lanes are shared with cars and buses, cycling is safe and respected. Conversely, in Brazil, as in other developing countries, as mentioned by Nkurunziza et al (2012) and Bechstein (2010), the lack of cycle ways prevents potential users to choose the bicycle mode as cycling in shared lanes can be too dangerous.

The results of the models show that both barriers and motivators for bicycle use in access trips are crucial factors for encouraging this access mode. The results provide an indication of the most relevant measures that would tap the potential for bicycle use in access trips. The findings show that current bicycle parking conditions and public safety are important barriers. Improving bicycle infrastructure, parking facilities and bicycle ownership appear to be the most important motivators.

The relationship between access and main mode was not significant in this research. Probably this result refers to the limitations in the number of case study areas and the limited number of stations/stops (two bus stops, one metro and one train station).

In many developing countries, as is the case in Brazil, public safety issues hinder bicycle users. However, as suggested by Heinen et al (2011), this is not an important factor in the Netherlands, where safety is quite high. The provision of safe parking contributes to reduce the safety issue. Therefore, specific actions need to be taken in order to improve safety so that people feel safe when cycling.

Improving bicycle parking facilities near metro/train stations and bus stops is a key improvement when it comes to increasing the potential for bicycle in multimodal integration. Both metro and train operators can increase ridership by providing these facilities within the station premises. Bus operators can work together with

municipalities to create bicycle parking facilities in the vicinity of bus stops to stimulate bike and bus integration.

Bicycle infrastructure appears to be an important motivator in the model. The presence of bicycle lanes in Rio de Janeiro would encourage people to use the bicycle. The municipality should invest in building new bicycle infrastructure, in particular in areas with a high potential for bike-PT integration.

Having a bicycle seemed to be an important motivator too and therefore bicycle ownership should be encouraged. To achieve this, a combination of policy measures could help. For example, a shared bicycle scheme is already in operation in the city of Rio de Janeiro, but it covers only the South Zone and the central area of the city. This service could be expanded to other areas of the city, e.g. one of the case study areas in the West zone where the highest rate of bicycle use in the city is recorded.

An alternative to increase bicycle ownership amongst commuters would be to encourage employers to stimulate bicycle use by their employees in trips to work. This could be done by creating a program to facilitate and subsidize the purchase of a bike by employees. On the other hand, the government could offer tax discounts for companies that encourage bicycle use in commuting trips. Currently companies bear the costs of PT of their employees in Brazil and in many cases it would be cheaper to subsidize the one-time cost of a bicycle rather than monthly paying the cost of transport.

To investigate differences in bicycle potential in access trips to different main modes (metro, bus and train), further research is needed by incorporating multiple metro/train stations and bus stops in a much wider area in the city. In this research work/school trips have been considered, which leaves open whether differences exist in motivators and barriers for other trip purposes when it comes to bicycle use in access trips to PT.

Finally, this research is a first exploration of the topic in this context, and future research could incorporate other psychological indicators to gain a deeper understanding of the perceptions and attitudes of current PT users towards the potential for bicycle use in integration with PT.

4 USING GIS TO VISUALIZE SPATIAL PATTERNS IN ACCESS MODE CHOICE AND THE POTENTIAL FOR BICYCLE IN ACCESS TRIPS IN RIO DE JANEIRO

Increasing congestion, low air quality, decreasing quality of life and time loss are, among others, consequences of the intensive use of car for personal mobility. (CHEN et al., 2011; GROTENHUIS; WIEGMANS; RIETVELD, 2007; VAN EXEL; RIETVELD, 2009). Concerns about environmental quality, climate change, social equity and economic growth have all urged discussions on sustainable development. The need of transport alternatives which are more socially, economically and environmentally sustainable become urgent.

Public transport (PT) is unquestionable a sustainable transport alternative and many authors have acknowledged the increase in the share of PT as a sound strategy towards sustainability (DIANA; MOKHTARIAN, 2009; GROTENHUIS; WIEGMANS; RIETVELD, 2007; HENSHER, 2007; JIANG; CHRISTOPHER ZEGRAS; MEHNDIRATTA, 2012; KENNEDY, 2002; KRYGSMAN; DJIST; ARENTZE, 2004; MURRAY et al., 1998). An efficient public transport service is crucial not only to provide an option for those willing to shift from cars but also to guarantee a transport alternative for those who do not own a private vehicle (Murray et al 1998). However, despite being widely considered a sustainable alternative, PT still is mainly used by captive users in developing countries, i.e. individuals who have no other transport alternative, and it is regarded as a slow option when the whole journey is considered (BRUSSEL; ZUIDGEEST; DE SOUZA, 2011).

When it comes to increase PT patronage and improved PT journeys, studies suggested the importance of also considering the access trip to station/stop. Brons et al (2009) indicate possible measures to increase PT use such as: to wider the catchment area by increasing geographical coverage of access services, to decrease travel times to stations and finally to improve quality of service to and from stations. In a research over the role of access trips to train service in overall user's satisfaction, Givoni & Rietveld (2007) conclude that accessibility to train station will determine if the train will be used or not and the access and egress trips to/from trains stations are an important part of the rail trip and therefore must also be accounted for in order to increase rail use. Krygsman et al (2004) state that "much of the effort associated with public transport trips is performed to simply reach the system and the final destination". It is clear that access trips are a crucial part of the whole PT experience and effortless and smooth alternatives improve the overall PT experience increasing transit ridership.

Access trips to train stations in The Netherlands were the object of study in many works each having a different approach. Studies looked at the spatial aspect of access trips (KEIJER; RIETVELD, 2000), the influence of access trips on the potential for increasing rail use (BRONS; GIVONI; RIETVELD, 2009), the role of access journey to the railway station in passengers' satisfaction with rail travel (GIVONI; RIETVELD, 2007a), the joint access mode and railway station choice (DEBREZION; PELS; RIETVELD, 2009). Hale (2013) identified and compared notable station access attribute in stations in cities in four continents. In other work Hale (2011) examined station access planning as an important component to make an efficient PT system. The access trips to the bus network in Northern Ireland (WU; HINE, 2003), to train or light rail in the US (KIM; ULFARSSON; TODDHENNESSY, 2007) and walking trips to BRT in China (JIANG; CHRISTOPHER ZEGRAS; MEHNDIRATTA, 2012) were also objects of studies. A common conclusion to many of these studies (BRONS; GIVONI; RIETVELD, 2009; GIVONI; RIETVELD, 2007a; HALE, 2013; KEIJER; RIETVELD, 2000) is access to transit has a great impact on the satisfaction and ridership of the main mode, in all the cases the train and therefore needs to be well taken into account in transport planning .

Considering the undeniable sustainable nature of the bicycle and its potential to replace motorized trips in access trips, many researches have been conducted examining different aspects of bicycle trips to PT. Some works included latent variables to when analyzing cycling as access mode to train stations in The Netherlands (PUELLO; GEURS, 2015), explored the bicycle as access mode to bus service in India (ADVANI; TIWARI, 2006b), investigated the role of bicycles in the accessibility to train stations in The Netherlands (RIETVELD, 2000a), examined the determinants of walking and cycling trips to rail stations in the US (PARK; KANG; CHOI, 2014).

Only in recent years more subjective elements such as attitude, perceptions and lifestyles have been incorporated in the studies in this field (SCHEINER, 2010). Kim et al (2007) concluded that PT riders are not homogeneous and indicate a better understanding of users profile and behavior cannot only enhance policy recommendations but also increase PT use. For policy makers and urban/transport planners as well as for the transport operators, one of the most important aspects of individuals' trips is then to understand the factors influencing a particular trip. This is also valid for access trips.

The unobserved factors affecting travel behavior have been increasingly incorporated into a variety of transport studies such as the effect of perceptions and

attitudes on the access trip to train stations (PUELLO; GEURS, 2015), the impact of latent variables as well as built environment and different geographical scales on travel behavior (LA PAIX PUELLO, 2012), the improvement achieved by using hybrid choice models over traditional models (YÁÑEZ; RAVEAU; ORTÚZAR, 2010), the effect of people's attitudes and personality on mode choice (JOHANSSON; HELDT; JOHANSSON, 2006), the comparison of the residents' perceptions of walkability in different neighborhoods (LESLIE et al., 2005) and the extended discrete choice models which incorporates latent variables amongst other factors (WALKER, 2001). By looking at subjective factors, such as preferences and attitudes towards transport, it is possible to understand a part of mode choice that is not influenced only by built environment or transport and trip characteristics.

The spatial aspect is also a core component of the transport phenomenon and GIS (geographic information system) has been largely used to incorporate the spatial pattern into transportation studies. Some studies use GIS to examine travel behavior in the household level (BULIUNG; KANAROGLOU, 2006), the travel pattern of the working women poor (ROGALSKY, 2010), student travel behavior (KAMRUZZAMAN et al., 2011) and the changes in commuting patterns along the years (LI; CORCORAN; BURKE, 2012). The spatial aspect has also been incorporated in studies which focus on the assessment of the quality of bicycle facilities (RYBARCZYK; WU, 2010) , the inclusion of cyclists' views on planning cycle network (ZIARI; KHABIRI, 2010) and on mapping potential measure to increase bicycle and walking levels (RYBARCZYK; GALLAGHER, 2014).

Many studies have investigated the factors affecting access mode choice from distinct perspectives and with different focus and under different contexts. Even though understanding access mode choices and the potential for cycling in access trips are of extremely importance, there is still a lack of knowledge on the spatial location of both phenomena. Knowing the spatial distribution by access mode and the attributes of choices of those modes per location as well as how do people perceive the use of bicycle in access trips and the motivators and barriers for this mode are crucial. Especially in developing countries where financial resources are often limited, prioritizing investments in areas where the results will benefit a larger population is key. By presenting a spatial analysis of the factors affecting the access modes' choice as well as of the motivators and barriers for the use of the bicycle in access trips this chapter aims to bridge this gap in the literature.

4.1 Methodology

This chapter presents the results from a survey conducted with PT users in two neighborhoods of Rio de Janeiro, Brazil, in 2009/2010. The survey consisted of questions regarding socioeconomic characteristics of respondents, the transport modes used in their commuting multimodal trips, information on the boarding and alighting points of each mode of transport used in the chain and also self-reported attributes of choice of each individual part of the trip. In addition, there were questions about the reason why respondents were not using the bicycle in the access trip to PT (barriers for bicycle) and what could be done for them to start using the bicycle in those trips (motivators). The more detailed description of the data collection process can be found in chapters 2 and 3.

Respondents were asked to describe their home-to-work trip in detail, including each transport mode used and the location of boarding and alighting of each mode. The key information is the home location and this was captured in the questionnaire, as well as the main mode boarding point location, so that the access trip could be tracked.

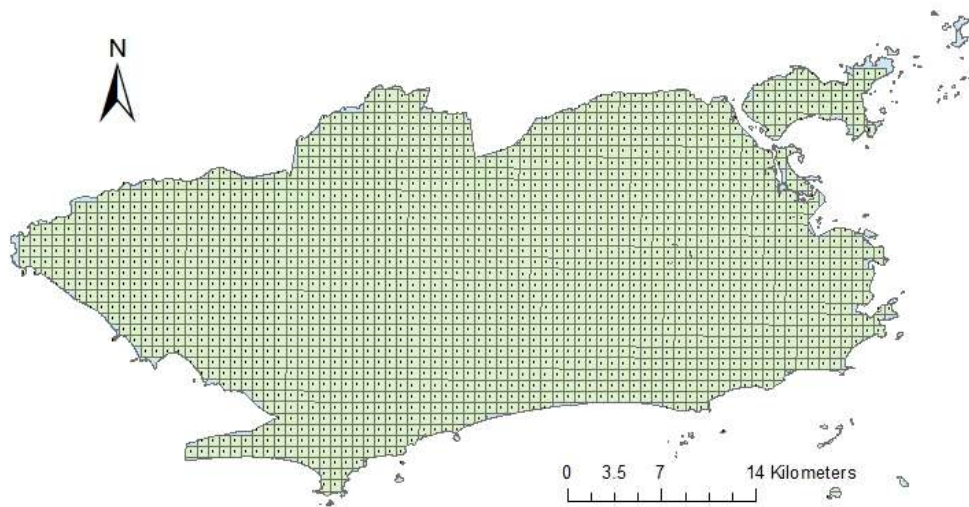

Figure 19: Representation of grid cells and centroids

The city of Rio de Janeiro was next divided in grid cells of 800m x 800m, as seen in Figure 19. Each grid cell has a centroid. The centroids are populated of the information regarding each individual living in the given grid cell. This setup allows the identification of possible spatial patterns in a smaller scale than a neighborhood, for instance.

4.1.1 Overview: Rio de Janeiro

The city of Rio de Janeiro has approximately 6 million inhabitants, and a 52 inhabitant/ha average density, though significant differences can be found, with the highest density found in Rocinha (447 inhab/ha) and the lowest in Guaratiba (8,5 inhab/ha) (INSITUTO PEREIRA PASSOS, 2006).

The railway system in the city of Rio de Janeiro is composed by 57km of metro railways (divided in 3 lines, with 41 stations), and 150km of urban trains (divided in 5 corridors with 71 stations). Regarding the road network, 3.357km of roads connect different areas of the city, and 2.420km out of this total accommodate public transport. The PT network in the city of Rio de Janeiro is illustrated in Figure 14.

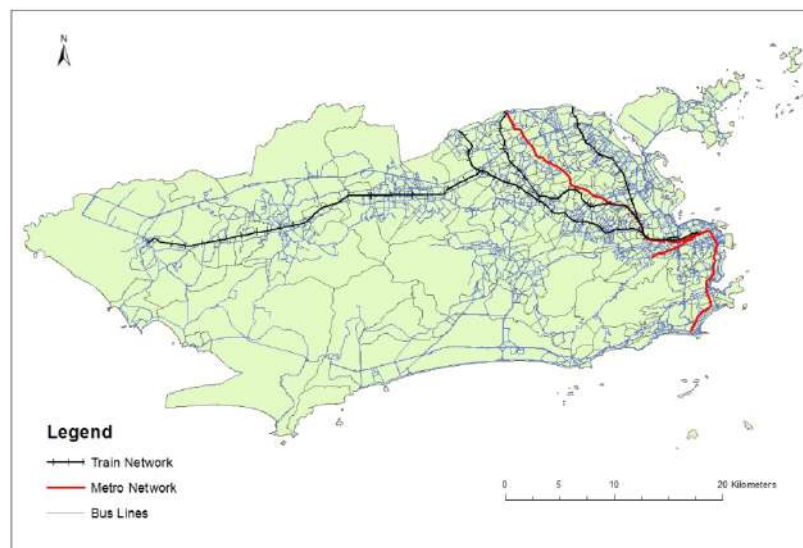

Figure 20: PT network in the city of Rio de Janeiro

According to an Origin Destination (OD) survey conducted in 2013 (SETRANS/RJ, 2014), approximately 22 million trips are made per day in the Metropolitan Region of Rio de Janeiro. From all these trips, 63% are made by motorized modes whereas the remaining fraction is made by non-motorized modes. The modal split indicates a higher share of PT among the motorized modes and a concentration of walk trips among the non-motorized modes. The PT share is divided among the different public modes, with a strong dominance of urban bus followed by informal transport. Metro, train and other modes (tram, boat and charter transport) play a minor role

4.1.2 Overview: case study areas

The data collection for the present study took place in two neighborhoods in the city of Rio de Janeiro: Santa Cruz and Colegio. The choice of these particular areas

was made to ensure the variability of both built environment and socioeconomic characteristics, which at the same time, lead to different behavioral patterns. Figure 15a depicts the location of both data collection neighborhoods, whereas Figure 15b provides an overview of the concentration of job positions across the city and the main areas are highlighted by the red circles. The two circles highlight the central area (smaller circle) and the South Zone, whereas the area of Barra da Tijuca is highlighted by the ellipse.

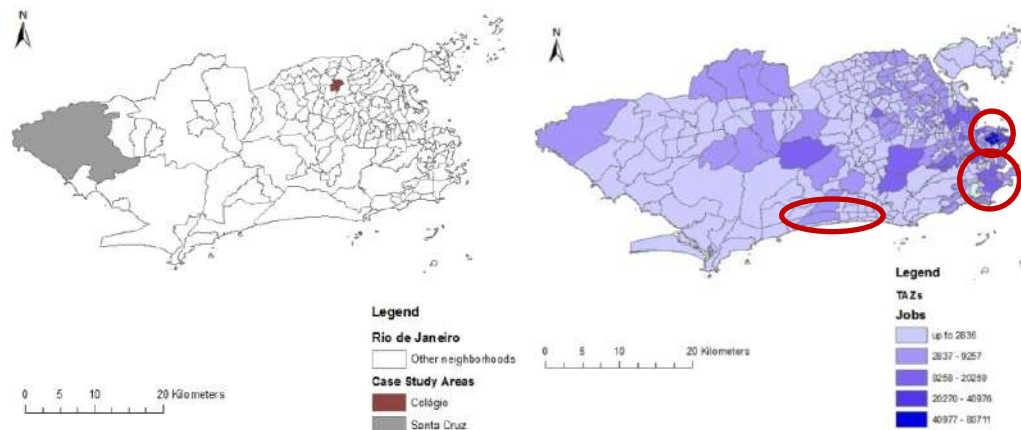

Figure 21: Study Cases location (a) and concentration of job positions (b)

Figure 16 illustrates the spatial distribution of respondent's home location (origin). From these images is possible to notice the catchment area of Santa Cruz's PT data collection point is significantly broader than the one in Colegio. In Table 11, the access distance distribution also shows that in Colegio access trips are substantially shorter than in Santa Cruz, where for example 15% of the access trips are longer than 5 km whereas in Colegio this share is of 1.4%.

Both neighbourhoods are low income areas, with average monthly income lower than the city average (R\$1,996), even though Santa Cruz (R\$941) has an average income slightly lower than Colegio (R\$1037) (Armazem dos Dados, 2014). Despite both being low income areas, these neighborhoods differ in many other aspects.

Colegio is located in the northern part of the city and it is closer to the main job location, as compared to Santa Cruz, as shown in Figure 15. Colegio has an area of 226ha and a density of 129 inh/ha, i.e. it has a high density and a small area. This neighborhood is served by a metro station and also by bus lines. The fact Colegio is a small neighborhood with a high density the short access trips to PT as shown in Table 11. Colegio and the surrounding neighborhoods are partly hilly and partly flat and there

is not much of bicycle infrastructure available, neither cycle lanes nor dedicated parking spaces, even though there are few bicycle parking spots inside the metro station, provided by the metro operator.

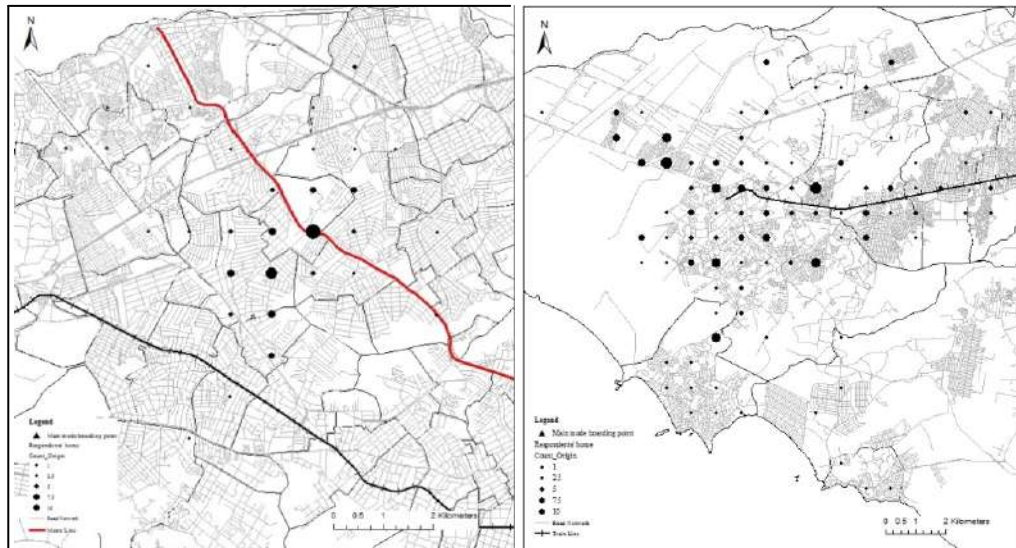

Figure 22: Distribution of origins in Colegio (a) and in Santa Cruz (b)

Santa Cruz, on the other hand, is located in the western part of Rio de Janeiro and it is the second biggest neighborhood of the city, with an area of 12,504ha and its density is one of the lowest in the city: 17inh/ha, which justifies the higher average access trip distance also seen in Table 11. The Santa Cruz train station is the final station of the train line, attracting passengers also from adjacent neighborhoods. Apart from the train, Santa Cruz is served by buses and informal transport (IT). Since this area is quite flat and due to the low density and scarce PT transport service, this is the area with the highest percentage of bicycle usage in the whole city. For this reason, there are some cycle lanes and parking facilities available for bicycle users. The concentration of parking spaces is in the center of Santa Cruz, in the vicinities of the train station.

The presence of informal transport in Santa Cruz but not in Colegio can be justified by the combination of the low density, large area and scarce formal PT provision, which fostered the appearance of IT operators in the region. Contrarily, in Colegio the density is high and the bus network is dense enough to meet the demand for PT. The origin of the informal transport service was in individuals who saw a business opportunity in the lack of official bus lines and offer the service. They usually use vans with approximately 10 to 14 places. They do not follow a formal itinerary and they do not have to obey to formal stops, but often they do pick passengers in bus

stops, they also have the freedom to stop to pick up and drop passengers anytime, anywhere. In addition, they do not have a fixed schedule with an established frequency. Once they are full they do not stop to pick up passengers, only to drop them.

Table 12: Sample's descriptive statistics

		Neighborhood		Total (%)
		Santa Cruz (%)	Colegio (%)	
Access Mode	Informal Transport	38.1	0	27.7
	Bus	42.2	18.1	35.6
	Walk	19.6	81.9	36.6
Gender	Female	61.6	60.1	61.2
	Male	38.4	39.9	38.8
Age Range	Up to 34 years	49.3	55.8	51.1
	35 to 54 years	43.9	38.4	42.4
	Older than 55 years	6.8	5.8	6.5
Income	up to 1 MW	28.9	26.1	28.1
	1.01MW - 2 MW	45.5	31.2	41.6
	2.01 MW - 3 MW	16.3	16.7	16.4
	> 3.01 MW	9.3	26.1	13.9
Car Availability	Yes	43.6	39.1	42.4
	No	56.4	60.9	57.6
Bicycle ownership	Yes	51.0	36.2	46.9
	No	49.0	63.8	53.1
Bicycle Availability	Yes	70.3	49.3	64.6
	No	29.7	50.7	35.4
Ride bicycle	Yes	80.4	86.2	82.0
	No	19.6	13.8	18.0
Density TAZ	Low (up to 7500h/km2)	99.7	0.7	72.6
	Medium (7500 to 15000h/km2)	0.3	89.1	24.7
	High (More than 15000h/km2)	0	10.1	2.8
Access Trip Distance	up to 1km	12.9	52.2	23.7
	1.01km to 2km	15.6	35.5	21.1
	2.01km to 5km	54.8	10.9	42.7
	> 5km	16.7	1.4	12.5

4.2 Data analysis

The aim of this chapter is to provide a spatial analysis of the factors affecting access mode choice and the motivators and barriers for the use bicycle in those trips. Therefore, in chapter 2 a MNL model of access mode choice was presented and the

output was the main attributes for access mode choice. In chapter 3 two BL models were presented and the outcome were the main barriers and motivators for cycling in access trips. A framework of the data analysis of the present chapter is shown in Figure 23. The scope of the present study is defined by the dashed line.

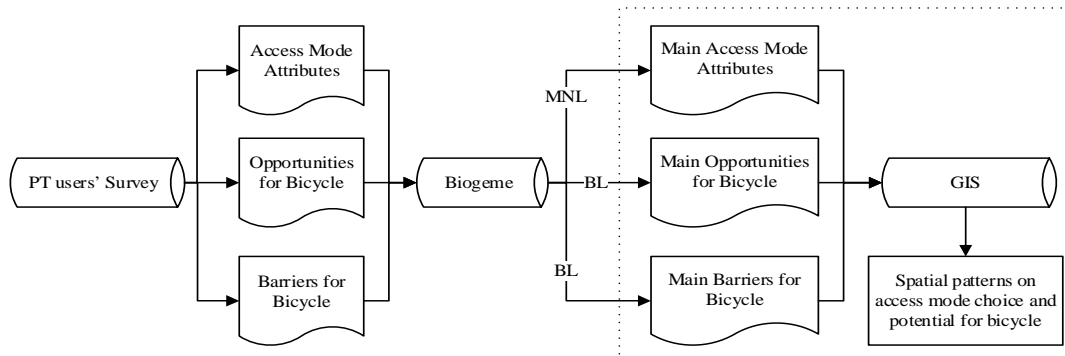

Figure 23: Data analysis framework

A summary of the outcomes of chapters 2 and 3 are presented in Table 13.. These are, the factors shown to be the most relevant in those previous chapters and will be here analyzed including the spatial component, as seen in Figure 23.

Table 13: Variables overview and definition

Socioeconomic variables		
Age ^{1, 2, 3}	in the survey form the age of the respondent was asked, but for the model the age variable was separated into discrete categories and each category was transformed into dummy variables	<24 years: yes = 1; otherwise 0 25 to 34 years: yes = 1; otherwise 0 35 to 44 years: yes = 1; otherwise 0 >45 years: yes = 1; otherwise 0
Bicycle ownership ^{2,3}		yes = 1; otherwise 0
Car ownership ^{2,3}		yes = 1; otherwise 0
Gender ^{1, 2, 3}		if female =1 if male =0
Users' perceptions towards access mode choice		
Proximity from home (closehome) ¹	if the proximity from home is the reason revealed by the respondent for having choosing a certain mode.	yes = 1; otherwise 0
Captivity (onlyoption) ¹	if the reason why the respondent used the mode is because it is perceived as the only option available for the trip	yes = 1; otherwise 0
Cost (price) ¹	if the cost of the chosen mode is the reason revealed by the respondent for having choosing a certain mode	yes = 1; otherwise 0
Travel Time (travel time) ¹	if the reason why the respondent used the mode is because it is perceived as fastest option for the	yes = 1; otherwise 0

trip

Frequency	if frequency cost of the chosen mode is the reason revealed by the respondent for having choosing a certain mode	yes = 1; otherwise 0
Respondents' self reported motivator for bicycle use		
Change home location (chanhhomeOB) ²	if changing the home location is the motivator factor which would potentially make user cycle to PT	yes = 1; otherwise 0
Cycleways (cyclewaysOB) ²	if the presence of cycleways is the motivator factor which would potentially make user cycle to PT	yes = 1; otherwise 0
Have a bike (havebike) ²	if having a bicycle is the motivator factor which would potentially make user cycle to PT	yes = 1; otherwise 0
Park infrastructure (parkinfra) ²	if the presence of suitable parking infrastructure is the motivator factor which would potentially make user cycle to PT	yes = 1; otherwise 0
Respondents' self reported barrier for bicycle use		
Live too close (liveclose) ³	if living too close to PT boarding point is the revealed reason why respondent does not currently cycle	yes = 1; otherwise 0
Current parking conditions (parkcond) ³	if the current parking conditions are the revealed reason why respondent does not currently cycle	yes = 1; otherwise 0
Personal constraints (persconstr) ³	if personal constraints (health conditions, feel too old, dressed up) are the revealed reason why respondent does not currently cycle	yes = 1; otherwise 0
Public safety (publsunsafe) ³	if public safety is the revealed reason why respondent does not currently cycle	yes = 1; otherwise 0
Transport supply variable		
Availability of alternative access mode ¹	if this trip could have been made by another transport alternative	yes = 1; otherwise 0
Access mode - bus ^{2,3}	if the bus is the current mode used for access trip	yes = 1; otherwise 0
Spatial variables		
Access trip distance ^{1,3}	the network distance of the access trip (i.e. from home to the main mode boarding point (bus stop, metro or train station)	distance in km
Density ^{1,2,3}	the density of the origin's TAZ	inhabitants/km ²

1: relevant factor for access mode choice model

2: relevant factor for motivators for bicycle as access mode model

3: relevant factor for barriers for bicycle as access mode model

*as continuous variable

4.3 Spatial analysis

4.3.1 Spatial patterns in access mode travel behavior

Understanding how people choose access mode and what are the factors affecting the potential for bicycle in those trips are relevant to improve the access to stations/stops. However, knowing where the bottlenecks are for certain modes and being able to prioritize investments regarding areas and impacts can be even more valuable for urban planners and transport operators.

Distance plays a decisive role in access mode choice. The catchment area of Santa Cruz station is significantly broader than in Colegio, as showed in Figure 24. As previously mentioned, density in Colegio is higher than in Santa Cruz and in addition, the distance between metro stations is smaller than between train stations. The fact that the Santa Cruz train station is the final station it is also determinant. Individuals prefer to travel a longer access trip in order to go to the final station so they can have more chance to sit during their train journey. Furthermore, there are bus lines which departs only from Santa Cruz towards the area of Barra da Tijuca (marked by an ellipsis in Figure 21b), which means that people from the surroundings of Santa Cruz need to board there to reach this area.

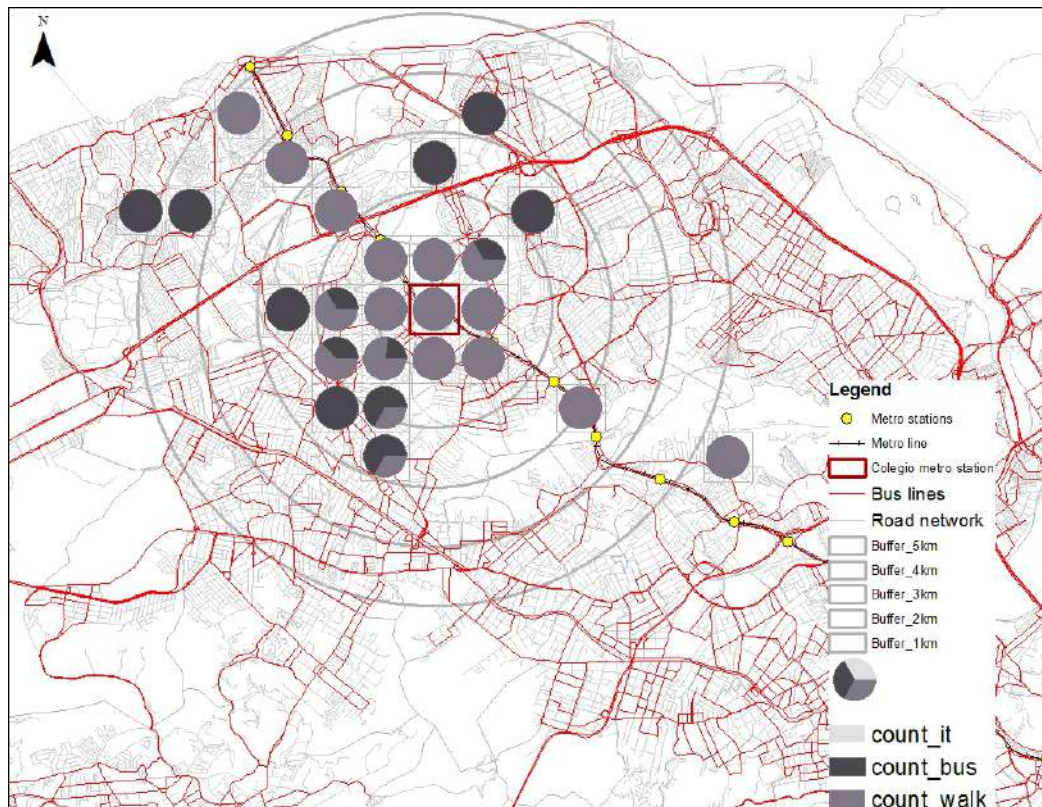

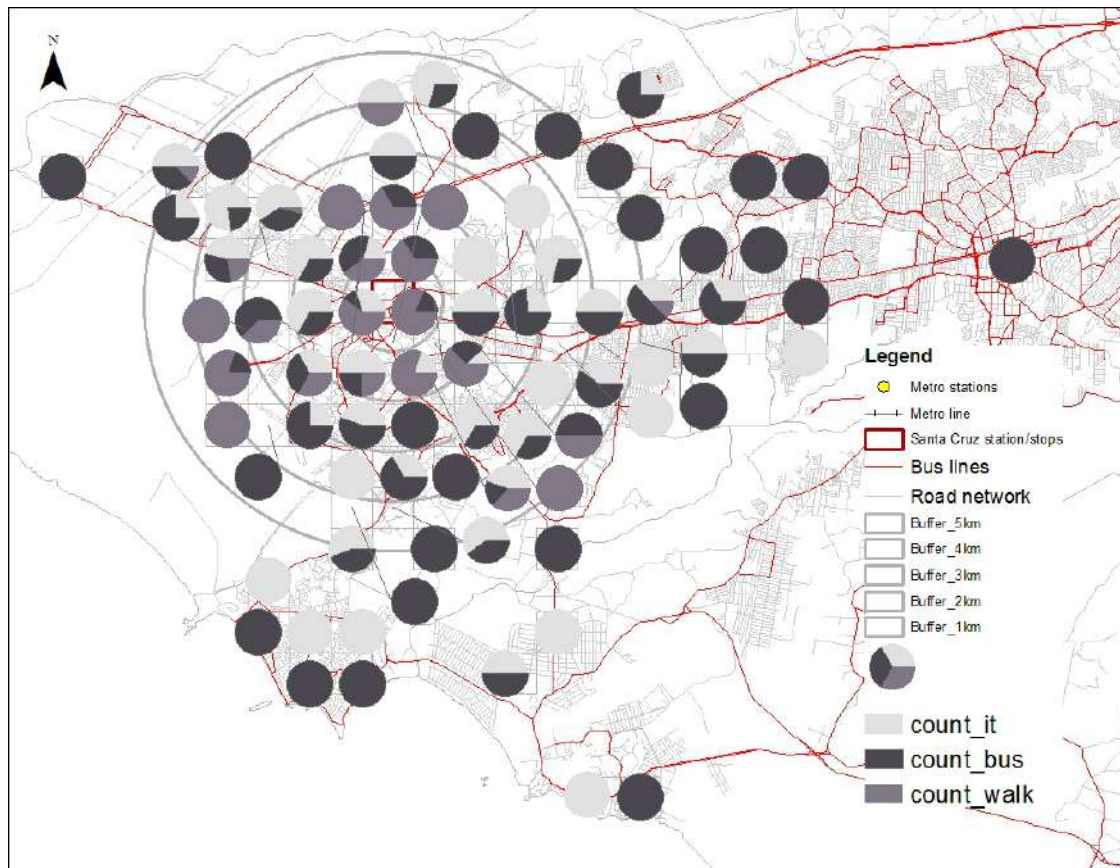

Figure 24: Access mode share in Colegio (a) and Santa Cruz (b)

Walking trips in Colegio are concentrated in a radius of 2km from the station and the further from the station, the higher the share of bus trips. The walking distance in Santa Cruz is longer as compared to Colegio, there are people walking up to 5 km. Motorized trips are the longest. Informal transport is present only in Santa Cruz, and it is possible to identify areas where IT is predominant. Bus is used in both locations.

The main attributes of choice associated to IT as access mode are travel time and frequency, which are closely related. Especially further southern from the station, where distance is longer, these attributes play a significant role (Figure 25). Captivity is also a relevant factor when choosing IT. Figure 26 shows three main areas (highlighted in grey) where PT users indicate that IT is their only alternative. Even though bus lines are present in the vicinities, still users do not perceive them as an option. This can be due to the fact that IT is more flexible and can go in lower hierarchy roads, whereas busses have fixed itineraries and usually are confined to main roads.

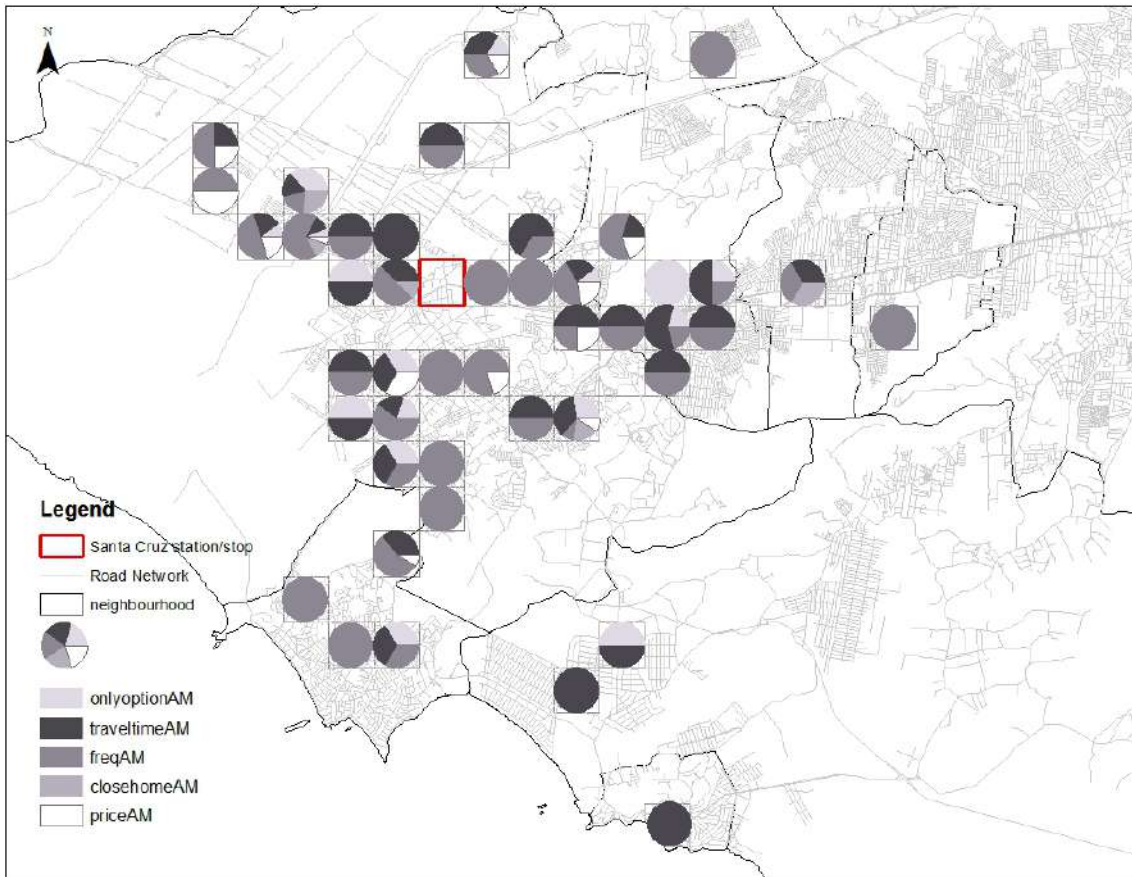

Figure 25: Spatial distribution of IT choice attributes in Santa Cruz

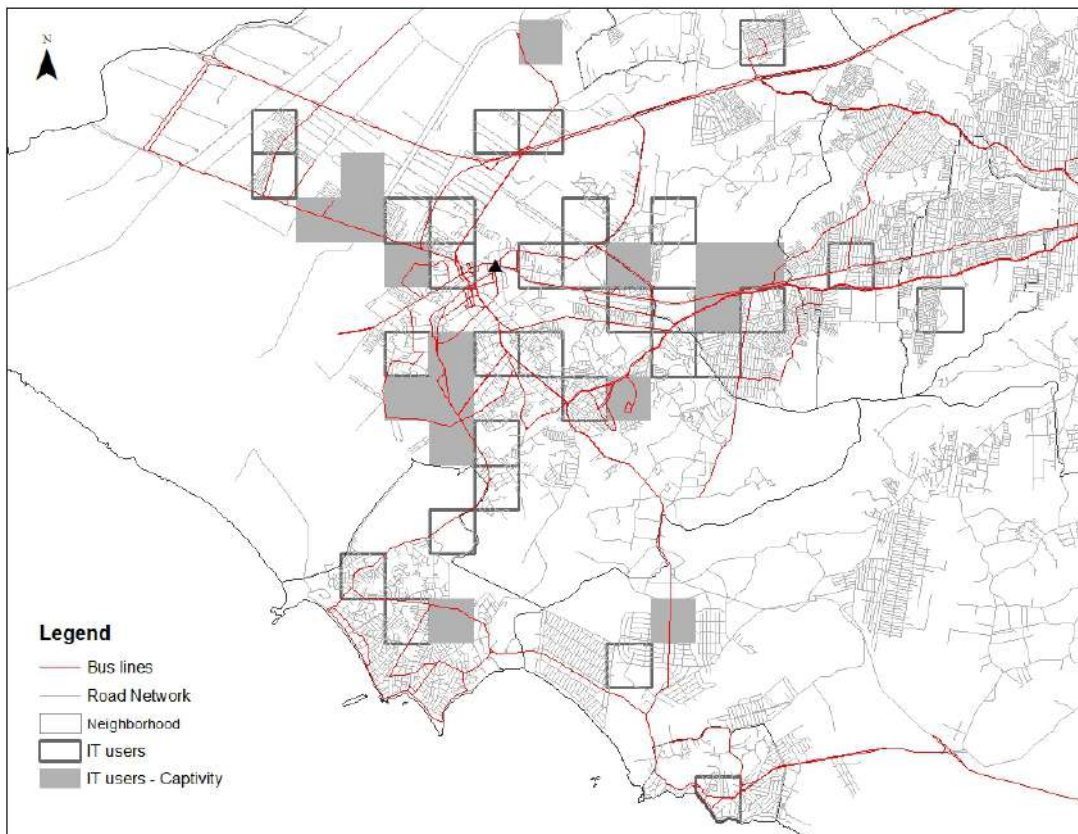
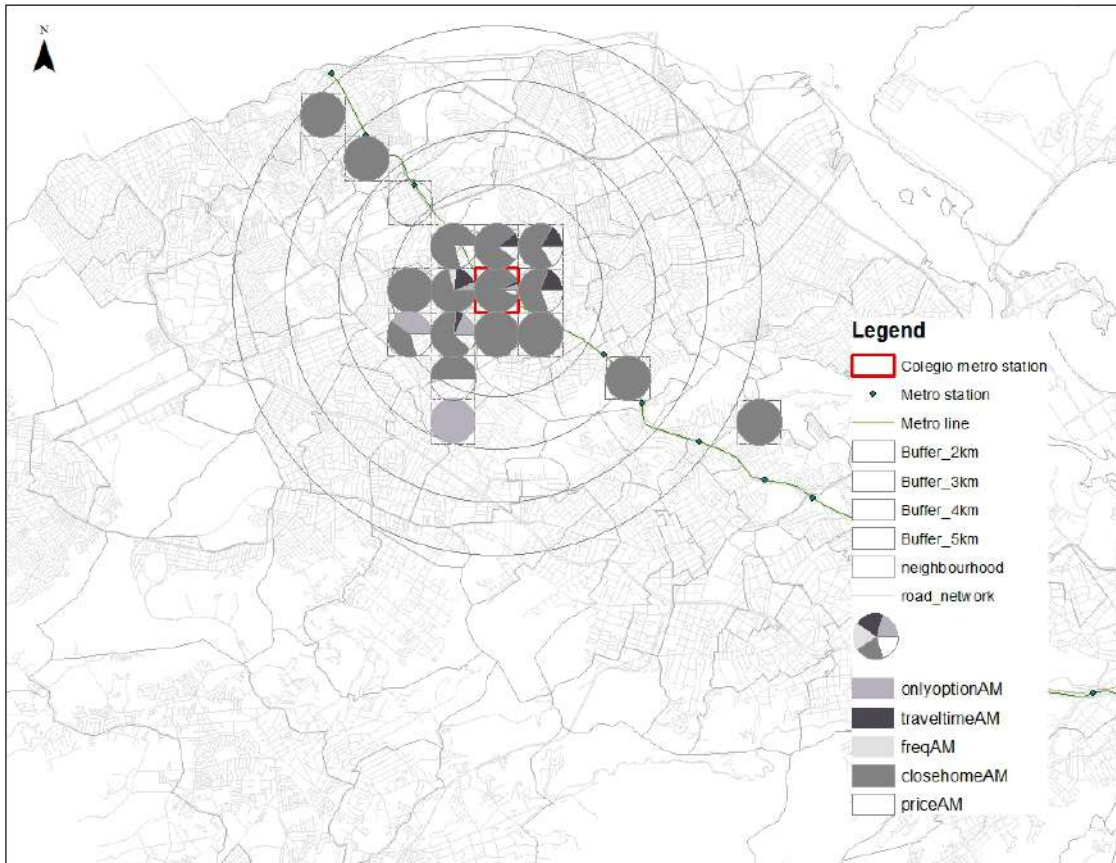

Figure 26: Spatial location of captive IT users in Santa Cruz

Proximity and cost are the main factors influencing walking as access mode (Figure 27a/b). Comparing across locations cost plays a bigger role in Santa Cruz than in Colegio. As mentioned before, the average income in Santa Cruz is lower than in Colegio, and this can explain the importance of cost in this location. Additionally, the practice of walking to in order to save money of the PT fare is common in the city of Rio de Janeiro, as revealed by a survey conducted by a transport operator in the city (FETRANSPOR, 2004).



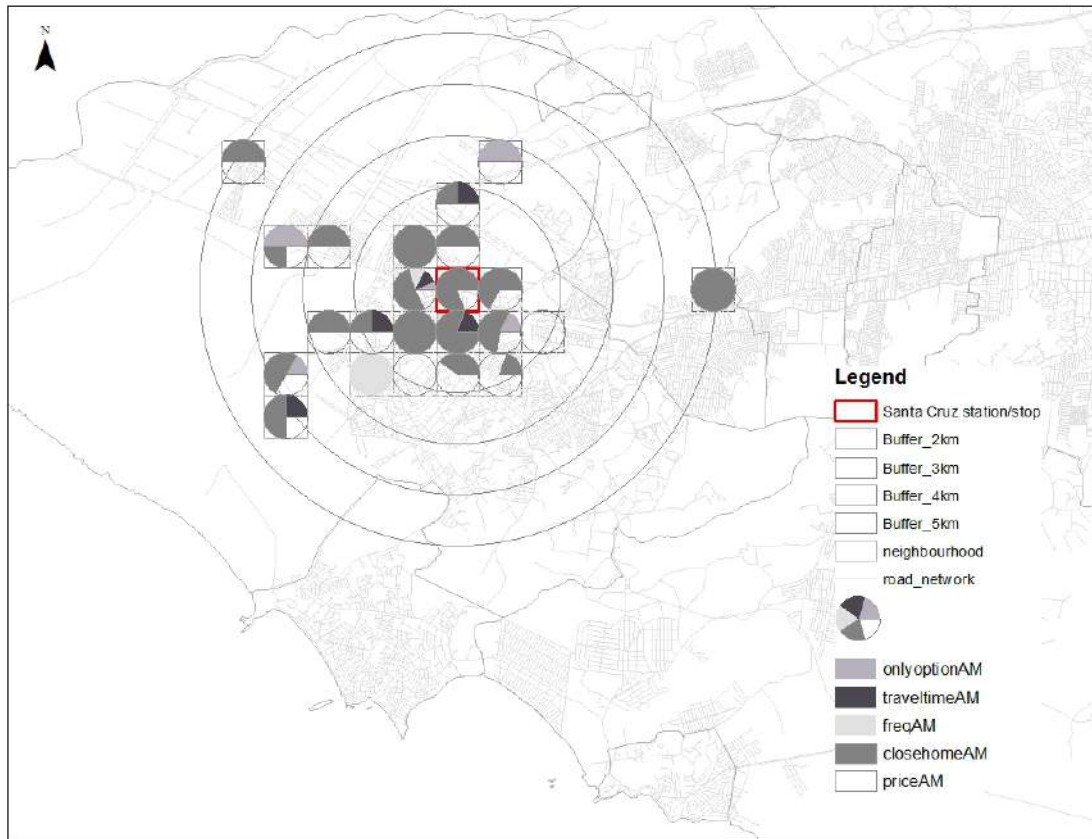
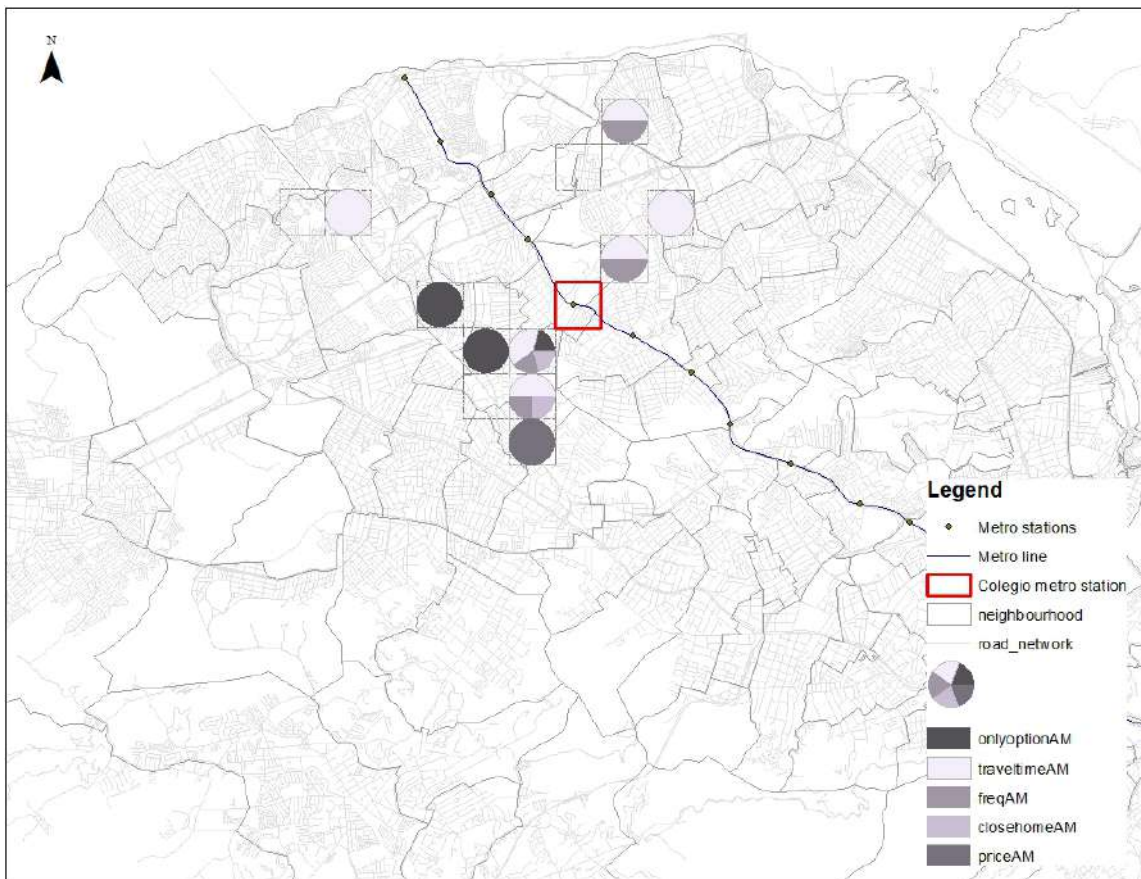

Figure 27: Spatial distribution of walking attributes of choice in Colegio (a) and in Santa Cruz (b)

In Santa Cruz it is possible to notice that the “proximity” attribute for walking trips is concentrated in the surroundings of the station, as expected (Figure 27b). However, it is surprising to detect that this attribute is also present in areas further from the stations. This highlights that “close” and “far” are relative concepts and can be perceived differently by individuals. The buffers below show that in Santa Cruz people walk up to 5km and they still consider it “close to home”. In Colegio people consider close to home with 2km distance (Figure 27b). Those grids out of the 2km buffer actually mean that individuals actually walk to the closer metro station (and not to Colegio station) from their home. It is a common practice for people living nearby stations which are close to the final station of a metro (or train) line to actually travel in the opposite direction (towards the beginning station) so that they can get a seat for the whole trip to the central area, as metro cars get extremely full in peak hours. Colegio is one of the stations use to “change directions”. In general the metro departs already from the first station with all seats taken for this reason.

Figure 28 depicts the distribution of attributes of bus choice per grid cell. Travel time and frequency are the most important attributes for bus users. Those attributes are closely related as both can be perceived as a time element. Figure 29 illustrates the

share of “frequency” attribute per grid cell, and the importance of this attribute is higher as further it gets from the boarding point (highlighted as a red square) and similar pattern can be detected when it comes to “travel time” attribute (Figure 30). This pattern is expected as the longer the journey is, the longer it takes in terms of time. The bus catchment area is again significantly wider in Santa Cruz than in Colegio, for the reasons mentioned above.



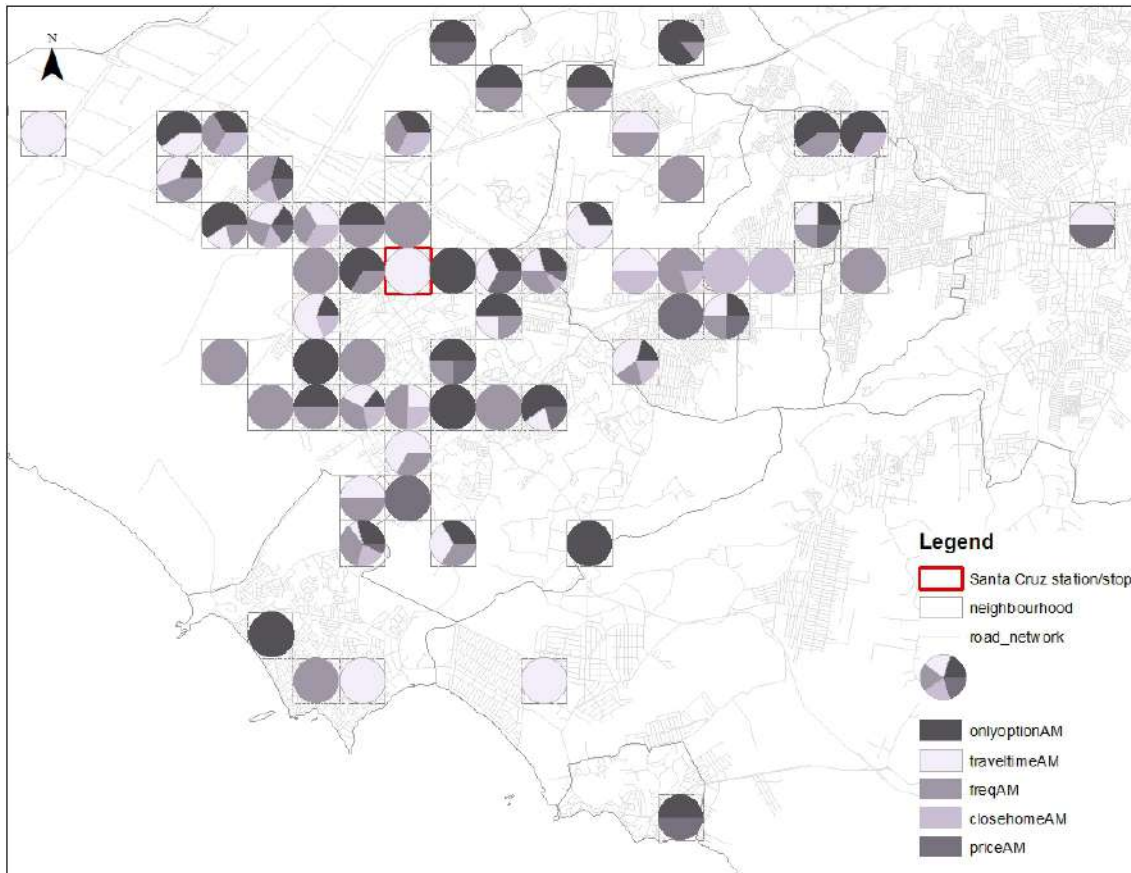
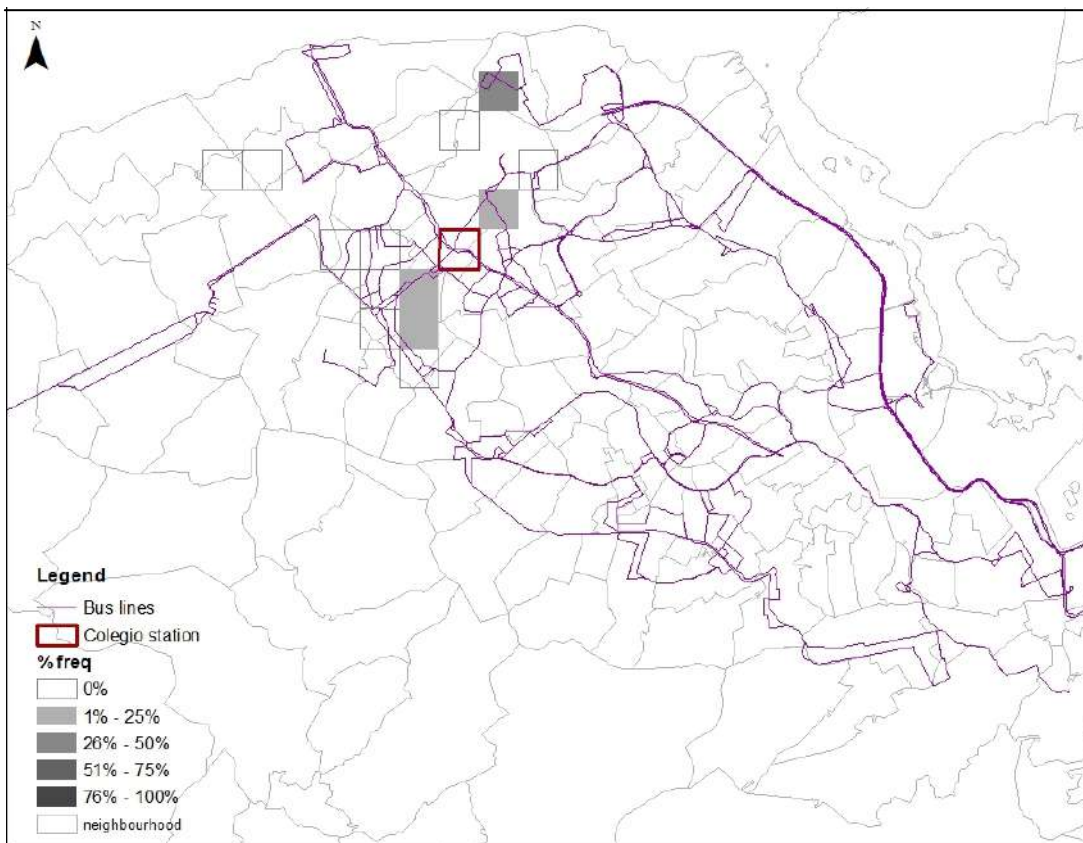

Figure 28: Spatial distribution of bus attributes of choice in Colegio (a) and Santa Cruz (b)



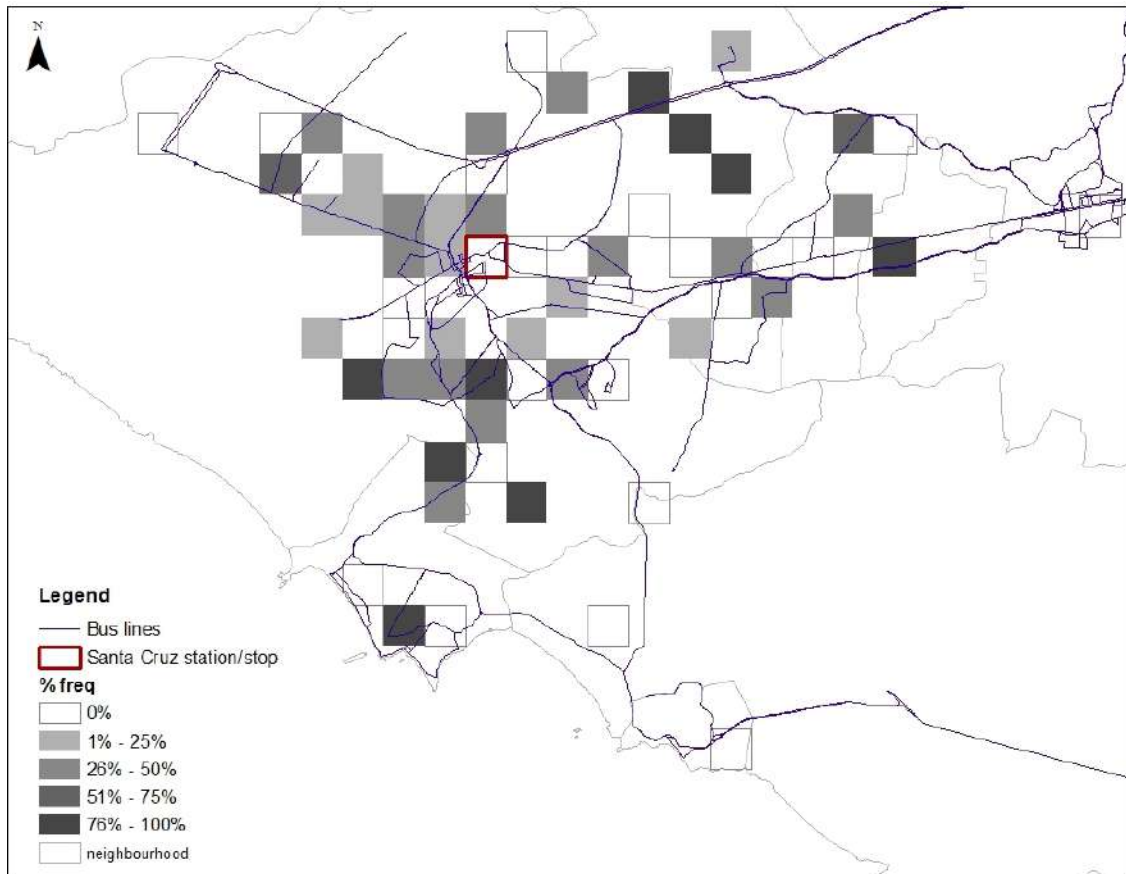

Figure 29: Spatial distribution of “frequency” attribute in Colegio (a) and Santa Cruz (b)

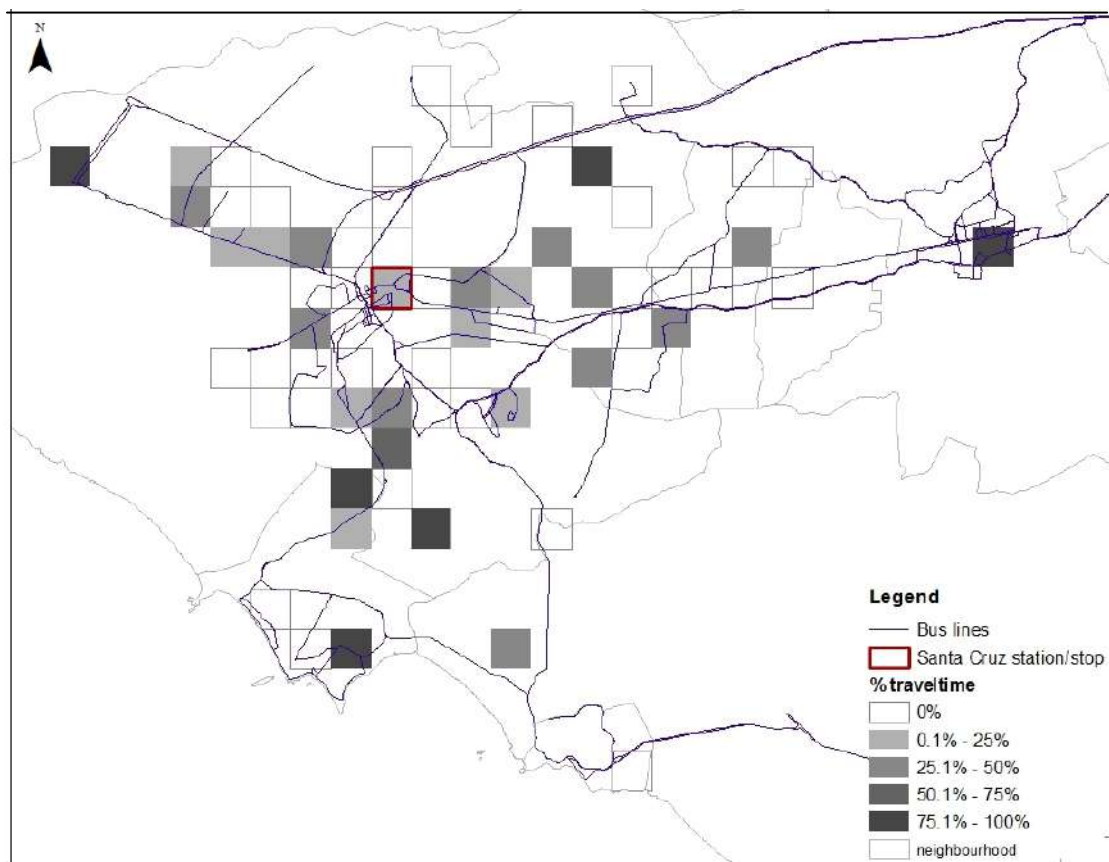
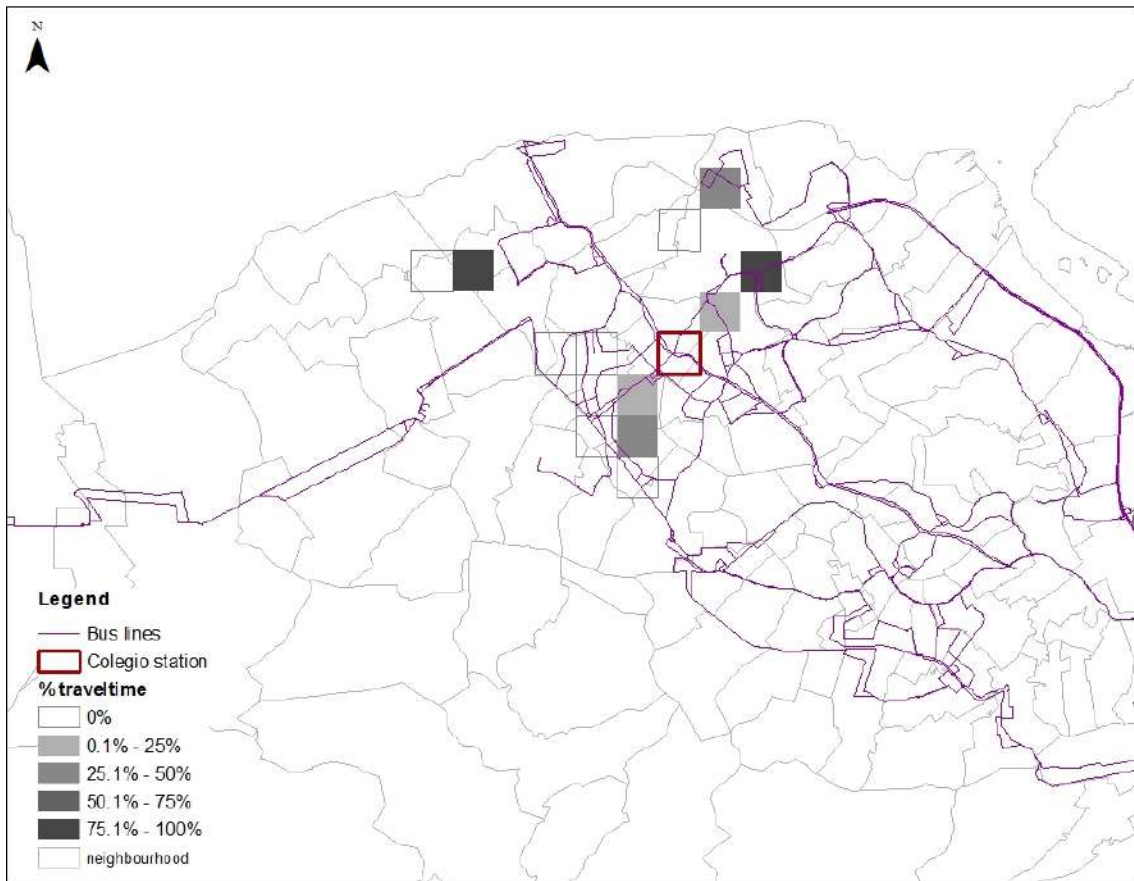
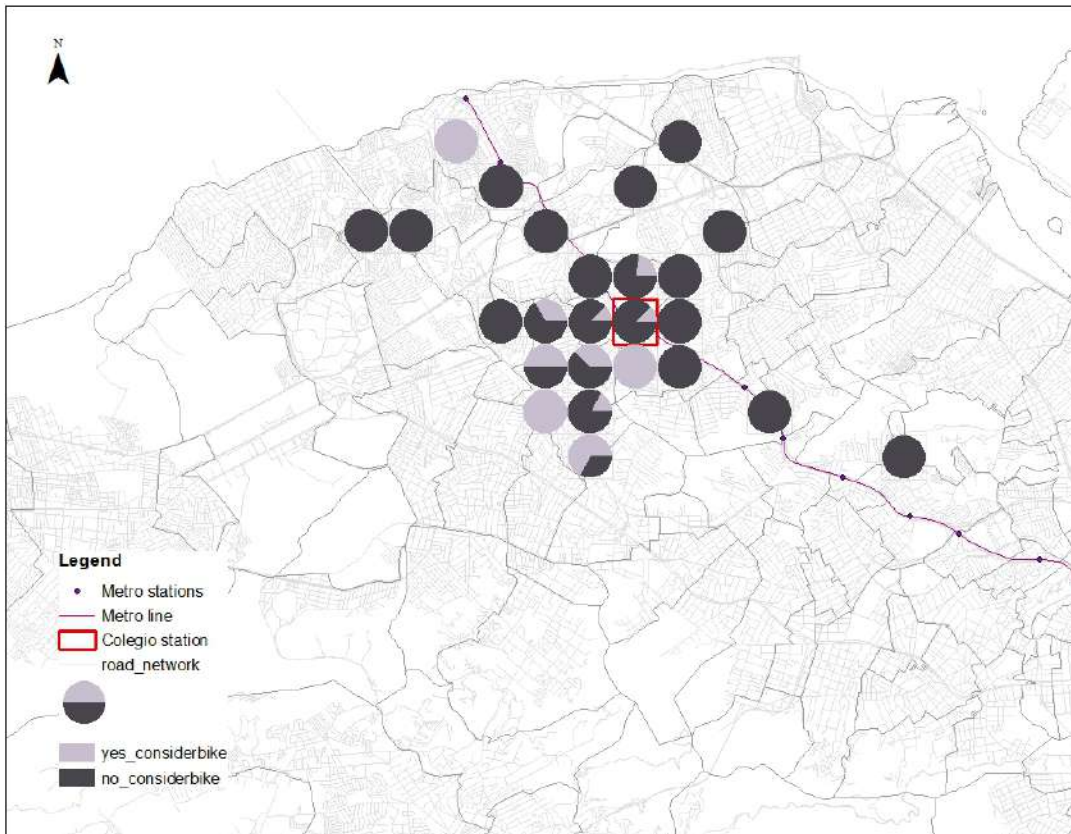

Figure 30: Spatial distribution of “travel time” attribute in Colegio (a) in Santa Cruz (b)

4.3.2 Spatial patterns in access mode travel behavior potential for bicycle in access trips: barriers and motivators

The different characteristics of both locations have a major influence on the potential for biking in access trips. In Colegio the share of people who state they do not consider using the bicycle in trips to the metro station is considerably high (Figure 31). On the other hand, in Santa Cruz, there are more people considering biking to the station/stop. The flat geography coupled with the scarcer offer of PT services and the longer distances can explain the higher potential for bicycle in Santa Cruz than in Colegio.

Especially in Santa Cruz, it is difficult to identify a spatial pattern in the likelihood to cycle which can indicate that this behavior is not necessarily associated to distance or specific areas, but instead it can be more connected to personal preferences or perceptions.



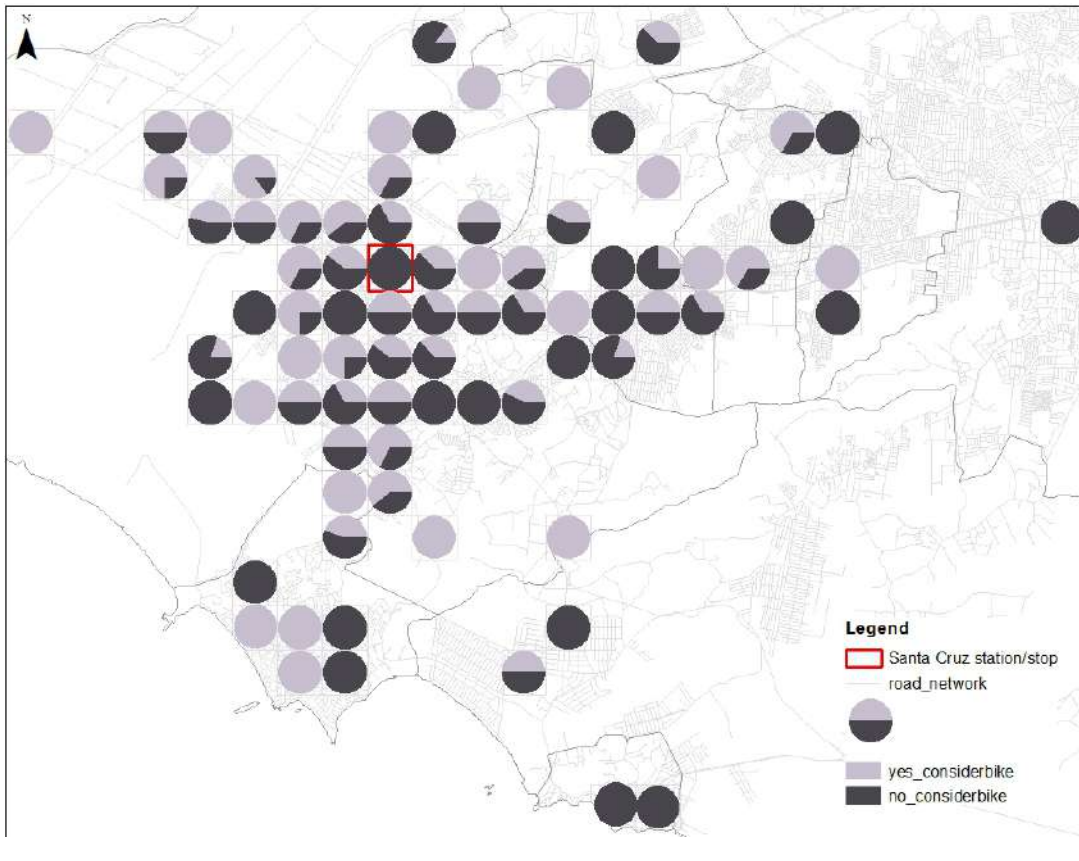

Figure 31: Share of respondents who consider/do not consider biking to the station/stop in Colegio (a) and Santa Cruz (b)

As seen in Table 11 , the most significant self-reported barriers to cycling in integration with PT are living too close, current parking conditions, public safety and personal constraints. The spatial distribution of the share of these barriers is presented in Figure 32. In Colegio living too close is the main barrier and it is unsurprisingly the higher concentration is located in the vicinities of the metro station. For the other barriers no spatial pattern can be detected. The grid cells with no information available correspond to locations where respondents mentioned other barriers other than the ones resulted from the model as explained in section 4.2.

Public safety is major concern in Santa Cruz and there are areas where it is a bigger issue such as on the southern and eastern part of the station as well as in the northwest area. Parking conditions is also an important hindrance to cycling in the area, but no spatial pattern can be identified, as this is more related to the destination (the station/stop) than the origin or the way.

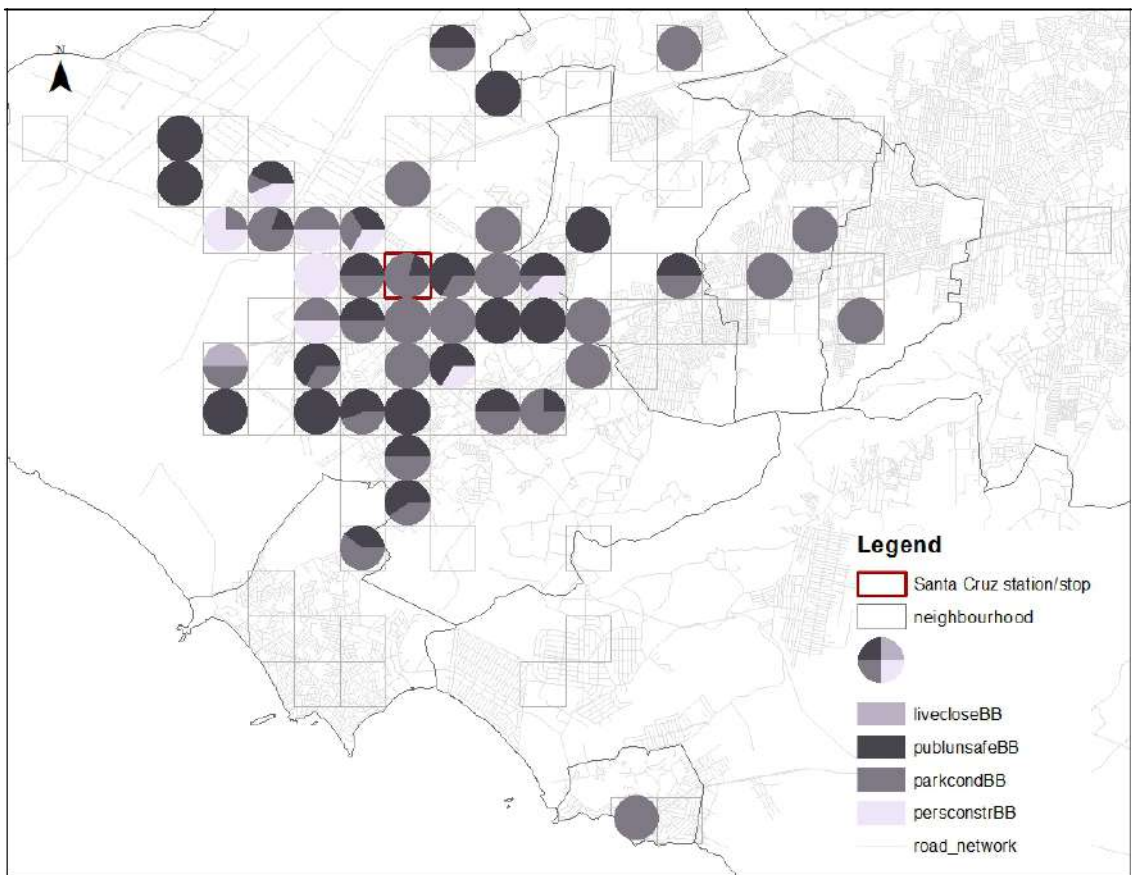
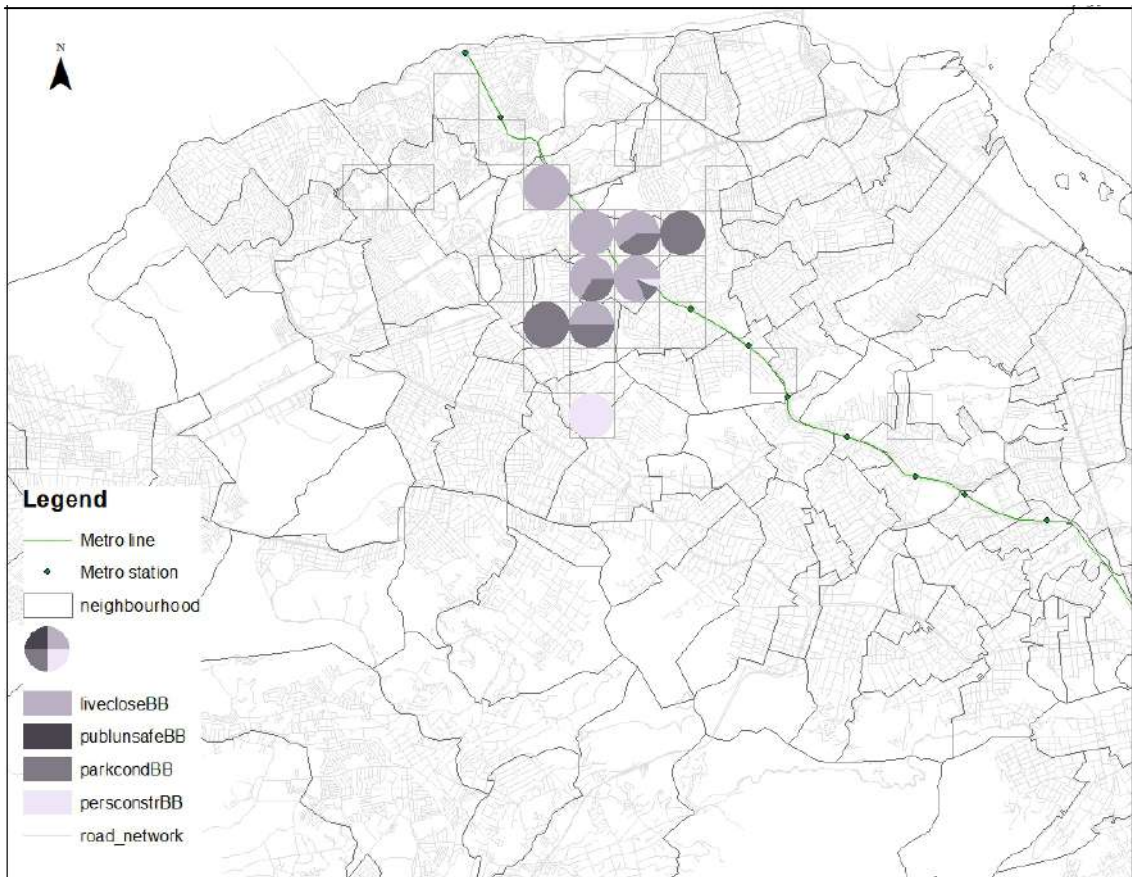
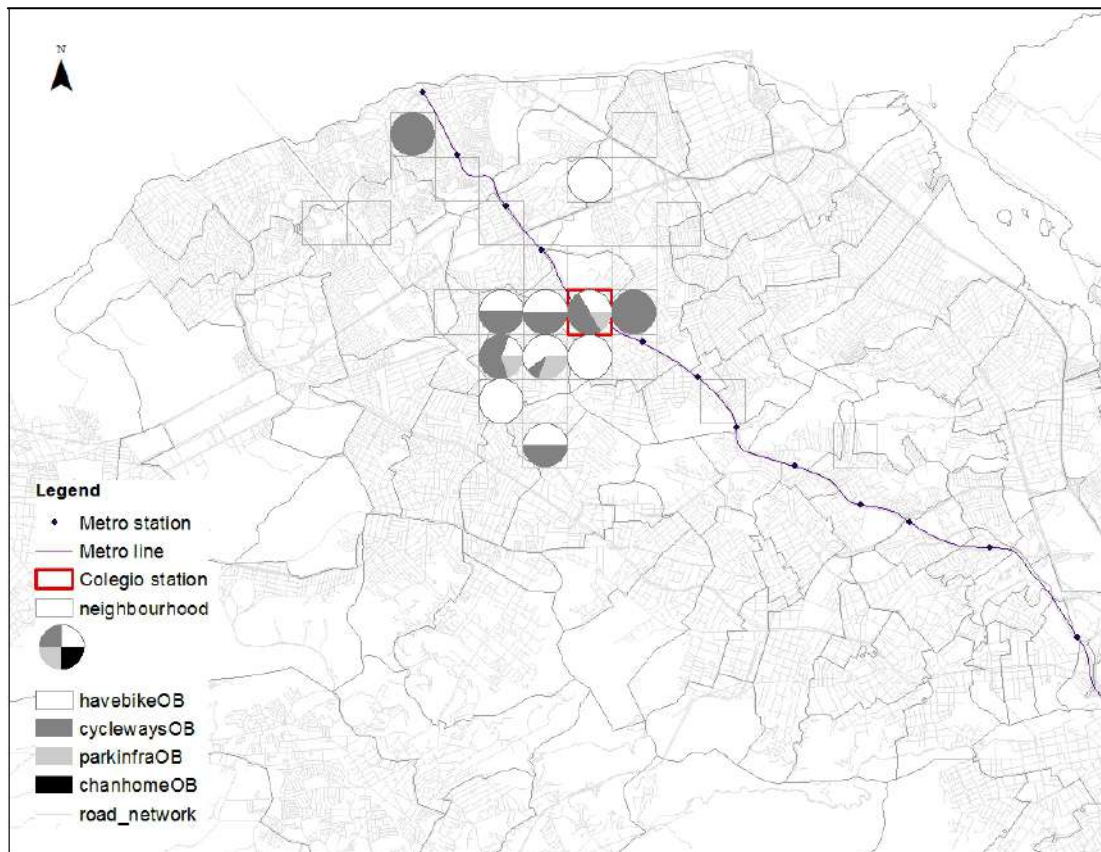

Figure 32: Share of barriers for biking to station/stop in Colegio (a) and Santa Cruz (b)

As for the relevant self-reported motivators for cycling in integration with PT, having a bicycle was mentioned as an important one in Colegio even though no spatial pattern is related to it (Figure 33). The fact that people do not own a bicycle in this area can be explained by the hilliness of the region, which can be a hindrance to the use of this mode. On the other hand, cycleways are considered motivator in the neighborhood and they are particularly relevant for those living in the surroundings of the station.

Contrarily, in Santa Cruz, cycleways are important for origins further from the station. Northern from the station there is a concentration of origins where people mentioned the importance of cycleways and this can be due to the fact that they are located on the other side of a major national highway and crossing it is currently challenging. The same applies for the cluster located on the northwest side from the station. This is an area which is connected to the station through a busy and high speed avenue, which means that cyclists feel very unsafe to cycle along this avenue in shared roads with vehicles.



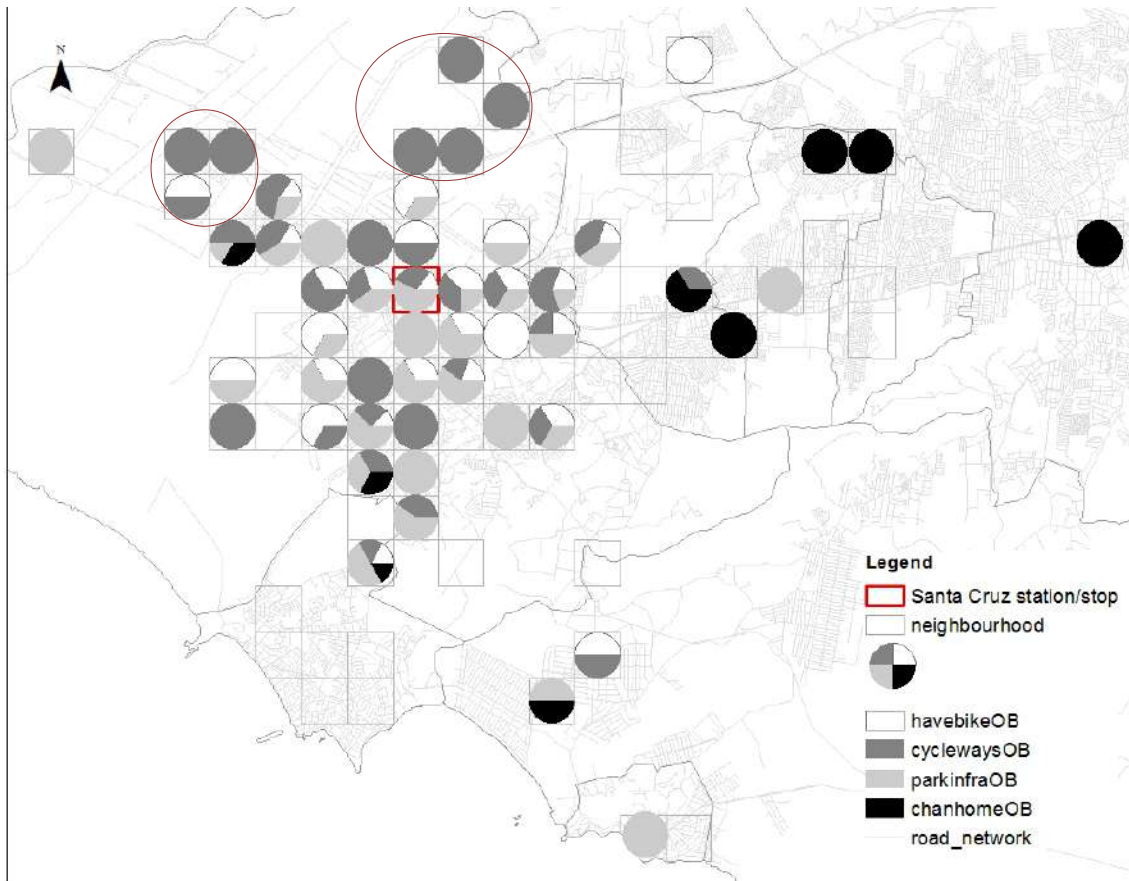

Figure 33: Share of motivators for biking to station/stop in Colegio (a) and Santa Cruz (b)

During the survey, respondents were asked what could be done for them to start biking to station/stop (motivators). A significant number of respondents answered “nothing” meaning that this share of individuals cannot be considered potential cyclists as nothing can be done to change their current behavior towards bicycle. In both locations a higher share of this category of respondents can be found further from stations (Figure 34). The blank grids in Figure 32 and Figure 33 can be explained by this group of respondents.

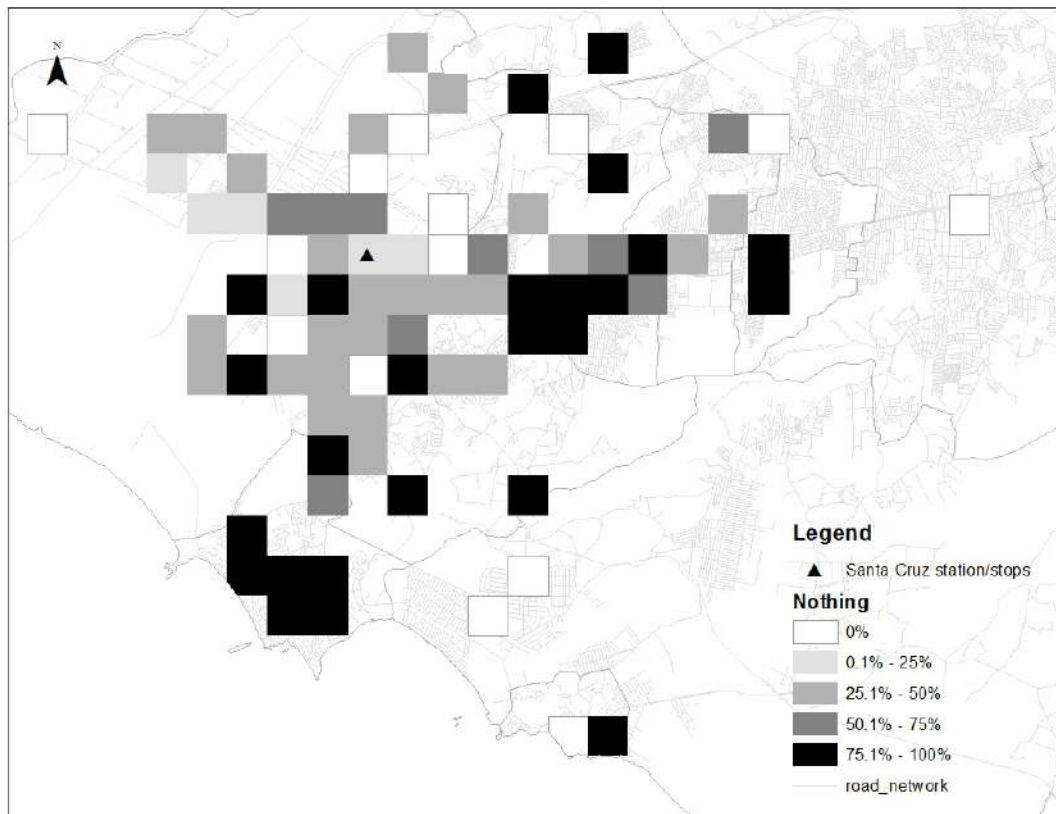
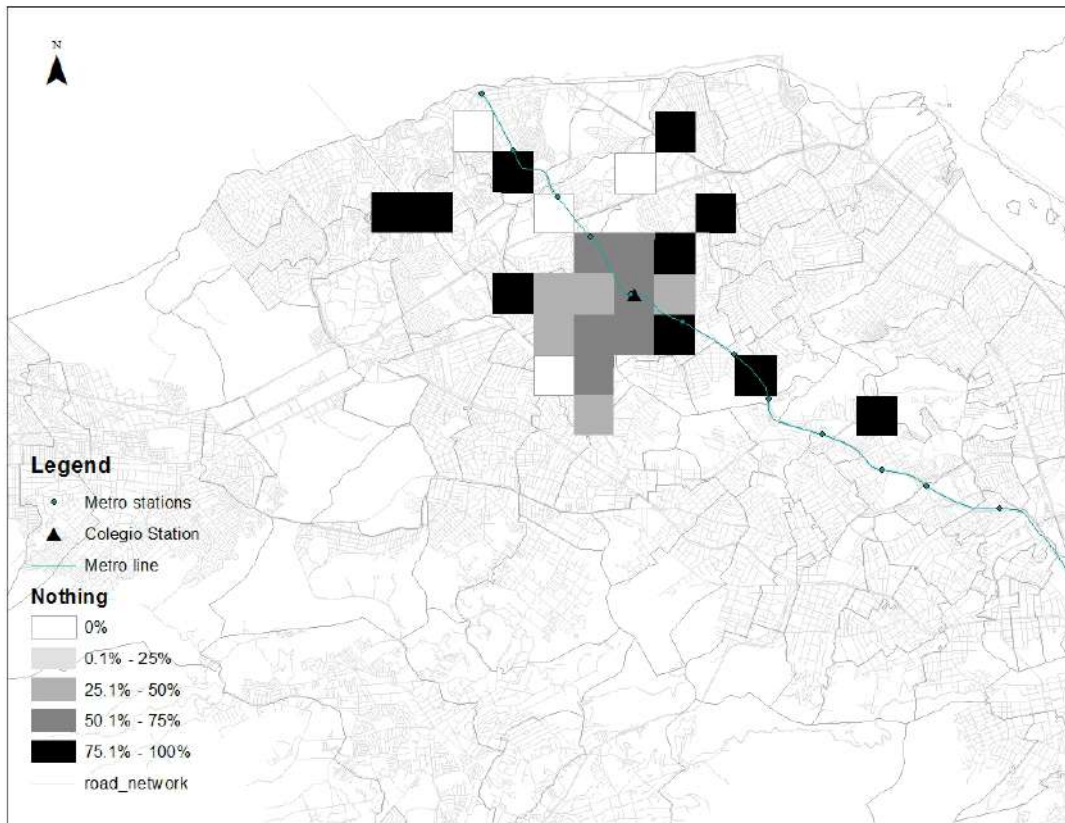

Figure 34: Share of respondents who mentioned that “nothing” would make them cycle Colegio (a) and Santa Cruz (b)

4.4 Conclusion and recommendations

In this chapter the spatial pattern of access mode choice attributes and motivators and barriers for the use of bicycle in access trips were analyzed in two low income areas in Rio de Janeiro. Usually statistical models are used to estimate the factors affecting different kind of trips, however in those statistical models it is not possible to incorporate the spatial dimension. Since transportation is essentially a spatial phenomenon there is a need to understand those factors also in the spatial dimension.

The outcome of this chapter present the spatial patterns in some of the most important outputs from Chapters 2 and 3. In this chapter it is possible to observe the close relation between access mode choice (and its attributes) and the potential for bicycle in access trips (and its barriers and motivators).

Financial constraint is a serious issue, particularly in developing countries where resources are limited. Therefore, it is crucial to know not only what needs to be done, but moreover, where each investment will cause the largest and most positive impacts to people living in each different area.

When it comes to investing in promoting the bicycle as means of transport, it is crucial to know where the highest demand will be revealed, so that the investment made can impact the largest number of people. The spatial analysis of mode choice models enables the identification of areas with specific needs and demands.

Unsurprisingly, proximity from home and cost are the main factors affecting walking trips and spatial patterns are detected. Here there are differences across neighborhoods. Whereas in Colegio the maximum walking distance is of 2km, in Santa Cruz this scales up to 5km. For some of these individuals walking up to 5km in Santa Cruz, "proximity from home" is the reason why the walk. This sheds light to how people perceive distance differently and stresses the importance of understanding travel behavior associated with a spatial analysis.

The indication of from where people walk the most to the station can help urban planners and local government to invest in improving the conditions in these areas. Improving the sidewalks, pavement and traffic lights for pedestrians would have a positive impact for those currently walking but could also encourage other people to shift from motorized modes to walking.

A clear pattern for individuals choosing for IT for its frequency and travel time can be noticed and they are located further from the station. Captivity was also mentioned by bus users who perceive IT as their only possible mode. This information can be useful for bus transport operators, as they can know where their competitor (IT) is more competitive and why and they can invest in new routes in these areas. Residents would benefit from more alternatives.

The time component is also relevant for bus users as “travel time” and “frequency” are mentioned as important attributes of choice for this mode. This holds true especially for people living further from station/stop as the longer the distance the longer the trip takes and the more important this component becomes. For transport operators this can be an indication that, in order to increase patronage, it is crucial to have fast routes and high frequency services, particularly in the most distant areas.

The potential for the use of bicycle in access trips in Colegio is lower than in Santa Cruz due to the fact that access distance is lower in Colegio, meaning that people prefer to walk and the area is hilly which can be a hindrance for this mode.

There is a significant share of people who are not willing to shift from their current access modes to the bicycle, regardless of the changes or improvements in cycling conditions and for these people no spatial pattern is detected, which suggests a relation with personal preferences and perceptions and not to location-specific attributes. This share is higher in Colegio.

Living too close is the main barrier for cycling in Colegio and not relevant barrier in Santa Cruz which brings again the difference in perception of what is close and far. In Santa Cruz, public safety is a major problem and the spatial analysis indicate more critical locations. Even though public safety is a general problem in Rio de Janeiro, this information can help local government to tackle specific areas where this problem is perceived as more prominent.

Dedicated bicycle lanes are important for people living in Santa Cruz and there are specific areas where this is even more needed. By implementing cycleways in certain areas, the local government would encourage the people living there to cycle more to the stations/stops.

When it comes to barriers and motivators for cycling to PT, many of them are not associated to a spatial pattern, like “personal constraints” or “improving parking conditions”. This can be explained by the fact that some of the barriers and motivators

mentioned by respondents are more related to personal perceptions or to the destinations' surroundings than to location-specific characteristics.

The main limitations from this study are the limited sample size and the limited number of study areas. By extending the area of the study and the sample size, it would be possible to observe more nuances in the motivators and barriers, as more areas and more respondents with different characteristics and perceptions would be involved.

Future research could investigate the spatial pattern for the potential for bicycle in access trips in a city level. This would provide more insights on the most promising areas for the bicycle in integration with PT and it would be a powerful tool for the government in prioritizing investments. The broader coverage of a future study would also give an indication on the potential for bicycle in access trips for different income levels.

Another interesting research would be to investigate the behavior as well as barriers and motivators of individuals who currently cycle to stations/stop. It would be interesting to confront the results from the actual cyclists with the potential ones and identify possible similarities and differences across these two groups. It would also highlight the main improvements necessary from the current users' point of view.

5 SYNTHESIS

Public transport is widely acknowledged as a sustainable alternative to individual motorized modes of transport in a rapidly urbanizing world. The need to make PT trips more attractive is not only urgent to serve and keep current users but also to attract people who at present use individual motorized transport options.

5.1 Summary and discussion of the results

This section provides an overview of the findings of this research for each specific objective.

5.1.1 Access mode choice

Access trips are a crucial part of PT transport trips and its importance has been acknowledged by many authors. For this study, an access trip is defined as the trip from home to the main mode boarding point. Access trips can be made by NMT, such as walking and cycling, but also by motorized modes such as bus or car, whereas egress trips are predominantly walking trips. In order to improve the quality of PT journeys and to attract more users, it is essential to understand how people get to the main mode boarding point and which factors influence these choices.

In Chapter 2, it is indicated that socioeconomic characteristics such as gender and age play an important role in access mode choice, particularly for informal transport (IT) users. Women are more likely to use IT whereas young people are less likely to use this mode. Surprisingly, when it comes to walking, age and gender do not play a role as younger people and men are expected to walk more. It can probably be explained by the fact that in low income areas people tend to walk more, regardless their age and gender, in order to save money.

Proximity to the station/stop and costs are closely related to walking trips whereas frequency and travel time explain the choice for IT. Captivity has a negative effect on IT choice, which means that those people are more likely to use the bus.

5.1.2 Potential for bicycle in access trips

Bicycle is a green, active (thus beneficial for health) and almost costless mode of transport. Its potential for access trips is enormous as it is faster than walking and it

is efficient for short distance trips, which is often the case for access trips. In addition, the bicycle is flexible and does not have to comply with itinerary and timetables, as public transport alternatives do. However, in many developing countries the practice of combining the bicycle with PT is not widespread. Therefore there is a need to investigate the main barriers and motivators for the use of the bicycle in access trips to PT in its local context. This research has investigated this topic for two neighbourhoods in the city of Rio de Janeiro, Brazil.

In Chapter 2, it is indicated that for individuals who currently walk to PT, travel costs are an important attribute of access mode choice, as well as proximity from home. The bicycle can easily replace walking trips as a (virtually) costless and faster mode. However, walking is still the preferred mode when the distance to the station/stop is very short. In Chapter 3 it was pointed that living very close was one of the main reasons for not using the bicycle in access trips, consistent with Dutch findings. In the Netherlands people walk to train stations for access trips up to 1.2km, for longer trips (up to 3.7km) they cycle and for even longer trips (more than 3.7km) they use PT (Givoni & Rietveld, 2007; Keijer & Rietveld, 2000; Puello & Geurs, 2015; Rietveld, 2000b).

As seen in Chapter 2, for IT (informal transport) users, frequency and travel time are relevant factors for choosing this mode of transport, as compared to the bus. In trips where the distance is not too long, the bicycle can be a faster alternative, as motorized modes get frequently stuck in congestion. Furthermore, the bicycle is permanently available (as long as the person owns one) and, as mentioned above, does not depend on a fixed timetable.

Current bicycle parking conditions are identified as an important barrier and, likewise, the improvement of bicycle parking conditions was pointed as a motivator. Contrarily to the home location, bicycle parking infrastructure near stations/stops is an issue that can be tackled by local governments. Even though parking spots are currently available in both areas, their capacities are insufficient. Demand is higher than supply in both cases. Local authorities and transport operators could collaborate and together provide better, safer (guarded) and free bicycle parking inside premises of the stations and also in the surroundings.

Public safety is an issue in many developing countries and more so in Rio de Janeiro. This factor is a hindrance for many potential bicycle users. Cyclists can feel very vulnerable and the research suggests that it is the reason why being a woman is negatively correlated with the use of the bicycle. Measures to improve public safety can

be implemented, such as improving lightening and having dedicated bicycle traffic lights at crossings, so cyclists do not have to travel in dark environments or to stop and wait for the green light too long. Knowing where the critical locations for public safety are would help local authorities to prioritize investments. In Chapter 4, spatial patterns for bicycle potential in access trips are identified.

Bicycle ownership is positively related to the bicycle potential in access trips, as mentioned in Chapter 3. Corroborating this finding, owning a bicycle is an important motivator for potential access trips made by this mode, hence ownership should be encouraged. Since this study focusses on commuting trips, employers could play a role and stimulate employees to use bicycle in their home-work trips. Moreover, the existing bicycle sharing facilities could be extended to more areas of the city of Rio de Janeiro and they could also be more financially attractive, so that low income workers could also make use of these facilities.

Finally, cycleways is also a significant motivator. By building dedicated lanes for bicycles, local authorities would encourage individuals to cycle. Especially in developing countries where funds are scarce, it is crucial to prioritize investments in (cost-attractive) bicycle infrastructure with adequate design standards, and to know where the bicycle potential is the highest and the new infrastructure would have the highest impact on travel demand. The locations where cycleways are most suitable in the two case study areas are presented in Chapter 4.

5.1.3 Spatial patterns in access mode choice attributes and barriers and motivators of cycling in access trips

In Chapter 4 the visualization of the access mode choice attributes and the motivators and barriers for the use of bicycle in those trips enables the incorporation of the spatial component and analysis.

Spatial patterns can be noticed when it comes to access mode choice. Proximity from home for walking trips is located in the surroundings of the stations. However, it is interesting to notice that how close people consider their homes from station differs significantly across neighborhoods and this can be relevant for urban and transport planners. By knowing from where people walk local government can provide adequate infrastructure to encourage this sustainable and healthy means of transport.

Captivity and frequency and relevant for IT users and there is a spatial pattern involved, for people located further from the station and in certain areas. Bus operators can benefit from this information as they can offer new routes in those areas.

In Santa Cruz, public safety is a major problem and the spatial analysis indicates dangerous areas. Public safety is a wide-ranging problem in Rio de Janeiro, however, knowing the critical areas can help local government to tackle where this problem is perceived as more prominent.

Dedicated bicycle lanes are important for people living in Santa Cruz and there are specific areas where this is even more desired. By implementing cycleways in certain areas, the local government would encourage the people living there to cycle more to the stations/stops.

5.2 Reflections

This section provides a reflection on the key findings of this thesis. It contains a summary of the main contributions and recommendations for the future studies.

5.2.1 Main Contribution

This thesis is amongst the first research to look at access trips and the potential for bicycle as access mode in developing countries, considering bus and metro as main modes and not only train, incorporating behavioural factors, coupling logit models with visualizations in GIS.

Firstly, this study analyses travel demand for public transport access trips based on data collected in Brazil, a developing country, which adds to the current body of research that is mainly concentrated on developed countries, particularly in Europe. Culture, travel habits and patterns as well as transport supply differ significantly, hence this research provides an additional perspective to the well consolidated literature in developed countries.

Secondly, this research looks at access mode choice and the potential for bicycle in access trips through the users' perspective, by incorporating self-reported attributes of mode choice and barriers and motivators for bicycle use, which in turn proved to be relevant factors.

Thirdly, this investigation focusses on access trips to various modes of transport, such as bus, train and metro, differently from other studies which focus mainly on one single main mode, mostly trains.

Finally, in the research the results of logit models to estimate the factors affecting access mode choice and the potential for bicycle in access trips are coupled with a spatial analysis, which enables the visualization of the phenomena under investigation.

5.2.2 Limitations and recommendations for future research

In this section, the main limitations and recommendation for further research are presented.

Broader geographical catchment

Due to financial and time limitations, this study is based on data collected in two low income neighbourhoods in Rio de Janeiro, Brazil. Even though the variability amongst areas was taken into account when selecting the locations, it would be interesting to have a variety of neighbourhoods in future studies. This variety could encompass more areas with the same characteristics, but also is could incorporate, for instance, high income areas.

Larger sample

The financial and time limitation in this study also affected the sample size, not only the limited number of study areas. Having a larger sample and a broader geographical area would allow for more insights and deeper results in a higher level than the neighbourhood one. Ideally a city-wide survey would provide the municipality with a real picture and a map of the investments priorities per location.

Diversity in main mode boarding points

A limitation of this research was also the fact that only one metro station, one train station and a few bus stops (in a distance of 400m one from the other) were included in the analysis. Even though another study (MARTENS, 2004) has identified the relation between bicycle in access trips and main mode, and also other studies (KEIJER; RIETVELD, 2000; MARTENS, 2004; RIETVELD, 2000a) have confirmed the strong relation between access mode and main mode choice, this variable (main mode) was not significant in the models presented in Chapter 2 nor in Chapter 3. This can be due to the limited number of stations considered in the present research. Future research in developing countries could look at a bigger number of stations/stops, in

different areas and with different characteristics and examine the relation between the bicycle and the main mode.

By including multiple boarding points for all modes, it would be possible to control for the influence of main mode on access trips and on the potential for cycling to stations/stops.

Trip purposes

The focus of the present research is on commuting trips. However, it would be interesting to examine the factors affecting access mode choice and the barriers and motivators for cycling in those trips for other trip purposes, such as leisure and shopping, for instance.

Psychological indicators

In this research the self-reported barriers and motivators for the bicycle use is incorporated in order to bring the behavioural component to the model. Nevertheless, the inclusion of other psychological indicators such as perceptions, beliefs, life style, would enrich the behavioural analysis and would provide deeper insights into the underlying reasons for individuals not to cycle.

Barriers for access mode

Part of the focus of the present research is on the factors affecting access trips. This means that the question posed to the respondents is “why do you choose the mode”. It would be also interesting to investigate what could be done to improve the conditions of the current access mode. This would help transport operators and local government in improving current access trips and consequently the overall commuting experience.

6 BIBLIOGRAPHY

ADVANI, M.; TIWARI, G. **Bicycle – As a feeder mode for bus service**. Velo Mondial Conference. **Anais...**Cape Town, South Africa: 2006a

ADVANI, M.; TIWARI, G. Review of Capacity Improvement Strategies for Bus transit service. **Indian Journal of Transport Management**, n. October-December, p. 363–391, 2006b.

ANTP. Panorama da Mobilidade Urbana no Brasil: Tendências e desafio. **Cadernos Técnicos**, v. 3, p. 121, 2006.

ANTP. Sistema de Informações da Mobilidade Urbana Relatório Geral 2011 Dezembro / 2012. p. 118, 2012.

BACHAND-MARLEAU, J.; LEE, B. H. Y.; EL-GENEIDY, A. M. Better Understanding of Factors Influencing Likelihood of Using Shared Bicycle Systems and Frequency of Use. **Transportation Research Record: Journal of the Transportation Research Board**, v. 2314, p. 66–71, 2012.

BAKKER, S. et al. Hot or not? The role of cycling in ASEAN megacities: case studies of Bangkok and Manila. **International Journal of Sustainable Transportation**, v. 0, n. ja, p. 0, 2017.

BECHSTEIN, E. **CYCLING AS A SUPPLEMENTARY MODE TO PUBLIC TRANSPORT: A Case Study of Low Income Commuters in South Africa**. 29th Southern African Transport Conference SATC 2010. **Anais...**2010Disponível em: <[http://repository.up.ac.za/bitstream/handle/2263/14739/Bechstien_Cycling\(2010\).pdf?sequence=1](http://repository.up.ac.za/bitstream/handle/2263/14739/Bechstien_Cycling(2010).pdf?sequence=1)>

BEUKES, E. et al. Quantifying the contextual influences on road design. **Computer-Aided Civil and Infrastructure Engineering**, v. 28, n. 5, p. 344–358, 2013.

BIERLAIRE, M. Estimation of discrete choice models with BIOGEME 1.8. 2009a.

BIERLAIRE, M. Biogeme. 2009b.

BRONS, M.; GIVONI, M.; RIETVELD, P. Access to railway stations and its potential in increasing rail use. **Transportation Research Part A: Policy and Practice**, v. 43, n. 2, p. 136–149, fev. 2009.

BRUSSEL, M.; ZUIDGEEST, M.; DE SOUZA, F. How can the stigma of public transport as the “poor man’s vehicle” be overcome to enhance sustainability and climate change mitigation?”. **Natural Resources Forum**, v. 34, n. 2010, p. 327–331, 2011.

BULIUNG, R. N.; KANAROGLOU, P. S. A GIS toolkit for exploring geographies of household activity/travel behavior. **Journal of Transport Geography**, v. 14, n. 1, p. 35–51, 2006.

CERVERO, R.; KOCKELMAN, K. **Travel demand and the 3Ds: Density, diversity, and design** **Transportation Research Part D: Transport and Environment**, 1997.

CHEN, S. et al. Multi-scale and multi-modal GIS-T data model. **Journal of Transport Geography**, v. 19, n. 1, p. 147–161, jan. 2011.

CHERCHI, E.; CIRILLO, C. **On the day-to-day variability in modal choices: a mixed logit model**. Proceedings of the 16th PANAM. **Anais...**Lisbon, Portugal: 2010

CHERRY, C.; CERVERO, R. Use characteristics and mode choice behavior of electric bike users

in China. **Transport Policy**, v. 14, n. 3, p. 247–257, 2007.

CONFEDERACAO NACIONAL DO TRANSPORTE. **Pesquisa Mobilidade da Populacao Urbana 2017**. Brasilia: [s.n.].

CURTIS, C. Planning for sustainable accessibility: The implementation challenge. **Transport Policy**, v. 15, n. 2, p. 104–112, mar. 2008.

DARGAY, J.; GATELY, D.; SOMMER, M. Vehicle Ownership and Income Growth , Worldwide : 1960-2030. **Energy**, v. 28, n. 4, 2007.

DE SOUZA, F. et al. **TO CYCLE OR NOT TO CYCLE ? FACTORS INFLUENCING THE DECISION TO USE THE BICYCLE AS ACCESS MODE TO PUBLIC TRANSPORT**. 12th WCTR. **Anais...**Lisbon: 2010

DE SOUZA, F. et al. **A COMPARATIVE STUDY ON CYCLISTS PROFILE, CYCLING TRIPS AND CYCLISTS BEHAVIOR IN TWO AREAS OF RIO DE JANEIRO**. ANPET. **Anais...**2011

DEBREZION, G.; PELS, E.; RIETVELD, P. Modelling the joint access mode and railway station choice. **Transportation Research Part E: Logistics and Transportation Review**, v. 45, n. 1, p. 270–283, jan. 2009.

DIANA, M.; MOKHTARIAN, P. Desire to change one's multimodality and its relationship to the use of different transport means. **Transportation Research Part F: Traffic Psychology and Behaviour**, v. 12, n. 2, p. 107–119, mar. 2009.

DILL, J.; CARR, T. Bicycle Commuting and Facilities in Major U . S . Cities : If You Build Them , Commuters Will Use Them – Another Look. p. 1–9, 2003.

DILL, J.; VOROS, K. Factors Affecting Bicycling Demand: Initial Survey Findings from the Portland, Oregon, Region. **Transportation Research Record**, v. 2031, p. 9–17, 2008.

ENSOR, M.; SLASON, J. **Forecasting the benefits from integrating cycling and public transport**. Institution of Professional Engineers New Zealand (IPENZ) Transportation Conference. **Anais...**Auckland, New Zealand: 2011

EWING, R.; SCHROEER, W.; GREENE, W. School Location and Student Travel Analysis of Factors Affecting Mode Choice. **Transportation Research Record**, v. 1895, n. 1, p. 55–63, 1 jan. 2004.

FERNÁNDEZ-HEREDIA, Á.; MONZÓN, A.; JARA-DÍAZ, S. Understanding cyclists' perceptions, keys for a successful bicycle promotion. **Transportation Research Part A: Policy and Practice**, v. 63, p. 1–11, maio 2014.

FETRANSPOR. **Pesquisa de Opinião Pública sobre Transportes Coletivos**. [s.l: s.n.].

GIVONI, M.; RIETVELD, P. The access journey to the railway station and its role in passengers' satisfaction with rail travel. **Transport Policy**, v. 14, n. 5, p. 357–365, set. 2007a.

GIVONI, M.; RIETVELD, P. The access journey to the railway station and its role in passengers' satisfaction with rail travel. **Transport Policy**, v. 14, n. 5, p. 357–365, set. 2007b.

GIVONI, M.; RIETVELD, P. The access journey to the railway station and its role in passengers' satisfaction with rail travel. **Transport Policy**, v. 14, n. 5, p. 357–365, set. 2007c.

GROTENHUIS, J.; WIEGMANS, B.; RIETVELD, P. The desired quality of integrated multimodal

travel information in public transport: Customer needs for time and effort savings. **Transport Policy**, v. 14, n. 1, p. 27–38, jan. 2007.

HALE, C. Station Access On Four Continents. **13th WC**, p. 1–15, 2013.

HALE, C. A. **Station Access and the Modern Transit System**. Australasian Transport Research Forum 2011 Proceedings. **Anais...Adelaide**, Australia: 2011Disponível em: <<http://www.patrec.org/atrf.aspx>>

HARTWIG, H. Assessment of Bicycle Service Areas around Transit Stations. **International Journal of Sustainable Transportation**, n. 954, p. 1–45, 2013.

HEINEN, E.; MAAT, K.; WEE, B. VAN. The role of attitudes toward characteristics of bicycle commuting on the choice to cycle to work over various distances. **Transportation Research Part D: Transport and Environment**, v. 16, n. 2, p. 102–109, mar. 2011.

HEINEN, E.; VAN WEE, B.; MAAT, K. Commuting by Bicycle: An Overview of the Literature. **Transport Reviews**, v. 30, n. 1, p. 59–96, jan. 2010.

HENSHER, D. Sustainable public transport systems: Moving towards a value for money and network-based approach and away from blind commitment. **Transport Policy**, v. 14, n. 1, p. 98–102, jan. 2007.

HINE, J.; SCOTT, J. Seamless, accessible travel: users' views of the public transport journey and interchange. **Transport Policy**, v. 7, n. 3, p. 217–226, jul. 2000.

HOOGENDOORN-LANSER, S.; VAN NES, R.; HOOGENDOORN, S. Modeling Transfers in Multimodal Trips: Explaining Correlations. **Transportation Research Record**, v. 1985, n. 1, p. 144–153, 2006.

IBGE. **Pesquisa de Orçamentos Familiar 2003-2004 - Brasil e Grandes regiões** Pesquisa de orçamentos familiares. [s.l.: s.n.]. Disponível em: <http://www.ibge.com.br/home/estatistica/populacao/condicaoodevida/pof/2008_2009_aquisicao/pof20082009_aquisicao.pdf>.

IBGE. **Pesquisa de Orcamentos Familiares 2008-2009**. Rio de Janeiro: [s.n.].

IBGE. **Sinopse do Censo Demografico 2010**. Rio de Janeiro: [s.n.].

IBGE. Pesquisa Nacional por Amostra de Domicílios: Síntese de indicadores. p. 272, 2012.

INSITUTO PEREIRA PASSOS. **Plano Diretor de Transportes da Cidade do Rio de Janeiro**. [s.l: s.n.].

JAIN, D.; TIWARI, G. How the present would have looked like? Impact of non-motorized transport and public transport infrastructure on travel behavior , energy consumption and CO 2 emissions – Delhi , Pune and Patna. **Sustainable Cities and Society**, v. 22, p. 1–10, 2016.

JENSEN, M. Passion and heart in transport — a sociological analysis on transport behaviour. **Transport Policy**, v. 6, n. 1, p. 19–33, jan. 1999.

JIANG, Y.; CHRISTOPHER ZEGRAS, P.; MEHNDIRATTA, S. Walk the line: station context, corridor type and bus rapid transit walk access in Jinan, China. **Journal of Transport Geography**, v. 20, n. 1, p. 1–14, jan. 2012.

JOHANSSON, M. V.; HELDT, T.; JOHANSSON, P. The effects of attitudes and personality traits on mode choice. **Transportation Research Part A: Policy and Practice**, v. 40, n. 6, p. 507–525, 2006.

JONES, M.; BUCKLAND, L. **Estimating Bicycle and Pedestrian Demand in San Diego**. TRB 2008 Annual Meeting CD-ROM. **Anais...**2008

KAMRUZZAMAN, M. et al. Using GIS to visualise and evaluate student travel behaviour. **Journal of Transport Geography**, v. 19, n. 1, p. 13–32, 2011.

KEIJER, M. J. N.; RIETVELD, P. How do people get to the railway station? The dutch experience. **Transportation Planning and Technology**, v. 23, n. 3, p. 215–235, 2000.

KENNEDY, C. A. A comparison of the sustainability of public and private transportation systems : Study of the Greater Toronto Area. **Transportation**, p. 459–493, 2002.

KIM, S.; ULFARSSON, G.; TODDHENNESSY, J. Analysis of light rail rider travel behavior: Impacts of individual, built environment, and crime characteristics on transit access. **Transportation Research Part A: Policy and Practice**, v. 41, n. 6, p. 511–522, jul. 2007.

KOPPELMAN, F. S.; BHAT, C. A Self Instructing Course in Mode Choice Modeling : Multinomial and Nested Logit Models by with technical support from Table of Contents. 2006.

KRYGSMAN, S.; DJIST, M.; ARENTZE, T. Multimodal public transport: an analysis of travel time elements and the interconnectivity ratio. **Transport Policy**, v. 11, n. 3, p. 265–275, jul. 2004.

LA PAIX PUELLO, L. **MODELLING THE IMPACT OF BUILT ENVIRONMENT , GEOGRAPHICAL SCALES AND LATENT**. [s.l.] Universidad Politécnica de Madrid, 2012.

LARSEN, J.; EL-GENEIDY, A. A travel behavior analysis of urban cycling facilities in Montréal, Canada. **Transportation Research Part D: Transport and Environment**, v. 16, n. 2, p. 172–177, mar. 2011.

LAWSON, A. R.; MCMORROW, K.; GHOSH, B. Analysis of the non-motorized commuter journeys in major Irish cities. **Transport Policy**, v. 27, p. 179–188, maio 2013.

LESLIE, E. et al. Residents' perceptions of walkability attributes in objectively different neighbourhoods: A pilot study. **Health and Place**, v. 11, n. 3, p. 227–236, 2005.

LI, T.; CORCORAN, J.; BURKE, M. Disaggregate GIS modelling to track spatial change: exploring a decade of commuting in South East Queensland, Australia. **Journal of Transport Geography**, v. 24, p. 306–314, 2012.

MAARSEVEEN, M. H. P. Z. AND M. F. A. M. VAN; SECTION. Transportation planning for sustainable development. n. July, p. 17–20, 2000.

MAAT, K.; WEE, B. VAN; STEAD, D. Land use and travel behaviour: expected effects from the perspective of utility theory and activity-based theories. **Environment and Planning B: Planning and Design**, v. 32, n. 1, p. 33–46, 2005.

MARTENS, K. The bicycle as a feedering mode: experiences from three European countries. **Transportation Research Part D**, v. 9, p. 281–294, 2004.

MARTENS, K. Promoting bike-and-ride: The Dutch experience. **Transportation Research Part A: Policy and Practice**, v. 41, n. 4, p. 326–338, maio 2007.

- MASSINK, R. et al. The climate value of cycling. **Natural Resources Forum**, v. 35, n. 2, p. 100–111, 2011.
- MAT YAZID, M. R.; ISMAIL, R.; ATIQ, R. The use of non-motorized for sustainable transportation in Malaysia. **Procedia Engineering**, v. 20, p. 125–134, 2011.
- MCFADDEN, D. **The measurement of urban travel demand** **Journal of Public Economics**, 1974.
- MINISTÉRIO DAS CIDADES. **Caderno de Referência para elaboração de: Plano de Mobilidade por Bicicleta nas Cidades**. [s.l: s.n.].
- MURRAY, A. et al. Public Transportation Access. **Transportation Research Part D: Transport and Environment**, v. 3, n. 5, p. 319–328, set. 1998.
- NES, R. VAN. **Design of multimodal transport networks A hierarchical approach**. [s.l.] Technische Universiteit Delft, 2002.
- NKURUNZIZA, A. et al. Examining the potential for modal change: Motivators and barriers for bicycle commuting in Dar-es-Salaam. **Transport Policy**, v. 24, p. 249–259, nov. 2012.
- ORTÚZAR, J.; IACOBELLI, A.; VALEZE, C. Estimating demand for a cycle-way network. **Transportation Research Part A: Policy and Practice**, v. 34, n. 5, p. 353–373, jun. 2000.
- PARK, S.; KANG, J.; CHOI, K. Finding determinants of transit users' walking and biking access trips to the station: A pilot case study. **Journal of Civil Engineering**, v. 18, n. 2, p. 651–658, 2014.
- PARKIN, J.; WARDMAN, M.; PAGE, M. Estimation of the determinants of bicycle mode share for the journey to work using census data. **Transportation**, v. 35, n. 1, p. 93–109, 2008.
- PLAUT, P. O. Non-motorized commuting in the US. **Transportation Research Part D: Transport and Environment**, v. 10, n. 5, p. 347–356, set. 2005.
- POCHET, P.; CUSSET, J.-M. Cultural barriers to bicycle use in Western African cities: The case of Bamako and Ouagadougou. v. 23, n. 2, p. 43–50, 1999.
- PUCHER, J.; BUEHLER, R. Making Cycling Irresistible: Lessons from The Netherlands, Denmark and Germany. **Transport Reviews**, v. 28, n. 4, p. 495–528, 2008.
- PUELLO, L. L. P.; GEURS, K. Modelling observed and unobserved factors in cycling to railway stations: Application to transit-oriented-developments in the Netherlands. **European Journal of Transport and Infrastructure Research**, v. 15, n. 1, p. 27–50, 2015.
- QUARSHIE, M. L. **Integrating cycling in Bus Rapid Transit in Accra**. (G. M. Morrison, S. Rauch, Eds.) Proceedings of the 8th Highway and Urban Environment Symposium. **Anais...Nicosia**, Cyprus: Springer, 2007
- REPLOGLE, M. Bicycle access to public transportation: learning from abroad. **Transportation Research Record**, n. December, p. 1–10, 1992.
- RIETVELD, P. The accessibility of railway stations: the role of the bicycle in The Netherlands. **Transportation Research Part D: Transport and Environment**, v. 5, n. 1, p. 71–75, jan. 2000a.
- RIETVELD, P. Non-motorised modes in transport systems: a multimodal chain perspective for The Netherlands. **Transportation Research Part D: Transport and Environment**, v. 5, n. 1, p. 31–36,

jan. 2000b.

RIETVELD, P. **Biking and Walking: The Position of Non-Motorised Modes in Transport Systems** Erasmus. [s.l: s.n.].

RIETVELD, P.; DANIEL, V. Determinants of bicycle use: do municipal policies matter. **Transportation Research A**, v. 38, p. 531–550, 2004.

RODRIGUES, J. M. **Evolucao da frota de automoveis e motos no Brasil 2001 – 2012 (Relatório 2013)**. Rio de Janeiro: [s.n.].

RODRÍGUEZ, D. A.; JOO, J. The relationship between non-motorized mode choice and the local physical environment. **Transportation Research Part D: Transport and Environment**, v. 9, n. 2, p. 151–173, mar. 2004.

ROGALSKY, J. The working poor and what GIS reveals about the possibilities of public transit. **Journal of Transport Geography**, v. 18, n. 2, p. 226–237, mar. 2010.

RYBARCZYK, G.; GALLAGHER, L. Measuring the potential for bicycling and walking at a metropolitan commuter university. **Journal of Transport Geography**, v. 39, p. 1–10, 2014.

RYBARCZYK, G.; WU, C. Bicycle facility planning using GIS and multi-criteria decision analysis. **Applied Geography**, v. 30, n. 2, p. 282–293, 2010.

RYSTAM, A. **Bicycle as a local feeder to regional public transport**. European Transport Conference 1996. **Anais...1996**

SCHEINER, J. Social inequalities in travel behaviour: Trip distances in the context of residential self-selection and lifestyles. **Journal of Transport Geography**, v. 18, n. 6, p. 679–690, 2010.

SCHWANEN, T.; DIELEMAN, F. M.; DJIST, M. Travel behaviour in Dutch monocentric and policentric urban systems. **Journal of Transport Geography**, v. 9, n. 3, p. 173–186, set. 2001.

SETRANS-RJ. PTDU Pesquisas de Origem e Destino – Parte 2: Análise dos Resultados da Pesquisa Domiciliar. 2013.

SETRANS/RJ. PDTU Pesquisas de Origem e Destino – Parte 2: Análise dos Resultados da Pesquisa Domiciliar. 2013.

SETRANS/RJ. **Minuta do Relatório 4 – Planejamento e Execução das Pesquisas: Parte 3: Diagnóstico da Situação Atual**. [s.l: s.n.].

SMAC; COPPE. **INVENTÁRIO DAS EMISSÕES DE GASES DE EFEITO ESTUFA DA CIDADE DO RIO DE JANEIRO EM 2012 E ATUALIZAÇÃO DO PLANO DE AÇÃO MUNICIPAL PARA REDUÇÃO DAS EMISSÕES - Resumo Técnico**. Rio de Janeiro: [s.n.].

SMART, M. US immigrants and bicycling: Two-wheeled in Autopia. **Transport Policy**, v. 17, n. 3, p. 153–159, maio 2010.

STINSON, M.; BHAT, C. Frequency of Bicycle Commuting: Internet-Based Survey Analysis. **Transportation Research Record**, v. 1878, n. 512, p. 122–130, 2004.

TIWARI, G. Urban Transport Priorities: Meeting the Challenge of Socio-economic Diversity in Cities, a Case Study of Delhi, India. **Cities**, v. 19, n. 2, p. 95–103, 2002.

TRAIN, K. **Discrete Choice Methods with Simulation**. [s.l.] Cambridge University Press, 2003.

UN HABITAT. **Global Report on Human Settlements: Cities and Climate Change**. London, Washington DC: [s.n.].

VAN EXEL, N. J. A.; RIETVELD, P. Could you also have made this trip by another mode? An investigation of perceived travel possibilities of car and train travellers on the main travel corridors to the city of Amsterdam, The Netherlands. **Transportation Research Part A: Policy and Practice**, v. 43, n. 4, p. 374–385, maio 2009.

VAN WEE, B. Land use and transport: research and policy challenges. **Journal of Transport Geography**, v. 10, n. 4, p. 259–271, dez. 2002.

VASCONCELLOS, E. A. **Transporte urbano, espaço e equidade: análise das políticas públicas**. 2a edicao ed. Sao Paulo: Annablume Editora, 2001.

WALKER, J. L. **Extended Discrete Choice Models : Integrated Framework , Flexible Error Structures , and Latent Variables**. [s.l.] Massachusetts Institute of Technology, 2001.

WU, B.; HINE, J. A PTAL approach to measuring changes in bus service accessibility. **Transport Policy**, v. 10, n. 4, p. 307–320, out. 2003.

YÁÑEZ, M. F.; RAVEAU, S.; ORTÚZAR, J. D. D. Inclusion of latent variables in Mixed Logit models: Modelling and forecasting. **Transportation Research Part A: Policy and Practice**, v. 44, n. 9, p. 744–753, nov. 2010.

ZIARI, H.; KHABIRI, M. M. Applied Gis software for improving pedestrian & bicycle safety. **Transport**, n. January 2014, p. 37–41, 2010.

ANEXO A

Questionnaire applied to the sample

Are you going to work or study now?

- a. Study
- b. Work

1. Which mode do you use to get to this bus stop/station?

- a. Bicycle
- b. Walk
- c. Bus
- d. Informal
- e. Car (driver)
- f. Car (passanger)
- g. Other _____

2. Where do you park your bicycle?

- a. Private parking
- b. In the station
- c. On the street
- d. Public parking

3. Why do park there?

- It is safe
- It is for free
- It is the only place available
- It is close to the station
- Other _____

4. How much do you pay for it??

- a. Nothing
- b. R\$ 0,01 – R\$0,50
- c. R\$ 0,51 – R\$1,00
- d. R\$ 1,01 – R\$1,50

e. + R\$1,51

5. Which line? _____

6. Where did you take this bus? ____

7. Why did you choose this mode?

- It is cheaper
- It is faster
- it is my only option
- it is more comfortable
- it is healthy
- it is relaxing
- I am completely independent
- I don't have to wait for the bus
- I don't have to walk to the bus stop
- The stop is close to my home
- High frequency
- Outro: _____

8. Have you ever thought of coming to this station/stop by bicycle?

- a. Yes
- b. No

9. What are the main problems in cycling to the bus stop/station?

- the drivers don't respect the cyclists
- the quality of the road is too bad
- when it is raining/warm it is not comfortable

- when it is hilly on the way it is not good
- you get to expose to violence on the way
- no free parking
- risk of bicycle theft when parking
- there is no parking close to the stop/station
- it takes too long to park the bicycle
- I don't have to walk to the bus stop (feeder bus)
- Outro: _____

10. What could make you cycle? (ONLY FOR NON-BICYCLE)

- if I had facilities to buy a bicycle
- separate cycleway
- if I felt safer on the way
- if there was a safe parking
- if there was free parking
- if there was a parking close to the stop/station
- if I had facilities on my work to take a shower
- if I could the the bike with me in the train/bus/metro
- nothing, I would never cycle

11. Why do choose this bus stop/station?

- it is the only one possible
- it is the closest to my home
- it is the safest
- because of the bicycle parking facilities here
- because it is the terminal stop and I can seat in the bus/train/metro

- because I have more options here
- Other: _____

12. Why are you taking this bus/train/metro?

- it is the only option
- it is faster
- it is cheaper
- it is more comfortable
- it is safer
- I don't have to change modes
- it is the closest to my home
- it is the closest to my job/school
- I don't have to wait too much (high frequency)
- Other: _____

13. Where do you leave this mode?

14. Do you take another mode after this train/metro/bus?

- a. No
- b. Yes

15. Which?

- a. Bus
- b. Informal
- c. Metro
- d. Train

16. Where? _____

17. Where do you leave this mode? _____

18. Why do you take this mode?

- it is the only possible combination
- it is the cheapest combination
- it is the fastest combination
- it is the combination with fewer changes

- other: _____

19. Could you have made this trip differently?

- a. No
- b. Yes

20. How?

AM	MM	OM	OM	OM

21. Why you haven't?

- it is more expensive
- the journey takes longer
- the stop/station is further from my house
- the stop/station is more dangerous
- it is more uncomfortable
- I'd have to change more times
- I have to walk longer to my work
- I have to wait too long (low frequency)

22. Gender?

- a. Male
- b. Female

23. How old are you? _____

24. Monthly income? (in portuguese the responses are in Reais)

- a. Up to 1 MW
- b. 1 – 2 MW
- c. 2 – 3 MW
- d. 3 – 4 MW
- e. 4 – 5 MW
- f. + 5 MW

25. Do you owe a car?

- a. Yes > go to Q56
- b. No

26. Do you have access to a car?

- a. Yes
- b. No

27. Do you owe a bicycle?

- a. Yes
- b. No

28. Do you have access to a bicycle?

- a. Yes
- b. No

29. Do you know how to cycle?

- a. Yes
- b. No

Where do you live?

Where do you work/study?
