



SINTEK JURNAL: Jurnal Ilmiah Teknik Mesin
ISSN: 2088-9038, e-ISSN: 2549-9645

Homepage: <http://jurnal.umj.ac.id/index.php/sintek>



MODIFICATION OF DIGITAL OIL PRESSURE MEASUREMENT EQUIPMENT USING BLUETOOTH TECHNOLOGY

Rasma^{1,*}, Thomas Junaedi², Hendro Purwono³, Riki Efendi⁴

^{1,2,3}Program Studi D3 Alat, Berat Fakultas Teknik, Universitas Muhammadiyah Jakarta

⁴Program Studi Teknik Mesin, Fakultas Teknik, Universitas Muhammadiyah Jakarta
Jln. Cempaka Putih Tengah 27 Jakarta, DKI Jakarta, Indonesia

*E-mail: rasma@ftumj.ac.id

Accepted: 22-10-2019

Revised: 18-11-2019

Approved: 01-12-2019

ABSTRACT

PT United Tractors Tbk Jakarta workshop held a lot of Machine Inspection Programs for Komatsu units. During the implementation of the Machine Inspection Program (PPM) the machine inspection program is one part of the maintenance that is carried out periodically to obtain accurate data on the condition of the equipment at the time by carrying out checks and adjustments using measurement methods and diagnostic instruments. The use of a pressure gauge is still using manual and has a measurement distance that is still limited, if workers or mechanics are not equipped with sufficient knowledge then the pressure gauge will have the potential for error in use and the selection of a pressure gauge is not appropriate to the pressure gauge directly connected to the hydraulic pressure through the hose then the work process ppm is not enough 1 manpower. Therefore it is necessary to modify a digital pressure gauge that has a wide range of scales, in addition a wireless connection is needed to enable the operation of the unit and measurements are made 1 manpower and Bluetooth is one of the right choices in addition to the reach can be met in an application not too difficult so that readings measurement results can be connected directly via mobile.

Keywords: Pressure gauge, Hydraulic, Hydraulic oil.

1. INTRODUCTION

One unit of heavy equipment that is quite widely used in the mining area is the Excavator type. This type of unit is widely used in the construction and mining industry sectors. The machine inspection program is one part of the maintenance that is carried out periodically to get accurate data on the condition of the equipment at the time by carrying out checks and adjustments using measurement methods and diagnostic instruments. When oil pressure measurement tools used are standard pressure gauge still using manuals and have a measurement distance that is still limited, if workers or mechanics are not equipped with

sufficient knowledge then the pressure gauge will potentially lead to errors and the selection of a pressure gauge is not according to the standard, this will cause the pressure gauge to be inaccurately read when doing PPM work, there can be damage to the pressure gauge, the pressure gauge is directly connected to the hydraulic pressure through the hose so the PPM work process is not enough for one manpower [1].

Therefore it is necessary to modify a digital pressure gauge that has a wide range of scales. In addition, a wireless connection is needed to enable the operation of the unit and measurements are carried out one manpower

and Bluetooth is one of the right choices in addition to the reach can be met in an application not too difficult so that readings measurement results can be connected directly via mobile so that it makes it easier for the monitoring process to accelerate the process of the machine inspection program.

The machine inspection program is a part of the treatment that is carried out periodically to obtain accurate data on the condition of the equipment at the time by carrying out checks and adjustments using diagnostic measurement methods and instruments [2].

2. METHODS

2.1. Tools and Materials

a. Tools Hydraulic Measurement

A pressure gauge group is used to measure oil pressure, tire air pressure, and fuel pressure. The unit of measurement on the pressure gauge uses PSI (Pounds Per Square Inch), Kpa (Kilo Pascal) and kg / cm². Where in the measurement must use a gauge that has a scale above the pressure to be measured so that the gauge does not occur due to overload. In the pressure gauge group there are several gauges of various sizes, namely 1500 mmHg, 10 kg/cm², 25 kg/cm², 60 kg/cm², 400 kg/cm², and 600 kg/cm².



Figure 1. Pressure Gauge Group [3]

b. Bluetooth

A wireless technology device that can connect multiple devices via low-frequency radio waves. Bluetooth facilitates the connection and exchange of information between devices such as cellphones, laptop computers, printers, and digital cameras through

short-range radio frequencies. The Bluetooth functions as a liaison between the pressure gauge that is a tool modification with the process of reading the measurement results directly via mobile phones. The Bluetooth has a range of 30 m, [4].



Figure 2. Bluetooth [4]

c. Arduino

Arduino is an opensource single-board microcontroller, designed to facilitate the use of electronics in various fields. The hardware has an Atmel AVR processor and the software has its own programming topics such as the Arduino IDE (Integrated Development Environment).

Arduino has 14 digital input/output pins (of which 6 pins can be used as PWM outputs), a USB power jack connection and a reset button. Arduino Uno has a number of facilities for communicating with other computers or microcontrollers, as I will discuss with wireless-based serial communication found on pin 0 (RX) and pin 1 (TX).



Figure 3. Arduino [4]

d. Liquid Crystal Display (LCD)

The LCD screen is a data display media that is very effective in its use. To display a character on the LCD screen requires some additional series. To make it easier for electronic users to create an LCD module.

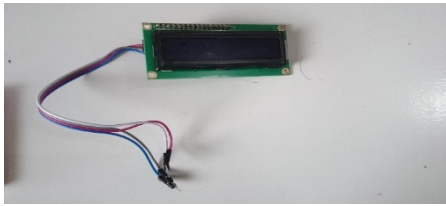

Figure 4. LCD [4]

2.2. Targeting

The target in this problem is the creation of a tool that can improve the effectiveness of manpower and safety better so that what has been determined by PT United Tractors can really be achieved properly and the creation of efficiency from the manpower itself.

a. Value To Improve

- Ease of selecting Pressure Gauge.
- Ease of use Pressure Gauge range scale with all sizes

b. Target

- Reduces potential damage to the Pressure Gauge.
- When measurement is more economical.

c. Theme

Modification of digital pressure gauges by using bluetooth technology.

2.3. Fishbone Diagram

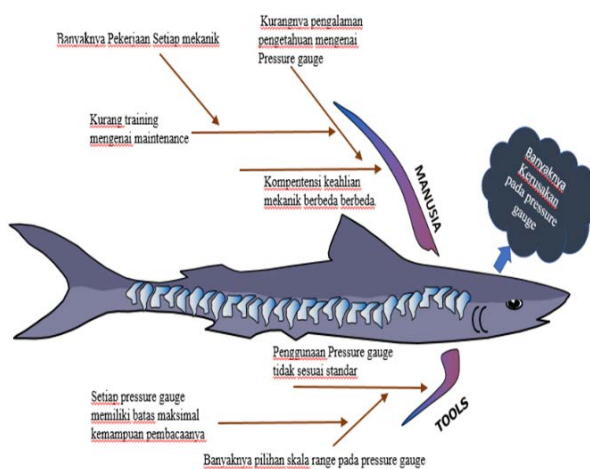

Figure 5. Fishbone Diagram [6]

Based on the fishbone diagram in figure 5 and 6, in carrying out the work of the Machine Inspection Program process, the amount of damage to the pressure gauge (Human) due to the competence of mechanical expertise varies due to the lack of experience regarding the pressure gauge due to lack of maintenance training due to the amount of work of each mechanic. (Tools) often the use of pressure gauge is not according to the standard because of the many choices of the scale range on the pressure gauge because each pressure gauge has a maximum reading capability.

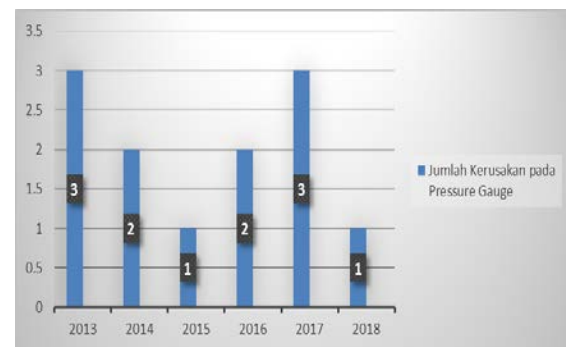

Figure 6. Pressure Gauge Damage Diagram.

2.4. Research Methodology

Research carried out in the manufacture of tools for measuring oil pressure digital by utilizing bluetooth technology using seven-up ++ innovation, [1,7].

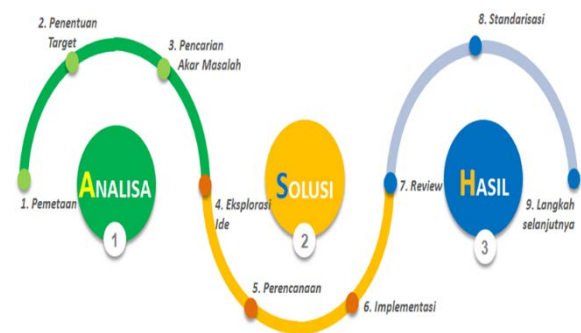

Figure 7. Flow chart seven up ++ innovation [7]

Seven-Up ++ is a reference in innovating. It is intended that innovations become more organized, easily monitored, and recorded

properly so that they can facilitate innovation and the results of these innovations can be used as a solution while doing the same process.

Modification Design Concepts Digital pressure gauges utilizing bluetooth technology.

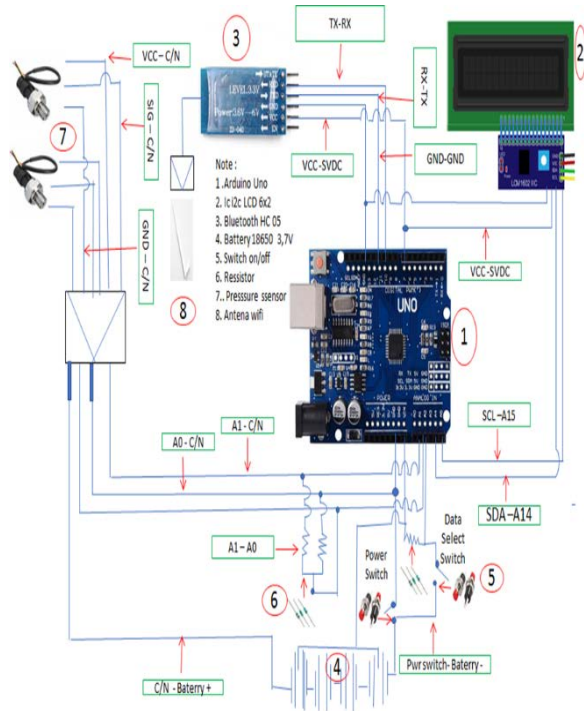

Figure 8. Modified Wiring Design Tool

2.5. Programming

Arduino Programming aims to give commands to Arduino in order to process input and produce output in accordance with what has been described. Arduino programming is done with the help of a computer with the Arduino IDE (Integrated Development Environment) application.

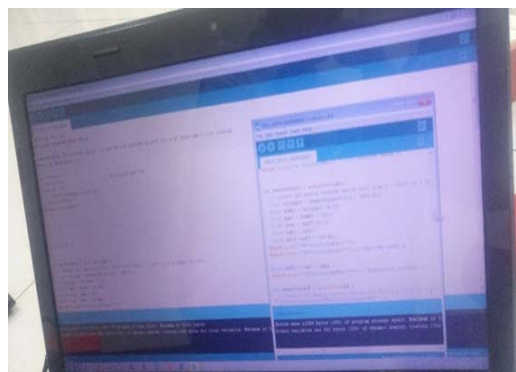







Figure 9. Arduino IDE Programming

After programs are written and there are no errors in it means the program is ready to upload. To find out if the program error or not, can be seen by clicking the verify button. The following is an explanation of a few buttons on the IDE.

Table 1. Menus and Functions of the Arduino IDE

Button	Name	Function
	<i>Verify</i>	Test whether there are errors in the program or sketch. If the sketch is correct, it will be compiled. The compilation is the process of changing program code in machine code.
	<i>Upload</i>	Send a compiled machine code to the Arduino board.
	<i>New</i>	Make a new page sketch or worksheet.
	<i>Open</i>	Function to open an existing work page.
	<i>Save</i>	Function to save the work page.
	<i>Serial Monitor</i>	Displays data sent and received through serial communication.

To upload a program. First, connect the Arduino USB to the computer. After the Arduino serial port is detected by the computer, the Arduino is ready to upload the program. After uploading the program, enter Bluetooth settings.

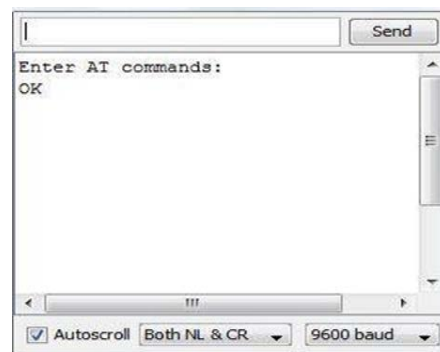

Figure 10. Bluetooth settings in Arduino IDE

The materials and tools needed to make are as follows:

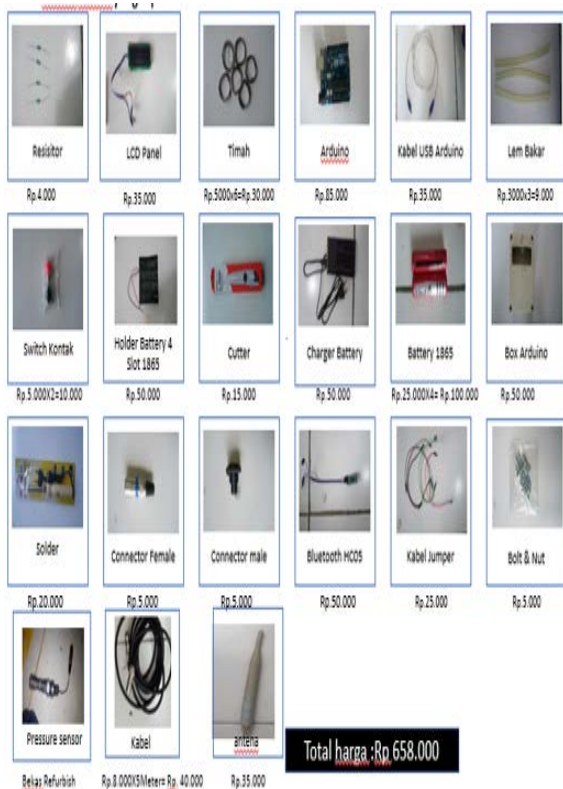

Figure 11. Tools and Materials

The total cost needed to make the modification of a digital pressure gauge utilizing Bluetooth technology is Rp. 658,000.

2.6. Tool Making

Following is the process of making the modification of a digital pressure gauge utilizing Bluetooth technology.

2.7. Test Tool

Test the Bluetooth Digital Pressure Gauge tool on the Hydraulic Pump PC 400 LC-8 by installing the Hydraulic Pump check port coupler.

The trial was conducted in accordance with the Standards of measurement contained in the PPM Check sheet in the hydraulic pump area, namely when the Engine Speed is high idle (1900 rpm) and when the Engine Speed is High Idle. Arm Out Relief, 343 kg/cm² front Pump and Arm Out Relief, Rear Pump 344 kg/cm²

which in writing the unit in writing PPM check sheet is the kg/cm² unit.

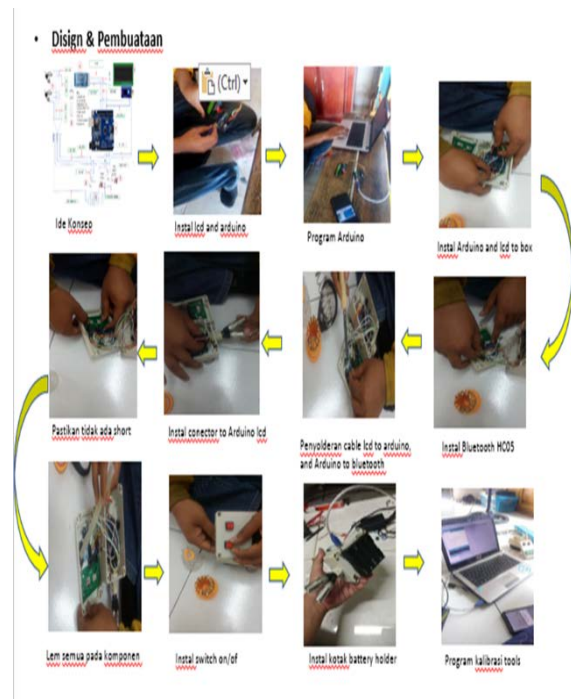

Figure 12. Tool Making Steps

3. RESULTS AND DISCUSSION

3.1. Process Comparison

After an improvement has been made in the measurement process, by using the Modification Tool for digital pressure measuring devices utilizing Bluetooth technology, it can be seen the difference before and after the repair.

a. Before

From observations made by researchers during the PPM process using a pressure gauge in general.



Figure 13. The reading process before improvement.

b. After

After implementing the application using improvement in the PPM process by making Modifications of pressure gauges using Bluetooth technology, the quality will be faster and safer.



Figure 14. The process of reading the measurement results after improvement

3.2. Saving Cost Comparison

After modification of the tool on the previous measuring tool, the Modification tool is expected to reduce the use of manpower, secure and prevent damage to the measurement results reader. Where the Income from the service implementation of the Machine Inspection Program (PPM) is only Rp. 4,500,000.

a. Before the Modification Tool

3 hour job estimation
 = 3 x 27 \$ per hour
 = 3 x (27x14.270)
 = Rp. 1.155.870,-

b. After the Modification Tool

Work Estimation save 2 hours
 = 2x 27 \$ per hour
 = 2x (27x14.270)
 = Rp.770.530,-

So, the benefits are Costs 1x PPM - (Costs Before the existence of Tool Improvement - Costs After the Tools Improvement).







= Rp. 4.500.000 - (Rp. 1.155.870 – Rp. 770.530)
 = Rp. 4.500.000 - Rp. 385.340
 = Rp. 4.114,660-

3.3. Standardization



After repairs, testing and implementation, it is necessary to standardize or standard operating procedures (SOP) of this tool. Here is the standardization of these tools:

	STANDARISASI PROSEDUR PENGOCCOKAN BLUETOOTH DIGITAL PRESSURE GAUGE		No. Doc: _____																																	
	Indra Pujitrisnana Manajemen		Uk. Ekuival: _____																																	
		Manajemen	Revisi: _____																																	
		Manajemen	Revisi: _____																																	
<p>Tujuan:</p> <ol style="list-style-type: none"> menjadi acuan apabila akan dilakukan pemasangan modifikasi selanjutnya menjadi acuan apabila akan dilakukan pemeliharaan modifikasi selanjutnya <p>Daftar Isi:</p> <p>Standardisasi ini dibuat agar menjadi acuan dalam melakukan hal yang berkaitan pada lubricating oil pressure pada proses pengecekan per clinic yang yang dibutuhkan serta proses pemasangan modifikasi bluetooth digital pressure gauge pada unit KOLATSI</p> <p>Bahan yang dibutuhkan:</p> <table border="0"> <tr> <td>1. antenna sma : 1 pcs</td> <td>9 Switch break : 1 pcs</td> <td>17 label jumper : 1 Amp</td> </tr> <tr> <td>2. Resistor : 1pc</td> <td>10 Termal : 1 pcs</td> <td>18 Switch break : 1 pcs</td> </tr> <tr> <td>3. led : 1 pcs</td> <td>11 Charger battery : 1 pcs</td> <td>19 Antena : 1 pcs</td> </tr> <tr> <td>4. baterai : 1 pcs</td> <td>12 Chip antenna : 1 pcs</td> <td>20 lens balok : 1 pcs</td> </tr> <tr> <td>5. label sub antenna : 1 pcs</td> <td>13 bolt end nut : 1 pcs</td> <td>21 cover : 1 pcs</td> </tr> <tr> <td>6. holder battery : 20 pcs</td> <td>14 connector male : 1 pcs</td> <td></td> </tr> <tr> <td>7. Kabel : 10 meter</td> <td>15 connector female : 1 pcs</td> <td></td> </tr> <tr> <td>8. bluetooth module : 1 pcs</td> <td>16 nutler : 1 pcs</td> <td></td> </tr> </table> <p>Alat yang dibutuhkan:</p> <table border="0"> <tr> <td>1. Crimp pliers</td> <td>5. Kain Api</td> </tr> <tr> <td>2. Crimp pliers</td> <td>6. Obeng</td> </tr> <tr> <td>3. Avo meter</td> <td></td> </tr> <tr> <td>4. Drilling machine</td> <td></td> </tr> </table>					1. antenna sma : 1 pcs	9 Switch break : 1 pcs	17 label jumper : 1 Amp	2. Resistor : 1pc	10 Termal : 1 pcs	18 Switch break : 1 pcs	3. led : 1 pcs	11 Charger battery : 1 pcs	19 Antena : 1 pcs	4. baterai : 1 pcs	12 Chip antenna : 1 pcs	20 lens balok : 1 pcs	5. label sub antenna : 1 pcs	13 bolt end nut : 1 pcs	21 cover : 1 pcs	6. holder battery : 20 pcs	14 connector male : 1 pcs		7. Kabel : 10 meter	15 connector female : 1 pcs		8. bluetooth module : 1 pcs	16 nutler : 1 pcs		1. Crimp pliers	5. Kain Api	2. Crimp pliers	6. Obeng	3. Avo meter		4. Drilling machine	
1. antenna sma : 1 pcs	9 Switch break : 1 pcs	17 label jumper : 1 Amp																																		
2. Resistor : 1pc	10 Termal : 1 pcs	18 Switch break : 1 pcs																																		
3. led : 1 pcs	11 Charger battery : 1 pcs	19 Antena : 1 pcs																																		
4. baterai : 1 pcs	12 Chip antenna : 1 pcs	20 lens balok : 1 pcs																																		
5. label sub antenna : 1 pcs	13 bolt end nut : 1 pcs	21 cover : 1 pcs																																		
6. holder battery : 20 pcs	14 connector male : 1 pcs																																			
7. Kabel : 10 meter	15 connector female : 1 pcs																																			
8. bluetooth module : 1 pcs	16 nutler : 1 pcs																																			
1. Crimp pliers	5. Kain Api																																			
2. Crimp pliers	6. Obeng																																			
3. Avo meter																																				
4. Drilling machine																																				

(a)

Prosedur Pemrograman Bluetooth Digital Pressure Gauge		
No	Langkah pemrograman	Gambar
1	instal battery on box digital pressure gauge	
2	aktifkan sensor	
3	instal sensor	
4	penyalaan sensor on, select data log on the PG	
5	monitor digital pressure gauge	
6	instal tool and connector adapter pressure sensor	

(b)

7	aktifkan Bluetooth	
8	Download aplikasi Emsa Soft Bluetooth Connector dan USB Appliance tool kit	
9	load sensor pada pressure gauge	
10	Connect Bluetooth	
11	aktifkan konfigurasi yang diinginkan	
12	aktifkan Manual pressure gauge yang diinginkan	

(c)

Figure 15. Standard Operational Procedure (SOP) Tool Modification

4. CONCLUSION

With the improvement of making modifications to the digital pressure gauge with the use of Bluetooth technology in the process of the Machine Inspection Program.

Able to reduce the potential pressure gauge damage by 7 pressure gauge after it was applied and until now in 2019 there was no damage. More safety in measuring pressure with a wider range of scales. Easy to read Digital Pressure Gauge measurement results. Connecting tools with Bluetooth and opening measurement results via mobile phones. Lead time efficiency can be realized from 3 hours manpower to 2 hours manpower.

REFERENCES

- [1] Rasma., Purwono, H., Effendi, R., Analisis Perancangan Alat Khusus untuk Pemasangan Suspensi Belakang pada Unit HD785-7, SINTEK JURNAL: Jurnal Ilmiah Teknik Mesin, 2018; 12: 79-86.
- [2] Rasma., Purwono, H., Effendi, R., Perancangan Alat Bantu untuk Proses Penggantian Track Shoe Pada Unit Excavator PC200-8, Jurnal POLIMESIN, 2019; 17: 33-40.
- [3] Effendi, R and Faozan, F, Modifikasi Konstruksi Dies Lever Comp Brake Motor Matik untuk Meningkatkan Kapasitas Proses Produksi, FLYWHEEL: Jurnal Teknik Mesin Untirta, 2017; 3: 20-23.
- [4] Diesel Engine (BMC-1), Training Center PT United Tractors Tbk, Jakarta, 2011.
- [5] Hydraulic System, Basic Mechanic Course 1, Training Center PT United Tractors Tbk, Jakarta, 2011.
- [6] Huzij, R., Spano, A., Bennett, S., Modern Diesel Technology: Heavy Equipment Systems, 2nd Edition, New York: Delmar Cengage, 2014.
- [7] Basic Mechanic Course 1, Training Center PT United Tractors Tbk, Jakarta, 2011.
- [8] Shop Manual PC 400LC-8, Training Center PT United Tractors Tbk, 2006.
- [9] Sharing by Mechanic Site Bengalon, Training Center PT United Tractors Tbk, Jakarta, 2018.
- [10] OMM PC 400LC-8, Training Center PT United Tractors Tbk, Jakarta, 2004.