

Hot Volcanic Soils Field Trip 2 December 2014



Once Despised Now Desired: Innovative Land Use
and Management of Multilayered Pumice Soils in
the Taupo and Galatea Areas,
Central North Island, New Zealand



New Zealand

Society of Soil Science

“Soil Science For Future Generations”

2014 Conference

The University of Waikato, Hamilton

1 – 4 December 2014

Field trip led by David J. Lowe, Megan R. Balks, and Nadia Laubscher

Cover photo

Exhumed soil originally formed on Whakatane Tephra from 5526 ± 145 cal yr BP until its burial (c. 3800 years later) by Taupo Tephra in $AD 232 \pm 10$ (i.e., c. 1782 years before AD 2014). This soil has not been at the land surface for nearly 1800 years. Dug up by farmer Eric Smeith, Whirinaki Road, Galatea area, as part of the Galatea Soil Flipping Project. Steep slopes of Ikawhenua Range form background at right. Photo: D.J. Lowe

Hot Volcanic Soils

Field trip for conference “Soil Science for Future Generations”
New Zealand Society of Soil Science, University of Waikato, Hamilton
Tuesday, 2 December, 2014



**Once despised now desired: innovative land use and
management of multilayered Pumice Soils in the
Taupo and Galatea areas, central North Island,
New Zealand**

Leaders: David J. Lowe¹, Megan R. Balks¹,
and Nadia Laubscher²

¹Earth Sciences, School of Science, University of Waikato, Private Bag 3105, Hamilton 3240
d.lowe@waikato.ac.nz, m.balks@waikato.ac.nz

²DairyNZ, 605 Ruakura Road, Hamilton 3240
nadialaubscher@gmail.com

Hot volcanic soils field trip is sponsored by

Ravensdown Fertiliser Co-operative



With additional support from

Earth sciences group, School of Science, University of Waikato

Landcorp Farming



Bibliographic reference entire guide

Lowe, D.J., Balks, M.R., Laubscher, N. 2014. Once despised now desired: innovative land use and management of multilayered Pumice Soils in the Taupo and Galatea areas, central North Island, New Zealand. Guidebook for field trip “Hot volcanic soils”, New Zealand Society of Soil Science conference “Soil Science for Future Generations”, Hamilton (1-4 December), 85 pp.

Bibliographic reference for part of guide (e.g.)

Palmer, J. 2014. Background and development of rules affecting land use in the Lake Taupo catchment. *In*: Lowe, D.J., Balks, M.R., Laubscher, N. Once despised now desired: innovative land use and management of multilayered Pumice Soils in the Taupo and Galatea areas, central North Island, New Zealand. Guidebook for field trip “Hot volcanic soils”, New Zealand Society of Soil Science conference “Soil Science for Future Generations”, Hamilton (1-4 December), pp. 41-45.

Note

Some material in this guide is unpublished and the authors should be consulted for permission before citing or reproducing for any other publications. Text, photographs, and figures/tables otherwise unattributed are provided by the three named authors and their respective organisations. Ma = millions of years ago; ka = thousands of years ago; BP = before present, ‘present’ being defined as AD 1950 for radiocarbon-derived ages. Radiocarbon (¹⁴C) ages are given in calendar or calibrated (cal) years BP unless noted otherwise, or as calendrical dates (e.g. AD 232). The Holocene encompasses the last 11,700 cal years (Walker et al., 2009).

Introduction: themes and itinerary for “Hot volcanic soils”

In his traverse of the Kaingaroa Plateau from Galatea to Lake Rerewhakaaitu (near Mt Tarawera) in December, 1841, William Colenso wrote of the land as “an interminable succession of dry and barren hills of broken lava, pumice, ashes, and other volcanic matter, where the stunted vegetation was all but quite burnt up with the exceeding heat of the sun’s rays” (Colenso, 1894). Highly siliceous Pumice Soils, comprising about 15% of North Island soils, continued as the sickly poor cousin into the first half of the 20th Century, being described as “land that a few years ago was despised” (Vucetich and Wells, 1978, p. 85) because of ‘bush sickness’ (an animal wasting disease resulting from cobalt deficiency, as well as Se, Cu, B, I, and Mo deficiencies), low fertility, and other problems such as droughtiness, compaction, and erodibility (Vucetich et al., 1960). With research, experience, understanding, and improvements, however, the soils eventually became widely desired, so much so that by the 1970s “exotic forestry and agriculture vie for the pumice land, and both are equally important” (Vucetich and Wells, 1978, p. 86). Today we are amidst another period of major change in the use and management of some of our pumice lands and soils, which may be regarded now as highly desirable, maybe even ‘hot’ [volcanic] property!

Our tour brings together innovative land use change and management associated with dairy farming, and land-based effluent disposal, on weakly weathered and multi-layered, glass-rich, Pumice Soils (Vitrandis) in the Taupo and Galatea areas. These changes and their effects, together with environmental and sustainability issues, form a central theme of our trip. Four main stops are planned, two before lunch and two after: (1) plantation pine-to-dairy farm conversion and impacts, the Taupo eruption deposits (AD 232 ± 10) and the Taupo soil, Tahorakuri; (2) overview of the application of secondary-treated wastewater and nitrogen leaching and uptake, Rotokawa; (3) a sequence of five Holocene tephras and buried soils, including Kaharoa eruption deposits (AD 1314 ± 12)* and the Galatea soil, Smeith Farm, Murupara; and (4) enhancing pasture production on ‘new’ soils formed by excavating and mixing (‘flipping’) buried soil horizons (paleosols) on Smeith’s farm.

During the trip – which helps mark Waikato University’s 50th anniversary – we will see a spectacular range of volcanic and fluvial landscapes and deposits, together with impacts of tectonism, as we traverse the famous Taupo Volcanic Zone (TVZ) in the central volcanic region. Landforms and soils dominated by tephras (volcanic ash) become generally younger towards the loci of volcanic activity. Extensive areas of soils have been formed repeatedly from the fragmental eruptive products of the two most frequently active and productive rhyolite (silica-rich) volcanic centres known, namely Taupo and Okataina. Thus soil stratigraphy and upbuilding pedogenesis form a second theme on the trip.

The first part of the guidebook thus contains sections including (i) volcanism and its products, (ii) Quaternary volcanism in TVZ including deposits erupted recently from Taupo and Tarawera volcanoes from which Pumice Soils have been formed, (iii) tephra-derived soils including Pumice Soils, their classification, special problems, and (low) fertility, (iv) allophane and its formation, and (v) the interplay between geological and pedological processes relating to tephras (upbuilding pedogenesis). The second part then comprises notes and illustrations pertaining to each stop (note that figure and table numbers are self-contained at each stop, or not used). Broad overviews of the region’s geology are covered by Leonard et al. (2010), and the soils are outlined by Rijkse and Guinto (2010) and S-map. Further compilations of data are available in tour guides by Lowe (2008) and Lowe et al. (2010).

Although covering considerable distances, we aim to spend about two hours in the morning at stops 1 and 2, and a similar time in the afternoon at (adjacent) stops 3 and 4. Packed lunches will be provided in Taupo and an evening meal in Rotorua. Comfort stops are included. Acknowledgements to the many people who helped contribute to the trip are given at the end of the guidebook (p. 79).

*This year is the septingentenary, or 700th anniversary, of the Kaharoa eruption of Mt Tarawera of AD 1314 (± 12 years). The importance of the eruption and its products are described by Lowe and Pittari (2014).

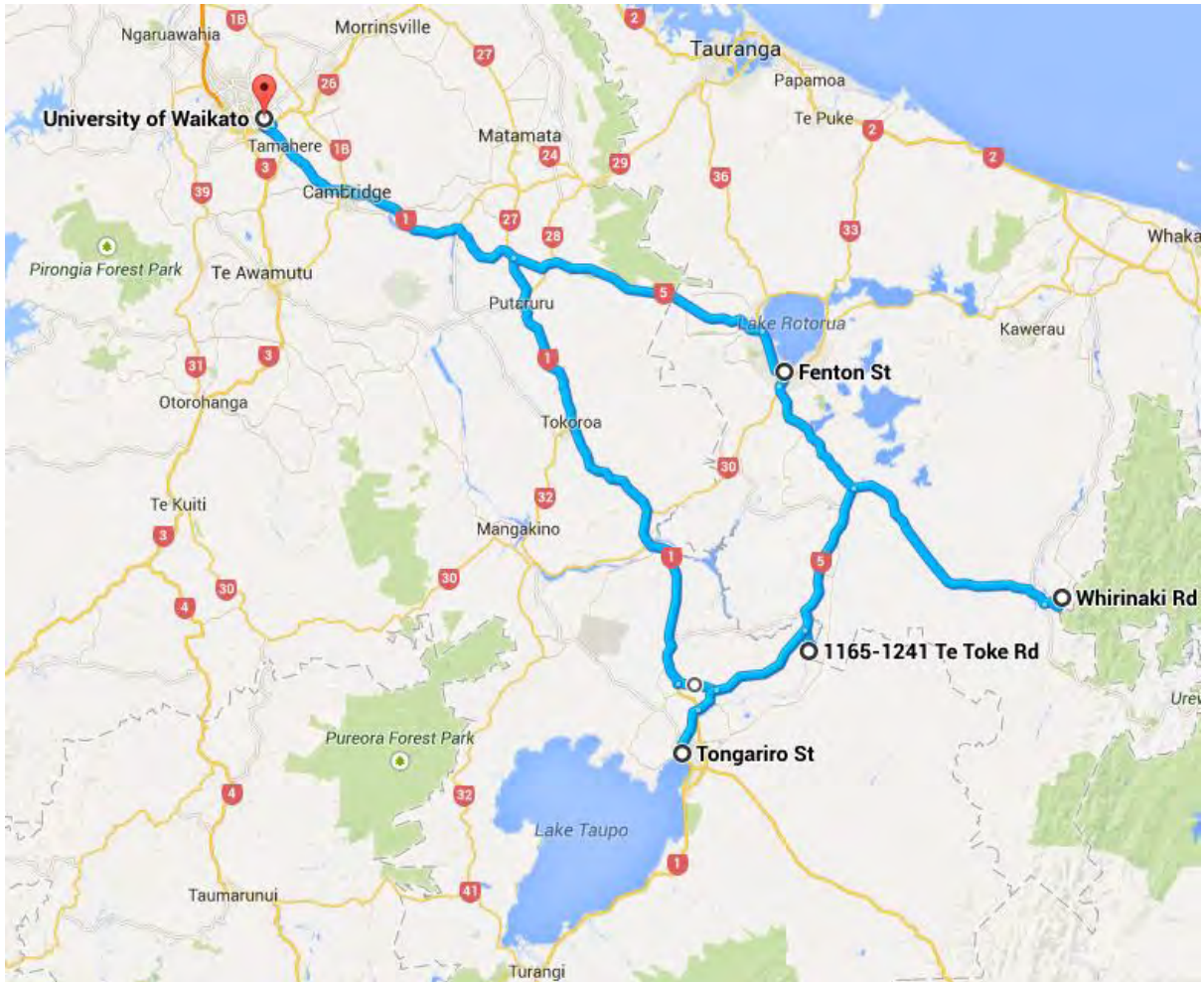

Fig. 1 Regional map showing tour route.



Fig. 2 View northward of forested Kaingaroa Plateau (left) underlain by ignimbrites, and farmland of the Galatea Basin, a tectonic depression in middle distance (our destination for stops 3 and 4) underlain by deposits of Holocene age including at least five tephra beds and older fluvial and fan deposits (from Leonard et al., 2010, p. 11).

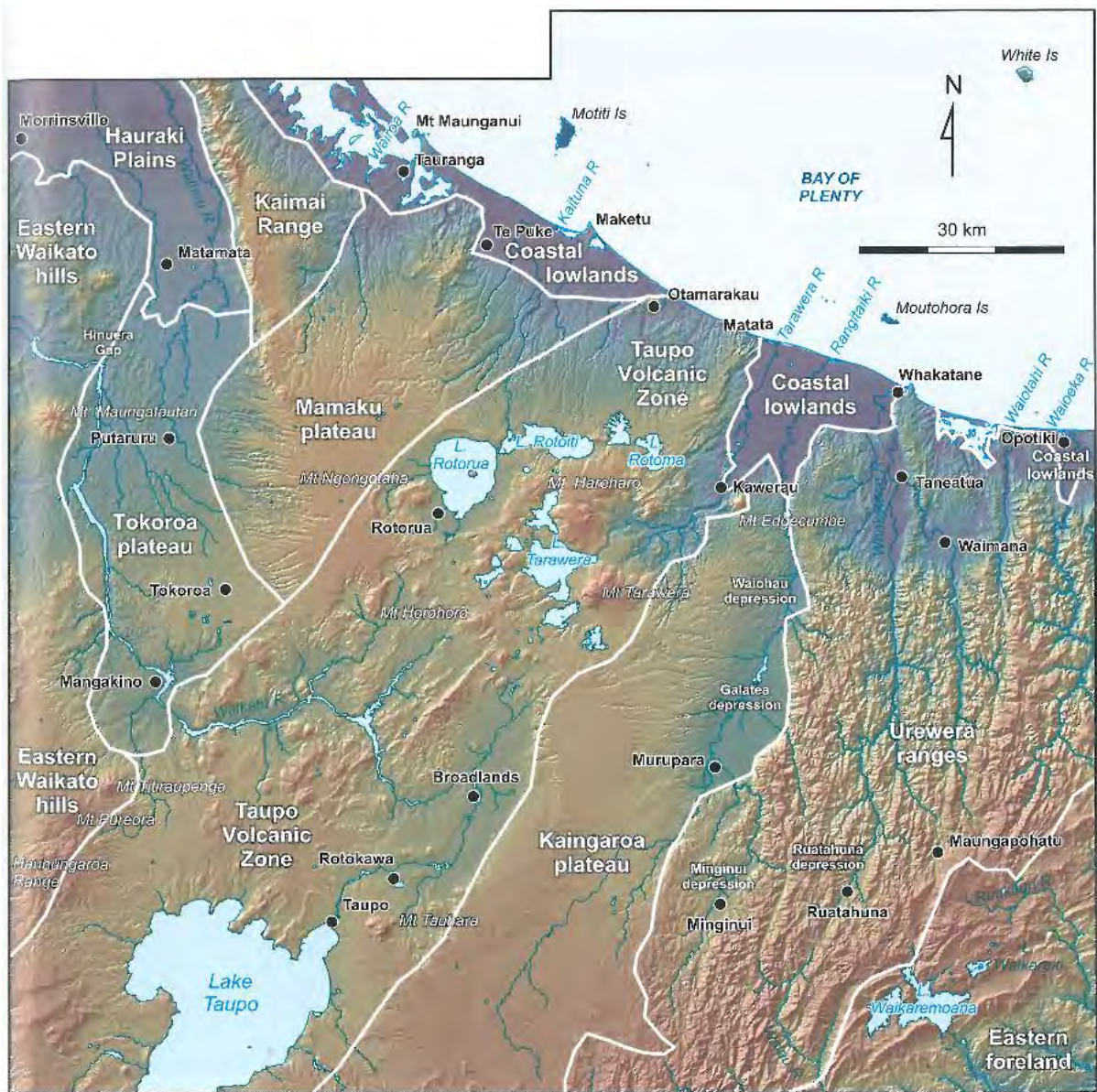

Fig. 3 Topographic relief model illustrating the physiographic regions covered on our trip. The ‘geomorphic’ Taupo Volcanic Zone (TVZ) comprises an area of largely volcanic hills and lakes and covers a similar area (but not exactly equivalent) to the volcanological TVZ (defined by vent locations only) (from Leonard et al., 2010, p. 7).

Itinerary for “Hot volcanic soils”

- 8.00 am Depart from Gate 2a, Knighton Rd (outside Bryant Hall, University of Waikato)
- 8.00-10.00 am Drive Hamilton to Te Toke Rd, Tahorakuri
- 10.00-11.30 am **STOP 1** Pine plantation to dairy farm conversion, Endeavour Farm, Te Toke Rd
Includes morning tea on arrival, toilets, possible walk through milking shed, soil pit
- 10.00-11.00 am
- (i) Allan Bullick: overview of pine-to-dairy conversion, dairy farm management
 - (ii) Jon Palmer: healthy rivers, nutrient budgeting, regulating using Overseer
 - (iii) Megan Balks: changes in C and N after pine-to-dairy conversion
- 11.00-11.30 am
- (i) David Lowe: Taupo sand – soil stratigraphy and profile (soil pit)
 - (ii) Ants Roberts: fertiliser requirements for Pumice Soils
- 11.30-11.45 am Drive Te Toke Rd to View Rd
- 11.45-12.15 pm **STOP 2** Land disposal site at View Rd, Taupo District Council, Rotokawa (30 mins)
- (i) Nicola Hancock: overview of land disposal by TDC, suitability of Pumice Soils
 - (ii) Kevin Sears: site operation and management
 - (iii) Megan Balks: N leaching and uptake from effluent irrigation
- 12.30-1.00 pm **LUNCH** Tongariro St, Taupo
Tongariro South Domain and Riverside Park, toilets available (30 mins)
- 1.00-2.30 pm Drive Taupo to Galatea
- 2.30-2.40 pm Toilets, Galatea War Memorial Hall, Mangamate Rd, Galatea (10 mins)
- 3.00-3.30 pm **STOP 3** Holocene tephra-buried soil section, Smeith’s Farm, Whirinaki Rd (30 mins)
David Lowe: Galatea sandy loam – soil stratigraphy and profile (quarry section)
- 3.45-4.45 pm **STOP 4** Galatea soil flipping project – farming on paleosols, Smeith’s Farm
- 3.45-3.55 pm **4a** Recently flipped soils, ‘new’ admixed soil profile (10 mins)
Eric Smeith: why and how of flipping soils in south Galatea
- 4.00-4.30 pm **4b** DairyTeam soil flipping trials and UoW research (30 mins)
- (i) Bill Adam: quantifying pasture production response and economic return
 - (ii) Nadia Laubscher: readily available water holding capacity, root penetrability
- 4.35-4.45 pm **4c** Exhumed paleosol on Whakatane Tephra growing fodder beet (10 mins)
- 5.00-5.30 pm **REFRESHMENTS**, commemorative Kaharoa cake, Galatea Hall and toilets (30 mins)
- 5.30-6.30 pm Drive Galatea to Rotorua
- 6.30-7.45 pm **DINNER** at Valentine’s Restaurant, Cnr Fenton/Amohau Sts, Rotorua
- 7.45-9.0 pm Drive Rotorua to Hamilton

Introduction to volcanism and its products

Volcanoes are not only conical mountains, but span a very wide range of landforms. A volcano is any landform that results from molten rock (magma) being erupted at the Earth's surface. The size and shape of a volcano reflect how often it erupts, the sizes and types of eruptions, and the composition of the magma it produces. Magmas contain almost all of Earth's known chemical elements but typically they comprise only nine – silicon, oxygen, aluminium, magnesium, iron, calcium, sodium, potassium and titanium – that sum 98% or more by weight. Oxygen and Si together are generally the most abundant elements, making up 48–76 % by weight of most magmas. The chemistry of magma, especially Si content, is important for influencing the way it erupts, and three main magma types, and resulting volcanic rocks, are identified on the basis of their chemical composition. A fourth type, dacite, is usually grouped with andesites but is intermediate between andesite and rhyolite in composition (Smith et al., 2007).

- *Basalt* is rich in Fe and Mg and low in Si and erupts at very high temperatures (~1100–1200 °C) as a very fluid magma. Basalt magma with very little gas cools to form dark black, dense lava, but where magma erupts with lots of gas it cools to form ragged scoria or ash.
- *Rhyolite* magma is rich in Si, K and Na and erupts at temperatures between 700–850 °C as an extremely viscous magma. Rhyolite magma containing lots of gas bubbles cools to form pumice, but if the magma contains little gas it may form obsidian glass.
- *Andesite* (also *dacite*) magma is intermediate in composition and physical properties. Erupting at ~800–1000 °C it is more viscous than basalt, but much less viscous than rhyolite. Andesite magma cools to form dark grey lava if gas-poor or scoria or ash if gas-rich.

Volcanic eruptions vary remarkably in style and size. The smallest may just dust the summit of a volcano with volcanic ash, whereas the largest are capable of creating entirely new landscapes across whole countries. Although there is great diversity of volcanic behaviour, eruptions can generally be classed as one of two broad types – either explosive or effusive (Smith et al., 2007).

Explosive eruptions

Explosive eruptions are caused by gases violently ripping apart and shattering magma into pieces which cool and solidify into pumice (if the magma is rhyolite), scoria (if the magma is andesite or basalt), and volcanic ash (sand and dust-sized fragments mainly of volcanic glass). Explosive eruptions take place in one of two ways. The first involves gas that is contained within the magma at depth. As magma rises to the surface the drop in pressure causes these gases to bubble and expand violently. Close to the surface magma becomes like the foam that explodes out of champagne or a can of fizzy drink when first opened. The second type of explosive eruptions occurs when magma contacts water, either beneath the ground (at an aquifer) or at the land surface (either a lake or the sea). The very high temperature of magma (700–1200 °C) means that it instantly boils the water, causing violent steam explosions, which blow apart the magma, eject liquid water and steam, and rip up the ground containing the water. These types of eruptions are called phreatomagmatic eruptions.

In both types of explosive eruptions, the shattered magma and other rock fragments are carried violently into the air by the uprush of expanding gases, before settling back to the ground to form a pyroclastic (literally 'fiery fragmental') deposit. The more explosive the eruption the more energetic this roaring stream of gas, and the higher the tephra and rock fragments will be carried into the air. The higher the material goes, the further from the volcano it will be blown by the wind, and so there is a close correlation or relationship between the energy of an eruption and how far the eruption products are spread (Smith et al., 2007).

Effusive eruptions

Effusive eruptions occur when magma contains little gas and so cannot behave explosively, but instead quietly extrudes at the surface forming flows of lava. The very fluid basalt lavas can flow long distances forming extensive, almost flat volcanoes, whereas very viscous rhyolite lava piles up around the vent, like toothpaste squeezed from a tube, forming large, steep-sided mounds called domes.

Three different types of volcanoes in North Island

Although North Island's active volcanoes look quite different from one another, all can be grouped into one of three main landform types:

- classic cones or stratovolcanoes (e.g. Mt Taranaki, Mt Ruapehu)
- volcanic fields (e.g. Auckland Volcanic Field, South Auckland Volcanic Field); and
- caldera collapse craters (e.g. Taupo caldera, Haroharo caldera)

Each of these has obvious landforms and the violence and styles of eruptions are unique to each. These differences reflect the type of magma erupted: basalt at the volcanic fields, andesite at the cone volcanoes, and rhyolite at the calderas. During our trip, we will see mainly rhyolitic or dacitic deposits and landforms.

Caldera volcanoes and eruptions

A caldera is a large, deep crater resulting from the caving in of a rhyolite magma chamber. In places the caldera walls can be seen as steep cliffs, but many are difficult to observe in the landscape because they may be filled in with erupted material or covered by water. Calderas have extremely violent origins and form when a vast amount of viscous rhyolite magma, bubbling with gas, erupts explosively from a magma chamber that may only be a few kilometres beneath the ground. During these eruptions, so much magma is erupted that the chamber empties, leaving the ground above it unsupported. This area collapses, dropping like a piston, to form a wide, deep depression. Lake Taupo, the area to the east of Rotorua known as Okataina, and Mayor Island or Tuhua, are three examples of recently active caldera volcanoes in New Zealand. Some older calderas exist in the area between Taupo and Rotorua (see Fig. 5, p.13) and on the Coromandel Peninsula (Smith et al., 2007).

Rhyolite calderas may be active for several hundred thousand years, but large eruptions are rare, with typically thousands of years between events. Caldera collapse is not the only effect on the landscape arising from these large explosive eruptions. Huge quantities of pumice, ash and gas are pumped into the atmosphere, and through a combination of heat and momentum, a roiling column of this material may rise to over 50 km above the caldera. From this height, ash and especially aerosols – gases and tiny drops of acid – can spread around the globe, affecting the world's climate for several years. Closer to the caldera the landscape may be buried by metres of pumice. The most devastating process, however, occurs when this column of material falls back to earth like a fountain, then surges out in all directions from the caldera as a hurricane-like billowing, ground-hugging flow of hot pumice, ash and gas. These pyroclastic flows or 'density currents' can travel over 100 km at the speed of a racing car, leaving behind a layer of volcanic (pyroclastic) debris that might be more than 100 metres deep. Some flows are so hot (600-700 °C) and thick that the ash and pumice fragments weld back together, forming solid rock known as partially or densely welded ignimbrite.

Dome building

Eruptions from rhyolite volcanoes are not always so explosively catastrophic. A small amount of rhyolite magma may remain after a caldera eruption, which is exhausted of all gas and so can only ooze from the volcano slowly, often along the faults and fissures opened up by earlier caldera collapse. The very high viscosity means the silica-rich rhyolite lava will not flow far, and instead, piles up around the vent, like toothpaste squeezed from a tube, to form a steep-sided dome or dome complexes. These domes are prominent landscape features amongst the caldera volcanoes of the TVZ that we

enter southward of Tokoroa. Kaimanawa rhyolite dome is prominent near stop 1 in Te Toke Rd. Mokoia Island and Mt Ngongataha are rhyolite lava domes erupted within Rotorua caldera, and Mt Tarawera comprises a collection of lava domes erupted c. AD 1314 within Haroharo/Okataina caldera.

Defining tephra, ash, and lapilli

'Tephra' comes from a Greek word *tephra* meaning ashes, and is an all-encompassing term for the explosively erupted, loose, pyroclastic (fragmental) products of volcanic eruptions (Lowe, 2011). It includes all grain sizes ranging from the finest dust to blocks the size of sofas. 'Ash' is not a burnt residue. Rather, it consists of particles <2 mm in diameter including rock particles (lithics), pumice, mineral grains (crystals), and glass shards. Grains 2–64 mm in size are called lapilli (lapillus for single grain), and particles >64 mm are called blocks if they are sharp and angular in shape, or bombs if they are partly rounded or smooth in shape. Derivative terms based on the word 'tephra' are defined in Table 1 (note that the letter 'o' becomes the connecting letter, replacing 'a' of tephra).



Table 1 Tephra-related nomenclature in brief (from Lowe, 2011).

Term	Definition
Tephra	All the explosively-erupted, unconsolidated pyroclastic products of a volcanic eruption (Greek <i>tephra</i> , 'ashes')
Cryptotephra	Tephra-derived glass-shard or crystal concentration, or both, preserved in sediment (including ice) or soil and not visible as a layer to the naked eye (Greek <i>kryptein</i> , 'to hide')
Tephrostratigraphy	Study of sequences of tephra layers and associated deposits, their distribution and stratigraphic relationships, and their relative and numerical ages. Involves defining, describing, characterizing, and dating tephra layers in the field and laboratory
Tephrochronology (sensu stricto)	Use of tephra layers as isochrons (time-parallel marker beds) to connect and synchronize sequences and to transfer relative or numerical ages to them using stratigraphy and other tools. An age-equivalent dating method
Tephrochronology (sensu lato)	All aspects of tephra studies and their application
Tephrochronometry	Obtaining a numerical age or date for a tephra layer

Quaternary volcanism in TVZ

The highest concentration of Quaternary volcanic activity in New Zealand occurs in the TVZ. This narrow band of cone and caldera volcanoes extends from Ruapehu in the south, over 240 kilometres to Whakaari (White Island) in the north, with the Taupo, Okataina, Rotorua and other calderas nestled between. Some of the planet's largest and most violent volcanic eruptions have occurred from this zone, as well as New Zealand's most recent small eruptions (Ruapehu 1995-1996, Whakaari 2000, Te Maari craters on Tongariro 2012). Volcanism occurs in the TVZ, and at Taranaki, because of subduction of the Pacific tectonic plate beneath the North Island (Fig. 4). As this plate descends and is heated, water and other fluids are boiled off and stream into the mantle rocks under the North Island. These fluids cause chemical changes that enable the otherwise solid rock of the mantle to melt, forming basaltic magma. This magma rises until, because of its higher density, it gets trapped underneath the continental crust of the North Island. Here the very hot basalt magma acts like a gigantic blow-torch, melting the crust and mixing with it to form andesite magma, which is then erupted as cone volcanoes. Where enough melting of the continental crust occurs, rhyolite magma forms, generating caldera volcanoes (Smith et al., 2007).

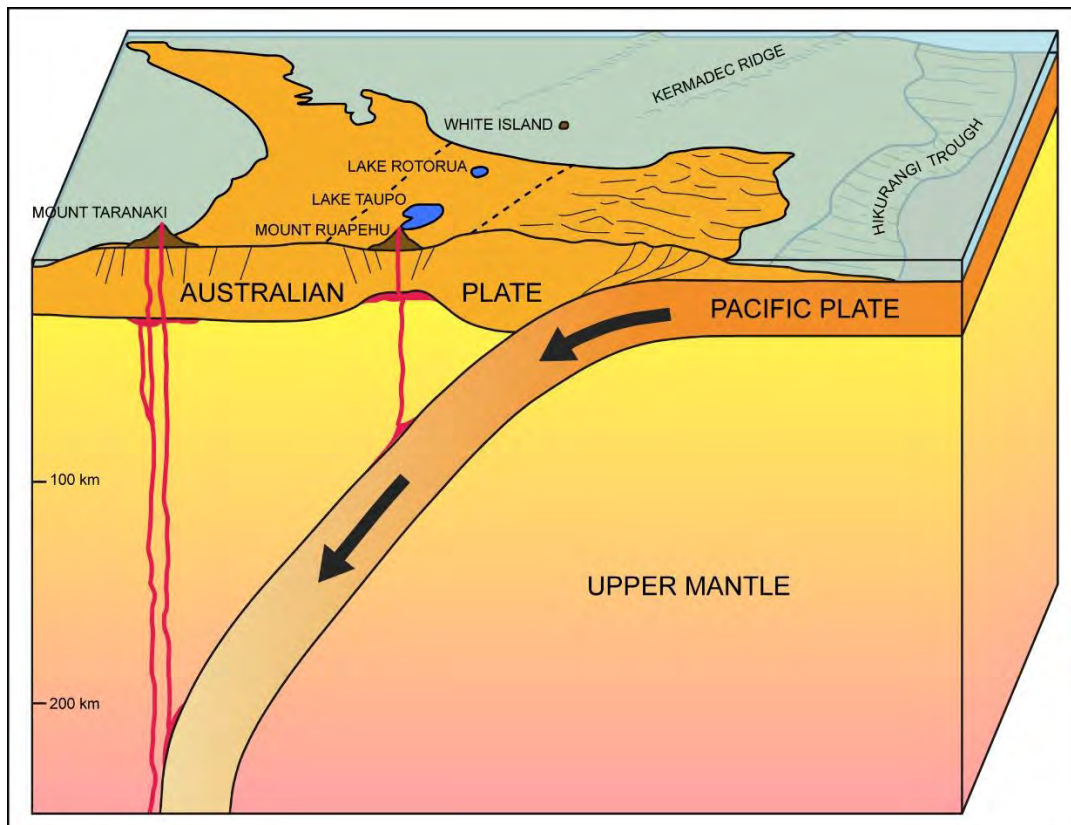

Fig. 4 Simplified North Island plate tectonic setting (diagram courtesy of Adrian Pittari).

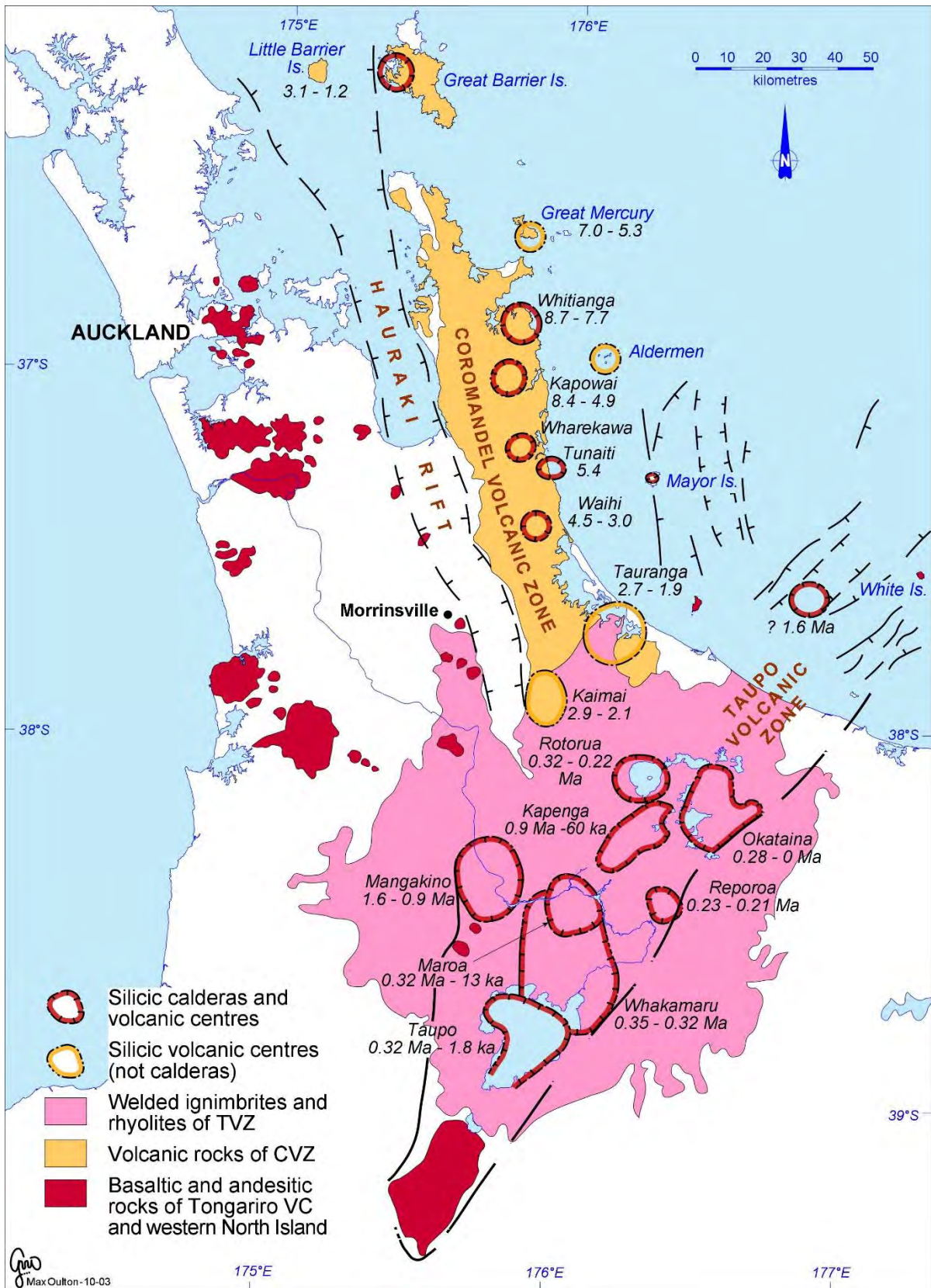

Fig. 5 Volcanic centres and the ages of activity and rocks (including welded ignimbrites) of central North Island. Newly recognised Ohakuri caldera is not shown and Maroa (infilled with many domes) is now considered a volcanic centre rather than caldera. Diagram courtesy of Roger Briggs (after Briggs et al., 2005).

TVZ

The TVZ comprises three distinct parts (Fig. 5; Wilson et al., 2009). A southern part, dominated by andesite cones, includes the active Ruapehu and Tongariro volcanoes and the probably extinct Pihanga and Tihia-Kakarama cones. A northern part, which is also dominated by andesite stratovolcanoes, includes the active Whakaari (White Is.) and mid-Holocene Putauaki (Edgecumbe), and the much older, deeply eroded cones of Motuhora (Whale Is.) and Manawahe. These two stratovolcano clusters book-end the third and largest central part of the zone, extending from Turangi north to the Rotorua lakes district. This area is dominated by rhyolite calderas, including the highly active Taupo and Okataina volcanoes (Fig. 6), and seven older calderas/centres including Mangakino, Kapenga, Whakamaru, Reporoa, Rotorua, Maroa, and newly-identified Ohakuri caldera (Gravelly et al., 2007). The origins and extent of Rotorua caldera are debated (e.g., Esler, 2010). Large explosive eruptions over the last 2 million years or so from this nested collection of rhyolite volcanoes have produced a huge volume of pyroclastic deposits, which when loose are sometimes called tephra (Table 1) and many of the older volcanoes cannot be seen in the landscape because of burial underneath hundreds of metres of volcanic material from more recent eruptions. The products of these caldera eruptions are most obvious as the extensive plateaux flanking the western and eastern sides of the TVZ, which erosion reveals to be made up of many layers or sheets of ignimbrite, pumice, and tephra fallout layers. However, caldera eruption products are found far beyond the more obviously volcanic landscape of the central North Island. If we consider a volcano as including all the material erupted from it, then in a sense the entire area from Auckland to Hawkes Bay is part of a huge caldera volcano centred on TVZ (Smith et al., 2007).

Introduction to Taupo Volcanic Centre and the Taupo eruption

Taupo volcano (Fig. 5) is the most frequently active and productive rhyolite volcano on Earth. Activity began after the eruption of the widespread and voluminous c. 340 ka Whakamaru group ignimbrites, including widespread Rangitawa tephra from Whakamaru caldera. Modern activity began c. 60 ka with nearly 40 eruptions recognised (Fig. 6). These were overwhelmingly pyroclastic (>95%) and from vents mostly now concealed beneath Lake Taupo (Wilson et al., 2006). Pyroclastic deposits exposed in the Taupo-Maroa area represent 11 eruptions from c. 60 ka to c. 25 cal ka, and then the phreatomagmatic Kawakawa/Oruanui eruption occurred at c. 25.4 cal ka. This eruption was extremely voluminous with a total dense-rock equivalent (DRE) volume of ~530 km³ (equivalent to nearly 1200 km³ as bulk pyroclastic material) (Wilson et al., 2006), and it generated one of the most widespread and stratigraphically useful tephra-fall deposits in the wider New Zealand region (Wilson, 2001; Wilson et al., 2006; Lowe et al., 2008, 2013; Holt et al., 2010; Vandergoes et al., 2013). Caldera collapse associated with this eruption generated most of the modern outline of the basin now partly filled by Lake Taupo, and much of the central North Island landscape was changed as a consequence of the eruption (Manville, 2002; Manville and Wilson, 2004; Wilson et al., 2009).

Since the Kawakawa eruption (also known as the Oruanui eruption, hence sometimes referred to as the Kawakawa/Oruanui event), there have been a further 28 eruptions, all but three taking place in the last 12,000 cal years. The most recent (apart from lava extrusion of eruption Z) was the extremely powerful 'ultraplinian' caldera-forming Taupo eruption event (Wilson and Walker, 1985; Wilson, 1993) (Table 2). Wilson (1993) erected a volcanological nomenclature for these 28 events beginning with ψ (the oldest) followed by Ω , A, ..., and Z. Other names are also used for some of them (Froggatt and Lowe, 1990).

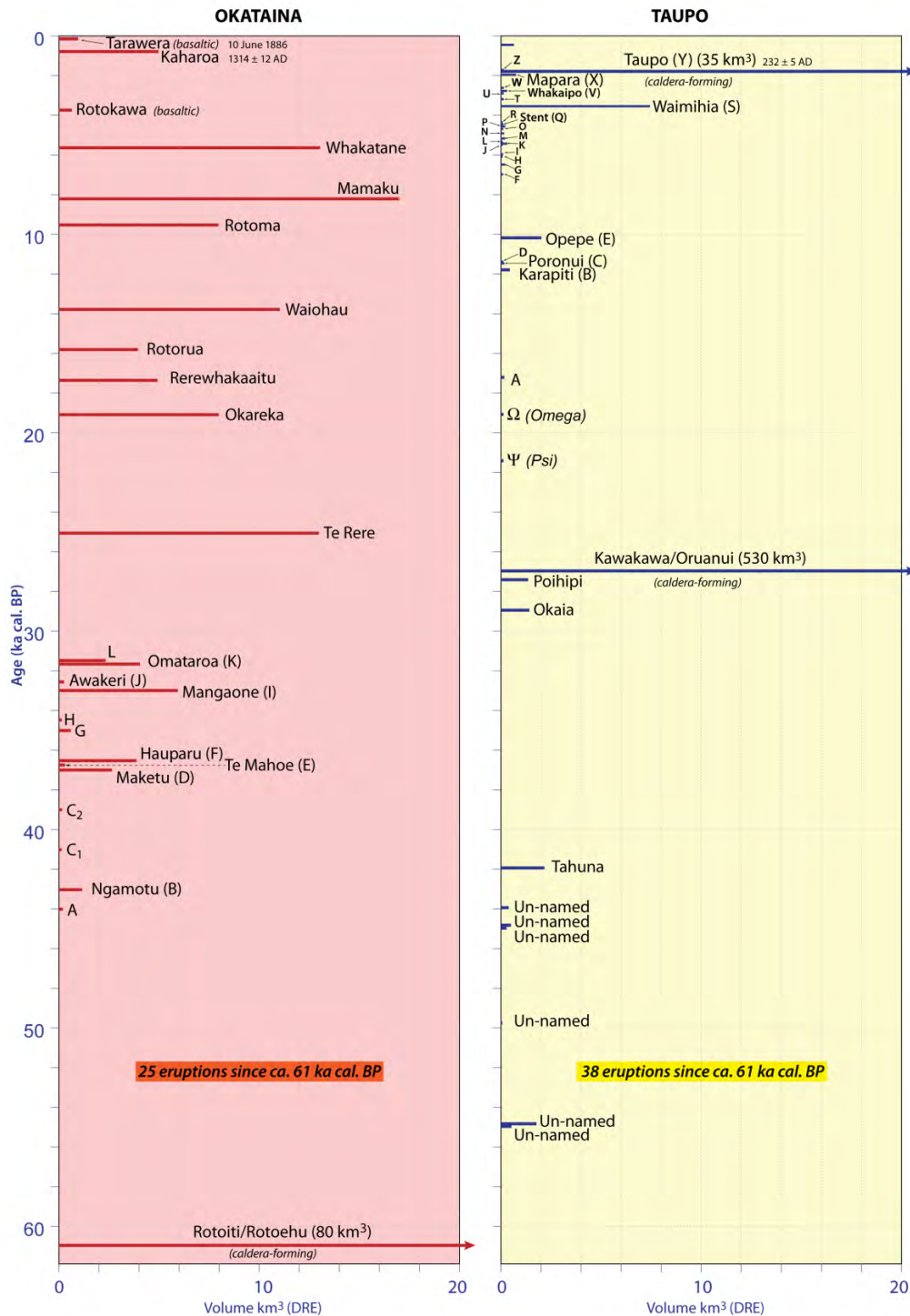

Fig. 6. Interfingering stratigraphic relationships, ages, and volumes (as non-vesiculated, void-free magma or dense-rock equivalent, DRE; multiply by ~ 3 to obtain approximate bulk volumes) of tephras erupted from Okataina and Taupo caldera volcanoes in North Island, New Zealand, since c. 60 cal yr ago (based on Wilson et al., 2009). Another significant unit (not depicted) is the rhyolitic Earthquake Flat tephra (EFT) (7 km^3 DRE), erupted from the Kapenga caldera volcano immediately after the Rototiti/Rotoehu eruption. Note that since this diagram was published by Lowe (2011), Danišik et al. (2012) re-dated the Rototiti/Rotoehu and EFT eruptives using (U-Th)/He and high-resolution ^{14}C dating to attain ages of c. 45-50 cal ka; Vandergoes et al. (2013) re-dated the Kawakawa/Oruanui eruptives using high-resolution ^{14}C dating on new, optimal sample materials to derive an age $25,358 \pm 162$ cal yr BP (2σ); and ages on around 24 other widespread tephras erupted since 30,000 cal yr BP were revised by Lowe et al. (2013).

Table 2 Summary of tephra names and ages and other information for 28 Taupo eruptives post-dating the Kawakawa/Oruanui eruption c. 25 cal ka (after Wilson, 1993, 1994). Note that ages for some eruptives have been modified since this table was published (see Lowe et al., 2013)

Previous published tephra formation name	Volcanological name	Adopted age (years BP) ¹⁴ C time scale	Adopted age (years BP) calibrated timescale	Bulk volume in km ³ as used by Wilson (1993)	Other volume estimates, in km ³	Eruptive activity		Pyroclastic flow(s)	Lava extrusion
						'dry' fall	'wet' fall		
(not defined)	Eruption Z	-	1740	0.28	-	-	-	-	yes
Taupo Tephra	Unit Y	1850	1770	44.75	65, 105	yes	yes	yes	-
Mapara Tephra	Unit X	2150	2150	0.8	0.65, 2, 6	yes	yes	-	(possible)
(not recorded)	Unit W	(2650)	2750	0.023	-	-	yes	-	yes
Whakaipo Tephra	Unit V	2700	2800	0.8	0.8, 1.5, 2, 6	yes	yes	-	(possible)
(not recorded)	Unit U	(2750)	2850	0.2	-	-	yes	-	(possible)
(not recorded)	Unit T	(3000)	3200	0.08	-	-	-	-	(possible)
Waimihia Tephra	Unit S	3300	3550	16.9	15, 17, 19, 29	yes	-	yes	-
Hinemaiaia Tephra	Unit R	3950	4450	0.05	-	yes	yes	-	-
	Unit Q	(4050)	4550	0.15	-	-	yes	-	(possible)
	Unit P	(4100)	4750	0.05	-	yes	yes	-	(possible)
	Unit O	(4150)	4800	0.05	-	yes	yes	-	(possible)
	Unit N	4200	4850	0.15	(3)	yes	yes	-	(possible)
	Unit M	(4500)	5250	0.2	-	yes	(possible)	-	(possible)
	Unit L	4550	5300	0.07	-	-	yes	-	yes
	Unit K	(4600)	5350	0.35	-	yes	yes	-	(possible)
	Unit J	(4620)	5370	0.015	-	-	yes	-	(possible)
(not recorded)	Unit I	(5200)	5950	0.02	-	-	yes	-	(possible)
Motutere Tephra	Unit H	(5300)	6050	0.2	(0.5, 1)	yes	yes	-	(possible)
(not recorded)	Unit G	(5800)	6650	0.5	-	yes	yes	-	(possible)
(not recorded)	Unit F	(6150)	7050	0.12	-	-	yes	-	yes
Opepe Tephra	Unit E	(9050)	9950	4.8	4, 5, 12	yes	yes	yes	-
Poronui Tephra	Unit D	(9780)	11 380	0.2	(3, 3.5, 7)	-	yes	-	yes
(not recorded)	Unit C	(9800)	11 400	0.75	-	yes	yes	-	(possible)
Karapiti Tephra	Unit B	10 100	11 800	1.4	2, 5, 6	yes	yes	-	-
(not recorded)	Unit A	(c. 14 200)	(c. 17 000)	(0.01)	-	-	yes	-	(possible)
(not recorded)	Unit Ω	(c. 15 600)	(c. 18 800)	0.1	-	-	yes	yes	-
(not recorded)	Unit Ψ	(c. 17 200)	(c. 20 500)	(0.05)	-	-	yes	yes	(possible)
Kawakawa Tephra	Oruanui ignimbrite	22 600	24 000-	300	-	-	-	yes	-
	Oruanui fall deposit		26 500	c. 500	-	-	yes	-	-

Taupo eruption

The so-called Taupo eruption (eruption Y) took place in late summer to early autumn (typically late March to early April) on the basis of fruit and seeds preserved in a buried forest at Pureora (Fig. 7) and the lack of an outer latewood ring (Clarkson et al., 1988; Palmer et al., 1988). The eruption year was AD 232 ± 10 AD based on dendrochronology and wiggle-match dating by Hogg et al. (2012). A total eruptive bulk volume was estimated at ~105 km³ (~30 km³ DRE).

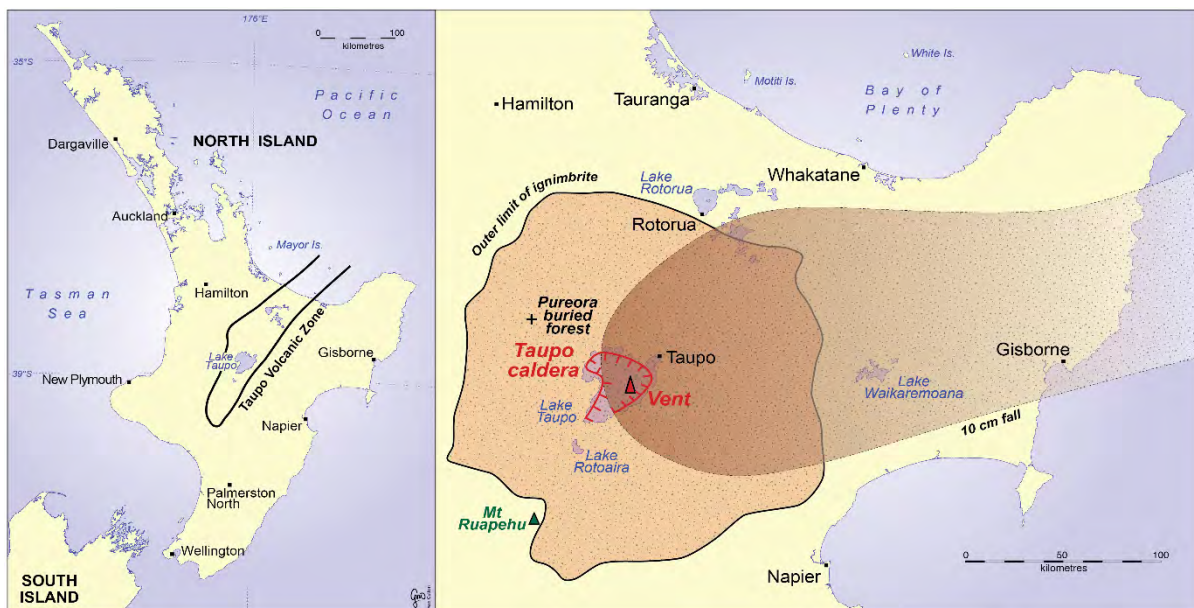

Fig. 7 Distribution of Taupo ignimbrite radially around Lake Taupo and tephra fallout isopachs (in cm) derived from the Taupo eruption (from Hogg et al., 2012).

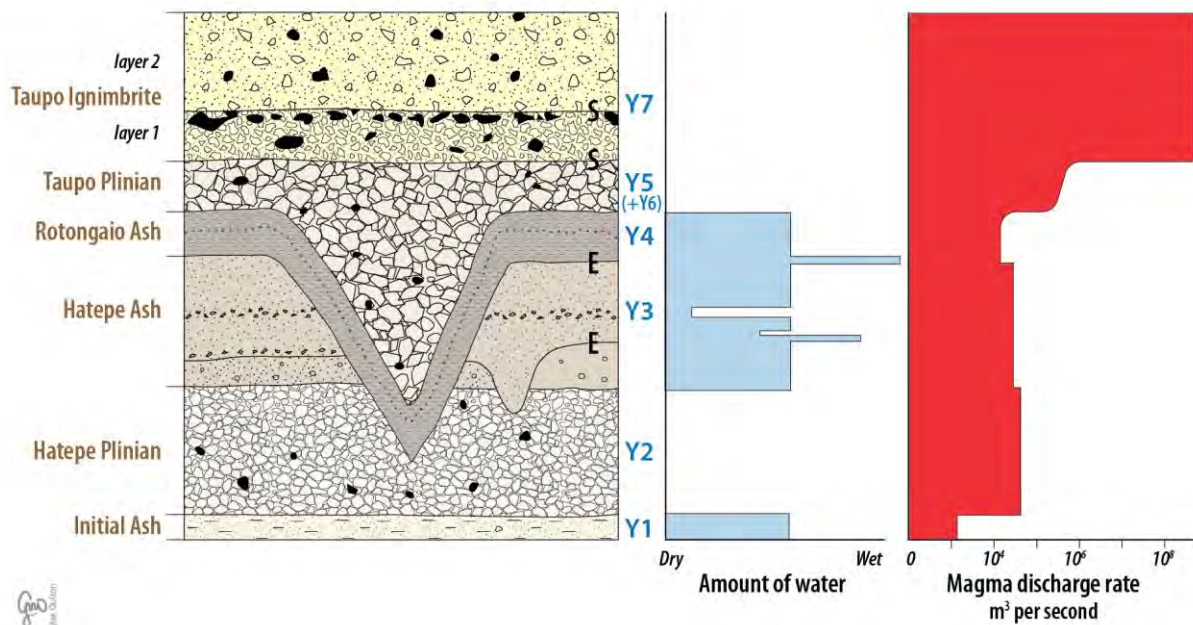

Fig. 8 Summary of the stratigraphy of pyroclastic deposits of the Taupo eruption (eruption Y of Wilson, 1993). Graphs at right indicate qualitative changes in the inferred degree of magma-water interaction and the magma discharge rate (which becomes ‘extreme’ during emplacement of Unit Y7) during the eruption. E = erosion horizons formed by running water; S = erosion horizons from shearing beneath the fast-moving pyroclastic flow that deposited the Taupo ignimbrite (after Houghton and Wilson, 1986).

The eruption was complex, generating three phreatomagmatic (‘wet’) and two plinian (‘dry’) fall units, a multi-flow intraplinian ignimbrite, and at the eruption climax, the extremely violently emplaced Taupo ignimbrite (Unit Y7) (Fig. 8). The duration of the entire eruption episode was of the order of tens of hours with break after Y3 (probably < 3 weeks). The height of the main ultra-plinian phase (Unit Y5) eruption column has been estimated at 50-55 km; this phase lasted for ~6 to 17 hours (Walker, 1980). The ignimbritic material was emplaced cataclysmically over about 400 seconds (~7 mins) by an extremely energetic pyroclastic flow (also called a pyroclastic density current or PDC) moving at 200-300 m/s over a near-circular area (~80 km radius) of c. 20,000 km² around the vents (Wilson, 1985, 1993; Wilson and Walker, 1985; Smith and Houghton, 1995). Its temperature was about 400-500° C at ~ 50 km from vent (within ~30-40 km of the vent it was 150-300° C) (McClelland et al., 2004; Hudspeth et al., 2009). The non-welded ignimbrite was spread thinly over the landscape to generate an archetypal ‘low aspect ratio’ ignimbrite (Walker and Wilson, 1985). Ignimbrite-veneer deposits (IVD) are generally 0.5 to 1 m-thick and drape topographic highs; valley-pond ignimbrites (VPI) infill valleys and depressions to depths of 5 to 60 m (Manville, 2001a).

Because of its extreme violence and energy release ($\geq 150 \pm 50$ megaton TNT explosive yield, cf. Hiroshima bomb 0.015 Mt), and by analogy with the 1883 Krakatau event, it is likely that the ignimbrite-emplacement phase generated a volcano-meteorological tsunami that may have reached coastal areas worldwide (Lowe and de Lange, 2000). The emplacement of the ignimbrite destroyed all forests in its path (about 1 km³ of timber), and then ignimbrite contains numerous charred logs and charcoal, many of the logs notably being orientated radially around the vents (Froggatt et al., 1981). Yet the forests recovered within 100-200 years (Clarkson et al., 1992, 1995; Wilmshurst and McGlone, 1996).

The wide variation in eruption styles and dynamics relate to variations in discharge rate and the degree of interaction between the magma and water in the proto-Lake Taupo (Wilson and Walker, 1985; Wilson, 1993, 1994; Houghton et al., 2010). Much of Lake Taupo was expelled, evaporated, or drained

into a caldera-collapse structure beneath the current lake floor during the eruption. Afterwards it refilled over approximately 15 to 40 years, reaching a height of ~400 m, about 30-40 m above its present level (357 m) to form a semi-continuous, wave-cut bench and highstand shoreline deposits (Manville et al., 1999, 2007, 2009). Catastrophic failure of a pumiceous pyroclastic dam led to the reestablishment of the Waikato River and the release of ~20 km³ of water in a single phase, the peak discharge being 20,000–40,000 m³/sec, equivalent to the Mississippi River in flood (Manville et al., 1999). The break-out flood deposits can be traced 220 km downstream of Lake Taupo (Manville et al., 2007).

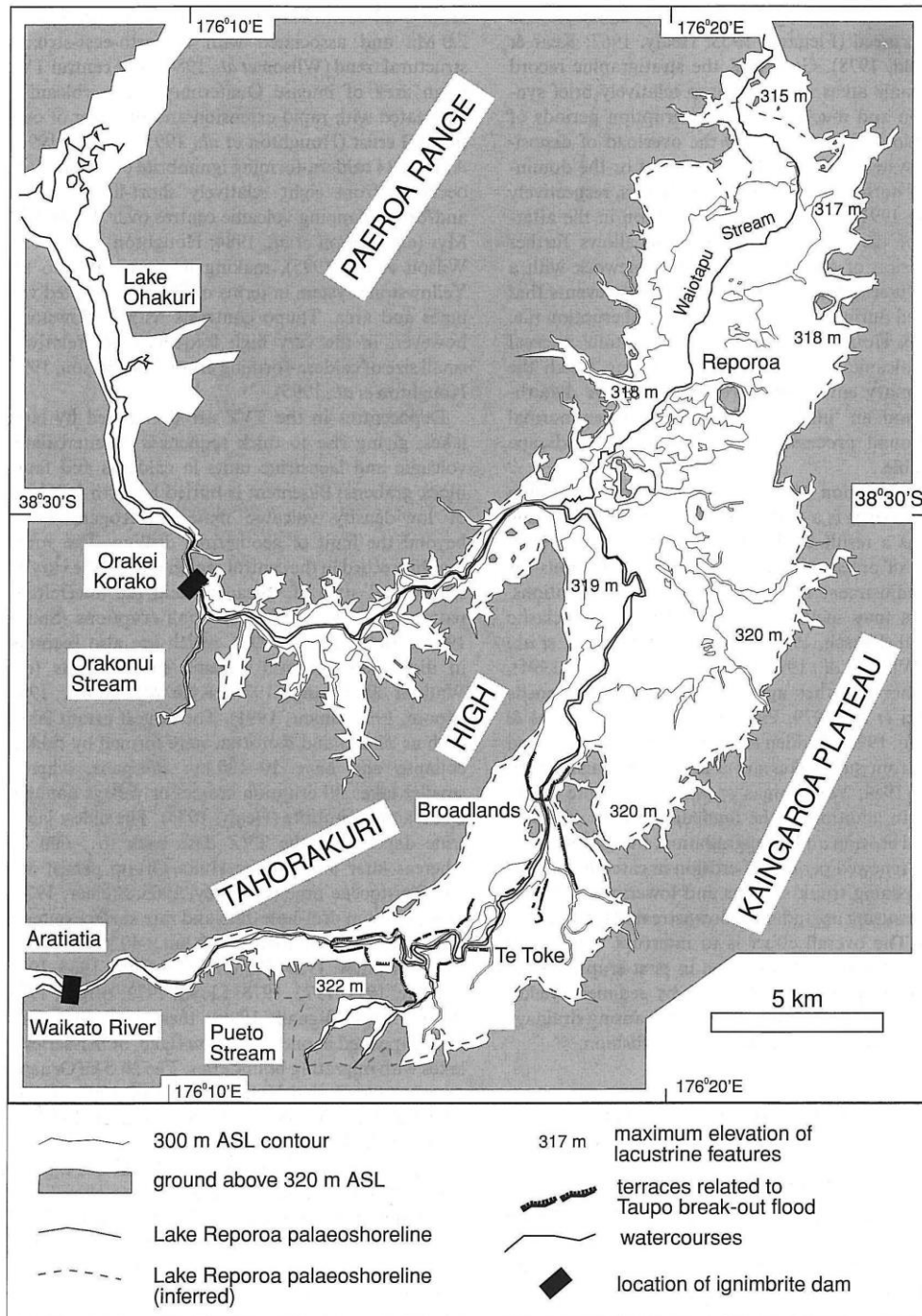

Fig. 9 Outline topography of Reporoa Basin, the area covered by temporary 'Lake Reporoa' and the location of ignimbrite dams that blocked the Waikato River after the Taupo eruption (from Manville, 2001b).

The Reporoa Basin, to the north of Taupo (Fig. 9), was temporarily infilled by a supra-ignimbrite lake, 'Lake Reporoa', because of blockage by Taupo ignimbrite of the basin near Orakei Korako. We drive over the floor of the former lake enroute to Galatea. Lake Reporoa would have formed in about three years and had a maximum area of ~190 km² and a volume of ~2.5 km³ (Manville, 2001b). The lake highstand shoreline is marked approximately by the 320-m contour (perhaps up to 360 m: Manville and Wilson, 2004) where a prominent bench and associated beach and lake sediments occur (Manville, 2001b). The lake would have emptied quickly after overtopping the barrier at its lowest point, near Orakei Korako, generating a peak flood discharge of about 17,000 m³/sec which contrasts with the Waikato River flow rate through the area today of ~130 m³/sec (Manville, 2001b). Several decades after the formation and destruction of Lake Reporoa (Fig. 10), the basin was again partially inundated by the the break-out flood triggered by the failure of the ignimbrite dam at the outlet of intracaldera Lake Taupo as described above.

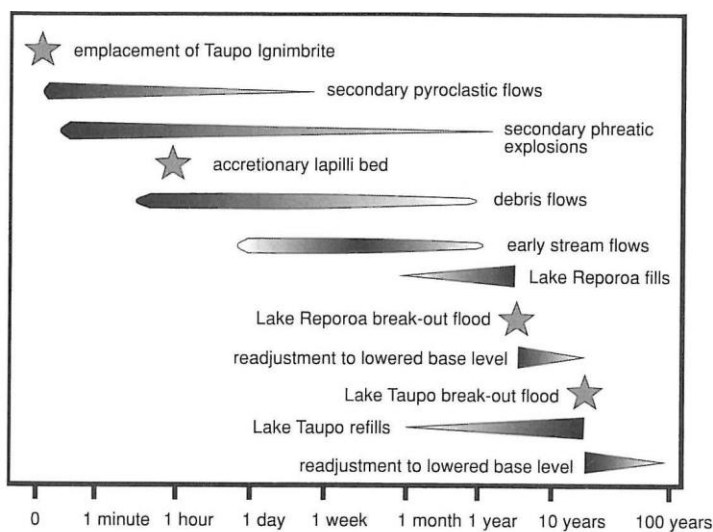

Fig. 10 Chronology of post-Taupo eruption (after c. 232 AD) responses and events. Scale approx. logarithmic. Tapering shaded bars indicate duration and intensity of each process; stars indicate geologically instantaneous events including emplacement of Taupo ignimbrite and break-out flood event from Lake Taupo (from Manville, 2001b).

Introduction to Okataina Volcanic Centre and the Kaharoa eruption

The Okataina Volcanic Centre (Fig. 5) comprises two main parts, the northern Haroharo Volcanic Complex (and Okareka embayment), and the southern Tarawera Volcanic Complex (centred on Mt Tarawera) (see Fig. 3). Since c. 60 cal ka there have been at least 25 eruptions from Okataina (Fig. 6) and the most important tephras since c. 25,400 cal years ago are listed in Table 3 (below).

Kaharoa eruption

Most of us are aware of the basaltic Tarawera eruption on 10th June 1886: the high toll on life (~120 people), landscape devastation, and loss of the Pink and White Terraces. But this was not the first time that Mt Tarawera produced an eruption of importance both to volcanology and human history. The Kaharoa eruption occurred at Mt Tarawera in the winter of 1314 AD (\pm 12 years) (Hogg et al., 2003; Sahetapy-Engel et al., 2014). The importance of the Kaharoa eruption is at least threefold (Lowe and Pittari, 2014). (1) It is the most recent rhyolite eruption in New Zealand, and the largest New Zealand eruption volumetrically of the last millennium. (2) The Kaharoa tephra is an important marker horizon in late Holocene stratigraphy and geoarchaeology (Vucetich and Pullar, 1964; Lowe et al. 1998, 2000), and in particular helps to constrain the timing of settlement of early Polynesians in North Island, which occurred in c. AD 1280, a few decades before the eruption (Newnham et al. 1998; Wilmshurst et al., 2008). (3) There is a link between the soils that developed on the Kaharoa tephra, the animal 'wasting' disease known as 'bush sickness', and the birth of the government soil survey group as an independent organisation (Tonkin, 2012).

Table 3 Summary of main rhyolitic tephras deposited in the Rotorua-Galatea region since c. 25,400 cal yr BP.

Name (source)*	Date or age [†]	Description
Tarawera Tephra (Tr) (Tarawera)	10 June 1886	Comprises basaltic scoria (Tarawera Scoria) with occasional rhyolite clasts and/or fine greyish brown 'muddy' ash (Rotomahana Mud). Mud was dispersed more widely than the scoria.
Kaharoa Tephra (Ka) (Tarawera)	1314 ± 12 AD (636 ± 12 cal yr BP)	Fine to coarse white to grey ash, with occasional dense pumice, rhyolite, obsidian and basalt lapilli. Contains abundant biotite.
Taupo Tephra (also known as Unit Y) (Tp) (Taupo)	232 ± 10 AD (1718 ± 10 cal yr BP)	Creamy coloured coarse ash with plentiful shower-bedded pumice lapilli (crushable). Ignimbrite unit always associated with charcoal fragments.
Whakatane Tephra (Wk) (Haroharo)	5526 ± 145 cal yr BP	Shower-bedded pale yellow coarse ash, overlying a fine to coarse rhyolitic (pale grey) ash. Rich in cummingtonite. Reddish-brown uppermost horizon (sometimes with basaltic Rotokawau tephra c. 4 cal ka).
Mamaku Tephra (Ma) (Haroharo)	7940 ± 257 cal yr BP	Loose, coarse yellowish-brown pumice ash grading into a weakly shower-bedded coarse ash/lapilli.
Rotoma Tephra (Rm) (Haraharo)	9423 ± 120 cal yr BP	Shower-bedded fine grey to yellowish brown ash with coarse ash layers, cummingtonite. Marked by a dark Ah horizon at top, sometimes with charcoal, or podzolised.
Waiohau Tephra (Wh) (Tarawera)	14,009 ± 155 cal yr BP	Grey fine and coarse shower-bedded ash. Distinctive v. fine cream ash layer at the base. Usually has well developed yellowish-brown or greyish upper soil horizon. Deposited a few centuries before late-glacial cool episode (NZce-3) in NZ-CES [‡] .
Rotorua Tephra (Rr) (Okareka embayment)	15,635 ± 412 cal yr BP	Shower-bedded pumiceous yellowish lapilli or blocks (gravel). Occasional rhyolitic lithics. Deposited at start of late-glacial mild episode (NZce-4) in NZ-CES [‡] .
Rerewhakaaitu Tephra (Rk) (Tarawera)	17,496 ± 462 cal yr BP	Yellowish-brown ash grading down into tephric loess. Contains abundant biotite. Marks transition from Last Glacial to post-glacial conditions (Termination I); reforestation occurred soon after deposition.
Okareka Tephra (Ok) (Tarawera)	21,858 ± 290 cal yr BP	Yellowish brown ash contains abundant biotite. Typically encased in yellowish to olive brown tephric loess. Deposited just before stadial A (NZce-6) NZ-CES [‡] .
Te Rere Tephra (Te) (Haroharo/Okareka)	25,171 ± 964 cal yr BP	Yellowish-brown ash (typically encased in yellowish to olive brown tephric loess).
Kawakawa Tephra (Kk) (also known as Oruanui) (Taupo)	25,358 ± 162 cal yr BP	Olive brown to pale yellowish brown ash (typically encased in yellowish to olive brown tephric loess). Deposited just before interstadial D (NZce-9) in NZ-CES [‡] .

*Terminology is based mainly on Froggatt and Lowe (1990). Descriptions generalised because character may differ from proximal to distal locations and from site to site. The region has received additional distal tephras from Taupo and Tuhua volcanic centres, and has been dusted regularly with andesitic tephra fallout from numerous eruptions at Tongariro Volcanic Centre and Egmont/Taranaki Volcano, most recently in the 1995-96 Ruapehu eruptions.

[†]Ages are given in calibrated or calendar (cal) years (95% probability range) before present (BP). Ages are based on Bayesian probability age modelling: Lowe et al. (2008, 2013). Calendar dates for the Kaharoa and Taupo eruptions have been determined by dendrochronology and ¹⁴C wiggle-match dating (Hogg et al., 2003, 2012).

[‡]NZ climate event stratigraphy of Barrell et al. (2013)

Distribution of main soil-forming tephras

The thickest tephra sequences occur downwind of the TVZ in the Rotorua-Taupo area, Bay of Plenty, East Coast-Poverty Bay, and Hawke's Bay (Fig. 11). Moderately thick deposits are found in Wanganui-Taranaki, King Country-Waikato-Coromandel, and Auckland regions. Fewer tephra layers occur in other parts of the North Island. Only a handful of tephras has been recognised so far in the South Island. They include Rangitawa Tephra, erupted c. 340,000 years ago from Whakamaru volcano, and Kawakawa Tephra, erupted c. 25,400 cal years ago from Taupo volcano.

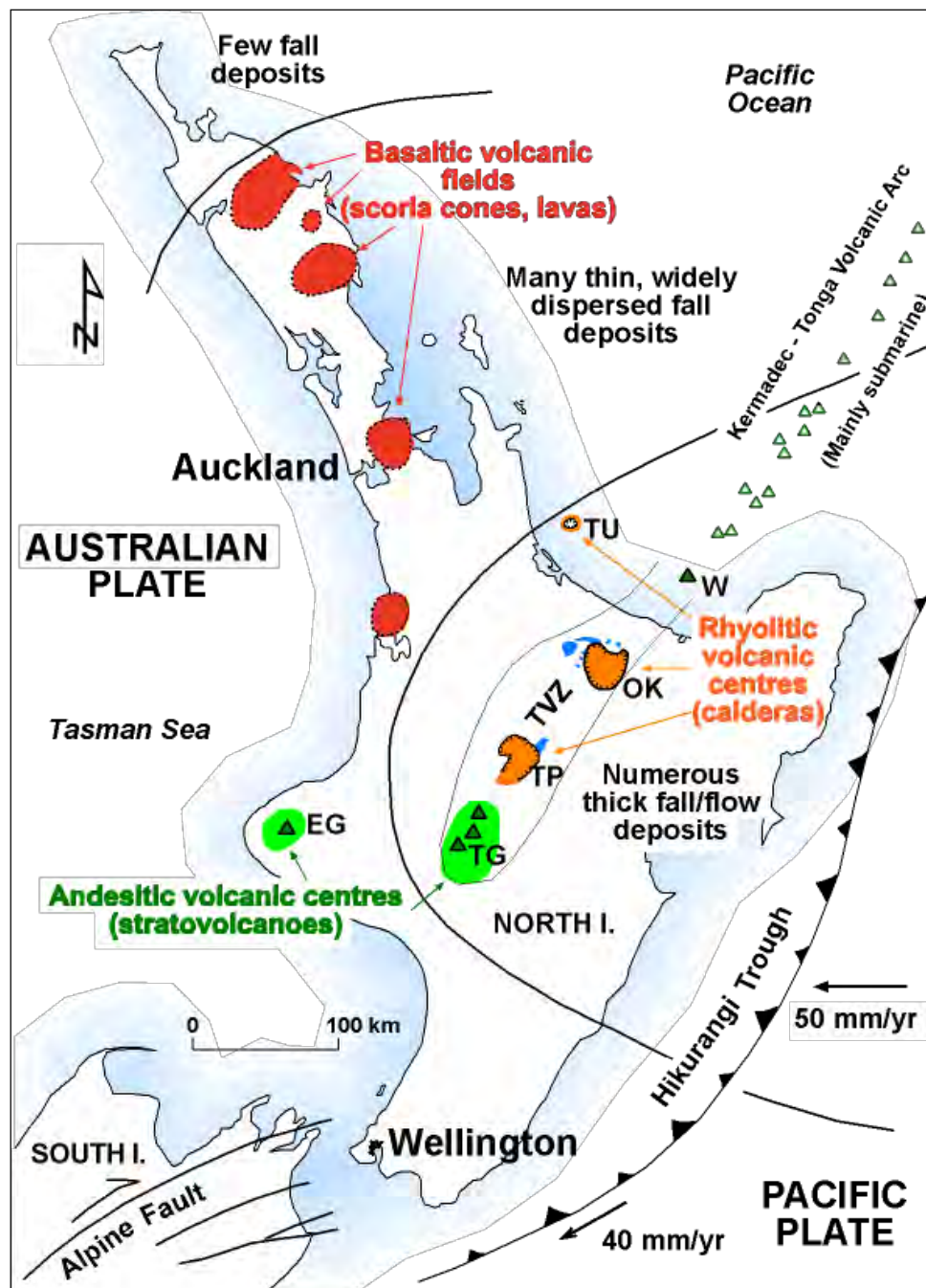

Fig.11 Map showing plate tectonic setting, the main volcanic centres that produced parent materials for many tephra-derived soils, and the general dispersal of tephra on North Island. EG, Egmont/Taranaki volcano; TG, Tongariro Volcanic Centre; TP, Taupo Volcanic Centre; OK, Okataina Volcanic Centre (includes Mt Tarawera and Haroharo volcanic complexes); TU, Tuhua Volcanic Centre (Mayor Is.); W, Whakaari (White Is.) (from Lowe and Palmer, 2005).

Tephra-derived soils of New Zealand

The relatively young landscapes of much of central North Island, especially the Bay of Plenty-Taupo-Tongariro area, are predominantly of volcanic origin. Consequently, the nature and distribution of the soils contained in these landscapes are very strongly influenced by the volcanic history as well as faulting (tectonism) and reworking by water and wind. Variations in the age, thickness, and mineralogical composition of the tephra deposits in which the soils are forming have significantly contributed to the soil patterns. Post-depositional erosion and reworking of tephra deposits have helped to shape the landscape and, in turn, have created 'genetic' links of varying strengths between the soils and landforms of the region. To some extent, climatic and indigenous vegetation gradients have also been imprinted upon the soils and their distribution pattern (Molloy and Christie, 1998).

Soils formed from tephra deposits are represented by five orders of the *New Zealand Soil Classification (NZSC)* which reflect increasing age and development (Lowe and Palmer, 2005; Hewitt, 2010) (Fig. 12):

- (Tephric) Recent Soils (~1% of North Island soils)
- Pumice Soils (~15%)
- Allophanic Soils (~12%)
- Granular Soils (~3%) and (rarely) Ultic Soils

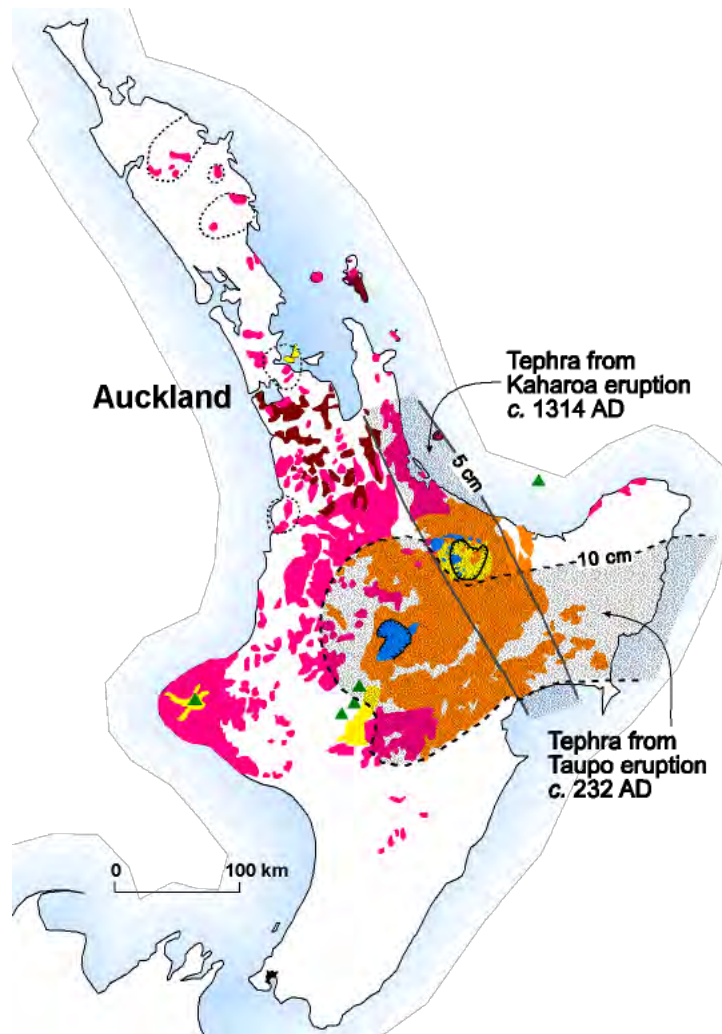

Fig. 12 Map of North Island showing single isopachs of Taupo and Kaharoa tephras, on which soils were deficient in Co which resulted in 'bush sickness'. Yellow, Recent Soils from tephra; pink, Allophanic Soils; brown, Granular Soils (from Lowe and Palmer, 2005).

Pumice Soils, which are classed as Vitrandis in *Soil Taxonomy* (see below, p. 28) cover a large swath of the central and eastern North Island (Fig. 12). These siliceous soils are made up of coarse, highly siliceous rhyolitic pumice deposits derived mainly from the Taupo (c. 232 AD) and Kaharoa eruptions (c. 1314 AD), and are the focus of today's trip.

Pumice Soils, “bush sickness”, and plantation forestry

Inherently low in Co, these pumiceous parent tephras led to low Co levels in soils and herbage, and ultimately to a deficiency in ruminant animals (sheep and cows) that developed a serious and commonly fatal wasting disease known as “bush sickness” (Lowe and Palmer, 2005; Neall, 2006) (Fig. 13). This term referred to a variety of symptoms exhibited by livestock stemming from their inability to produce vitamin B₁₂ (cobalamine, discovered in 1948), of which Co is an essential component for red blood cell production (Cornforth, 1998; Hendy, 2008).



Fig. 13 ‘Bush-sick’ cow on Taupo soil at Ngaroma, South Waikato (from Grange and Taylor, 1932)

Identified in 1911, bush sickness became an increasingly urgent problem in the late 1920s when many farms on Pumice Soils, settled after WW I, were abandoned as the depression hit. The association of bush sickness with the Pumice Soils was recognized by Les Grange (who began mapping volcanic deposits in 1926) in the early 1930s (Grange and Taylor, 1932; Grange, 1937). Acquired Co deficiency also occurred in some other soils where high rainfall and strong leaching were the cause. Veterinarians were unable to diagnose any diseases, and it was thought that some property of the soil was responsible. Analytical techniques of the day (early 1900s) were too insensitive to show what this might be, but trial and error showed that iron ore (“limonite”) from some, but not all, sources provided relief as a stock ‘lick’ (Hendy, 2008). There was some rivalry in this work. Elsa Kidson (Cawthron Institute) and K.J. McNaught (Department of Agriculture) each developed essentially the same methods for finding trace amounts of cobalt. They published a series of papers on cobalt levels in rocks, soils, and pastures, while pointing out each other’s errors (Tonkin, 2012). Initial research was directed at trying to supplement the animals’ diets with iron. In 1934, R.E.R. Grimmett and F.B. Shorland (senior chemists at the Department of Agriculture) found that the iron ore which gave the best results contained significant amounts of cobalt, and went against popular wisdom by dosing animals with cobalt, with spectacular results. Australians Underwood and Filmer (1935) confirmed the association. Grimmett and Shorland then developed cobaltised superphosphate fertiliser, which has

been applied to the affected area ever since at a rate of a few grams per hectare, and has resulted in the addition of about 250,000 ha of productive farmland to New Zealand's stock (see also notes by Ants Roberts on p. 25). Possibly, this one discovery has paid for all of the scientific research ever carried out in New Zealand (Hendy, 2008). In addition, Grange's insight resulted in soil survey becoming a separate, independent branch of the Department of Scientific and Industrial Research (DSIR) in 1936 rather than effectively an 'add-on' to the Geological Survey Branch as it had been (Lowe, 1990; Tonkin, 2012). Grange was the first director of Soil Survey (and later a director of Geological Survey); it was renamed Soil Bureau in 1945 until morphing into Landcare Research in July 1992.



Fig. 14 Landscape at Litchfield, midway between Putaruru and Tokoroa, underlain by shallow Taupo soils on Taupo tephra. The Co deficiency here was the first to be rectified – on the nearby farm of K.S. Cox.

Partly as a result of these agricultural problems, a forestry industry became established, the mainstay tree being *Pinus radiata* from California (known as Monterey pine). *P. radiata* has been very successful, it matures rapidly in about 25 years on average, and can grow on 'clapped out' soils with little problem. Its roots can easily punch through surficial pumice deposits to reach nutrients and water in buried soil horizons. The soils to the east of SH1 between Putaruru and Tokoroa are now growing their 5th crop (rotation) of *P. radiata*. The importance of this tree will become very evident during our trip (e.g., see Fig. 2). Palmer et al. (2005) used a P-based nutrient model to establish that *P. radiata* was growing sustainably after two rotations on Podzol Soils developed on Taupo tephra in elevated areas on the southern Mamaku Plateau to the east of Tokoroa. Models to predict *P. radiata* productivity throughout New Zealand were developed by Watt et al. (2010) and various spatial prediction techniques for developing *P. radiata* productivity surfaces across New Zealand were compared by Palmer et al. (2009).

Erodibility

The soils developed in loose Taupo tephra deposits around Lake Taupo are susceptible to severe gully erosion. The erodibility of the soils under three classes of vegetation – pasture grasses, ungrazed grass, and scrub – was assessed by Selby and Hoskins (1973) with the use of a specially designed flume that simulated gully erosion. Erosion was found to be significantly higher beneath scrub than beneath grass vegetation when the same erosive stress was applied in each case. Under natural conditions, however,

greater runoff, and therefore greater erosive power, always occurs on pasture grasses than under scrub. In spite of the greater inherent erodibility of scrub, actual erosion is therefore greater on pasture lands (Selby and Hoskins, 1973). Under pasture grasses, plant roots and organic matter bind the soil particles and inhibit erosion. This effect is less under scrub. Gully erosion is attributable largely to the low density and easy entrainment of pumice particles. 'Retirement' of such gullies with tree planting has been successful in stabilising them.

Soil fertility on Pumice Soils

Ants Roberts

Ravensdown

Introduction

Soils formed on pumice cover a wide area in the central North Island (Fig. 12). These soils are physically suitable for pasture production, but are deficient in most major elements, and several trace elements as noted previously. If these deficiencies are corrected, pastures on the pumice soils can be productive. Although many of the Pumice Soils of the central North Island have been formed from Taupo and Kaharoa tephras, small areas of Pumice Soils formed on an earlier Taupo eruptive, Waimihia tephra (3401 ± 108 cal. yr BP), occur in Hawke's Bay (eastern North Island). In some areas, later eruptions have covered the Taupo and Kaharoa tephras with younger deposits, including andesitic tephras (e.g. Ngauruhoe tephra) and Tarawera tephra. Some of the volcanic material in valleys and on terraces has been sorted by water. Because pumice floats on water, the larger particles have been brought to the surface, and soils have been formed from this coarser material.

Physical characteristics

The textures of the Pumice Soils vary from silt to coarse gravel, depending on the characteristics of the original material and the age of the soil. In general, the material deposited becomes finer with increasing distance from the site of the eruption. Soils formed on the Taupo deposits undisturbed by water erosion often have a layer of fine ash (Taupo ignimbrite, Unit Y7) overlying layers of coarser material (pre-ignimbrite phases) which sometimes contain large lumps of pumice (see stop 1 for a classic profile of the Taupo sequence, p. 47). Pumice Soils have few physical limitations to pasture growth. The topsoils are loose and friable, with low bulk densities. They recover quickly from heavy grazing, and soil compaction of the topsoil is not a problem. Some soils contain compact sub-surface layers developed during the cooling of Taupo ignimbrite. These layers may restrict the root growth of trees and deep-rooted plants such as lucerne. Available soil moisture may be low, particularly in coarser-textured soils, but increases as organic matter content of the topsoil is built up. Because they have weak structure, Pumice Soils can erode easily if the pasture cover is disturbed by stock.

Chemical fertility

Phosphorus (P)

Pumice Soils are very deficient in P, and heavy initial fertiliser applications, as much as 1.25 to 2.5 tonnes/ha, are needed. For field crops, application rates can be reduced by banding the fertiliser with the seed. For near maximum pasture production, Olsen P soil test values of 35 to 45 are needed, higher than in other soil types. Once Pumice Soils are brought into production and initial P requirements are met, maintenance fertiliser requirements are much lower. These will depend on the losses of P in produce removed from the farm, and hence on the intensity of farming.

Potassium (K)

These soils have little ability to retain K in the topsoil. As a result, much of the K returned to the soil in dung and urine is leached out of the topsoil to deeper layers. Soil test K values of 6 to 8 are needed for near maximum pasture production. The equivalent of 45 kg K/ha (e.g., 90 kg potassium chloride/ha) is needed to raise the test level by approximately one unit.

Sulphur (S)

S deficiency can be a major problem on Pumice Soils. In the first year of pasture establishment, S is usually adequate, but for the next 10 to 20 years much added S is tied up in unavailable organic forms. S retention by the topsoil also decreases, so any inorganic S is leached into the subsoil. Eventually, after many years under pasture, soil organic matter reaches equilibrium, and S is released at about the same rate that it is tied up. Leaching of S still occurs, but cycling of organic S and addition of fertiliser S prevent deficiency.

The measurement of organic S is essential to fertiliser management on pumice soils. If values are below 15 to 20, S fertiliser is needed. Using elemental S fertiliser slows down S leaching and gives a longer period of protection from S deficiency than sulphate-S fertiliser. The use of some elemental S fertiliser should be considered if organic S levels are low, or in areas where the rainfall is over 1200mm, or on coarse, free-draining soils. It should also be considered if S fertiliser is applied only once a year, particularly if this is in autumn. If fertiliser is applied less than once a year, elemental S is strongly recommended.

Magnesium (Mg)

Mg levels in the topsoils of Pumice Soils tend to be low, and applying Mg fertiliser often increases pasture yield. Soil tests for available Mg should be carried out; and test values over 4 are needed for maximum pasture production. If the soil is low in Mg, 25 kg Mg/ha (45 kg MgO/ha) will be needed to eliminate deficiency in the pasture. Higher levels will be needed to increase the Mg content of the forage sufficiently to minimise Mg deficiency in grazing animals. In dairy farming, soil test levels of 8 to 10 are considered optimum.

pH

Pumice soils usually have moderate to high pH levels, so lime applications rarely increase pasture growth. Soil testing should be used to monitor pH levels. Lime at 2500 kg/ha is beneficial for the establishment of lucerne from inoculated seed, but is rarely required for later growth. Where cultivation brings more acidic subsoil to the surface, lime may benefit pasture establishment and growth. Soil pH levels may be maintained by small annual lime applications to counter the acidification that occurs under pastoral management.

Sodium (Na)

Na is not required for pasture growth, but adequate levels are required for animal health. Lucerne and pastures dominated by browntop on pumice soils can be too low in Na for lactating ewes and cows, and for growing lambs. Na supplements should be provided for grazing livestock under these conditions, following veterinary advice.

Copper (Cu)

Cu has given only slight increases in pasture growth, but copper deficiency has been found in cattle. In some cases, this is caused by high levels of molybdenum, which interfere with the absorption of Cu, rather than low Cu concentrations in pasture.

Cobalt (Co)

Co is not required by pasture plants; its main effect is on livestock health. Unless additional Co is supplied, ruminants grazing pastures on Pumice Soils suffer “bush sickness”, as described above. This can be prevented either by supplying Co or vitamin B₁₂ directly to stock or by topdressing the pasture with a fertiliser containing Co. If 350g cobalt sulphate/ha is applied for 7 to 10 years, the Co content of the soil will be raised, and maintenance rates can be reduced to 60 g/ha annually. Herbage Co concentrations and livestock vitamin B₁₂ levels should be checked each spring.

Selenium (Se)

Se is another trace element needed only by livestock. Deficiency leads to white muscle disease in lambs and calves. Concentrations are low in some Pumice Soils, particularly on soils formed from coarse water-sorted material in valleys. Se can be supplied directly to animals, or applied in fertiliser. If it is to be supplied in fertiliser, the equivalent of 10 g Se/ha should be applied annually.

Molybdenum (Mo)

Mo levels vary widely and inexplicably in Pumice Soils. On some coarse soils of alluvial flats and old lake beds, Mo deficiency can reduce the growth of lucerne and pastures. On these soils, 50 g sodium molybdate/ha should be applied every 4 years. In other areas, high Mo levels induce Cu deficiency in cattle. Because of these variations, Mo fertiliser should not be used unless soil or plant tests indicate that the element is deficient.

Boron (B)

B deficiency is widespread on Pumice Soils, and can reduce growth of lucerne and brassica crops. Deficiency can be overcome by applying 10 kg sodium borate/ha annually.

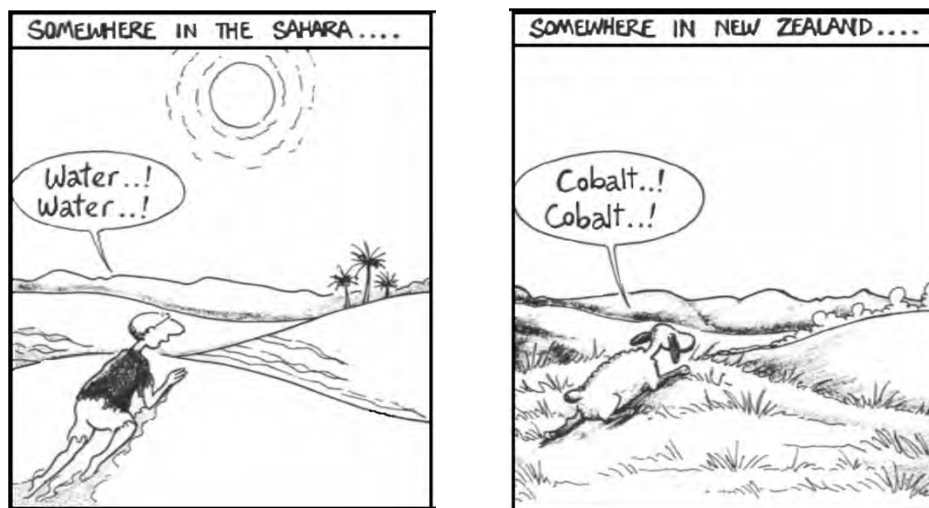

Cartoon by scientist (geochemist) Nick Kim.

Classification of Pumice Soils in *Soil Taxonomy*

Andisols are one of 12 soil orders in the international soil classification system *Soil Taxonomy* (Soil Survey Staff, 1999). They are often deep soils commonly with depositional stratification developing mainly from ash, pumice, cinders (scoria), or other explosively erupted, pyroclastic volcanic material (referred to collectively as tephra) and volcanoclastic or reworked materials. Andisols occur much less commonly on lavas. Unlike many other soils, Andisol profiles commonly undergo upbuilding pedogenesis as younger tephra materials are deposited on top of older ones, as described below. The resulting profile character is determined by the interplay between the rate at which tephra are added to the land surface and classical topdown processes that form soil horizons. Therefore, understanding Andisol genesis usually requires a stratigraphic approach combined with an appreciation of buried soil horizons and polygenesis (see notes on p.31) (McDaniel et al., 2012). The *NZSC* splits Andisols into Allophanic Soils (mainly Udands) and Pumice Soils (mainly Vitrandis). Vitrandis are defined as slightly weathered, coarse-textured, glass-dominated Andisol with < 15% 1500 kPa water retention on air-dried samples and < 30% kPa water retention on undried samples (Soil Survey Staff, 2014).

Andisols are defined by characteristic andic soil properties that include physical, chemical, and mineralogical properties that are fundamentally different from those of soils of other orders (andic properties are termed allophanic soil materials in *NZSC*). The coarser fractions of Andisols are often dominated by volcanic glass. This glass weathers relatively quickly to yield a fine colloidal or nanoscale fraction (1–100 nm) dominated by short-range-order materials composed of ‘active’ Al, Si, Fe, and organic matter, especially humus. Previously described erroneously as ‘amorphous’, short-range order materials comprise extremely tiny but structured nanominerals, referred to nowadays as nanocrystalline, the main ones being allophane and ferrihydrite. Another colloidal constituent, imogolite, comprises long filamental tubes and therefore has both short- and long-range order (Churchman and Lowe, 2012). The nanominerals, chiefly allophane, ferrihydrite, and also Al- or Fe-humus complexes, are responsible for many of the unique properties exhibited by Andisols (McDaniel et al., 2012). The formation of allophane and other minerals including halloysite are described by Churchman and Lowe (2012). Some properties of buried soil horizons may be altered via diagenesis.

Allophane and its formation

Allophane is a nanocrystalline aluminosilicate comprising tiny spherules ~3.5 to 5.0 nm in diameter and with a chemical composition $(1-2)\text{SiO}_2 \cdot \text{Al}_2\text{O}_3 \cdot (2-3)\text{H}_2\text{O}$ (Abidin et al., 2007) (Figs. 15-16). It provides many tephra-derived soils including Allophanic Soils and Pumice Soils with many of their unique chemical and physical properties (McDaniel et al., 2012; Yuan and Wada, 2012). With its small size, extreme surface area (up to $1500 \text{ m}^2 \text{ g}^{-1}$) (Parfitt, 2009; Yuan and Theng, 2012), and variable surface-charge characteristics that arise via $(\text{OH})\text{Al}(\text{OH}_2)$ groups at wall perforations of its outer gibbsitic octahedral sheet $[\text{Al}(\text{OH})_3]$, allophane has strong affinity for water, metal cations, anions, organic molecules and DNA (Harsh, 2012; Huang et al., 2014).

The essential conditions for the formation of allophane are the activity of silicic acid in the soil solution, the availability of Al species, and the opportunity for co-precipitation (Fig. 17). These conditions are controlled largely by the leaching regime, the organic cycle, and pH, which, in turn, are potentially influenced by numerous environmental factors including rainfall, drainage, depth of burial, parent tephra composition and accumulation rate, dust accession, type of vegetation and supply of humic substances, and human activities (such as burning vegetative cover), together with thermodynamic and kinetic factors (McDaniel et al., 2012). Availability of Al, derived mainly from the dissolution of glass or feldspars, is assumed to be unlimited in this model, though potentially more is available from andesitic and especially basaltic tephra than rhyolitic tephra. In contrast, in pedogenic environments rich in organic matter and with pHs ≤ 5 , humus effectively competes for dissolved Al, leaving little Al

available for co-precipitation with Si to form allophane or halloysite. In these environments (such as in parts of Japan), Al-humus complexes are formed instead of allophane (McDaniel et al., 2012).

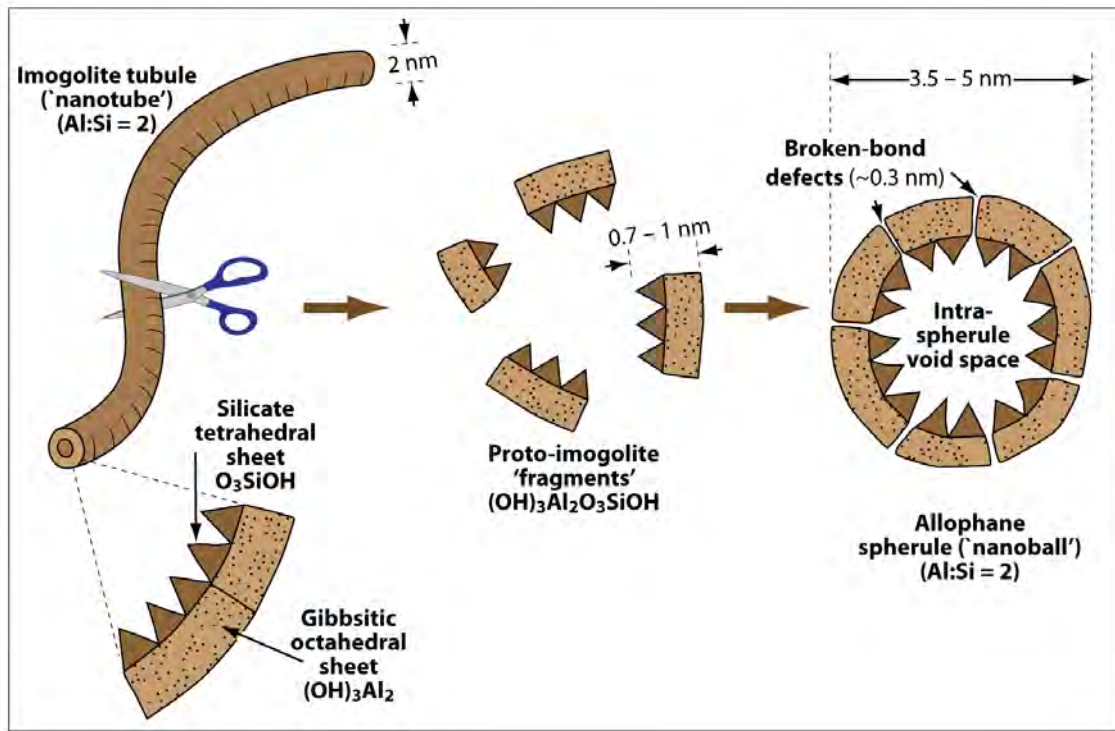

Fig. 15 Diagram of imogolite nanotubes and Al-rich allophane nanospheres, which have similar structures at the atomic scale (from McDaniel et al., 2012).

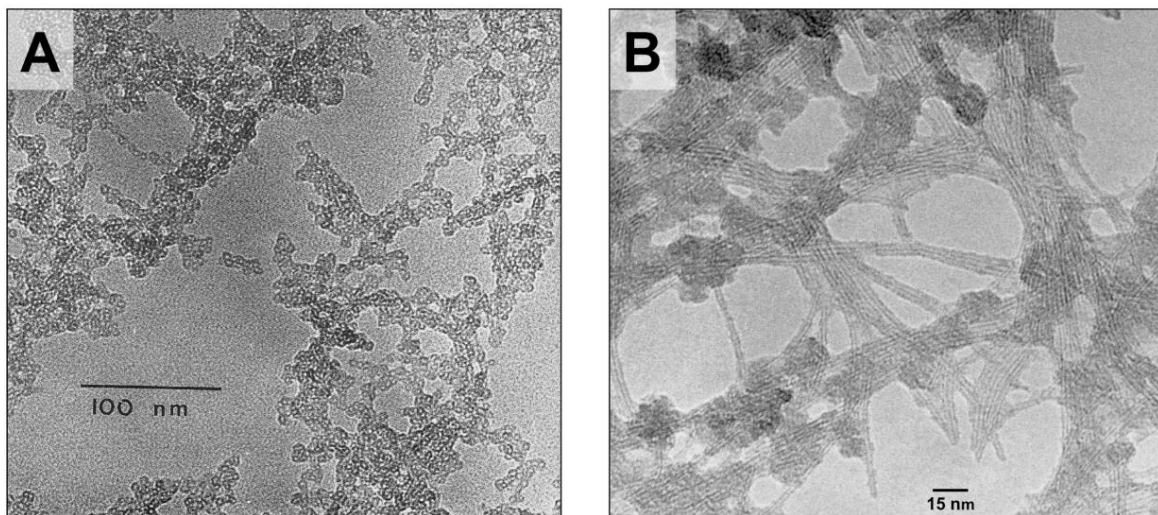

Fig. 16 Micrographs of (A) allophane and (B) imogolite (external diameter of nanotubes is ~2 nm) (from McDaniel et al., 2012, after Parfitt, 1990).

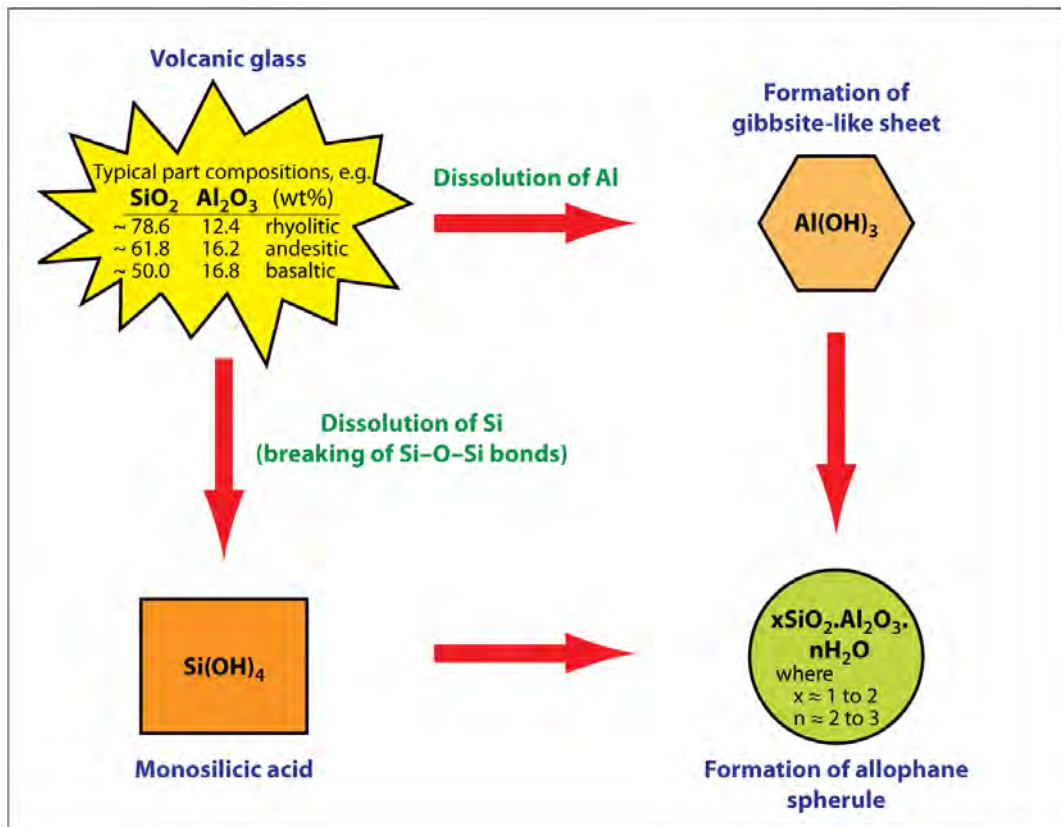

Fig. 17 Various volcanic glass compositions and dissolution of Al and Si and their reprecipitation to form allophane spherules or ‘nanoballs’ (from McDaniel et al., 2012, after Hiradate and Wada, 2005).

In New Zealand, both mineralogical and soil-solution studies on soils derived from tephras extending across a rainfall gradient showed that rainfall, coupled with through-profile drainage, helps govern Si concentration [Si] in soil solution and thus the likelihood of allophane being formed or not (Parfitt et al., 1983; Singleton et al., 1989; Parfitt, 1990, 2009). The Si leaching model is summarized as follows: where [Si] is less than ~10 ppm (mg l^{-1}), allophane is formed; where [Si] is greater than ~10 ppm, halloysite is formed. If [Si] is close to ~10 ppm then either allophane or halloysite may predominate. A profile throughflow threshold of approximately 250 mm per year of drainage water likely controls [Si] – less than ~250 mm means that the loss of Si is insufficient for Al-rich allophane to form and halloysite (or Si-rich allophane) forms instead (Parfitt et al., 1984; Lowe, 1986; McDaniel et al., 2012) (Figs. 18-19).

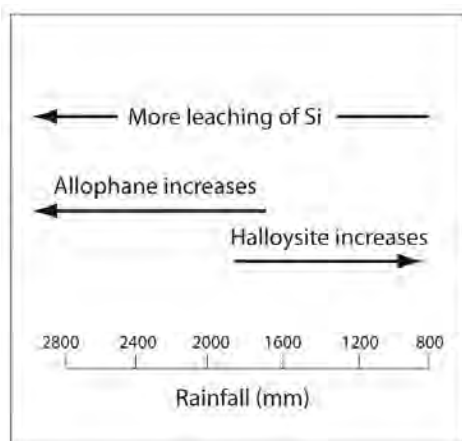

Fig. 18 Simplified allophane-halloysite rainfall leaching model (from McDaniel et al., 2012, after Parfitt et al., 1983).

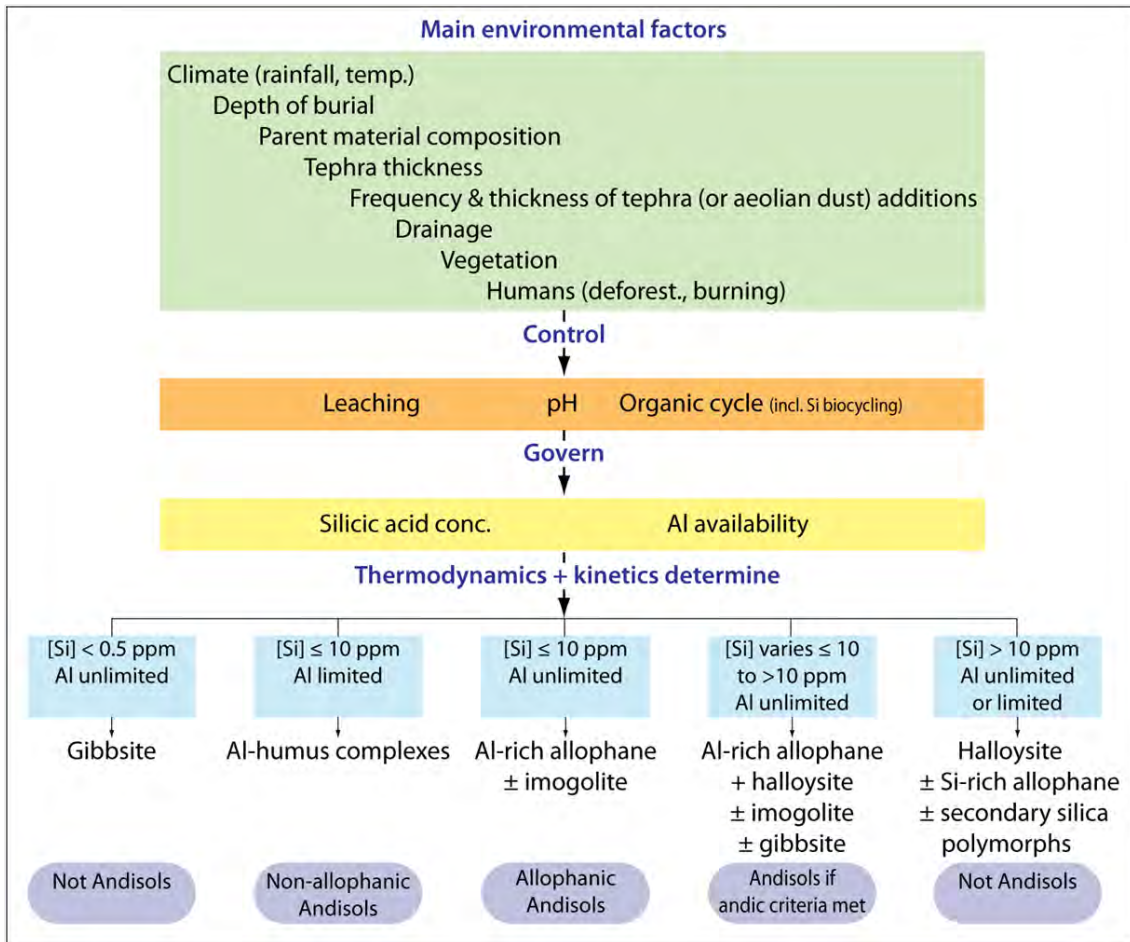

Fig. 19 Environmental influences and controls that govern the critical conditions leading to the formation of different clays from the weathering of tephtras, and the likely occurrence, or not, of Andisols (mainly Allophanic and Pumice Soils in NZSC) as a result (from Churchman and Lowe, 2012). ± indicates that the clay mentioned may also be present.

Forming a soil whilst tephtras accumulate: geological vs pedological processes

A distinctive feature of many tephtra-derived soils is the multilayered nature of their profiles which attests to building up the landscape via the deposition of tephtras from numerous eruption. After establishing the stratigraphy (geological layering) of the sequences, the interplay of topdown pedogenesis (soil formation) and the accumulation to tephtras on the land surface can be considered (upbuilding pedogenesis).

Topdown pedogenesis is the ‘classical’ formation of *soil horizons* in a profile through various processes that gradually deepen the profile as a downward moving ‘front’ on a pre-existing parent material on a stable land surface with *nil or negligible additions* to the surface. Soil formation proceeds by effectively modifying pre-existing parent materials to a greater or lesser extent according to a range of factors that dictate a range of processes. However, in many landscapes, such as those of alluvial plains, or where tephtras or loess are deposited, aggrading parent materials are very common. The evolution of soils in such landscapes therefore has an additional complexity because the impact from topdown processes is modified by the rates at which new materials are added to the landsurface via geological processes (Almond and Tonkin, 1999). The resultant soils are formed by upbuilding pedogenesis.

Upbuilding pedogenesis is the ongoing formation of soil *via topdown processes* whilst tephra or loess (or alluvium, colluvium) *are concomitantly added* to the land/soil surface as normal geological processes (Lowe and Tonkin, 2010; McDaniel et al., 2012). The resultant soils may show distinctive layering and buried horizons (sometimes referred to as paleosols), forming *multisequal (multilayered) profiles*. The frequency and thickness of tephra accumulation (and other factors) determine how much impact topdown processes have on the ensuing profile character, and if *developmental* or *retardant* upbuilding, or both, will take place. These terms were coined by Johnson and Watson-Stegner (1987) and Johnson et al. (1990) as part of their dynamic-rate model of soil evolution whereby soils are envisaged to evolve by ‘ebb and flow’ through time (Schaetzl and Anderson, 2005).

- **Developmental upbuilding** occurs when the rate of addition of tephra or loess to the land is incremental and sufficiently slow so that topdown pedogenesis effectively keeps pace as the land gradually rises (a corollary is that each part of the profile has been an A horizon at one time) (Fig. 20).
- **Retardant upbuilding** occurs when a relatively thick layer of tephra (or alluvium, colluvium) is instantaneously added to the surface, or the rate of accumulation of thinner additions is fast, so that the original soil is rapidly buried (overwhelmed), and thus becomes a *buried horizon cut off and isolated* from the new land surface in which pedogenesis begins anew (Fig. 21).

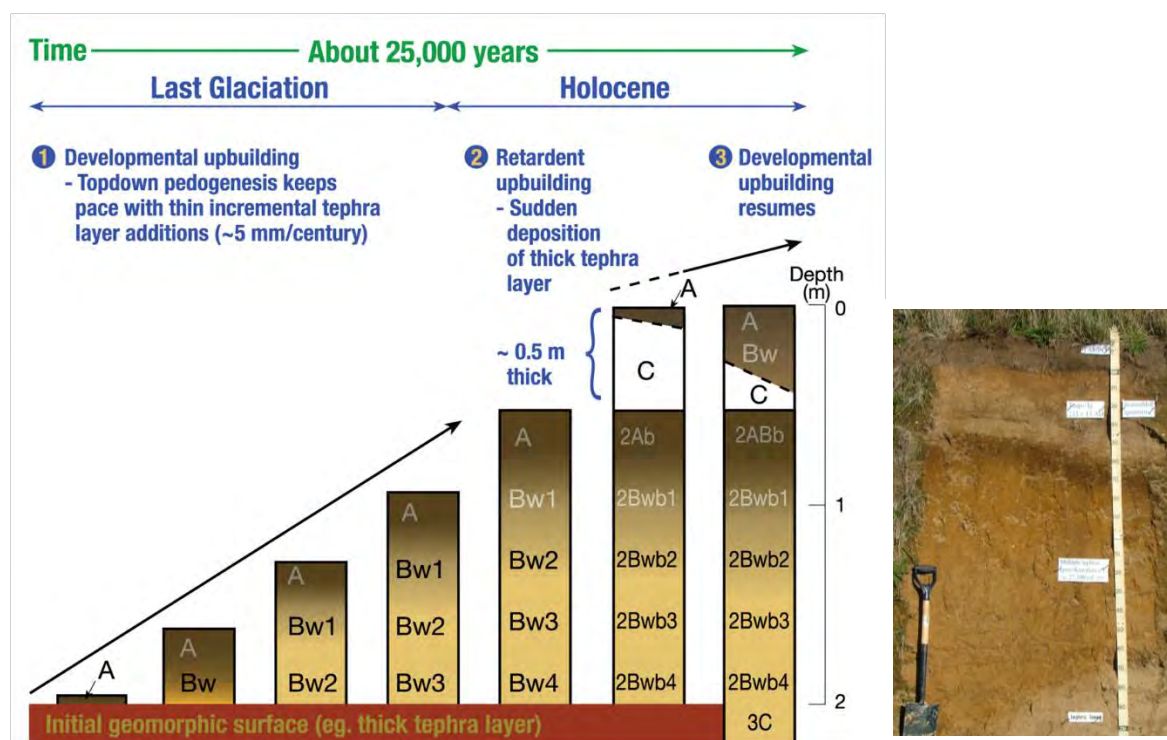

Fig. 20 Model of upbuilding pedogenesis in tephra deposits and the formation of a multisequal profile (photo at right) over c. 25,000 years in South Waikato. The underlying initial surface is marked here by a thick pinkish-grey layer of Kawakawa Tephra (c. 25,400 cal yr BP). In phase 1, thin, distal tephra accumulate slowly whilst topdown processes imprint weak horization features on them as the land surface gradually rises (developmental upbuilding). In phase 2, the sudden deposition of a tephra layer ~0.5 m thick, Taupo ignimbrite here (c. AD 232), from a particularly powerful eruption buries the antecedent soil, isolating it from most surface processes so that topdown processes begin anew on the freshly deposited tephra (retardant upbuilding). In phase 3, incremental tephra deposition on the new soil continues and developmental upbuilding resumes (from McDaniel et al., 2012).

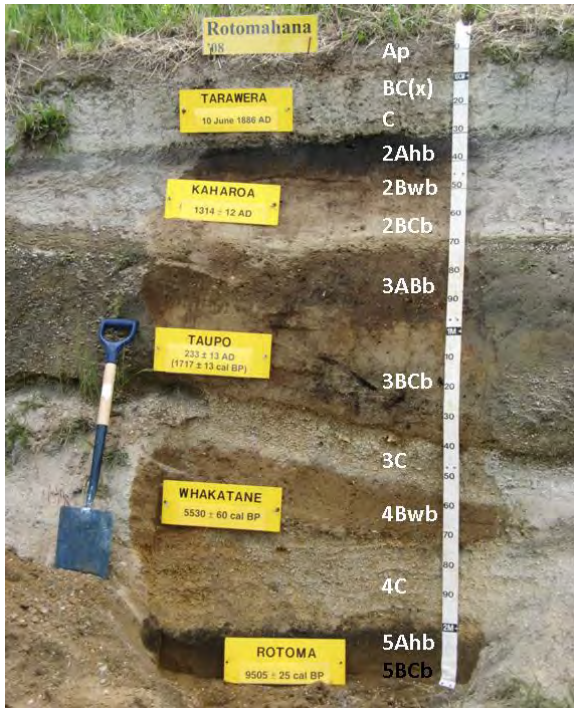

Fig. 21 Very clear example of a multilayered soil formed through retardant upbuilding at Brett Rd near Mt Tarawera. After each tephra is deposited, soil begins to develop until it is buried by another tephra and topdown pedogenesis begins operating in the fresh deposit. The buried 'mini' soil profile on Whakatane tephra (4Bwb, 4C horizons) reflects ~3800 years of pedogenesis, the amount of time it was at the land surface before burial by Taupo tephra; that on Taupo tephra (3ABb, 3BCb, 3C) reflects ~1100 years; that on Kaharoa tephra (2Ahb, 2Bwb, 2BCb) reflects ~570 years; and the topmost (surface) mini profile (Ap, BC(x), C) reflects ~120 years of pedogenesis on hydrothermally altered, mud-rich tephra deposited in AD 1886 by the Tarawera eruption (from McDaniel et al., 2012).

Buried brown rather than black 'topsoil' horizons

Buried 'A' horizons in New Zealand on tephra tend to be brownish rather than dark or black (and hence often have AB or Bw rather than Ah notations) and there is debate as to the reason for this. One suggestion is that in New Zealand they have largely been developed under podocarp-broadleaved forest until very recent times (last c. 700 years) and that such soils, especially Allophanic Soils, tend have brownish rather than dark A horizons anyway (this applies in USA for Andisols under conifers: P. McDaniel, pers. comm., 2008). Alternatively, or in addition, once 'A' horizons are buried then they may, depending on depth of burial, become isolated from the organic cycle and hence no longer receive new organic matter to maintain their darkness via melanisation (Fig. 22).

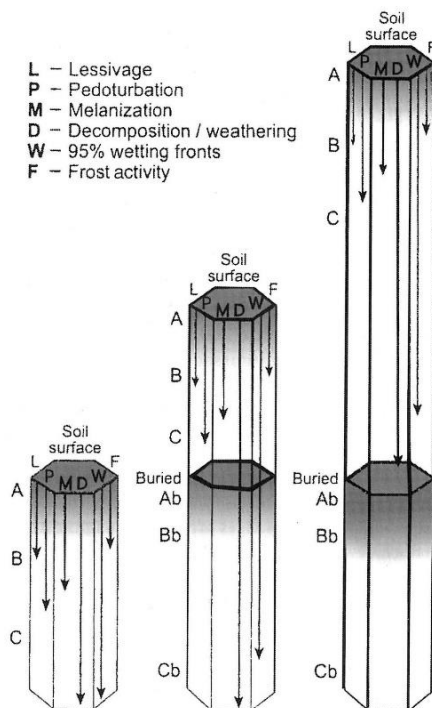

Fig. 22 Idealised models of buried soil horizons at different depths and how they may be impacted by surficial (topdown) processes (from Schaetzl and Anderson, 2005).

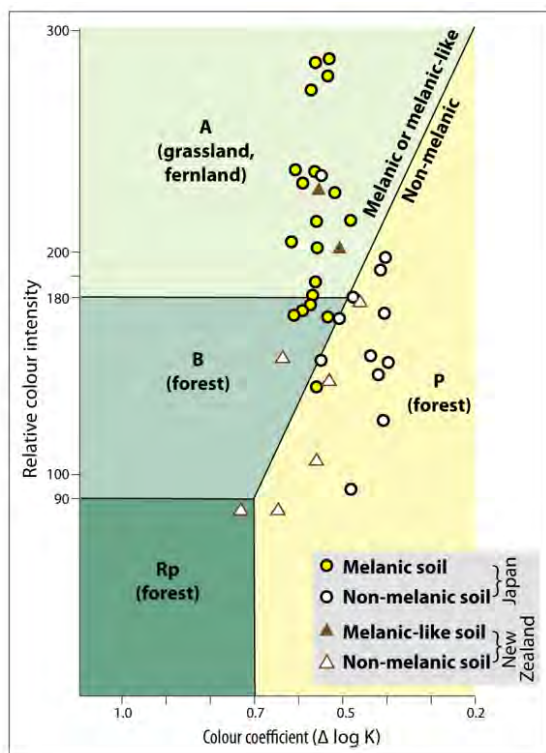

Fig. 23 Comparison of humic acids from tephr-derived soils in Japan and New Zealand (after Watanabe and Sakagami, 1999). The buried soil horizon on Kaharoa tephra is melanic-like and contains charcoal probably from Polynesian burning (also European burning in much of Bay of Plenty prior to the 10 June, 1886, eruption of Tarawera).

Residual colours after removing organic matter from A horizons by H_2O_2 or burning in the lab are similar to those of buried horizons on the tephras (P.J. Tonkin pers. comm., 2006). In some cases the depositional (burial) event may ‘scalp’ the topsoils (e.g., during emplacement of the Taupo ignimbrite), leaving effectively subsoils to represent the antecedent (now paleo) land surface. Forest fires following eruption events may also partially ‘bleach’ upper horizons (Wilson, 1994), and the effects of podzolisation (acid leaching), giving rise to bleached ‘E’ (albic) horizons over dark brown or reddish-brown podzolic-B (spodic) horizons are also evident in soils on Holocene tephras including on Taupo, Whakatane, and Rotoma tephras (Lowe et al., 2012).

Impacts of deforestation and burning, and the role of bracken fern, on the properties of surficial or buried soil A-horizons

Bracken fern (*Pteridium* spp.) is an aggressive plant that commonly invades disturbed sites. Its success as an invader is attributable, in part, to its ability to produce abundant growth, both below ground in the form of rhizomes and fine roots and above ground as fronds and stems (Table 4; Lowe and McDaniel, 2010). This biomass production has been shown to affect numerous soil properties. For many years, the black A horizons often found on Pumice Soils have been attributed ‘to bracken fern, which replaced much of the forest’. Analyses of humus and phytoliths in the A horizons of soils developed especially on Kaharoa and Taupo tephras in central North Island (buried beneath 1886 Tarawera eruptives in the parts of Bay of Plenty) showed that type-A humic acids predominated and that fernland and grassland had replaced the pre-existing forests (Fig. 23) (Birrell et al., 1971; Sase et al., 1988; Hosono et al., 1991; Sase and Hosono, 1996). Pollen, phytolith and associated studies, together with tephrochronology, have shown that human-induced deforestation by burning began in New Zealand soon after Polynesian settlers arrived (Newnham et al., 1998; McGlone and Wilmshurst, 1999; McWethy et al., 2009, 2014). The repeated burning resulted in the formation of extensive fernlands (McGlone et al., 2005).

Table 4 Bracken biomass comparisons – New Zealand and northern Idaho, USA*

Location	Rhizome biomass		Fronde biomass	
	Mean	Range	Mean	Range
		(kg m ⁻²)		(kg m ⁻²)
Nelson, New Zealand	--	7.08 (max.)	--	1.41 (max.)
New Zealand (23 stands)	2.92	0.91-5.19	--	--
Idaho, USA (9 stands)	1.96	1.14-2.54	0.52	0.27-0.89

*From Lowe and McDaniel (2010)

In northern Idaho, USA, establishment of bracken is associated with the conversion of allophanic to non-allophanic Andisol mineralogy (Johnson-Maynard et al., 1997). These changes include increased soil carbon, darker soil colours, lower pH, and increased organic forms of active Al. In Japan, a major part of soil organic carbon in Andisols and associated soils comprises humic acids, which are characterized by their stability and aromatic (humified) structure (Shoji et al., 1993; Hiradate et al., 2004). These features arise from the presence of labile and active metals, chiefly Al and Fe, supplied by the weathering of glass and other tephritic materials, which are able to bind humic substances through strong coordination bonding to form macromolecules of Al- and Fe-humic acid complexes very resistant to degradation or leaching (Hiradate et al., 2004).

The resultant very dark or commonly black A horizons, typically melanic horizons in *Soil Taxonomy* (Table 5), can contain up to 15% organic carbon (Hiradate et al., 2004). The Japanese pampas grass or 'susuki', *Miscanthus sinensis*, a C4 plant with large amounts of root residues, has been maintained artificially for millennia in ancient Japan to provide roofing material, straw bags, and fodder for grazing. Burning the grass in early spring before germination was common practice (buds of the pampas grass are several centimetres underground and so are not damaged) (Lowe and McDaniel, 2010). During burning, large amounts of very dark-coloured and charred microparticles were produced and these provided a second source of humic acids. The pampas grass has been regarded as a classic 'andisolizer' or 'melaniser' (Wada, 1986; Shoji et al., 1990, 1993; Hiradate et al., 2004).

Table 5 Main properties of melanic horizon*

- Munsell colour values and chromas of ≤ 2 (dark) throughout
- Melanic index ≤ 1.70 throughout
- $\geq 6\%$ organic C as weighted average
- Andic soil properties
- ≥ 30 cm thick

* After Soil Survey Staff (1999, p.23)

The relative importance of these two mechanisms – (1) stabilization of humic acids by complexing reactions with Al and Fe, or (2) cultivation of *M. sinensis* and its charred derivatives as a major source of carbon in humic acids – was evaluated by Hiradate et al. (2004) using $\delta^{13}\text{C}$ analyses of humic substances in a range of soils in Japan. Hiradate et al. (2004) were able to compare the contributions from C3- or C4-plant- derived carbon because *M. sinensis* was effectively the only C4 plant species in

(traditional) Japan. They found that the contribution to humic and fulvic acids of carbon derived from *M. sinensis* ranged from 18 % to 52 %. Their conclusions were that although highly-humified, i.e. dark-coloured, humic acids tended to be derived from C4-plant-derived carbon (ultimately *M. sinensis*), the dominant source of carbon for humic and fulvic acids in many cases was from C3 plants (mainly forest vegetation). Consequently, the overriding importance of active Al and Fe especially on the formation and accumulation of the dark-coloured humic acids in *Kuroboku* soils (Andisols) was reinforced (Hiradate et al., 2004).

In New Zealand the 'black' A horizons generally have melanic properties, but do not meet the thickness criterion for melanic epipedons, and hence are regarded as 'melanic-like'. As noted above, they formed under fernland and tussock grassland and most contain A-type humic acids (\pm charcoal). Non-melanic topsoils are formed under forest (most have non A-type humic acids, including Pg in P-type humic acids from deciduous trees) (Fig. 23). Differences between New Zealand and Japan thus relate largely to differences in human settlement history and impacts, with New Zealand having an exceptionally short prehistory of only c. 700 years (since c. 1280 AD) in comparison with >10,000 years in Japan (Lowe and McDaniel, 2010).

Stop 1 Endeavour Farm, Te Toke Road,

Location 38° 34' 29" S, 176° 14' 28" E; elevation ~358 m

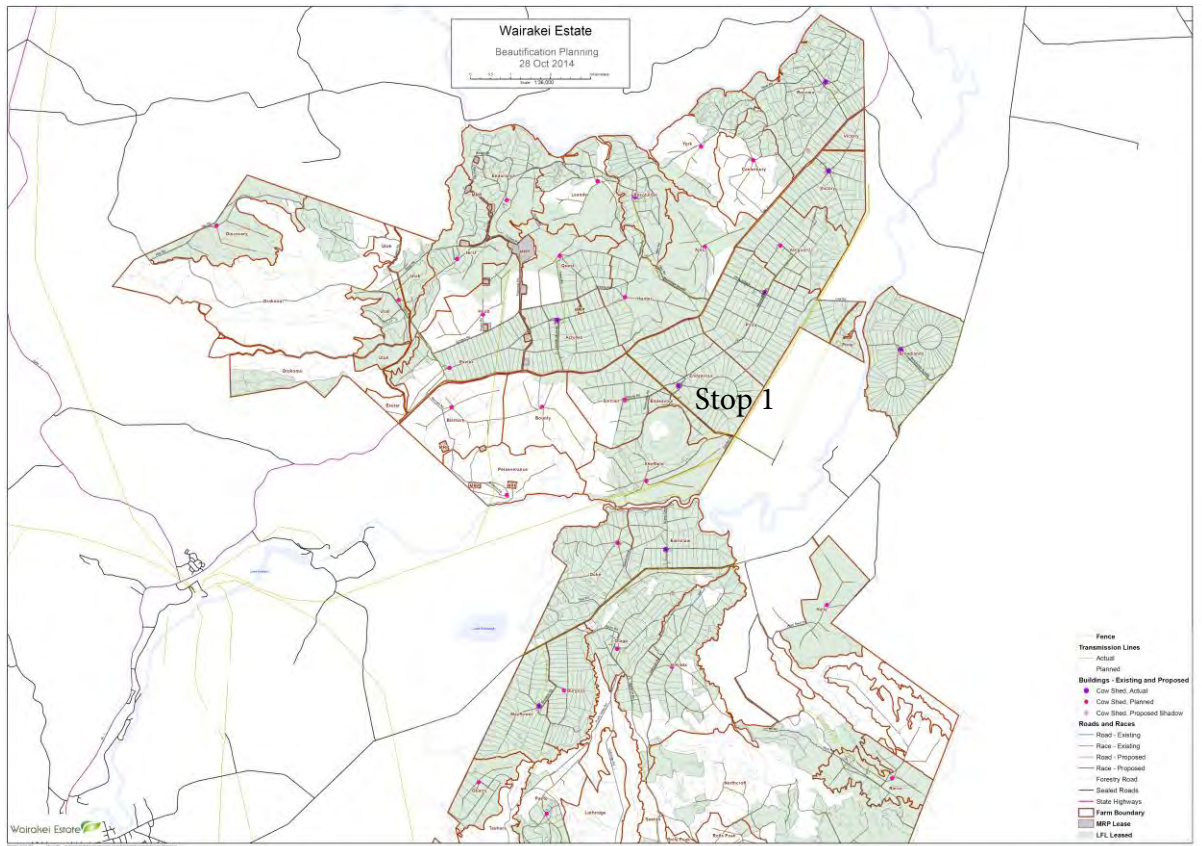

Landscape at Te Toke Rd looking towards Endeavour Farm (in shadow in middle distance). Photos: D.J. Lowe.



Entrance to Endeavour Farm.



Milking shed.



Transformation from pine plantation to pasture on SH5 near Te Toke Road. Photos: D.J. Lowe.

Healthy rivers: plan for change/Wai ora: He rautaki whakapaipai

Jon Palmer

Waikato Regional Council

The 'Healthy Rivers: Plan for Change' project is working with stakeholders to develop changes to the regional plan to help restore and protect the health of the Waikato and Waipa rivers, which are key to a vibrant regional economy. Once developed, the plan change will help, over time, to reduce sediment, bacteria and nutrients (nitrogen and phosphorus) entering water bodies (including groundwater) in these catchments. Waikato and Waipa River iwi and Waikato Regional Council are partners on this project, as set out in settlement and co-management legislation for the Waikato and Waipa rivers.

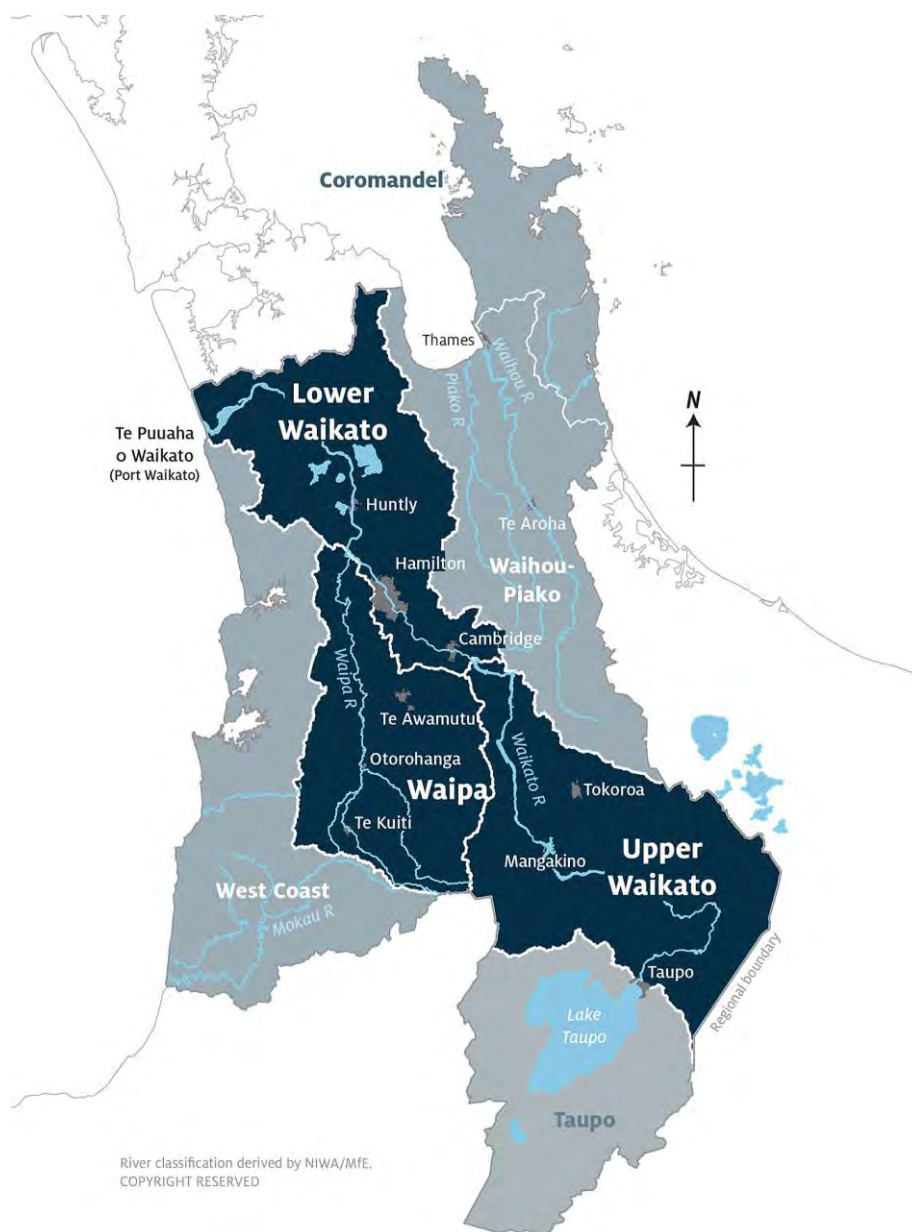

Waikato region: rivers and catchments

Why a plan change is needed

Developing a plan change:

- is legally required by the Vision and Strategy for the Waikato River/Te Ture Whaimana o Te Awa o Waikato and the Government's National Policy Statement for Freshwater Management 2014
- will tackle issues that are apparent in monitoring of the rivers, and prevent them becoming more difficult and expensive to fix
- will provide greater protection for fresh water – reviews of current Waikato Regional Council policy to protect fresh water state more protection is needed
- will help meet the expectations the Waikato community, iwi and industry hold for fresh water and the rivers.

Farmers, iwi, industry, local government and other stakeholders have already done much to address water quality, and are continuing to do so.

Water quality monitoring

- Nitrogen levels in both rivers, although low to moderate, have been slowly but steadily rising over the last 20 plus years, and, if nothing is done, will continue to rise. Nitrogen in groundwater can take decades to emerge into waterways, and this indicator of water quality will probably get worse.
- Phosphorus levels in both river are moderate, but mostly stable in the Waikato. In the Waipa, trends vary, but are rising in the most downstream monitoring site.
- Sediment levels in the lower reaches of both rivers are high, and have risen over the last 20 plus years.
- Bacteria levels are high in the Waipa and moderate in the Waikato from Karapiro to the mouth. The trends are stable.

In the Waikato River, biochemical oxygen demand and dissolved colour have improved, due to improvements in industrial discharges, such as those from dairy factories and meat works, and sewage plants. Chlorophyll *a* contamination has also decreased. Dissolved oxygen concentrations are mostly excellent, and levels of toxicants like ammonia, heavy metals and pesticides are low.

In the Waipa levels of E.coli are much lower than they were 50 years ago.

What the plan change will cover

It's too soon to say exactly what the proposed plan change will be, as it will be developed with stakeholders. However, it will set objectives, limits and targets for water quality in all water bodies. It also might include:

- limits and targets on contaminants such as bacteria and sediment entering water directly or via land
- property-level limits and targets for nitrogen and phosphorus, either as inputs or outputs
- specific outcomes for ecological health and recreation, fisheries and mahinga kai (food gathering)
- methods to help achieve limits and targets for sediment and bacteria, and ecological health and other outcomes, such as riparian fencing and planting.

Collaborating with stakeholders to develop the plan change

Collaboration with stakeholders and the community is key in developing the plan change and achieving lasting outcomes. Individuals and organisations will be involved in developing the plan change in a number of ways. The 25 member Collaborative Stakeholder Group (CSG) is the central channel for stakeholder and broader community involvement in the project. This group will:

- actively involve communities affected and understand their views
- play a key role in leading further opportunities for involvement
- review and deliberate on technical material on the environmental, social, cultural and economic complexities of the project
- recommend solutions to decision makers.

The CGS represents dairy farming, water supply takes, industry, rural professionals, horticulture, rural advocacy, energy, sheep and beef farming, local government, forestry, tourism and recreation, community, maori, and environmental non-government organisations.

The CSG focus statement is:

To come up with limits, timelines and practical options for managing contaminants and discharges into the Waikato and Waipa catchments to ensure our rivers and lakes are safe to swim in and take food from, support healthy biodiversity and provide for social, economic and cultural wellbeing.

The CSG's first workshop was in March 2014 and they will continue to meet every four to six weeks.

An alliance of technical experts

The Technical Alliance will play a crucial role in the development of the plan. This impartial, advisory group of specialists will provide technical information to the Collaborative Stakeholder Group. Key principles of the technical alliance are to:

- inform policy development by providing expert advice
- narrow the points of debate

The Technical Alliance will collate, analyse, summarise and present environmental, social, cultural and economic information about the rivers and the consequences of different land management scenarios. This information will be used by the Collaborative Stakeholder Group and decision makers on the proposed plan change. The Technical Alliance comprises a core Technical Leaders Group and a second wider group of around 80 experts who will be called upon as required.

When it's happening

We expect to notify the proposed plan change in 2015. Allowing a couple of years for hearings, and any Environment Court appeals, the whole plan could be operative in 2019.

Background and development of rules affecting land use in the Lake Taupo catchment

Jon Palmer

Waikato Regional Council

Introduction

The Waikato Regional Plan Variation 5 – Lake Taupo Catchment (“RPV5”) – adds a new section to the Waikato Region Plan to provide policies and methods to protect the water quality of Lake Taupo. This section arose in response to increasing pressures for land-use intensification in the catchment during the late 1990s, along with signs that lake water quality is starting to decline. The variation has been appealed to the Environment Court and a decision is pending in the near future. Many staff within Waikato Regional Council and other organisations have contributed to the development of the Variation. This summary is taken from other Waikato Regional Council reports.

Land use and ownership in the Lake Taupo catchment

Lake Taupo is 622 square kilometres in area. The lake's catchment (watershed) has an area of 3487 square kilometres (including the lake). In addition to the urban centres at Taupo and Turangi, there are several smaller settlements around the lake, some of which are in the process of expansion and development. Land uses in the catchment can be broadly divided into pastoral farming, planted production forestry, and undeveloped land (including indigenous forest). Most farms are drystock, mainly mixed sheep and beef, with some farms also running deer. There are six dairy farms in the catchment with four located entirely within the catchment and two partly within the catchment.



NASA space shot of Lake Taupo and its catchment (from Nathan, 2007).

[NASA JSC Digital Image Collection](#)
(reference ISS005-E-21107)

Ngati Tuwharetoa is the iwi with mana whenua (traditional land tenure) in the lake's catchment. Its rohe (territory) includes the catchment of Lake Taupo and stretches further on all sides. Collectively, Ngati Tuwharetoa represents the largest private land owner in the catchment. Approximately 110,000 ha or 40 percent of land in the catchment is in Maori ownership.

Threat to water quality

Scientific evidence gathered over the last 30 years shows that the water quality in Lake Taupo is under threat. The lake currently has excellent water quality, reflected by extremely low levels of plant nutrients and phytoplankton. This means that the lake has very clear water. The excellent water quality is threatened by increasing nitrogen loads entering the lake, particularly from farming activities, but also from wastewater from community sewage treatment plants and septic tanks. Nitrogen is a nutrient which increases tiny, free-floating algae in the lake water, and these algae make the water look murky. Increased nitrogen in the lake also can cause an increase in some lake weeds and an increase in slimy growths on the lake bed.

If the water quality of Lake Taupo were allowed to continue to deteriorate, it would eventually result in adverse impacts on the economy of the Taupo area, given its dependence on tourism and recreation.

Consultation and partnerships

In response to concern about changes in the lake and the potential for future intensification, Waikato Regional Council commissioned technical investigations in mid-2000 to learn more about lake water quality and the influence of catchment land uses. It also circulated an issues and options paper amongst key stakeholders and the general public and invited local people to public meetings. In 2001, Environment Waikato resolved to take steps to protect the lake from any further long-term decline in water quality. The principal objective was to maintain current water quality in Lake Taupo in the long-term. The time scale was intended to allow for the fact that groundwater in the catchment takes many years (decades) to reach the lake.

Following this, Environment Waikato began a further extensive period of consultation with stakeholders including central Government, the Taupo District Council, Ngati Tuwharetoa, and other landowner groups in the catchment, to formulate a strategy to achieve the objective stated above. The strategy that was developed involves a two-pronged approach, each equally important. (1) A planning or resource management approach under the Resource Management Act (RMA), and (2) the establishment of a public fund to assist landowners to reduce their outputs of manageable nitrogen. The first approach has resulted in Variation 5 to the proposed Waikato Regional Plan. The second has resulted in the formation of the Lake Taupo Protection Trust. This trust has been established through consultation with local and regional communities to establish rating contributions from Environment Waikato and Taupo District Council and a central Government taxpayer-funded contribution. This fund is administered by the Lake Taupo Protection Trust, which is a council -controlled organisation established under the Local Government Act 2002. The trust is overseen by a joint committee comprising two representatives from Government, Ngati Tuwharetoa, Taupo District Council and Environment Waikato.

The regional plan variation

Nitrogen can enter the lake from a variety of sources including animal urine, rainfall, nitrogen-fixing plants such as clover, planted production forest, sewage, and urban runoff. Some of these sources can be managed to reduce the amount of nitrogen entering the lake. RPV5 focuses on controlling the amount of nitrogen from these manageable sources. Pastoral farming is responsible for 93 percent of the manageable load of nitrogen to the lake, and sewage and storm-water for 7 percent.

The main objective of RPV5 is for 2001 water quality levels in Lake Taupo to be maintained by 2080. The reason for the long time-frame is that it takes many decades for nitrogen to travel from where it enters the ground until it reaches the lake. Because land was less intensively farmed in the catchment 50 years ago, the nitrogen currently entering the lake is at a lower concentration than it will be in years to come. Therefore, nitrogen levels in the lake are likely to get worse before they get better. The most important thing that the RPV5 rules do is to cap the amount of nitrogen entering the catchment at current levels. It does this through a series of policies and rules that manage land-use activities and wastewater discharges.

To cap nitrogen from land uses, the rules ensure people in the lake catchment manage their land-use activities so that nitrogen leaving their land (that is, leaching through soil) does not exceed the average nitrogen leaching from their land over the period 2001 to 2005. People's nitrogen allowance is said to be 'grandparented'. This means, for example, that if a farm was leaching 14 kilograms of nitrogen per hectare per year in the past, then it can continue to do so. Most farmers will need to obtain a resource consent from Waikato Regional Council to remain farming under RPV5. Through the consent process

they were given a nitrogen discharge allowance (NDA) which will be equivalent to the amount of nitrogen per hectare per year that their land leached on the most favourable year for the land owner in the benchmark period between 2001 and 2005. Their NDA was ‘benchmarked’ at this level using a computer model called Overseer. Farm information such as stock numbers and fertiliser rates for the farm during this benchmark period were put into the Overseer model to generate the NDA. The Overseer model was also be used in the preparation of a farm nitrogen management plan which describes the way the farm will be managed to achieve the NDA.

RPV5 also provides a way that land owners can trade nitrogen. Such trading is done by one land owner increasing his/her consented NDA at the same time that another land owner decreases his/her NDA, by changing their respective consents. RPV5 also has policies and methods relating to the public fund. In particular, there is a requirement for the public fund to be used to permanently reduce nitrogen from rural land use activities by 20 percent. This is to ensure that the additional nitrogen yet to enter the lake from ground water will be offset by a nitrogen reduction, so that lake water quality reverts to 2001 levels by 2080. The \$80 million fund was primarily used to purchase nitrogen permanently from landowners and the cumulative purchase will result in the 20% reduction when completed.

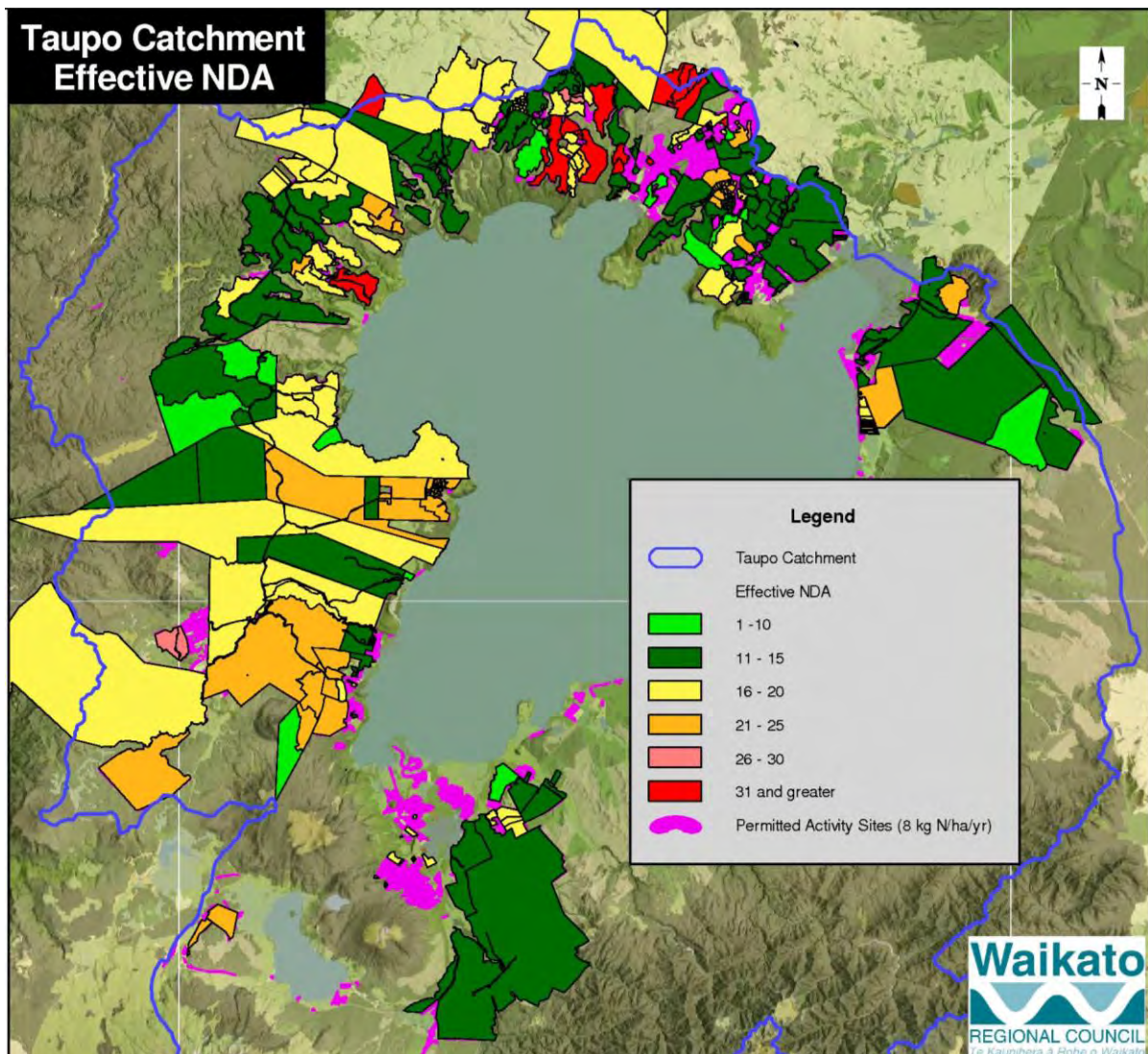

Taupo Benchmarked Farms NDA values.

Hearings, submissions and appeals

RPV5 was notified on 9th July 2005. In all, 136 submissions were received. The hearing began on 1 May 2006 and the hearing committee heard evidence and submissions from 123 witnesses representing 69 parties. The 'Council Decisions Version' of RPV5 was released in February 2007. Nine appeals were lodged with the Environment Court with respect to the Waikato Regional Council decision and the appeal was heard from May 2008. The court decision, an interim ruling, was released on 12 November, 2008, and upheld Waikato Regional Council's proposed set of rules designed to effectively cap the amount of nitrogen entering the catchment at current levels. Policy was finally signed off by the environment court judge in February 2011.

Project achievements

- All farms in the Taupo Catchment have now been benchmarked – 116 farms over 368 parcels of land, covering 67,000 ha. This represents 26% of the total catchment.
- The average NDA was 17 kg N/ha/yr – average dry-stock being 16 kg N/ha/yr and average dairy being 36 kg N/ha/yr. The range of NDAs benchmarked was 6 kg N/ha/yr to 55 kg N/ha/yr.
- There were also many small holdings (lifestyle blocks) that were not benchmarked because of the unavailability of auditable data – covering 5,800 ha.
- 151,000 kg N/yr has been purchased by the Lake Taupo Protection Trust from 26 farms. So there is 151,000 kg less nitrogen entering Lake Taupo annually – predicted nitrogen loss from Overseer. 18,000 kg of nitrogen has also been traded between farmers.
- There has been significant land use change bought on by the policy including 5,800 ha of new forestry, 163 ha converted from dairy farming to forestry, 5,637 ha converted from dry-stock farming to forestry, and 680 ha converted from dry-stock to dairy farming.
- Some innovations have also been borne from RPV5 including Taupo Beef – a premium beef product that has been endorsed by Waikato Regional Council based on their environmental auditing, and is outselling standard beef products in local restaurants – customers are willing to pay a premium for this product based on the endorsement and its quality.

Changes in soil total C and N contents at three chronosequences after conversion from plantation pine forest to dairy pasture on a New Zealand Pumice soil

G. P. Sparling^{A,C}, R. Lewis^A, L. A. Schipper^A, P. Mudge^{A,B}, and M. Balks^A

^ADepartment of Earth and Ocean Sciences, University of Waikato, Private Bag 3105, Hamilton 3240, New Zealand.

^BCurrent address: Landcare Research, Private Bag 3127, Hamilton 3240, New Zealand.

^CCorresponding author. Email: sparling@waikato.ac.nz

Abstract

The large amounts of carbon (C) and nitrogen (N) sequestered as organic matter in soils have implications for global and national C and N balances and greenhouse gas emissions. Changes in soil management can affect the amount of C and N stored in soil. We investigated the change in land use from radiata pine plantation to ryegrass–white clover dairy pasture on the total C and N content of Taupo Pumice Soil. Samples were taken at three study sites (Atiamuri, Tokoroa and Wairakei) in North Island, New Zealand. Soils were cored to 60 cm depth and subsampled by soil horizon, and bulk density cores were taken from soil pits. A chronosequence of sites was obtained after conversion from pines to pasture. Long-term pastures (40–80 years) and mature pine plantations were included for further comparison. Regression analyses were completed after logarithmic transformation of the time data. The data were highly variable, but significant ($P < 0.05$) increases in total C and N were found at the Atiamuri and Wairakei sites. However, there was no significant change in the total C content of the profile at the Tokoroa site. Increases in total C and N were greatest in the Ap horizon and were most rapid 1–5 years after conversion. Overall rates of increase in the first 10 years after conversion were 0.167 kg C m⁻² year⁻¹ for total C and 0.032 kg N m⁻² year⁻¹ for total N, dropping to 0.027 kg C and 0.005 kg N m⁻² year⁻¹ for the 10–50-year period. The change in land use from plantation forest to dairy pasture has resulted in a moderate increase or no change in soil storage of C. Compared with total C, increases in total N storage were proportionately greater in all three examples of this Taupo Pumice Soil.

Additional keywords: deforestation, land use change, pasture chronosequence, soil carbon, soil N, soil storage.

Taupo tephra sequence and soil, Endeavour Farm

Location 38° 34' 29" S, 176° 14' 28" E; elevation ~358 m



Location of soil pit on Endeavour Farm near the troughs. Wayne Tangney excavating. Photos: D.J. Lowe.

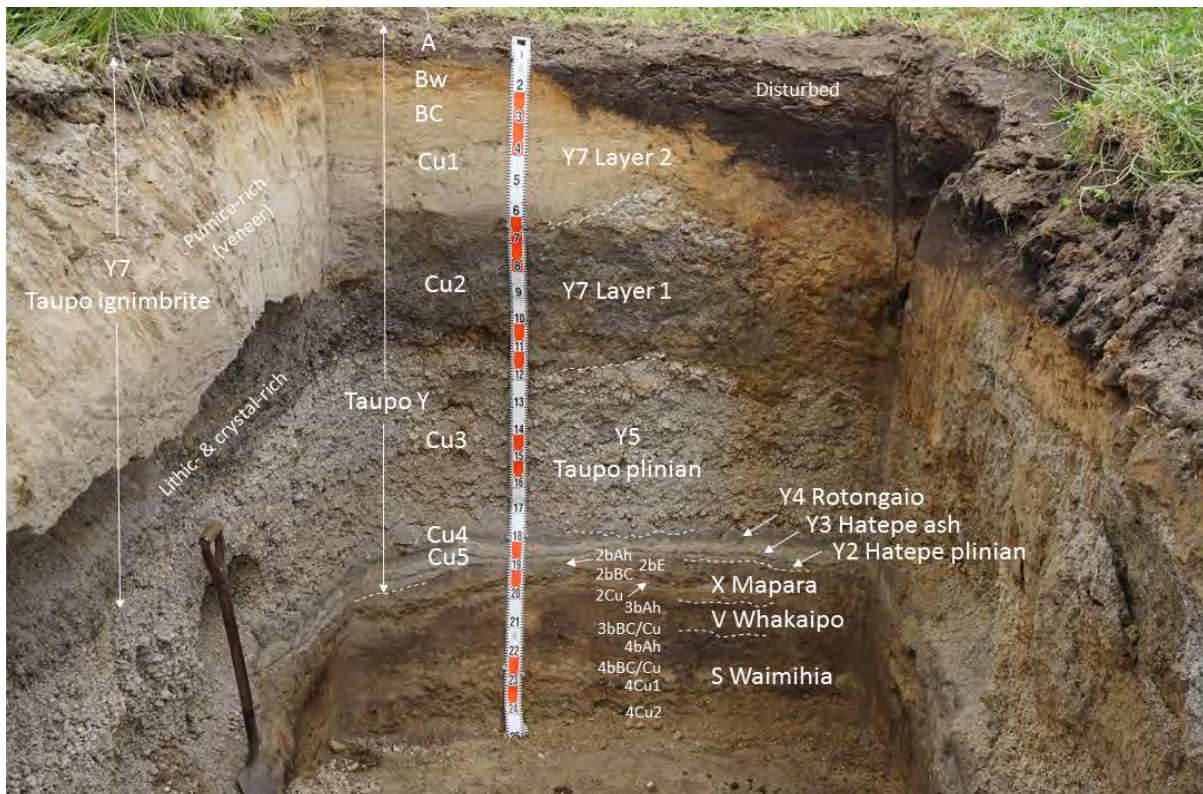

Soil pit showing stratigraphy associated with deposits from the Taupo eruption and several earlier volcanic events, and horization of Taupo sand. See part 1 of guide for interpretation, especially Fig. 8 (pp.16-17). Tephra names (units from Wilson, 1993; other names from Froggatt and Lowe, 1990) and ages (from Lowe et al., 2013): Unit S, Waimihia (3401 ± 108 cal yr BP), Unit V, Whakaipo (2800 ± 60 cal yr BP), Unit X, Mapara (2059 ± 118 cal yr BP); Unit Y, Taupo (1718 ± 10 cal yr BP or AD 232 ± 10): Y2, Hatepe plinian; Y3, Hatepe ash; Y4, Rotongaio ash; Y5, Taupo plinian, Y7, Taupo ignimbrite (layer 1 “ground layer”, and layer 2 “venerer”). Horization based on Clayden and Hewitt (1994). Photo: D.J. Lowe.

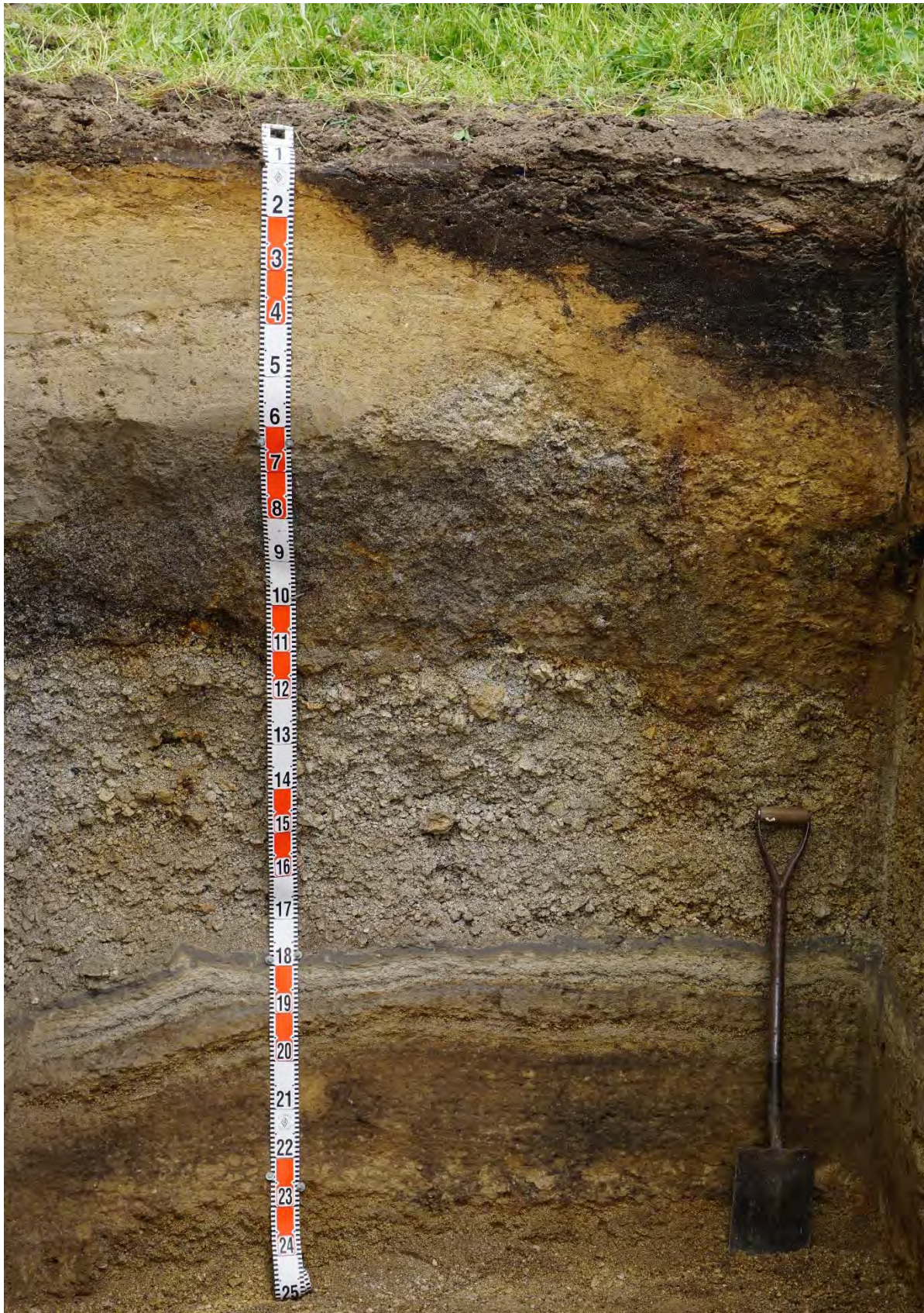

The soil is classified in NZCS as an Immature Orthic Pumice Soil, tephric, na (Rh fines), sandy, rapid (Hewitt, 2010; Webb and Lilburne, 2011) (nearly an Impeded Orthic Pumice Soil, which requires a 'welded' subsoil < 90 cm depth, brittle, with no roots, but sparse fine roots are present in this profile within 90 cm of surface). In *Soil Taxonomy* it is a Typic Udivitrand, ashy-pumiceous, glassy, mesic (Soil Survey Staff, 2014). Photo: D.J. Lowe.

Soil profile description and analyses of Taupo sand, Wairakei

Landform and site location: summit of hill on (former) Wairakei Research Station ~500 m north of Wairakei Village (see Rijske and Vucetich, 1980)

Parent material: Pumiceous tephra – Taupo Tephra 232 ± 10 AD (stratigraphy indicated)

Location U17 799834, elevation 450 m asl, rainfall ~1280 mm. Well drained

NZSC: Immature Orthic Pumice Soils

Soil Taxonomy: Ashy-pumiceous, glassy, mesic Typic Udivitrands

Analytical data from Parfitt et al. (1981) and Lowe and Percival (1993)

(Note: in description below, Y3 +Y3 should read Y3 + Y2)

Profile description and stratigraphy of Taupo sand at Wairakei

Profile	Depth (cm)	Description	Stratigraphic Unit
Ap	0- 9	very dark brown (10YR 2/2) gritty sand; friable; weakly developed medium and fine nut structure breaking to crumb and granular structure; many fine lapilli (2-6 mm) of yellowish brown(10YR 5/6) colour; few fine black (10YR 2/1) pieces of charcoal; many fine roots; distinct smooth boundary,	Y7 (Taupo ig)
Bw	9-24	yellowish brown (10YR 5/6) and olive yellow (2.5Y 6/6) gravelly sand; friable; weakly developed medium block structure breaking to crumb and single grain; many fine grey (10YR 5/1) rhyolite fragments; few medium (10 mm) yellowish brown (10YR 5/6) lapilli; many fine roots; few coarse roots; indistinct irregular boundary,	
BC	24-34	pale brown (10YR 6/3) gritty sand; very friable; weakly developed crumb and granular structure; many fine grey (10YR 5/1) rhyolite fragments and few yellowish brown (10YR 5/6) lapilli; many fine roots; distinct irregular boundary,	Y5 (Taupo plin)
C1	34-64	very dark grey (10YR 3/1) and very pale brown (10YR 7/4) fine gravel (2-5 mm); mainly rhyolite (max. size to 50 mm) loose; single grain; few black (10YR 2/1) carbonised branches (40-50 mm); abundant fine roots; distinct irregular boundary,	
C2	64-95	yellow (10YR 7/6) pumice lapilli; loose; single grain; strong brown (7.5YR 4/6) and yellowish brown (10YR 5/8) iron staining on lapilli; lapilli vary from 5 to 100 mm; many medium grey (10YR 5/1) rhyolite fragments (4-8 mm) few reddish brown (5YR 4/4) rhyolite fragments; few fine roots; sharp smooth boundary,	Y4 (Rotongaio)
C3	95-102	grey (10YR 5/1) loamy sand; friable; weakly developed medium block structure breaking to weakly developed fine blocky and crumb structure; many distinct dark yellowish brown (10YR 6/6) tubular staining; sharp smooth boundary, (Rotongaio Ash)	
C4	102-103	very pale brown (10YR 7/4) pumice gravel (2-10 mm); loose; single grain; sharp smooth boundary,	Y3 + Y3 (Hatepe)
C5	103-104	light grey (2.5Y 7/2) gritty loamy sand; firm; massive; sharp smooth boundary,	
2bAh	104-108	dark brown (7.5YR 3/4) loamy sand; slightly greasy; soft; massive breaking to single grain; sharp smooth boundary,	X (Mapara)
2C	108-113	brown (10YR 5/3) and yellowish brown (10YR 5/6) gritty sand; loose; single grain; abundant fine lapilli (5-10 mm); distinct smooth boundary,	
3bBw	on	yellowish brown (10YR 5/6) gritty loamy sand; slightly greasy; slightly firm; weakly developed medium blocky breaking to crumb and single grain; many fine (2-3 mm) lapilli.	V (Whakaipo)

Stop 2 View Road land disposal site

Nicola Hancock

Taupo District Council



Overview of the Taupō Wastewater Treatment Plant

The Taupō Wastewater Treatment Plant (WWTP) was commissioned in 1975 to treat wastewater from the Taupō township which at the time had a population of approximately 12,500. It was originally designed to remove 80% of suspended solids and 80% of the biological oxygen demand (BOD). A number of upgrades to the WWTP have been undertaken since the site was commissioned, the first major one in 1985 which effectively doubled its capacity to allow it to serve a population of approximately 27,000 and improve solids and BOD removal to 90%. Upgrades to the WWTP are ongoing, with a recent addition of a third digester and additional trickling filter.



Taupo WWTP

WWTP processes include primary clarifiers, trickling filters, a secondary (humus) clarifier as well as sludge conveyance, thickening, digestion, dewatering and disposal as follows:

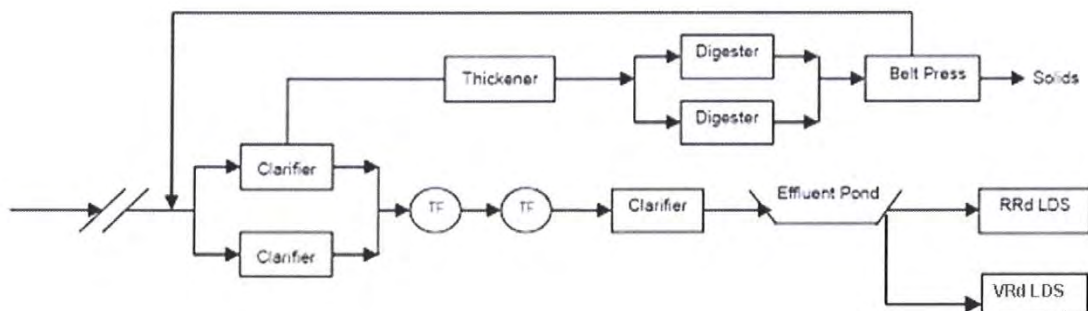

Up until 1995, the discharge of treated effluent was directly to the Waikato River. At this time it was recognised that the direct discharge was culturally and environmentally unacceptable and a change to the method of disposal was implemented. A three stage pumping system and storage ponds were built to transfer the effluent for land disposal at a site 5 km north of Taupo. The Taupo Sewage Land Disposal Scheme (referred to as the Rakaunui Road LDS) was opened in September 1995 and built at a cost of \$5.3 million.

In December 2008, an additional LDS site started operating at View Road. Prior to this, Council was having difficulty complying with nitrogen application and hydraulic loading rate resource consent limits specified for the Rakaunui Road LDS which would only prove more challenging as the Taupō population increased. In addition, the Eastern Arterial highway (ETA) was planned to dissect the Rakaunui Road LDS resulting in significant loss of land disposal area. This resulted in the purchase and development of the View Road land disposal area of which approximately half is currently utilised for effluent disposal.



Image showing locations of WWTP, Rakanui Rd LDS, View Rd LDS, the ETA highway, and Taupo township.

LDS operation

Approximately 6,100 m³ of treated effluent is disposed of each day. Effluent discharge is via “pop up” sprinklers at Rakaunui Road and pivot irrigators at View Road. The 145 hectare Rakaunui Road LDS is divided into 10 blocks, 30 spray areas and pipe work for 3,300 pop-up irrigation sprinklers. A 20-metre wide buffer zone protects the public from spray drift.



Irrigation at Rakanui Road.



Harvested bales at View Rd.



Pivot irrigator at View Rd



Groundwater monitoring at View Rd.

The View Road LDS consists of 8 pivot irrigators discharging to 118 hectares which irrigate on to a ryegrass pasture (cultivar 'impact'). Grass from each site is harvested and baled approximately 4-5 times between September and May, with the proceeds from bale sales being used to supplement operational costs. Over the 2013-2014 harvesting season, 8130 bales were removed from Rakaunui

Road (approximately 14 t DM/ha) and 8102 from View Road (approximately 16 t DM/ha). The demand for bales is very high throughout the country with most presold early in the growing season.



Sign of the times. Photo at View Rd site taken in mid-November 2014 (photo: D.J. Lowe).

Taupo is one of New Zealand's largest animal feed providers. However, the supply of feed to lactating cows could potentially be a future issue with new rules imposed by Fonterra on farmers regarding the supply of feed exposed to human waste. It is unlikely this will affect bale sales due to the high demand. Land surrounding irrigated areas at View Road LDS has been planted in Lucerne to maximise return from available land. A section of View Road is currently utilised for biosolids storage. After a stand down period of 18 months, solids are sold for private composting business. Council have run a biosolids application trial on an upper section of the View Road site and is seeking resource consent to make this a regular part of the wastewater treatment operation in future.

Monitoring

In its first 10 years of operation, the Rakaunui Road LDS was one of the most highly monitored sites in the Southern Hemisphere. As knowledge of the sites operation and performance has improved (and costs of monitoring increased), monitoring has been somewhat reduced. Monitoring at both LDSs currently includes:

- Testing of effluent effluent quality prior to discharge
- Quarterly groundwater sampling of 9 bores at Rakaunui Road (one monitoring bore was buried under the highway) and 13 bores at View Road
- Testing of grass at the time of harvest
- Monitoring of the harvested haylage for feed quality prior to sale, results of which are made available to farmers and used to charge a premium price for high quality product
- Soil fertility testing, results of which are used by the operators to determine fertilising requirements
- Soil and pasture health monitoring
- Monitoring of stormwater runoff, should it occur
- Monitoring of springs, should they appear (historically one spring at Rakanui Road was monitored until it was burried under the ETA – no springs have developed at View Raod since the site was commissioned)
- Historical monitoring of soil lysimeters at Rakaunui Road and during the nitrogen trial at View Road.

Site performance

The WWTP provides secondary treatment of wastewater and is not designed for nutrient removal. The Land Disposal Sites at Rakaunui and View Roads are a fundamental part of the wastewater treatment system and are targeted towards nutrient reduction. A summary of site performance and compliance with resource consents, based on monitoring data from 2013-2014 and the OVERSEER model is as follows:

	Rakaunui Road		View Road	
	<i>Measured</i>	<i>RC limit</i>	<i>Measured</i>	<i>RC limit</i>
Volume applied	2,700 m ³ /day	9,000	2100 m ³ /day	15,000
Nitrogen applied	332 kg/ha/year	640 kg/ha/year	259 kg/N/ha/year	550 kg/ha/year
	0.97 kg/N/ha/day		0.7 kg/N/ha/day	
Nitrogen removed in bales	298 kg/N/ha		310 kg/N/ha	
	80 %		120 %	
Estimated N leaching losses	35 kg/N/ha		<10 kg/N/ha	
Estimated NO ₃ N concentration in drainage	<10 g/m ³		2 mg/L	
Hydraulic loading rates	2.4 mm/day		1.7 mm/day	15 mm/day
	17 mm/week	35 mm/week	12 mm/week	45 mm/week

- Last year was one of the best to date in terms of site performance (bale numbers and percentage N removal)
- The land treatment operation is successful largely due to the pumices soils. The Atiamuri and Whenuaroa soils form the majority of the soils on the View Road site and are a good representation of Rakaunui soils being gritty and gravelly sandy loams with high hydraulic conductivities which allow the soil to accept the volume of effluent required.
- Phosphorus is not an issue as it is taken up and removed by grass. The Olsen P status of View Road soils is currently just below the target range for pumice soils. Phosphorus is usually near detection limits in groundwater.
- At View Road there are currently no definitive effects of discharge on groundwater quality which has remained stable since the site was commissioned.
- At Rakaunui Road groundwater shows signs of impact by wastewater discharges. These have stabilised and reduced in some areas following the opening of View Road LDS

View Road nitrogen trial

The 550 kg/N/ha/year nitrogen loading limit imposed by the resource consent is lower than Rakaunui LDS and was determined through a desk top study undertaken by the WRC during the application process. Council obtained a special consent condition allowing it to undertake a N trial on a section of the site, where nitrogen leaching could be physically monitored under different application rates. If Council could demonstrate that leaching under higher application rates was less than 30 kg/N/ha/yr, then a variation to the consent application rate could be sought. An increase in N loading limit would have substantial economic benefits for the Taupō District in terms of managing future growth.

The trial was undertaken from 2008 to 2012 in conjunction with the University of Waikato (see below) and provided valuable information for assessing nitrogen uptake by pasture and leaching losses under different application rates. Results demonstrated that the nitrogen loading rate of 550 kg/ha/year was an ideal limit and that leaching losses in excess of 30 kg/N/ha/year would be unlikely up to this point. At an application rate of 550 kg/N/ha/yr (the current resource consent limit), approximately 6% or 33 kg/N/ha/yr was anticipated to be lost to leaching. The trial also showed that the OVERSEER model accurately predicted leaching losses, although to much less accuracy than that demonstrated in the trial. As a result, Council have not pursued a change in resource consent to increase nitrogen loading rates.

Nitrogen leaching from effluent irrigation: Taupo District Council View Road effluent treatment site

Glen Treweek¹, Megan Balks², and Erin Telfer³

¹Lincoln University, ²University of Waikato, ³SMEC Australia, Canberra

Taupo township (population of approximately 20,000) irrigates all of its treated municipal wastewater onto ryegrass pasture in a cut and carry system. Regulatory authorities have set a target maximum N leaching rate of 30 kg N/ha/year from the Taupo land treatment scheme. In order to maximise the economic efficiency, while preventing environmental degradation, the optimum rate of effluent irrigation must be determined in field conditions. There have been very few field-scale studies where varied effluent N loading rates have been tested at land treatment schemes.

The objectives of this study were to determine the rate of N leaching, and uptake of N by the pasture of a cut and carry system, under four effluent loading rates, with field scale replication. A lysimeter trial was established in 2009 to determine the N loss from soils at the View Road effluent irrigation site. Forty eight lysimeters, containing “undisturbed” soil from the site were installed under two pivot irrigators that were programmed to slow down and speed up to provide varying rates of effluent application (Fig. 1).

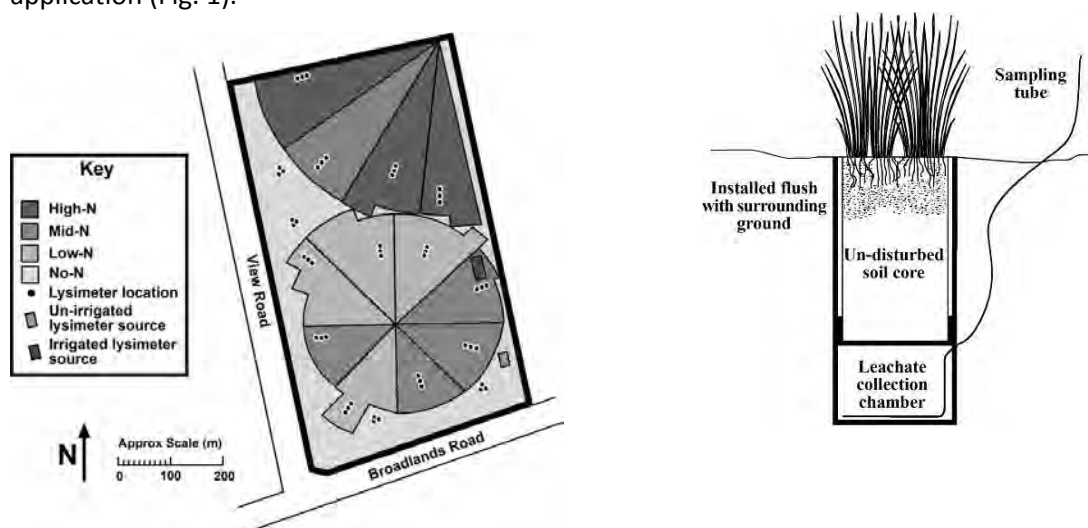

Fig. 1. Lysimeter installation at View Road effluent Irrigation site, Taupo. Left: map of lysimeter installation sites and programmed effluent application rates. Right: Diagram of lysimeter design (from Treweek, 2011).

The Taupo soil (Fig. 2) is a coarse textured, moderately-well to well-drained Immature Orthic Pumice Soil (Hewitt, 2010), or Typic Udivitrand (Soil Survey Staff, 2014) formed on rewashed detritus from the c. AD 232 Taupo eruption. In the decades prior to 2008, the site was a long-term drystock sheep and beef farm. In December 2008, irrigation with municipal effluent onto a recently sown ryegrass pasture (*Lolium perenne*, “Impact”) began. The cores were carved and lysimeters installed in September 2009. They were left to equilibrate for three months and measurements were undertaken from January to December 2010 (Treweek, 2011) and then from Oct 2011 until Sept 2012 (Telfer, 2013).



Fig. 2. Taupo Soil on pumice at View Rd effluent irrigation site.

Leaching, and pasture uptake of nitrogen measured under four different N loading treatments nominally no-N (0 kg N/ha. year), low-N (280-350 kg N/ha. year), mid-N (350-450 kg N/ha. year), and high-N (450-570 kg N/ha. year). To determine the actual loading rate, a rain gauge was situated next to each lysimeter, which was read at the time of leachate collection. There was very little difference in the N leached between the first and second measurement periods (Table 1), and even the highest rate was within, though near, the consent limits.

Table 1 Mean and std deviation nitrogen leached from lysimeters through two measuring periods.

Treatment	Mean N leached in the first monitoring period (2010) ¹ kgN/ha/yr	Mean N leached in the second monitoring period (2011/12) ² kgN/ha/yr
No N	5 +/- 3	2.8 +/- 0.6
Low N	15 +/- 1	12.7 +/- 4
Med N	17 +/- 8	16 +/- 7
High N	26 +/- 4	28.6 +/- 10

¹From Treweek (2011), ²From Telfer (2013)

Pasture production was higher in effluent irrigated sites than the controls in both years but there was no significant difference between the effluent treatments (Figure 3). The highest N loading of effluent correlated with the highest N concentration in the pasture (Figure 3). The N balance shows that the vast majority of the applied effluent was taken up by pasture, with minimal differences between the two measuring periods (Table 2). The rate of un-recovered N was highest under the highest N loading, suggesting greater rates of N accumulation in soil, denitrification, or volatilisation under high rates of effluent application.

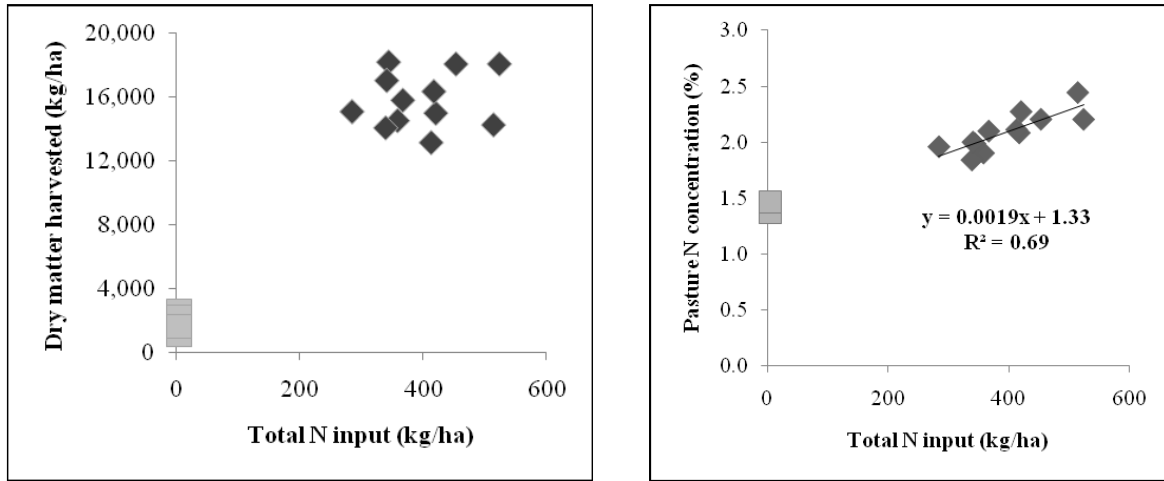

Fig. 3. Pasture dry matter production (left) and N concentration (right) in relation to N input from effluent (from Treweek, 2011).

Table 2 Mean fate of applied N through two measuring periods.

Fate of applied effluent N	First monitoring period (2010) ¹	Second monitoring period (2011/12) ² .
Pasture uptake	84%	79 - 100 %
Leached	5%	4-6%
Unaccounted for	11%	4-16 %

¹Mean across all treatments (Treweek, 2011). ²Range of means for each individual treatment (Telfer, 2013).

It is likely that N has begun accumulating in the soil organic matter under the higher rates of irrigation, and the soil may eventually reach N saturation if N input exceeds N removal. If N saturation of the soil occurs, the rate of leaching may increase. Further increases in efficiency, and the potential to increase effluent application rates beyond those presented in this study, might be achieved by more frequent pasture harvesting (Telfer, 2013).

Stop 3 Quarry section Holocene tephra-buried soils, Smeith Farm, Whirinaki Rd, Galatea area

Location 38° 27' 46" S, 176° 44' 01" E; elevation ~200 m

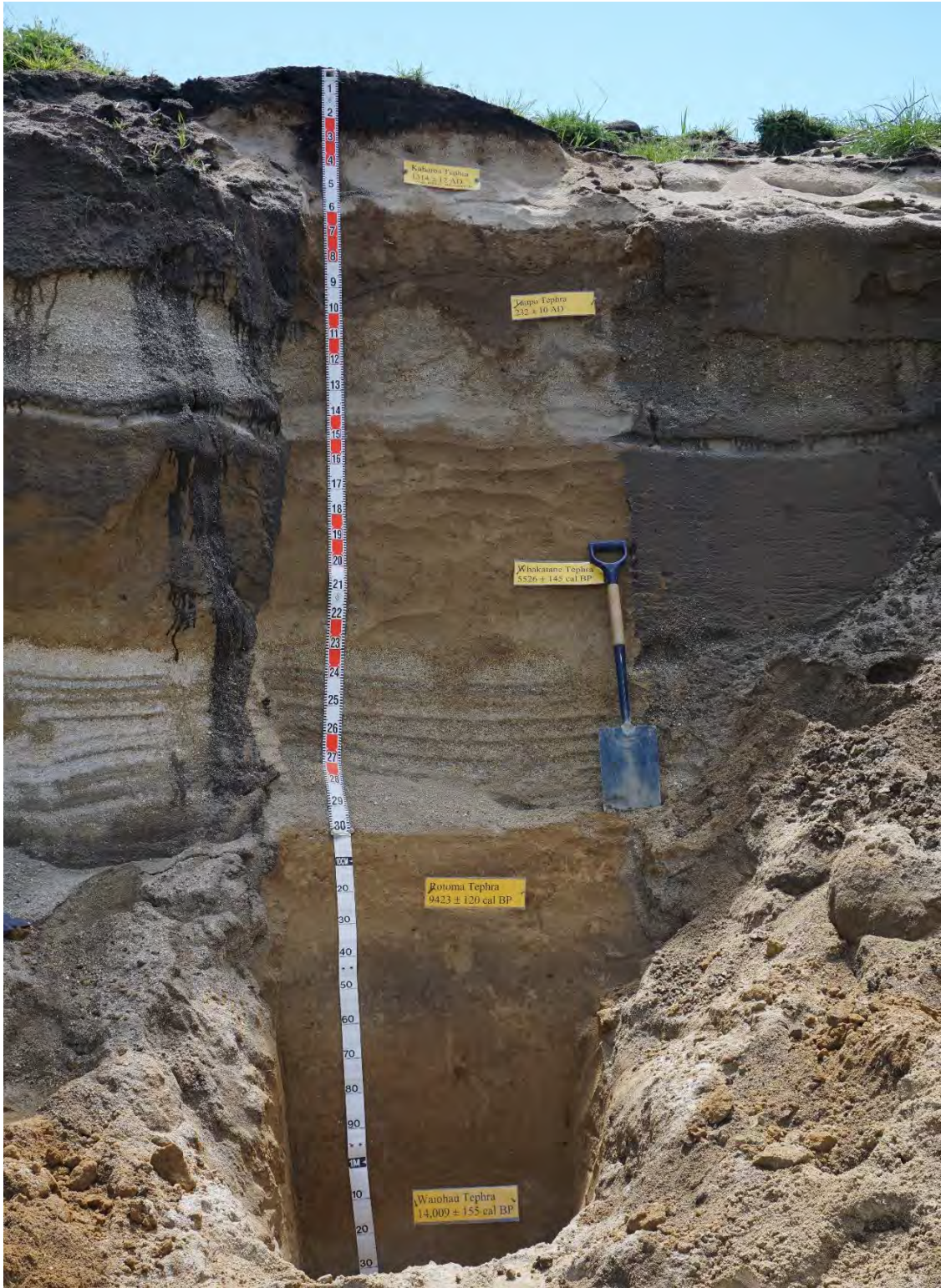

Photo showing location of Holocene tephra-buried soil sequence in quarry on terrace underlain by fluvial deposits. Section shown below is at far right. Lower terrace in background flanks Whirinaki River. Photos: D.J. Lowe.



View of tephra-buried soil sequence. Tephra from top: Kaharoa, Taupo, Whakatane, Rotoma, and (quarry floor) Waiohau. Ages given in next photo.

The modern soil (Galatea loamy sand) is classed in NZSC as an Immature Orthic Pumice Soil, tephric, with pumice clasts > 2 mm ("rhyolite stones"), sandy, rapid (Hewitt, 2010; Webb and Lilburne, 2011). In *Soil Taxonomy* it is a Typic Udivitrand, pumiceous, glassy, mesic (Soil Survey Staff, 2014).



Sequence of tephras and buried soils at Smeiths' quarry. All the tephras except Taupo are from the Okataina Volcanic Centre (see also Table 3, p.20). Rotoma tephra is relatively thin here compared with the same tephra elsewhere in the quarry section. Ages are from Lowe et al. (2013). Not far below Waiohau tephra (possibly ~0.5 m) are fluvial deposits (pebbles, cobbles). The modern soil (Galatea loamy sand) is classed in NZSC as an Immature Orthic Pumice Soil, tephric, with pumice clasts > 2 mm ("rhyolite stones") (needs >3% pumice clasts > 2 mm, otherwise "stoneless"), sandy, rapid (Hewitt, 2010; Webb and Lilburne, 2011). In *Soil Taxonomy* it is a Typic Udivitrand, pumiceous, glassy, mesic (Soil Survey Staff, 2014). Horizonation and a soil profile description are given below (from Laubscher, 2014). Photo: D.J. Lowe. *Note:* Whakatane tephra has been identified on Pitt Island, Chatham Islands (Holt et al. 2011).

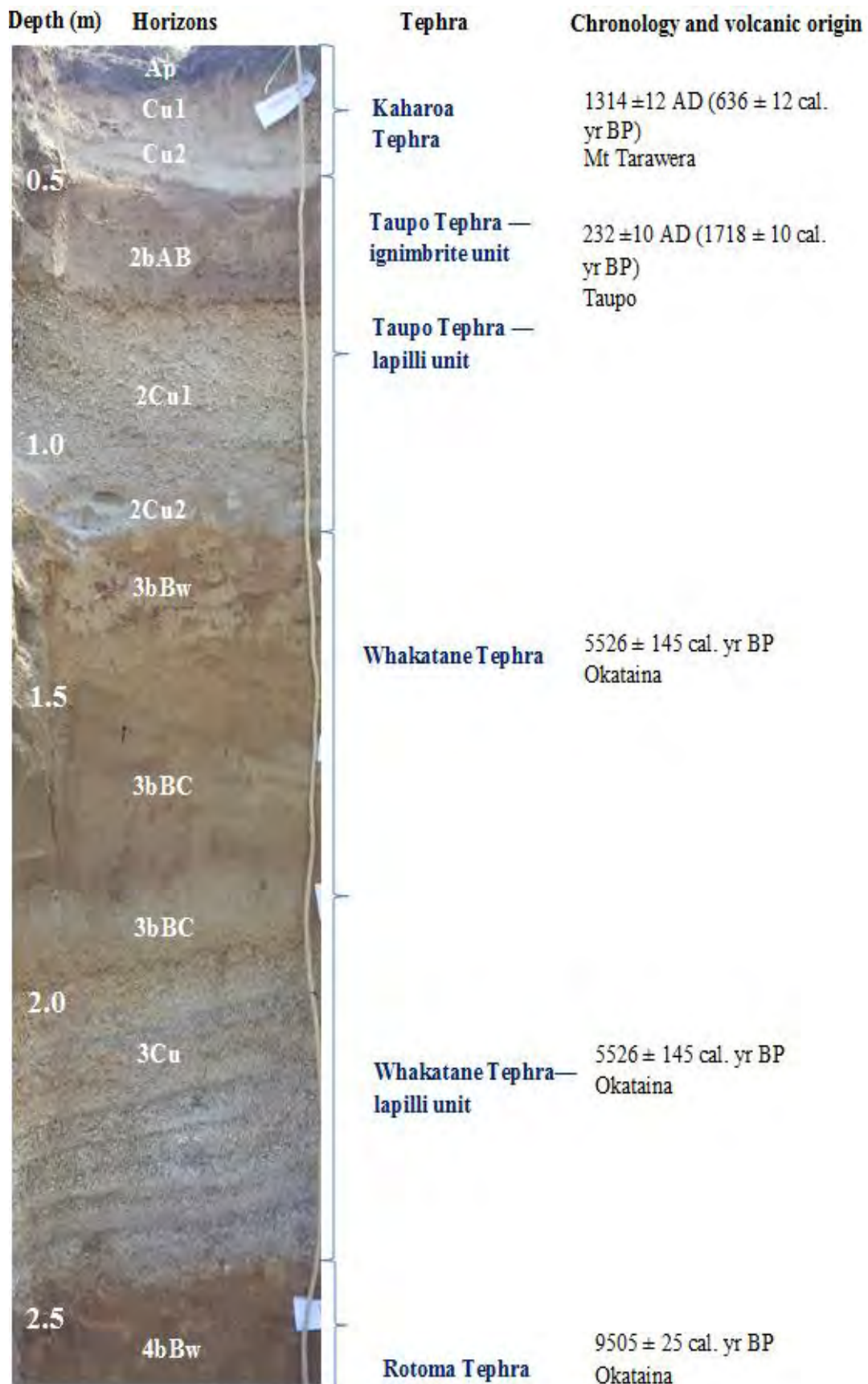

Profile and horizonation of Galatea soil, and parent tephra; description on next page (from Laubscher, 2014).

Horizon Depth (cm)	Description of Galatea loamy sand
Ap 0-10	Brownish black (10YR 2/2) loamy sand; non sticky; non plastic; very weak to weak soil strength; very friable; apedal earthy; abundant extremely fine roots: abrupt smooth boundary. [Kaharoa Tephra.]
Cu1 10-40	Light grey (2.5Y 8/1) slightly gravelly coarse and medium sand; non sticky; non plastic; apedal single grain; abundant extremely fine roots; abrupt smooth boundary. [Kaharoa Tephra.]
Cu2 40-50	Light yellowish brown (2.5Y 6/3) medium and fine sand; non sticky; non plastic; apedal single grain; few extremely fine roots; abrupt smooth boundary. [Kaharoa Tephra.]
2bAB 50-75	Dull yellow brown (10YR 5/4) loamy sand with few fine sub-rounded pumice lapilli and charcoal fragments; non sticky; non plastic; slightly firm soil strength; apedal massive breaking to apedal earthy; abrupt wavy boundary. [Taupo Tephra – ignimbrite unit.]
2Cu175-115	Light grey (10YR 8/1) very gravelly sand with medium sub-angular pumice lapilli; non sticky; non plastic; apedal single grain; abrupt smooth boundary [Taupo Tephra – lapilli unit.]
2Cu2 115-125	Light grey (10YR 7/1) evenly sorted loose fine sand (marker bed); abrupt smooth boundary [Taupo Tephra – Hatepe unit.]
3bBw 125-140	Bright brown (7.5YR 5/6) sandy loam; common medium greyish yellow (2.5Y 7/2) mottles; non sticky; non plastic; weak soil strength; apedal massive breaking to earthy; abundant fine polyhedral peds; abrupt smooth boundary. [Whakatane Tephra.]
3bBC1 140-160	Olive brown (2.5Y 4/6) sandy loam with few fine charcoal fragments; non sticky; non plastic; weak to slightly firm soil strength; apedal earthy; abrupt smooth boundary. [Whakatane Tephra.]
3bBC2 160-185	Dull yellow (2.5Y 6/3) fine sand; non sticky; non plastic; weak soil strength; friable; apedal single grain; abrupt smooth boundary. [Whakatane Tephra.]
3Cu 185-250	Pale yellow (2.5Y 7/3) very gravelly sand with medium sub-angular pumice lapilli; non sticky; non plastic; apedal single grain; abrupt smooth boundary [Whakatane Tephra – lapilli unit.]
4bBw 250	Dull reddish brown (5YR 4/4) sandy loam with few medium greyish yellow (2.5Y 7/2) mottles; slightly sticky; slightly plastic; slightly firm soil strength; apedal massive [Rotoma Tephra.]

Horizon notation and profile description based on Clayden and Hewitt (1994) and Milne et al. (1995).

Stop 4 Smeith Farm, Whirinaki Rd, Galatea area

Eric Smeith, dairy farmer, explains why and how he began flipping his soils

As a 60-year old farmer who has lived in Galatea all my life, I have come to know how the hot dry summers can have a big impact on agricultural production in this valley. As a lot of farmers have noticed, where underground water lines and underground power lines have been laid the pastures stay greener longer as other pasture dries out. This is because lower, brown moist silt/clay layers are brought to the surface and mixed in the soils. On my own farm where we travel to a lower river terrace I noticed the different volcanic layers and how the brown silt/clay layers (buried soils) stay moist all year. I became interested in bringing these layers to the top soils where pasture grows. In 2001, I experimented with an excavator in bring up the brown soil on Taupo tephra and lowering the Kaharoa pumice/ rhyolite material below that. Black Kaharoa topsoil was returned to the top. The area I worked on was about 2 acres. Depth of digging was between 600 and 800 mm. This area today still stays greener longer and pastures stay alive in big droughts and quickly recover when the rain arrives. This was an expensive exercise and was not viable in my opinion.

The next few years our thoughts were how we could make it work. On my farm in the terrace to the river I could see a much thicker brown silt/clay layer (soil) below the Taupo lapilli layer and I thought the ultimate would be to bring this buried soil up to the growing area. In 2007, a small area was turned over to a depth of 1800 mm. I was very impressed how this area grew strong clover-dominant pasture and how it kept growing throughout the dry summer months. In talks with my farm adviser, Bill Adam, after I showed him the area, he recommended I try and quantify the pasture growth increase. He supplied me with a couple of small cages and I did this for 12 months. This data helped a local group of farmers who had carried out soil flipping/mixing methods on their own farms, using an excavator. So we decided to approach Dairy NZ and get research funding to find out which method was the most viable. We are in our third and last year of the trail. Other methods of flipping have since shown good results but these have yet to be quantified. Some involve burying all the top soil and rhyolite material and bringing up the ancient soil on the Whakatane tephra and growing pasture and crops directly into this. The work and experiments continue.





Stop 4a 38° 27' 22" S, 176° 44' 49" E; elevation ~207 m. Recently flipped and mixed soil at right; paddock at left was flipped some years ago. Photographed 24 October, 2014 (photo: D.J. Lowe).



Stop 4b 38° 27' 26" S, 176° 45' 01" E; elevation ~210 m. Site of trials being run by DairyTeam. Photographed 24 October, 2014 (photo: D.J. Lowe).



Stop 4c 38° 27' 44" S, 176° 45' 16" E; elevation ~216 m. Exhumed soil on Whakatane tephra re-exposed after being buried for nearly 2000 years. Now growing fodder beet. Photographed 24 October, 2014 (photo: D.J. Lowe).



Galatea Soil Flipping Project: “Farming Paleosols”

November 2014

Notes for “Hot Volcanic Soils” field trip for NZ Society of Soil Science
Conference (2 December, 2014)

Bill Adam

DairyTeam, Whakatane

Copyright for the following notes (including text, graphics, logos and icons) is owned by or licensed to DairyNZ Incorporated. No person may in any form or by any means use, adapt, reproduce, store, distribute, print, display, perform, publish or create derivative works from any part of this publication or commercialise any information, products or services obtained from any part of this publication without the written consent of DairyNZ Incorporated.

Acknowledgements

This project was funded by New Zealand dairy farmers through DairyNZ Incorporated OFIF 1114. The author wishes to acknowledge the contributions of the following people and organisations.

- The Galatea farming community, in particular
- Eric and Betty Steiner, Eric and Margaret Smeith, Richard and Jenny Mills, Dave and Nicola Garner, Andrew Carter
- Ravensdown Fertiliser
Ants Roberts, Terry Roberts
- ARL Limited
- RD1 Galatea
- DairyNZ staff past and present
Phillipa Hedley, Cameron Bierre, Kim Mashlan, Fran Adamski, Errol Thom, Bruce Thorrold, Barbara Dow, Deanne Waugh
- University of Waikato
Megan Balks, Nadia Laubscher, David Lowe, Louis Schipper
- AgResearch Ltd
Tom Fraser
- Bay of Plenty Farm and Pastoral Research Ltd
Sarah Anderson, Martin Hawke

Introduction

The Galatea Soil Flipping Project completed its second 12 months of pasture measurement at the end of August 2014, and some of the data have been analysed. The purpose of the trial is to quantify the pasture production response and economic return of several “soil flipping” techniques as a means of increasing pasture production and survival on dry land sandy pumice soils in Galatea (Bay of Plenty), with possible application to other pumice soils across the Volcanic Plateau. These techniques modify the soil profile to bring better developed paleosols to the surface, and affect water holding capacity, soil heat transfer properties, root development of pasture plants, and soil fertility properties. The 2-m soil profile below shows the various pumice layers and associated soils (see photos and tephra identifications on previous pages): from top, Kaharoa tephra (0 to ~50 cm), Taupo tephra (~50 to 110 cm), and (below 110 cm), soil developed on Whakatane tephra. Graduations on the staff are 100 mm.



Trials

Treatments involved using a 12 or 20 tonne digger to achieve “complete mixing” of soils to a depth of 0.8m or 1.8m, or “sorting” the layered pumice soil horizons to a similar depth bringing paleosols (buried soils) to the surface, and then spreading topsoil back on top. After plots were “flipped” paddocks were then cultivated and re-sown in new pasture with “Prospect” ryegrass/“Ella” cocksfoot/“Winna” white clover. Soil tests were taken on individual plots and fertiliser applied to reinstate soil fertility to biological optima, to eliminate soil fertility as a variable. Sowing date was mid-April 2012. The cutting trial commenced 1st September 2012 and the first year concluded 30th August 2013.

The first year of the trial encountered the longest drought in a number of years and all controls and treatments were seriously affected in terms of DM production, and to varying degrees, survival of sown species. Controls grew 8.7 and 8.8 tonne DM/ha for 12 months on Smeith’s and Steiner’s farms, respectively. Responses to flipping were +3.0 tonne DM/ha for shallow mix, + 3.1 for shallow sort, + 3.4 for deep mix, and + 4.1 tonnes for deep sort treatments at Smeith’s and + 2.3 for shallow mix, + 2.2 for shallow sort, + 2.9 for deep mix, and + 4.1 tonnes for deep sort treatments at Steiner’s. The second year of the trial concluded on 29th August 2014, and was affected by a second extended drought, which proved too much for the Steiner site, which had to be resown during the year. Controls grew 9.8 tonne of DM/ha on Smeith’s for 12 months and 6.9 tonne DM/ha at Steiner’s for 8 months before needing to be resown. Responses to flipping were + 0.9 tonne DM/ha for shallow mix, + 1.6 for shallow sort, + 1.5 for deep mix, and + 2.5 tonnes for deep sort treatments at Smeith’s and + 0.6 for shallow mix, + 0.1 for shallow sort, + 1.4 for deep mix, and + 0.7 tonnes for deep sort treatments at Steiner’s. Some results achieved statistical significance at Smeith’s but effects were generally not significant at Steiner’s. Overall, these responses were much less and reflected significant drought damage.

In a moderate dry spell, one of the economic benefits of flipping still appear to be greatly enhanced ryegrass survival and the reduction of costs associated with regrassing after a dry summer. The cost of undersowing a drought damaged pasture in a commercial situation is likely to be in the order of \$400/ha. However, as the plots at Steiners demonstrated, flipping is not irrigation, and there are limits to which a pasture can survive dry weather, even on flipped soils.

Taking into account estimated costs of doing this work on a commercial scale, it is very likely that all of these procedures are economically viable at farm scale given a \$6.00 milk price and current costs for soil flipping procedures.

It is important that the trial continues into subsequent years, to identify whether

1. these effects are permanent, and
2. the effects still occur in more favourable growth conditions

Post-treatment fertility

It is important to test paddocks as soon as practically possible after flipping and aggressively reinstate soil fertility to biological optima.

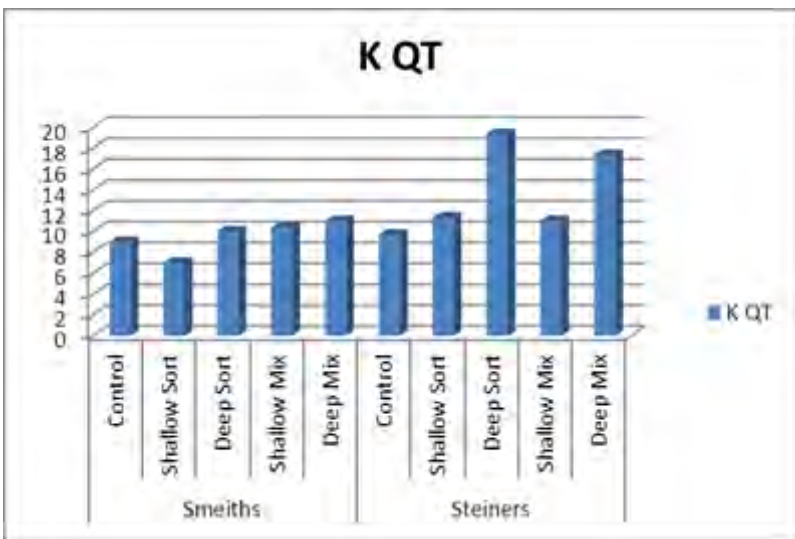
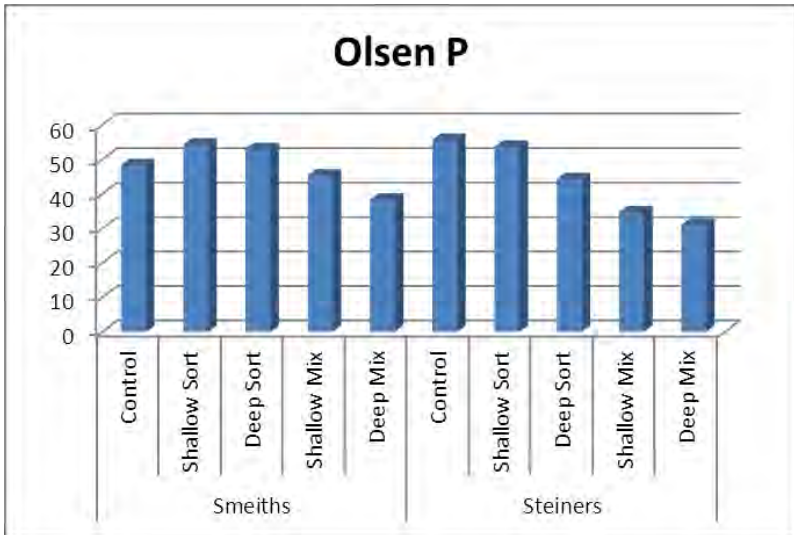
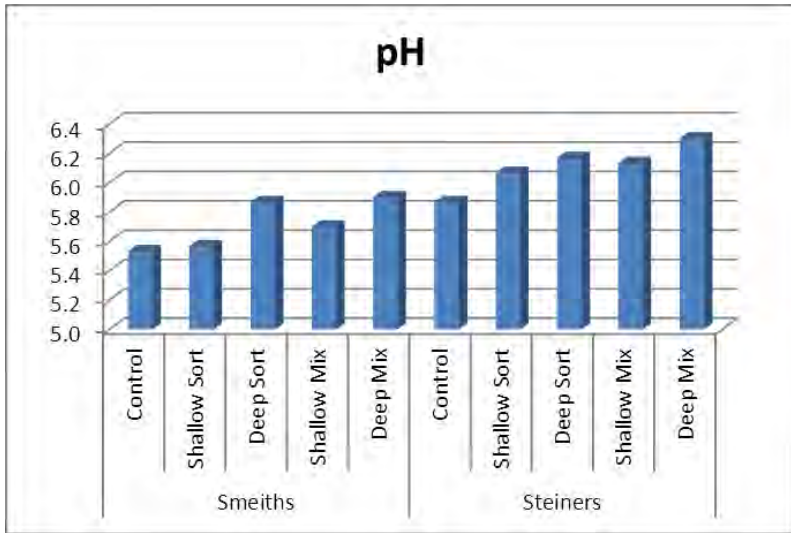



By late spring (November 2012) pasture responses were already evident – “control” is cage in right foreground.



By March after 5 months of very dry conditions, nothing was growing very much but at least the flipped treatments were surviving! Foreground in front of cage is effectively “control” green patch is “deep sorted”.

Yield data

Galatea Soil Flipping Project - Two Year Pasture Cut Results from 1/9/2012 - 29/4/2014						Yield Advantage	% Yield Advantage	
Average of two years by treatment		Spring	Summer	Autumn	Winter	Total	kgDM	%
Smeith	Shallow complete mix	4510	3006	2132	1635	11283	1958	21.0%
	Shallow sort	5266	3071	1449	1872	11658	2333	25.0%
	Deep complete mix	4521	3204	2244	1836	11805	2481	26.6%
	Deep sort	4976	3417	2322	1932	12646	3321	35.6%
	Control	4334	2153	1093	1745	9325		
Steiner	Shallow complete mix	4127	2940	1306	837	9209	1428	18.3%
	Shallow mix (retain topso)	4453	2846	1207	780	9286	1504	19.3%
	Deep Complete mix	4063	3336	1546	676	9620	1839	23.6%
	Deep sort	4387	3354	1623	795	10158	2376	30.5%
	Control	3631	2565	911	675	7782		

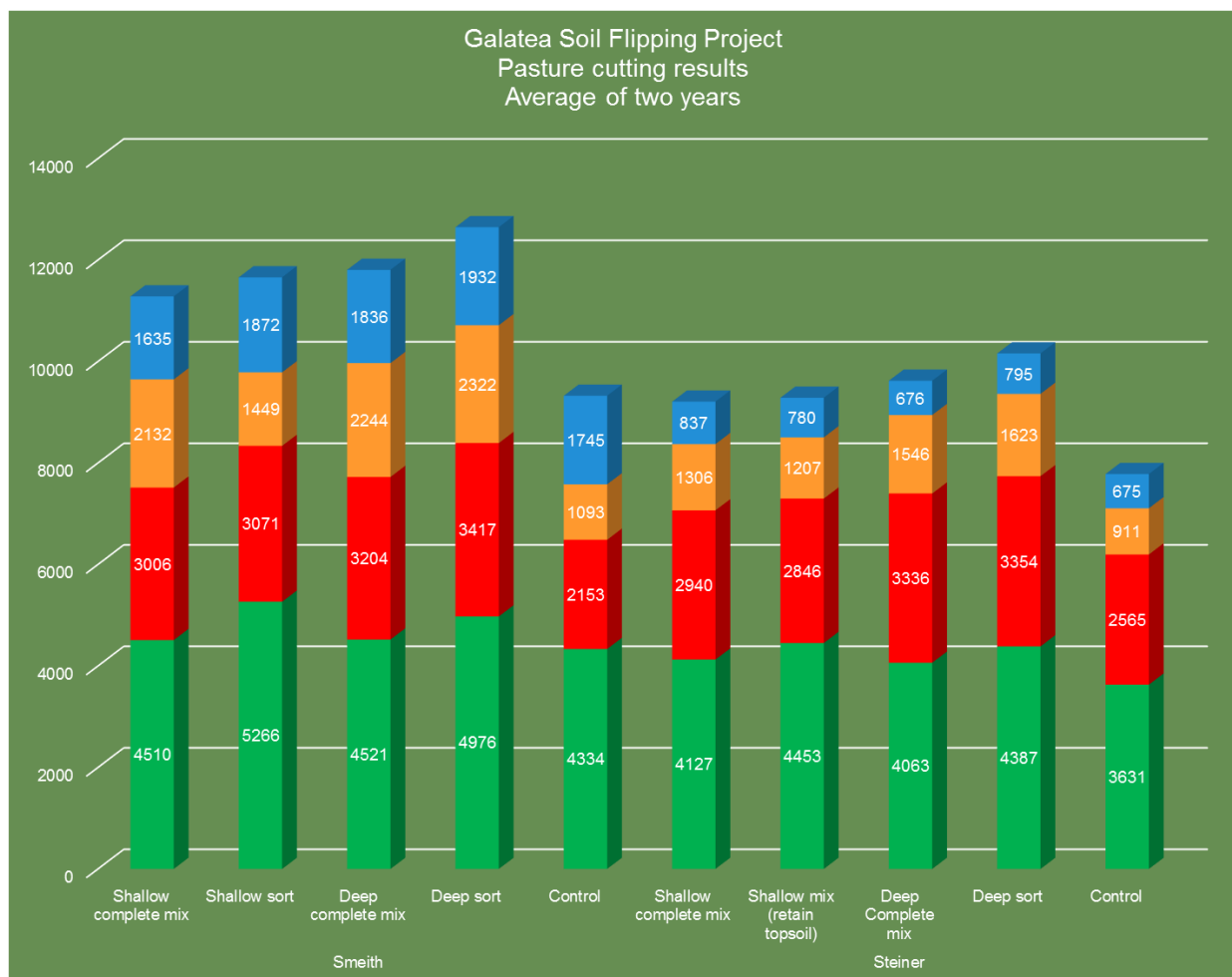

Observation of plots during the dry weather showed that all flipping treatments stayed green and grew for much longer into the dry weather and recovered more quickly when the dry weather broke. Loss of sown pasture species was severe on the control (un-flipped) plots but much less severe on all treatments, up to a point where in the second season, the weather became so dry it decimated all treatments alike.

Soil temperature (year 1)

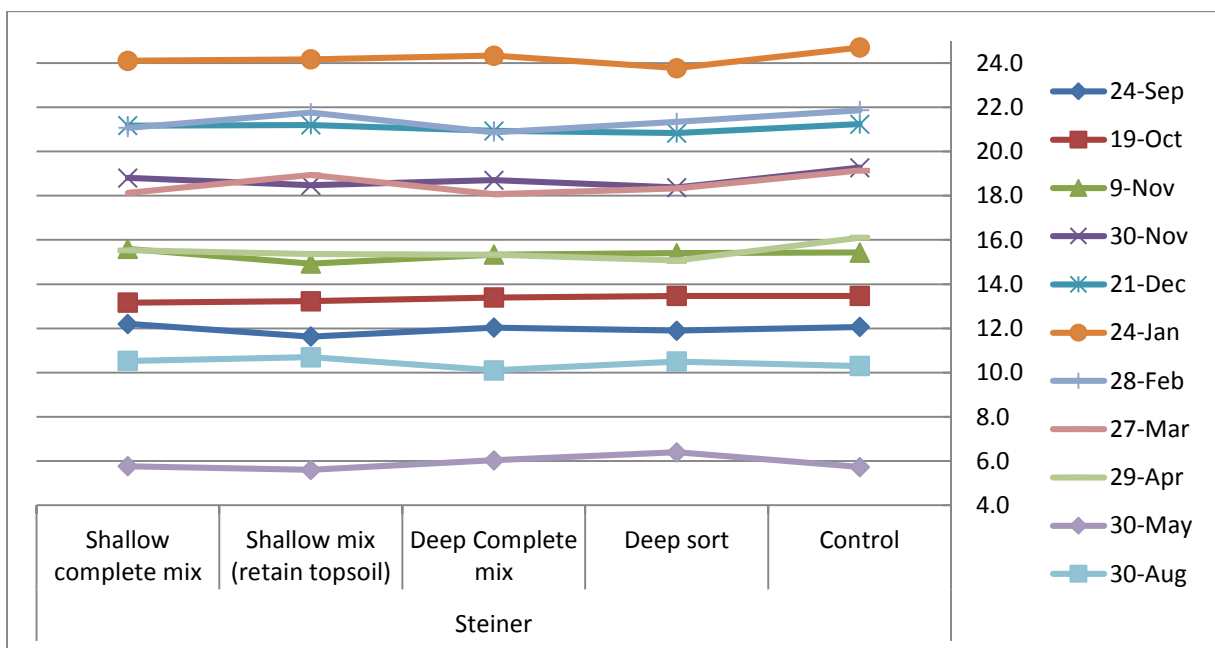
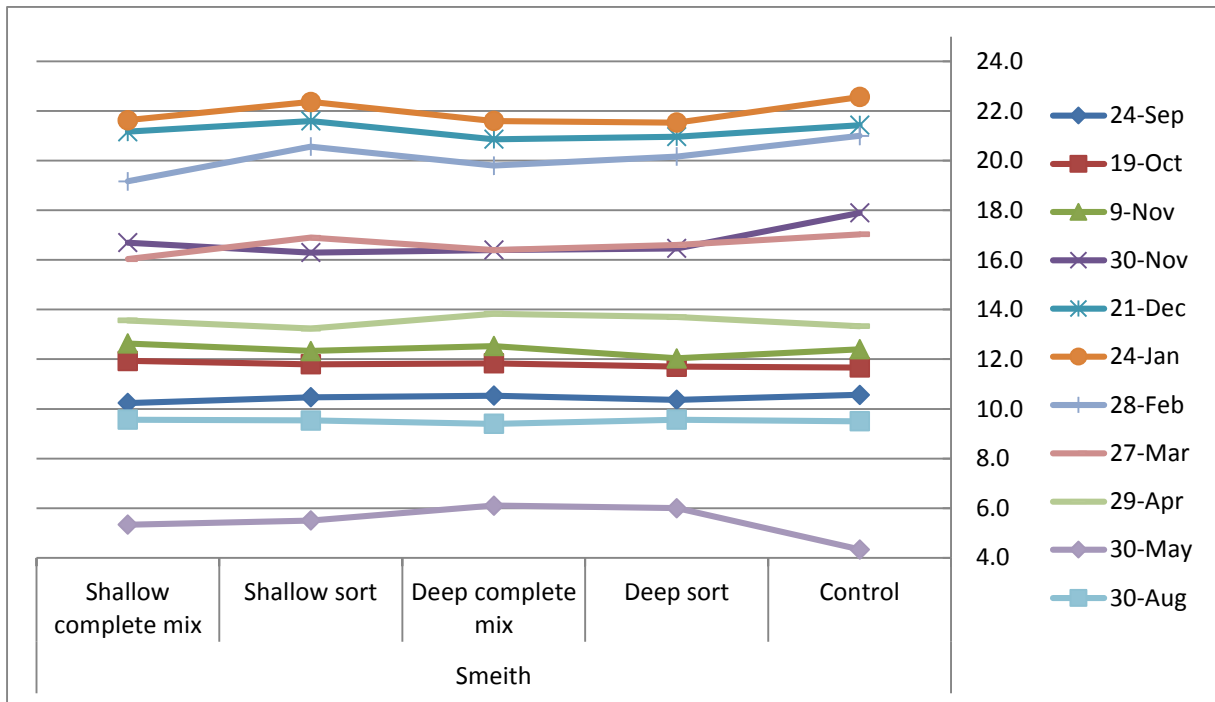

Soil temperature data confirms earlier farmer observations that flipped soils have a more even soil temperature profile than un-flipped soils. Although differences were small, there was a tendency (not fully consistent) over the season for the control plots to be colder than the treatments in cold weather and warmer than the treatments in warm weather. The shallow sorted plots were also warmer in warm weather – concurring with the theory that the black topsoil is heat attractant. This trend seems to support the idea that the 'B horizon' of the coarse Kaharoa pumice layer has an insulating effect of the topsoil from the subsoil, allowing the surface layer to heat and cool more quickly than if the topsoil were in contact with a finer, more moist subsoil.

Economic viability

For the farmer the procedure is very expensive and can only be paid for by a large and sustainable yield advantage. At this point the experiment has demonstrated large yield improvements in one season, but it has demonstrated lesser response in the second season. It has not demonstrated what the response will be in a more favourable growing season. Arguably because of the timing of the response, better conversion rates than 12:1 are achievable – i.e., responses occur at times when additional DM is particularly valuable – going into or recovering from a dry period.

Cost of procedures

Example: Smeith's Farm

Treatment Name	Hours/ha	Additional levelling and cultivation required due to flipping	Additional fertiliser required to reinstate normal soil test levels due to flipping	Total cost of flipping (does not include normal regrassing costs)
Treatment 1 Shallow complete mix	14@ \$150/hr = \$2100/ha	\$500/ha	2 tonne/ha superphosphate, 150 kg/ha KCl, 30 kg/ha MgO, 1 tonne/ha lime, + spreading \$1030/ha	\$3630
Treatment 2 Shallow sort	22@ \$150/hr = \$3300/ha		Assume half the fertility is lost as above, say \$515/ha to reinstate	\$4315
Treatment 3 Deep complete mix	20@ \$200/hr = \$4000/ha		2 tonne/ha superphosphate, 150 kg/ha KCl, 30 kg/ha MgO, 1 tonne/ha lime, + spreading \$1030/ha	\$5530
Treatment 4 Deep sort	24@ \$200/hr = \$4,800/ha		Assume half the fertility is lost as above, say \$515/ha	\$5815

Estimates of payback period made at with only year one cutting data now appear to be optimistic in the light of second year cutting data, which showed much less advantage to flipping than year one. The following table indicates likely payback periods, but this is entirely dependent on how the pastures recover from drought. Under good management at Smeith's this recovery appears to be occurring and initial indications in year 3 are that differences will re-appear.

Estimated Payback Period (Years)				Milk Price \$6.00	kgDM/kgMS 12
Site	Treatment	Extra DM p.a.	Cost	Extra income p.a.	Payback years
Smeith	Shallow complete mix	1958	3630	979	3.7
	Shallow sort	2333	4315	1167	3.7
	Deep complete mix	2481	5530	1240	4.5
	Deep sort	3321	5815	1661	3.5
Steiner	Shallow complete mix	1428	3630	714	5.1
	Shallow mix (retain topsoil)	1504	4315	752	5.7
	Deep Complete mix	1839	5530	919	6.0
	Deep sort	2376	5815	1188	4.9

Conclusions

The deep treatments show the strongest summer responses at both sites, most likely because of the larger volume of the Whakatane soil horizon, and its positive contribution to water holding capacity of the soil (see next section by Nadia Laubscher, p. 76).

Although not used as a treatment, exhuming the Whakatane paleosols would seem to have the best prospects as a technique, ignoring other soil horizons completely. Reinstatement of soil carbon levels and compaction of the exhumed soils appear to be risks, particularly where existing topsoil is not retained.

Soil modification techniques are quite likely to have wider applicability across the Volcanic Plateau, and supporting soil physics work is being undertaken by Waikato University. The project needs to continue for at least one more season to confirm that responses continue in subsequent seasons, and hopefully show that pastures do indeed recover better on flipped soils.

Farmer opinion is that these techniques work, and commercial farmers are already doing paddock scale flipping projects. This is being documented already, but where possible yield and economic data should be captured.

Response to deep sorting treatment appears to be best, however the lower cost techniques are probably cost competitive. It is still too early to recommend one technique above another. The cutting trial has defined a response to flipping – the underlying reasons for this response need to be better understood, and the Waikato University project has given some understanding of this, and will most likely allow us to make an educated assessment of likely responses in other districts on the basis of soil texture and physics.

Nadia Laubscher’s MSc study on Smeith’s Farm

Methods: excavated” sites

An undisturbed reference profile at the quarry (site 3), and four experimental sites, were sampled. Each site contained an excavated area comprising mixed soil materials and an adjacent “undisturbed” (control) area comprising undisturbed soil, within the same paddock. At sites 1 and 2, the topsoil was stripped and the pumice horizons and buried soil horizons were excavated to a depth of ~1.8 m and separated into piles. The pumice horizons were then buried first and the buried soil horizons were placed back next; lastly the original topsoil was placed back on top. At site 3, all the horizons and tephra deposits to a depth of 0.6 m (including topsoil) were excavated in small sections and tipped back into the hole to roughly mix the materials. At site 4, the topsoil was stripped and the horizons below the topsoil (to a depth of 0.6 m) were excavated in small sections and tipped back into the hole to mix the sub-soil materials. Where topsoil was not retained it was mixed in with the rest of the soil material. At each experimental site, three pits were excavated in the excavated area and three in the undisturbed area as shown below.

Description of sites sampled

Site	Years since excavating	Depth (m)	*Topsoil retained	Latitude & longitude	treatment
1	3	~1.8	Yes	38°27'25.84"S 176°44'39.41"E	“deep sort”
2	10	~1.8	Yes	38°27'37.80"S 176°45'7.72"E	“deep sort”
3	3	~0.6	No	38°24'49.71"S 176°47'51.76"E	“shallow mix”
4	3	~0.6	Yes	38°25'37.48"S 176°45'22.57"E	“shallow sort”
Reference profile (undisturbed)	n/a	n/a	n/a	38°27'47.73"S 176°43'59.46"E	n/a

* Retained topsoil

Results: readily available water

The overall objective of the study was to investigate why the layered Pumice Soils modified by excavation differ from undisturbed soils in adjacent (control) areas to better understand why grass growth increases. Four sites were identified that had previously been modified by excavating the soil. Each site contained an excavated area comprising excavated and mixed soil materials and an adjacent undisturbed (control) area. At each site, three pits were unearthed in the excavated area and three in the undisturbed area. Readily-available water content was calculated in the excavated soils to 60 cm depth and to 45 cm depth in the undisturbed soils (based on plant root observations in the field over summer). Readily-available water content was greater in the excavated soils compared to the undisturbed soils at sites 1, 2 and 3 ($P < 0.05$) and at site 4 ($P < 0.1$). The poster below summarises the main findings.

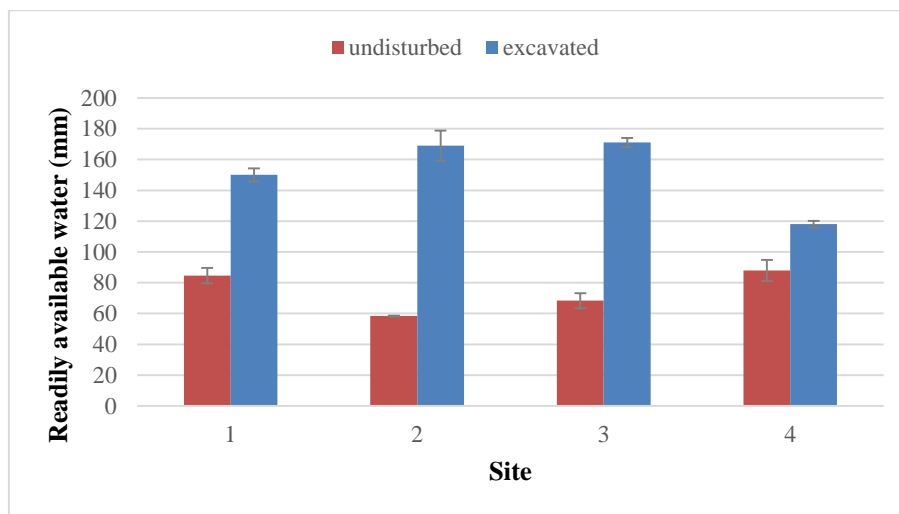

Mean readily available water (RAW) at sites 1-4, RAW was calculated in the excavated areas to 600 mm depth and in the undisturbed areas to 450 mm depth

Two tailed paired t-test (paired two samples for means) comparisons between paired excavated and adjacent undisturbed areas for sites 1-4.

	RAW
t-test	P(T<=t) two-tail
All excavated vs all undisturbed at all sites	<0.01
excavated vs undisturbed (site 1)	0.03
excavated vs undisturbed (site 2)	0.01
excavated vs undisturbed (site 3)	0.01
excavated vs undisturbed (site 4)	0.05

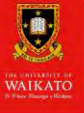

Improvement in soil water availability by excavating & mixing layered Pumice Soils (Vitrands) in the Central North Island, New Zealand



Nadia Laubscher, Megan R. Balks, David J. Lowe
School of Science, University of Waikato, Private Bag. 3105, Hamilton, New Zealand

Introduction

- Pumice soils in the central North Island of New Zealand (Fig. 1) are formed on layered rhyolitic tephra deposits. Near surface horizons comprise weakly weathered pumice (Fig. 2).
- Disturbed soils have been observed to have better pasture growth than undisturbed soils (Fig. 3).

Overall objective

- Investigate whether excavating and mixing buried soil horizons (Fig 4) up into the coarse pumice surface soil will give increased water holding capacity and thus better pasture production.



Fig 1. Location of the study area in New Zealand.



Fig 2. Soils are formed on a series of tephra layers.



Fig 3. Pasture growth on the undisturbed soil (control area) compared to pasture growth on mixed soil.



Fig 4. Excavating and mixing soil using a mechanised digger.

Methods

- Four sites each with a mixed soil area and an adjacent undisturbed (control) area were investigated. At each site three soil pits were sampled and described in the undisturbed area and three in the mixed area.
- Water retention was determined using a hanging column and a pressure plate extractor.
- Readily available water content (RAW) was calculated as the amount of water held between field capacity (10 kPa) and 100 kPa.

Results

- At mixed sites the surface pumice horizon had effectively been removed and the mixed soil comprised lumps of material from the various horizons (Fig. 5).
- During summer plant roots were abundant at depths up to 450 mm in the undisturbed soils and to 600 mm in the mixed soils.
- When RAW was calculated using a potential rooting depth of 450 mm in the undisturbed soils and 600 mm in the mixed soils, RAW was greater in the soil materials in the mixed areas than the soil in the undisturbed areas at sites 1-3 ($P < 0.05$) and at site 4 ($P \leq 0.1$) (Fig. 6).
- Mixed soils had water readily available for longer (mean of 39 days) than the undisturbed soils (mean of 19 days) between rainfall or irrigation events (assuming the soil was initially wet to field capacity and evapotranspiration was 4 mm/day).

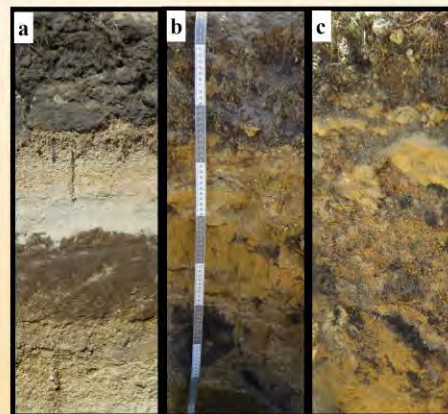

Fig 5. Examples of the undisturbed soil (a) and mixed soil (b & c).

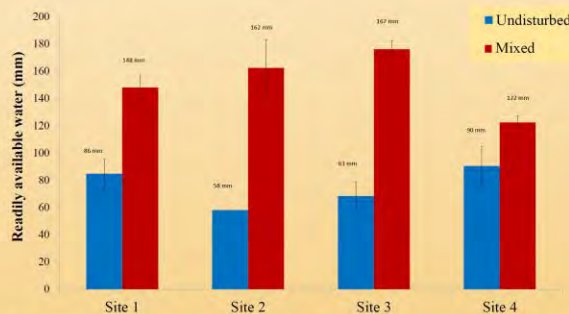

Fig 6. Mean readily available water at sites 1-4, (calculated using potential rooting depth of 600 mm in the mixed soils areas and 450 mm in the undisturbed areas).

Conclusion

Mixing the finer-textured buried soil material to the land surface in place of coarse pumice gave deeper plant root penetration and improved readily available soil water holding capacity.

Acknowledgements

Financial support was received from Dairy NZ, The Broad Memorial Fund, Frank Sydenham Trust, and the NZ National Agricultural Field Days Sir Don Llewellyn Scholarship.

Prize-winning poster presented by Nadia at World Congress of Soils in Jeju, 2014.

Acknowledgements

We are gratified that many colleagues and associated organisations willingly agreed to join us during the trip to provide insight and commentary and to help make our day informative and interesting. We especially thank Ravensdown for their generous trip sponsorship, and Ants Roberts (Ravensdown) for coming with us on the trip to share his experience and wisdom. Landcorp Farming also contributed to the trip: Allan Bullick set up the visit to Endeavour Farm and kindly provided morning tea and toilets, Wayne Tangney excavated the Taupo soil, and Jan Weston and others helped with logistics including teas. Kim Mashlan (DairyNZ) allowed us to cite data from DairyTeam research, led by Bill Adam, for Eric Smeith's farm. We also thank Nicola Hancock and Kevin Sears (Taupo District Council), and Jon Palmer (Waikato Regional Council), for their valued input. We acknowledge former students Glen Treweek, Erin Telfer, Riki Lewis, Djuro Paripovich, and Paul Mudge, who undertook research in the Taupo area. Eric Smeith is particularly thanked for preparing the quarry section and the 'mixed' soil pit on his farm, and for logistical support. Colin Wilson (Victoria Univ. of Wellington) provided very helpful, expert guidance on Taupo eruptives at Endeavour Farm. Patrick McCarthy and Deborah Taylor facilitated use of the Galatea Hall. Janine Ryburn (Waikato University), Natalie Watkins, the conference committee, and Lea Boodee (OnCue Conference and Events), are all thanked for organisational support. David Lowe and Megan Balks appreciated support from the School of Science, University of Waikato, and Nadia Laubscher from DairyNZ, to help enable them to prepare and run the trip.

References

- Abidin, Z., Matsue, N., Henmi, T., 2007. Differential formation of allophane and imogolite: experimental and molecular orbital study. *Journal of Computer-aided Materials Design* 14, 5-18.
- Almond, P.C., Tonkin, P.J. 1999. Pedogenesis by upbuilding in an extreme leaching and weathering environment, and slow loess accretion, south Westland, New Zealand. *Geoderma* 92, 1-36.
- Barrell, D.J.A., Almond, P.C., Vandergoes, M.J., Lowe, D.J., Newnham, R.M., NZ-INTIMATE members 2013. A composite pollen-based stratotype for inter-regional evaluation of climatic events in New Zealand over the past 30,000 years (NZ-INTIMATE project). *Quaternary Science Reviews* 74, 4-20.
- Birrell, K.S., Pullar, W.A., Heine, J.C. 1971. Pedological, chemical, and physical properties of organic horizons of paleosols underlying the Tarawera Formation. *New Zealand Journal of Science* 14, 187-218.
- Briggs, R.M., Houghton, B.F., McWilliams, M., Wilson, C.J.N. 2005. $^{40}\text{Ar}/^{39}\text{Ar}$ age of silicic volcanic rocks in the Tauranga-Kaimai area, New Zealand: dating the transition between volcanism in the Coromandel Arc and the Taupo Volcanic Zone. *New Zealand Journal of Geology and Geophysics* 48, 459-469.
- Churchman, G.J., Lowe, D.J. 2012. Alteration, formation, and occurrence of minerals in soils. In: Huang, P.M., Li, Y., Sumner, M.E. (Eds), *Handbook of Soil Sciences*, 2nd edition. Vol. 1: Properties and Processes. CRC Press (Taylor & Francis), Boca Raton, FL, pp. 20.1-20.72.
- Clarkson, B.R., Patel, R.N., Clarkson, B.D. 1988. Composition and structure of forest overwhelmed at Pureora, central North Island, New Zealand, during the Taupo eruption (c. A.D. 130). *Journal of the Royal Society of New Zealand* 18, 417-436.
- Clarkson, B.R., Clarkson, B.D., Patel, R.N. 1992. The pre-Taupo eruption (c. AD 130) forest of the Bennydale-Pureora district, central North Island, New Zealand. *Journal of the Royal Society of New Zealand* 22, 61-76.
- Clarkson, B.R., McGlone, M.S., Lowe, D.J., Clarkson, B.D. 1995. Macrofossil and pollen representing forests of the pre-Taupo volcanic eruption (c. 1850 yr BP) era at Pureora and Bennydale, central North Island, New Zealand. *Journal of the Royal Society of New Zealand* 25, 263-281.
- Clayden, B., Hewitt, A.E. 1994. *Horizon notation for New Zealand soils*. Manaaki Whenua Press, Lincoln, 30 pp.

- Colenso, W. 1894. Notes and reminiscences of early crossings of the romantically situated Lake Waikaremoana, County of Hawke's Bay, of its neighbouring country, and of its peculiar botany, performed in the years 1841 and 1843. *Transactions of the New Zealand Institute* 27, 359-382.
- Cornforth, I. 1998. *Practical soil management*. Lincoln University Press, Canterbury, and Whitireia Publishing, Wellington, 248 pp.
- Danišić, M., Shane, P.A.R., Schmitt, A.K., Hogg, A.G., Santos, G.M., Storm, S., Evans, N.J., Fifield, L.K., Lindsay, J.M. 2012. Re-anchoring the late Pleistocene tephrochronology of New Zealand based on concordant radiocarbon ages and combined $^{238}\text{U}/^{230}\text{Th}$ disequilibrium and (U-Th)/He zircon ages. *Earth and Planetary Science Letters* 349-350, 240-250.
- *Froggatt, P.C., Lowe, D.J. 1990. A review of late Quaternary silicic and some other tephra formations from New Zealand: their stratigraphy, nomenclature, distribution, volume, and age. *New Zealand Journal of Geology and Geophysics* 33, 89-109.
- Froggatt, P.C., Wilson, C.J.N., Walker, G.P.L. 1981. Orientation of logs in the Taupo Ignimbrite as an indicator of flow direction and vent position. *Geology* 9, 109-111.
- Grange, L.I. 1931. Volcanic ash showers. *New Zealand Journal of Science and Technology* 12, 228-240.
- Grange, L.I. 1937. The geology of the Rotorua-Taupo Subdivision. *New Zealand Geological Survey Bulletin* 37, 138 pp. + 14 map sheets.
- Grange, L. I., Taylor, N. H., 1932. The distribution and field characteristics of bush-sick soils. Part 2A. In: *Bush Sickness*. N.Z. Department of Scientific and Industrial Research Bulletin 32, pp. 21-35.
- Gravley, D.M., Wislon, C.J.N., Leonard, G.S., Cole, J.W. 2007. Double trouble: paired ignimbrite eruptions and collateral subsidence in the Taupo Volcanic Zone, New Zealand. *Geological Society of America Bulletin* 119, 18-30.
- Grimmett, R.E.R., Shorland, F.B. 1934. Some characteristics of "limonite" used in the cure and prevention of bush sickness. *Transactions of the Royal Society of New Zealand* 64, 191-213.
- Harsh, J., 2012. Poorly crystalline aluminosilicate clay minerals. In: Huang, P.M., Li, Y., Sumner, M.E. (Eds), *Handbook of Soil Science*, 2nd edn, Vol. 1: Properties and processes. CRC Press, Boca Raton, pp. 23.21-23.13.
- Hendy, C.H. 2008. Bush sickness and the discovery of trace element deficiencies. In: Lowe, D.J. *Soils – the most complex ecosystem in the world*. "Science on the farm" website, School of Science, University of Waikato, Hamilton. URL: <http://sci.waikato.ac.nz/farm/content/soils.html>.
- Hewitt, A.E. 2010. *New Zealand Soil Classification*, 3rd edition. Landcare Research Science Series No. 1. Manaaki Whenua Press, Landcare Research, Lincoln, 136 pp.
- Hiradate, S., Wada, S-I. 2005. Weathering process of volcanic glass to allophane determined by ^{27}Al and ^{29}Si solid-state NMR. *Clays and Clay Minerals* 53, 401-408.
- Hiradate, S., Nakadai, T., Shindo, H., Yoneyama, T. 2004. Carbon source of humic substances in some Japanese volcanic ash soils determined by carbon stable isotopic ratio, $\delta^{13}\text{C}$. *Geoderma* 119, 133-141.
- Hogg, A.G., Higham, T.F.G., Lowe, D.J., Palmer, J., Reimer, P., Newnham, R.M. 2003. A wiggle-match date for Polynesian settlement of New Zealand. *Antiquity* 77, 116-125.
- Hogg, A.G., Lowe, D.J., Palmer, J.G., Boswijk, G., Bronk Ramsey, C.J. 2012. Revised calendar date for the Taupo eruption derived by ^{14}C wiggle-matching using a New Zealand kauri ^{14}C calibration data set. *The Holocene* 22, 439-449.
- Holt, K., Wallace, R.C., Neall, V.E., Kohn, B.P., Lowe, D.J. 2010. Quaternary tephra marker beds and their potential for palaeoenvironmental reconstruction on Chatham Islands east of New Zealand, southwest Pacific Ocean. *Journal of Quaternary Science* 25, 1169-1178.
- Holt, K.A., Lowe, D.J., Hogg, A.G., Wallace, R.C. 2011. Distal occurrence of mid-Holocene Whakatane Tephra on the Chatham Islands, New Zealand, and potential for cryptotephra studies. *Quaternary International* 246, 344-351.
- Hosono, M., Oba, Y., Sase, T., Utsugawa, T., Aoki, K. 1991. Holocene volcanic ash soils at Waimangu Road tephra section, North Island, New Zealand – soil formation-vegetation relationship. *The Quaternary Research (Japan)* 30, 91-101.

- Houghton, B.F., Wilson, C.J.N. 1986. Explosive rhyolitic volcanism: the case studies of Mayor Island and Taupo volcanoes. *New Zealand Geological Survey Record* 12, 33-100.
- Houghton, B.F., Wilson, C.J.N., McWilliams, M.O., Lanphere, M.A., Weaver, S.D., Briggs, R.M., Pringle, M.S. 1995. Chronology and dynamics of a large silicic magmatic system: central Taupo Volcanic Zone, New Zealand. *Geology* 23, 13-16.
- Houghton, B.F., Carey, R.J., Cashman, K.V., Wilson, C.J.N., Hobden, B.J., Hammer, J.E. 2010. Diverse patterns of ascent, degassing, and eruption of rhyolite magma during the 1.8 ka Taupo eruption, New Zealand: evidence from clast vesicularity. *Journal of Volcanology and Geothermal Research* 195, 31-47.
- Huang, Y-T., Lowe, D.J., Churchman, G.J., Schipper, L., Rawlence, N.J., Cooper, A. 2014. Carbon storage and DNA adsorption in allophanic soils and paleosols. In: Hartemink, A.E., McSweeney, K. (Eds), "Soil Carbon". *Progress in Soil Science Series*, Springer, New York, pp. 163-172.
- Hudspith, V.A., Scott, A.C., Wilson, C.J.N., Collinson, M.E. 2009. Charring of woods by volcanic processes: an example from the Taupo ignimbrite, New Zealand. *Palaeogeography Palaeoclimatology Palaeoecology*, 291, 40-51.
- Johnson, D.L., Watson-Stegner, D. 1987. Evolution model of pedogenesis. *Soil Science* 143, 349-366.
- Johnson, D.L., Keller, E.A., Rockwell, T.K. 1990. Dynamic pedogenesis: new views on some key soil concepts, and a model for interpreting Quaternary soils. *Quaternary Research* 33, 306-319.
- Johnson-Maynard, J.L., McDaniel, P.A., Ferguson, D.E., Falen, A.L. 1997. Chemical and mineralogical conversion of Andisols following invasion by bracken fern. *Soil Science Society of America Journal* 61, 549-555.
- Laubscher, N. 2014. Improvement in soil water availability in pastures by excavating and mixing buried soil horizons from multilayered Pumice Soils (Vitrandis) at Galatea, central North Island, New Zealand. MSc thesis, University of Waikato.
- Leonard, G.S., Begg, J.G., Wilson, C.J.J. (Compilers) 2010. *Geology of the Rotorua area: scale 1: 250,000*. Institute of Geological and Nuclear Sciences 1: 250,000 geological map 5. 1 sheet and 99 pp. Institute of Geological and Nuclear Sciences, Lower Hutt.
- Lowe, D.J. 1986. Controls on the rates of weathering and clay mineral genesis in airfall tephras: a review and New Zealand case study. In: Colman, S.M., Dethier, D.P. (Eds), *Rates of Chemical Weathering of Rocks and Minerals*. Academic Press, Orlando, pp. 265-330.
- Lowe, D.J. 1990. Tephra studies in New Zealand: an historical review. *Journal of the Royal Society of New Zealand* 20, 119-150.
- Lowe, D.J. (Ed) 2008. *Guidebook for Pre-conference North Island Field Trip A1 'Ashes to Issues'*. Australian and New Zealand 4th Joint Soils Conference, Massey University, Palmerston North. New Zealand Society of Soil Science, 194 pp.
- Lowe, D.J. 2011. Tephrochronology and its application: a review. *Quaternary Geochronology* 6, 107-153.
- Lowe, D.J., Percival, H.J. 1993. Clay mineralogy of tephras and associated paleosols and soils, and hydrothermal deposits, North Island [New Zealand]. *Review and Guide F1 Field Tour – New Zealand*. Tenth International Clay Conference, Adelaide, Australia, 110 pp.
- Lowe, D.J., de Lange, W.P. 2000. Volcano-meteorological tsunamis, the c. AD 200 Taupo eruption (New Zealand) and the possibility of a global tsunami. *The Holocene* 10, 401-407.
- Lowe, D.J., Palmer, D.J. 2005. Andisols of New Zealand and Australia. *Journal of Integrated Field Science* 2, 39-65.
- Lowe, D.J., McDaniel, P.A. 2010. Impacts of deforestation and burning, and the role of bracken fern, on properties of surficial or buried soil A-horizons In: Lowe, D.J., Neall, V.E., Hedley, M., Clothier, B., Mackay, A. *Guidebook for Pre-conference North Island, New Zealand 'Volcanoes to Oceans' field tour (27-30 July)*. 19th World Soils Congress, International Union of Soil Sciences, Brisbane. *Soil and Earth Sciences Occasional Publication No. 3*, Massey University, Palmerston North, pp. 4.39-4.42.

- Lowe, D.J., Tonkin, P.J. 2010. Unravelling upbuilding pedogenesis in tephra and loess sequences in New Zealand using tephrochronology. Proceedings published at <http://www.iuss.org>, IUSS 19th World Soil Congress, Brisbane (1-6 Aug., 2010), Symposium 1.3.2 Geochronological techniques and soil formation, pp. 34-37.
- Lowe, D.J., Pittari, A. 2014. An ashy septingentenarian: the Kaharoa tephra turns 700 (with notes on its volcanological, archaeological, and historical importance). *Geoscience Society of New Zealand Newsletter* 13, 35-46.
- Lowe, D.J., McFadgen, B.G., Higham, T.F.G., Hogg, A.G., Froggatt, P.C., Nairn, I.A. 1998. Radiocarbon age of the Kaharoa Tephra, a key marker for late-Holocene stratigraphy and archaeology in New Zealand. *The Holocene* 8, 487-495.
- Lowe, D.J., Newnham, R.M., McFadgen, B.G., Higham, T.F.G. 2000. Tephtras and New Zealand archaeology. *Journal of Archaeological Science* 27, 859-870.
- Lowe, D.J., Shane, P.A.R., Alloway, B.V., Newnham, R.M. 2008. Fingerprints and age models for widespread New Zealand tephra marker beds erupted since 30,000 years ago: a framework for NZ-INTIMATE. *Quaternary Science Reviews* 27, 95-126.
- Lowe, D.J., Neall, V.E., Hedley, M., Clothier, B., Mackay, A. 2010. Guidebook for pre-conference North Island, New Zealand 'Volcanoes to Ocean' field tour (27-30 July, 2010). 19th World Soils Congress, International Union of Soil Sciences, Brisbane. Soil and Earth Sciences Occasional Publication No. 3, Massey University, Palmerston North, 239 pp.
- Lowe, D.J., Lanigan, K.M., Palmer, D.J. 2012. Where geology meets pedology: Late Quaternary tephtras, loess, and paleosols in the Mamaku Plateau and Lake Rerewhakaaitu areas. In: Pittari, A. (Compiler), *Field Trip Guides, Geosciences 2012 Conference*, Hamilton, New Zealand. Geoscience Society of New Zealand Miscellaneous Publication 134B, pp. 2.1-2.45.
- Lowe, D.J., Blaauw, M., Hogg, A.G., Newnham, R.M. 2013. Ages of 24 widespread tephtras erupted since 30,000 years ago in New Zealand, with re-evaluation of the timing and palaeoclimatic implications of the late-glacial cool episode recorded at Kaipo bog. *Quaternary Science Reviews* 74, 170-194.
- Manville, V. 2001a. Environmental impacts of large-scale explosive rhyolitic eruptions in the central North Island. In: Smith, R.T. (Ed), *Fieldtrip Guides, Geological Society of New Zealand Annual Conference*, University of Waikato, Hamilton. Geological Society of New Zealand Miscellaneous Publication 110B, 19 pp.
- Manville, V. 2001b. Sedimentology and history of Lake Reporoa: an ephemeral supra-ignimbrite lake, Taupo Volcanic Zone, New Zealand. *Special Publication of the International Association of Sedimentology* 30, 109-140.
- Manville, V. 2002. Sedimentary and geomorphic responses to ignimbrite emplacement: readjustment of the Waikato River after the A.D. 181 Taupo eruption, New Zealand. *The Journal of Geology* 110, 519-541.
- Manville, V., Wilson, C.J.N. 2004. The 26.5 ka Oruanui eruption, New Zealand: a review of the roles of volcanism and climate in the post-eruptive sedimentary response. *New Zealand Journal of Geology and Geophysics* 47, 525-547.
- Manville, V., White, J.D.L., Houghton, B.F., Wilson, C.J.N. 1999. Paleohydrology and sedimentology of a post-1.8 ka breakout flood from intracaldera Lake Taupo, North Island, New Zealand. *Geological Society of America Bulletin* 111, 1435-1447.
- Manville, V., Hodgson, K.A., Nairn, I.A. 2007. A review of break-out floods from volcanogenic lakes in New Zealand. *New Zealand Journal of Geology and Geophysics* 50, 131-150.
- Manville, V., Swegschneider, B., Newton, E., White, J. D. L., Houghton, B.F., Wilson, C.J.N. 2009. Environmental impact of the 1.8 ka Taupo eruption, New Zealand: landscape responses to a large-scale explosive rhyolite eruption. *Sedimentary Geology* 220, 318-336.

- McClelland, E., Wilson, C.J.N., Bardot, L. 2004. Paleotemperature determinations for the 1.8-ka Taupo ignimbrite, New Zealand, and implications for the emplacement history of a high-velocity pyroclastic flow. *Bulletin of Volcanology* 66, 492-513.
- McDaniel, P.A., Lowe, D.J., Arnalds, O., Ping, C.-L. 2012. Andisols. In: Huang, P.M., Li, Y., Sumner, M.E. (Eds), *Handbook of Soil Sciences*, 2nd edition. Vol. 1: Properties and Processes. CRC Press (Taylor & Francis), Boca Raton, FL, pp. 33.29-33.48.
- McGlone, M.S., Wilmshurst, J.M. 1999. Dating initial Maori environmental impact in New Zealand. *Quaternary International* 59, 5-16.
- McGlone, M., Wilmshurst, J.M., Leach, H.M. 2005. An ecological and historical review of bracken (*Pteridium esculentum*) in New Zealand, and its cultural significance. *New Zealand Journal of Ecology* 29, 165-184.
- McWethy, D.B., Whitlock, C., Wilmshurst, J.M., McGlone, M.S., Li, X. 2009. Rapid deforestation of South Island, New Zealand, by early Polynesian fires. *The Holocene* 19, 883-897.
- McWethy D.B., Wilmshurst, J.M., Whitlock, C., Wood, J.R., McGlone, M.S. 2014. A high-resolution chronology of rapid forest transitions following Polynesian arrival in New Zealand. *PLoS ONE* 9(11): e111328.
- Milne, D., Clayden, B., Singleton, P., Wilson, A. 1995. *Soil description handbook*. Revised edition. Manaaki Whenua Press, Lincoln, 157 pp.
- Molloy, L., Christie, Q. 1998. *Soils in the New Zealand Landscape*, 2nd edition. New Zealand Society of Soil Science, 253pp.
- Nathan, S. 2007. Lakes. Te Ara – the Encyclopedia of New Zealand. New Zealand Ministry for Heritage and Culture. Updated 5-Nov-2007. <http://www.TeAra.govt.nz/TheBush/Landscapes/Lakes/en>
- Neall, V.E. 2006. Volcanic soils, pp. 1-24. In: W. Verheye (Ed) *Land use and land cover. Encyclopaedia of life support systems (EOLSS)*. EOLSS Publishers with UNESCO, Oxford, U.K. Available online at: <http://www.eolss.net>
- Newnham, R.M., Lowe, D.J., McGlone, M.S., Wilmshurst, J.M., Higham, T.F.G. 1998. The Kaharoa Tephra as a critical datum for earliest human impact in northern New Zealand. *Journal of Archaeological Science* 25, 533-544.
- *Palmer, D.J., Höck, B.K., Kimberley, M.O., Lowe, D.J., Payn, T.W. 2009. Comparison of spatial prediction techniques for developing *Pinus radiata* productivity surfaces across New Zealand. *Forest Ecology and Management* 258, 2046-2055.
- Parfitt, R. L., 1990. Allophane in New Zealand – a review. *Australian Journal of Soil Research* 28, 343–360.
- Parfitt, R.L. 2009. Allophane and imogolite: role in soil biogeochemical processes. *Clay Minerals* 44, 135-155.
- Parfitt, R.L., Pollok, J., Furkert, R.J. 1981. Guide book for tour 1, North Island. International ‘Soils With Variable Charge’ conference, Palmerston North (Feb 1981), pp. 84-90.
- Parfitt, R.L., Russell, M., Orbell, G.E. 1983. Weathering sequence of soils from volcanic ash involving allophane and halloysite. *Geoderma* 29, 41-57.
- Parfitt, R.L., Saigusa, M., Cowie, J.D. 1984. Allophane and halloysite formation in a volcanic ash bed under different moisture conditions. *Soil Science* 138, 360-364.
- Rijkse, W.C., Vucetich, C.G. 1980. Soils of Wairakei Research Station, North Island, New Zealand. *New Zealand Soil Survey Report* 57. 26 pp.
- Rijkse, W.C., Guinto, D.F. 2010. Soils of the Bay of Plenty. Volume 2: Central Bay of Plenty. Environment BOP Environmental Publication 2010/11-2. 198 pp.
- Sahetapy-Engel, S., Self, S., Carey, R.J., Nairn, I.A. 2014. Deposition and generation of multiple widespread fall units from the c. AD 1314 Kaharoa rhyolitic eruption, Tarawera, New Zealand. *Bulletin of Volcanology* 76 (8), article 836: DOI 10.1007/s00445-014-0836-4.
- Sase, T., Hosono, M. 1996. Vegetation histories of Holocene volcanic ash soils in Japan and New Zealand – relationship between genesis of melanic volcanic ash soils and human impact. *Earth Science (Chikyū Kagaku)* 50, 466-482.

- Sase, T., Hosono, M., Utsugawa, T., Aoki, K. 1988. Opal phytolith analysis of present and buried volcanic ash soils at Te Ngae Road tephra section, Rotorua Basin, North Island, New Zealand. *The Quaternary Research (Japan)* 27, 153-163.
- Schaetzl, R., Anderson, S. 2005. *Soils – genesis and geomorphology*. Cambridge University Press, New York, 817 pp.
- Selby, M.J., Hoskins, P.J. 1973. The erodibility of pumice soils of the North Island, New Zealand. *Journal of Hydrology (New Zealand)* 12, 32-56.
- Shoji, S., Kurebayashi, T., Yamada, I. 1990. Growth and chemical composition of Japanese pampas grass (*Miscanthus sinensis*) with special reference to the formation of dark-coloured Andisols in northeastern Japan. *Soil Science and Plant Nutrition* 36, 105-120.
- Shoji, S., Nanzyo, M., Dahlgren, R.A. 1993. *Volcanic ash soils: genesis, properties and utilization*, *Developments in Soil Science* 21, Elsevier, Amsterdam, 288 pp.
- Singleton, P.L., McLeod, M., Percival, H.J. 1989. Allophane and halloysite content and soil solution silicon in soils from rhyolitic volcanic material, New Zealand. *Australian Journal of Soil Research* 27, 67-77.
- Smith, R.T., Houghton, B.F. 1995. Vent migration and changing eruptive style during the 1800a Taupo eruption: new evidence from the Hatepe and Rotongaio phreatoplinian ashes. *Bulletin of Volcanology* 57, 432-439.
- Smith, R.T., Lowe, D.J., Wright, I.C. 2007. *Volcanoes*. Te Ara – The Encyclopedia of New Zealand. New Zealand Ministry for Culture and Heritage, Wellington. Updated 16 April, 2007. <http://www.TeAra.govt.nz/EarthSeaAndSky/NaturalHazardsAndDisasters/Volcanoes/en>
- Soil Survey Staff 1999. *Soil Taxonomy*, 2nd Edition. United States Department of Agriculture Natural Resources Conservation Service, Agriculture Handbook No. 436, Washington D.C., 869 pp.
- Soil Survey Staff 2014. *Keys to Soil Taxonomy*, 12th edition. United States Department of Agriculture Natural Resources Conservation Service, Washington D.C., 360 pp.
- Telfer, E.I. 2013. Leaching and uptake of N and pasture production associated with irrigation of treated wastewater, Taupo, New Zealand. MSc thesis, University of Waikato.
- Tonkin, P.J. 2012. *Soil investigation - DSIR soil science: 1930–1950*. Te Ara – the Encyclopedia of New Zealand. New Zealand Ministry for Heritage and Culture. Updated 13-Jul-12. <http://www.TeAra.govt.nz/en/soil-investigation/>
- Treweek, G. 2011. Nitrogen leaching from effluent irrigated pasture. MSc thesis, Univ. of Waikato.
- Underwood, E.J., Filmer, J.F. 1935. The determination of the biologically potent element (cobalt) in limonite. *The Australian Veterinary Journal* 11, 84-92.
- Vandergoes, M.J., Hogg, A.G., Lowe, D.J., Newnham, R.M., Denton, G.H., Southon, J., Barrell, D.J.A., Wilson, C.J.N., McGlone, M.S., Allan, A.S.R., Almond, P.C., Petchey, F., Dalbell, K., Dieffenbacher-Krall, A.C., Blaauw, M. 2013. A revised age for the Kawakawa/Oruanui tephra, a key marker for the Last Glacial Maximum in New Zealand. *Quaternary Science Reviews* 74, 195-201.
- Vucetich, C.G., Pullar, W.A. 1964. Stratigraphy of Holocene ash in the Rotorua and Gisborne districts. *New Zealand Geological Survey Bulletin* 73, Part 2, 43-88.
- Vucetich, C.G., Wells, N. 1978. *Soils, agriculture, and forestry of Waiotapu region, central North Island, New Zealand*. New Zealand Soil Bureau Bulletin 31, 100 pp + 5 map sheets and extended legends.
- Vucetich, C.G., Leamy, M.L., Popplewell, M.A., Ure, J., Taylor, C.R., Will, G.M., Sutton, J.A., Blakemore, L.C. 1960. *Soils, forestry and agriculture of the northern part, Kaingaroa State Forest and the Galatea Basin*. New Zealand Soil Bureau Bulletin 18, 51 pp + 2 map sheets.
- Wada, K. (Ed) 1986. *Ando Soils in Japan*. Kyushu University Press, Fukuoka, 276 pp.
- Walker, G.P.L. 1980. The Taupo plinian pumice: product of the most powerful known (ultraplinian) eruption? *Journal of Volcanology and Geothermal Research* 8, 69-94.
- Walker, G.P.L., Wilson, C.J.N. 1983. Lateral variations in the Taupo ignimbrite. *Journal of Volcanology and Geothermal Research* 18, 117-133.

- Walker, M., Johnsen, S., Rasmussen, S.O., Popp, T., Steffensen, J.-P., Gibbard, P., Hoek, W., Lowe, J.J., Andrews, J., Björck, S., Cwynar, L., Hughen, K., Kershaw, P., Kromer, B., Litt, T., Lowe, D.J., Nakagawa, T., Newnham, R.M., Schwander, J. 2009. Formal definition and dating of the GSSP (Global Stratotype Section and Point) for the base of the Holocene using the Greenland NGRIP ice core, and selected auxiliary records. *Journal of Quaternary Science* 24, 3-17.
- Watanabe, M., Sakagami, K. 1999. Recent pedological approach to reconstruction of the Quaternary environment in Japan and east Asia. *The Quaternary Research (Japan)* 38, 244-252.
- Watt, M.J., Palmer, D.J., Kimberley, M.O., Höck, B.K., Payn, T., Lowe, D.J. 2010. Development of models to predict *Pinus radiata* productivity throughout New Zealand. *Canadian Journal of Forest Research* 40, 488-499.
- Webb, T.H., Lilburne, L.R. 2011. Criteria for defining the soil family and soil sibling, the fourth and fifth categories of the New Zealand Soil Classification (2nd ed). Landcare Research Science Series 3, 38pp.
- Wilmshurst, J.M., McGlone, M.S. 1996. Forest disturbance in the central North Island, New Zealand, following the 1850 BP Taupo eruption. *The Holocene* 6, 399-411.
- Wilmshurst, J.M., Anderson, A.J., Higham, T.F.G., Worthy, T.H. 2008. Dating the late prehistoric dispersal of Polynesians to New Zealand using the commensal Pacific rat. *Proceedings of the National Academy of Sciences of the United States* 105, 7676-7680.
- Wilson, C.J.N. 1985. The Taupo eruption, New Zealand II. The Taupo ignimbrite. *Philosophical Transactions of the Royal Society, London A* 314, 229-310.
- Wilson, C.J.N. 1993. Stratigraphy, chronology, styles, and dynamics of late Quaternary eruptions from Taupo volcano, New Zealand. *Philosophical Transactions of the Royal Society of London A* 343: 205-306.
- Wilson, C.J.N. 1994. Post-conference tour day 1: Hamilton-Tokaanu. In: Lowe, D.J. (ed) Conference Tour Guides. International Inter-INQUA Field Conference on Tephrochronology, Loess and Paleopedology. University of Waikato, Hamilton, 74-100.
- Wilson C.J.N. 2001. The 26.5 ka Oruanui eruption, New Zealand: an introduction and overview. *Journal of Volcanology and Geothermal Research* 112, 133-174.
- Wilson, C.J.N., Walker, G.P.L. 1985. The Taupo eruption, New Zealand. I. General aspects. *Philosophical Transactions of the Royal Society, London A* 314, 199-228.
- Wilson, C.J.N., Blake, S., Charlier, B.L.A., Sutton, A.N. 2006. The 26.5 ka Oruanui eruption, Taupo volcano, New Zealand: development, characteristics and evacuation of a large magma body. *Journal of Petrology* 47, 35-69.
- Wilson, C.J.N., Gravley, D.M., Leonard, G.S., Rowland, J.V. 2009. Volcanism in the central Taupo Volcanic Zone, New Zealand: tempo, styles and controls. In: Thordarson, T., Self, S., Larsen, G., Rowland, S.K., Hoskuldsson, A. (Eds), *Studies in volcanology: the legacy of George Walker*. Special Publications of IAVCEI (Geological Society, London) 2, pp. 225-247.
- Yuan, G., Theng, B.K.G. 2012. Clay-organic interactions in soil environments. In: Huang, P.M., Li, Y., Sumner, M.E. (Eds), *Handbook of soil sciences*, 2nd edn, Vol. 2: Resource management and environmental impact. CRC Press, Boca Raton, pp. 2.1-2.20.
- Yuan, G., Wada, S.-I. 2012. Allophane and imogolite nanoparticles in soil and their environmental applications. In: Barnard, A.S., Guo, H. (Eds), *Nature's nanostructures*. Pan Stanford, Singapore, pp. 494-515.

***References missing from list above**

- Esler, W.R. 2010. An introduction to the Rotorua Basin and Okataina Volcanic Centre: an iconoclastic view. In: Lowe, D.J., Neall, V.E., Hedley, M., Clothier, B., Mackay, A. Guidebook for Pre-conference North Island, New Zealand 'Volcanoes to Oceans' field tour (27-30 July). 19th World Soils Congress, International Union of Soil Sciences, Brisbane. Soil and Earth Sciences Occasional Publication No. 3, Massey University, Palmerston North, pp. 4.23-4.29.
- Palmer, D.J., Lowe, D.J., Payn, T.W., Höck, B.K., McLay, C.D.A., Kimberley, M.O. 2005. Soil and foliar phosphorus as indicators of sustainability for *Pinus radiata* plantation forestry in New Zealand. *Forest Ecology and Management* 220, 140-154.