



THE UNIVERSITY OF  
**WAIKATO**  
*Te Whare Wānanga o Waikato*

Research Commons

<http://waikato.researchgateway.ac.nz/>

## Research Commons at the University of Waikato

### Copyright Statement:

The digital copy of this thesis is protected by the Copyright Act 1994 (New Zealand).

The thesis may be consulted by you, provided you comply with the provisions of the Act and the following conditions of use:

- Any use you make of these documents or images must be for research or private study purposes only, and you may not make them available to any other person.
- Authors control the copyright of their thesis. You will recognise the author's right to be identified as the author of the thesis, and due acknowledgement will be made to the author where appropriate.
- You will obtain the author's permission before publishing any material from the thesis.

**THE IMPACTS OF CLIMATE CHANGE ON CATTLE  
WATER DEMAND AND SUPPLY IN KHURUTSHE,  
BOTSWANA**

**A thesis  
submitted in partial fulfilment  
of the requirements for the degree  
of  
Doctor of Philosophy  
at  
the International Global Change Institute (IGCI)  
University of Waikato  
by**

---

**Sennyé Masike**

**University of Waikato**

**2007**

## **ABSTRACT**

The primary question that the thesis investigates is: what impacts could climate change have on cattle water demand and supply in Khurutshe, Botswana. This thesis is pursued in light of the fact that there is a lack of knowledge on climate change and cattle water demand and supply. Thus, this thesis aims at filling the gap in knowledge on climate change and cattle water resources in Botswana and other semi-arid environments.

A cattle water demand and supply model is developed to investigate the primary question of the thesis. The model is driven by rainfall and temperature over time as these variables largely determine cattle water supply and demand, respectively. Climate scenarios for 2050 are constructed using SimCLIM (developed by the International Global Change Institute of the University of Waikato) based on HadCM3 and CSIRO Mk2 General Circulation Models (GCMs). Three Special Report on Emission Scenarios (SRES) are used: A1B, A1FT and A1T. These emission scenarios were selected based on their coverage for possible future Greenhouse Gas emissions (GHG). Climate scenarios show that by 2050 the temperature for the Khurutshe area could increase by as much as 3 °C depending on the GCM and SRES emission scenario and that there could be a decline in rainfall of up to 14% per month. CSIRO Mk2 displayed the maximum decline in rainfall while HadCM3 depicted the maximum increase in temperature.

The model is implemented in the Khurutshe of the Kgatleng District, Botswana. The results reported are for Masama Ranch and also for the whole of the Khurutshe area. The results show that climate change could lead to an annual increase of more than 20% in cattle water demand by 2050 due to an increase in temperature. In addition, climate change could lead to a decline in the contribution of surface pan water to cattle water supply. Overall, there could be an increase in abstraction of groundwater for cattle by 2050 due to an increase in demand and a decline in forage water content and surface pan water. Observations in semi-arid environments of Africa indicate that farmers encounter problems of declining

borehole yields and local depletion in groundwater in summer and drought years when demand peaks. In addition, it has been observed that during drought more cattle are lost as a result of lack of water, particularly for those whose cattle are reliant on surface water. Thus, the results from this study indicate that climate change could enhance this problem.

In the thesis I have shown the importance of integrating climate change impacts on water demand and supply when assessing water resources, which has been ignored in the past. Some of the policy options that are discussed are tradable pumping permits for controlling abstraction and allocation issues in the Khurutshe aquifer and, controlling stocking numbers. This is in recognition of the fact that climate change could result in more reliance on groundwater for both cattle farming and urban water supply hence compromising sustainability and allocation issues especially for the Khurutshe aquifer which is earmarked to supply the city of Gaborone and surrounding villages in drought periods.

## Acknowledgements

Firstly, I would like to give thanks and praise the Lord God who makes all things possible. I am heavily indebted to my supervisors Dr. Peter Urich (chief supervisor), Dr Wei Ye, Dr. Peter Kouwenhoven, and Prof Richard Warrick for their comments and guidance in this thesis. I am heavily indebted and acknowledge Dr Peter Urich whose comments and guidance made completion of this study possible. I am heavily indebted to his advice on data collection methods, layout and overall outcome of this study from the proposal to the finalisation of this thesis. Special thanks to Dr Wei Ye for his expertise on construction of climate scenario and SimCLIM, data analysis and comments on chapters 5, 7 and 8. I would also like to say thank you to Dr Peter Kouwenhoven for comments on data analysis, programming and guidance on modelling and comments on chapter 9 and 10. Lastly Prof. Richard Warrick for building up the proposal that led to this study.

I also wish to express my gratitude to Dr Peter Urich for accommodating me at his place, Zuluka and Anya for their company during my stay in New Zealand. I am heavily indebted to you guys; I could not have done this thesis without you especially during my trying moments. In addition, I would like to say thank you to the whole of IGCI staff for their support during the loss of my family. Special thanks to the following for their support: Prof Neil Ericksen and Glennis Ericksen, my friends Denis and Anne Craw, and Hamilton SDA members for their love and support. I will also like to pass my gratitude to Gaborone SDA and AFM church members and the Dimbungu family for their support. Many thanks to my fellow students, Lisa Kosy for her support, encouragement and assistance with my topic, and Greg and Katie. And lastly, my MOTHER.

I also wish to express my gratitude to the Department of Meteorological Service (Botswana) for climate data which was used for construction of climate scenarios and modelling, especially to Ms Malefshane. M. Mogotsi and Mrs. Lillian Ntshwarisang. John Molefe and Max Oulton for drawing the maps, and Edwin Keetshabe, Denis and Cox for assisting in data collection.

*In memory of*

*This thesis is written in memory of my best friend and wife Keboletse Kay Masike and my friend, play-mate and son Bogolo “Tippi-Nnana” Masike. You are my inspiration for the completion of this thesis. Rest my friends until we meet again when our Lord Jesus Christ, king of kings comes to take us home.*

## Table of Contents

Chapter 1 : Introduction .....	1
Background and statement of the problem .....	1
Methodology .....	8
Climate change.....	8
Pans water and climate change .....	9
Forage water content and climate change .....	10
Model development for cattle water system .....	11
Primary and specific questions .....	11
Goal, objectives and tasks of the research .....	12
Thesis outline .....	15
Chapter 2 : Evidence of Gap in Knowledge on Climate Change and Cattle Water Demand .....	18
Introduction.....	18
Developments on cattle water demand over time and the gaps .....	19
Evidence of imbalances in climate change research .....	21
The impacts of climate change on water resources .....	22
Climate Change and Water Supply .....	22
Link between climate change and water demand .....	23
Climate change and its impacts on water demand .....	24
Urban water demand .....	25
Irrigation water demand and climate change .....	25
Livestock water demand and climate change .....	27
Rational for assessing the impacts of climate change on cattle water demand.....	28
Summary .....	30
Chapter 3 : Water Resources and Challenges in Botswana and the Kgatleng District.....	31
Introduction.....	31
Background of the Country .....	32
Problems of increased livestock in Botswana.....	36
Climate of Botswana and weather patterns.....	37
Precipitation .....	38

Temperature	39
Water rights, policies and Country Acts governing use of water .....	40
Water resources and demand pattern in the country .....	41
Groundwater occurrence, aquifers and their properties .....	44
The Geological and Hydrogeological description of the Khurutshe Aquifer .....	46
The Geology of the Khurutshe Area	47
Hydrogeology of the Khurutshe Area	48
Recharge estimate in the Ntane Aquifer .....	55
Chemical and isotope techniques for estimating groundwater recharge in semi-arid environment and the study area	56
Chloride Mass Balance Method for estimating groundwater recharge	57
Khurutshe aquifer properties (conductivity, transmissivity and thickness).....	60
Water resources for livestock and challenges faced by farmers in the Kgatleng District.....	61
Groundwater utilization and sustainability issues in the country .....	68
Current groundwater utilisation for livestock and sustainability issues in the Khurutshe Area	75
Climate change and cattle water demand.....	78
Summary .....	81
Chapter 4 : System Dynamics Modelling .....	83
Introduction .....	83
Systems and their structures.....	84
Dynamics of systems	87
Dynamics of cattle water demand and supply.....	91
System dynamic approach .....	92
Types of System Dynamics Methods.....	95
The feedback loop and modular approaches	95
Qualitative system dynamics method	96
Quantitative system dynamics	98
Time factor and system dynamic equations .....	101
Delays and information smoothing in system dynamics.....	103
STELLA software .....	103
Summary .....	104
Chapter 5 : Climate Scenarios and Impact Assessment Studies .....	106



Introduction .....	106
Climate scenarios and uses in climate change studies .....	107
Uses of scenarios in assessments studies .....	109
Uncertainty in scenarios .....	111
Construction of climate scenarios .....	112
Baseline conditions and climate change scenarios .....	113
Socioeconomic/emission scenarios .....	114
Types of climate scenarios .....	118
Incremental scenarios .....	118
Analogue scenarios .....	118
General circulation models .....	120
Variability of climate scenarios in inter-GCM experiments .....	124
Procedure for selecting GCM output .....	125
Regional climate scenario .....	126
Regionalisation/Downscaling Techniques .....	126
Dynamical downscaling .....	127
Empirical/Statistically downscaling .....	127
Transfer functions/regression methods .....	128
Weather typing .....	129
Weather generators .....	130
Baseline data for the study area .....	131
Climate and climate scenarios for the study area .....	132
The issue of variability in cattle water demand and supply .....	137
Summary .....	138
Chapter 6 : Rainfall Patterns and Pan Water .....	140
Introduction .....	140
Pan water and its importance to the livestock grazing system .....	141
Rainfall patterns in the study area .....	143
Rainfall-runoff modelling and pan water .....	144
Towards a simple rainfall-runoff model to estimate pan water for the study area .....	145
Seepage, evaporation and cattle consumption from pans .....	151
The effect of climate change on pan water .....	153
Summary .....	154

Chapter 7 : Forage Water and Climate Change .....	156
Introduction.....	156
Rangeland productivity in the semi-arid environments .....	157
Precipitation, evapotranspiration and soil moisture .....	161
Soil characteristics in the study area and soil water content.....	164
Towards modelling evapotranspiration .....	165
Modelling forage water content in the Masama Ranch .....	173
Estimating water intake from forage.....	174
Models for estimating daily forage intake .....	176
The effects of climate change on forage water .....	177
Summary .....	178
Chapter 8 : Development of the Cattle Water Model .....	180
Introduction.....	180
Cattle water system .....	181
Purpose of the model.....	184
Reference mode of behaviour for cattle water demand for borehole water .....	185
Model structure for cattle water system model .....	186
Model calibration and simulation of the function relationship between model variables .....	187
Functional relationships between variables in the developed model.....	189
Cattle daily water consumption model .....	189
Time series data modelling .....	190
Simple linear regression model for water consumption .....	193
ARIMA model for cattle water consumption .....	194
Using moving average to simulate daily consumption .....	199
Rainfall-runoff, water in pans and seepage.....	203
Evaporation from pans .....	209
Consumption from the pans .....	211
Forage water content and rainfall in the study area .....	213
Estimating groundwater quantity in the Masama Ranch and recharge rates .....	218
Groundwater recharge rates in the Masama Ranch .....	219
Groundwater sustainability and cattle water consumption in Masama Ranch .....	220
Evaluating the validity of the developed cattle water supply model .....	221
Sensitivity analysis of the model .....	224

Summary .....	227
Chapter 9 : Impacts of Climate Change on Cattle Water Resources .....	229
Introduction .....	229
Baseline water demand and supply in a semi-arid grazing system.....	230
Cattle water demand, abstraction rates under the baseline period	231
Contribution of pan water to annual livestock water demand and climate change	236
Forage water content under the baseline period	240
Abstraction rates of groundwater and sustainability for the baseline period	241
Cattle water demand and supply by the year 2050 .....	249
Cattle water demand by 2050	249
Contribution of surface water supply to water demand by 2050	252
The impacts of climate change on evaporation rates by 2050 .....	254
Forage water content for cattle water supply by 2050	255
Abstract rates of groundwater and sustainability by 2050	257
Groundwater sustainability by 2050	259
Discussion of the findings.....	262
The importance of groundwater in Botswana and abstraction management options.....	267
Groundwater abstraction management for cattle water demand	268
Controlling stocking rates	268
Tradable pumping permits	270
Summary .....	271
Chapter 10 : Conclusions and Summaries .....	273
Introduction.....	273
Rational for choosing this topic and contribution to knowledge .....	273
Cattle population and water resource in Botswana .....	275
Methodology .....	276
Climate scenarios (rainfall and temperature).....	277
Rainfall patterns and pans water for cattle.....	278
Forage water content.....	279
Model development and validity.....	279
Results and recommendations.....	280
Cattle water demand	280

Surface water supply for cattle	281
Abstraction of groundwater	282
Implication of the findings in relation to semi-arid environments of Africa .....	284
Management recommendations	286
Strength of this study .....	287
Limitations of the study .....	288
Future work required.....	289
Reference: .....	291
Appendix 1 .....	321
Data import .....	322
Spatial climate scenario generator .....	323
Generalised Extreme event Analysis .....	325
Impact model component of SimCLIM .....	326
Appendix 2 .....	328

### **Table of Figures**

Figure 1.1: Study area in a national and Southern Africa context .....	6
Figure 1.2: Study area relative to NSWC, Gaborone and the dams.....	7
Figure 3.1:Trends in cattle population between 1915-1999.....	35
Figure 3.2: Annual precipitation for Khurutshe (1960-1990).....	39
Figure 3.3: Water demand and projections for all sectors in the country. ....	44
Figure 3.4: Groundwater resources in Khurutshe area.....	50
Figure 3.5: Distribution of pans in the study area.....	65
Figure 3.6: Borehole distribution in the Khurutshe area.....	77
Figure 4.1: An example of system structure, components, feedbacks and boundary .....	85
Figure 4.2: A dynamic system over time .....	88
Figure 4.3: An example of a feedback mechanism.....	89
Figure 4.4: Examples of exponential and goal seeking behaviour.....	90
Figure 4.5: Examples of s-shaped and oscillation behaviour.....	91
Figure 4.6: Voluntary per capita water demand for cattle for different months...	92
Figure 4.7: Stages in system dynamic modelling .....	94
Figure 4.8: Quantity of stock over time. ....	100

Figure 4.9: Time steps in simulating.....	101
Figure 4.10: Components of cattle water demand-supply. ....	105
Figure 5.1: An example of climate scenario construction under an equilibrium experiment.....	122
Figure 5.2: An example of climate scenario construction under a transient experiment.....	123
Figure 5.3: Baseline Tmax , Tmin and Average Tmax.....	131
Figure 5.4: Annual rainfall recorded for Khurutshe (1960-1990).....	132
Figure 5.5 : Temperature for baseline and 2050 based on HadCM3 and CSIRO Mk2 GCMs. ....	135
Figure 6.1: Standard deviation for monthly average precipitation (1960-1990)	143
Figure 7.1:Observed average sunshine hours for Khurutshe area.....	172
Figure 8.1:Borehole and pump in Masama Ranch.....	183
Figure 8.2:Water storage tank in Masama Ranch. ....	183
Figure 8.3: Cattle drinking from a trough in Masama Ranch .....	184
Figure 8.4: Cattle water demand for borehole water.....	186
Figure 8.5: Qualitative cattle water demand and supply model (using STELLA software).....	187
Figure 8.6: Water meter used for recording daily water consumption. ....	191
Figure 8.7: ACF for the non-difference daily water consumption.....	196
Figure 8.8: ACF for the difference daily water consumption .....	196
Figure 8.9: Observed and estimated daily water intake .....	202
Figure 8.10: Simulated daily water consumption .....	203
Figure 8.11: Rainfall events in Masama ranch from (dec 04-august 05).....	204
Figure 8.12: Simulated water quantity in pan .....	206
Figure 8.13: Composition of soil types within a typical pan in Khurutshe area.	207
Figure 8.14: Dry pan in Masama Ranch. ....	207
Figure 8.15: Simulated seepage rate in the pan.....	209
Figure 8.16: Daily evaporation from pan.....	211
Figure 8.17: Cattle consumption from the pan. ....	213
Figure 8.18: Simulated evapotranspiration. ....	215
Figure 8.19: Observed and estimated average evapotranspiration.....	216
Figure 8.20: Observed and estimated forage water content.....	217
Figure 8.21: Water obtained from forage (litres).....	218

Figure 8.22: Simulated sustainability index in Masama .....	221
Figure 8.23: Abstraction rate of groundwater for cattle consumption .....	224
Figure 8.24: Sensitivity analysis for abstraction rates. ....	225
Figure 8.25: Sensivity analysis for sustainability index .....	226
Figure 9.1: per capita consumption for the baseline period .....	233
Figure 9.2: montly water demand for the baseline period for Masama Ranch ...	234
Figure 9.3: Annual water demand between baseline years. ....	235
Figure 9.4: Monthly contribution of surface and borehole to cattle water demand for the baseline period. ....	237
Figure 9.5: Maximum contribution of pan water to cattle water demand.....	239
Figure 9.6: Annual contribution of pan water to annual water demand for the baseline period for Khurutshe area. ....	240
Figure 9.7: Ratio of water in forage per gram for the baseline period.....	241
Figure 9.8: Monthly abstraction rates for the Baseline period.....	243
Figure 9.9: Mean daily abstraction rates with and without pan water. ....	244
Figure 9.10: Max and average daily abstraction rate over the years for Masama Ranch .....	245
Figure 9.11: Daily abstraction rate in Khurutshe .....	245
Figure 9.12: Sustainability index for Masama Ranch for the baseline period. ...	247
Figure 9.13: Sustainability for Khurutshe area for the baseline period. ....	248
Figure 9.14: Water demand by 2050 based on different emission scenario for Masama Ranch. ....	250
Figure 9.15: Changes in water demand between 2050 and baseline period for Masama Ranch. ....	251
Figure 9.16: Total monthly water demand for Khurutshe area for baseline and 2050.....	251
Figure 9.17: Water demand over time for Masama ranch .....	252
Figure 9.18: Percentage decline in supply of surface pan water to cattle water demand .....	254
Figure 9.19: Evaporation rates for the baseline and 2050 based on GCMs and SRES emission Scenarios .....	255
Figure 9.20: Forage water content for the baseline and 2050 using HadCM3 A1FT and A1T emission scenarios .....	256
Figure 9.21: Change in ratio of water in forage between baseline and 2050.....	257

Figure 9.22: Daily abstraction rates for baseline and 2050 for Masama Ranch.	258
Figure 9.23: Daily abstraction rate for Khurutshe area.....	258
Figure 9.24: Changes in abstraction rate of groundwater .....	259
Figure 9.25: Groundwater sustainability for Masama Ranch .....	261
Figure 9.26: Groundwater sustainability for Khurutshe area.....	261
Figure 10.1: data import wizard icon .....	322
Figure 10.2: Site data editor .....	323
Figure 10.3:Climate variables icon .....	323
Figure 10.4: Scenario generation parameters.....	324
Figure 10.5: Extreme event analysis interface. ....	325
Figure 10.6: Extreme value analysis result graph .....	326
Figure 10.7: DLL registration interface. ....	327

## Table of Tables

Table 3-1: Recharge estimates for the Khurutshe area. ....	60
Table 3-2: water sources in the Kgatlang District.....	63
Table 3-3: Cattle losses from the Limpopo River.....	64
Table 5-1: Summary of the IS92 Scenarios and their environmental implications .....	115
Table 5-2: Summary of the SRES emission scenarios and their environmental implications .....	117
Table 5-3: average increase in temperature by 2050 from the baseline temperature in °C.....	134
Table 5-4: Changes in rainfall by 2050 from the baseline period in % by month .....	134
Table 5-5: extreme event analysis for temperature by 2050 .....	136
Table 5-6: Return period of drought for baseline and 2050.....	137
Table 6-1: Rainfall, surface type and runoff coefficients. ....	149
Table 6-2: Runoff coefficients for rural areas.....	150
Table 6-3: Runoff curve numbers for different catchment surfaces. ....	151
Table 7-1: ANPP and precipitation in semi-arid environments in Africa.....	159
Table 7-2: SMSC for ferralic Arenosols.....	164
Table 8-1: R-squared for linear cattle water demand model.....	193

Table 8-2: coefficients for the simple linear cattle water demand.....	193
Table 8-3: Parameters estimate for the ARIMA (110) .....	197
Table 8-4: Parameters estimates for the ARIMA (2 1 0).....	198
Table 8-5: Parameter estimates for the average water demand model.....	200
Table 9-1: Comparison of daily water consumption in litres with other studies	233
Table 9-2: Standard deviation for the contribution of pan water to cattle water demand for months.....	238
Table 9-3: increase in water demand by 2050 for Masama ranch .....	252
Table 9-4: Annual sustainability for groundwater abstraction in m <sup>3</sup> .....	260
Table 9-5: cattle water abstraction as a percentage of recharge.....	262
Table 9-6: Stocking rate to achieve sustainability for baseline and 2050.....	269
Table 10-1: Increase in water demand by 2050 .....	281
Table 10-2: decline in surface water supply to cattle water demand .....	282
Table 10-3: increase in groundwater abstraction rates.....	283



# Chapter 1 : Introduction

---

## Background and statement of the problem

In this thesis I investigate the impacts of climate change on cattle water demand and supply in the Khurutshe area, of the Kgatleng District in Botswana. Figure 1.1 shows the location of the study area in a national and southern Africa context. A system dynamics model is developed with temperature and rainfall being the determinants of cattle water demand and supply. A time frame for assessing the impacts of climate change is 2050. This time frame has been selected as it is perceived to be not too far off from the present time to raise doubts. It was felt that if a year is too far in the future it would raise doubts and the results may not be significant to policy makers. In addition, it was felt that if a year is too distant such as 2100, decision and policy makers may dismiss the findings as of no relevance to this generation.

Globally, the livestock sector is an important economic activity. Steinfeld *et al* (2006) highlight its social and political importance. It is the major contributor (40 %) to global agricultural gross domestic product (Delgado *et al.*, 1999; Steinfeld *et al.*, 2006). In addition, it is noted that “it employs 1.3 billion people and creates livelihoods for one billion of the world’s poor” (Steinfeld *et al.*, 2006). Over the years, there have been major changes in livestock systems in terms of production and management practises. These dynamics have been linked to the global demand and consumption patterns for livestock products (Delgado., *et al.*, 1999; Sere *et al.*, 2007; Steinfeld *et al.*, 2006). Growth in human population and incomes and economic expansion and changes in food preferences contributed significantly to the increase in demand for livestock products (Delgado *et al.*, 1999, Sere *et al.*, 2007 & Steinfeld *et al.*, 2006).

Global production of meat could more than double from 229 million to 465 million tonnes in 2050 and milk could also double from 580 million to 1 043 million tonnes between 1999/01 and 2050 (Steinfeld *et al.*, 2006). According to Delgado *et al.*, (1999), to keep up with the increase in demand for livestock products (meat and milk) there is a likelihood that there will be an increase in the numbers of animals. Furthermore, there has also been a shift from extensive grazing towards intensification and industrialization (Delgado *et al.*, 1999; Sere *et al.*, 2007; Steinfeld *et al.*, 2006). Steinfeld *et al.* (2006:xx) note that “livestock production is shifting geographically, first from rural areas to urban and peri-urban, to get closer to consumers, then towards the sources of feedstuff”. Thus, increasingly, farmers are using more livestock feeds such as maize and other grains in livestock production.

An increase in livestock numbers and a change in their management (intensification and industrialisation) will have an impact on the environment. Steinfeld *et al.*, (2006) point out that livestock is the single largest anthropogenic use of land and impacts the environment considerably. It causes deforestation, degradation due to overgrazing, compaction and erosion, lower groundwater tables, reduced infiltration, and contributes significantly to climate change (methane, nitrous oxide, emission and through deforestation). Importantly, the “livestock sector is the key player in increasing water use” (Steinfeld *et al.*, 2006:xxii). Thus, it is noted that with projected increases in livestock products and increase in livestock numbers to keep up with demands for products, competition for water between sectors may increase. Moreover, intensification and industrialisation of livestock may also increase the percentage of water use by this sector. More water will be required to produce livestock feeds and also as the livestock will be feeding on dry feeds the demand for water may increase. Sub-Saharan Africa is projected to increase water demand for irrigation by 27% by 2025. It is noted by Steinfeld *et al* (2006) that involuntary water intake (water taken during ingestion) constitutes 15% of total water requirement.

Local demands for both meat and milk mimic the global patterns. This is a result of combinations of factors such as increased incomes, human population and urbanisation. In addition, the Botswana Meat Commission and Ministry of

Agriculture has encouraged intensification in the livestock sector. Thus, there is an increase in the number of feedlots. Though feedlots are few in number and small in scale they are poised to increase in the near future. Strong demand for livestock products in Botswana has led to an increase in the price of beef. For instance, last year the Botswana Meat Commission increased the price of beef by 40%. This sector has now become attractive for investors. As projected by Steinfeld *et al.*, (2006) environmental impacts of livestock such as depletion and pollution of water resources, rangeland degradation and biodiversity loss might intensify. In future, competition for water resources, both surface and groundwater, could intensify in Botswana.

The livestock sector<sup>1</sup> accounts for 40% of annual water use and is the largest user at a national level. Steinfeld *et al.*, (2006) on the other hand note that livestock accounts for 23% of total water use in Botswana. Most of the water servicing the cattle sector is sourced from groundwater. However, during the rainy season (November to March) pans<sup>2</sup> can provide surface water for livestock. The importance of pans is reflected by the fact that some farmers in Botswana, particularly in the hardveldt region, are dependent on them to water their livestock. These farmers resort to buying water from farmers with boreholes when the pans dry. The increase in cattle numbers in the country is linked to borehole development of groundwater resources. For example, borehole technology facilitated the expansion of the cattle industry into the sandvedlts part of the country, which hitherto lacked suitable surface water resources. The increase in cattle numbers has resulted in environmental problems amongst them being increased abstraction of groundwater to satisfy cattle water demand. The increased rate of abstraction has led to a debate regarding the sustainability of groundwater resources, with some arguing that current abstraction rates are not sustainable (Kgathi, 1998). The problem of increased groundwater abstraction has manifested itself in many ways: increased salinity of some boreholes, local depletion as reflected by declining borehole yields, declining water tables and in some cases drying up of boreholes and hand-dug wells. The water table in the Khurutshe area

---

<sup>1</sup> Livestock sector constitute the following animals: cattle, goats, sheep, donkeys, horses, pigs, mules and chicken. In this study the emphasis is on cattle because they represent the largest sector both by sheer numbers and in economic impact.

<sup>2</sup> A pan is a depression on land that holds rainwater. It can be natural or man-made.

is declining at a rate of 0.61 m per year (Arntzen *et al.*, 2003). Generally, declining water tables indicate water mining (CSO, 2000). In many cases, these problems are encountered during the regular dry season but are exacerbated by drought (CSO, 2000) when rainfall decreases and demand peaks (Calow *et al.*, 2002). To conserve water, farmers control the frequency with which their cattle drink particularly in areas where there are problems of local depletion (Nicholson, 1987).

Observations throughout the semi-arid environments of Africa indicate that water demand peaks in summer when it is hot and most of the water scarcity problems manifest (Calow *et al.*, 2002; Mati *et al.*, 2005). During drought periods farmers can lose up to 50% of their cattle as a result of acute water scarcity (Mati *et al.*, 2005). More hours of groundwater pumping and more diesel (fuel) are required for groundwater abstraction in summer. In addition, research on cattle water daily intake revealed that water demand varied markedly with temperature (Hoffman and Self, 1972; Parker *et al.*, 2000; Roller and Goldman, 1969). Climate change could have an effect on future temperature and rainfall thereby influencing cattle water demand and supply, thus, forming justification for this research.

This thesis is carried out in the Khurutshe area of the Kgatleng District. Khurutshe has a high density of boreholes to supply cattle with water. It is also the site of boreholes for the North South Water Carrier (hereafter NSWC) which supplies potable water to Gaborone. This part of the Kgatleng District is settled by wealthy farmers and therefore has high stocking rates. This study area has been selected due to the strategic location of the aquifers to the NSWC. The NSWC pipeline transports water from the north at Letsibogo dam (350 km) to Gaborone in periods when local Gaborone dams cannot meet Gaborone's demand. The production boreholes in the Khurutshe wellfield are to be used as back-up supply when dams cannot meet the demands of Gaborone and surrounding villages. Figure 1.2 depicts the location of the study area in relation to Gaborone dams and the pipeline.

For the Khurutshe aquifer to be exploited and used as an adaptation strategy it must be managed properly and future impacts of climate change on current

abstraction rates must be investigated. In addition, climate change, especially declining precipitation, will affect the runoff into the dams in future and therefore there might be a shift in reliance to groundwater for urban water supply. This could lead to competition and allocation issues; hence policies need to be put in place now.

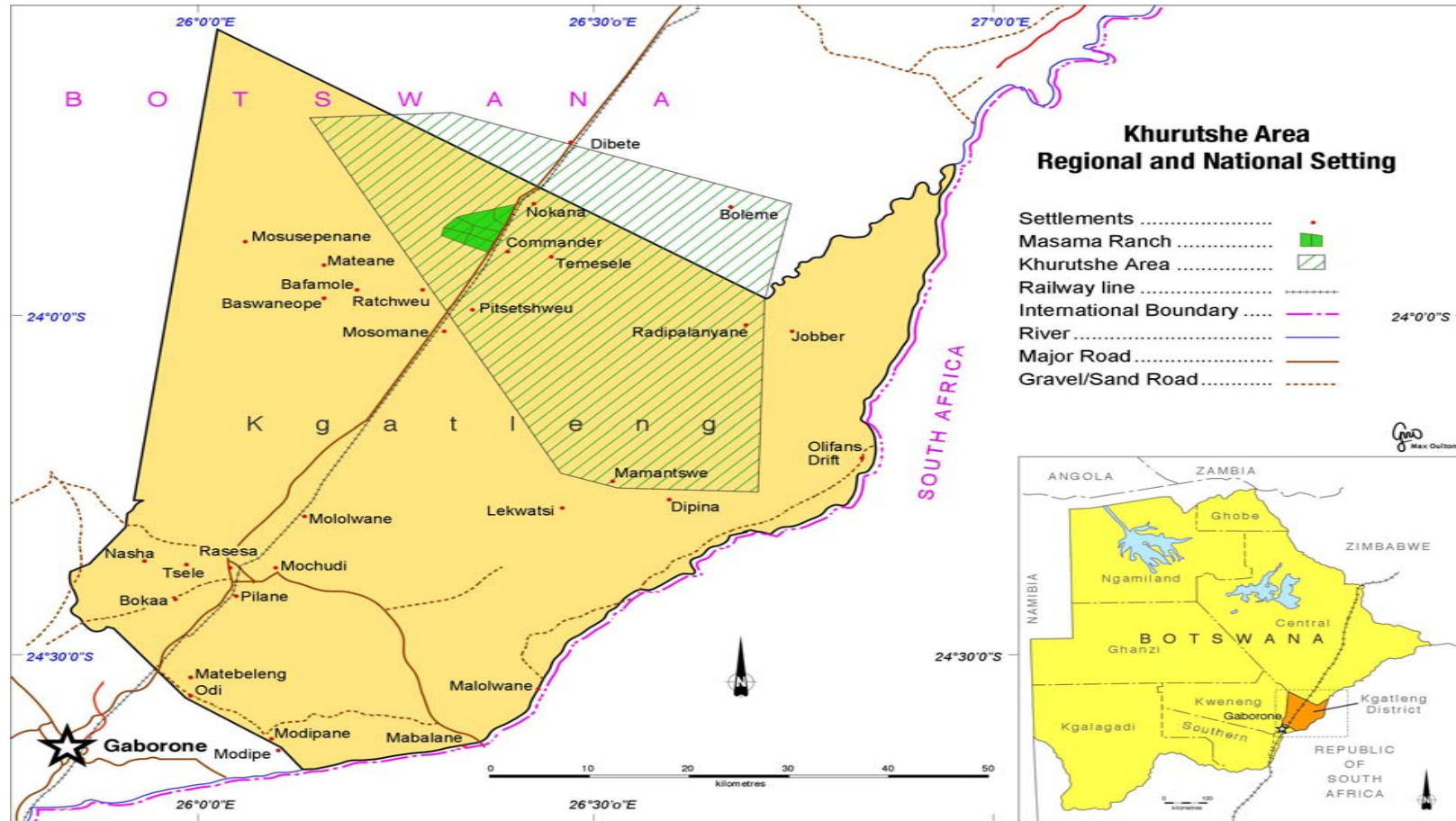

Figure 1.1: Study area in a national and Southern Africa context

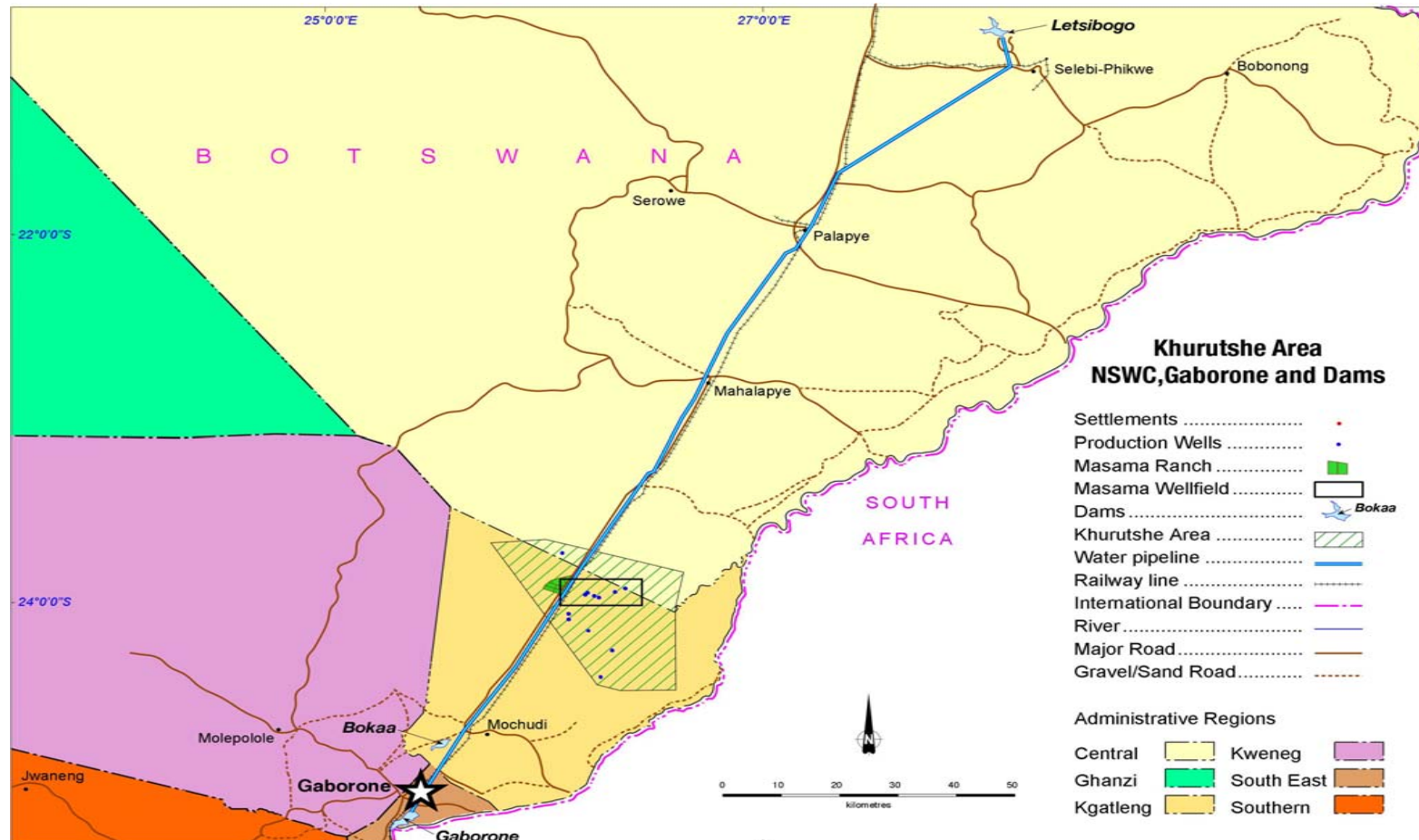

Figure 1.2: Study area relative to NSWC, Gaborone and the dams

## Methodology

A system dynamics model is adapted as a methodological approach to assess the impacts of cattle water demand and supply in Khurutshe, Kgatleng District. System dynamics models for modelling systems have been used for over 40 years (Kirkwood, 1998). The credit for the development of the modelling tool is given to J.W. Forrester. Over the years the methodology has been used to model almost any complex system from all disciplines (Honggang, 2003; Moxnes, 2000; Satsangi *et al.*, 2003; Schieritz and Milling, undated). The advantage of system dynamics modelling lies in the integration of feedbacks into the modelling system, which are responsible for its complexity. The components and interaction of the cattle water model is depicted in a simplified version in Figure 4.10.

## Climate change

Rainfall and temperature are the two climatic variables driving the model. Both variables will be affected by climate change (Dessai *et al.*, 2005; IPCC, 2001; IPCC, 2007). For instance IPCC (2007:7) notes that “at continental, regional, and ocean basin scales, numerous long-term changes in climate have been observed. These include changes in Arctic temperatures and ice, widespread changes in precipitation amount, ocean salinity, wind patterns and aspects of extreme weather including drought, heavy precipitation, heat waves and the intensity of tropical cyclones”. According to General Circulation Models (hereafter GCMs) global temperatures are warming as a result of greenhouse gases (hereafter GHGs) (Dessai *et al.*, 2005; Giorgi, 2005; IPCC, 2001; IPCC, 2007). Similarly it is projected that rainfall will be affected by climate change. The magnitude and direction of changes in rainfall will vary from region to region. For Southern Africa, GCMs indicate that there will be a decline in rainfall (Hulme, 1996; IPCC, 2001). IPCC (2007) indicate that “drying has been observed in the Sahel, the Mediterranean, southern Africa and parts of southern Asia”. Such changes may affect water demand and supply for cattle through a decline in pan water and an increase in demand due to increased temperatures. Consequently, abstraction of groundwater to satisfy water demand may affect groundwater sustainability and potentially worsen the current water situation in semi-arid environments.



To investigate the effects of climate change on cattle water demand and supply, climate scenarios are needed. SimCLIM<sup>3</sup> is used to generate climate scenarios (temperature and rainfall) to 2050. SimCLIM is extensively discussed in appendix 1. Two GCMs were selected: CSIRO Mk2<sup>4</sup> and HadCM3<sup>5</sup>. CSIRO Mk2 and HadCM3 are two of a wide range of GCMs that are three dimensional that incorporate all the major aspects (atmosphere, ocean, cryosphere and the biosphere) of the climate system (McCarthy *et al.*, 2001). To simulate the climate, baseline climate data is required plus solar radiation; concentration of GHGs; and concentration of sulphate aerosols (McCarthy *et al.*, 2001). In this study CSIRO Mk2 and HadCM3 GCMs were chosen as they cover the highest and lowest changes in precipitation and temperature. For instance, CSIRO Mk2 projects a high decrease in precipitation and a lower increase in temperature while HadCM3 projects a high increase in temperature and a lower decrease in rainfall. In addition, three Special Report on Emission Scenarios (hereafter SRES) were selected: A1B, A1T and A1FT. The rationale for selecting these SRES emission scenarios is that they cover the lowest emission (A1B,) average emissions (A1T) and highest emissions (A1FT).

### **Pans water and climate change**

Pan water is one of the important components of the cattle water system in semi-arid environments (Arntzen *et al.*, 1998; Arntzen and Opschoor, 1985; Bergstrom and Skarpe, 1999; Burgess, 2003; Moleele and Mainah, 2002; Wesemael *et al.*, 1998). Pans represent an important water resource for rural economies especially the livestock sector. Surface water runoff from rainfall is collected in pans. Runoff in semi-arid environments can be low especially in the sandveldts due to high infiltration rates. The availability of pan water can affect the rate of groundwater abstraction as during the rainy season cattle drink pan water (Burgess, 2003) and abstraction of groundwater falls to zero. Unlike boreholes, pans are a more

---

<sup>3</sup> SimCLIM is a software modelling tool developed by International Global Change Institute of the University of Waikato that simulates and models climate. The software uses inputs from GCMs and SRES emission scenarios, in addition to local baseline data.

<sup>4</sup> CSIRO Mk2 is a global coupled ocean –atmosphere climate model developed by the Australian Commonwealth Scientific and Industrial Research Organisation.

<sup>5</sup> HadCM3 is a third-generation coupled atmosphere –ocean GCM developed by the Hadley Centre in the United Kingdom for climate prediction and research.

convenient source of water for cattle. This is because pans are often located near grazing areas and therefore cattle need not trek long distances between grazing areas and water points. Compared to boreholes, pastures surrounding pans are not severely overgrazed as they only hold water during the rainy season.

Pans can be affected by climate change mainly through changes in rainfall and changes in evapotranspiration rates. For instance, it is expected that there will be a reduction in precipitation for the Sahel and Southern Africa and Horn of Africa (IPCC, 1998). At the same time, evapo-transpiration is projected to increase while runoff may decrease (Hulme 1996; IPCC, 1998, 2001). Thus, reliance on borehole water could increase and for those livestock with no access to boreholes, climate change could be fatal.

### **Forage water content and climate change**

Forage water content is another important component of the cattle water system (Bartholomew, 2004). It provides involuntary water intake (Bartholomew, 2004; Hoffman and Self, 1972; Howden *et al.*, 1999; Parker *et al.*, 2000; Perrington and Devender, undated; Roller and Goldman, 1969; Steinfeld, *et al.*, 2006). This is water obtained from forage during ingestion. Thus, it has been observed that daily water intake is affected by forage water content. Cattle that graze lush forage demand less water than those which graze dry forage. In semi-arid environments, where there is no irrigation, rainfall is the only source of soil water for forage. Intuitively, forage water content is highly variable over short time periods. It is also determined by evapotranspiration which is a function of climatic variables.

Daily involuntary water intake is a product of forage intake and forage water content. Forage intake is a complex phenomenon and current models' performance in estimating forage intake are poor (Coleman and Moore, 2003; Roseler *et al.*, 1997). This is because there are many factors interacting to determine forage intake. In this thesis, a rule of thumb is used to estimate daily forage intake.

Climate change may affect forage water negatively through changes in rainfall and changes in transpiration. Baker and Viglizzo (1998) note that elevated concentration of atmospheric CO<sub>2</sub> could accelerate transpiration. This may affect evapotranspiration leading to decline in soil water. In addition, decreased rainfall may be accompanied by declines in soil water leading to the same effect as above.

### **Model development for cattle water system**

Boundaries define a system and the components that have an influence on the system (Wilson, 1981). Outside a system's boundary, variables do not have any influence on the system's dynamics. In constructing the model for a cattle water system, the literature on cattle water systems in semi-arid environments is surveyed to determine a boundary and select the above mentioned components of the model. Farmers were consulted to assist in identifying the components of the cattle water demand and supply system. Selection of these components was done based on the following criteria: that the model be a true representative of the real system; that the model be simple and manageable; and, lastly the model should be applicable to any semi-arid environment of Africa.

### **Primary and specific questions**

The primary and specific questions of this study are as follows:

The primary question is:

- What impacts could climate change have on cattle water demand and supply in Khurutshe, Botswana?

**Specific questions are:**

1. What determines water supply and demand for cattle?
2. What changes in climate are expected by 2050 in Khurutshe, Botswana?
3. How might cattle water demand be impacted by these changes?
4. How might cattle water supply be impacted by these changes?

- a. What sources of water supply can be identified?
  - b. How might these sources be impacted?
5. Is the current supply: demand ratio sustainable?
  6. Might the future supply: demand ratio be sustainable with climate changes?
  7. How can supply/demand characteristics be changed to become sustainable?

### **Goal, objectives and tasks of the research**

The goal of the study is to establish and enhance scientific knowledge on the impacts of climate change on water demand, which has not been thoroughly explored in climate change impact studies. It is envisaged that enhancing scientific knowledge and closing this scientific gap will contribute to sound and effective water management, with specific reference to groundwater resources. This goal will be achieved by constructing a cattle water demand and supply dynamic model. STELLA software<sup>6</sup> is used to simulate the interaction between key variables of the system.

This goal is to be achieved through the following objectives and underlying tasks:

#### **Objective 1**

To document and describe the system of livestock grazing and water resources in Kgatleng District, Botswana as a basis for systems modelling by:

- Task 1

Review documents on livestock-water related issues in the country. Survey literature on cattle production and challenges faced by farmers with an emphasis on water-related issues.

- Task 2

Identify the key variables and components for the cattle water demand and supply system and their interrelationships. Feedback between the system's variables will

---

<sup>6</sup> STELLA is a system thinking software for modelling dynamic system systems. It is an object-oriented program software.

also be identified and discussed. This is the first and the most important task in the construction and development of a system dynamics model or any other model. Key variables that are currently identified as being important in the cattle water demand-supply system are: temperature, rainfall, groundwater, number of cattle, forage water content, and surface water.

## **Objective 2**

To develop a water demand-supply dynamics model for cattle in the Masama Ranch, Kgatleng District. This objective will be achieved by:

- Task 1

Distinguish between stock and flow variables from the identified set of key variables. In system dynamics modelling, variables are defined as either stocks or flows and this is important for the construction of the model. Stock variables are defined as variables that have a tendency to accumulate over time. Flow variables are those variables that change by adding to or deducting from a stock. Categorizing variables into stocks and flows is important for studying the connectedness of a system (Roberts *et al.*, 1983). In addition, feedback will be indicated in the diagrams.

- Task 2

Construct causal, stock and flow diagrams. This is one of the two steps in system dynamics modelling that will be discussed in subsequent paragraphs. This task generally involves trial and error to assist in developing the final system dynamics model. Causal, stock and flow diagrams are graphic representations of the connectedness among various key components of the system. According to Roberts *et al.* (1983) causal thinking is a vital step towards organizing ideas in system dynamics modelling.

- Task 3

Review available grass and pan evaporation models and select the most appropriate ones to incorporate in the cattle water demand-supply for the baseline. Both grass and pans are vital sources of water for livestock. This task will assist in task four.

- Task 4

Derive mathematical formulas of the relationship between variables. This task is basically translating the stock and flow diagram into mathematical language. This will enable the simulation of the interaction between key variables in a system using relevant software such as STELLA. Mathematical formulas are derived from data collected from the field.

### **Objective 3**

To implement the developed model in Masama Ranch and Khurutshe Area in Kgatleng District, Botswana. This will be achieved by the following tasks:

- Task 1

Collect baseline data for temperature and rainfall and perturb the model with these baseline data. Baseline climatic data are derived from the Botswana's Department of Meteorology. Other data required will be recharge rates and quantities of groundwater in the Khurutshe Area. Sources of data include: Ministry of Agriculture, Department of Water Affairs, Department of Meteorology, Department of Animal Health, and Department of Geological Surveys.

- Task 2

Run the model to simulate the interaction between key variables of the livestock system using data collected for the identified variables.

- Task 3

Validate the model by carrying out appropriate tests. There are various methods used to determine the validity of the model, such as whether results obtained from the model conform to expectation, whether the simulated outcome is as expected and consistent when some of the values of the key variables are changed. Roberts *et al.* (1983) point out that there are numerous tests that must be performed to evaluate a model's quality and validity. Of the various tests they point to the following: logical consistency, matching output against observed data collected over time and other statistical tests on the parameters used in the simulation models.

## **Objective 4**

To assess the impacts of climate change on cattle water demand-supply in Kgatleng District, a semi-arid environment of Botswana. This is to be achieved by the following:

- Task 1

Review of climate and climate change scenarios. Climate scenarios are defined by IPCC (2001) as coherent, internally consistent, and plausible descriptions of a future state of the world. Scenarios are at the core of impact and adaptation studies. There are different methods for generating scenarios as discussed in the IPCC (2001).

- Task 2

Review use of SimCLIM as a climate scenario generator and select its most appropriate application to generate future rainfall events for the Kgatleng District. Compute both temperature and rainfall scenarios for those selected. Review existing water balance models and select the appropriate model for the formation and frequency of pans during the rainy seasons.

- Task 3

Perturb the developed model with the computed climate scenarios to assess the impacts of climate change on cattle water demand and supply for selected years. In STELLA software, all the mathematical equations for key components of the system are systematically linked to each other. Therefore any change in the associated key variable will automatically affect other key components of the cattle water demand-supply system.

## **Thesis outline**

Chapters of the thesis excluding chapter 1 are briefly outlined as follows:

- Chapter 2: In this chapter I discuss evidence of a gap in knowledge on climate change and water demand, with particular attention to cattle water demand. In addition, developments made on modelling cattle water requirements are presented. The link between climate

variables (rainfall and temperature) and cattle water demand are shown.

- Chapter 3: In this chapter I discuss water resources in Botswana and in the Kgatleng District. In addition, groundwater resources and aquifer characteristics in Khurutshe area are extensively discussed. The link between cattle population and groundwater development is also discussed. Lastly, utilisation of groundwater in the Khurutshe area is highlighted.
- Chapter 4: In this chapter I discuss system dynamics models and the characteristics of a model. Dynamics of the system are discussed and the variables that result in system dynamics.
- Chapter 5: In this chapter I discuss climate scenarios, their construction and importance in impact assessment studies. Types of climate scenarios are described and associated uncertainty in climate change studies. Lastly, climate scenarios for the study area are constructed.
- Chapter 6: In this chapter I describe pan water which is a source of water supply during the rainy season. Quantity of pan water is estimated and a simple water balance model is described to estimate the dynamics of pan water. Rainfall-runoff relations are discussed.
- Chapter 7: In this chapter I look at forage water content as a source of involuntary water consumption by cattle. A model that estimates forage water content is describe, which includes available soil water, soil moisture and evapotranspiration. A simple water budget is also described.
- Chapter 8: In this chapter I describe cattle water demand and supply model development and validation. Mode of reference of behaviour of the system is described. Testing of the model is undertaken based



on structural, statistical and mode of reference behaviour. Sensitivity analysis is conducted.

- Chapter 9: In this chapter I describe implementation of the model using generated baseline and climate scenarios. Discussion is based on demand, supply and sustainability for Masama Ranch and the Khurutshe area.
- Chapter 10: In this chapter I summarise and conclude with the findings of this thesis. Implications of the results are summarised as are recommendations.

## Chapter 2 : Evidence of Gap in Knowledge on Climate Change and Cattle Water Demand

---

### Introduction

Considerable progress has been made in climate change projection science and in assessing climate change's potential impacts on a wide range of ecosystems. Water resources are one of those areas that have received considerable research attention. However, research on the effects of climate change on water supply and water demand has not been balanced. While the supply (river flow, rainfall-runoff, evapo-transpiration, recharge and hydrology) has received considerable scrutiny, the demand side has been neglected. Although water demand<sup>7</sup> has been referred to in climatic change studies, empirical evidence is lacking; little in-depth, analytical work has been carried out (IPCC, 1996, 1998 and 2001). In many cases, the influence of climate on water demand has only been speculative and may be based on the knowledge that water demand peaks during the hotter summer season. For instance Arnell (1998) and Frederick (1997) argue that climate change may lead to an increase in water demand and water use. Their arguments may be based on studies done on the impacts of drought and heat waves on water demand and also on the effect of seasonality on water demand particularly domestic water consumption. However, for a more complete understanding of the impacts of climate change on water resources, systematic research on how climate change influences water demand and water supply is required. The importance of integrating climate change in assessing future water resources and demand is acknowledged by the Comprehensive Assessment of Water Management in

---

<sup>7</sup> Water demand is an economic term and defined as the relationship between quantity of water purchased at a certain price. In the proposal, the terms: water demand, water use, water requirement and water consumption are used interchangeably even though they have different meanings.

Agriculture (2007). They argue that climate change will have strong implications for water and agriculture.

Cattle water demand is one of the water use and demand sectors that appears to have received less attention in climate change impact assessment studies. However, this is surprising as cattle water consumption has been widely researched and moreover, cattle water demand is highly influenced by environmental factors. Not only do these environmental factors affect cattle water demand but one of them (rainfall) also affects water supply, especially, in semi-arid environments. For instance, the Comprehensive Assessment of Water Management in Agriculture (2007) noted that climate change is causing major changes/shifts in precipitation. In turn, these environmental factors might be affected by climate change. Thus, though there is a strong link between climate change and cattle water demand it is surprising that less work has been done to assess the impacts of climate change.

### **Developments on cattle water demand over time and the gaps**

Cattle water demand is one area that has a long history of research (Bartholomew, 2004; FAO, 1985; Hoffman and Self, 1972; Parker *et al.*, 2000; Winchester and Morris, 1956). Most of the research on cattle water intake focused specifically on factors affecting daily water consumption for both beef and dairy cattle. Factors that have a strong influence are daily temperature, relative humidity, precipitation and wind speed. According to Parker *et al.*, (2000) these climatic or environmental factors have an influence on animal physiology which in turn affects water intake. Other factors influence daily water requirements are dry matter intake or percentage of moisture in the diet, dietary salts and state of the animal, such as age (Parker *et al.*, 2000). Of these factors, air temperature is viewed as the dominant factor. The water requirements needed for heat regulation vary markedly with air temperature (Parsons *et al.*, 2001; Smart, undated; Steinfeld *et al.*, 2006). With a rise in temperature, water requirements increase. According to Smart (undated) when temperatures exceed 27 °C, daily water intake for cattle can double.

Most models developed to estimate cattle water intake are regression equations based on climatic or environmental factors. For instance Parker *et al's.*, (2000) model is based on maximum daily temperature, minimum daily relative humidity and average daily barometric pressure. Winchester and Morris (1956) used temperature, body weight and the production stage of animals, while Hicks *et al.*, (1988) used temperature, dry matter intake, precipitation and dietary salts to develop a regression equation for daily water intake.

While progress has been made on modelling daily water intake for cattle over time, my literature review reveals that very few studies has been conducted on the effect of climate change on cattle water demand. In fact, only one study by Howden *et al.*, (1999) looked at the effect of climate change on cattle water demand. Most studies looked at the effect of climate change on cattle heat stress. The reason for this is not known. Probably, the best reason arises from the controversy surrounding climate change. The other speculative reason may be that the demand side of water resources has lacked research on the impacts of climate change. This bias against demand in favour of supply may stem from the belief that impacts of climate change on water resources will depend on the present conditions of the water supply (IPCC, 2001). Arnell (1998) supports this view by arguing that climate change has a physical effect on both water quantity and quality. While Golubev (1993) argues that climate and the global hydrological cycle are interrelated, such that they are different sides of one process of water exchange in the ecosphere. Other studies highlight the link and strong relationship between water resources on the supply side and climate (Strzepek *et al.*, 1998). This perception (that demand is not related to climate) may have led to researchers focusing on supply and the hydrology side of the water resources equation while neglecting the demand side. Thus, there is an obvious link of climate change on the supply side such that the less obvious link between demand and climate change is quickly dismissed and ignored. Lastly, the bias towards the impacts of climate change on the supply side may be influenced by the traditional supply-oriented perspective of water resource management. That is, before the emphasis on water demand management strategies, the focus was on building more dams and disregarding demand.

## Evidence of imbalances in climate change research

It is evident from the IPCC (2001) survey and other studies (Arnell, 1998; Golubev, 1993; Strzepek *et al.*, 1998) that there have been a great number of studies on the potential effects of climate change on hydrology. The reports further show that of those studies that looked at hydrology, a majority focused on water balance, specifically effects of climate change on precipitation, runoff, evaporation rates, recharge and stream flow. The survey further reveals that a small number of the studies looked at the impacts of those changes for water resources and still fewer explicitly considered possible adaptation strategies.

To show the extent of bias in water resources and climate change research, I surveyed 305 articles of the IPCC (2001) references on hydrology and water resources. Only 30 are demand related. Out of these, 14 are on impacts of climate change and irrigation, 13 are on management in the face of climate change and three are concerned with urban water use. None referred to rural water demand and supply. Out of 305 articles, 275 focused on runoff, hydrology, evaporation, glaciers and stream flow.

The IPCC review and other studies are mainly concerned with projections of the extreme weather component of water resources such as storms, floods, droughts, *El Nino*<sup>8</sup> and *La Nina*<sup>9</sup> phenomena, and hydrology.

Boland (1997), Doll (2002) and Kaczmarek *et al.* (1996) reach the same observations, that there is a substantial amount of literature on analysis of possible impacts of climate change on water supply, while impacts on water demand (such as irrigation, urban water demand, municipal) have been virtually ignored.

---

<sup>8</sup> *El Nino* occurs when warm waters from the western tropical Pacific migrate eastwards and trade winds weaken because the waters become warmer in the central and eastern Pacific, shifting the tropical rains East.

<sup>9</sup> *La Nina* is the opposite of *El Nino*.

## **The impacts of climate change on water resources**

In the following sections I review the literature on the impacts of climate change on water resources. It is divided into two sections: impacts on water supply and on demand.

### **Climate Change and Water Supply**

Climate change will affect the water sector by influencing factors that are paramount to water supply such as precipitation, evaporation and runoff (IPCC, 2001; 2007; Mukheibir and Sparks, 2003; UNEP, 2005). IPCC (2007:437) notes that “the water sector is strongly influenced by, and sensitive to change in climate (including periods of prolonged climate variability)”. These factors (precipitation, evaporation and runoff) are inextricably linked to climate. A change in climate will inevitably mean a change in these factors. The effect of climate change on rainfall, evaporation and runoff will vary from region to region.

There is a general agreement that climate change will lead to increased annual global precipitation. IPCC (1996) projects that with a 1.5 to 4.5 °C rise in global mean temperature there will be an increase in global mean precipitation of 3 to 15%. But regionally some areas will receive less annual precipitation while others will receive more (IPCC, 2001; 2007). For instance, it is envisaged that a reduction in rainfall as projected by General Circulation Models for the Sahel and Southern Africa could be fatal for the hydrological balance of the African continent (IPCC 1998; 2007). It is projected that overall there will be an increase in precipitation over the whole of Africa, with declines by 2050 of 10% in Southern Africa and the Horn of Africa. In the Sahel, expectations are that rainfall will increase by 15% above the 1961-90 baseline averages. Moreover, equatorial Africa could experience an increase of 5%. But at the same time (by 2050), evapo-transpiration is projected to increase by a range of 5 to 10%.

Besides the IPCC reports, there are numerous other studies that have looked at the impacts of climate change and water supply. Hulme (1996) looked at the effect of climate change on runoff and precipitation in Southern Africa. In his study, he used three scenarios: core, wet and dry, to assess the impacts of climate change on

runoff. For the majority of Southern Africa, runoff may decrease by as much as 20% under both dry and core scenarios, while there could be slight increases under the wet scenario. Therefore, his findings are comparable with those of the IPCC (1998, 2001). Mukheibir and Sparks (2003) noted that climate change will have substantial impacts on available runoff in southern Africa, while UNEP (2005) projects the following reductions on the supply side of water resources: reduction in rainfall by as much as 20% in parts of South Africa; evaporation will increase by 5 to 10%; leading to reduced runoff. Mukheibir and Sparks (2003) on the other hand noted that by 2015 there could be as much as a 10% reduction in runoff in South Africa and that recharge could be affected. The Millennium Ecosystem Assessment (2005) also acknowledges that climate change will affect all aspects of the ecosystem services, including water supply.

Schneider *et al.* (1990) argued that with a doubling of atmospheric CO<sub>2</sub> annual precipitation in any region will change by an order of  $\pm 20\%$ . However, they cautioned that regional runoff and soil moisture might range between  $\pm 50\%$ .

### **Link between climate change and water demand**

Even though research on the effects of climate change on water demand has not been carried out intensively, the link between water demand and climate change has been acknowledged in climate change and hydrology articles. For instance, IPCC (1998, 2001) note the importance of demand in determining the impacts of climate change on water resources: “the impacts of climate change will depend on the baseline condition of water supply and the ability of water resources managers to respond not only to climate change but also to population growth and changes in demands, technology, economic, social and legislation conditions” (IPCC, 1998:5). The IPCC emphasises population growth and economic growth as factors that will lead to an increase in water demand and ignore the likely effect of climate change. IPCC (2007) indicates that climate change will impose additional stress on water demand in Africa particularly southern African countries.

Boland (1997) argues that, though less frequently discussed and only referred to in climate studies, climate change will affect water demand as much as it affects

water supply. His view is that climate change will lead to increased demand for water and at the same time reduce water supply. Therefore according to him, climate change will widen the gap between water demand and water supply leading to water scarcity. It is anticipated that weather-sensitive uses such as lawn and garden irrigation and water for cooling requirements will be positively affected by climate change (Frederick, 1997; IPCC, 1998, 2001; Kaczmarek *et al.*, 1996; SASRD, 2000). It is concluded that climate change will lead to an increase in water demand. Thus, having anticipated the impacts of climate change on water demand, water planners and managers, especially those on the demand side, are increasingly calling for integrating climate change impacts into water demand management (Donkor and Wolde, undated).

Assessment models reveal that climate change will increase the number of countries classified as water-stressed and water scarce (Steinfeld *et al.*, 2006). For instance IPCC (2001) highlights that currently there are 19 countries in the Middle East and Southern Africa which are currently classified as either water-stressed or scarce and that the number may double, in large part, because of an increasing demand due to economic and population growth. If the effect of climate change on water demand can be integrated into the equation, the number of water-stress countries could increase as noted by Doll (2002). He found that if a country or regions get drier due to climate change, the decreased water availability will be worsened by an increase in demand that could be climate-induced. UNEP (2005) on the other hand projects that within the next 20 to 30 years, 25 African countries may experience water scarcity or water stress. Doll (2002) and SASRD (2000) remark that human induced climate change does not only affect water availability through runoff but also water demand.

### **Climate change and its impacts on water demand**

Though water demand has only been at the background of the debate on water resources and climate change since the mid 1990s, research in the area has expanded. However, emphasis has been placed mostly on urban and agriculture water demand especially irrigation, while research on other sectors such as industrial, rural and livestock water use have stalled.



## Urban water demand

Boland (1997) studied the impacts of climate on urban domestic demand. His studies show that by the year 2030, summer water use could increase by between 7% to 13%. Herrington (1996) also looked at the effect of changes in climate on water demand in England and Wales and his findings for a 1.1 °C increase in temperature are as follows:

- an increase of 12 per cent for showers
- 35 per cent for lawn sprinkling
- 19 per cent for other garden uses.

In the USA, Hughes *et al.*, (1994) also looked at the relationship between domestic water use and increases in temperature and evapotranspiration. Findings were similar to those found elsewhere, of a positive correlation between temperature and water demand. They concluded that an increase in temperature of 2.2 °C results in an increase in water use of 5% in the summer and 14% in winter.

From the few studies done on water demand and climate change/variability, it can be concluded that climate change has a positive effect on water use at the urban domestic level. Moreover, from the percentage changes cited by different studies, climate change has a significant impact on water consumption; therefore, policies should integrate climate change into water demand management and planning.

## Irrigation water demand and climate change

Compared to other sectors, agriculture, specifically irrigation has received more attention. Assessing the impacts of climate change on irrigation water demand is not easy. For instance, Allen *et al.* (1998) attempted to assess the effects and concluded that the effect of increased CO<sub>2</sub> and increased temperature cannot be quantified due to insufficient knowledge on the counteracting effects. This is because there are positive and negative feedbacks. Firstly, increased CO<sub>2</sub> concentration causes lower plant stomatal conductance, resulting in decreased

transpiration. The process leads to an increase in water use efficiency (WUE)<sup>10</sup> in plants. However, there can be a negative feedback experienced through increased plant growth. At higher concentrations of atmospheric CO<sub>2</sub>, plants will grow quickly as the photosynthetic rate increases and this will offset water use efficiency (Christensen *et al.*, 2004; Doll, 2002; IPCC, 2001; Rotter and Geijn, 1999). Christensen *et al.*, (2004) assessed the effects of doubling CO<sub>2</sub> (700 ppm) and found both the stomatal conductance and transpiration rates and photosynthesis were reduced and increased by 20%, respectively, for herbaceous plants. Thus, depending on which force is stronger and the plant species, climate change can lead to increased, decreased or no change in irrigation water demand.

But there are some authors who provide conclusive results. Herrington (1996) looked at how climate change would affect water demand for irrigation in England and Wales. Findings are that a 1.1 °C rise in temperature would lead to a 12% and 4% increase for agriculture and golf courses, respectively. However, Herrington (1996) only looked at temperature and did not take into account CO<sub>2</sub> concentrations. Doll (2002) also analyzed the implication of human induced climate change on irrigation requirements. Findings are that overall irrigation water requirements will be affected by climate change. Using 2020 as the projection year, Doll (2002) concludes that irrigation requirements would increase in most irrigated areas north of 40° N by up to 30%.

Rotter and Geijn (1999: 657) looked at the effect of climate change on plant growth. Their findings on the impacts of climate change on water requirements for irrigation were at odds. Their argument was that “water consumption on a ground-area basis might be less affected”. While Hatch *et al.*<sup>11</sup>. (1999) concluded that with a combination of the following, an overall increased rainfall annually, water use efficiency due to CO<sub>2</sub> enrichment, and shorter growing seasons, climate change will lead to a reduction in the demand for irrigation by a factor between 1 and 20% in 2030 for different crops.

---

<sup>10</sup> WUE is defined as the ratio between carbon gain through photosynthesis and water loss through transpiration (Hulme, 1996).

<sup>11</sup> The authors used climate change scenario derived from HadCM2 which produce increased rainfall for most seasons (IPCC, 2001).

## Livestock water demand and climate change

From the literature that I surveyed only one study assessed the effects of climate change impacts on livestock water demand. Howden *et al.*, (1999) assessed the impacts of climate change on heat stress on Australian beef cattle and concluded that between 1957 and 1996 heat stressed increased by 40% and that by 2050, the heat stress is estimated to increase by 138% because of climate change. In addition, he argues that climate change will increase water consumption for Australian beef cattle. Mostly, studies focused on the effect of climate change on heat stress on cattle (Howden, *et al.*, 1999; Jones and Hennessy, 2000). It is therefore concluded that increased heat stress is an indication that water requirements will increase leading to overgrazing near water points.

Therefore, knowledge on climate change and livestock water requirements is still lacking. These sentiments are shared by IPCC (2001:238) that “the ability of livestock producers to adapt their herds to the physiological stress of climate change is not known”.

IPCC (2001) looked at climate change, its potential effects on grass production and rangeland ecosystems. There are other studies that have looked at climate change and livestock production (Christensen *et al.*, 2004; Howden *et al.*, 1999; Jones and Hennessy, 2000; Rotter and Geijn, 1999). IPCC (1998, 2001) simulation studies show that with doubling CO<sub>2</sub>, grass production will increase by 20 to 30%. Rotter and Geijn (1999) did an assessment of the impacts of climate change on livestock growth. Their conclusion is that climate change can affect livestock in the following manner:

- The impacts of changes in livestock feed grain available and price;
- Impacts on livestock pastures and forage crop production and quality;
- The direct effects of weather and extreme events on animal health, growth and reproduction; and,
- Changes in the distribution of livestock diseases and pests.

Though there are few studies done on livestock water requirement and climate change. It is clear from the link between air temperature, other environmental factors and water requirement that climate change may significantly affect cattle demand for water. This is also noted by Calow *et al.*, (2002) that in semi-arid environments water demand peaks during the summer periods leading to local depletion of groundwater. Impacts of climate change on water demand may manifest in two ways: Firstly, an increase in temperature might lead to an increase in demand for water, as is evident from regression equations developed over time (Hicks *et al.*, 1988; Parker *et al.*, 2000; Smart, undated; Winchester and Morris, 1956). Secondly, climate change may lead to increased incidents of drought leading to dryness of forage and thus a decline in forage water content, this might affect water intake. The implication of this is that farmers might have to supply more water for their livestock relative to the baseline climate condition. Therefore climate change could lead to increased pressure on the existing water supply.

### **Rational for assessing the impacts of climate change on cattle water demand**

The rational for assessing the impacts of climate change on cattle water demand is divided into four intertwined reasons: the link between environmental factors and cattle water intake; the cattle sector as the major use of water in semi-arid environments of Africa; semi-arid environments of Africa occupying a large proportion of land and supporting a large proportion of the rural population; and lastly, the link between groundwater sustainability, the cattle sector and rural livelihood sustainability. As revealed in the literature review, there is a strong link between environmental factors and cattle water demand. Thus, as climate change might lead to increases in environmental factors that influence cattle daily intake (mainly daily temperature), it is crucial that an assessment is made on how cattle water demand might be impacted by these changes. Linked to this argument is the fact that in semi-arid environments, livestock is the major water user (Calow *et al.*, 2002). For instance, in Botswana, it accounts for more than 40% of all water use. It is also the case in other semi-arid environment such as Texas in the USA (Parker *et al.*, 2000). Currently, there is a concern on the use of water, particularly groundwater, by the livestock sector in semi-arid environments with emphasis on

conservation (Parker *et al.*, 2000). In most of the semi-arid environments of Africa, the effects of changing seasons on water resources are local depletion of groundwater in summer when the demand for water by cattle peaks (Calow *et al.*, 2002). This is an indication that climate change might have an effect on cattle water demand in future. Thus, there is a need to assess the impacts of climate change on cattle water demand and overall water resources. It is imperative that we know how climate change might affect demand and abstraction and how that might impact sustainability either at a large or local scale. This argument is supported by the Comprehensive Assessment of Water Management in Agriculture (2007) and the Millennium Ecosystem Assessment (2005) that strongly argue that climate change will affect society and the environment with serious implications for water and agriculture. Therefore it is suggested that the projected impacts of climate change on water resources needs to be incorporated into project planning. Therefore the impact of climate change can only be incorporated if it is known and assessed, which is the rationale for this study.

Semi-arid environments occupy over 40% of the earth surface and approximately 38% of the earth's population lives in these semi-arid environments (Blij *et al.*, 2007; IUCN, undated). In Africa, it is estimated that 34% of the population resides in arid environments (Findley, 1996). In most cases, the rural livelihoods are reliant on the livestock sector which is dependent on groundwater resources. Thus, there is a need for the assessment of the impacts of climate change on cattle water demand and supply and its sustainability. With so many people lives' at stake it is vital that the effect of climate change on cattle water demand and supply are assessed and adaptation strategies implemented. Climate change is not the only factor that will affect cattle water demand and supply and overall water resources. The dynamics (particularly increases) of both human and cattle population will affect water resources of the world. IPCC (2000) noted that increases in population and standards of living may increase world water demands. In addition, increases in standards of living may also affect the demand for beef that might spur an increase in the rearing of livestock. Thus, it is important to assess the impacts of climate change on cattle water demand and supply and indicate their likely contribution to projected future increases as a result of population growth.

## Summary

This chapter has reviewed some of the developments made towards modelling daily cattle water intake and factors affecting cattle water intake. In addition, this chapter has also revealed the imbalances in research, particularly towards water demand and the impacts of climate change. Models based on environmental factors have been developed to estimate livestock daily water intake. In this chapter I have established that even though environmental factors are known to influence water demand, few studies have included climate change in work already done on regression models for livestock daily water intake. This is particularly worrisome in semi-arid environments where livestock is the major use of water resources, especially groundwater, and with the knowledge that climate change might affect water supply e.g., groundwater recharge in semi-arid environments. Studies indicate that local depletion of groundwater in semi-arid environments occurs mostly during the summer months when the demand for water peaks. This therefore calls for an investigation of the impacts of climate change on cattle water demand and supply and thus forms the rationale for this study.

In the next chapter I discuss water resources in Botswana with particular attention to the Kgatleng District and the problems faced by farmers in the District.

## Chapter 3 : Water Resources and Challenges in Botswana and the Kgatleng District

---

### Introduction

Botswana is a semi-arid country with highly erratic annual precipitation and high evaporation rates. These factors combined with high demand for water results in water scarcity, particularly surface water. Thus, sectors such as livestock, irrigation and rural water supply are dependent on groundwater resources. This makes groundwater a vital and strategic resource. The advantages of groundwater have been noted elsewhere (Todd, 1980; Tuinhof *et al.*, 2003) particularly for semi-arid and arid environments. However rainfall-runoff water collected in pans forms an important component and can affect groundwater abstraction rates in both the sand and the hard veldts of the country. During the rainy season it has been observed that livestock and wildlife frequent pans and use them for drinking, especially in the Kalahari and the Makgadikgadi salt pans. In addition, it has been noted that cattle generally wander from their boreholes in excess of 30 km to drink from the pans. Therefore, the importance of pans in relieving pressure from the groundwater resource cannot be underestimated.

The role pans play as an alternative and temporary source of water for livestock has prompted the government to construct and rehabilitate pans to capture rain water for longer periods of time. Availability of surface water in pans has a bearing on decision-making regarding abstraction of groundwater for livestock production. Though pans play an important role and enhance groundwater sustainability by reducing pressure for groundwater abstraction for the livestock sector, their utilisation has never been maximised. A hindrance to maximum and efficient use of pans is the issue of their public good nature and the associated problems of free riding and tragedy of the commons, as noted by farmers in the

Kgatleng District during interviews. This is a common problem associated with communal resources (CSO, 2000). However, there are cases in Africa where communal resources are used sustainably (Makhaya, 2002). Some of the factors that enhance efficient utilisation of these communal resources are strong socio-cultural regulation. Makhaya (2002) highlight some of the factors that ensure sustainable utilisation of communal resources as follows:

- group membership is known;
- outsiders are excluded;
- development and enforcement of rules and regulation governing utilisation; and,
- implementation of incentives for group members to adhere to rules and regulations.

With an ever increasing demand for water in the country and less exploitable water resources, pans will play a more important role as an alternative source of surface water. Thus in the future, the conjunctive use between pans and groundwater may increase substantially as competition for scarce water resources intensifies. However, the impacts of climate change on pans as sources of surface water for cattle water consumption may undermine the importance of the water sources and the conjunctive use between pans and groundwater.

## **Background of the Country**

Botswana is a land-locked country sharing its border with South Africa, Namibia, Zambia and Zimbabwe. It covers approximately 580 000 km<sup>2</sup>. For the last decade, the country has experienced one of the fastest growing economies in the developing world coupled with one of the highest incomes per capita. Diamond mining is the major source of government revenue and gross domestic product (GDP) contributing well over 80% of the country's GDP. However, before the country's independence from Britain in 1966, the agriculture (with the cattle sector contributing over 75% of value added to the agricultural sector) was the predominant source of GDP contributing more than 60% until the late 1980s when its contribution declined dismally to below 4% (African Development Bank, 1995; McDonald, 2000). Though the sector's importance at the national level has



been desiccated over the years, it is still an important sector at the micro-level particularly to rural<sup>12</sup> communities. Studies indicate that it is the major source of income for rural households (McDonald, 2000; MOA, 1991). As far as employment is concerned, it accounts for 30.9% of the national labour force (Mmegi, 2006). Cattle rearing is undertaken for various reasons (CSO, 2000):

- as a ‘bank’ and for payment of school fees and dowry (token of appreciation for weddings);
- as a form of draught power, however, this is declining as a majority of farmers are now using tractors and on rare occasions donkeys. In addition, the number of households who still plough their fields has declined due to reduced rainfall and changes in rainfall patterns;
- as a sign of prestige and social security;
- for slaughter at weddings and other ceremonial activities; and,
- for commercial purposes, this is generally for livestock reared on ranches.

Botswana’s livestock sector is divided into two main systems: the traditional and commercial. The former system accounts for 97% of the cattle population in the country. A traditional system is practiced on tribal land also known as communal land and the commercial system on leased land and freehold ranches. Compared to the traditional sector, the commercial system includes more intensive production systems such as feedlots. In addition, the commercial sector is productive as offtake rates for the commercial and traditional are 17% and 8% respectively. The traditional sector on the other hand is exclusively free range with low supplementary feeding.

There are three forms of land tenure in Botswana: tribal/communal, State and freehold. Tribal land comprises approximately 70% of Botswana. This land is generally a public good, as it belongs to every citizen of Botswana and no one can be excluded from its utilisation, particularly cattle rearing. State land constitutes 23% of land in the country and belongs to the government. Land uses in the state land are national parks; game reserves; wildlife management area; forests reserves

---

<sup>12</sup> Approximately 45.8% of the total population in Botswana lives in rural settlements (CSO, 2004). There are three types of settlements in Botswana: cities and towns; urban villages and rural settlements. An urban settlement is defined by a minimum threshold population of 5000 residents with at least 75 percent of its economically active population engaged in non-agricultural activities (CSO, 2004). Thus a rural settlement is a settlement which does not meet these conditions.

and mining towns. Lastly, there is freehold which constitute 7%. This is leased and belongs to individuals, the majority of them being the white settlers from Britain who acquired it before independence. Land use in freehold areas is predominantly ranches for either wild game or livestock production.

Land uses in the communal land are rangelands, settlements and pastoral activities, especially fields for cultivation. Cultivation of fields is rainfed and therefore carried out during the rainy season. Thus during the winter and post-rainy season they are used for livestock grazing. More than 80% of the communal lands are rangeland, thus livestock rearing is the main economic activity (Harvey and Lewis, 1990). The abundance of rangelands has permitted the exponential growth of livestock numbers. For instance, in 1952 the cattle number stood at 1 million but reached over 3 million by 1980 (Harvey and Lewis 1990). However, there also has been some decline due to outbreaks of diseases such as the cattle lung disease in the North West District and foot and mouth disease. In these cases, where there has been an outbreak of contagious diseases the government kills all the cattle in the affected area to protect the European Union preferential beef markets. In addition to the abundance of rangelands, an observation by McDonald (2000) is that the periodic and severe droughts in the country makes livestock rearing an attractive option compared to arable farming where crops are vulnerable to drought. Figure 3.1 depicts trends in cattle population for the whole country from 1915 to 1998.

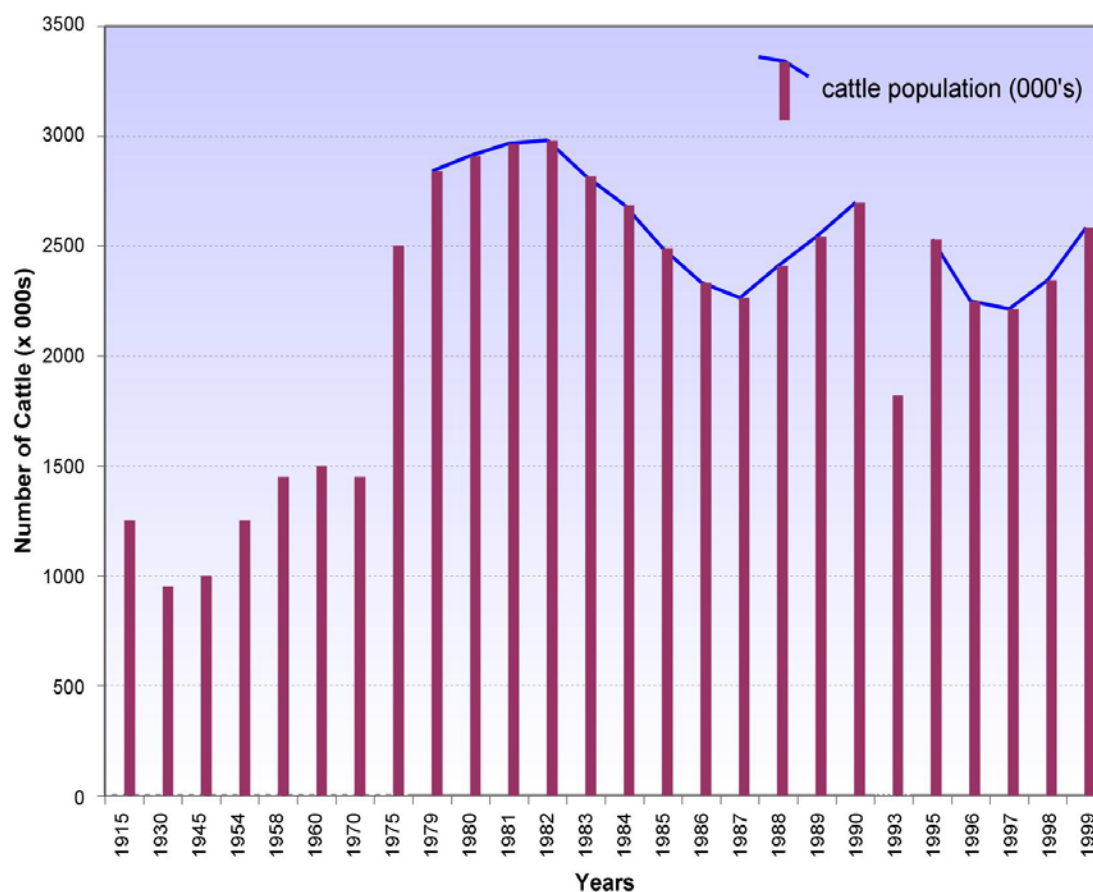

**Figure 3.1: Trends in cattle population between 1915-1999**

Source: CSO (2000).

Other factors besides abundance of rangeland that actually played major roles in exponential cattle number growth include:

- government subsidies, both direct and indirect, and a favorable tax system (Harvey and Lewis, 1990);
- access to EU preferential markets and the Loma Convention which set the market price for beef 20 to 50% above the world beef price (Fidzane, 1998);
- eradication of the tsetse fly in the North West District; and,
- borehole technology permitting access to previously untapped groundwater, this being the most important and relevant aspect for this study.

These incentives made the beef industry an attractive investment area for most of Batswana, particularly top government officials. Of these factors, the initial and fundamental contributing factor to phenomenal growth in cattle numbers is

borehole technology. The technology resulted in accessibility to groundwater to support larger herd sizes. “Long-term growth of the national herd was related in part to investment in water resources, particularly in boreholes, which spread the potential range land further west into Kgalagadi sand veldt areas” (Harvey and Lewis, 1990:73). The same sentiments are shared by Duraiappah and Perkins (1999) who argue that deep borehole drilling technology and good rain years of the 1970s contributed to livestock growth as it was now possible to keep livestock permanently in the Kgalagadi pastures. It is reasonable to assume that before borehole technology, livestock was kept in Kgalagadi, but as farmers used shallow hand dug wells it meant that farmers only kept low number which could have been watered through manual labour. The major impact of borehole drilling technology on the livestock industry is also acknowledged by the FAO. The FAO (1991) point out that natural water supplies such as ponds during the rainy season and permanent lakes and rivers are sources of water for extensive migratory livestock production. But when the livestock numbers increase, artificial water facilities have to be provided. With borehole technology, livestock expanded to other areas that have no permanent surface water. Abundant water supplies meant that the national herd could be increased. Though the livestock sector is totally dependent on groundwater, pressure on this vital resource is relieved during rainy periods as cattle drink from pans which collect rainwater. According to Burgess (2003), in winter when it is cool and during the summer rainy season cattle wander up to 30 km from their boreholes. During these periods cattle drink from pans and ponds. In addition, melons and tubers provide moisture as a source of their water intake.

### **Problems of increased livestock in Botswana**

The phenomenal increase in the livestock numbers due to the highlighted factors has been accompanied by environmental problems. Firstly, growth on livestock numbers has been at the expense of wildlife (Duraiappah and Perkins, 1999). It has been observed that species such as wildebeest (grazers) and other large browsers have declined as livestock encroach their habitat especially in the Kalahari District where livestock were hitherto not reared. The multiplicative impacts of grazers replacing browsers have been vegetation succession from grassland to bush and



- Spring/Pre-rainy seasons      September-October
- Rainy/Summer                      November-March
- Autumn/Post-rainy season      April

## **Precipitation**

Factors affecting the timing of rainfall in the country include (Bhalotra, 1984; 1987; DSM, 2002):

- extratropical waves and troughs in the middle and upper westerly airstream;
- tropical systems, Inter Tropical Convergence Zone (hereafter ITCZ) and the associated troughs and lows, and cyclones of the South-west Indian ocean;
- Tropical storms in the Mozambique channel;
- Southeastward movement and intensification of the seasonal low over Namibia/Angola; and
- Zaire/Congo air boundary and its oscillations.

According to Bhalotra (1984) tropical storms are generally associated with reduced rainfall in the country. This is because they induce a deep southeasterly flow of drier and subsident air. Botswana experiences convectional rainfall, from the warming process. As summer is the hottest season relative to other seasons in the country, heavy rainfall is experienced during this period. Winter rains also occur, but account for only 1% to 10% of annual rainfall depending on its location within the country (Bhalotra, 1987; DSM, 2002). Rainfall events in the country are highly variable between months and locations. This is due to the effect of the tropical systems and the marked inter-annual variation of the surface position of the ITCZ which supplies moisture (Bhalotra, 1987). The mean annual rainfall in the country ranges from over 650mm in the extreme northeastern area of Chobe District to below 25mm in the southwestern parts of the Kgalagadi District. Kgatleng District generally receives annual rainfall of about 450 mm.

The Masama Ranch is located close to the Tropic of Capricorn and is under the influence of both the inter tropical air masses and the southern polar oceanic air masses (BRGM, 1993). Average annual rainfall recorded for a period of 30 years for the Khurutshe area is 377 mm.

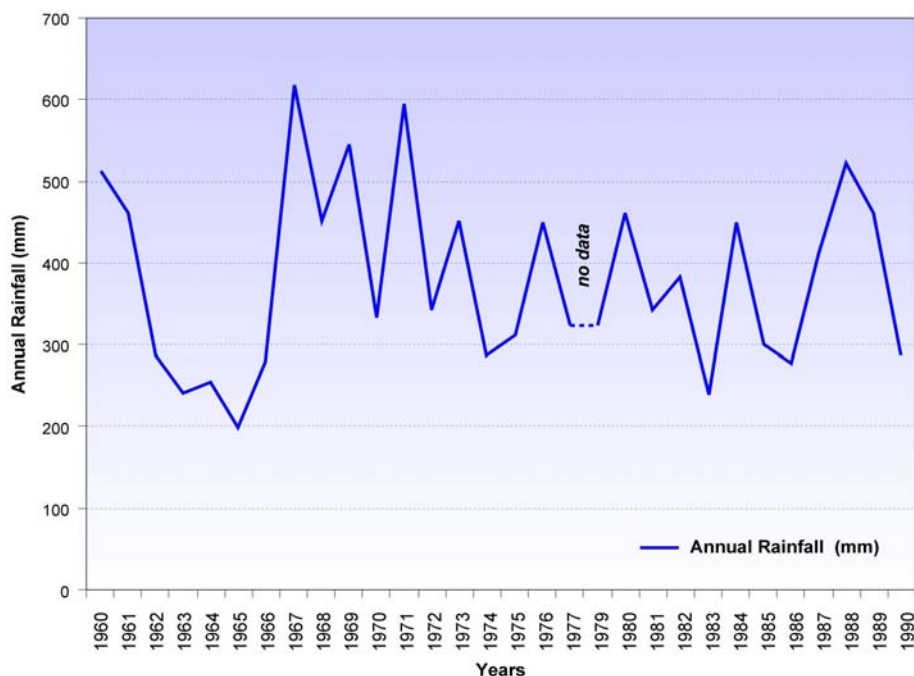

**Figure 3.2: Annual precipitation for Khurutshe (1960-1990).**

One of the most prominent features of weather in Botswana is drought and they are recurrent. According to Bhalotra (1987) this is not unusual as countries located at the edges of the sub-tropical high pressure belt experience recurrent drought. Drought and its return are discussed and computed under climate scenarios.

## Temperature

Temperatures in the country are less variable compared to rainfall but still variable between seasons especially winter and summer. Summer temperatures are extremely high compared to the winter temperatures. Temperatures of below zero are occasionally recorded in winter. Maximum summer temperature can reach as high as 40 °C particularly during drought years. In chapter five I discuss baseline data for temperature for the study area and also present figures.

## Water rights, policies and Country Acts governing use of water

Generally, water policy and Acts in the country were established specifically for groundwater utilisation and monitoring. In addition, one could argue that the water policy and Acts were put in place for the livestock sector as the domestic and industrial sectors get their supply from the Department of Water Affairs (hereafter DWA) and Water Utilities Corporation (hereafter WUC). The government of Botswana, under the Ministry of Minerals and Water Affairs, holds both surface and groundwater rights in the country. In towns, the government has vested the rights to the (WUC), which is responsible for supplying and distributing water to consumers. While in the villages, DWA, a governmental department under the Ministry of Mineral Resources and Water Affairs is responsible for supplying reliable water to the rural sectors with assistance from the Ministry of Local Government, Land and Housing. In addition, the DWA, in partnership with the Department of Geological Survey, is responsible for monitoring groundwater quality. Though, monitoring of abstraction is not undertaken, the DWA also is responsible for monitoring groundwater quantity. There are various monitoring boreholes particularly on developed wellfields to monitor water tables.

The Borehole Act governs groundwater extraction in the country, though its enforcement is weak and lacks monitoring. The Act provides for drilling or increasing the depth of existing boreholes beyond 15 m and only permits the drilling of boreholes at a distance of 8 km from the nearest borehole (Snowy Mountain Engineering Corporation (hereafter (SMEC, 1991)). This is also the radius of an average Tribal Grazing Land Policy (hereafter TGLP)<sup>13</sup> ranch in the country. According to SMEC (1991) the 8 km rule is not applied because of the scarcity of groundwater but to avoid crowding of the cattle posts and therefore to ease overgrazing. The procedure for borehole drilling is that either a farmer or

---

<sup>13</sup> TGLP is a policy introduced in the 1980s with the aim of combating the prevalent problems of tragedy of the commons and free-ride problems in the communal lands. Farmers with large herds of cattle were moved to demarcated ranches to avert over-stocking and over-grazing in the communal lands. However, the policy was not a success as those farmers who have been moved still possessed dual-rights to both the communal lands and their ranches. Their tendency is to over-graze their ranches and move to communal lands so as to then rest their ranches (MOA, 1984).



syndicate of farmers identifies an unoccupied pasture, supposedly, 8 km from an existing borehole. Then the farmer or syndicate submits an application to the Landboards for drilling a borehole. Once the farmer or syndicate has drilled a borehole, they automatically have water rights which give them grazing rights on a radius of 8 km around the borehole. Water extraction is not limited and the Act does not control water extraction from any borehole. However, where an individual or a syndicate has applied for water development grants and subsidies, they are bound to a certain limit of cattle, though monitoring is lax (SMEC, 1991). The Water Act, which does not limit quantity extraction, has resulted in excessive extraction of groundwater and also indirectly encouraged farmers to keep large herds of livestock.

### **Water resources and demand pattern in the country**

Botswana is one of the countries in the southern Africa region and indeed in Africa which has water scarcity. The country has experienced acute water scarcity, such as in the 1980s. The year 2004/05 had below average rainfall and water restrictions were imposed regarding watering lawns and gardens, and car washing. Obviously, water scarcity is a combination of different socio-economic and physical factors. Aridity and factors that affect demand are responsible for water scarcity. In addition, locations of water points and population distribution have an influence (Oageng, 1999). For instance, in Botswana the population is distributed on the eastern part of the country, along the railway line, while abundant water resources are located at the northwestern part of the country where there is low population density. There are two large rivers in the country: the Okavango and Zambezi. They account for over 95% of the country's 705 Mm<sup>3</sup> surface water (SMEC, 1991). However, these rivers are shared with other southern African countries. Even if these rivers were in proximity to the major water demand centres, they would not probably be used as their use is not trivial. This is because they are shared with other countries and therefore any use of them is subject to international agreements. Population distribution and location of resources results in water scarcity in the eastern part of the country.

As elsewhere, there are two sources of water for different uses in the country: mainly surface and groundwater. Rivers and dams provide surface water. Dam supply is the most prevalent source of surface water in the eastern part of the country (Arup, 1991; SMEC, 1991). There are six dams, supplying the urban settlements and adjacent villages. Poor soil drainage<sup>14</sup> and lack of suitable sites in the country have restricted dam construction to the eastern portion. Moreover, the flat terrain that dominates the country has constrained dam construction (SMEC, 1991). In addition, pans are also a source of surface water for both animals (wild and livestock) and rural settlements, especially those settlements that have no water reticulation.

While surface water provided by dams accounts for a majority of water consumed in the urban settlements, rural settlements and agricultural activities particularly the livestock sector are totally dependent on groundwater. In fact, groundwater is the major source of water supply countrywide. It accounts for over 65% of total water consumed (Arntzen *et al.*, 2000; SMEC, 1991). While Arntzen *et al.*, (2003) argue that the government of Botswana has reduced dependence on groundwater from 65% in 1992 to 56% in 2001. Total available groundwater is estimated at between 100 billion and 380 billion m<sup>3</sup> (African Development Bank, 1995; DSM, 2002; SMEC, 1991). Its extraction is mainly through the drilling of boreholes and pumping into storage tanks by diesel powered engines, either for domestic, commercial or livestock consumption.

Water demand in the country is spatially imbalanced (Oageng, 1999). Obviously, water demand is high on the eastern part of the country where there are more economic activities and a greater concentration of population. According to SMEC (1991) water demand is high in the eastern part of the country where surface and groundwater may not cope with future water requirements. The comment by SMEC (1991) arises from the fact that over the years there has been an exponential growth in water demand, particularly in the eastern part of the country. This phenomenal growth in water demand has put pressure on already

---

<sup>14</sup> About two thirds of the country is covered with kalahari sand veldt (DSM, 2002). The thick sands of the Kgalagadi deserts cover the sand veldt. All the rain water is quickly absorbed by these soils. Only one third are in the hard veldt where the dams are constructed.

scarce water resources. The following factors have been responsible for the rapid increase in water demand in the country:

- rapid economic growth as a result of the discovery of diamonds leading to a boom in the construction sector;
- increases in population of both people and livestock;
- increases in per capita income as a result of the discovery of diamonds in 1967 which resulted in increased per capita water consumption; and
- borehole drilling technology which has resulted in opening up of the Kalahari sand veldt which was previously not used for livestock (Arup, 1991; SMEC, 1991).

Water uses in the country can be categorized into five sectors: settlements also frequently referred to as the domestic sector; mining and energy; agricultural (livestock; irrigation and forestry); and wildlife. In 1990, the livestock sector was the major consumer abstracting over 35.3 million cubic meters, over 40% of total water consumption in the country followed closely by settlements with 33.8 Mm<sup>3</sup> per year (Kgathi, 1998; SMEC, 1991). Though studies indicate that agriculture consumption is closely followed by settlements, the gap between the two sectors may be wider than indicated. This is because farmers in the proximity of Gaborone and other major villages such as Mochudi in the Kgatleng District and throughout the country, water their animals from their yard connection and public stand pipes meant for domestic consumption. Discussions with farmers during data collection in Kgatleng District and Tlokweneng village indicated that most small farmers in the radius of 20 km from Mochudi and Gaborone, water their livestock (mainly small stock and calves) from their yard connection. In addition, all households through the country who rear livestock in their homestead and not at cattle posts, water their livestock with water meant for domestic consumption. The rampant use of water for livestock consumption especially from the public stand pipes prompted councils in the country to introduce some excludability measures by introducing electronic cards for those households which cannot afford to have yard/private connection<sup>15</sup>. Thus when calculating domestic water use, it is just assumed that water drawn from the house connections and public

---

<sup>15</sup> Discussion with Kgatleng District Council Water Department personnal on water demand and use in Kgatleng District.

standpipes have been used for domestic consumption while it has been drawn for livestock consumption. Thus, this underestimated the consumption by the livestock sector.

SMEC (1991) did a detailed study for water demand and projected future demands. Figure 3.3 shows projections of water demand using medium scenarios between 1990, 2000 and 2020.

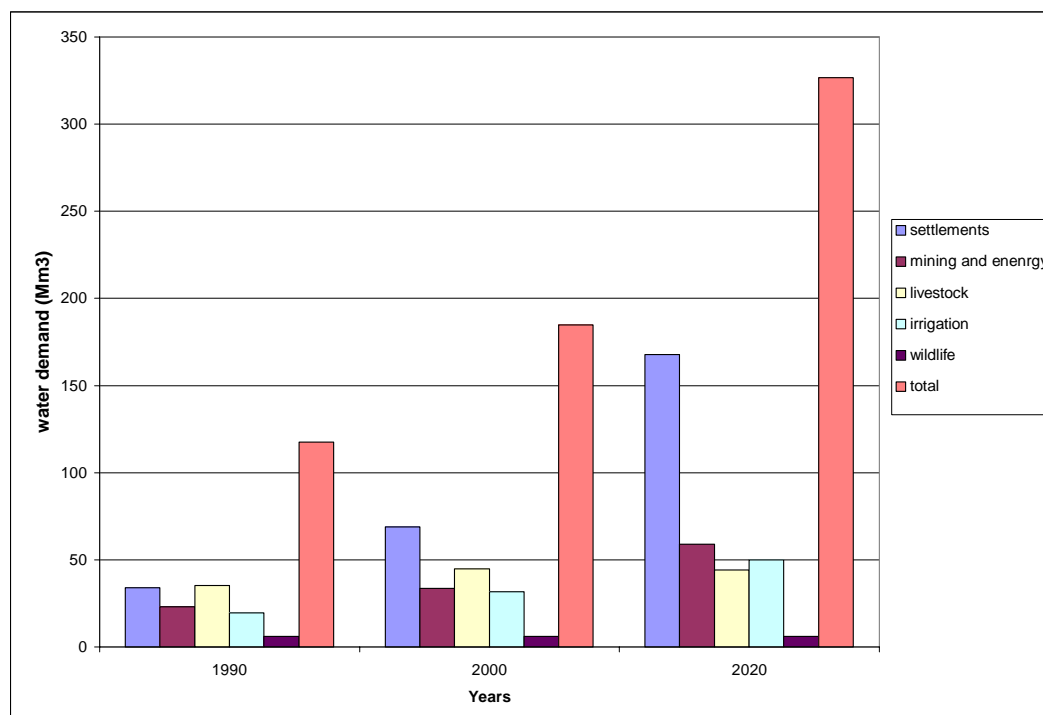

**Figure 3.3: Water demand and projections for all sectors in the country.**

Source: SMEC (1991).

## Groundwater occurrence, aquifers and their properties

Groundwater occurs in various geologic formations, aquifers being the most important (Todd, 1980). An aquifer is defined as “a formation that contains sufficient saturated permeable materials to yield significant quantities of water to wells and springs” (Todd, 1980: 25). It is noted that generally aquifers are areally extensive and can be overlain and underlain by confining beds (SMEC, 1991; Todd, 1980). The two most important aquifer properties are transmissivity and storativity as they describe the aquifer’s ability to transmit and store water (GCS,

1999). Transmissivity defines the ability of an aquifer to transfer water between the pores (Todd, 1980). It is defined as the product of conductivity and aquifer thickness. Storativity on the other hand is defined as the amount of water being released from or taken into storage per unit surface area of the aquifer per unit decline or rise of head (SMEC, 1991). It is argued that most of the aquifers in Botswana have low transmissivities. Aquifers in the country are categorised into four groups (DWA, 1994; GCS, 1999; SMEC, 1991):

- fractured porous dual porosity systems whereby water is released from a porous matrix via a series of transmissive interconnected fractures;
- fractured, these are aquifers whose matrix has limited porosity due to the rock's solid structures or to subsequent metamorphic changes. It is the fractures, joints and the weathering process that provide the storage and transmissive properties of the aquifer;
- porous, these aquifers that store and transmit water through the interstitial pore space in the sedimentary formation; and,
- karstic fractured – location of these aquifers is in the carbonate rocks, weathering by solution along joint fractures, and bedding has enhanced the water-bearing capabilities of the rock over the years.

Amongst the four types of aquifers occurring in the country, the fractured porous which are represented by the Karoo sandstones are the most prevalent at 37% (Wellfield Consulting Services, 1996). Fractured porous are closely followed by porous aquifers which are represented by alluvial and Kalahari bed aquifers at 35%, fractured aquifer 27% and lastly karstified fractured aquifers (SMEC, 1991). Of these four types of aquifers, the fractured porous represented by the Karoo and karstified represented by the Transvaal dolomite aquifers have the highest transmissivities (SMEC, 1991). The aquifers in the country occur in combinations of confined, unconfined and semi-confined (Wellfield Consulting Service, 1996). According to SMEC (1991) this combination of confined, unconfined aquifers has an influence on storativity.

Though it is estimated that groundwater occurring in aquifers is substantial in Botswana, there are certain aspects that hinder their development (CSO, 2000; SMEC, 1991):

- Siting of boreholes is difficult and expensive;
- Majority of the aquifers in the country have low storage capacities;
- Recharge of the aquifers is generally low due to low rainfall and extremely high evapotranspiration; and,
- Prevalence of saline water in the southwestern and western parts of the country.

In the Kgatleng District, aquifers occur in combinations of either confined and unconfined or water tables (Wellfield Consulting Service, 1996). Unconfined aquifers are represented by the Karoo sandstones and the shallow alluvial deposits which are related to the rivers. Some of the aquifers such as the Karoo are confined and are recharged from the unconfined aquifers (SMEC, 1991).

### **The Geological and Hydrogeological description of the Khurutshe Aquifer**

Masama Ranch within the study area where data gathering was undertaken, is situated on one of the most important and strategic aquifers in the eastern part of the country. The area is locally known as the Khurutshe area. The Khurutshe area is a fault bounded block around Masama (AquaTech, 1988; BRGM, 1993). It is enclosed within the Khurutshe Fault Zone, the faulted Ntane Sandstone Formation/Ramasselwana volcanic formation contact, the Boleleme Fault and the limit of Karoo subcrop. It is estimated that Khurutshe covers approximately 2,270 km<sup>2</sup> (BRGM, 1993). The Khurutshe area has rock types in the Karoo Supergroup which are favourable for groundwater occurrence and development (AquaTech, 1988; SMEC, 1991).

## The Geology of the Khurutshe Area

The geology of the study area Khurutshe, is well discussed and outlined by GCS (1999); and AquaTech (1988). The Khurutshe area “has a complex structure but the dominant feature is the large Khurutshe Fault Zone which is probably active at the present time” (AquaTech, 1988:10-2). The Khurutshe falls within the Central Kalahari Karoo Basin (GCS, 1999). The lithostratigraphy and geological composition of the Khurutshe area are well discussed and covered by AquaTech (1988); BRGM (1993) and GSC (1999). Figure 3.4 shows groundwater resources in the Khurutshe area. Two supergroups in the Khurutshe area have been identified by BRGM (1993) and GSC (1999) as the Karoo and the Waterberg supergroups. These two supergroups consist of numerous groups. From the Karoo supergroup, there are two groups: the Stormberg Lava and the Lebung which form the Kalahari beds, Ramoselwana Volcanics, Ntane sandstone and Mosolotsane formations, respectively (BRGM, 1993). The lithological description of the Ramoselwana Volcanics formation is crystalline, massive amygdaloidal basalt (BRGM, 1993). While the Ntane Sandstone formation is Aeolian sandstone, medium fine grained with minor mudstone intercalations and partially fluvial towards the base (BRGM, 1993). The thickness of the Ntane Sandstones is estimated on the range of 90 to 134 metres below the basalts (BRGM, 1993). Thus, the Ntane Sandstone is mostly found beneath the basalts. It is envisaged that the Ntane Sandstone formation was not heavily eroded before the extrusion of the basalts (BRGM, 1993). Mosolotsane formation on the other hand comprises of fluvial red beds, siltstone and fine grained sandstones. The Karoo supergroup belongs to the Mesozoic era.

While within this Mesozoic era, there are other groups that do not belong to the Karoo supergroup. These are Beaufort, Upper Ecca, Middle Ecca, Lower Ecca and lastly, Dwyka groups. The Beaufort group forms the Tlhabalala formation which comprises of the non-carbonaceous mudstones and siltstones with minor sandstones. The Upper Ecca group forms the following formations: Letlhakeng, Dovedale, and Dibete formations, respectively. The Letlhakeng formation comprises of the following: siltstone and carbonaceous mudstones with coal. On

the other hand, the Dovedale formation is comprised of coals and coaly mudstones and sandstones. Lastly, the Dibete group which falls within the Upper Ecça group is comprised of coals and carbonaceous mudstones. The middle Ecça group results in the Mmamabula formation. This formation consists of interfingering sandstones, siltstone and the carbonaceous mudstones. The lower Ecça group resulted in the Mapashalala formation. The Mapashalala formation is made up of the post-glacial lacustrines mudstones and siltstones marking the base of the Ecça group. While the Dwyka group resulted in the Dukwi formation which consists of the following: the base of the Karoo sequence, tilities and shales, varved siltstones and mudstones. BRGM (1993) points out that the total thickness of the Mosolotsane, Tlhabala, Letlhakeng and Debete formations is about 200 m in the Khurutshe area.

The Waterberg supergroup has one group, the Palapye group which forms the Shoshong formation. The Shoshong formation comprises of the Crystalline Dolorite, Siltstones, shales and the quartzites. The Waterberg supergroup belongs to the Proterozoic era. Another supergroup in addition to the Karoo and the Waterberg supergroup that belongs to the Archean era/age is the basement which consists of the granite gneiss and amphibolites. There is also the Kalahari group that neither belongs to the supergroup which was formed during the Cainozoic age which formed the Kalahari bed formation. It consists of soils, sands, calcrete and clay. Its thickness is generally estimated to be less than 15m (BRGM, 1993).

### **Hydrogeology of the Khurutshe Area**

Extensive work on groundwater, both desk studies and detailed groundwater assessment evaluation, have been carried out over the years in the Khurutshe area and also in the Palla Road area. Hydrogeology work carried out in the study area is well covered by Aquatech (1988) and BRGM (1993). This includes explorations for coal, cement and quicklime production, overlaying clay and mudstone for brick manufacturing, and sampling of sands overlying Ntane Sandstone in the Masama area for glass production. Different exploration companies such as Shell Coal, Geological Surveys, BP Coal and Anglo Botswana Coal Prospecting, both private and public enterprises, have been involved in



exploration of the area (AquaTech, 1988). DGS carried out evaluation of groundwater occurrence and exploration in the Mmabula area in 1994 (GCS, 1999). AquaTech did desk work on groundwater occurrence in the area (AquaTech, 1988; GCS, 1999; SMEC, 1991). Borehole siting and drilling in the area started from the early 1950s for villages, cattle posts and railway production (AquaTech, 1988). For instance, railway boreholes which were drilled along the railway line can be spotted now but they are obsolete and most of them used windmills. In most cases, all the successful boreholes that were drilled in the study area were those drilled in the Ntane Sandstone that is underlying the Stormberg lava and Kahlari beds. For instance, AquaTech (1988) sited and successfully drilled boreholes into the Ntane Sandstone for DWA at Leshibitse about 3 km from the Masama Ranch.

The Khurutshe area has two main aquifers which are both fractured porous media in the Karoo supergroup (BRGM, 1993; SMEC, 1991). The groundwater resource map (Figure 3.4) for the Khurutshe area shows different aquifers in the area. These two main aquifers are of the following types: in the Karoo, there are the Ntane Sandstones aquifers and Mmambula Sandstones members. The Mmambula Sandstones are generally three feldspathic sandstone members of the Mmambula Formation (BRGM, 1993). These three feldspathic sandstones members are considered as one aquifer (SMEC, 1991). It is estimated that the two main aquifers (Ntane and Mmambula Sandstones) are separated by the Mosolotsane, Tlhabala Letlhakeng and Korotlo formations which together comprises of 200 m thickness (BRGM, 1993).

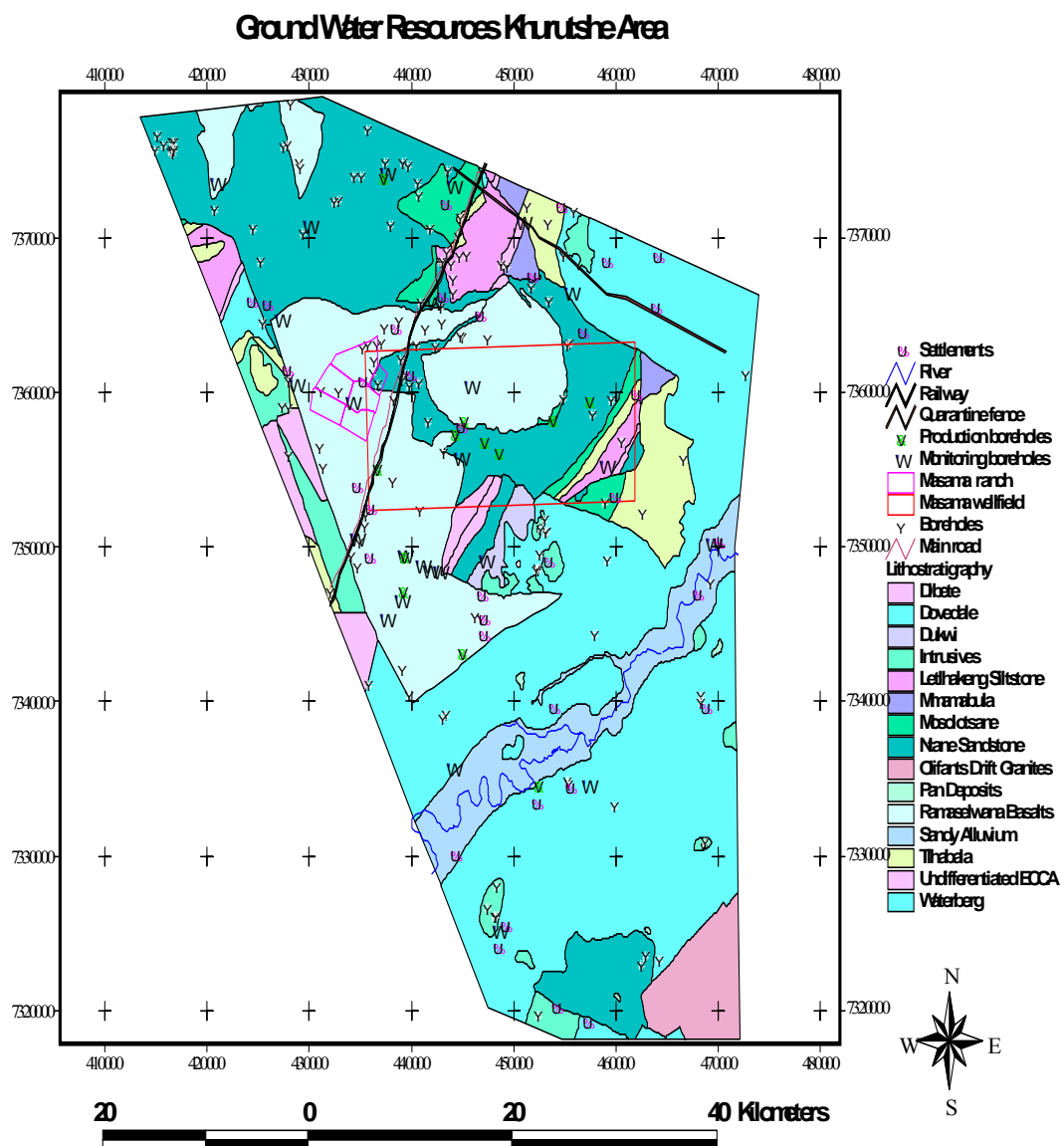

Figure 3.4: Groundwater resources in Khurutshe area.

While in the Waterberg supergroup, there are only fractured type aquifers which are related to faults and dolerite intrusion (AquaTech, 1988; BRGM, 1993; SMEC, 1991). Obviously, these aquifers are not as important and significant relative to the two main aquifers. The reason the Khurutshe area has various aquifers is because it comprises of the most complex arrangement of the aquifer blocks in the country (BRGM, 1993; GCS, 1999). Of the numerous aquifers in the Khurutshe area, which are arranged in the most complex manner, the most important aquifer in the study area is the Ntane Sandstone aquifer which has high yield and also proved to be a highly transmissive zone, second in order of importance is the Middle Ecca group (AquaTech, 1988; GCS, 1999). In addition, a high degree of blockfaulting has resulted in further divisions of the Ntane sandstone into the upper part known as the Massive Member and the lower part called the Transition Member (SMEC, 1991). It is estimated that the layers separating the main aquifer, the Ntane sandstone from the lower aquifer has a total thickness ranging from 200 m in the northern part to about 250 m in the southern part (SMEC, 1991). The Ntane Sandstone formation is areally extensive relative to other formations (AquaTech, 1988). Other formations such as the Ramaselwane volcanic formation do not contain any aquifers (AquaTech, 1988; BRGM, 1993). Around the Masama, it is found that the Ntane Sandstone either subcrops or has been intersected underneath the Ramaselwana volcanic formation.

Excessive groundwater in the Ntane Sandstone aquifers has been observed to occur at areas with significant fracturing and also at the top of the formation where it is below the static water level (BRGM, 1993). This observation has been made after all the boreholes drilled on major fracturing and faults have recorded high yields relative to other boreholes drilled elsewhere. Areas in the Khurutshe where there are major and strong post-Karoo fracturing which have favourable groundwater resources and high yield are the Masama, Boleleme, and Mmamagwaile faults zones (BRGM, 1993). While in the Waterberg formations, the occurrence of water is also strongly related to fractures and dolerite intrusions (BRGM, 1993). However, it is suspected that due to metamorphism, porosity of the Waterberg formation is close to zero (BRGM, 1993).

According to AquaTech (1988) the Ntane Sandstone Formation aquifer is both confined and unconfined. It is unconfined to semi-unconfined where it subcrops beneath the superficial deposits and becomes semi-confined to confined at a point where the aquifer is under the basalt cover (Aquatech, 1988).

The Ntane Sandstone aquifer thickness is estimated at around 120m and separated from the underlying Ecca aquifers by an aquiclude consisting of a sequence with thickness of up to 200m of the Mosolotsane and the Thabala mudstones and siltstones (GCS, 1999). The Ntane aquifer is highly compartmentalised. Its continuity is only interrupted where there is block faulting at which point the formation has been eroded in uplifted portions (GCS, 1999). To reach groundwater in the Ntane sandstone aquifer, it is pointed out that deep boreholes are required (SMEC, 1991). This is evident from the depth of boreholes drilled in the Masama and Makhujwane wellfields whose average depths are 203 m and 339.5 m, respectively.

There is also the phreatic aquifer in the study area, which is estimated to be on the range 10 to 30 m below the ground surface (GCS, 1999). Just like everywhere in the country where there are phreatic aquifers, access is through hand dug wells for livestock water and domestic consumption though at a very small scale. However, phreatic aquifer abstraction is only seasonal, functioning only during the rainy season. However all the production drilled to the depth of between 25m to 45 m did not have any yield in the Khurutshe area, specifically on the Masama and Makhujwane wellfield (GCS, 1999).

Estimating the volume of water held in a particular area such as Khurutshe area is not an easy task. Estimation of the quantity is not homogenous but is highly variable (Todd, 1980). It is pointed out in the Karoo supergroup, the task of estimating water in storage is extremely difficult due to its structurally complex area (AquaTech, 1988). Variables that are needed in estimating the amount of water held by an aquifer are firstly, the areal extent of the aquifer. Secondly, thickness of the aquifer which basically measures the depth of the aquifer. Lastly, the porosity of the aquifer is also needed. Todd (1980:26) defines porosity of a rock or soil as “a measure of the contained interstices or voids expressed as the

ratio of the volume of interstices to the total volume”. He calculates porosity as in Equation 3.1.

$$\alpha = \frac{v_i}{V} \quad \text{[Equation 3:1]}$$

Where,

$\alpha$  is the porosity;

$v_i$  is the volume of interstices; and,

$V$  is the total volume.

Thus, different types of rocks and soils have different porosity (Bear, 1979; Todd, 1980). In the study area, the most relevant rock type is the sandstone which dominates the area. Sandstones have reduced porosity as they are basically cemented forms of sand and gravel (Todd, 1980). He concludes that “the best sandstone aquifers yield water through their joints” (1980:41). However, BRGM (1993:4.4) discovered that “the Ntane Sandstones, mostly of aelian origin, are generally weakly cemented and might have a relatively high intergranular porosity, except in areas where sporadic diagenetic or paedogenetic silicification occurs”. It is observed that the aquifers in the Khurutshe area have a primary and secondary porosity which is related to fractures and weathering along the fractures (BRGM, 1993). A personal discussion with groundwater specialists at the Department of Water Affairs put the porosity value for the Khurutshe area at 20% which reflects very low porosity.

In 1988, AquaTech estimated that extractable water in storage in the Khurutshe area is approximately  $410 \times 10^6 \text{ m}^3$  quantity of groundwater, which in year terms was approximated at 34 years supply at the minimum abstraction rate (AquaTech, 1988; SMEC, 1991).

Tests conducted on the Ntane aquifer reveal that its mean transmissivity is around  $34 \text{ m}^2/\text{d}$ . In addition, the aquifer exhibits both the early and late storativites (S) which range between  $7 \times 10^{-6}$  to  $1 \times 10^{-5}$  for the early S and  $4.5 \times 10^{-4}$  to  $1 \times 10^{-2}$  for the late S (GCS, 1999). Furthermore, tests indicate that there is a good

hydraulic connection between boreholes in the area and the Ntane aquifer as shown by the negative skin factor (GCS, 1999).

The Khurutshe area is dominated by a large number of cattle post boreholes (BRGM, 1993). Thus, groundwater abstraction in the area is dominated by livestock as oppose to other uses such as domestic. These boreholes are either individually owned or alternatively owned by syndicates. However, syndicates are likely dominant over individuals due to the limitation of the land in the Kgatleng District. In 1993, it was estimated that there are 95 boreholes in the Khurutshe area, which according to BRGM (1993) signals a high density of cattle in the area. The current number of boreholes in the Khurutshe area contravenes<sup>16</sup> the 8 km radius policy for the boreholes.

The significant occurrence of groundwater in the Khurutshe area, specifically in the Ntane Sandstone has some strategic advantage for urban water consumption. Together with the Palla road aquifer, the Khurutshe aquifers are located along the NSWC. The NSWC is a project implemented to convey water from the Letsibogo dam in the northern part of the country to Gaborone in the south where there is occasionally acute water scarcity such as 1983/84 and 2004/2005 drought years. The NSWC project has been implemented with the sole purpose of supplying Gaborone and the surrounding villages in instances when Gaborone dam, Bokaa dam and the Molatedi dam cannot meet demand. Other villages that are supplied by Gaborone and Bokaa dams are Tlokweng, Mogoditshane, Ramotswa, Mochudi and Lobatse. The year 2004/05 is the first instance when the NSWC was supplying Gaborone as the Gaborone dam was reported to be only 25% full in June and was given only two months to dry up. The pipeline transports water from the Letsibogo dam over a distance of about 350km to the capital city and the surrounding villages. Together with the Palla Road aquifer, the two aquifers have been identified as a strategic backup supply to meet water demand from Gaborone and other surrounding villages when the Gaborone, Bokaa and Letsibogo dams cannot meet the demand (GCS, 1999). Thus, due to their strategic location along the NSWC pipeline, these aquifers are regarded as very important to the country.

---

<sup>16</sup> Borehole density in the Khurutshe area is 0.0418 per km<sup>2</sup>. Therefore, one borehole services approximately 23.89 km<sup>2</sup>. However, this includes settlements, production for NSWC and monitoring boreholes.

In the Khurutshe area, two wellfields being Masama and Makhujwane have been developed to supply the NSWC project (GCS, 1999). Subsequently, 23 production boreholes have been identified and drilled in the Masama wellfield within the Khurutshe area and 19 production boreholes in the Palla Road area (GCS, 1999). GCS (1999) projects that the total daily abstraction from the proposed 23 production boreholes in the Masama Wellfield will be 21 402 m<sup>3</sup> per day for 18 hours during those periods when there is a shortage of water at Gaborone and Bokaa dams.

The sole purpose of these production boreholes on the Khurutshe and Palla Road areas is to act as a strategic back-up water supply to the NSWC and not as permanent supply. It is envisaged that if the production boreholes are used as permanent supply for Gaborone then this may have detrimental impacts to groundwater resources leading to possible depletion of these vital resources in a short period of time (GCS, 1999).

### **Recharge estimate in the Ntane Aquifer**

Estimating recharge in the semi-arid and arid environments is not an easy task. For instance, Selaolo (1998:5) remarks that “a lively debate has continued for more than 100 years as to whether groundwater by infiltration of rainwater through Kalahari sediments is occurring under the present climatic conditions”. While others found recharge in the Kalahari some argue that Kalahari sand with thickness of above 6m will prevent active rainfall infiltration due to seasonal moisture retention and ultimate loss through evaporation and evapotranspiration (Selaolo, 1998). There are several methods in existence that are generally used for estimation of groundwater recharge (Gieske, 1992; Selaolo, 1998). In the study area, several of these methods have been employed to estimate recharge, though most of these methods qualitatively estimated recharge rates in the area (GCS, 1999). Methods for estimating recharge of the groundwater can be categorised into three distinct groups as follows: direct methods; indirect methods; and chemical or isotope techniques (GCS, 1999; Gieske, 1992; Selaolo, 1998).

Direct and indirect methods for estimating groundwater recharge are also known as physical methods (Selaolo, 1998). These methods are called thus as they involve a direct measurement of soil water transport while the indirect methods involve indirect calculation of moisture transport by soil-physical parameters (Selaolo, 1998). Of these methods, chemical and isotope techniques are said to be applicable and most relevant to semi-arid environments and have been applied to Botswana, particularly to the study area (GCS, 1999; Gieske, 1992; Selaolo, 1998). This is acknowledged by Selaolo (1998) who remarks that their potential in estimating groundwater recharge is more promising than the physical approach in semi-arid environments.

### **Chemical and isotope techniques for estimating groundwater recharge in semi-arid environment and the study area**

According to Selaolo (1998) chemical and isotope methods that are used to estimate soil moisture fluxes and recharge rates in both the saturated and unsaturated zone rely on the solute mass balance and isotope profiling techniques. The tracers that are used in the chemical and isotope techniques for estimating groundwater recharge should meet certain criteria (GCS, 1999; Gieske, 1992; Selaolo, 1998). The first criteria is that the tracer must behave conservatively. Basically, this means that the tracer must not be lost in significant quantities either by vegetation nor produced in the soil and its flux in the soil must be accounted for (Gieske, 1992, Selaolo, 1998). In addition, the tracer movement should not be slowed in relation to water movement (Selaolo, 1999). In addition, it is assumed that the tracer is transported downwards with penetrating water at deep infiltration zones (GCS, 1999). There are a range of tracers that are used in recharge estimation studies: tritium ( $^3\text{H}$ ),  $\text{Cl}^-$ ,  $\text{NO}_3^-$ ,  $\text{SO}_4^{2-}$ , oxygen-18 ( $^{18}\text{O}$ ), deuterium ( $^2\text{H}$ ) and chlorine-36 ( $^{36}\text{Cl}$ ). The procedures for using these tracers in estimating recharge are discussed intensively elsewhere (Gieske, 1992; Selaolo, 1998; Todd, 1980). In addition, advantages and disadvantages of these methods are also outlined such as data requirements and suitability and limitations to different climates. Due to the limitations of these numerous tracers in terms of data



requirement and limited applicability in the semi-arid environment, they will not be discussed here with the exception of chloride mass balance.

### **Chloride mass balance method for estimating groundwater recharge**

This method is used to determine moisture fluxes through the unsaturated zone, hence assessment of recharge to groundwater basins (Selaolo, 1998). It is one of the groundwater recharge methods that has been widely applied and best suited to a range of environments (Gieske, 1992) including the semi-arid environments of Botswana. Some of the basic assumptions of the chloride mass balance in estimating recharge are:

- The chloride ion behaves in a conservative manner, such that it is not taken up significantly or leached from aquifers. It is assumed that in a stable environment the amount taken up by vegetation equals the amount returned by decomposition of the vegetation (Gieske, 1992). According to Gieske (1992) chloride is one solute that generally meets the requirement of no net release or storage from the soil or rock matrix.
- The atmospheric input of chloride made up of wet and dry deposition is assumed to be constant annually and over long time scales (Selaolo, 1998).
- An assumption of a piston flow regime, defined as the downward vertical diffuse flow of soil moisture is made. However, according to Selaolo (1998) the assumption may sometimes not hold due to the complex transport of moisture by vertical and lateral movements occurring in the unsaturated zone as a result of variations in rainfall and evapotranspiration both seasonally or annually.

With these assumptions, infiltration rate and recharge of groundwater can then be calculated. The chloride balance method was applied for the Palla Road and Khurutshe areas. To estimate the aquifer replenishment for the two areas, Equation 3.2 was used (GCS, 1999):

$$C_R = C_P \frac{P}{R} \quad \text{[Equation 3.2]}$$

Where R (m/yr) is the aquifer recharge;

P (m/yr) is the areal precipitation;

$C_P$  is the chloride concentration in the precipitation sample (both dry and wet deposition); and,

$C_R$  is the chloride concentration in the groundwater.

In applying the above equation, GCS (1999) assumed that there is a constant wet and dry deposition of 400 mg/(m<sup>2</sup> x yr). In estimating recharge for the Khurutshe area, the total area was demarcated and categorised according to their recharge permeability, such as areas with calcretisate and silcrete layers which reduced recharge potentially greatly and areas without (GCS, 1999). Thus, recharge data is subdivided according to the aquifer structure (GCS, 1999). In the study for estimating recharge, in the Khurutshe and Palla Road areas, it was found that increased recharge occurs at areas where the basalt cover is absent, especially in the Ntane Outcrop area (GCS, 1999). However, it was discovered that thin basalt cover in the Masama fault zone does not impede groundwater recharge (GCS, 1999). In fact, where there was a thin layer cover of basalt which is less than 50 m and heavily fractured is favourable to recharge just like the Ntane outcropping areas. There are other intermediate formations in the Khurutshe area which comprises of the siltstones and mudstones that have primary and secondary porosity (GCS, 1999). These intermediate formations are between Ntane and thick Basalts cover in terms of their permeability to groundwater recharge. The Khurutshe area is said to have a highly complex aquifer structure particularly where there are outcroppings. It was found that block thickness varies greatly over short distances. Moreover, interlayers of shale and mudstones affect groundwater recharge variability considerably (GCS, 1999). Thus, to overcome the complexity in estimating recharge for the area, an average groundwater recharge of 1.6 mm per year is used for Khurutshe area (GCS, 1999). For the intermediate formations average recharge for the Khurutshe area was derived using Equation 3.3 (GCS, 1999):

$$\sum R_i \cdot A_i = A_{tot} \cdot \bar{R} \quad \text{[Equation 3.3]}$$

Where

$R_i$  is the recharge in area  $A_i$ ;

$A_{tot}$  is the whole area; and,

$\bar{R}$  is the averaged recharge.

According to the nature of the formation and its description and outcropping, five zones of recharge in the Khurutshe area were identified (GCS, 1999):

- Zone 1: recharge in the Ntane sandstone outcrop areas. This is where there is maximum groundwater in the location estimated at 6.0 mm per year.
- Zone 2: this is the zone of intermediate formation outcrop. Presumably this is the area that is covered by siltstones and mudstones which has considerable recharge but less than Ntane Sandstone outcrop areas. Recharge in this zone is put at 1.0 mm per year.
- Zone 3: This area is covered by the thick basalt layers and it is the zone with the lowest recharge rate of 0.2 mm per year and this is where the Masama ranch is situated.

With the zoning GCS (1999) estimated the total annual mass flux for the Khurutshe area as depicted in Table 3-1.

**Table 3-1: Recharge estimates for the Khurutshe area.**

Outcropping formation	Area (km <sup>2</sup> )	Averaged Recharge (mm per year)	Total Annual Mass Flux (m <sup>3</sup> per year)
R1. thick Basalt cover	475	0.2	90 000
R2. Pre-Ntane formations	280	1.0	280 000
R3. Ntane and thin Basalt cover	275	6.0	1 670 000
R4. subsurface inflow west	250	1.0	250 000
R5. subsurface inflow east	500	1.0	500 000
Overall catchment area	1800	1.6	2 800 000

Source: GCS (1999).

There are different values of recharge obtained when using different methods. Using the soil moisture balance method, recharge rate for the Khurutshe area is estimated at 1.5 mm per year (GCS, 1999). On the other hand when using chloride mass balance, recharge of groundwater in the Khurutshe area gives figures of 9 to 18 mm. According to GCS (1999) these figures are too high, with high culminating from uncertainty of chloride in rainwater.

### **Khurutshe aquifer properties (conductivity, transmissivity and thickness)**

Generally, aquifers possess properties that are highly variable spatially (SMEC, 1991; Todd, 1980). For these reasons Todd (1980), argues that though an aquifer has different properties, in mathematical calculations of the storage and flow of the groundwater, an idealized aquifer is normally assumed. Todd (1980) defines an idealized aquifer as one that is homogeneous and isotropic. A homogeneous aquifer is defined as one that “possesses hydrologic properties that are everywhere identical” (Todd, 1980:45). Two important aquifer properties that are frequently employed in groundwater hydraulics are aquifer thickness and hydraulic conductivity.

Aquifer properties are generally estimated from various methods such as laboratory techniques and borehole data specifically test pumping and water level monitoring (SMEC, 1991; Todd, 1980). Todd (1980) points out that of these various methods, the most reliable one specially for estimating conductivity is by test pumping of boreholes. Todd (1980) defines a unit hydraulic conductivity as when in a unit time, a unit volume of groundwater is transmitted at the prevailing kinetic viscosity. In the Khurutshe area measured conductivities vary greatly and has been grouped according to the aquifer types as follows: Eastern fractured Ntane Sandstone, eastern Ntane Sandstone, Western and northwestern Ntane Sandstone, and Pre-Ntane formations. From these conductivity zonations and groupings, the eastern fractured Ntane sandstone has the highest conductivity. On the other hand the eastern Ntane Sandstone and Western and northwestern Ntane Sandstone have relatively the same conductivities (GCS, 1999).

As pointed out at the recharge section, Khurutshe aquifer thickness is not uniform, but varies as is the norm with other aquifer properties such as conductivity, specific yield etc. GSC (1999) divided the aquifer thickness in two groups; 1) Less than or equal to 100m; and, 2) Greater than 100 but less than 200m. On average it is estimated that the whole thickness of the Ntane Sandstone formation is between 100 and 130m (BRGM, 1993).

### **Water resources for livestock and challenges faced by farmers in the Kgatleng District**

Livestock in the Kgatleng district obtain their water supply from two sources: surface water and groundwater. Refer to Table 3-2 on sources of livestock water supply in the Kgatleng District. The district is one of the smallest districts in the country, measuring 7910 km<sup>2</sup>. Due to its small size, overstocking and overgrazing is high relative to other districts in the country. Comparatively, it is argued that Kgatleng District became the first District in the country to experience accelerated large scale borehole drilling and groundwater utilization (Peters, 1983). This dates back to the 1920s (Peters, 1983). Incidentally, accelerated large scale borehole drilling and the small size of the District resulted in the District reaching its spatial

limits in terms of space for borehole drilling for livestock (Arntzen, 1985). That is with the 8 km radius of borehole drilling, there was no space to permit further boreholes drilling at least for livestock farming.

To accommodate a large number of farmers in the District, formation of syndicates was therefore adopted. A syndicate can be defined as a group of farmers who collude and jointly own a borehole sharing the fixed costs (drilling and surveying) and operational variable costs (diesel and maintenance). According to Peters (1983) this management was first adapted in Kgatleng District. He argued that the rationale for syndicate formation was initially to generate revenue to cover recurrent operation and maintenance costs. While this may have been the initial motive, the prevalence of syndicates in the Kgatleng District relative to other Districts is generally prompted by the size of the area rather than as an incentive to generate funds to run boreholes. The reason being that with spatial limits reached it was no longer possible for new entrants to drill their own boreholes. Thus the only plausible option was for the new entrants to join the already established farmers with boreholes. For those individuals who have identified locations which satisfy the 8 km radius, it was encouraged that they team together to form syndicates (SMEC, 1991). Therefore one can argue that syndicate farming in Kgatleng District is not a matter of choice but of circumstance. This argument is supported by SMEC, (1991:12-8) who observed that “the MLGL guidelines favour the allocation of boreholes to syndicates and groups rather than to individuals. This is presumably to ensure wider access by local communities to their communal grazing resources”.

Water as an input in the livestock sector is the most limiting factor in the Kgatleng District. Water rights give de facto grazing rights and therefore, those farmers with no boreholes do not have grazing rights. Generally, the procedure for farmers with no boreholes is to come up with arrangements with those farmers with boreholes and buy water from them thus giving them grazing rights in the process. Normal charges per cow range between P3-P5 per month<sup>17</sup>. These charges are generally set in an ad hoc manner and do not reflect the cost of abstraction per cattle per month. In any case, 33 farmers interviewed pointed out that they are not

---

<sup>17</sup> P stands for Botswana currency and it is called Pula. P1 is equivalent to NZD 3.5 (30/09/2006) exchange rate.

charging fees that recover costs but that these are fees that have been agreed by syndicate members and they have not been changed for a long time (three years at most). However, most farmers were interested in knowing the actual costs of abstraction per cow so that they could adjust their charges. Their charges are not a surprise given the communal nature of their livestock production.

**Table 3-2: water sources in the Kgatleng District**

<b>Water point</b>	<b>Number</b>	<b>Type and ownership</b>
Boreholes	963	Owned by government, syndicate and individuals
Wells	132	Individuals, located along the rivers
Dams	1329	Mainly haffirs <sup>18</sup>
Natural sources	126	Pans both natural and man-made, man-made are excavations along roads

**Source: Wellfield Consulting Services (1996) .**

Pans are a primary source of surface water for livestock (natural and borrow-pits from excavation for gravel for road construction). Figure 3.5 shows distribution of pans in the study area. Rivers are also an important source of livestock water supply (Mpotokwane, 1999). There are four rivers in the Kgatleng District: Madikwe, Olifants, Limpopo and Notwane. However, rivers are less preferred due to the losses associated with them, especially during below normal rainfall years when cattle are weak. Farmers in proximity of these rivers opted to water their cattle at boreholes as their livestock get trapped in the mud during the dry season. Losses from cattle trapped in the mud can be substantial. An interview with farmers in proximity of the rivers reveals the following losses in the Limpopo river in 2004 (Table 3-3).

<sup>18</sup> Haffirs is defined as artificial excavations which collect surface water during the rainy season to be used by the livestock sector.

**Table 3-3: Cattle losses from the Limpopo River**

Number of Livestock trapped in river	Number of farmers
1-5	6
5-10	3
10-15	1

Due to the losses involved in watering from rivers, pans are the most important and preferred sources of surface water during the rainy season. Interviews and discussions held with farmers revealed that during good, rainy years, boreholes can be idle for more than three months, between December and to April when the cattle use pans. In his thesis, Mpotokwane (1999) observed that water points in the study area can hold water for up to four months during above normal rainfall years. However on bad years, like in 2004-2005 pans held water for only a few days or weeks. However, in the western part of the District in the Khurutshe area farmers indicated that pans are not as significant in providing water for their cattle.



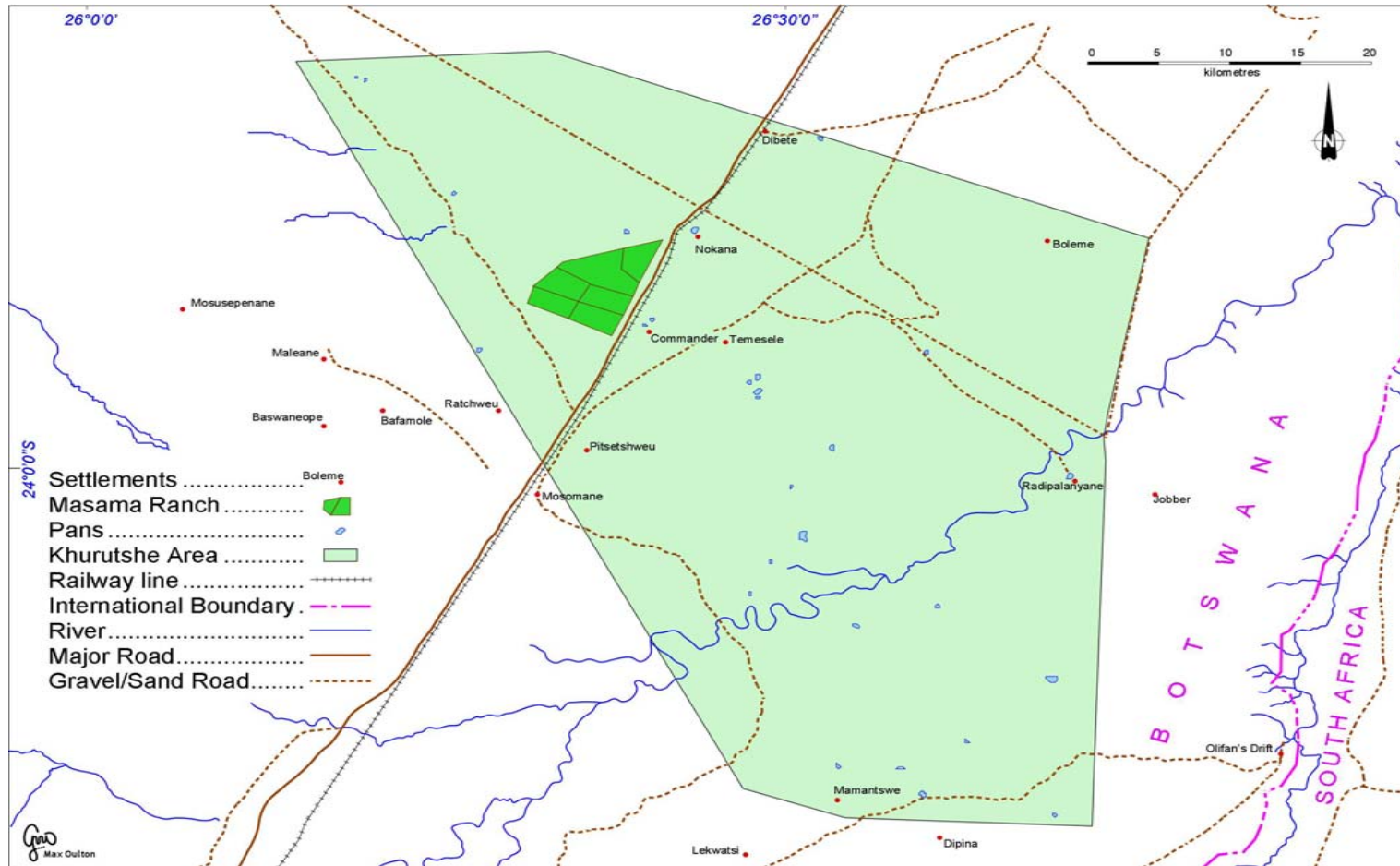

Figure 3.5: Distribution of pans in the study area

Discussions with numerous farmers reveal that their objective is generally to minimise water costs which to them are substantial. In fact 70% of the 33 farmers interviewed revealed that water is the most costly input in livestock production. These findings support those of Bailey (1980) and Oageng (1999) that to meet livestock water requirements, farmers opt for the most reliable and least costly supply. Therefore, surface water from pans and rivers are the more convenient and low cost sources of livestock water as opposed to boreholes which obviously have operational costs. These costs include diesel and maintenance. However, during the dry season when pans are dry, farmers revert to the use of boreholes. Though it is argued that farmers choose between pans and borehole to water their livestock, this is not true as it is not a matter of choice from the farmers side. It emerged during the discussion with the farmers that as soon as water points are filled with rain water cattle automatically move to them. This is because generally pans are located near grazing areas as opposed to the boreholes. Areas around boreholes are normally overgrazed and therefore bare as observed by Durraipah and Perkins (1999), thus cattle have to move more than 10 km between water points and grazing locations. Thus, it is more convenient for cattle to drink at the pans which are near grazing areas than move great distance and lose grazing time. A majority of the farmers interviewed (90%) indicated that as long as there is surface water available at the pans, cattle stop coming to their boreholes.

Another practise adopted by farmers, not only in Kgatleng District, but the whole country and in other semi-arid environments, particularly pastoral farmers, is on the numbers of days that livestock are watered. The Animal Production Research Unit (APRU) recommends that livestock be allowed 24 hours access to water at reasonable distance from grazing, however, this is not easy to achieve as discovered by Oageng (1999). Factors that constraint farmers from allowing livestock 24 hour access to water include the following:

- distance between grazing and boreholes. Carl Bro (1982) pointed out that the distance between a water source and grazing area is usually high and therefore to avoid stress and to provide time for grazing, farmers decide to water their livestock every 2 to 3 days.
- When groundwater levels are low and borehole yield declines. According to MOA (1984) when water levels are low, farmers fear that watering their

livestock on a daily basis may deplete aquifers before the rainy season comes and therefore revert to the strategy of watering their livestock every 2 to 3 days. Interviews conducted in the Kgatleng District reveal that borehole yield sometimes declines considerably, such that it takes two days pumping to fill the reservoirs. This is generally experienced during the dry season when livestock water demand is high. As a strategy to save the depleting groundwater farmers do not water on a daily basis.

Nicholson (1987) observed the same strategy in southern Ethiopia and northern Kenya where pastoralist tribes allow their cattle access to water after 2 to 3 days. According to him, the benefits from this strategy are threefold. Firstly, exploitation of grazing resources is optimized as livestock do not trek on a daily basis. Secondly, where water is scarce, a saving of 30% is made. Thirdly, water intake is directly related to dry-matter intake. Thus, “under a 3-day system, water intake dictates dry-matter intake. In a long dry season, the result would be conservation of fodder resulting from this depression of dry-matter intake” (Nicholson, 1987:127). However, this strategy may also affect the production of the livestock in terms of growth, weight gain and production.

Though pans might play a fundamental role in supplying water to livestock, their use is not optimised and efficient as revealed during the discussion and also from the data collected at the Masama Ranch. Pans as a source for cattle water supply help achieve groundwater sustainability in two ways. Firstly, when they are filled, groundwater utilisation is reduced and therefore if there was any decline in groundwater resources, recovery is possible during the resting period, particularly in the rainy season. Secondly, farmers make some saving in terms of operational costs (diesel and maintenance) when cattle drink from free surface water resources. Thirdly and lastly, pans might be responsible for recharge of the aquifer through seepage.

In 1995, the government of Botswana devised a policy to facilitate improved utilization of pans through fencing and excavation to increase holding capacity. These policies were in the form of subsidies provided to farmers to fence pans and also evacuate them. However, while there are economic and environmental

benefits from pans, as pointed out, farmers are reluctant to fence and excavate them in the vicinity of their boreholes. From the discussions and interviews with farmers, the main reasons for reluctance in using pans in an efficient and optimal manner stems from the fact that, pans are public goods. Farmers argue that improving holding capacity and fencing (which improves water quality) attracts many livestock from their respective boreholes to the improved pan and this encourages overgrazing in the vicinity of that particular pan. As pans are a public good, their use is non-excludable while diminishing the marginal benefits of grazing. As water rights give grazing rights on the 8km radius, it means that the owner(s) of the borehole(s) adjust to the pan losses. Thus, though important, pans have free riding and tragedy of the commons problems. This observation is supported by Mpotokwane (1999) who noted that during dry years, there is a high stocking density around water points which hold water for a long time. Therefore, farmers opt not to improve the water holding capacity of their pans as they will impact negatively on the grazing in the vicinity of their boreholes. But still the role played by pans is appreciated and acknowledged by farmers as they eagerly wait for their pans to fill. Another problem that farmers face in the Kgatleng District is watering stray livestock at their boreholes. Discussions with the farmers reveal that stray cattle and donkeys frequent their boreholes and they are forced to water them to avoid cattle destroying the gates and fence near the drinking troughs.

### **Groundwater utilization and sustainability issues in the country**

As indicated, dependency on groundwater resources in the country is high (greater than 56%). Currently, the livestock sector is the major consumer of water constituting about 40% of all water used with almost all of it originating from groundwater. However, such dependency on groundwater is not unusual, as noted by Tuinhof *et al.* (2003) and Todd (1980). They argue that due to the abundance of groundwater, representing about 97% of fresh water, it is the main source of water supply to mankind. Secondly, groundwater is relatively cheap compared to surface water whose development cost, through dam construction, can be extremely high and prohibitive. And lastly, groundwater is readily available at

good quality as compared to surface water resources which can be easily polluted (Todd 1980). However, this second advantage is apparently being lost as noted by Sophocleous (2000:27) that “the time has passed when abundant supplies of water were readily available for development at low economic, social, and environmental costs”. Another important advantage of groundwater is that it is not subjected to evaporation losses relative to surface water resources.

Groundwater in the country is subjected to tremendous pressure from all sectors: domestic, livestock and mining, particularly the Orapa and Letlhakane diamond mines and the Morupule power station where there is serious depletion of groundwater, particularly around the mining towns of Jwaneng and Orapa (SMEC, 1991). In almost all these cases, except for mining towns and mining activities, intensive exploitation of groundwater can without doubt be linked with the development of mechanised borehole and pumping technologies. Of particular interest to this study, which has been heavily acknowledged and cited in the literature, is the link between borehole technology and growth in cattle numbers. Before borehole technology which enabled accessibility to groundwater, farmers only kept livestock that could be supported by surface water from rainfall and shallow hand dug wells. This is acknowledged by SMEC (1991:12-15) who point out that “...water yield and labour are likely to be the most limiting factors on livestock numbers where water is hand pumped from wells”. Thus, with borehole technology and pumps, livestock numbers increased tremendously throughout the country. SMEC (1991) remark that prior to the 1940s, livestock numbers increased slowly and were restricted to the hardveldt where surface water from rivers were prevalent. However, the installation of boreholes in the 1950s in the hardveldt and sandveldt areas facilitated livestock rearing on the sandveldt on a year round basis. Water was no longer a limiting factor.

Besides the technological factors, borehole drilling and diesel engines to pump groundwater, there are other factors in the country that encourage the over-utilisation of groundwater. Economies of scale is one of the factors that encourage over-utilisation. Economies of scale can be defined as declining average cost of production as output increases. Thus, to realise economies of scale, farmers over-stock their boreholes such that total costs (fixed and variable costs) are spread

over a large number of livestock. This strategy is cited by SMEC (1991:12-11) that “the large investment required to bring a borehole to production and its subsequent operating costs, are inducement to keep as many cattle there as possible”. Therefore, economies of scale is a factor that directly influences over-utilisation of groundwater, as farmers over-stock to bring the costs of operation down. Expansion of livestock numbers to achieve economies of scale and to make borehole operation viable led to a phenomenal exponential growth in groundwater abstraction in the country. Presumably, economies of scale fits well in the water development strategy for farmers which is to minimise the costs of livestock water supply (SMEC, 1991).

Secondly, financial incentives can be linked with over-utilisation of groundwater. In the quest to make the livestock sector attractive, the government of Botswana gave financial assistance to farmers for borehole drilling. Obviously, borehole drilling and water assistance were introduced due to the realisation that water was a limiting factor and that the costs of borehole development were prohibitive. For instance, SMEC (1991) put the initial cost of drilling and equipping a cattle post borehole in 1989 at between P50 000 and P60 000. While in the western region it could be double that amount (SMEC, 1991). The following are some of the incentives that the government introduced to ensure that water was no longer a limiting factor:

- The National Development Bank (NDB)

The bank provides loans to different economic enterprises. In addition, loans are available to stock owners for water development in both communal and commercial cattle posts. According to SMEC (1991) loans declined over the last 10 years probably due to the scarcity of grazing lands. In 1982/3, 226 water development loans were approved as opposed to only 25 per year in the 1990s.

- The Drought Assistance Programme (DRP)

DRP was a concept of the Ministry of Agriculture and introduced in 1988 with the objective of assisting livestock owners financially in drilling and equipping boreholes on communal areas only (SMEC, 1991). DRP had three schemes:

- Scheme A where a grant of up to P20 000 was allocated to assist syndicates to improve equipment of existing water resource or for reticulation to ease grazing pressure. The other condition for allocation under this scheme was that the syndicates should comprise of at least three members, each member with at least 60 cattle (SMEC, 1991). Thus, indirectly this led to over-utilisation of groundwater by encouraging member to have more cattle to qualify for the grant.
- Scheme B of DRP provided drilling grants to livestock owners with between 61 and 200 cattle. Under this scheme, DRP covered 60% of the drilling costs (SMEC, 1991).
- Lastly, scheme C was for farmers with over 200 cattle with borehole drilling (SMEC, 1991). Kgatleng District had six approved DRP applications out of a total of 145 approved applications countrywide between January 1989 and January 1990.
- Services to Livestock Owners in Communal Areas (SLOCA)  
SLOCA's main aim was to extend new animal husbandry methods to small livestock owners (SMEC, 1991). Farmers were given subsidies to improve water for their livestock.

There are other water schemes that were introduced such as the Livestock Water Development Scheme in 1980 where farmers in drought-stricken parts of the country were assisted with funds for drilling and pumps for boreholes (Oageng, 1999). In addition, the Agricultural Water Development scheme was implemented in 1993. The main objective of the scheme was to assist farmers in construction of “multi-purpose dams for livestock, irrigation, and fisheries, rehabilitate wells and install hand-pumps for farmers and provide troughs for watering livestock” (Oageng, 1999:17). Thus all the schemes facilitated, one way or the other, in extensive groundwater development and utilisation in the country.

Intensive abstraction of groundwater has been universal and has been associated with a break through in borehole drilling technology (Custodio, 2002; Dottridge and Jaber, 1999; Loaiciga, 2004; Tuinhof *et al.*, 2003). Another factor that has been responsible for intensive use of groundwater has been increasing demand for

water and scarcity of surface water. Limited surface water meant that the only possibility to meet escalating demand, was groundwater exploitation. Surface water as a contributing factor to groundwater mining is acknowledged by Custodio (2002:255) who argued that “in many regions, especially where rainfall is scarce and the area is favourable for human settlements, aquifer development may be intensive, since groundwater is often the fresh-water resource that is most accessible, cheap and reliable”.

As with other natural resources, excessive exploitation of groundwater to meet escalating demands has led to concerns and skepticism on the sustainability of this resource. These concerns are worldwide (Custodio, 2002; Loaiciga, 2004; Loaiciga *et al.*, 2000; Loaiciga and Leipnik, 2001; Sophocleous, 2000). Intensive exploitation of groundwater has been heavily associated with terms such as groundwater mining, over-draft and overexploitation. Over the years, aquifers have been classified as either mined, over-drafted and over abstracted (Custodio, 2002). Even in Botswana these terms have been applied (CSO, 2000).

Intensive abstraction and over-reliance on groundwater has resulted in a rift among scholars with the bone of contention being whether current abstractions is sustainable or unsustainable. In addition, terms used to describe the use and condition of aquifers have also been subjected to criticism. For instance, Custodio (2002) argued that overexploitation, over-draft, over-extraction of groundwater are terms that are loosely used, misinterpreted and often used without a precise meaning and definition. Moreover, he ascertained that these terms were frequently used in semi-arid and arid regions where there is an intensive use and total dependence on groundwater. He cautions that care must be exercised when using such terms in groundwater exploitation. Hence, each country has its own definition of groundwater mining or sustainability probably because sustainability is a difficult concept to measure, particularly groundwater sustainability, where recharge rates are low and abstraction rates high. For instance, in Botswana, groundwater mining is defined as a continuous drop in water level for a period of five successive years (CSO, 2000).



More importantly, others have focused on sustainability and abstraction of fossil aquifers with insignificant recharge or no recharge rates. The common definition of sustainable development is the development that meets the needs of this generation without compromising the ability of the future generation to meet their own needs (Perman *et al.*, 1997). Thus, using this definition, if the present generation uses fossil water, each abstraction is incrementally reducing the ability of the future generation to meet their needs (Perman *et al.*, 1997). On the other hand if there is no abstraction taking place then the resource is of no benefit to anyone. In fact, with a positive <sup>19</sup>discount rate, then a utility gained from consumption of a unit m<sup>3</sup> of groundwater progressively declines over time. Therefore, if groundwater is not used because of equity issues (intergenerational) then its net present value (hereafter NPV) will decline over time with a positive discount rate (Perman *et al.*, 1997).

Using this argument, when there is no recharge of groundwater, being a non-renewable resource, it is economically justifiable to deplete it over time (Custodio, 2002). However, its depletion over time should maximise social NPV. In addition, the revenue collected should be reinvested so as to enable future generations to meet their needs through relatively expensive water alternatives. Maximising NPV basically means exclusion of inefficient, uneconomic water uses and allocating water from low value added to high value uses. For instance, in irrigation low value crops being replaced with high value crops such as cotton. This would maximise the dollar value of each unit m<sup>3</sup> of groundwater as it is depleted. The rule that is generally adopted for efficient and sustainable depletion of non-renewable resources is the Hotelling rule. The rule states that as the resource is being depleted the rate of change of the resource price must increase at the same rate as the discount rate over time (Perman *et al.*, 1997).

Where aquifers are generally recharged over time, hydrologists and water managers have devised a measure called safe yield to guide exploitation of groundwater in a sustainable manner. Sophocleous (2000:29) defines safe yield as

---

<sup>19</sup> Discount rate is used to find the present value of future costs and benefits. The higher the discount rate the lower is the present value of future costs and benefits. Thus, if we use a high discount rate for groundwater, we are saying, its value in future is lower compared to today's value.

“the attainment and maintenance of a long-term balance between the amount of groundwater withdrawn annually and the annual amount of recharge”. While Dottridge and Jaber (1999:319) defines safe yield “as the water that can be abstracted permanently without producing undesirable results”. According to Dottridge and Jaber (1999) two extreme definitions of safe yield can be adopted: the conservative and non-conservative. In general, the non-conservative definition can be adopted for arid and semi-arid regions where there is no recharge (Dottridge and Jaber, 1999). Consequently, safe yield is the same concept known as maximum sustainable yield (hereafter MSY) that is used to manage renewable biological resources such as fishery, forestry and animal populations.

However, safe yield and MSY as tools for sustainable management for renewable resources has been heavily criticised by natural resources managers. For instance in fish management, the frequent criticism is that it is static while fish populations are dynamic (Perman *et al.*, 1997). Thus, in years where a fish population is low, a calculated MSY may be too high for the available population leading to depletion of the fish resources. Likewise, safe yield has been heavily criticised, for its lack of insight in functions of an aquifer except recharge and abstraction. Custodio (2002); Dottridge and Jaber (1999); and Sophocleous (2000) categorically dismiss safe yield and argue that using safe yield to manage groundwater becomes unsustainable over the long term. This is because it does not take into account the interaction between aquifers and surface water (Custodio, 2002). In addition, it ignores the fact that under either natural recharge or equilibrium conditions, natural recharge is balanced by discharge from the aquifer by evapotranspiration or into streams, springs and seeps (Dottridge and Jaber, 1999). Overall, it is argued that it excludes environmental impacts in its quest for groundwater sustainability in the long run (Dottridge and Jaber, 1999). The exclusion of discharge into streams and springs when estimating safe yield ultimately results in springs and surface water bodies drying (Custodio, 2002; Sophocleous, 2000). It is noted, when using safe yield as a groundwater management concept, an aquifer is classified as mined or over-exploited when abstraction is above safe yield (Custodio, 2002).

### **Current groundwater utilisation for livestock and sustainability issues in the Khurutshe Area**

Information on groundwater abstraction is unavailable as monitoring is only carried out on council boreholes which supply the domestic sector. For individual boreholes which are solely used for livestock production, monitoring of abstraction does not occur. In addition, farmers also do not know the exact number of the livestock that drink from their boreholes due to the prevalence of stray cattle in the communal areas and also high mobility of livestock between boreholes. This is especially true during the rainy season when livestock move between pans. Thus, mobility of cattle coupled with stray cattle make it impossible to know abstraction of groundwater. Moreover, information on the amount of water required per animal and the effect of seasonality is not known with certainty. For instance, studies that have estimated water consumption by different sectors, have assumed that daily per capita water consumption does not change with seasonality.

A total of 103 boreholes, both private and syndicates, supply livestock in the Khurutshe area. Figure 3.6 shows the distribution of boreholes in the Khurutshe area. Currently, Artesia, Dibete, Kgomodiatshaba, Leshibitse and Mookane settlements get their supply from the Khurutshe groundwater. These are generally small settlements with a combined population of less than 7000 (GSC, 1999). The livestock sector is the major consumer of groundwater resources in the area, comprising of over 70%. In the Khurutshe area, village supply was estimated to be in the region of 10% of total use (GSC, 1999). From the survey conducted in the Khurutshe area on the number of cattle per borehole, it emerged that on average a borehole supports approximately 500 cattle. Thus, the total number of cattle in Khurutshe area is estimated at 45 000 for this study. Compared to the southern part of the Kgatleng District, the Khurutshe area is managed by wealthy farmers who have more cattle. Therefore, the Khurutshe area is heavily populated compared to the rest of the District. In addition, movement of livestock is unrestricted such that cattle from the eastern part of the Kgatleng frequent the Khurutshe due to reliability of boreholes in the former area.

Sustainability of groundwater is one of the core issues in this study and incidentally one issue that is not easy to determine. Firstly, there is more than one measure that can be used to estimate sustainable use of groundwater. Secondly, the recharge rates in semi-arid environments are highly uncertain (Selaolo, 1998). And, lastly, different measures can give different results leading to inconsistent conclusions. To determine sustainability of groundwater utilisation in the Masama area, two approaches have been adopted. Firstly, the difference between daily recharge and abstraction has been computed for the Masama Ranch and the whole Khurutshe area. Secondly, the ratio between total groundwater in the area and the difference between recharge and abstraction has been computed. The second method basically measures the depletion period of the resource and it is generally relevant where recharge is significantly small to adopt a safe yield strategy. This measure may not be relevant for the Khurutshe area.

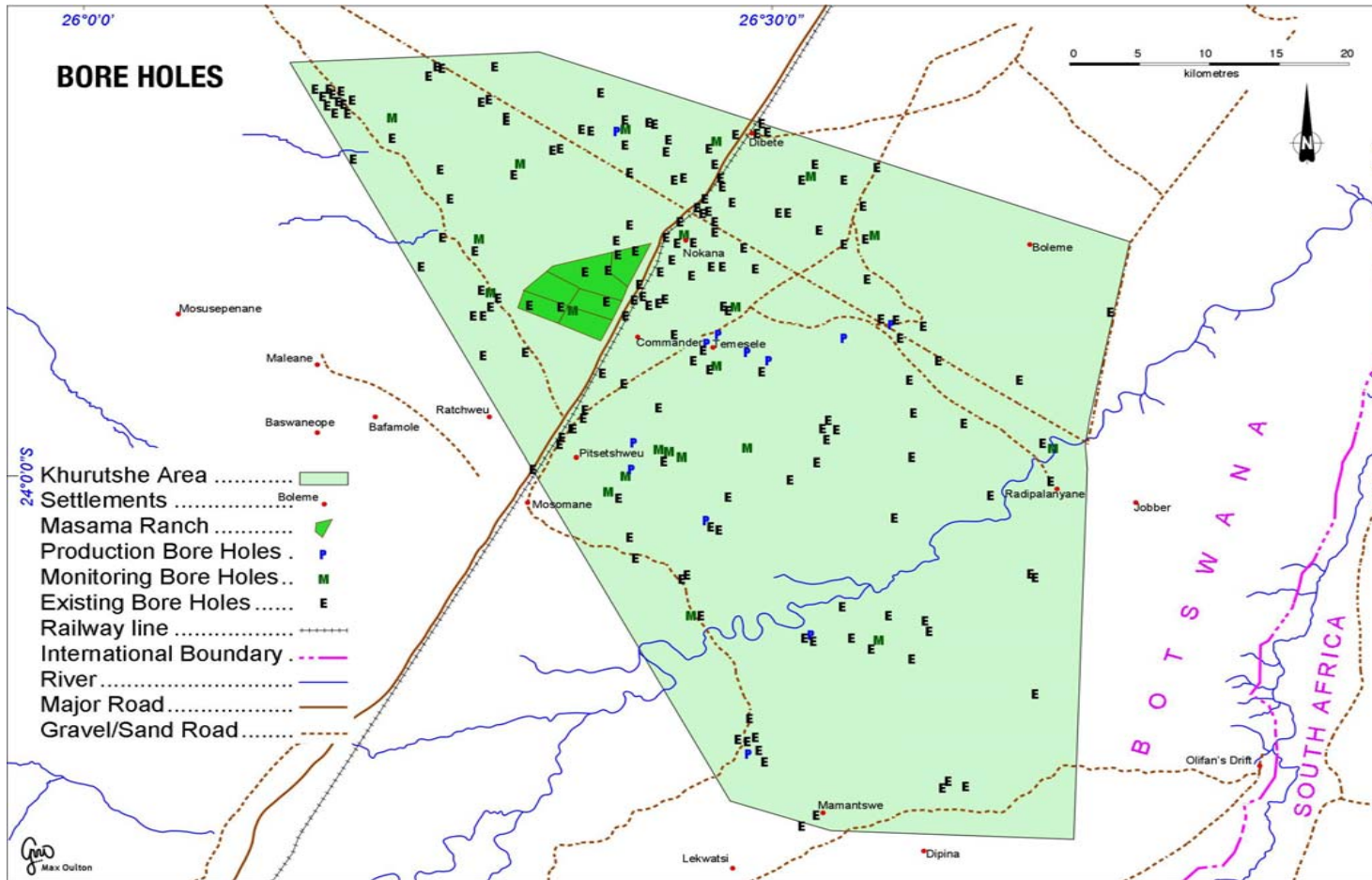

Figure 3.6: Borehole distribution in the Khurutshe area.

The water table in the Khurutshe appears to be declining at a rate of 0.61 meters per year (Artnzen *et al.*, 2003). In general terms, this is an indication that groundwater is being overdrawn in the Khurutshe area. If there is a depletion of the groundwater then it is expected that the water level in the borehole declines (CSO, 2000; Custodio, 2002; Dottridge and Jaber, 1999). Specifically, Custodio (2000) argues that declining water tables could indicate a temporary disequilibrium caused by the rate increase or the more serious condition of groundwater mining under unsustainable pumping rates. Thus, water levels as a measure of groundwater depletion is a good method given the extremely slow movement of water between aquifers. For instance, Tuinhof *et al* (2003) defined the flow of groundwater between aquifers at rates ranging between 1 m per year and 1 m per day. In addition, though interaquifer leakage may initially level off, with declining water tables over time, adjacent aquifers also could decline to the level of the over-used aquifer leading to a progressive decline of water tables for the whole aquifer (Custodio, 2002). Other studies have observed that groundwater levels in the Kgatleng District are declining. SMEC (1991) estimate that in the Kgatleng District water tables are declining at a rate of between 0.04-0.19m per year in Mochudi and 0.1-1.8m per year in Malotwane. Generally, water levels in the country show a declining trend with abstraction (CSO, 2000). According to the GCS (1999) the decline in water levels are due to a combination of groundwater abstraction and natural declines in regional water levels. In addition, the CSO (2000) points out that there are some boreholes in the country that actually show a continuous drop in the water level for a period of five successive years.

### **Climate change and cattle water demand**

Very few studies have attempted to assess the effects of climate change on livestock water demand. Therefore, knowledge on climate change and livestock water requirements is lacking (IPCC, 2001). IPCC (2001) looked at climate change, its potential effects on grass production and rangeland ecosystems. There are other studies that have looked at climate change and livestock production (Christensen *et al.*, 2004; Howden *et al.*, 1999; Jones and Hennessy, 2000;

Perrington and Devender, undated; Rotter and Geijn, 1999). IPCC (1998, 2001) simulation studies show that with a doubling of CO<sub>2</sub>, grass production will increase by 20 to 30%. Rotter and Geijn (1999) did an assessment of the impacts of climate change on livestock growth. Hulme (1996) also assessed the effect of climate change on rangeland in Southern Africa and concluded that there will be an acceleration of bush encroachment.

Another report, related to climate change and cattle water consumption, is *Water for Animals* by the FAO (1985). The report only looks at water requirements<sup>20</sup> for livestock under different temperatures. Water consumption by animals (livestock) varies greatly with the following factors: air temperature; food quality and quantity; relative humidity; animal size and type; and percentage moisture of the diet (Bartholomew, 2004; FAO, 1985; Parker *et al.*, 2000).

The daily water requirement of cattle is made up of two components:

- Voluntary water intake<sup>21</sup> or actual water drunk by the animals; and
- Involuntary water intake or water obtained from forage.

It has been found that water requirements are higher on hot and dry days and when animals graze on dry forage (Hoffman and Self, 1972; Howden *et al.*, 1999; Parker *et al.*, 2000; Perrington and Devender, undated; Roller and Goldman, 1969). Comparatively, water needs and consumption decrease on cool, rainy days, and this is a season when animals graze on lush forage (Batholomew, 2004). According to the FAO (1985), during the rainy season grass forage may contain up to 80% water, while Batholomew (2004) puts the value between 70 and 90%. The moisture content under such conditions therefore accounts for a substantial percentage of an animal's total water requirements. However, this depends on the amount of forage cattle take on a daily basis. Dry forage may contain only 10-15% of water. Therefore, when forage is lush the demand for voluntary water intake is lower relative to when forage is dry.

---

<sup>20</sup> Water requirement is defined as the total quantity of water required by animals for their metabolic processes as well as for the heat regulation of their body (FAO, 1996).

<sup>21</sup> Voluntary water intake is defined as quantity of water which has actually to be supplied to animals and corresponds to that part of the water requirement which cannot be provided by the moisture within forage.

As noted in chapter two, temperature affects livestock daily water needs considerably (Parker *et al.*, 2000; Parsons *et al.*, 2001; Roller and Goldman, 1969; Smart, undated). Other factors that influence water requirements for cattle are water quality and food quality. It has been observed that the content of salt in food intake has an influence on water consumption. The FAO (1985) found that water consumption of sheep grazing on saltbush increased by three times compared to sheep on grassland where salt content is low. There are also other effects of increased temperature as identified by Bianca (1965).

Though few studies have been done on livestock water requirement and climate change, it is clear that there is a strong link between cattle water demand and temperature. As climate change entails increases in temperature it can be concluded that climate change may lead to increase in water demand. Specifically, an increase in temperature and a decrease in rainfall will lead to increased voluntary water intake for livestock. Impacts will manifest in two ways: firstly, an increase in temperature will automatically lead to an increase in demand for water, and, secondly, climate change may lead to increased dryness of forage and increased length of the dry season. The implication being that farmers will have to supply more water for their livestock relative to the baseline climate condition as involuntary water intake would have declined due to dryness. In addition, climate change may affect the quantity of water supplied by farmers, as climate change will have an effect on another water source, pans. Therefore climate change could lead to increased pressure on the existing water supply. Overall climate change may affect sustainability of groundwater resources in the Khurutshe area and in the country, in general. Currently localised depletion of aquifers is experienced in summer in some parts of the Kgatleng District and the whole country. With climate change and its effects on cattle water demand this problem may also be experienced in winter seasons and as winter months get warmer.



## Summary

It is clear that water is a scarce resource, in Khurutshe area of the Kgatleng District, particularly surface water. Therefore, it is no coincidence that the livestock and mining sectors are highly dependent of groundwater. Additionally, I discussed problems with expansion of the cattle population, in particular, the potential for depletion of groundwater resources during the summer season. This potential depletion during the summer season has sparked debate on the sustainability of groundwater extraction. As noted, groundwater sustainability is complex due to the uncertainty of recharge rates. Although the livestock sector is dependent on groundwater, pans are also an important source of surface water during the rainy season.

Factors that can determine livestock water demand and supply in semi-arid environments have been discussed. Temperature is a major determinant of daily water intake. During the summer, water demand for livestock increases substantially and leads to local depletion. Though the relationship between climatic variables and livestock water demand has been thoroughly researched, a gap in knowledge exists. For example, the impacts of climate change on livestock water demand is not adequately known. However, as livestock water consumption is dependent on temperature, it is probable that with a warming of the climate there will be an increase in water demand. Secondly, livestock water consumption is a function of forage water content. That is, the more lush the forage the more water will be obtained from that forage. Thus, with climate change (decrease in precipitation and increase in temperature) forage water content could drop and farmers will have to increase the voluntary water intake to compensate for the decline. In addition, climate change is likely to have a negative affect on surface water supply leading to more reliance on borehole water.

A model is required to assess the impacts of climate change on livestock water demand and supply. In this study, I adopt a systems dynamics methodology to assess the impacts of climate change on cattle water demand and supply. In the next chapter I discuss the concept of a system and its dynamics. Emphasis is given

to factors that determine a system's dynamics over time. In addition, the origins of system dynamic modeling are discussed.

## Chapter 4 : System Dynamics Modelling

---

### Introduction

A system is defined by the coupling of its components to fulfill a function. These components give the system its identity and integrity. By their nature, systems are dynamic hence dynamic systems. A dynamic system is one that changes over time. Virtually all systems are dynamic though in some cases it might be difficult to tell. There are four types of behaviour that systems can display: s-growth, oscillation, goal seeking and exponential growth. In addition, these behaviours can either be continuous or discrete over time. Two processes enhance the dynamics and behaviour of a system: output and their influences from a system's environment; and, internal influences of the components of a system. Of the internal influences, feedbacks are the most important and they occupy a central role in a system dynamics approach.

System dynamics is simply a method that uses feedback loops and computer simulation to enhance our understanding of complex non-linear systems. It is a method devised by Jay W. Forrester to understand complex dynamic systems. There are two approaches to system dynamics: qualitative and quantitative. Qualitative system dynamics rely on the use of diagrams (specifically feedback loops and flow diagrams) to qualitatively describe the system and its growth over time. On the other hand, quantitative system dynamics is an extension of the qualitative system dynamics models as it further develops the mathematical relationships of the variables of the system, quantifies the stocks and the flows/rates and uses a computer to simulate a system's behaviour. Simple difference equations are used to describe the dynamics of the system. These methods (quantitative and qualitative system dynamics models) are mutually

exclusive. To develop a quantitative system dynamics model it is a prerequisite to construct the feedback and flow diagrams which are specific to a qualitative system dynamics model. In addition, there are two approaches towards mode construction: feedback loop and modular. A feedback loop identifies the reference mode of behaviour while a modular approach identifies the key variables and links them to form diagrams.

In this study, quantitative system dynamics will be employed to investigate the dynamics of water demand and supply and the impacts of climate change on water demand and supply. The cause of concern in this study is cattle water demand-supply specifically voluntary water demand for beef cattle. Voluntary water demand corresponds to both abstraction of groundwater and consumption from pans.

## **Systems and their structures**

Generally, a system is defined as a group of elements or components interacting and coupling to fulfil a certain function. Virtually, anything that we might think of is a system or a component of a system, *e.g.*, human body where hands, legs, brain *et cetera*, are interacting to carry out different functions; and, cattle grazing where components such as grass, water and livestock are all interacting to perform the functions of meat, wool and milk production. A system gets its identity from its components and their couplings (Coyle, 1996). Moreover, its structure is also determined by these components. A system structure is defined as sets of components and how they are related to each other in giving the system its identity and achieving its functions (Bossel, 1994; Wolstenholme, 1990). Figure 4.1 represents an example of a system structure. Thus, a system's structure determines the system's behaviour.

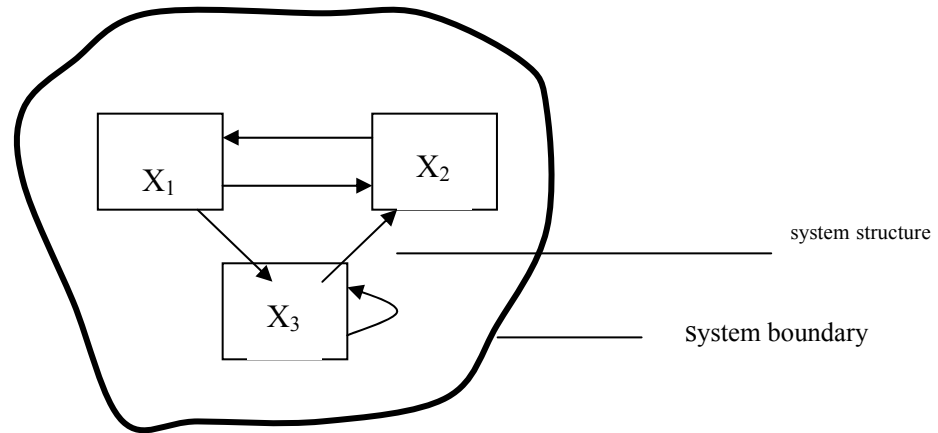

**Figure 4.1: An example of system structure, components, feedbacks and boundary**

A system is recognised and identified by the following general properties (Bossel, 1994; Pilishkin, 2002):

- For a system to be defined, it must have at least one function which is readily observable and recognisable to the investigator;
- It must have a characteristic constellation of elements or components which make its structure and at the same time its function(s), purpose and identity; and,
- If one of the components is removed, it losses both its identity and integrity and can no longer fulfil its function(s).

Cattle grazing is a system with the above highlighted properties. In the first case, it is identifiable and recognised as a system because of its functions. An investigator will readily identify and recognise beef and milk production as a function performed by the livestock grazing system. Secondly, cattle grazing has a group of associated components, which interact to fulfil functions, and also gives it identity. Lastly, if one of the components of a cattle grazing system is removed, either, water, grass or cattle, then the system will no longer be a system. In addition, its identity and functions will be lost.

Systems are diverse and varied in terms of their nature and complexity (Bossel, 1994; Pilishkin, 2002). There are a spectrum from different disciplines ranging from mechanics, physics, ecology, environmental science to social science, *e.g.*, computer, ecosystem, organisational and political systems. In most cases systems are observable because they are physical, but in other cases they are not observable.

Systems can be categorised into two distinct types: input-determined systems or memory-free systems; and state-determined systems. A memory-free system is one that is dependent of the system's earlier state (Bossel, 1994). On the contrary, any system whose past state determines its present state is defined as a state-determined system (Bossel, 1994). Memory-free systems are rare and have no state variables. Cattle grazing as a system falls under a state-determined system.

Generally, a system does not exist in isolation but has a surrounding, which is known as its environment. In most cases the environment will have an effect on the functions of a system and state of the system. Therefore, a system gets its influences both externally and internally, *i.e.*, from the system's environment and internally through the system's components and their interactions (Bossel, 1994). External elements that affect the system from the environment are called exogenous variables. Internal elements are referred to as endogenous variables and they are of particular importance when analysing a system. A system's components can be categorised into state variables and auxiliary variables<sup>22</sup>. State variables are important for the dynamics and behaviour of a system (Bossel, 1994; Roberts *et al.*, 1983). They are important in the sense that if their values and how they behave over time are known, values of other variables can be computed from such changes (Bossel, 1994). State variables are also referred to as storage variables, and they can be categorised into two types: the integrators and the delays.

The behaviour of a system is determined by two sources: mainly external and internal influences, therefore it is imperative to define a boundary between a

---

<sup>22</sup> Auxiliary variables are defined as those variables that lead from the levels/stock to rates or flows.

system and its environment when analysing a system. Defining a boundary between a system and its environment simply helps in determining the system components and its corresponding structure from its environment. In addition, this exercise also determines a system's complexity. A large boundary takes more elements that influence a system and the complexity of a system of interest also increases. For physical systems or mechanical systems this exercise is easy. However, there are challenges encountered with non-physical systems (Wilson, 1981). For instance, it is not difficult to draw the boundary between a livestock system and its environment. Clearly, livestock grazing as a system has more components beyond water, livestock and grass. However, for modelling purposes all components cannot be included, hence the need to define a boundary. Due to the difficulties faced by systems analysts in defining the boundaries between systems and their environment, Bossel (1994:24) gives the following guidelines for drawing the boundary:

- Where the interaction between the system and its environment is much weaker than the internal coupling of the system;
- Where the interaction to the environment is not functionally relevant; and,
- Where the inputs from the environment are not significantly affected by the system.

### **Dynamics of systems**

Wolstenholme (1990) defines dynamics simply as behaviour. Thus, dynamics of a system deals with how the system performs over time. While this may entail behaviour of structure, it may also refer to output of the system without necessarily a change in the structure of the system. Wilson (1981) defines a dynamic system simply as one that incorporates time as one of its factors. In a state-determined system, state variables play important roles in the dynamic of any system (Bossel, 1994). Figure 4.2 depicts a dynamic system.

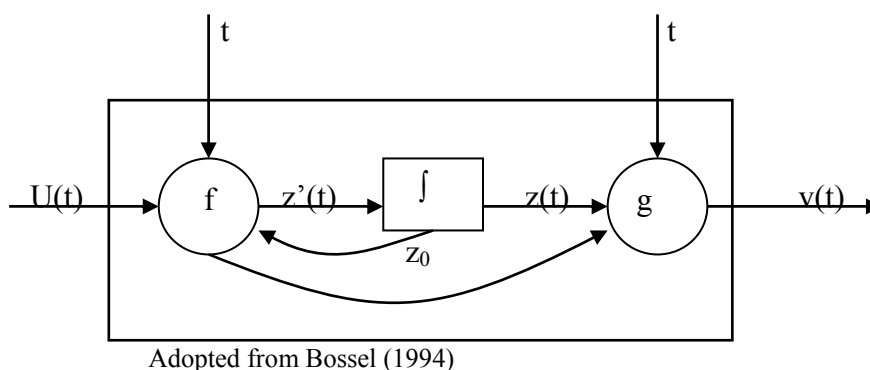

**Figure 4.2: A dynamic system over time**

Where,

$U(t)$  are the inputs from the system's environment;

$v$  are the outputs of the system;

$z$  are the state variables of the system;

$g$  and  $f$  are the functional relationships of the state variables; and,

$t$  is the time.

From Figure 4.2, it is clear that two processes are responsible for the dynamics of a system over time: a system's environment and its inputs; and the interactions of internal components especially feedbacks (Bossel, 1994; Coycle, 1996). The dynamic of a system as a result of feedbacks can be subtle and complex. Wilson (1981) suggests that feedbacks are the most important interactions for the overall behaviour of a system and its dynamics. Moreover, it has been observed that feedbacks have brought much complexity into the analysis of systems even when the structure of the system itself is not complex (Bossel, 1994). This is due to the fact that in most cases an investigator will ignore such subtle coupling especially when using different methods other than system dynamics methods. A feedback in a system occurs when effects from one variable to another variable is transferred back to the original variable in the future (Wolstenholme, 1990). For instance, in Figure 4.1, variable  $X_1$  affects  $X_2$ , in future these effects generated by  $X_1$  are transferred back to  $X_1$ . These effects can be traced as generated by  $X_1$  through  $X_3$  to  $X_2$  and back to  $X_1$ .



A relevant example for this study is that in summer, water demand for cattle increases significantly due to high temperature, this increase leads to an increase in abstraction rates to meet demand. In turn, the increase in abstraction affects water supply leading to a decline in borehole yield. The reaction of the farmers is to reduce the number of days their cattle drink with the aim of conserving water. Thus, over time the effects that originated at demand are transferred back to demand, through a farmer's decision and water conservation efforts. The effects of demand on supply and borehole yield are shown in Figure 4.3 below. Figure 4.3 basically depicts feedback for the cattle water demand-supply during the summer months when the demand increases leading to a decline in borehole yield, to conserve water farmers control the number of times their cattle drink thus affecting water demand. This is especially true in the eastern part of the Kgatleng District.

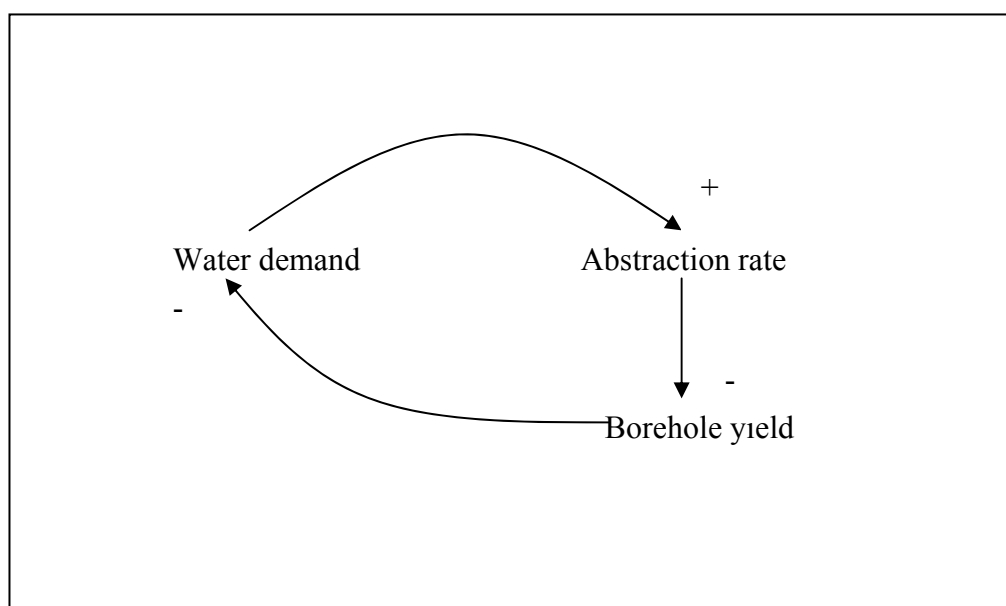
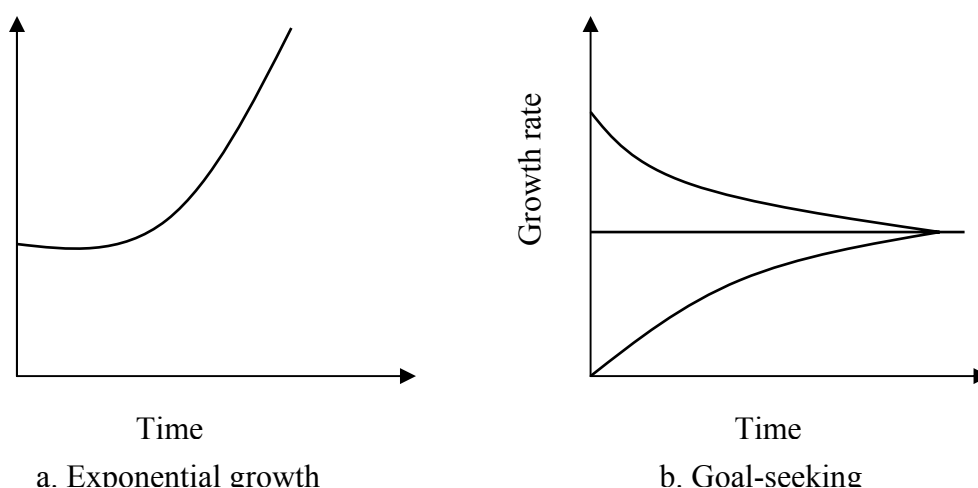

**Figure 4.3: An example of a feedback mechanism.**

There are two types of feedback: positive and negative which pull a system in four different directions of evolution/behaviour: exponential, goal-seeking, s-shaped and oscillation (Kirkwood, 1998). Figure 4.4 and Figure 4.5 depict different behaviour that a system can take over time. In addition to the listed types of behaviour a system can also display either a continuous or a discrete behaviour. A positive feedback is when the effects are amplified and it is responsible for

reinforced or decay growth such as exponential growth (Figure 4.4a). The number of negative polarities determines the types of feedback in any feedback loop. A positive feedback loop has an even number of negative polarities and odd number for a negative feedback loop. Positive feedbacks are associated with the vicious cycle famously known as a Catch 22 (Bossel, 1994). Conversely, a degenerated positive feedback results in an exponential decay (Bossel, 1994). Negative feedback is when effects are dampened. It is associated with a balancing growth such as goal-seeking or target growth (Figure 4.4b) (Bossel, 1994; Kirkwood, 1998; Wilson, 1981). According to Wilson (1981) stable equilibriums achieved by negative feedback are termed *homeostatic*.

An s-shaped behaviour is a result of a combination of both positive and negative feedbacks. With accelerated growth, it shows the dominance of a positive feedback and a shift to a negative feedback leading to a goal-seeking or target behaviour (Figure 4.5a). On the other hand, oscillation displaces some target or goal seeking behaviour and therefore has a dominance of negative feedback throughout its evolution (Figure 4.5b).



**Figure 4.4: Examples of exponential and goal seeking behaviour.**

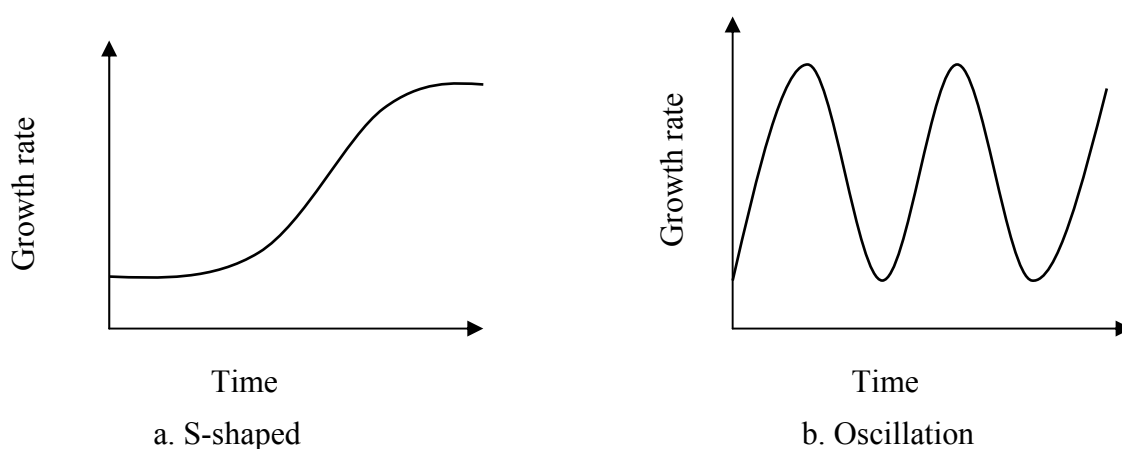

**Figure 4.5: Examples of s-shaped and oscillation behaviour.**

### **Dynamics of cattle water demand and supply**

To develop a system dynamic for a cattle water system, in this study I intend to adopt the modular approach to feedback loops and causal diagram construction. The approach defines the cause of concern, which in this case is voluntary cattle water demand. Therefore, to analyse the impacts of climate change on cattle water consumption a distinction is made between free water intake provided by farmers and water derived from other sources, specifically forage water content and free water intake provided by pans during the rainy seasons. Free water intake provided by farmers corresponds exactly to groundwater abstraction. Free water intake provided either by farmers or pans and water obtained from other sources equals the daily water requirement. A daily water requirement is defined as the total quantity of water required by livestock for their metabolic processes as well as for the heat regulation of their body. Forage water content and pan water are vital sources of water for a livestock grazing system. Therefore due to the seasonal variations and the effects on availability of pan water and forage water content, abstraction of groundwater is anticipated to oscillate as in Figure 4.6.

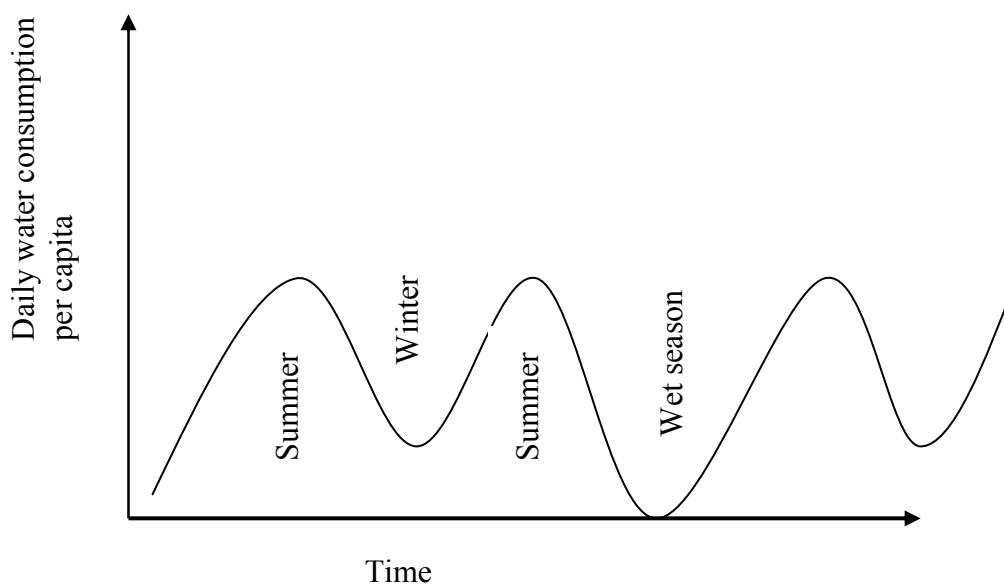

**Figure 4.6: Voluntary per capita water demand for cattle for different months.**

### **System dynamic approach**

There are numerous and diverse definitions of system dynamics. In this study I adopt Wolstenholme's definition. He defines system dynamics as "a rigorous method for qualitative description, exploration and analysis of complex systems in terms of their processes, information, organisational boundaries and strategies; which facilitates quantitative simulation modelling and analysis for the design of system structure and control"(Wolstenhome, 1990:3). From this definition it can be deduced that system dynamics is an approach that uses both diagrams and quantitative methods which combines mathematical relationships and computer simulations to simulate the dynamics of a system. It is an approach that is concerned with developing models for systems, studying them and improving our understanding of their behaviour. System dynamics evolved due to a deficiency of available models to solve complex problems (Bossel, 1994; Honggang, 2003; Satsangi *et al.*, 2003). It is a modelling approach that has been developed specifically for non-linear, dynamic and complex systems (Coyle, 2000; Schieritz and Milling, undated; Wu and Vankat, 1991). The method has a long history of application in complex systems and decision making (Cole *et al.*, 1973 and 1973b; Forrester, 1961; Roberts *et al.*, 1983; Wilson, 1981).

The method evolved over 40 years as a tool for solving complex causal relationships (Kirkwood, 1998). But with the evolution of computers, the methodology has gained popularity (Roberts *et al.*, 1983). For instances, Satsangi *et al.*, (2003) used system dynamics specifically because other available methods did not provide long-term sustainable solutions to India's urban decay problems. Honggang (2003); Schieritz and Milling (undated) highlight that system dynamics have been used exclusively for solving complex systems with feedbacks. In fact, feedbacks are at the core of system dynamics or rather emphasis is placed solely on feedbacks, as they are responsible for complex and unpredictable behaviour of systems when perturbed (Wolstenholme, 1990).

Generally, feedbacks make the behaviour of the system illusive. Moxnes (2000) studied stocking rates and harvesting rates in common and private property regimes. In all regimes he found that participants tended to overstock and over-harvest. His conclusion was that common property and the tragedy of the commons is not to blame for these unsustainable practices but it is misperceptions of feedbacks, which lead to overstocking and harvesting. Because of the presence of feedbacks, farmers and fishermen react late in reducing their stocking rates and their harvest rates, respectively. Analysis of feedbacks enhances human understanding of systems (Bossel, 1994; Wolstenholme, 1990). Instead of analysing a system piecemeal, system dynamic takes a holistic approach, which gives the modeller a much broader perspective of the system. In addition, system dynamics promotes investigating the internal structure of the system when there is a peculiar behaviour rather than focusing on the external forces (Bossel, 1994; Wolstenholme, 1990).

According to Wolstenholme (1990:3) there are two factors that make system dynamics attractive as opposed to other approaches and methods. Firstly, its ability to develop structures which are informative; "Spotting isomorphism which others do not is often considered as the key to real intelligence and system dynamics provides a way of developing these skills". Secondly, is the ability to highlight salient behaviour of a system when a new strategy or policy is implemented. In most cases, policies are implemented with the assumption that a system will behave in a certain way. However, policy makers may sometimes be

taken by surprise hence, the advantage of system dynamics in avoiding unexpected behaviour from systems.

There are generally seven stages that are adopted in system dynamics in studying, understanding and solving complex system problems (Coyle, 1996; Moffatt, 1991). However, when using qualitative system dynamics, there are only three stages. They are summarised diagrammatically in Figure 4.7 for both qualitative and quantitative system dynamics.

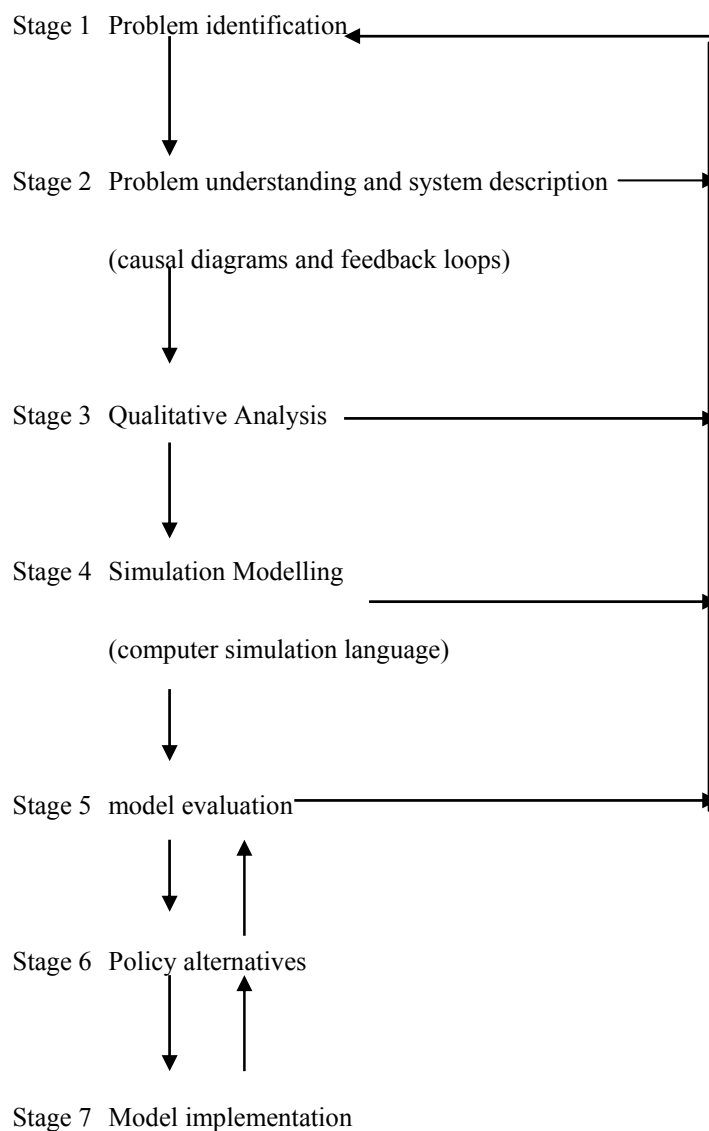

**Figure 4.7: Stages in system dynamic modelling**

Adapted from Coyle, 1996 and Moffatt, 1991

## Types of System Dynamics Methods

As pointed out in the introductory chapter, there are two types of system dynamics: the qualitative and quantitative (Coyle, 1996; Coyle, 2000; Cresswell *et al.*, 2002; Luna-Reyes and Andersen, 2003; Richardson, 1986; Richardson, 1996; Wolstenholme, 1990). While a qualitative method can be used as a final method in the analysis of the dynamics and behaviour of a system, it can also be used as a step towards the ultimate construction of quantitative system dynamics (Coyle, 2000; Wolstenholme, 1990). In this study, I use a quantitative method. The quantitative approach cannot be achieved without constructing feedback loops and causal diagrams, which is fundamentally a qualitative system dynamics model. Roberts *et al.*, (1983) point out that causal diagrams are fundamental to computer simulation and problem solving. Qualitative system dynamics is basically construction of the feedback loops and the causal diagrams and then the application of them to describe the dynamics of a system. While Coyle (1996:12) remarks that “the influence diagrams and the simulation models are simply two versions of the same model; one written in arrows and words, the other in equations and computer code”. Construction of a qualitative model can be achieved in two ways through feedback loops and a modular approach.

### The feedback loop and modular approaches

When using the feedback loop it is imperative to have knowledge on the reference mode of behaviour of the system (Wolstenholme, 1990). As each mode of behaviour is associated with certain types of feedback, the identified mode of behaviour of a system will enable a researcher to determine the likely feedback loops that the system structure is composed of (Wolstenholme, 1990). The feedback loop approach relies on identifying as many feedback loops as possible and linking them to explain the defined mode of behaviour of a system. After

identification of the feedback loops, variables, stock<sup>23</sup>, flows<sup>24</sup> and other auxiliary variables are identified and the feedback loop is labelled.

A modular approach is the antithesis of a feedback loop approach (Wolstenholme, 1990). Identification of key variables to the cause of either the peculiar behaviour or cause of concern is the starting point (Wolstenholme, 1990). From this point the initial state of each system element is identified and linked to the flow for each stock (Wolstenholme, 1990). Other key elements of the structure such as delays and information, can be superimposed leading to a comprehensive depiction of the system.

### Qualitative system dynamics method

If qualitative system dynamics modelling, also known as diagramming, is used then the developed feedback loops can assess qualitative system behaviour. This is basically just like story telling without putting values on variables and their changes. According to Wolstenholme (1990: 29) this is achieved by “identifying major information feedback loops and tracing out the effects to specific rate variables of the loops”. The development of system dynamics models is an iterative process (Luna-Reyes and Andersen, 2003; Skraba *et al.*, 2003). Qualitative system dynamics stops short of the process of quantification and computer simulation of the interactions of the mathematical system dynamics (Luna-Reyes and Andersen, 2003). To validate the model, the behaviour obtained from the model is compared with the reference mode of behaviour. In building feedback loops the following guidelines are given by Wostenholme (1990):

- Stock should depend on flows only and not other level nor auxiliaries;
- Flows should depend on the information from auxiliaries and other level and not on other flows; and,
- A feedback must contain at least one stock and flow.

---

<sup>23</sup> Stock and levels are used interchangeably in this study.

<sup>24</sup> Flow and rate are also used interchangeably.



There are mixed reactions on the use of feedback loops (qualitative system dynamics). Wolstenholme (1990, 1992) argues that model building does not necessary have to lead to quantification and simulation. Moreover, he supports this by pointing out that quantification and simulation will either break or enhance our understanding of a system's behaviour. Coyle (2000) supports qualitative system dynamics by arguing that the method can be very useful and that in some cases quantification can be misleading if it is used beyond its limits. In addition, problems inherited in the quantification of qualitative variables have led to the conceptualisation of qualitative system dynamics (Luna-Reyes and Andersen, 2003) especially non-quantifiable or soft variables. These problems as pointed out by Coyle (2000:226) can be "fraught with so many uncertainties that the model's output could be so misleading that the policy inference drawn from them might be illusory".

However, there are those who are sceptical and cautious about the use of feedback loop diagrams as system dynamic method to describe the interaction and explain system behaviour. For instance, Richardson (1986:158) argue that "yet even those who advocate the use of qualitative system dynamics are careful to point out that in all the successful applications of such qualitative methods the analysts have had extensive experience with formal model building". Coyle (2000) notes that over the last 15 years that qualitative models have emerged, they have been heavily criticised. Comments from some authors have been that system dynamics without quantified simulation is an oxymoron and has called it 'system dynamic lite' (Coyle, 2000).

An element of caution arises from the fact that there are problems with causal-loop diagrams, which are used as final tools in a qualitative approach (Richardson, 1986). The problem results from the apparent non-distinction that is made between information links and flow-to-stock. The non-distinction between information links and flow-to-stock gives rise to inconsistency when defining the positive and negative causal loops. To show the inconsistency and problems that may arise when using the qualitative system dynamics, Richardson (1986) commences by defining a positive polarity. Richardson (1986:159) defines a positive polarity as "a change in the variable at the end of the arrow will cause a

change in the variable at the top of the arrow in the same direction”. To show the inconsistency, he gives an example of population and birth rates. An increase in the birth rate will lead to an increase in the population in the same direction. Using the same definition, it goes without saying that a decrease in birth rates will result in a decrease in population. This however is wrong, as birth rates never result in a decrease in population, a decrease in birth rate can only mean a slow growing population. Another example is that of water in a glass and water flowing in it. By the same token, a plus at the end of the arrow will indicate that the relationship between water flow and water in a glass is positive. However, a decrease in water flow to the stock of water in a glass will not result in a decrease in stock of water in the glass which will be indicated by the causal loop diagram.

According to Richardson (1986) the example listed above is inconsistent with the definitions of positive and negative links because they represent flow-to-stock connection while the definitions only represent information links. The other problems that arise from causal loop diagrams are hidden loops and net rates (Richardson, 1986). His conclusion is that “the simplicity of causal-loop diagrams hides a subtlety, however, which poses problems which have not been adequately acknowledged” (Richardson, 1986:159). Thus, when using the qualitative system dynamics, which relies solely on diagrams, a mix up on the flow-to-stock connections and information links might lead to misinterpretations of the system’s behaviour. In conclusion, Bossel (1994) argues that influence diagrams only allows qualitative conclusions about the system and its dynamics, but he argues that qualitative conclusions are not enough and reliable in understanding the system’s behaviour over time. Thus, he argues that using qualitative system dynamics is not enough in understanding the dynamics of the system over time.

### **Quantitative system dynamics**

Quantitative system dynamics has dominated since the inception of the system dynamic concept by Jay Forrester in 1961. For instance, see Coyle (2000) on the applications of system dynamic models and application. The reason for this dominance is simply put by Coyle (2000:225) as “a cardinal point in this *genre* was that the dynamics of a system cannot be inferred simply by reasoning from an

influence or causal loop diagram and that quantified simulation is the *sine qua non* of policy analysis". In addition, the dominance may be explained by the fact that quantitative system dynamics is superior to the qualitative model in terms of being informative, analytical and more insightful to the problem (Coyle, 2000).

The quantitative system dynamics model is an extension of the qualitative model, in that values are given to the variables in the causal diagrams. This process is simply called quantification. However, before variables are quantified, it is essential to categorise variables into stocks/levels and flow/rates. This is then followed by formulation of the mathematical functional relationships between levels, rates and auxiliary variables as depicted in the diagrams. For the computer to simulate the behaviour of the systems the relationships have to be translated into a computer language. Quantification is riddled with problems especially quantifying the non-quantifiable variable as argued by Coyle (2000). Another problem highlighted by Wolstenholme (1990) is in developing the equations for the auxiliary and rate variables. However, it is emphasised that all aspects of a model must be quantified as much as possible even using normative scale because simulating behaviour is not based on individual components but all components (Wolstenholme, 1990). Roberts *et al.*, (1983) summarises the steps of a full quantitative system dynamic model as: formulate a causal-loop diagram, followed by a flow diagram, translation of flow diagrams into equations and using the equations to simulate the model on the computer.

System dynamics is based on integration (Schieritz and Milling, undated; Wolstenholme, 1990). Thus, to estimate an accumulation of a stock over time, the area under the curve of the flow or rate is calculated as an integration of flows over time. Figure 4.8 depicts accumulation of a stock over time. Mathematically assuming the stock to be  $x$ , its change over time can be represented by Equation 4.1.

$$x = x_0 + \int_0^t (dx / dt) dt \quad \text{[Equation 4.1]}$$

Where,

$x$  is the stock variable;

$x_0$  is the initial stock in time 0; and,  
 $t$  is the time.

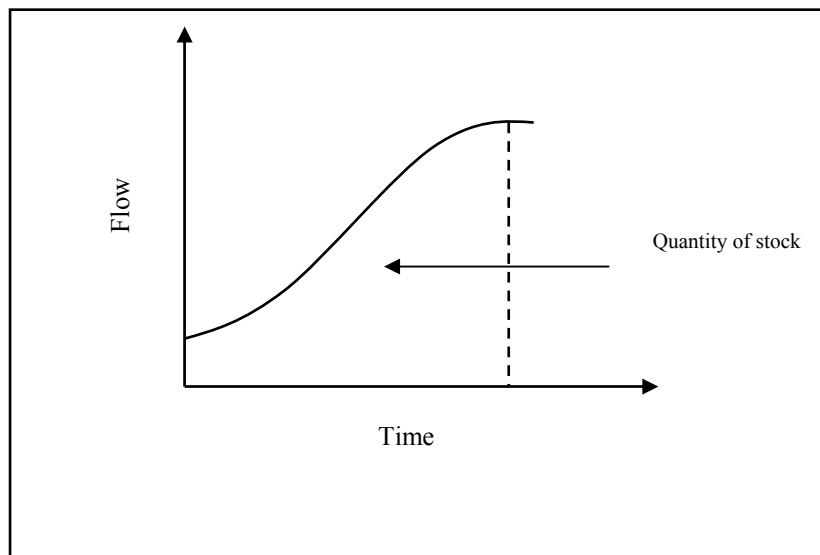

**Figure 4.8: Quantity of stock over time.**

According to Wolstenholme (1990), a rate accumulating into a flow over time occupies a central role in system dynamics simulation. Thus, the laws of construction of diagrams and the computational sequences used in system dynamics simulation all depend on the transferral process (Wolstenholme, 1990). It can be recalled that in addition to the four types of behaviour that can be displaced by a system, there is also continuous and discrete behaviour. Thus, system dynamics adopts the continuous behaviour and uses simple difference equations rather than differential equations to represent the accumulation of stock from rates. A rate of change for stock  $X$  variable is expressed by both difference equation and differential equations as shown in Equation 4.2.

$$\frac{\partial X}{\partial t} \quad \text{and} \quad \frac{\Delta X}{\Delta t} \quad \text{respectively.} \quad \text{[Equation 4.2]}$$

## Time factor and system dynamic equations

A time factor is crucial in system dynamic simulation. Variables such as stocks and rates occur at a point in time and therefore they are dependent on the time factor (Coyle, 1996; Wolstenholme, 1990). The amount for accumulation of stock from rates is a function of time. In system dynamics, there are three particular points of time of interest: the past, J; present, K; and, the future, L (Coyle, 1996; Moffatt, 1991; Wolstenholme, 1990). Wolstenholme (1990) graphically shows the reference point of time of interests as in Figure 4.9.

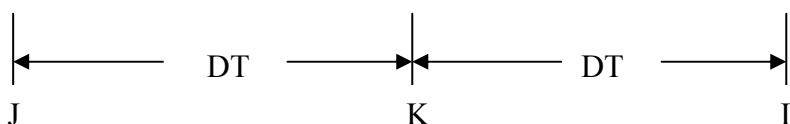

**Figure 4.9: Time steps in simulating.**

DT is the simulation interval time and it is very small (Coyle, 1996). Coyle (1996) advises on the criteria for selecting the value of DT. Generally DT can take any value from the smallest to the largest. But he cautions that “if DT is too small, time will be wasted waiting for the models to run. If it is too large, numerical instability may occur which means that dynamics in the model may be due to errors of calculation, not to the dynamics of the system”(Coyle 1996:109). His formula for calculating the desirable DT is as shown in Equation 4.3.

$$DT \leq \frac{DEL}{4 * ORDER} \quad \text{[Equation 4.3]}$$

Where,

DT is the simulation time steps;

DEL is the magnitude of delay; and,

ORDER is the number of delays

In addition, Wolstenholme (1990) advises that DT should be specified as a binary function to avoid instability in the model.

The step from the past to the present is labelled JK and likewise KL for movement between present, K and the future, L (Coyle, 1996; Wolstenholme, 1990). Labelling of the level is in reference to important time points, thus, a level is referred in time as LEVEL.J, LEVEL.K or LEVEL.L depending on the time of interest. On the other hand, flows or rates are labelled not at a point in time but with respect to the simulation interval, DT. Thus, a flow from past to present and present to future would be labelled RATE.JK and RATE.KL respectively (Coyle, 1996). Labelling is fundamental and the basis for writing system dynamic equations. To distinguish between a level and rate equation, a letter L for level and R for rate are written immediately to indicate the nature of the variable as depicted in Equation 4.4.

$$LLevel.K = Level.J + DT * rate.JK \quad \text{[Equation 4.4]}$$

The interpretation of the equation is that the present quantity of the particular level of interest, is the previous amount in period J plus the amount that has flowed in between the past J and the present, K multiplied by the time DT. State equations must be dimensionally consistent (Bossel, 1994; Coyle, 1996). Dimensional consistency is satisfied when the units of measurement are the same on both sides of the equation (Coyle, 1996). The need for dimensional consistency arises from the fact that it helps in determining the correct conversion factors and also helps in formulating correct model statements and equations (Bossel, 1994). It is pointed out that dimensional disagreement indicates errors in the model formulations (Bossel, 1994).

Equation 4.5 represents a rate.

$$RRate.KL = f(level.K, Auxillary.K, Parameters) \quad \text{[Equation 4.5]}$$

Once again, the equation starts by defining the nature of the variable R for rates. A rate in time DT is a function of the level in time K, the auxiliary variables in time

K and parameters. According to Coyle (1996), in the rate equation past conditions are being used to show that future changes are generated by present conditions.

## **Delays and information smoothing in system dynamics**

Delays are part of systems and therefore crucial in system dynamics modelling. In fact, Wolstenholme (1992) states that it contributes to the dynamics of a system. Delay can be defined as when state variables (levels) are stored in a system for a given period of time (t) and released at a later time (t+1). For this reason Wolstenholme (1990) refers to delays as hidden levels. According to Bossel (1994) there are two types of delays: the transport delay and smoothing delay. Transport delay basically deals with transport while smoothing delay refers to a situation when a company receives goods and releases them at a lower rate to achieve a steady flow of stock (Bossel, 1994). This is to achieve smooth information outflow.

## **STELLA software**

STELLA software is used to simulate the interaction of the system's components and assess the impacts of changes in temperatures and rainfall (due to climate change) on cattle water demand and supply. In addition, the software is used to assess how the sustainability of a livestock system, dependent on groundwater, is affected by climate change. STELLA is an object-oriented programme which differs yet, has some similarities with traditional programming languages (Palmer, undated). It is different because it is built using object icons instead of writing instructions using computer language (Palmer, undated). However, it is similar as the functional relationships must be defined just like in traditional programmes such as FORTRAN. Objects are linked by connectors and a functional relationship is written. Compared to other modelling softwares, STELLA as an object-oriented programme is advantageous as it is easy to use and therefore enhances the speed of model development. Secondly, the results are easily presented and communised.

## Summary

In this chapter I discussed the system dynamics model as a methodological approach to the study of cattle water demand and supply. There are two system dynamics approaches: qualitative and quantitative. From the literature review, it is apparent that quantitative system dynamics is an extension of the qualitative. It extends the qualitative approach by developing functional mathematical relationships between variables and through simulation. In this study, I have selected quantitative over qualitative system dynamics as it is more informative. Moreover, all the variables I have used are quantifiable.

I discussed the system and its dynamics over time. The behaviour and dynamics of the system stem from external and internal factors. Internal factors arise from feedbacks: both positive and negative. The presence of feedback in the system results in complex behaviour that can only be explained and simulated through the incorporation of a system dynamics method. STELLA software is used to simulate the interactions of the cattle water demand and supply components. STELLA is an object-oriented programme.

One must compute climate scenarios for rainfall and temperature to assess the impacts of climate change on cattle water demand and supply. Climate scenarios are then used to perturb the cattle water model with the results being indicative of the impacts of climate change. Therefore, in the following chapter I discuss climate scenarios, their applicability for impact assessment studies, and lastly, I compute climate scenarios for the study area. In chapter 5 and 6 I discuss components of the cattle water demand and supply model: pans and their formations; and forage water content, respectively. The components of the cattle water demand and supply model are discussed in chapters 5, 6 and 7 as presented in Figure 4.10.



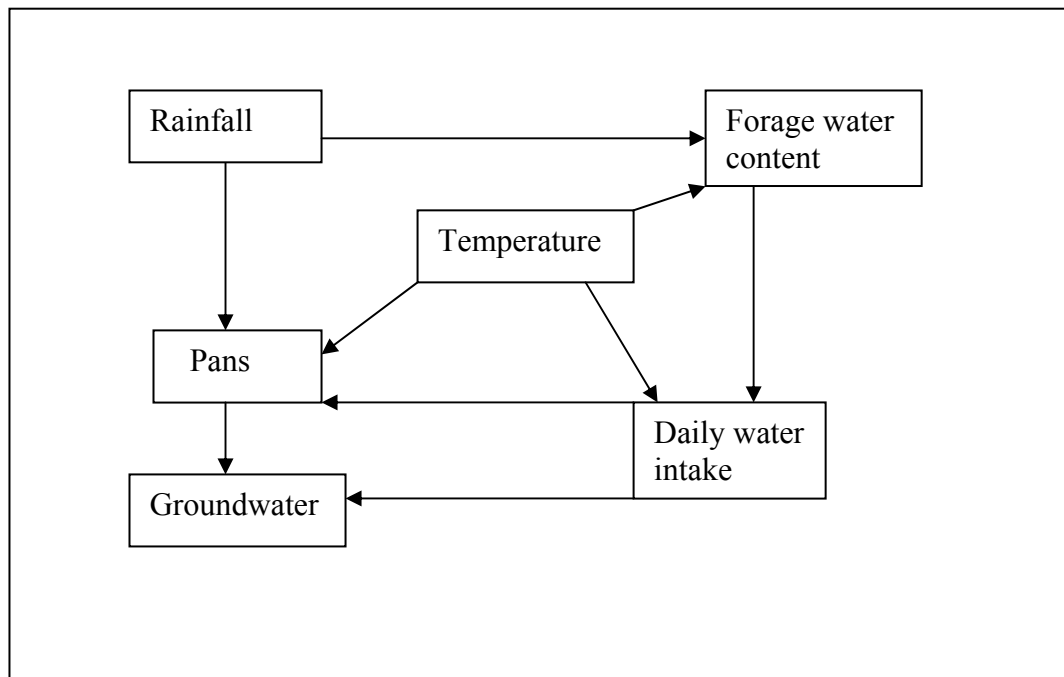

**Figure 4.10: Components of cattle water demand-supply.**

## Chapter 5 : Climate Scenarios and Impact Assessment Studies

---

### Introduction

Climate scenarios occupy a central and significant role in climate change impact, vulnerability and adaptation assessment studies. Their evolution can be traced from early debates on global warming. Therefore, it is not coincidental that with greenhouse gas (hereafter GHGs) emissions and global warming being debated, climate scenarios have also been extensively researched and widely applied. It is for this reason that this chapter is devoted to climate change and scenarios. In this study, temperature and rainfall scenarios are of primary importance. These variables directly influence cattle water demand-supply, thus they are the drivers of the system dynamic model for the Khurutshe cattle water system in the Kgatleng District. There are three main ways in which rainfall and temperature scenarios can be constructed: incremental, analogue and from GCMs. GCMs are the most intensively used of the three methods, therefore in this study I will employ them in assessing the impacts of climate change on livestock water demand and supply.

Scenarios are at the heart of climate change impact studies as they define the exposure unit<sup>25</sup> of the system to climate change. IPCC (2001) traced the evolution of climate scenarios back to 1965 when there was a debate on aircraft and global cooling. Simple incremental scenarios, one of the methods pointed out above (to be discussed under types of climate scenarios) were devised to assess the impacts

---

<sup>25</sup> Exposure unit is defined by IPCC (2001) as an activity, group, region or a resource that is exposed to climate change and variations.

of aircraft on global climate. With increased GHG emissions and accumulation of GHGs in the atmosphere and the resultant global warming, the need for climate scenarios has increased tremendously (Hellstrom and Chen, 2003). In this study two GCMs (HadCM3 and CSIRO Mk2) output and three SRES emission scenarios are used in SimCLIM to construct climate scenarios for the study area for 2050. Lastly, baseline data is an essential part of climate scenarios, thus the changes as a result of GHGs are used together with baseline data to construct climate scenarios for 2050. Baseline data for temperature and rainfall covers 30 years from 1960 to 1990 obtained from the Department of Meteorology.

### **Climate scenarios and uses in climate change studies**

A survey of the literature reveals that there is only one commonly used definition of scenario adopted from IPCC (1994). It defines scenario as a “coherent, internally consistent and plausible description of a possible future state of the world” (IPCC, 2001:148).

The need for consistency may explain the IPCC’s adoption of a single definition of scenario. If there were many definitions, it would be difficult to construct scenarios that were consistent and hence comparable. Even with one agreed definition of a scenario, skepticism and doubts have been raised with regard to consistency in scenario computation and application. Even though the scenario definition was adopted by the IPCC technical team in 1994, many of the climate change assessment studies have not complied with this definition (IPCC, 2001; PARC, 2001). The reports (IPCC, 2001; PARC, 2001) further remark that due to the inconsistency on the development and application of scenarios, especially climate scenarios, it has been difficult to draw conclusions and compare results from similar climate change impact studies.

By scenarios being internally consistent, it means that relationships between variables of interest such as meteorological variables should affect one another in a logically consistent manner (Smith *et al.*, 1998). PARC (2001) gives

precipitation as reflected in the cloud/radiation value as an example of internally consistent variables.

In addition to internal consistency, scenarios should also be aligned with the physical law, meaning that “they should not violate the basic laws of physics” (Smith *et al.*, 1998: p.3-4). Moreover, climate scenarios should be consistent with IPCC projections of global warming of ranges 1.0 – 3.5°C by 2100 or 1.5 – 4.5°C with a doubling of CO<sub>2</sub> (PARC, 2001). Lastly, scenarios should describe relationships between changes that are physically plausible.

Scenarios describe how the future unfolds (IPCC-TGCIA, 1999, McCarthy *et al.*, 2001). It is strongly advised and cautioned that a scenario should be used as a description of the future but not a forecast, or prediction of future climate change (IPCC, 1994, 2001; Smith *et al.*, 1998). Yet projections are an important part of scenario computation. Projections are used as input in the computation of scenarios. In addition, baseline conditions are also required to compute climate scenarios (IPCC, 2001). A clear example where projections serve as raw material towards the ultimate construction of a scenario is the emissions of GHGs.

There are different types of scenarios and the potential list is inexhaustible, as they depend on the discipline of the study. IPCC (2001) gave a list of climate scenarios. Some of the types of scenarios listed by IPCC (2001) are: socio-economic; land use and land cover; environmental; climate and climate change; emission; and sea level rise. For this study, climate, climate change and GHGs emission scenarios are of paramount importance. Though climate change and climate scenarios are used interchangeably there is a distinction between the two. For instance, IPCC (2001) makes a clear distinction between climate change and climate scenarios. They define climate scenarios as “a description of the response of the climate system to a scenario of GHG and aerosols emissions” (IPCC, 2001:743), while climate change scenarios are defined as plausible future climate. A climate change scenario is part of a climate scenario. Computation of a climate scenario, involves combining current observable (baseline data) and a climate change scenario (IPCC 1998, 2001). In most climate change literature, climate change and climate scenario terminology is used interchangeably (IPCC, 2001).

Though, climate and climate change scenarios are of particular reference to this study, this does not mean that other types of scenarios are not important. IPCC (2001) remarks that other types of scenarios are equally important. For instance, socio-economic scenarios play various roles in the climate impacts, adaptation and vulnerability studies (McCarthy *et al.*, 2001). In the past, socio-economic scenarios have been used extensively on the basis for projecting GHG emissions. Nowadays they are also used to establish baseline socioeconomic vulnerability and to assess climate change impacts on economic activities and post-adaptation vulnerability (IPCC, 2001).

In assessing the impacts of climate change on cattle water demand and supply, scenarios of future water resources, water availability, cattle population and water policies are all needed as they describe the exposure unit to change. In addition, baseline data such as availability of groundwater and surface water are important in this study. Thus climate scenarios are used as inputs in the cattle water model. As pointed out, they are the driving variables for the model.

### **Uses of scenarios in assessments studies**

Scenarios have various purposes in impact assessment studies. Firstly, they are used to describe emission of GHGs and the resultant concentration of GHGs. Secondly; they are used to convert concentrations into radiative forcing (IPCC, 2001; Mitchell *et al.*, 1999; Smith *et al.*, 1998). Thirdly, scenarios are required in climate change impact, and vulnerability assessments to give alternative options of future conditions considered likely to influence a given system or activity (IPCC, 2001). Thus, scenarios describe the future state of the activity that will be exposed to change and impacts and reflects the dynamics of the system. Emission scenarios for CO<sub>2</sub> and other GHGs are used to predict future global climate change. Thus, concentrations of these GHGs, which are used to calculate their radiative<sup>26</sup> forcing and resultant warming of atmospheric temperature are based on

---

<sup>26</sup> Radiative forcing is defined as “the change in the net vertical irradiance (expressed in Watts per square meter (Wm<sup>-2</sup>) at the tropopause due to an internal change in the external forcing of the climate system, such as a change in the concentration of CO<sub>2</sub> or the output of the sun. Usually radiative forcing is computed after allowing for stratospheric temperatures to readjust to radiative

emission scenarios. Hulme and Viner (1998) remark that the Model for the Assessment of Greenhouse Gas-Induced Climate Change (MAGICC) gives internally consistent estimates of global mean temperature based on anthropogenic emissions of GHGs. The radiative forcing of these gases result in global warming. According to Hulme and Viner (1998) emissions scenarios for GHGs are critical for predicting future climate change.

Smith *et al.*, (1998) and Smith and Pitts (1997) elaborate on the importance of climate change scenarios in assessment studies. They argue that choice of climate change scenarios will greatly influence the outcome of climate change impacts. This is because scenarios are used as inputs. Just like in any production process, where output is determined by inputs, output from climate impact assessment studies are determined by scenarios as inputs. Thus, extreme scenarios will produce extreme results while moderate scenarios will produce moderate results (IPCC, 2001; Mitchell *et al.* 1999; Smith *et al.*, 1998).

Scenarios are used in climate change impact assessment studies because of a lack of knowledge of the predictive power of climate change models. According to Hulme and Viner (1998:145) “regional climate change predictions, in the sense of being able to attach probabilities to the outcomes of climate model experiments, is not yet possible. It may yet be several years before model development and computing power reaches a stage when prediction defined in this way is achievable”. The same sentiments are reflected by IPCC (1996) and (2001), Smith and Pitts (1997). They argue that scenarios are the only tools that could be used for the assessment of future implications of changes in complex climate change systems. They are not sufficiently understood, thus, there is high uncertainty. Due to the constraint in the predictive power of the climate models, climate change scenarios are used as inputs to model the impacts of future climate change. However, as pointed out, they are not used to predict the future climate but as descriptive tools of the future as it is not yet possible to predict with certainty the impacts of climate change. IPCC (2001) argue that the true purpose of climate scenarios is to illuminate uncertainty.

---

equilibrium, but with all tropospheric properties held fixed at their unperturbed values”(IPCC 2001:992).

## Uncertainty in scenarios

As noted, climate scenarios were devised to overcome the problem of lack of predictive power of existing climate models. However, climate scenarios have their own problems in terms of uncertainty. Mitchell *et al.*, (1999), IPCC (2001); highlight the following sources of uncertainties:

- future emission of GHGs and their atmospheric concentrations;
- uncertainties in converting concentration to radiative forcing which is used to calculate increase in global or regional temperature;
- even if emissions and their resultant concentration could be perfectly projected, there is still imperfect and incomplete knowledge on the radiative forcing of the GHG and the aerosols;
- conversion of model responses into inputs for impacts studies; and,
- the accuracy of the prediction is further limited by the natural climate variability.

Uncertainty is inherent in assessment studies that have a long time horizon. Generally, with an increased time horizon uncertainty increases. However, various methods have been devised to reduce and limit the level of uncertainty. IPCC (2001), Mitchell *et al.*, (1999), Smith and Pitts (1997) have covered these methods. Smith and Pitts (1997) recommend that the U.S. Country Studies Program use more than one type of climate scenario for their impact studies as a way of limiting uncertainty. They also suggest that in selecting climate change scenarios, among other features “scenarios selected should reflect a regional range of potential climate changes. The scenarios should account for uncertainty about the direction and magnitude of change in such meteorological variables as temperature and precipitation” (Smith and Pitts 1997:5). Other authors also advise on use of a range of scenarios to reflect uncertainty (IPCC, 2001; McCarthy *et al.*, 2001; Smith *et al.*, 1998). McCarthy *et al.*, (2001) advise that to reduce uncertainty in climate scenarios obtained from the GCMs output, all the available GCM results should be used. The procedure for using all available selected GCMs

output is that, they are averaged and the average is applied to the baseline data. Averaging the results has an advantage in that it reduced the noise due to natural variability (IPCC, 2001). Results from GCM can also be pattern scaled<sup>27</sup> to increase confidence in the use of climate change scenarios.

The selection of scenarios as inputs in assessment studies should satisfy certain criteria (see IPCC, 2001; PARC, 2001; Smith and Pitts, 1997 for detailed discussion). Some of the identified criteria include:

- They should be easy to obtain, their interpretations and applications should be simple and straightforward;
- They should be physically plausible and internally consistent;
- They should estimate a sufficient number of climate variables on both spatial and temporal scale that should allow for impact assessments;
- They should be consistent with widely accepted global estimates of climate change for instance, for 2xCO<sub>2</sub> their estimate of global temperature increase to fall in the range of 1-3.5°C by 2100 (IPCC, 2001);
- They should also reflect a regional range of potential climate change; and,
- They should be representative of the range of uncertainty of projections.

## Construction of climate scenarios

Central to climate scenarios computation are baseline conditions and emissions of GHGs. There are essentially five steps towards climate scenario construction:

- Identification of the baseline construction;
- Construction of GHGs emission scenario;
- Conversion of GHG concentration into radiative forcing;

---

<sup>27</sup> Pattern scaling is described by Mitchell (2003:220) as an attempt to estimate the anomaly in a variable (V) for a particular grid box (i), month or season (j) and year or period (y) that would be obtained if a GCM was forced under a selected forcing scenario (x). The estimated (V\*) is the product of the scalar (S) and the response pattern (V')

$$V^*_{xijy} = S_{xy} \cdot V'_{zij}$$

z is a different forcing scenario.



- Perturbing climate under different radiative forcings (i.e., forcing the GCM at different level); and,
- Computing the climate scenarios by either taking the difference or the ratios between current baseline climate conditions and future conditions and applying the results to the observational meteorological variable.

### **Baseline conditions and climate change scenarios**

Baseline conditions are at the core of climate scenarios and impacts studies. There are two types of baseline conditions: current and future. Current baseline conditions generally refer to the present observable conditions (IPCC, 2001; Santoso, 2003; Smith *et al.*, 1998). They could either be socio-economic, environmental and obviously climatological baselines. A future baseline describes the anticipated future changes in conditions regardless of climate change (Carter *et al.*, 1999; McCarthy *et al.*, 2001; Smith *et al.*, 1998). Particularly relevant to climate change scenarios construction are the current baselines. Current climate baseline conditions are used as a reference climate from which a change in climate can be calculated (McCarthy *et al.*, 2001). Put simply, in order to detect a change in climate or of any other phenomena, there must be a reference point to compute the rate of change. The second use of a climate baseline, is that it defines the prevailing climate condition which an activity or system is exposed to and also which it must adapt to (Carter *et al.*, 1999; McCarthy *et al.*, 2001). The third use of current baseline is in the construction of climate change scenarios from GCM outputs (IPCC, 2001; McCarthy *et al.*, 2001). The procedure for computing climate change scenarios are discussed and shown diagrammatically (Figure 5.1 and Figure 5.2) under scenarios computed from GCMs outputs. However, to mention it briefly, the difference or the ratio between results obtained from current climate run and from future climate run experiments is taken and applied to the present observational data (IPCC, 2001; PARC, 2001).

It is recommended that the climatological baseline should be based on a 30 year period. For instance, the World Meteorological Organisation baseline period is 1961-1990 (Carter *et al.*, 1999; McCarthy *et al.*, 2001; Smith *et al.*, 1998). While other studies use 1951-80 as the baseline period (Smith *et al.*, 1998). Thirty years

is generally recommended as it is long enough to capture all the variabilities and anomalies (IPCC, 2001; Smith *et al.*, 1998). In addition, it is pointed out that 1961-1990 data is recent and has been recorded world wide (with some exceptions).

### **Socioeconomic/emission scenarios**

Socioeconomic scenarios are an integral part of climate scenarios. According to IPCC-TGCI (1999) socioeconomic scenarios are important as they are the major cause of changes in the atmospheric concentration of gases especially GHGs. In addition, human activities induce changes on land use and land cover, and the environment. Thus, even with no climate change, changes will still be there. IPCC-TGCI (1999) summarises the importance of socio-economic scenarios in assessment studies as follows:

- They enhance our understanding of the relationships and dynamic of future emissions;
- They provide a plausible range of future emissions of net GHGs and aerosol precursors, which are then converted to atmospheric concentration and resultant radiative forcing, required in the GCM experiments; and,
- They offer a consistent framework of projections which can be used in climate change impact, adaptation and vulnerability studies.

While all socio-economic scenarios are important, only emission scenarios are discussed in this section. Other types of scenarios such as population and economic growth are mentioned in passing as they determine emissions. Currently, there are two types of GHGs emissions scenarios computed: IS92 and the SRES emission scenarios.

IS92 are the early computed emission scenarios first published in 1992 by the IPCC (IPCC-TGCI, 1999). There are six IPCC emission scenarios: IS92a; IS92b; IS92c; IS92d; IS92e; and IS92f (IPCC, 2000; IPCC-TGCI, 1999). These scenarios have different assumptions and projections on economic and population

growth and other socio-economic factors that affect emissions. Table 5-1 lists the characteristics of IS92 scenarios and their environmental implications.

**Table 5-1: Summary of the IS92 Scenarios and their environmental implications**

Scenario estimate	1990	IS92 scenarios for 2100					
		IS92a	IS92b	IS92c	IS92d	IS92e	IS92f
Population (billion)	5.252	11.3	11.3	6.4	6.4	11.3	17.6
Economic growth rate (annual GNP; p.a)	-	2.3	2.3	1.2	2.0	3.0	2.3
CO <sub>2</sub> concentration (ppmv) <sup>1</sup>	354	708	685	471	542	954	820
Global annual-mean temp. change (°C) <sup>2</sup>	-	2.18	2.13	1.47	1.75	2.64	2.52
Range (°C) <sup>3</sup>	-	1.50-3.14	1.46-3.06	1.29- 2.18	1.18- 2.56	1.83- 3.73	1.74-359
Global mean sea-level rise (CM) <sup>2</sup>	-	51	50	40	45	57	56
Range (CM) <sup>3</sup>	-	20-90	20-89	14-76	16-82	24-98	23-96

<sup>1</sup> Best-guess assumptions C cycle; <sup>2</sup> assuming 2.5 °C climate sensitivity; <sup>3</sup> based on 1.5 °C and 4.5 °C climate sensitivity range.

Adopted from IPCC-TGCI (1999).

In 1995, there was a review of the IS92 scenarios and it was recommended that new emission scenarios be computed (IPCC, 2000; IPCC-TGCI, 1999). The recommendation generally came from issues that emerged from a literature review on factors affecting emissions (IPCC, 2000). The IS92 scenarios had some shortfalls, especially on addressing factors driving emissions. Hence, the computation of SRES emission scenarios progressed. SRES scenarios were computed based on a storyline approach (IPCC, 2000; IPCC-TGCI, 1999). The

storyline<sup>28</sup> approach produced four sets of scenarios which are known as families (IPCC, 2000). The four scenarios families are named as A1; A2; B1 and B2.

Each of the four families of scenarios describes the world differently in terms of economic and population growth, and technologies and their utilization (IPCC, 2000; IPCC-TGCIA, 1999). From these four scenario families a total of six scenarios were computed, three scenarios from A1 family named:

- A1FT which describe the future as more fossil fuel intensive;
- A1B which describes a balanced use of all fuel sources; and
- A1T which is utilizes predominantly non-fossil fuel.

The remaining three sets of scenarios are named A2, B1 and B2. From the six scenarios a multi-model approach was adopted that produced a total of 40 SRES scenarios (IPCC, 2000). Table 5-2 is a summary of the SRES emissions scenarios and their selected environmental consequences.

---

<sup>28</sup> A storyline is defined as “a narrative description of a scenario (or a family of scenarios) highlighting the main scenario characteristics and dynamics, and the relationships between key driving forces”(IPCC-TGCIA, 1999).

**Table 5-2: Summary of the SRES emission scenarios and their environmental implications**

Scenario estimates	1990	SRES marker scenarios for 2100			
		A1	A2	B1	B2
Population (billions)	5.25	7.1	15.1	7.2	10.4
Economic growth rate (annual GNP; % p.a)	-				
CO <sub>2</sub> concentration (ppmv) <sup>1</sup>	354	680	834	547	601
Global annual – mean temp. change (°C) <sup>2</sup>	-	2.52	3.09	2.04	2.16
Range (°C) <sup>3</sup>	-	1.70-3.66	2.12-4.41	1.37-2.99	1.45-3.14
Global mean sea-level rise (cm) <sup>2</sup>	-	58	62	50	52
Range (cm) <sup>3</sup>	-	23-101	27-107	19-90	20-93

<sup>1</sup> best-guess assumption re. C cycle; <sup>2</sup> assuming 2.5°C climate sensitivity; <sup>3</sup> based on 1.5°C and 4.5 °C climate sensitivity range

Adopted from IPCC-TGCI (1999).

After emissions have been described, atmospheric concentrations of GHGs are calculated based on the life time of these GHGs and converted into radiative forcing (IPCC, 2000). According to IPCC-TGCI (1999:41), GCM simulations use a “stylised forcing scenarios of 0.5% or 1% per annum increase in the concentrations of equivalent CO<sub>2</sub> in the atmosphere”.

## **Types of climate scenarios**

There are three types of climate change scenarios (IPCC, 2001; McCarthy *et al.*, 2001). Listing in order of their complexity they are: incremental or synthetic, analogue and General Circulation Models. According to Viner *et al.*, (1995) none of these methods of scenarios construction are ideal; each method has its own advantages and disadvantages, though the superiority of GCMs has been noted (Hellstrom and Chen, 2003; Smith *et al.*, 1998; Viner, 2000). The advantage and disadvantages of these methods are well documented elsewhere (IPCC, 2001, 1998; McCarthy *et al.*, 2001; Viner, 2000). I highlight the most important issues.

### **Incremental scenarios**

With incremental scenarios, also known as synthetic, a value of a meteorological variable is changed by some plausible, though arbitrary value (IPCC, 2001). Taking temperature and precipitation variables as an example, their values will be incrementally changed by +1, +2, +3°C and ±10% and ±20% respectively (Smith and Pitts, 1997; Smith *et al.*, 1998). These types of scenarios can be varied seasonally, annually, spatially and diurnally (IPCC, 2001). They are only applied to determine the sensitivity of an activity to variation in the climate variables (Smith *et al.* 1998). For instance, Chipanshi *et al.*, (2003) used arbitrary but plausible changes (incremental scenarios) in temperature of 2°C and 3°C to assess the sensitivity of crop yields to climate change in the eastern part of Botswana. In addition, as has been alluded to, incremental scenarios have been applied to test the global implications of aircraft and global cooling of the stratosphere (IPCC, 2001).

### **Analogue scenarios**

These types of climate scenarios can be constructed in two ways: Firstly by using a past-recorded climate that may resemble the future climate in a given region. Secondly, by transferring present climate of one region to another region that is anticipated to have the same climate in the future (IPCC, 2001; Smith *et al.*,

1998). These two forms of analogue scenario construction correspond to the two types of analogue scenarios the temporal and spatial analogue scenarios (IPCC, 2001).

Spatial analogue scenario is the simplest approach to analogue scenario construction (Viner *et al.*, 1995), as it uses present climate in one region to infer to the future anticipated climate of another region (IPCC, 2001; Smith *et al.*, 1998). For instance, in the northwest part of Botswana, temperatures and rainfall are much higher and lower, respectively, than the southeast for all seasons. Thus, higher temperature and lower rainfall in the northwest part can be used as a scenario for anticipated future temperatures and rainfall for the southeast. According to Viner *et al.* (1995: 178) this type of scenario construction is advantageous as it “provides a useful tool for illustrating to a wide audience the potential significance of future climate change.” But its major disadvantage is that its usefulness in impact studies is rather limited as incremental change is not based on emissions of GHGs but is arbitrary.

Temporal analogue scenarios are not as simple as their counterparts and in addition, their accuracy is questionable (IPCC, 2001). The procedure uses past temperatures, which were usually high, and synonymous with projected ones due to anthropogenic activities (Smith *et al.*, 1998). Under analogue scenario, there are three eras of particular significance to the climate scientists: the mid-Holocene period, which is about 5 to 6 ky BP<sup>29</sup> (1°C warmer); the interglacial which is about 120 to 150 ky BP (approx. 2°C warmer) (IPCC, 2001; PARC, 2001); the third period known as the Pliocene, which is about 3-5m BP (between 3-4°C warmer) is also of particular interest (PARC, 2001).

Another way to construct temporal analogue scenarios is through an instrumental method (PARC, 2001). Under this method, past observed and recorded temperature are used to construct climate scenarios. Constructing scenarios using this method has an added advantage in that climate has been observed and recorded and is therefore internally consistent and physically plausible (IPCC, 2001). In instrumental scenarios, the period of particular importance is the

---

<sup>29</sup> ky BP is 1000 years Before Present (IPCC, 2001).

industrial revolution when massive emissions of GHGs commenced. While it is noted that the disadvantage may be that the recorded climate changes have been fairly small compared to the anticipated ones (IPCC, 2001), thus an element of underestimation of the impact assessments outputs occurs.

### **General circulation models**

GCMs are three dimensional, complex, mathematical models that simulate the physical and dynamic interactions between ocean, atmosphere and soils (Haywood and Valdes, 2004; Manabe *et al.*, 2004; McCarthy *et al.*, 2001). Relative to other types of scenario computation, scenarios from GCMs are the mostly widely used climate change scenarios (IPCC, 2001; IPCC, 2007; McCarthy *et al.*, 2001; Smith *et al.*, 1998). Logically, their wide utilisation in climate impact studies is not coincidental. It arises from the realisation that GCMs are the “only credible tools currently available to simulate the physical processes that determine global climate” (PARC, 2001:18). Smith and Pitts (1997) state that using GCMs scenarios is advantageous in that they meet all four criteria for selecting scenarios. Their superiority is also echoed by Hellstrom and Chen (2003).

There are three main types of GCMs, listed in order of their complexity:

- Atmospheric GCMs coupled with a simple slab ocean. These are generally used in equilibrium experiments;
- Atmospheric GCMs (AGCMs) coupled to a three-dimensional representation of the ocean system. An example of this type of model is the UKTR; and,
- Atmospheric GCMs (AOGCMs) coupled to a three-dimensional representation of the ocean and a three-dimensional terrestrial biosphere model. Examples given are the HadCM2 and HadCM3 (Viner, 2000).

Computation of climate change scenarios in GCMs can be done either by equilibrium response or the transient response experiments (McCarthy *et al.*, 2001; Smith *et al.* 1998; Smith and Pitts 1997; Viner *et al.*, 1995). Under the



equilibrium experiment, an assumption is made that the current climate is stable and therefore in equilibrium (McCarthy, *et al.*, 2001; PARC, 2001; Smith *et al.*, 1998; Viner, 2000). This is the baseline climate scenario. Most of the earlier GCM models are used in the equilibrium experiments and they comprise a three-dimensional atmospheric model coupled to a 'slab-ocean' (Viner, 2000). The ocean components on the earlier version of GCMs are very simple and not well represented (PARC, 2001; Smith *et al.*, 1998). The 'slab-ocean' basically represents the whole ocean but it only includes the shallow, top layer (McCarthy *et al.*, 2001). From the stable/equilibrium climate, either CO<sub>2</sub> concentration is instantaneously doubled (2xCO<sub>2</sub>) or its (CO<sub>2</sub>) equivalency. A climate scenario is developed on the basis of the baseline concentration 1xCO<sub>2</sub> and 2xCO<sub>2</sub> (Smith *et al.*, 1998; Viner, 2000; Wetterhall, 2002). Thus, computations of climate change scenarios involve two runs. Firstly, under a baseline 1xCO<sub>2</sub>, the experiments are run until a stable climate is reached. Second, instantaneously 2xCO<sub>2</sub> and sometimes 4xCO<sub>2</sub> is imposed and the model is run until a new equilibrium is reached (IPCC, 2001; PARC, 2001; Wetterhall, 2002). The procedure for climate scenario construction is that the results from the two simulations under 1xCO<sub>2</sub> and 2xCO<sub>2</sub> are averaged and their difference is calculated (2xCO<sub>2</sub> – 1xCO<sub>2</sub>). While for precipitation the ratios of the two results applies (2xCO<sub>2</sub>/1xCO<sub>2</sub>) (IPCC, 2001; PARC, 2001). Figure 5.1 illustrates climate scenario construction under an equilibrium experiment.

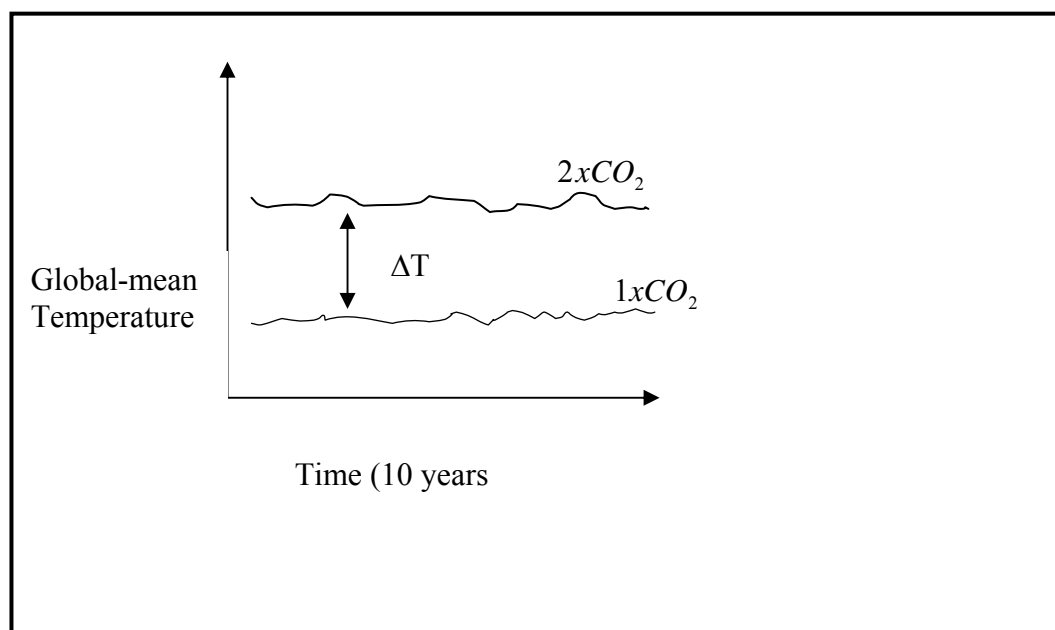

**Figure 5.1: An example of climate scenario construction under an equilibrium experiment.**

Adopted from PARC (2001)

Using the equilibrium experiments to compute climate change scenarios has some disadvantages. Firstly, it is impossible to estimate emissions against calendar years *i.e.*; we cannot say when 2xCO<sub>2</sub> will be achieved. The experiment is not time dependent. Secondly, it is unrealistic to assume that from 1xCO<sub>2</sub>, emissions and resultant concentrations will shoot to 2xCO<sub>2</sub> (PARC 2001).

Unlike with the equilibrium experiments where, it is assumed that there is an abrupt increase to 2xCO<sub>2</sub> (IPCC, 2001; Smith *et al.*, 1998), a transient experiment assumes a steady yearly increases e.g., 1% yearly increases (McCarthy *et al.*, 2001; Smith *et al.*, 1998). In addition, transient experiments are run using complex coupled Atmospheric-Ocean General Circulation Models (AOGCMs) (McCarthy *et al.*, 2001; Sokolov *et al.*, 2003). Currently, transient experiments are widely used relative to equilibrium experiments (Sokolov *et al.*, 2003), and have been from the 1990s onwards (IPCC, 2001). Compared to the equilibrium experiments where models are run for 10 years, transient experiments can be run for up to 100 years (Viner, 2000). Transient experiments are however run in a similar manner to equilibrium experiments. Firstly, there is a baseline condition

called the ‘control’ experiment, where it is assumed that there is no radiative forcing. Then, the model is run with incremental CO<sub>2</sub> concentrations (on a yearly basis) (PARC, 2001). Figure 5.2 illustrates the transient experiment for climate scenario construction.

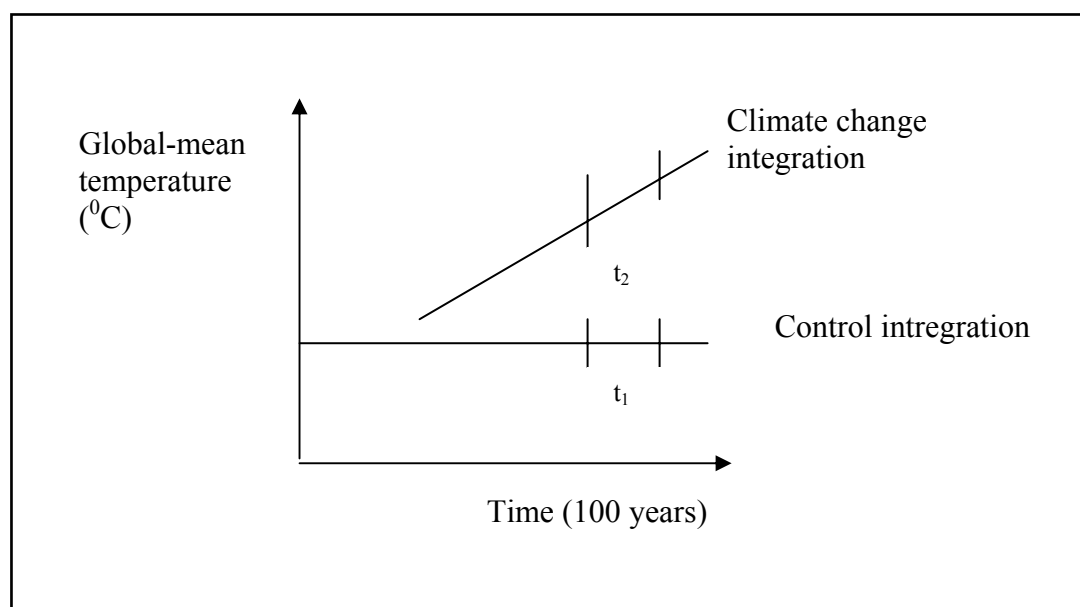

**Figure 5.2: An example of climate scenario construction under a transient experiment**

Adopted from PARC (2001)

Construction of climate scenarios under experiments is slightly different from that of the equilibrium experiments. The differences or the ratios of the variables of interest (meteorological values) are taken at corresponding times. This is advantageous in that it facilitates putting in the emissions and the impacts with calendar dates.

It has been observed that earlier transient response experiments were susceptible to a phenomenon known as “cold start<sup>30</sup>” (IPCC, 2001; Smith *et al.*, 1998). “Cold-start” introduced an error by underestimating climate change for the first few decades (IPCC, 2001; Viner *et al.*, 1995). To correct this, historic GHG emissions should be forced into the transient experiments. This is known as the “warm start”

<sup>30</sup> Cold start occurs when the transient experiment fails to take into account historic GHGs emissions beyond the defined baseline (Smith *et al.*, 1998). This problem is only inherited in transient as oppose to the equilibrium response experiment. Probably, this is because, in the equilibrium experiments, the first baseline experiment is run until it is in equilibrium. Thus, taking into account historic emissions.

(IPCC, 2001; PARC, 2001; Smith *et al.*, 1998). Recent transient experiments have been forced with historic emissions to correct “cold start” (IPCC, 2001; Smith *et al.*, 1998).

### **Variability of climate scenarios in inter-GCM experiments**

Analyses of the results obtained from the two types of GCM experiments reveal that, the models simulate global present climate perfectly (IPCC, 1998, 2001). However, this is not so at the regional scale. According to IPCC (2001) simulation at the regional scale is marked and characterised by biases and high variability between regions. For instance, IPCC (1998, 2001) note that seasonal temperature is biased within the range of  $\pm 4^{\circ}\text{C}$ , while in other regions it is in the extreme of  $\pm 5^{\circ}\text{C}$ . On the other hand, precipitation is moderately biased relative to temperature. It is biased in the range of  $-40$  and  $+80\%$  with extreme cases of  $100\%$  in some regions (IPCC, 2001). IPCC (1998) revealed an extreme bias of regional precipitation of greater than  $200\%$  in African deserts. Another peculiar factor is that different models give different simulations for the same region even when perturbed by the same forcing (IPCC, 1998). The conclusion that is reached is that at a regional scale GCM performance is generally poor. Over the years, high resolutions GCMs have been assembled (IPCC, 1998). However, it has been found that biases have increased with the high resolution models (IPCC, 2001). Though, it is a good exercise to compare the results with observation data, caution is given. PARC (2001) advises that to make a robust assessment of model performance, a large sample of GCM experiments with identical forcing conditions should be averaged. This is known as the ensemble-mean, and should be compared with the observed climate data (PARC, 2001). Their argument is that ensemble-mean reduces noise<sup>31</sup> and should match closely the observed climate data.

Poor performance of the GCMs in simulating regional climates is due to the following reasons:

---

<sup>31</sup> Noise in climate data refers to variability of the data and it is a result of natural processes (PARC, 2001).

- Generally GCMs have a coarse resolution. They can only simulate climate at the sub-continental level. According to IPCC (2001:589), “coupled GCMs cannot provide direct information at scales smaller than their resolutions (order of several hundred kilometers)”. Smith *et al.* (1998) estimate that a typical average resolution of a GCM is in the range of 250 kilometers in width and 600 kilometers in length. While Murphy (1999) gives a horizontal resolution of 300 km.
- In addition, due to their coarse resolution, GCMs are not able to mimic detailed regional forcing that influences regional and local climates (Hellstrom and Chen, 2003; IPCC, 2001; Murphy, 1999). It is evident that regional and local climates are influenced by forcing at both the local/regional and global scale. According to IPCC (2001) regional climate is a function of the interaction of forcings and circulations that occur at the planetary, regional and local spatial scales, in addition to a range of both temporal scales, from sub-daily to multi-decadal. Obviously, GCM experiments are able to capture forcing at the planetary scale. However, finer and finer features such as water bodies, terrains and forests that determine microclimate of any region escape the simulation of the GCMs. This leads to overestimation and underestimation of the regional and local climates.

### **Procedure for selecting GCM output**

There are many experiments undertaken using GCMs. The issue that arises is how to choose the best results from so many GCM outputs. According to IPCC-TGCI (1999); McCarthy *et al.*, (2001) there are three factors that must be taken into account when selecting the results/output from GCM experiments. There are as follows: vintage, resolution, and validity.

Vintage basically deals with the time factor. It is argued that recent models simulate the climate better than the earlier versions as they are based on recent knowledge and advanced technology (McCarthy *et al.*, 2001; Smith *et al.*, 1998). Therefore, their resolution is superior to the earlier models. For this reason one is encouraged to use scenarios from a recent model. The resolution factor is thus

incorporated in the vintage. Higher resolution output is more favored relative to coarse resolution. This is due to the fact that, there will be no need for further downscaling which may bring in more uncertainties and errors. Lastly, it is obvious and will make sense to select the results that closely simulate the observational data rather than selecting outputs with biases.

## **Regional climate scenario**

Given the poor performance of GCM experiments in simulating current climate and also the fact that GCMs do not give climate at a fine scale, there is a need to convert GCM outputs to regional scale for scenario construction. In addition, IPCC (1998) remarks that though technological advances have resulted in increased resolution of the coupled GCMs, their output are still too coarse to capture all the complex features that interact to determine microclimate. This led to the development of regionalisation techniques (statistically downscaling and dynamical downscaling) and GCM transient experiments with high spatial resolutions.

## **Regionalisation/Downscaling Techniques**

As alluded too, regional climate is different from the global climate. There are fine feature that influence local and regional climate that cannot be captured by GCMs. Murphy (1999) remarks that it is common knowledge that regional forcing from features such as orography, coastlines, lakes, and land surface characteristics influence local climate. Hence, there is a need to take these various factors and features into account. This process is known as downscaling or regionalisation. It is defined as transformation of large-scale sub-continental climate to smaller-scale regions with high resolution (Heimann and Zemsch, undated; PARC 2001). Downscaling simply relies on the GCM outputs (IPCC 1998; PARC, 2001). Thus, for downscaling to be effective and simulate well the regional climate, global climate should be simulated well by the GCM. There are currently two distinct methods that can be employed to convert the coarse resolution outputs (sub-continental outputs from GCMs) to high resolution regional and local climates. These are statistical downscaling and dynamical downscaling. There is also a

combination of the two methods known as statistically-dynamical downscaling (SDS).

### **Dynamical downscaling**

There are three approaches to dynamical downscaling: Limited Area Model (LAM) or Regional Climate Model (RegCM), using high resolution atmospheric GCMs (AGCMs), and use of a variable-resolution global model (Hellstrom and Chen, 2003). Of these types, RegCM is frequently used in dynamical downscaling. Under dynamical downscaling, a high resolution regional model such as a Regional Climate Model (RegCM) is nested within the coarse resolution GCM (Hellstrom and Chen, 2003; IPCC, 1998, 2001; Murphy, 1999). It uses the boundaries of the GCM and also the domain of the GCM to produce its own domain. Thus, boundary conditions of the GCM are forced at the boundary condition of the RegCM to develop its own local climate within the GCM domain (Hellstrom and Chen, 2003; IPCC, 2001; Wetterhall, 2002). According to Murphy (1999:2257) “the RCM acts, as required, as a physical based interpolator of the GCM output”. Compared to the other downscaling methods, this method is rarely used. Reasons for its infrequent utilization in downscaling are two fold. Firstly, it is computationally expensive relative to other techniques (Murphy, 1999; Wetterhall 2002). Secondly, for certain assessments studies, which involve specific ecosystems, there is a need for further downscaling to even finer resolutions (Wetterhall, 2002). Nested RegCM is based on the assumption that the GCM output is not biased.

### **Empirical/Statistically downscaling**

Statistical downscaling is a technique where local meteorological values are inferred from the global and sub continental meteorological values. There are three main types of empirical/statistical/dynamical downscaling (Linderson *et al.*, 2004; Murphy, 1999; PARC, 2001; Wetterhall, 2002).

- Transfer functions or regression methods;
- Weather typing; and

- Weather generation.

### **Transfer functions/regression methods**

Transfer function methods are based on linear regressions. An assumption is made that there is a statistical relationship between large scale/ global climate anomalies and local/regional climate events (Abaurrea and Asin, undated; Fuentes and Heimann, 2000; IPCC, 2001; Linderson *et al.*, 2004; Wetterhall, 2002). The central issue under this method is therefore to establish a statistical relationship between atmospheric circulation obtained from the GCM results and local scale variables. The atmospheric variables are called predictors and the regional variables are called predictands (IPCC, 2001; PARC, 2001). According to Murphy (1999:2257) developing the statistical relationship between the predictors and predictands is based on the assumption that “the atmospheric circulation in a GCM simulation is more likely to be reliable than the distributions of surface climate elements”. These statistical relationships are assumed to hold even under changed climates. There are four essential steps towards creating regional climate change scenarios under transfer functions (IPCC, 2001; Linderson *et al.*, 2004; Wetterhall, 2002):

- Identify predictors that affect predictands, the predictors must be well simulated by the GCMs;
- Establish and develop a statistical relationship between predictors and predictands;
- Validate the established relationship between predictors and predictands with independent data; and,
- Using the predictors from the GCM into the established regression model to obtain values of the predictands.

There are various predictors that are assumed to influence local meteorological variables. Cavazos and Hewitt (2002) assessed the most skilful and significant predictor for precipitation for various countries. To select the most skilful predictors, stepwise regression can be used (Linderson *et al.*, 2004). In this



methodology, predictors are systematically added to the existing ones and are retained in the model, if they increase the correlation coefficient ( $R^2$ ) then they are skilful. However, they are removed if their inclusion in the model does not make a significant change to the  $R^2$ . There are various methodological approaches and techniques that can be adopted under the transfer functions such as: artificial neural networks, canonical correlation analysis, and singular value decomposition (Busuioc *et al.*, 1999; Linderson *et al.*, 2004).

### **Weather typing**

Weather typing is very similar to the transfer function (Linderson *et al.*, 2004; PARC 2001), as it involves linking observed climate data to a given weather classification scheme (Wetterhall, 2002). Firstly, it involves identification and classification of schemes either objectively or subjectively (Linderson *et al.*, 2004; PARC, 2001; Wetterhall, 2002). Objective classification employs methods such as principal components analysis (Linderson *et al.*, 2004; PARC 2001)

Linderson *et al.* (2004); Wilby and Wigley (1997); and Xu (1999); highlighted the steps in weather typing as follows:

- Classification of the atmospheric circulation patterns into a few defined classes;
- Simulate weather types through relevant models and methods;
- Condition the predictands to the predictors;
- Perturb and simulate the predictands using output GCM as forcing data; and,
- Simulate precipitation in case of a wet day or temperature.

## Weather generators

Weather generators are statistical models of observed daily sequences of meteorological variables, particularly precipitation (PARC, 2001; Wetterhall, 2002; Wilks and Wilby, 1999). Thus, they operate on a daily time step basis (Wilks and Wilby, 1999). The method is used for various purposes such as modelling of climate-sensitive systems, simulation of missing weather data and obviously for downscaling of regional climate change scenarios. It is mostly used in precipitation processes due to the fact that “precipitation data exhibits distinctive and difficult characteristics which complicate the statistical models needed to describe them” (Murphy, 1999). Secondly, precipitation is unique in that it has mixed character, i.e., it is both a discrete and continuous variable, it could be either zero or nonzero (Murphy, 1999). According to Murphy (1999) weather generators are suitable as a tool for analysis and downscaling precipitation. Weather generators have the ability to present wet and dry days in serial or autocorrelation, such “that wet and dry runs tend to clump together in time more strongly than could be expected by chance” (Wilks and Wilby, 1999:331). A first or second order Markov process is at the core of the weather generator (Wetterhall, 2002; Wilks and Wilby, 1999). In this model/process a meteorological variable, mainly precipitation, and its occurrence is dependent on the outcome of the previous day (Wetterhall, 2002). Thus, a probabilistic method is used to generate future regional climate.

Xu (1999) and Wetterhall (2002) summarise the steps in weather generators:

- Use the observed daily meteorological variable to determine the probability state of the day;
- Use either exponential or Markov renewal processes to fit and determine the amount of precipitation on a wet day or zero precipitation on a dry day; and,
- Lastly, condition other meteorological variables to a wet/dry status of the day.

## Baseline data for the study area

Baseline data for this study was collected on temperature and precipitation and covers a 30 year period (1960-1990), as recommended by IPCC. Figure 5.3 shows average maximum temperature for the study area. The months with the highest average temperature are November, December, January and February, while the lowest average temperature are for the winter months (May, June and July). Thus, temperature in the country is highly variable between seasons (summer and winter) as depicted from Figure 5.3. Rainfall is no exception in terms of variability. Variability between the years ranges from 600mm to 180 mm as shown in Figure 5.4. On average annual rainfall recorded for the study area during the baseline period is 377mm. As pointed out by Bhalotra (1987), Botswana experiences conventional rainfall, thus, occurring during the summer period in November, December, January and February while the months that receive the least rainfall are May, June, July and August.

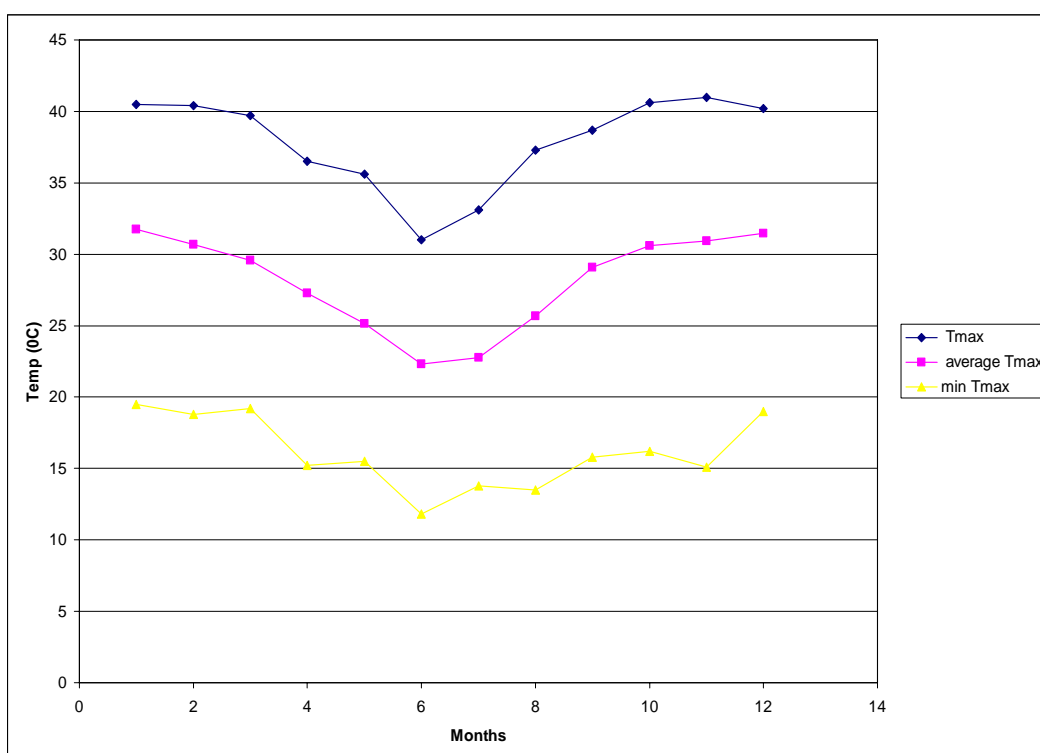

**Figure 5.3: Baseline Tmax , Tmin and Average Tmax**

Source: Department of Meteorology, Botswana (2004)

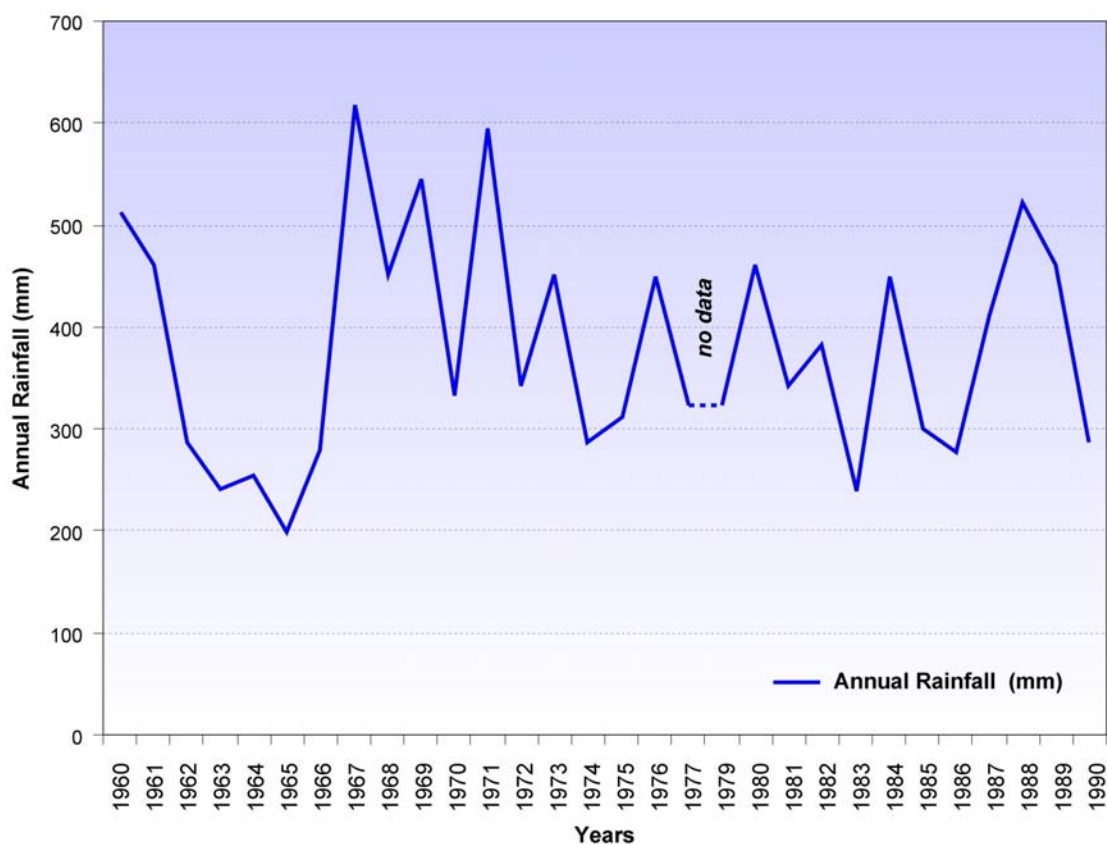

**Figure 5.4: Annual rainfall recorded for Khurutshe (1960-1990).**

Source: Department of Meteorology, Botswana (2004)

## Climate and climate scenarios for the study area

Climate scenarios for the study area are generated using SimCLIM software. SimCLIM software uses output from global GCMs to generate local climate scenarios. In this study HadCM3 and CSIRO Mk2 GCMs are used to compute climate scenarios. The GCMs were selected for the following reasons: currently, they are the only tools available to simulate global climate reasonably well (PARC, 2001). Secondly, GCMs are the most skilful tools available in capturing the important dynamics of the atmosphere (Kiker, undated). Thirdly, compare to analogue and incremental scenarios, GCMs are intensively used and highly recommended by IPCC. Lastly, Reason *et al.*, (2006) assessed their performance

in simulating southern Africa rainfall. They indicated that “when forced with observed sea-surface temperatures a GCM was able to capture the main summer seasonal rainfall variability over southern Africa” (Reason *et al.*, 2006). Despite, their skilful in capturing the dynamics of the atmosphere, GCMs are still in limited due to uncertainties. A total of six climate scenarios for the year 2050 are generated using three SRES emission scenarios: A1B, A1FT and A1T. That is, three sets of emission scenarios are used for both the HadCM3 and CSIRO Mk2 GCM to construct climate scenarios for rainfall and temperature. Generation of climate scenarios for the study area was done using mid climate sensitivity<sup>32</sup>. Baseline and climate scenarios for 2050 are based on the long term mean for the years 1960-90. However, extreme event analysis for both temperature and drought are based on a 30 year daily time series record for both baseline and climate scenarios. Table 5-3 below shows increase in temperature in absolute unit (°C) between the baseline data (1960-1990) and 2050 based on HadCM3 and CSIRO Mk2 GCM results with different emission scenarios. In all emission scenarios the HadCM 3’s increase is higher than CSIRO Mk2 results. In all cases, the highest months that experience maximum increases in temperature are the winter months while other months have relative lower increases compared to winter months. The common feature on all the temperature scenarios generated is that there is an increase in temperature though the magnitude of the increase differs greatly.

Unlike temperature scenarios where all the GCM and different SRES emission scenarios show increases in temperature, the rainfall scenarios for the same year (2050) show increases and decreases. January is the only month where there is an increase in precipitation while November indicates a maximum decline of 10.5%. Overall the net average change in precipitation is a decline of between 3 and 9.6%. Table 5-4 below shows the magnitude of change for precipitation using different emission scenarios for HadCM3 and CSIRO Mk2 GCMs. While the HadCM3 gives the highest temperature and lowest precipitation change by the year 2050, the CSIRO Mk2 on the other hand gives lower values for temperature change but higher values for precipitation for the year 2050. According to CSIRO

---

<sup>32</sup> Climate sensitivity is a measure of changes in radiative forcing. It is defined as a change in global mean surface temperature resulting for a doubling of the atmospheric CO<sub>2</sub> or its equivalent (IPCC, 2001). It is expressed as °C/ (W/m<sup>2</sup>). The parameters have been defined under the footnote for radiative forcing. Climate sensitivity is estimated to be in the range of 1.5 to 4.5 °C (IPCC, 2001).

Mk2 A1FT GCM by 2050 average annual precipitation will be reduced from current (1960-1990) average of 377 mm per year to 337 mm per year, a decline of 12%.

**Table 5-3: average increase in temperature by 2050 from the baseline temperature in °C**

Months	CSIRO Mk2 A1T	CSIRO Mk2 A1B	CSIRO Mk2 A1FT	HadCM3 A1B	HadCM3 A1FT	HadCM3 A1T
1	1.31	1.09	1.39	1.49	1.90	1.73
2	1.10	0.92	1.16	1.50	1.92	1.78
3	1.09	0.90	1.15	1.51	1.93	1.84
4	1.09	0.90	1.15	2.11	2.70	2.54
5	1.35	1.12	1.43	2.71	3.46	3.28
6	1.59	1.32	1.69	2.42	3.10	2.90
7	2.00	1.65	2.12	2.32	2.97	2.45
8	1.71	1.41	1.81	2.11	2.70	2.52
9	1.22	1.17	1.49	1.99	2.54	2.40
10	1.54	1.30	1.68	1.74	2.23	2.10
11	1.39	1.15	1.47	1.66	2.11	2.00
12	1.42	1.18	1.50	1.66	2.13	2.01

**Table 5-4: Changes in rainfall by 2050 from the baseline period in % by month**

GCM type	Emission scenario	Average% change	Maximum % increase	Minimum % change
HadCM3	A1B	-3.17	2.14	-8.09
	A1FT	-4.09	2.66	-10.5
	A1T	-3.86	2.5	-10
CSIRO Mk2	A1B	-7.53	0.5	-8.09
	A1FT	-9.6	0.58	-11
	A1T	-9.09	0.58	-14.1

Figure 5.5 depicts baseline average monthly temperature and the SimCLIM generated 2050 temperature scenarios by SimCLIM using SRES emission scenarios. The HadCM3 GCM A1B SRES gives the medium change in maximum temperature compared to other SRES emission scenarios.

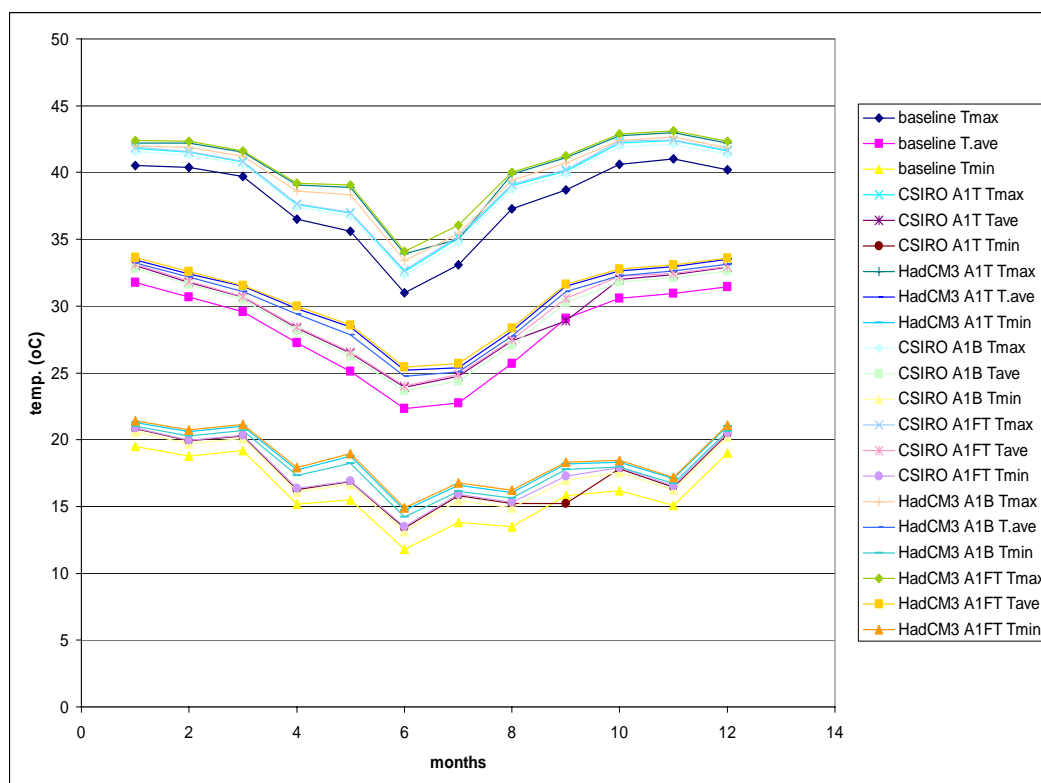

**Figure 5.5 : Temperature for baseline and 2050 based on HadCM3 and CSIRO Mk2 GCMs.**

An extreme event analysis was conducted for temperature. Table 5-5 shows an extreme value of temperature in six days for the baseline period and 2050 and its return period. A return period, also known as the recurrent interval, measures the average time for the next occurrence of a defined event (Johnson and Watson, 1999). It is noted that a return period is equal to the inverse of the probability of the event occurring in the next time period (Johnson and Watson, 1999). The extreme event value for temperature in six days for the baseline is 38.68 °C. During the baseline period the return period for the extreme value in six days is 131.77 years. However, by 2050 the return period will be reduced considerably to between two and three years. Though 38.68 °C is not the highest recorded maximum temperature for the Khurutshe area, the highest being 41 °C, it was chosen to analyse the effect of climate change on its return period. It was felt that the frequency of occurrence of 41 °C was infinitely small such that climate change may not have a significant impact on its return period. In addition, 38.68 °C was selected as being an extreme value from 27 °C as has been noted by Smart (undated) that at temperature of 27 °C and above cattle will double their water intakes. These changes in the extreme event value and the return period have

serious implication for cattle water demand on a daily basis such that in future, cattle water demand may be constantly high due to higher temperature than the baseline period.

**Table 5-5: extreme event analysis for temperature by 2050**

GCM	Emission scenario	Extreme event value	Return period	U	A	K	R2
Baseline	1990	38.68	131.77	35.85	1.83	0.61	0.45
HadCM3	A1B	38.68	2.86	37.38	2.03	0.69	0.97
	A1FT	38.68	2.18	37.83	2.06	0.7	0.91
	A1T	38.68	2.31	37.72	2.05	0.7	0.92
CSIRO Mk2	A1B	38.68	4.11	36.86	2.29	0.81	0.96
	A1FT	38.68	3.03	37.15	2.42	0.86	0.8
	A1T	38.68	3.25	37.08	2.38	0.85	0.85

Where,

U is the location parameter;

A is the scale parameter;

K is the shape or the power parameter; and,

R2 is the coefficient of variations.

Drought is recurrent yet of different intensity. Climate change undoubtedly will alter the return period and intensity of drought. In Botswana, drought is defined as when annual precipitation in any year is below long-term mean rainfall (Tsheko, 2003). Thus, drought is basically a deficiency in rainfall at a particular point in time. Drought referred to here is the meteorological drought and it affects water demand for cattle in various ways as discussed in chapter 9. Briefly, it heavily impacts on forage water content. Secondly, drought years are hotter than wet years. Lastly, it affects supply of surface water to cattle. A long term mean of 377 mm per year is used to estimate return period for drought for baseline and 2050. Using the above definition of drought Table 5-6 gives the return period for a mild



drought<sup>33</sup> between the baseline and by 2050. Basically, it is clear that by 2050, the frequency of drought occurrence could increase. For instance, during the baseline, the return period of drought was two years and by 2050, the return period could be between 1.6 and 1.75 years depending on GCMs and their associated SRES emission scenarios. Another interesting issue that emerges is the fact that the intensity of drought will also alter; mild droughts that were experienced during the baseline will become severe in future. Drought intensity can be estimated by the difference between annual recorded precipitation and long term average, as precipitation will decline with climate change, it means that the intensity of drought will increase with climate change.

**Table 5-6: Return period of drought for baseline and 2050**

GCM	Emission Scenario	Return period
Baseline	1960-1990	2
HadCM 3	A1B	1.75
	A1FT	1.75
	A1T	1.75
CSIRO	A1B	1.66
	A1FT	1.66
	A1T	1.66

### **The issue of variability in cattle water demand and supply**

Variability is an integral part of any system and as such livestock sector is not an exception. Variability can complicate our understanding and modeling of systems. In livestock sector particularly livestock sector, variability is persistent and it is affected by various factors. According to the Comprehensive Assessment of Water Management in Agriculture (2007) management that is adaptive entails and incorporates an understanding of the variability within the system. As has been alluded to, variability in climate in the country affects livestock water resources. Variability in rainfall events determines droughts and their intensity. Drought affects water supply for cattle such that during the droughts years, there is heavy dependence on groundwater (Calow *et al.*, 2002; Mati *et al.*, 2005). Not only is

<sup>33</sup> A mild drought in this study is distinguished from a severe or harsh drought. A severe drought for cattle is defined as when rainfall is 40% below long term mean precipitation (Burgess 2003). Therefore anything below long term precipitation average and less than 40% below long term mean precipitation is considered a mild drought.

the surface water affected but also groundwater through borehole yield (Calow *et al.*, 2002). In addition, drought has an immense impact of the variability of the livestock numbers. Consequently, the variability in livestock number directly and indirectly affects water resources. Climate change might increase variability of extreme events such as floods, droughts and heat waves (IPCC, 2007). Thus, given our current inability to model current variabilities (IPCC, 2001 & 2007), climate change might complicate our understanding and management of the cattle water resources. However, climate variability is not the only phenomenon that brings an element of variability in the cattle water demand and supply system (Reilly, 2002). There are economic forces of demand and supply that create both short and long term variability in the livestock and agriculture sector (Reilly, 2002). Changes in world markets and price and out-break of diseases (foot and mouth, madcow) can cause variability in the livestock numbers. This might further complicate our future understanding and modeling capability on livestock water sector system

## Summary

In this chapter I reviewed the types of climate scenarios and their uses in impact assessment studies. The reasons for their use have also been presented. One major issue that arose from the literature review was that climate scenarios still face challenges when used in impact assessment studies. The major challenge is uncertainty with regard to future emissions of GHGs, their radiative forcing, and positive and negatives feedbacks from GHGs emissions (IPCC, 2001; Mitchell *et al.*, 1999). One aspect learned from the use of climate scenarios in impact assessment studies is that outputs, or the results from impact assessment studies, are dependent on the climate scenarios used. For instance, extreme scenarios give extreme outputs. Another important lesson learned is that given the uncertainties, it is important to select various types of scenarios that cover a broad spectrum. For instance, in this study three emission scenarios have been selected that cover what is currently viewed as being the greatest future emission scenario, the lowest and intermediate. In addition, the two GCMs selected, the CISRO Mk2 and HadCM 3, cover the lowest and highest changes in rainfall and temperature.

The scenarios indicate that by 2050 rainfall might decline while temperature might increase. These findings have implications for water demand and supply for the cattle sector, not only for the study area but for all semi-arid environments of Botswana where rainfall and temperature are the major determinants of cattle water supply and demand.

Having discussed the importance of climate scenarios in climate change impact assessment studies and having constructed rainfall and temperature scenarios for the study, I discuss the key variables for the cattle water demand and supply system and how they are affected by climate change. This will assist in building the cattle water demand and supply model. In the next chapter, I take the lessons learned here and extend them to the interaction between the system's variables.

## Chapter 6 : Rainfall Patterns and Pan Water

---

### Introduction

Pans are vital to rural livelihoods and their associated economic activities. They are embedded by their multi-functional role in supporting the rural economy, especially the livestock sector, in providing surface water primarily in the rainy season. From economic and environmental points of views, pans are important for two reasons: firstly, as an alternative source of water for livestock which is largely dependent on groundwater, thus, pressure is temporarily relieved from groundwater during the rainy season when livestock drink elsewhere; and secondly, there are economic benefits realised by farmers as abstraction costs for pumping groundwater are reduced when the demand for borehole water intake declines to zero. Though pan water is only available during the rainy season and extends for a few months thereafter, their existence is still vital for livestock grazing and economics of livestock rearing in semi-arid environments. For instance, studies have shown that in above average rainfall years, pans can hold water for the entire rainy seasons (up to four months). In other cattle posts in the Kgatleng District, there are no boreholes and cattle rearing is dependent on pans for water which have been improved (excavation) by the Water Department in the Ministry of Agriculture.

However, changes in rainfall patterns as a result of global warming may affect the quantity of rainwater collected in pans. The impacts will then be the reverse of the highlighted advantages. Firstly, farmers will have to increase their abstraction rates of groundwater to make up for the lost pan water, and increase pressure on the already pressurised water resources. This may negatively affect sustainable use of groundwater for cattle sector. There will also be an associated rise in the costs of abstraction of groundwater in addition to the depletion costs.

A simple rainfall-runoff model is adopted to assess the formation of pans in the study area and impacts of climate change on rainfall-runoff processes and formation of pan water. This model is used to estimate and calculate quantity of pan water for the baseline and 2050. The relationship between rainfall-runoff and water collected in the pans is an important component of cattle water demand-supply system. This component specifically affects the supply-side of the system.

### **Pan water and its importance to the livestock grazing system**

A pan is defined as a depression on land that occasionally holds water during the rainy season. Botswana is known for its abundant pans, especially the Makgadikgadi saltpans. There are numerous medium to small sized pans scattered across the country (Artnzen *et al.*, 1998). The small to medium-sized pans and even the Makgadikgadi saltpans are locally known as *megobe*, while in the Kgalagadi District they are known as *matsha*. Small to medium pans are between 20 and 200m in diameters (Bergstrom and Skarpe, 1999). Pans fall into two groups: man-made and natural. Man-made pans are normally formed during road construction and other building, when gravel is excavated for construction. These shallow depressions dug by construction companies are seldom restored due to the realisation that they have direct benefits as sources of water for cattle and wildlife. This is also emphasised in environmental impact assessments (hereafter EIA) for road construction that the benefits of gravel excavation will be a source of water points for wildlife and cattle during the rainy season. In addition, the government constructs small dams to store water for livestock and irrigation, when requested by farmers. These are also classified as pans. While natural pans were formed by geomorphological processes (Bergstrom and Skarpe, 1999) and others such as the Makgadikgadi saltpans were formed during the ancient period when a lake flooded the area and later dried up (Ringrose *et al.*, 1999).

Pans also provide for the rural population where there is no proper water reticulation compared to the major villages, towns and cities. Pans also provide mineral licks and relatively nutrient-rich vegetation for both livestock and wildlife, especially the calcrete rimmed pans in the Kgalagadi region (Bergstrom

and Skarpe, 1999) and other parts of the country. However, their importance in providing water to rural economies is seasonal, and in most cases short-lived due to high seepage and evaporation rates and over-use. The significant role of the pans is shown by the associated behaviours of households and livestock. During the wet season, herds of animals (both wildlife and domestic) and communities settle around the pans and disperse when they are dry (Arntzen *et al.*, 1998). In other cases livestock, especially cattle, wander 30 kms from their boreholes to graze near waterholes over the rainy season (Bergstrom and Skarpe, 1999; Burgess, 2003). In the Kgatleng District, Arntzen and Opschoor (1985) observed that among other sources of water, dams and pans which only fill over the rainy season are the most important sources of water for both livestock and household consumption. For those cattle posts which are far away from the perennial rivers, pans are a vital source of water for livestock (Moleele and Mainah, 2002).

The importance of pans is not only restricted to rural economies in Botswana but worldwide. For instance Wesemael *et al.*, (1998) point out that ponds, wells and *aljibes* are sources of water for livestock in the rural area of Turkey and Spain. They point out that during the ancient times they were the only source of water for livestock. FAO SAFR (1998) also indicates the importance of pans in other countries in southern Africa, that pans that are in proximity of human settlement are used for cattle grazing and watering. Those in national parks are used as habitats by wildlife and contribute significantly to the tourism industry.

However, the length of time pans can hold water is short and temporary even though there is some variation. For instance, some pans can hold water for a long period of time even after the rainy season (hard veldt), while in other cases they can only hold water for a very short period of time (sand veldt). The duration of water holding is determined by various factors: pan depth, surface area, prevailing weather conditions that determine evaporation and amount of rainfall received in any year, soil types around the pans which in turn determine the seepage rates. One strategy that has been devised by farmers, especially small to medium hold farmers, to optimise pan water is to fill 250l drums with pan water which are later used to water stock, especially goats. In other cases, donkey carts are used to transport water-filled drums to the kraals. This strategy reduces loss from

evaporation and seepage. However, there is also misuse or mismanagement of the pans. Pans are often not fenced and they are frequently polluted by animal waste.

### Rainfall patterns in the study area

Generally, rainfall is extremely erratic both spatially and temporarily in the study area as depicted by the standard deviation on the monthly averages over a 30 year period in Figure 6.1. This is not unusual as remarked by Wesemael *et al.*, (1998) that rainfall and runoff in semi-arid areas is characterised by discontinuity. 95% of rainfall is received in summer: mainly November, December, and January. May, June and July receive less than 5% of the annual rainfall, though there are years when the annual rainfall is all experienced in summer. The study area is located in the belt that receives the majority of the rainfall in the country, approximately 700 mm per year with the region at the lower end of the precipitation spectrum receiving less than 200 mm per year (DSM, 2002). Specifically, the study area received an average annual precipitation of approximately 377 mm per year from 1960-1990.

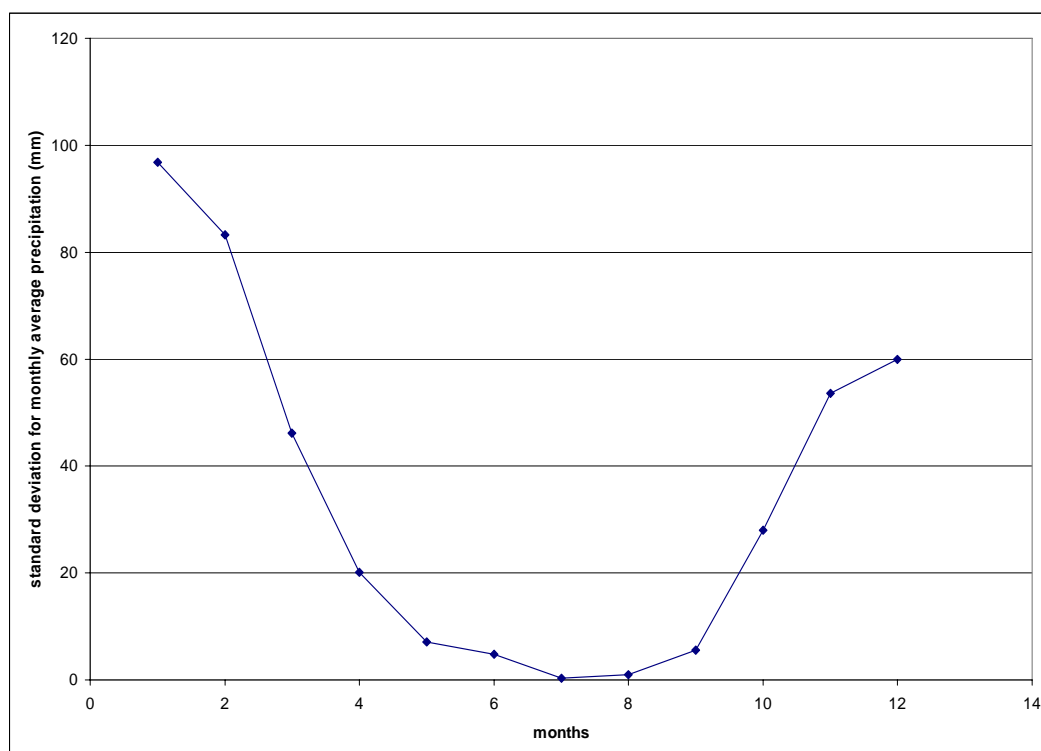

**Figure 6.1: Standard deviation for monthly average precipitation (1960-1990)**

Source: Department of Meteorology (2004).

## Rainfall-runoff modelling and pan water

Runoff is an important process in semi-arid regions as it contributes solely to the formation of pan water and ephemeral rivers. There are three types of runoff: surface; subsurface also called interflow; and groundwater runoff also known as baseflow (Pala, 2003; Singh, 1988). The type of runoff into a watershed is a function of a combination of climatic and physiographic factors and characteristic of the rainfall (Beven, 2001; Singh, 1988). As surface runoff contributes solely to the formation of pan water in the study area and other semi-arid regions, other types of runoff are not considered in this study. In addition, surface runoff is only considered because of the observation made that in semi-arid regions; runoff into a watershed is in most cases predominantly surface runoff (Singh, 1988). As the name implies, surface runoff travels over the ground through channels. Specifically, surface runoff travels via overland and channel flow (Singh, 1988). Generally, in this study and other similar rangeland it has been observed that runoff mostly follows cattle tracks.

Surface runoff occurs when the rainfall exceeds the loss of rainwater that is, when its intensity exceeds the rainfall amount that is intercepted, infiltrated and evaporated, known as transmission loss, and initial losses respectively (Allitt, 2003; Singh, 1988). Singh (1988) defines transmission loss as the amount that is lost due to infiltration when it flows to storage, a pan in this case. In arid to semi-arid regions transmission loss is common and occasionally results in no runoff at all. Not every rainfall event produces runoff. Portions of rainfall contribute to infiltration and the other portion contributes to different types of runoff. The portion that contributes to surface runoff is known as effective rainfall (Beven, 2001; Singh, 1988).

Rainfall loss is considered an important factor in the runoff process (Wang and Chen, 1996). Thus, the runoff travel distance is a function of the following: amount of surface runoff and soil moisture characteristics (Singh, 1988). Of these two factors, soil moisture has been singled out as the most important. For



instance, Campolo *et al.*, (1999) and Aubert *et al.*, (2003) point out that soil moisture is a key variable that determines the dominant type of runoff.

In addition, Allitt (2003) recognised the importance of the type of surface where rainfall falls. He defined two types of surfaces, which influence runoff: impermeable and permeable surfaces. Rainfall experienced over an impermeable surface quickly becomes runoff while with the latter a saturation threshold has to be reached before runoff is experienced. As permeable surfaces become wetter, and reach saturation point, the rate at which water is absorbed declines and eventually becomes runoff. In addition to the saturation threshold being reached, soil infiltration capacity and surface depression storage initialise the process of surface runoff (Singh, 1988).

In the study area, both permeable and impermeable surfaces are present. This is because there are instances where the pans are located in the proximity of the roads, which are impermeable, and in highly impermeable clay soils. Some pans are located on sandy to loam soils which are permeable. All pans formed from the excavation of gravel during road construction are typically located near roads. In most cases they fill quickly with runoff from roads.

### **Towards a simple rainfall-runoff model to estimate pan water for the study area**

According to Beven (2001), there are many reasons advanced for using models in rainfall-runoff processes. The paramount being that there are many limitations as far as measurements of hydrological techniques are concerned (Beven, 2001). Therefore models are used to extrapolate rainfall-runoff processes for decision making. It is acknowledged that modelling rainfall-runoff processes is extremely complex (Aubert *et al.*, 2003; Rajurkar *et al.*, 2004; Singh, 1988). In fact, Allett (2003) and Rajurkar *et al.*, (2004) point out that the complexity of modelling rainfall-runoff processes has dominated hydrological studies. This is reflected by Beven's (2001:1) comment that "there is much rainfall-runoff modelling that is carried out purely for research purposes". Though there are numerous and various models that simulate rainfall-runoff process, Singh (1988:86) notes that due to the

complexity of the process “our understanding of physical principles and the mathematical formulations governing it is limited”. There are four main types of hydrologic models developed to model rainfall-runoff: empirical; water-balance; conceptual lumped-parameter; and, physically-based distributed models (Mirza, 1997; Rajurkar *et al.*, 2004; Wang and Chen, 1996).

Obviously, each of these four main models has its own advantages and disadvantages (Mirza, 1997; Rajurkar *et al.*, 2004; Wang and Chen, 1996). For instance, Wang and Chen (1996) reflect that the conceptual lumped models are widely used to model rainfall-runoff processes however, they have their own shortfalls. For instance, in medium to large watersheds they assume that rainfall is constant throughout the watershed (Wang and Chen, 1996). In addition, to the advantages and disadvantages, their complexity and data requirement also differ widely. Most of these models are more detailed and encompass complex groundwater processes. In addition, they are designed for simulating discharge over a large watershed and rivers.

In this study, a simple model for rainfall-runoff is sought. The study is only concerned with the formation of pans. Thus, complex rainfall-runoff models that take into account subsurface and ground runoff and infiltration rates are beyond the scope of this study. Thus, a simple model that can provide or contribute to calculating the following information is required:

- A model that can estimate the amount of runoff a rainfall event will yield for a given area such as per  $m^2$  given topography and elevations, soil types, vegetation and land use, and;
- The model should estimate how much water a pan will yield from a rainfall event.

Use of simple models has been acknowledged and welcomed in simulating rainfall-runoff processes. For instance, Rajurkar *et al.*, (2004:96) justified the use of a simple model by stating that “many situations in practice demand use of simple tools such as the linear system theoretic models or black box models”. Others such as Mirza (1997) argue that using simple models yield the same results as complex models. However, the disadvantage of simple models is that they may

not mimic well the dynamics and non-linearity of rainfall-runoff processes (Rajurkar *et al.*, 2004).

To estimate the amount of runoff or discharge in a pan following a rainfall event given a catchment area, a simple equation adopted from Penman (1964) is used, Equation 6.1.

$$Q = C * I * A \quad \text{[Equation 6.1]}$$

Where,

Q is runoff into pans or the discharge in m<sup>3</sup>;

C is the runoff coefficient;

I is the average intensity of rainfall or just rainfall either annually, seasonally or monthly; and,

A is the catchment area, m<sup>2</sup>.

The equation has been used extensively to estimate water volume that can be produced by a rainfall event (Dixit and Patil, 1996). The most important and influential parameter of the equation is the runoff coefficient, C. It is defined simply as the proportion of rainfall that is turned into surface runoff. Singh (1988) points out that it represents the fraction of rainfall that appears as surface runoff from a drainage area. It is given by Equation 6.2.

$$C = \frac{R_o}{R} \quad \text{[Equation 6.2]}$$

Where,

C is the runoff coefficient;

R<sub>o</sub> is the runoff; and,

R is the rainfall.

A runoff coefficient is therefore dimensionless and highly variable depending on factors such as the slope of the catchment area; nature of the soils; surface cover; rainfall intensity; degree of the saturation of the watershed at the beginning of the rainfall event and surface storage (Dixit and Patil, 1996; FAO, 1991; Singh,

1988). Variability exists as shown by the FAO (1991:8) “in a specific catchment with the same initial boundary conditions (e.g. antecedent soil moisture) a rainstorm of 20 minutes duration with an average intensity of 30mm/h would produce a smaller percentage of runoff than a rainstorm of only 10 minutes duration but with an average intensity of 60mm/h although the total rainfall depth of both events were equal”.

The coefficient runoff of one rainfall event varies, with the duration of the event, soil moisture and the corresponding saturation threshold of the soils. Hence at the beginning of the event, the proportion that turns into runoff will be lower. When saturation is exceeded the proportion of runoff will increase. This applies for permeable surfaces, while for impermeable surfaces the variability may be negligible. With, these factors in mind the parameter should be modified slightly to show an asymptotical increase until it reaches equilibrium as in Equation 6.3.

$$\Delta C = C^\alpha \quad \text{[Equation 6.3]}$$

Thus, the rainfall-runoff equation is shown in Equation 6.4.

$$Q = C^\alpha * I * A \quad \text{[Equation 6.4]}$$

Where

$\alpha$  is a factor that describe the dynamics of runoff during a rainfall event.

FAO (1991) cautions on the use of the runoff coefficients. It advises that using a runoff coefficient derived from another watershed should be avoided and that runoff coefficients for large watershed should not be used for small catchment areas. Regardless of these problems of assuming linearity, a runoff coefficient is still useful for this study due to its simplicity and its limited data requirement.

There are numerous tables that have been derived for runoff coefficient. Table 6-1 and Table 6-2 show the values of C under different surface, rainfalls, soils and slopes.

In addition to the use of a coefficient of runoff to estimate total runoff from a given rainfall event, curve numbers can also be used to estimate runoff (Table 6-3). The curve number method was developed by the US Soil Conservation Services in 1972 (Nath and Bolte, 1998). Curve numbers are computed using the Equation 6.5 and Equation 6.6.

$$Q = \frac{(P - 0.2S)^2}{P + 0.8S} \quad \text{for } P > 0.2S \quad \text{[Equation 6.5]}$$

$$S = \frac{25400}{CN} - 254 \quad \text{[Equation 6.6]}$$

Where;

Q is runoff (mm)

P is precipitation

S is the potential maximum retention after runoff begins

**Table 6-1: Rainfall, surface type and runoff coefficients.**

Surface type and rainfall	rainfall (mm-year)	value of C
Dry tracts with annual rainfall	350-750	15-20
Intermediate zones rain	750-1500	20-30
Higher zone with rainfall	>1500	30-55
Roof and paved areas		80-90

Source: Dixit and Patil (1996)

**Table 6-2: Runoff coefficients for rural areas.**

	Soil Texture		
	Open Sandy Loam	Clay and loam	Tight clay
<b>Topography and vegetation</b>			
Woodland			
Flat 0.5% slope	.10	.30	.40
Rolling 5-10% slope	.25	.35	.50
Hilly 10-30% slope	.30	.50	.60
Pasture			
Flat	.10	.30	.40
Rolling	.16	.36	.55
Hilly	.22	.42	.60
Cultivated			
Flat	.30	.50	.60
Rolling	.40	.60	.70
Hilly	.52	.72	.82

Source: Singh (1988)

**Table 6-3: Runoff curve numbers for different catchment surfaces.**

		Curve numbers for hydrologic soil group		
Land use or cover	Hydrology condition	B Coarse textured valley bottom	C (thin, rocky soils)	D (sealed surfaces)
Fallow	Poor	86	91	94
Small grain	Poor	76	84	88
Semi-arid	<30% cover	80	87	89
Pasture or rangeland	30-70% cover	71	81	89
	>70% cover	62	74	85
Dirt roads		90	90	90

Source: Wesemael *et al.*, (1998)

### Seepage, evaporation and cattle consumption from pans

Runoff water collected in a pan can be stored for a period of time. The length of time is determined by the following factors: the initial volume of water collected in the pan, evaporation, seepage and water consumed by the livestock. Seepage, evaporation and water consumed by the cattle are all believed to be the most important water. Evaporation is one of the most important water losses in semi-arid environment (Els and Rowntree, undated). It is estimated that in Botswana annual evaporation from open water varies between 1, 900 mm and 2, 200 mm (Matlock, 2007). The quantity of the water in the pan can be estimated by a simple water balance model and it can be easily updated on a daily basis. A simple water balance model for water in the pan is shown in Equation 6.7.

$$QP_t = QP_{t-1} - SP - WC - EV + R_p \quad \text{[Equation 6.7]}$$

Where;

$QP_t$  is the current water in the pan ( $m^3$ );

$QP_{t-1}$  is the previous quantity of water in the pan ( $m^3$ );

SP is seepage rate ( $\text{m}^3$  per day);

WC is cattle water consumption ( $\text{m}^3$  per day);

EV is evaporation ( $\text{m}^3$ ); and,

$R_p$  is rainfall (mm)

Seepage is computed either from the surface area of the pan or a function of the volume of water in the pan. In which case, a seepage rate is estimated per square meter. Evaporation is estimated from the surface area of the pans and it is assumed to be a function of temperature and hours of sunshine. Other variables such as windspeed are ignored. Lastly water consumed by the cattle is a function of number of cattle drinking at that pan and daily per capita consumption, which is a function of temperature and forage water content. In this study, seepage and evaporation are estimated by first estimating the amount of water consumed by cattle. Evaporation loss is estimated from evaporation equation which is a function of temperature and sunshine multiplied by surface. The remaining loss, after subtracting evaporation and cattle consumption, is assumed to be seepage loss.

Evaporation is defined as a process whereby water changes from a liquid to a gas (Burman and Pochop, 1994; Penman, 1964). Given the availability of surface water and vegetation there is a distinction between potential and relative evaporation. Potential evaporation is defined as the maximum evaporation that would occur given unlimited surface water supply (Burman and Pochop, 1994; Newsson and Fahey, 2003; Reed, undated). Thus, potential evaporation is theoretical in the sense that it is calculable even when there is no surface water. While actual evaporation is defined as the amount of water that has evaporated from the surface (Burman and Pochop, 1994). The difference between the two is apparent, even when actual evaporation is zero, potential evaporation would be calculable. Evaporation is one of the most important processes in water balance and water budgets, especially in pans (Brutsaert, 1982; Nath and Bolte, 1998). As stated by Brutsaert (1982:1) “the amount and rate of evaporation from water surfaces is information which is required to design storage or to assess the value of natural lakes for such purposes as municipal and industrial water supply, irrigation of agricultural land.” For evaporation to occur, energy needs to be



supplied to surface water known as the latent heat of vaporisation (Arora, 2002; Newson and Fahey, 2003; Penman, 1964). The source of energy is radiant sunshine and it is affected by the following factors: cloud cover, season, and latitude (Penman, 1964). However, some of the heat is radiated back to the atmosphere by the earth's surface as long wave radiation (Penman, 1964).

### **The effect of climate change on pan water**

The effect of climate change on pan water is straight forward compared to its effects on other systems and ecosystems. As pointed out, the quantity of water collected in pans is a function of the amount of rainfall, runoff coefficient and catchment area. Assuming that other factors are constant, climate change through changes in precipitation is positively related to the quantity of water collected in pans. There is a general agreement that climate change will lead to increased annual global precipitation. IPCC (1996) projects that with a 1.5 to 4.5 °C rise in global mean temperature there will be an increase in global mean precipitation of 3 to 15%. But at a regional level, some regions will receive less annual precipitation while others will receive more precipitation (IPCC, 2001). For instance, it is envisaged that a reduction in rainfall as projected by GCMs for the Sahel and Southern Africa could be fatal for the hydrological balance of the African continent (IPCC, 1998; 2007). It is projected that overall there will be an increase in precipitation over the whole of Africa, and by 2050, there will be a decline of about 10% in Southern Africa and Horn of Africa. In the Sahel, expectations are that rainfall will increase by 15% above the 1961-90 baseline averages. Moreover, equatorial Africa could experience an increase of 5%. But at the same time, evapo-transpiration is projected to increase by a range of 5 to 10% by 2050. IPCC (2007) noted that there will be a reduction in precipitation for Sahel and southern Africa.

Besides the IPCC reports, there are numerous others that have looked at the impacts of climate change and water supply. Hulme (1996) looked at the effect of climate change on runoff and precipitation in Southern Africa. In his study, he used three scenarios: core, wet and dry to assess the impacts of climate change on runoff. For the majority of Southern Africa, runoff may decrease by as much as

20% under both dry and core scenarios, while there will be slight increases under the wet scenario. Therefore, his findings are comparable with those of IPCC (1998, 2001).

Schneider *et al.* (1990) argued that with doubling of atmospheric CO<sub>2</sub> annual precipitation in any region will change by an order of  $\pm 20\%$ . However, they cautioned that regional runoff and soil moisture might range between  $\pm 50\%$ . Thus, from the studies it is clear that southern Africa is likely to experience a decline in annual rainfall. Keeping other factors constant from the simple rainfall-runoff model, it means that there will be some decline on the amount of water collected in pans. Lastly, from the computed climate scenarios, particularly for precipitation, there will be a decline in rainfall by 2050. However, this does not automatically mean that these declines may result in a significant change in runoff and quantity of water collected in pans.

## Summary

In this chapter, I reviewed the methodology for pan water formation as one of the key variables in the cattle water demand and supply system. What emerged from the literature was the importance of pans as a source of surface water for both the livestock sector and rural communities. This has been embraced by the government of Botswana which has set-up incentives for the construction and restoration of pans. However, it has been learned that the role played by pans is seasonal and is realised only during the rainy seasons. In addition, it has been found that pans can influence the drinking behaviour and movement of the livestock and wildlife. During the rainy season cattle seldom come to the borehole and this affects the abstraction rate of groundwater. In order to determine the amount of water collected in a pan after a rainfall event a rainfall-runoff model is required. The important variables in the rainfall-runoff model are the runoff coefficient and catchment area. Of these variables, the runoff coefficient is the most important and complicated to determine. From the literature I discovered that the relationship between rainfall and runoff has widely been researched. This has resulted in estimation of runoff coefficients for various land-uses, types and

different soil textures. After determining the amount of water collected in a pan following a rainfall event, a simple water balance model was used to compute daily pan water availability for the study area. Rates that are used include seepage, cattle water consumption, rainfall and evaporation. Lastly, the relationship between climate change (decline in precipitation) and quantity of pan water is inferred.

The next chapter addresses another key variable of the cattle water demand and supply model, forage water content and how it relates to climate change, specifically temperature and rainfall. The impact of climate change on cattle water demand and supply will therefore be reflected through these resources: pan water, forage water content and lastly, temperature as a determinant of water demand.

## Chapter 7 : Forage Water and Climate Change

---

### Introduction

Water obtained from forage constitutes a significant portion to daily water required by cattle. However, it is highly variable both seasonally and also with the maturity of forage. In addition, it is also greatly influenced by precipitation and evapotranspiration from the soils. Obviously, as a portion of total water required by livestock, water obtained from forage has a significant impact on the amount of water provided by farmers known as free water or voluntary water intake. Forage water content directly affects abstraction of groundwater. For instance, it is estimated that when forage is lush, especially at the beginning of the rainy season, forage can contain up to 80% of water. On the other hand during the late stages of the plant, it can contain less than 10%. As it is obtained during feeding (chewing), it can easily be computed as a product of the amount of water moisture per gram in forage and the total forage intake.

It is essential to compute the amount of water obtained from forage by estimating daily forage intake and forage water. Estimating and predicting daily forage intake is not simple. This is because forage intake is a function of multiple factors simultaneously interacting in a complex way. These factors include: environment; forage chemistry; palatability; the gut function of the livestock; farm management and the amount of time cattle trek between forage area and water points. Models for estimating and predicting livestock forage intake have been formulated and they can be categorised into two groups: the empirical models and mechanistic models.

In this chapter, the importance of water obtained from forage and its influence on the abstraction rate is evaluated. Its variability is also scrutinised. In addition, the effects of climate change on forage water content and how it is likely to affect this source of water for livestock is assessed. Though inference is made to the models used to estimate forage intake, this study will not use any of these models. Results from other studies will be used in the model developed for the cattle water demand and supply system.

## **Rangeland productivity in the semi-arid environments**

Aboveground net primary production (hereafter ANPP) defines the productivity of a rangeland. ANPP estimates the amount of biomass produced in a specific area (kg per m<sup>2</sup>), typically per year. Rangelands in semi-arid and arid environments are in disequilibrium, thus ANPP variability is high from one year to another (Abel, 1997; Duraiappah and Perkins, 1999; Pickup, 1996). Sullivan and Rohder (2002) point out that the variability in rainfall in arid and semiarid environments is responsible for the non-equilibrium by disrupting the tight relationship between consumer-resources. Because of variability, estimating productivity of rangelands is complex (Pickup 1996). This is because productivity of a rangeland is influenced by various factors, the most important being precipitation, soil moisture, temperature, evapotranspiration, soil nutrients, competition, light and species diversity (Baars, 2002; Duraiappah and Perkins, 1999; Knapp *et al.*, 2001; Perkins and Owens, 2003; Topp and Doyle, 1996; Wiegand *et al.*, 2004). Some of these factors such as precipitation and temperature are highly variable making productivity highly variable.

However, the issue of whether semi-arid and arid rangelands are at disequilibrium is debated (Illius and O'Connor, 1999; Sullivan and Rohde, 2002). For instance, Ellis and Swift (1988) argued that due to the climatic variations, herbivore population are determined by fundamental nonequilibrium processes in which plants and animals are decoupled. Illius and O'Connor (1999) point out that the dynamics of arid and semiarid grazing systems are influenced by highly variable rainfall and drought causing mortality in herbivores. According to them "this has led to the suggestion that they are nonequilibrium systems, in which animals

impacts on plants are strongly attenuated or absent” (Illius and O’Connor, 1999:798). However, Illius and O’Connor (1999) argue that though it appears that there is lack of equilibrium, herbivore numbers are regulated by limited forage available in key resource areas. Due to this regulation of limited resources on herbivore numbers, their model suggested that strong equilibrational forces exist on the system (Illius and O’Connor, 1999). They conclude that “spatially and temporally, the whole system is heterogeneous in the strength of the forces tending to equilibrium, these diminishing with distance from watering and key resources areas and during the wet seasons” (Illius and O’Connor, 1999:798). More importantly, Illius and O’Connor (1999) note that in most grazing systems population dynamics of both plants and animals are mutually dependent and thus, are in equilibrium. Based on the results obtained from the vegetation-kangaroo dynamics model, Illius and O’Connor (1999:800) argue that “highly variable systems show perturbed equilibrational dynamics, with consumer-resource coupling”. Counter arguments were made by Sullivan and Rohde (2002). They argue that non-equilibrium arguments for arid and semiarid environments are acceptable because the “dramatic variability in productivity in these environments occurs in the timescales that are crucial for management decisions enabling the sustenance of livelihoods based on multifaceted pastoral production” (Sullivan and Rohde, 2002:1597).

Obviously, all these factors are significant in biomass production. For instance, experiments conducted on the grass seedlings on two plots with different shading revealed the importance of the lack of light in ANPP (Lenart *et al.*, 2002). ANPP in plots exposed to more light was high relative to those plots deprived of light (Lenart *et al.*, 2002). Ephrath *et al.*, (1996) experimented with temperature and its effects on the overall development of primary productivity and point out that the rate of plant growth is proportional to temperature. Plants need an optimal temperature for their growth and production. Extreme temperatures, either low or high, causes stress and vegetation does not grow optimally. In other studies such as Wiegand *et al.* (2004) they used temperature as one of the most important determinants of rangeland productivity in South African grasslands. The importance of temperature on rangelands productivity was assessed by Hulme (1996) using BIOME. He found that in Southern Africa, temperature is one of the

factors determining ANPP especially on the grasslands and savannah biomass. Seastedt *et al.*, (1994) also found that modest changes in average temperature have measurable impact on grassland productivity.

Nutrients such as nitrogen play an important role in rangeland productivity. However, in semi-arid environments the most important determinant of rangeland productivity is precipitation (Baars, 2002; Duraiappah and Perkins, 1999; Hulme, 1996; Knapp *et al.*, 2001; Lenart *et al.*, 2002; Li and Ji, 2002; Perkins and Owens, 2003; Seastedt *et al.*, 1994; Wiegand *et al.*, 2004). The importance of precipitation on rangeland productivity is emphasised by the most striking revelation that “worldwide, range productivity in similar rainfall zones of semi-arid to sub-humid regions shows little variation”(Baars, 2002:378). Table 7-1 shows ANPP and precipitation in semi-arid environments in Africa. Another interesting revelation is the discovery that previous precipitation events have an influence on future rangelands net productivity (Wiegand *et al.*, 2004). Wiegand *et al.*, (2004) computed a precipitation memory index to assess influence of previous precipitation to future rangeland productivity.

**Table 7-1: ANPP and precipitation in semi-arid environments in Africa**

Zone (t/ha)	iso-hydrates (mm)	annual production
West Africa	400	1.5
	500	2.0
	750	3.0
	1000	4.0
Western Zambia	550-1000	1.5-4.0
Southern Ethiopia	400-800	1.5-2.7

Source: Baars (2002).

However, the impact of precipitation on ANPP must be critically assessed, especially in the semi-arid and arid environment where evapotranspiration is extremely high. In these environments not all precipitation events contribute to ANPP. Li and Ji (2002) argue that in semi-arid environments precipitation does

not necessarily lead to an increase in net biomass productivity of the rangelands. This is owing to the fact that most of the precipitation eventually evaporates. To assess the contribution of precipitation on rangeland productivity studies have been conducted on the variation between precipitation and biomass. Many studies have discovered that the coefficient of variation (CV) of biomass and precipitation are not correlated. For instance, Wiegand *et al.*, (2004) in the South African grasslands found that the CV of phytomass was higher than the CV of rainfall. Other studies such as Li and Ji (2002) and Knapp *et al.*, (2001) are consistent with Wiegand *et al.*'s., finding, especially in semi-arid environments.

Perkins and Owens (2003) assessed the effect of reduced summer precipitation on grass and shrubs in semi-arid environments. They found that reduced precipitation did not have any significant effect on ANNP of grass and shrubs. The reasoning behind the unexpected relationship was that reduced precipitation on the experimental plots did not have any significant effect on the amount of soil moisture (Perkins and Owens, 2003). They concluded, “consequently, we hypothesize that small changes in precipitation patterns in semi-arid environments may not cause a proportionate change in the amount of soil moisture available to seedling growth and establishment due to other environmental factors” (Perkins and Owens, 2003:115). The findings and argument are supported by Fay *et al.*, (2000) who noted that a reduction in precipitation does not automatically lead to reduced soil moisture content especially after soils have received plenty of water. Burman and Pochop (1994) further emphasised the importance of soil moisture by pointing out that soil provides both the structural support and a reservoir of water for a plant's growth. Soil with a moisture deficit will inhibit plant growth ultimately leading to the plants loss of more water through transpiration than they would take in. When this occurs vegetation, especially short root plants, wilt and die (Burman and Pochop, 1994).

In light of this, Wiegand *et al.*, (2004) used effective precipitation to assess the impacts of precipitation on rangelands productivity. They computed effective precipitation as a product of temperature index and precipitation. While Pickup (1996) in his study allowed for evapo-transpiration in modelling rangeland productivity.



Soil moisture and the corresponding evapotranspiration chiefly determine growth and ANNP of rangelands (Hulme, 1996). Early rains followed by long dry periods generally results in seedlings wilting due to a prolonged moisture deficits, this is common in Botswana.

### **Precipitation, evapotranspiration and soil moisture**

Soil moisture for vegetation growth is supplied by precipitation in semi-arid environments, where water tables are extremely low. Factors that determine water storage capacity for soils are soil texture, organic material, mineral and biological constituents and the disturbance of the soil structure (Burman and Pochop, 1994; Hulme 1996; Kirkham, 2005; Nielsen *et al.*, 1972). For instance loam, sandy and clay soils all have different water storage capacity (Burman and Pochop, 1994; Saxton *et al.*, 1986; Vorosmarty *et al.*, 1989). As precipitation is the only source of soil moisture in semi-arid areas, it means that the amount of precipitation will determine soil moisture, thus, the initial input is the amount of precipitation received but not the storage capacity. Soil moisture is stored in the pores of the soil and drawn by the plants roots for transpiration (Burman and Pochop, 1994; Kirkham, 2005). A pore space can be defined as a portion of the soil that is occupied by either air or water. Conversely, it is the space between the soil particles that is occupied by air and can be readily filled with water during wet events (rainfall and irrigation). In addition, the pore spaces enable movement of solutes between soil layers (Kirkham, 2005). Thus, the pore spaces soil determine the amount of water that a defined volume of soil can hold. Porosity is a term that is generally used to define the pore spaces in the soil. Todd (1980:26) defined porosity as a “measure of the contained interstices or voids expressed as a ratio of the volume of interstices to the total volume”. The soil reaches a saturation point when all the pores are filled with water and any extra precipitation water is instantly turned into surface runoff.

The three most important soil water attributes when modelling soil water for plants are field capacity (hereafter FC); wilting point (hereafter WP); and, available soil water (hereafter ASW). Water holding capacity can be defined as

the ability of the soil to store water. Though water holding capacity defines the amount of water in the soil, it does not define soil water available to plants as some of the water will drain due to gravitational force. According to Burman and Pochop (1994) and Kirkham (2005) after 1-2 days excess water will drain and the amount of water hereafter held by the soil reaches equilibrium after a wetting event, and this is known as either the field capacity of the soil or drained upper limit (hereafter DUL). Kirkham (2005) considers that field capacity is an imprecise term. He argues that “they (soil scientists) saw that it was not a unique value, because equilibrium is never reached” (Kirkham, 2005:102). FC does not have a unique value because soil water is highly dynamic as a result of drainage, evapotranspiration, dewdrops and rainfall. Regardless, the term remains in use as Kirkham (2005:103) points out “one is often asked to provide the field capacity for a soil when publishing a paper”. The difficulty in estimating the FC and its imprecision can be attributed to the fact that there are various factors that affect FC. They include: soil water history; soil texture and structure; type of clay; organic matter; temperature; water table; depth of wetting; presence of impeding layers; and evapotranspiration (Burman and Pochop, 1994; Kirkham, 2005)

Another important attribute in defining a soil water budget is WP also known as the permanent wilting point (hereafter PWP). WP is defined by Kirkham (2005:104) as “the amount of water per unit weight or per soil bulk in the soil, expressed in percent, that is held so tight by the soil matrix that the roots cannot absorb this water”. At the wilting point plants will die. Just like FC, Kirkham (2005) points out that WP is dynamic and dependent on soil texture, compaction and stratification, and the type of plant. Different plants have different WP. Burman and Pochop (1994) agree by noting that soil water changes with soil depth and therefore while soil water may be below the WP at the ground surface, at the deeper layers the soil water content may be above the WP. WP and PWP can be used interchangeably. With the two soil water concepts FC and WP, ASW also known as plant extractable soil water (hereafter PESW) can be defined. ASW is the amount of soil water readily available to plants. ASW is defined as water between the FC and WP as defined by Equation 7.1 (Allen *et al.*, 1998; Burman and Pochop, 1994; Kirkham, 2005).

$$ASW = FC - WP \quad \text{[Equation 7.1]}$$

The rationale for defining ASW as above is that water above FC is not available to plants as it quickly drains by gravitational force. Conversely, water below the WP is held strongly to the soil particles by forces that make it virtually impossible for the plants to extract it (Reed, undated). Allen *et al.*, (1998) estimate the typical suction values for FC and WP is -10 kPa and -1500 kPa, respectively.

Soil water capacities for different soil types and textures have been estimated over the years. This has been done through equations that have been developed to estimate soil-water content from soil texture and organic matter. Gupta and Larson (1979) developed a soil water content method given percentage of the following: sand, silt, clay, organic matter and bulk density. Burman and Pochop (1994) and Rawls *et al.*, (1982) have prepared tables on FC, WP, PESW or ASW and effective porosity for different soil textures.

The dynamics of the soil water content can be modelled by a simple soil-water budget equation (Equation 7.2):

$$w_t = w_{t-1} + P - P\alpha_{t-1} - PE\beta_{t-1} \quad \text{[Equation 7.2]}$$

Where,

$w_t$  is the current soil water;

$w_{t-1}$  is the soil moisture in the previous time period;

P is precipitation;

PE is potential evaporation;

$\alpha$  is the runoff extraction function;

$\beta$  is the soil moisture extraction function; and,

t is the time factor.

By the definition of FC, it means that at FC, runoff and drainage can be ignored or is zero. Thus, at FC the dynamics of the soil water at a particular soil depth, can be modelled as in Equation 7.3.

$$w_i = w_{t-1} + P - PE\beta_{t-1} \quad \text{[Equation 7.3]}$$

The soil moisture extraction function is an important component in estimating evapotranspiration. When the soil moisture declines, evapotranspiration also declines. The coefficient of evapotranspiration is defined as the rate of evapotranspiration to the potential rate of evapotranspiration which is based on the function of the current soil moisture content and moisture content retention properties of the soil (Reed, undated). There is a general pattern of behaviour that moisture follows when extracted from the soil (Reed, undated). This pattern occurs up to a point where there is a crucial moisture level, at which point a linear or non-linear decline in soil moisture extracted by evapotranspiration is achieved (Reed, undated).

### **Soil characteristics in the study area and soil water content**

Soil water content that is relevant in this study is from the top layer to the root level of the forage. Total available soil water is calculated by the method of integrating the available soil water over the depth of the roots of forage. In the Masama Ranch, the dominant soil type is Ferralic Arenosol (GSC, 1999; Nachtergaele and de Wit, 1990). Arenosols are defined as soils that are coarser than sandy loam and are generally found in arid to peri-humid environments under scattered mostly grassy foliage (FAO, 2005). FAO has estimated the soil moisture storage capacity (SMSC) of different soil units. The following are the soil moisture storage capacity for Ferralic Arenosols (FAO, 2005). Table 7-2 gives the soil moisture storage capacity (hereafter SMSC) for Ferralic Arenosols which is found in the Khurutshe area. The type refers to the size of the soil particles.

**Table 7-2: SMSC for ferralic Arenosols.**

Type	Coarse	Medium	Fine
SMSC (mm)	106	180	165

## Towards modelling evapotranspiration

Soil water content, as pointed out, is determined by various factors including evapotranspiration. Evapotranspiration is a combination of two processes being evaporation and transpiration. It involves water being lost from the soil surface and from crops by transpiration. The two processes take place at the same time such that their distinction becomes impaired (Allen *et al.*, 1998). However, it is pointed out that the proportion of water lost through either evaporation or transpiration differs according to the growing season. Allen *et al.*, (1998) estimated that at sowing stage nearly all the water lost is from evaporation but when crops are fully grown more than 90% of water lost is due to transpiration. For evapotranspiration to occur, three conditions must be met: firstly, there must be a vapour pressure gradient between the surface and the air above; secondly, there must be a supply of water; and lastly, there must be a source of energy to supply the latent heat of vaporization (Dagg and Blackie, 1970; Penman, 1948; Yang and Yanful, 2002).

In discussing evapotranspiration, four types are important: actual evapotranspiration (hereafter  $ET_a$ ); potential evapotranspiration (hereafter  $ET_m$ ); crop evapotranspiration (hereafter  $ET_c$ ); and, reference crop evapotranspiration (hereafter  $ET_o$ ). Actual evapotranspiration is the rate of evapotranspiration occurring given available or limited soil moisture and other climatic conditions. Rosenberg in Kirkham (2005:455) defines  $ET_m$  as “the evaporation from an extended surface of a short green crop which fully shades the ground, exerts little or negligible resistance to the flow of water, and is always well supplied with water”. Simply put, potential evapotranspiration is the maximum evapotranspiration given unlimited water supply, thus sometimes it is referred to as maximum evapotranspiration.  $ET_c$  is defined by Allen *et al.*, (1998:6) as “evapotranspiration from large well-watered fields that achieve full production under the given climatic conditions”. Burman and Pochop (1994:3) however defined  $ET_c$  as “evapotranspiration from a specific plant growth under defined conditions including soil water, fertility, and other cultural conditions”. Lastly,

$ET_o$  is a climatic parameter expressing the evaporation power of the atmosphere (Allen *et al.*, 1998). Crop evapotranspiration is a product of reference evapotranspiration and a crop coefficient, where a crop coefficient is defined as a dimensionless ratio that relates the specific crop to a reference evapotranspiration at a point in time (Allen *et al.*, 1998; Burma and Pochop, 1994). Crop coefficients vary with stage of growth and also with seasonality (Allen *et al.*, 1998; Burman and Pochop 1994). Thus actual evapotranspiration referred to as crop evapotranspiration can be estimated Equation 7.4.

$$ET_c = K_c * ET_o \quad \text{[Equation 7.4]}$$

Where,

$K_c$  is the crop coefficient; and,

$ET_o$  is the reference crop evapotranspiration.

If all three conditions that facilitate evapotranspiration to occur are met, climatic conditions and soil properties become the only limiting factors which control evaporation from the soil (Yang and Yanful, 2002). For instance, it has been observed that where there is limited soil water, then water controls soil evaporation and evaporation declines rapidly, ceasing in a short period of time (Allen *et al.*, 1998). Due to the limitation of soil water, three stages of evaporation in soil have been identified (Yang and Yanful, 2002). However, Kirkham (2005) only identified two-stages by integrating the last two stages into one stage. The three stages identified are:

- Stage I called the initial constant-rate evaporation where evaporation is not limited by water availability but by supply of energy;
- Stage II called the first falling-rate evaporation; and,
- Stage III called the second falling-rate evaporation.

The last two stages are where evaporation is controlled by movement of water availability and movement to the surface of the soil. Therefore, under the last two stages, the soil experiences declining evaporation until it reaches the residual evaporation rate. This is because as the soil continuously loses water, the

remaining soil moisture becomes increasingly bonded to the soil by forces. Due to the limitation of soil water to evapotranspiration, Burman and Pochop (1994) estimate actual evapotranspiration as in Equation 7.5.

$$ET_a = SWET_m \quad \text{[Equation 7.5]}$$

Where

$ET_a$  is actual evapotranspiration;

SW is dimensionless decimal correction for soil depletion below permanent wilting point, and;

$ET_m$  is maximum evapotranspiration at a specific time.

SW is basically the same coefficient as the soil moisture extraction function,  $\beta$ . However, below the permanent wilting point evapotranspiration can be said to be virtually non-existent as the remaining soil moisture is held by great forces making extraction by the plants impossible. In addition, one could argue that below the permanent wilting point evapotranspiration is not possible as the plants are already wilting and dying.

Evapotranspiration is an important process in hydrology, agriculture and water planning and as a result, intensive work on its estimation has been carried out. Basically, knowledge of evaporation rates from open waters is important in allocating optimal water-allocation schemes for sustainable utilization of wetlands. At the same time it is important in irrigation schemes for optimal irrigation without leading to water-logging. Thus, there have been many equations that have been derived to measure evapotranspiration (Grismer *et al.*, 2002; Hargreaves *et al.*, 2003; Mosner and Aulenbach, 2003; Pochop *et al.*, 1985). A count by Burman and Pochop (1994) is that close to 50 equations have been developed to calculate evapotranspiration. Pochop *et al.*, (1985) note that many of these equations are based directly on the equation derived by Penman in 1948.

Consequently, there are three main approaches to estimating evapotranspiration: the energy budget method; the empirical methods; and, the hydrologic models (Burman and Pochop *et al.*, 1985; Penman, 1948; Winter and Rosenberry, 1995).

A fourth approach is a combination of the energy budget and empirical approaches. Thus, the choice of a method for a particular assessment depends on the availability of data. The energy budget method relies on the amount of energy that is required to evaporate a unit amount of water at air temperature (Penman, 1948). He argues that given the unit energy required to evaporate 1/10g of water then “it is possible to build up the following expression for the heat budget, taking into account the incoming short-wave radiation from the sun and sky, and the long-wave exchanges between earth and sky” (Penman, 1948:123). Therefore the energy budget method requires estimation of net radiation (Brutsaert, 1982).

The most widely used and commonly known evapotranspiration equation is by Penman (1948). The Penman equation is a combination of theoretical energy balance and empirical wind functions (Burman and Pochop, 1994). The original Penman evapotranspiration equation is depicted by Equation 7.6.

$$\lambda ET = \frac{\Delta}{\Delta + \gamma} (R_n + G) + \frac{\gamma}{\Delta + \gamma} 6.43 f(e) f(u) \quad \text{[Equation 7.6]}$$

Where;

$R_n$  is the net radiation;

$G$  is the soil heat flux;

$\Delta$  is the slope of the saturation vapour pressure-temperature curve;

$\Gamma$  is the psychrometer coefficient;

$\Lambda$  is the latent heat of vaporisation;

$F(e)$  is the function of vapour pressure deficit; and,

$f(u)$  is the function of wind speed.

Other methods rely solely on temperature to estimate daily and monthly evapotranspiration rates. These methods use temperature as the surrogate to energy required to vaporise water (latent heat of vaporisation). They are generally preferred due to easy accessibility of the temperature and sunshine data. Burman and Pochop (1994) argue that generally, hydrologists and water planners are faced with the enormous tasks of estimating evaporation given available climatic data and the temperature methods become handy and useful. One such method is the Blaney-Criddle method. The Blaney-Criddle method has been extensively used



over the years especially in the western USA (Allen *et al.*, 1998). In addition, just like the Penman method, the Blaney-Criddle method has been modified over the years. The two popularly modified versions are the SCC Blaney-Criddle method and the FAO-24 Blaney-Criddle method.

The Blaney-Criddle method found that evapotranspiration is closely correlated to mean monthly temperature and daylight either or sunshine hours. However, there are some criticisms towards the Blaney-Criddle method such as there is no direct relationship between temperature and energy required to vaporise water for evapotranspiration (Burman and Pochop, 1994). The original Blaney-Criddle method was derived to estimate consumptive use or evapotranspiration on a monthly basis but with the right modifications it can be used to estimate evapotranspiration on a daily, weekly, monthly and seasonal basis (ASCE, 1990). In addition, it is recommended that for the Blaney-criddle method or any other evapotranspiration method to produce realistic evapotranspiration results they should be locally calibrated (Burman and Pochop, 1994). For the Blaney-Criddle method, local calibration involves regressing measured evapotranspiration against temperature (Burman and Pochop, 1994). Other scientists have taken a further step and shown that the Blaney-Criddle method gave better results when using solar radiation instead of the monthly percent of daytime hours.

The original Blaney-Criddle method is depicted in Equation 7.7.

$$ET_o = 25.4K_c'F \quad \text{[Equation 7.7]}$$

Where,

$K_c'$  is the an empirical seasonal consumptive use coefficient; and,

F is the sum of the monthly factors f, derived by Equation 7.8.

$$f = \frac{(1.8T + 32)P}{100} \quad \text{[Equation 7.8]}$$

T is the average air temperature

P is the monthly percentage of daytime in a year

According to Burman and Pochop (1994) the use of the  $K_c'$  coefficient did not enable monthly estimations of  $ET_a$  and therefore for monthly calculations, Equation 7.9.

$$u = 25.4k_c' f \quad \text{[Equation 7.9]}$$

Where,

$U$  is the monthly consumptive use; and,

$k_c'$  is the monthly consumptive use coefficient.

The SCS Blaney-Criddle method was modified by the US Soil Conservation Service and this version has been widely applied to the western US and also by the FAO. The SCS Blaney-Criddle method is depicted as in Equation 7.10, where  $k_t$  is estimated by Equation 7.11.

$$ET_a = \bar{k}_c k_t f \quad \text{[Equation 7.10]}$$

where,

$\bar{k}_c = \text{consumptive use coefficient}$

$$k_t = 0.0311T + 0.24 \quad \text{[Equation 7.11]}$$

$k_t$  is a climatic coefficient related to the mean air temperature

It is derived by regressing  $ET$  against air temperature (Burman and Pochop, 1994). Therefore, the value of  $k_t$  varies from location to location and for different crops. For instance, Pochop *et al.*, (1984) estimated the value of  $k_t$  for alfalfa under different altitudes as in Equation 7.12.

$$k_t = 0.0254T + 0.376 \quad \text{[Equation 7.12]}$$

The SCS Blaney-Criddle method is therefore estimated by Equation 7.13.

$$ET_a = k_c \bar{k}_t \frac{(1.8T + 32)p}{100} \quad \text{[Equation 7.13]}$$

There are various definitions of day-length or hours of sunshine (Forsythe *et al.*, 1995). In Botswana, day-length is defined as the time during which the centre of the sun is above the horizon (Bhalotra, 1987). Percent of sunshine hours per day or month is a function of the angle of sunset and also latitude (Burman and Pochop, 1994; Forsythe *et al.*, 1995; Thornton *et al.*, 1997). In addition, sunshine hours vary with the location upon the earth and day of the year (Forsythe *et al.*, 1995).

There are various equations that have been derived over the years to model daily percentage of sunshine. In this study neither of the equations will be used to estimate daily percentage hours of sunshine. This is because of the belief that climate change as a result of CO<sub>2</sub> and other greenhouse gases will not have an effect of hours of sunshine. The hours of sunshine in the country are recorded on a daily basis at the country's synoptic stations located in urban areas and major villages. Therefore, average observed hours of sunshine based on 25 years from 1975 to 2004 are used in calculating evapotranspiration. Figure 7.1 shows observed mean sunshine hours from 1975-2005 for the study area. Winter months, May, June July and August record the highest sunshine hours relative to other months. Thus, in estimating evapotranspiration rates, the average value for the 12 months is used and this is estimated at 8.6 hours of sunshine per day.

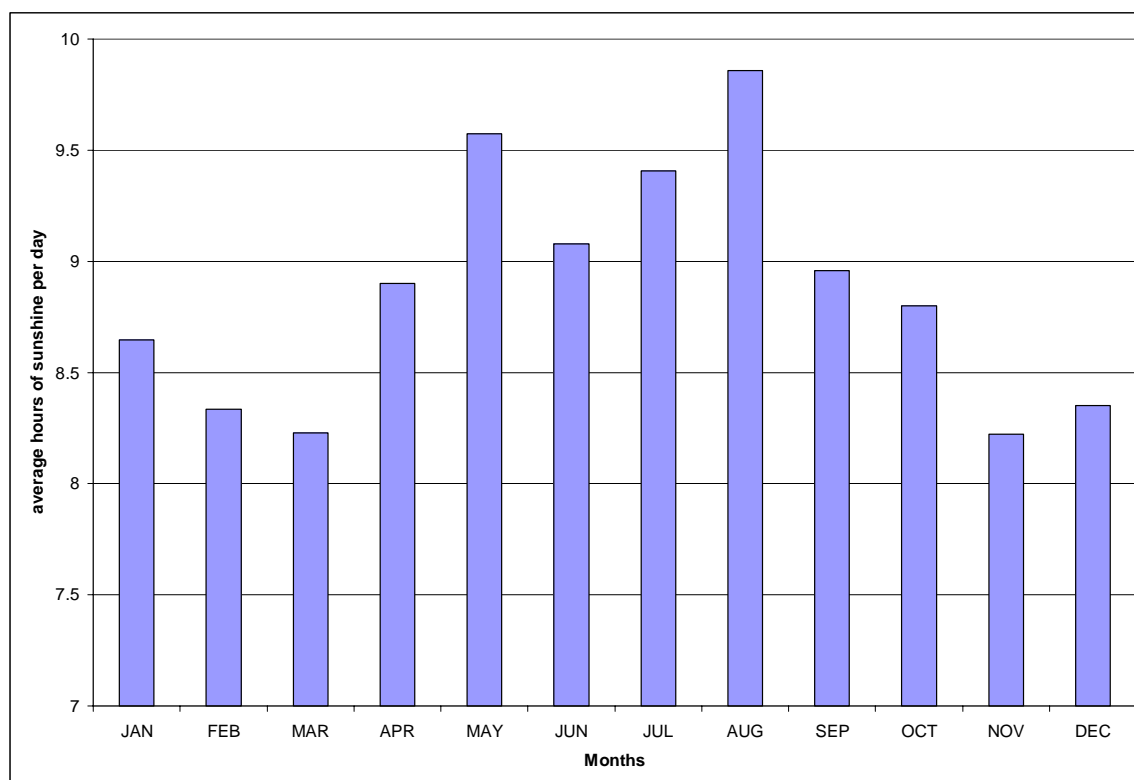

**Figure 7.1: Observed average sunshine hours for Khurutshe area.**

Local calibration of the SCS Blaney-Criddle method involves regressing observed daily evapotranspiration and against daily temperature. However, if no data exists for the evapotranspiration, it is recommended that the evaporation data from a Class A evaporation pan can be used (Allen *et al.*, 1998). With evaporation data from a Class A evaporation pan Equation 7.14 is used to calculate crop reference evapotranspiration:

$$ET_o = K_{pan} * E_{pan} \quad \text{[Equation 7.14]}$$

Where,

$ET_o$  is the reference crop evapotranspiration;

$K_{pan}$  is the pan coefficient; and,

$E_{pan}$  is the pan evaporation.

It is estimated that the value of  $K_{pan}$  for a Class A evaporation varies between 0.35 and 0.85 with an average of 0.70.

## Modelling forage water content in the Masama Ranch

As pointed out, forage water content is a function of soil water and evapotranspiration. Other factors that influence forage water content which are of less relevancy is the age of forage (Baars, 2002; Borreani and Tabacco, 1998; Wiegand *et al.*, 2004). However, if it rains through out the year this factor is of less significance. In this study a soil moisture index was derived and used to model forage water content. A soil moisture index was derived by Equation 7.15.

$$SMI = ASM - WP \quad \text{[Equation 7.15]}$$

Where,

SMI is the soil water index;

ASM is the available soil moisture at a point in time; and,

WP is the wilting point as defined previously.

For modelling purposes in this study, the SMI takes a value of one or zero as in equation 7.16.

When,

$$\begin{aligned} ASM > WP; \text{ then, } SMI &= 1 \\ ASM < WP; \text{ then, } SMI &= 0 \end{aligned} \quad \text{[Equation 7.16]}$$

The rational for using SMI as above is that when SMI is greater than zero then forage is able to draw water from the soil but if SMI is less than WP then forage will not be able to draw water from the soil and will wilt.

Using the above conditions, forage water content was estimated using Equation 7.17.

$$FWC = \alpha FWC_{t-1} + \beta SMI \quad \text{[Equation 7.17]}$$

Where

$\alpha$  is a coefficient of FWC (dimensionless)

$\beta$  is a coefficient of SMI (dimensionless)

### Estimating water intake from forage

In estimating water intake from forage, it is essential to know the amount of forage intake by the cattle. In this study, the amount of water derived from forage is estimated using Equation 7.18.

$$W_f = Q_{\text{forage intake}} * WC_{\text{forage}} \quad \text{[Equation 7.18]}$$

Where,

$W_f$  is the water intake from forage (liters day<sup>-1</sup>);

$Q_{\text{forage intake}}$  is the quantity of forage intake (kg day<sup>-1</sup>); and,

$WC_{\text{forage}}$  is the amount of water in forage (l kg<sup>-1</sup>).

To compute water obtained from forage, daily forage intake must be estimated. However, estimating and predicting forage intake of grazing animals is not easy (Coleman and Moore, 2003). Currently, available models developed to estimate and predict cattle forage intake are performing rather poorly (Roseler *et al.*, 1997). The complexity of estimating forage intake arises as intake is influenced by various factors that are complex and also interact in a complex manner to determine the amount of forage an animal actually takes i.e., forage intake is not constant but fluctuates (Coleman and Moore, 2003; Roseler *et al.*, 1997). Coleman and Moore (2003) define voluntary intake as the maximum consumption that an animal can take when there is no limitation on the amount of forage available.

There are various factors that influence forage intake. They are: environmental factors; quantity and quality of forage; and farm management strategies. Topp and Dolye (1996) highlight three factors: feed availability; the physiological limit of

forage intake; and, the physical ability of the animal to consume feed. In this study farm management refers to herding, as it affects forage intake directly by determining the amount of time that animals are allowed to graze. There are two predominant herd management systems in Botswana. The first one and the most prevalent is a system where livestock are allowed 24 hours access to grazing. Livestock are only kraaled during vacation and branding. This practice is predominately found in areas where predation is not common and in most cases when farmers do not milk their livestock. The second system is when livestock is kraaled at sunset and let off at sunrise. Obviously, these distinct herding strategies have an effect on the hours of grazing and corresponding amount of forage intake. Linked to herd management is the distribution of water between the grazing points. If the distance between the two is high then cattle spend considerable time trekking between water points and therefore less time is spent on grazing. In semi-arid rangelands such as Botswana the distance is high, as high as 10-15 km (Nicholson, 1987). The effect of distance between water points and grazing areas is felt more by animals that are kraaled at night. Those that are kraaled graze during the night and come to the borehole when it is hot. This is noted by Pickup (1996).

Another factor that influences forage intake is forage quantity and quality (Meissner, 1997; Pickup, 1996; Roseler *et al.*, 1997). This is an area where considerable research has been conducted yet makes estimation of intake difficult. Pickup (1996:822) explains that “intake per animal increases up to an asymptotic value with both the amount of forage present and its greenness”. His forage model reveals that forage intake is highest when the vegetation is green as palatability has a significant effect on the daily forage intake (Baars, 2002; Meissner, 1997; Pickup, 1996). Baars (2002:380) remarks “ruminant livestock cannot compensate for poor quality by consuming more feed as their dry matter intake is reduced as the digestibility and the crude protein concentration of the forage on offer decrease below optimum levels”. This occurs as the dry matter intake increases the reticulo-rumen that is filled up and therefore the rate of digestion is considerably reduced. When the reticulo-rumen is filled up the passage from the rumen acts as a mechanism that physically limits the forage intake (Baars, 2002; Coleman and Moore, 2003; Poppi *et al.*, 1994). For instance, Meissner (1997)

found that forage that is generally avoided are leaves containing low crude protein. They limit forage intake because this “results in lower digestibility, slower fermentation rate and particle size reduction in the rumen which slows down passage rate of residue from the rumen, thereby reduces intake” (Meissner, 1997:106). According to Meissner (1997) intake is limited when neutral detergent fiber concentration is 550-600 g per kg dry matter. Thus Coleman and Moore (2003:19) pointed out that “regulation of intake is an interaction of forage characteristics, the rumen and the host animal”. However, it is argued that when forage is highly digestible then the rumen and the passage do limit intake (Roseler *et al.*, 1997).

### **Models for estimating daily forage intake**

Models for estimating daily forage intake are necessary for this study as they facilitate calculation of the precise amount of forage taken by the livestock. This figure can then be used to estimate the amount of water that livestock obtained from the forage. Coleman and Moore (2003) and Meissner (1997) define two models for daily forage intake: mechanistic, also known as rational; and, empirical. The empirical models are those that are derived by simply fitting an equation that best explains the behaviour of intake to the data (Meissner, 1997). These models are less complicated and need experimental data for the empirical equations to be formulated. Empirical equations are based on one or more chemical components of forage (Coleman and Moore, 2003). Though they are less complicated, Meissner (1997) remarks that they are often very useful on one condition; when they are based on laboratory experiments. Coleman and Moore (2003) note that empirical models fail to estimate intake accurately due to the variations in the relationships among the analytes and forage quality, as a result of seasonality, weather and other variables. Variables used to estimate intake are crude protein, neutral detergent fiber, and acid detergent fiber, and cell wall. These variables can be used either combined or alone. Generally, multiple regression empirical equation will use a combination of these variables (Coleman and Moore, 2003).



Mechanistic models are more complicated. According to Meissner (1997:106) “most mechanistic approaches have centralised rumen functions with rumen fill, fermentation rate and passage from the rumen as prominent features”. Coleman and Moore (2003) point out that the mechanistic models were developed only on a theoretical basis. Given, the problems of both methods neither of them will be used to estimate daily forage intake. A simple approach that is used to estimate daily forage intake is the proportion of forage intake to the live weight of the cattle. Studies have found that cattle consume 2-5% of their body weight.

### **The effects of climate change on forage water**

Climate change will affect forage production and forage water in various ways through changes in precipitation and temperature. However, the effect of climate change on production is beyond the scope of this study. The effect of climate change on forage water content will be through precipitation. A reduction in rainfall will affect soil moisture content. The relationship between soil moisture content and forage water content is positive, that is soil moisture content above wilting point results in an increase in forage water content while soil moisture content below wilting point results in decrease forage water content as transpiration will be greater than uptake of soil water. Thus, with reduced rainfall, as indicated by the computed climate scenarios for the study area, forage water content may be affected negatively. On the other hand, an increase in temperature will increase transpiration of forage thus, from the simple soil water budget model, soil moisture will be reduced through reduced rainfall and will be quickly depleted through increased transpiration. Hulme (1996) assessed the impacts of climate change on southern Africa rangelands using three scenarios; wet, dry and core scenarios. He observed that temperature and soil moisture under climate change seriously hampered grassland and savanna biomass production. However, it should be noted that reduced precipitation does not automatically lead to reduced soil water content. The change in rainfall only affects the excess water drained by gravitational forces but may not affect the field capacity which is basically the relevant water for forage transpiration. If that is the case then temperature will be the only variable that may affect forage water content.

Overall, climate change may negatively affect forage water content. This is because the balance in soil moisture is determined by interactions between soil properties, rainfall, temperature and evaporation, and this drives the productivity of plants species (Hulme, 1996). As climate change will be accompanied by elevated concentration of atmospheric CO<sub>2</sub>, the impact could be accelerated transpiration (Baker and Viglizzo, 1998). At the same time climate change may increase the severity, length and intensity of the dry season through reduced rainfall. Caesele (2002) concluded that the duration of dry periods between deluges is projected to increase in Manitoba as warmer temperatures will drain both soil and crops of water. Other authors have also indicated that climate change will have an effect on the quality and quantity of livestock forage (Hulme, 1996; IPCC, 2001). For instance, Hulme (1996) indicated that one of the impacts of climate change in Southern Africa will be replacement of grassland by shrub. While Christensen *et al.*, (2004) showed that the interaction of grazing and climate change (changes in temperature, rainfall and CO<sub>2</sub> concentration) will lead to some change in vegetation composition in Mongolia.

## Summary

In this chapter I outlined the methods for estimating forage water content and soil moisture as key variables in the cattle water demand and supply system. What emerged from the review is that forage water content constitutes what is known as involuntary water intake for livestock. This portion of the total water requirement can be significant and can affect daily water intake. A model to estimate the amount of water taken from forage has been developed based on forage intake and the percentage of water in forage. It was gleaned from the literature that estimating daily forage intake is complex. Mechanistic and empirical models have been developed to overcome this complexity. The modelling of soil water content was achieved through the application of a soil water budget model. The model for forage water content was derived using the soil moisture index derived from the soil water budget model and was then based on the permanent wilting point and the soil water holding capacity.

Having described the methodologies for the key components of cattle water system: rainfall-runoff and pan water; forage water content, climate scenarios for rainfall and temperature; it is now appropriate to construct the cattle water demand and supply model with the aim of investigating the impacts of climate change on water demand and supply. The next chapter is therefore, devoted to the cattle water demand and supply system.

## Chapter 8 : Development of the Cattle Water Model

---

### Introduction

Cattle reared for the market in Botswana are largely grazed on a grass-based system. The system has components that interact with each other to facilitate productions of beef or milk and functions as discussed in chapter three. In developing a dynamic model for cattle water demand-supply for Masama Ranch, steps depicted in Figure 4.7 are followed (Bossel, 1994; Coyle, 1996; Moffatt, 1991). The model structure was developed based on the observation of the cattle water demand and supply in Masama Ranch and cattle posts in the Kgatleng District and also from discussions and interviews with farmers. In addition, the model was constructed bearing in mind the objectives and questions of this thesis.

Derivation of the equations for the functional relationships between variables was achieved from data collected from the Masama Ranch on a daily basis for nine months. Thus, most of the equations are empirically fitted to the collected data. The model was then simulated and validated based on the criteria set for model validation. The model was run for 240 days and not the whole year as data was only collected for nine months and validation was based on this period. It should be emphasised that validity entails many aspects therefore only those aspects that are deemed crucial were used to validate the model. Emphasis is placed on the following criteria: structural, dimensional, statistical character, plausibility of the results and behavioral reproduction which entails reference mode of behaviour. Sensitivity analysis of the model is conducted by arbitrarily changing temperature to see the effect on demand and abstraction for groundwater. It was appropriate to change temperature as it is the major determinant of water demand. Lastly,

environmental sustainability of the groundwater abstraction in the Masama Ranch was assessed. Results show that rainfall and temperature have a bearing on abstraction of groundwater and hence sustainability of groundwater utilization for cattle consumption.

### **Cattle water system**

Water is an important component of livestock rearing. It is a vital resource in cattle production and often needed by livestock on a daily basis for their survival and optimal production. However, some benefits can be derived by watering livestock three to four times a week and not on a daily basis (Nicholson, 1987), such as conservation of scarce water resources and optimizing grazing as cattle spend more time grazing as opposed to trekking between water points and grazing areas. In semi-arid environments, water is one of the limiting factors in livestock production. For instance, from the discussion and interviews with farmers, they pointed out that water is the most costly input in cattle production. Farmers who want to venture into cattle farming are prevented from doing so by either the unavailability of water or sites to drill for groundwater. This is especially true in the Kgatleng District where finding a site that meets the 8km radius is impossible. During drought years, livestock in the Kgatleng District are more vulnerable compared to other Districts. In the Kgatleng District livestock are heavily reliant on groundwater. Farmers pump groundwater into large storage tanks using diesel-powered engines (Figure 8.1 and Figure 8.2). Before independence, the most prevalent pump were windmills, however this has changed due to affluence and the unreliability of strong winds in the country. In Kgatleng District, only one functional windmill remains. The size of a storage tank is generally proportional to the initial size of the herd that a farmer or a syndicate owns. However, pumping of groundwater is mostly done on a daily bases. Factors affecting pumping of groundwater are as follows:

- number of cattle that a farmer has;

- temperature and seasonality. Discussion with farmers reveal that during the summer season pumping on average is 12-18 hours, while in winter, when it is cold, pumps are run on average 6 hours;
- During the rainy seasons cattle drink from the pans and when above normal rainfall occurs, water pumps can be idle or inactive for all the rainy months;
- Farmers assert that the state of grass is one of the determinants of daily water consumption per capita. They remarked that when grass is very mature and dry cattle drink water frequently compared to when forage is new and lush.

Cattle drink water from the troughs (Figure 8.3) which are supplied through a single pipe with a valve. Herd boys manually control the valve, as soon as the livestock start drinking and the water level in the trough drops, the valve is opened to refill the troughs. Therefore daily water consumption is also influenced by the presence of labour. For instance, when it has rained and pans are filled with water, herd boys do not go to the boreholes as they know cattle drink from the pans. In addition, during the hot and dry season, cattle may want to drink twice but the herd boys opt to come to the boreholes only in the mornings. The volume of water in pans is a function of rainfall and the pan's catchment area. Moreover, the rate at which water in the pan is lost is determined by seepage and the amount of consumption by the livestock. Lastly, the amount of water consumed by the livestock is determined by the quality of that water. A parameter that can be easily used to measure quality is the age of water in the pan.

From the description of the cattle water system, it is apparent that the system is by itself a dynamic system which is affected by continuously changing variables, especially temperature and rainfall. Therefore, the system can be understood better by a system dynamics model. In addition, a system dynamics model can give insights into the effect of climate change on a cattle water demand-supply system.



**Figure 8.1: Borehole and pump in Masama Ranch**



**Figure 8.2: Water storage tank in Masama Ranch.**



**Figure 8.3: Cattle drinking from a trough in Masama Ranch**

### **Purpose of the model**

The cattle water model is developed with the ultimate purpose of investigating the impacts of climate change (changes in temperatures and precipitation) on cattle water demand and supply in a semi-arid environment where groundwater accounts for a significant proportion of all water used. The sensitivity of the system is tested with the intention of determining the relative importance of impacts of climate change on water demand versus water supply where surface water is limited. In addition, the mode is developed with the primary aim of answering the following questions:



### **The main question of the thesis**

What impacts could climate change have on cattle water demand and supply in Khurutshe, Botswana?

### **Specific questions are:**

- What determines water supply and demand for cattle?
- What changes in climate are expected by 2050 in Khurutshe, Botswana?
- How might cattle water demand be impacted by these changes?
- How might cattle water supply be impacted by these changes?
  - a. What sources of water supply can be identified?
  - b. How might these sources be impacted?
- Is the current supply: demand ratio sustainable?
- Might the future supply: demand ratio be sustainable with climate changes?
- How can supply/demand characteristics be changed to become sustainable?

### **Reference mode of behaviour for cattle water demand for borehole water**

The cause of concern in this study is cattle voluntary water intake. As opposed to involuntary water intake, voluntary water intake is the amount of water that has to be supplied by farmers and therefore it corresponds to groundwater abstraction. Thus, the cause of concern is the dynamics of abstraction of groundwater and how it will be affected by climate change. As voluntary water intake is affected by factors such as pan water and forage water content, which varies significantly between wet and dry seasons it is envisaged that the reference mode of behaviour groundwater for abstraction rates is oscillation. During summer, when it is rainy and forage is lush, cattle will obtain almost all their water requirement from pans

and forage. Therefore demand for borehole water and corresponding abstraction rates of groundwater will be zero as long as pans are frequently filled with rain water. Conversely, when it is hot and dry (no availability of surface water and forage water content is extremely low) voluntary water intake will be high and therefore abstraction of groundwater will be at a maximum to meet the total cattle water requirement. Thus, the abstraction rates will reach maximum due to high temperatures, no availability of pans and dry forage. While in winter, abstraction will be low due to low temperatures. Therefore oscillation behaviour, as depicted in Figure 8.4 is the reference mode for the livestock water supply system.

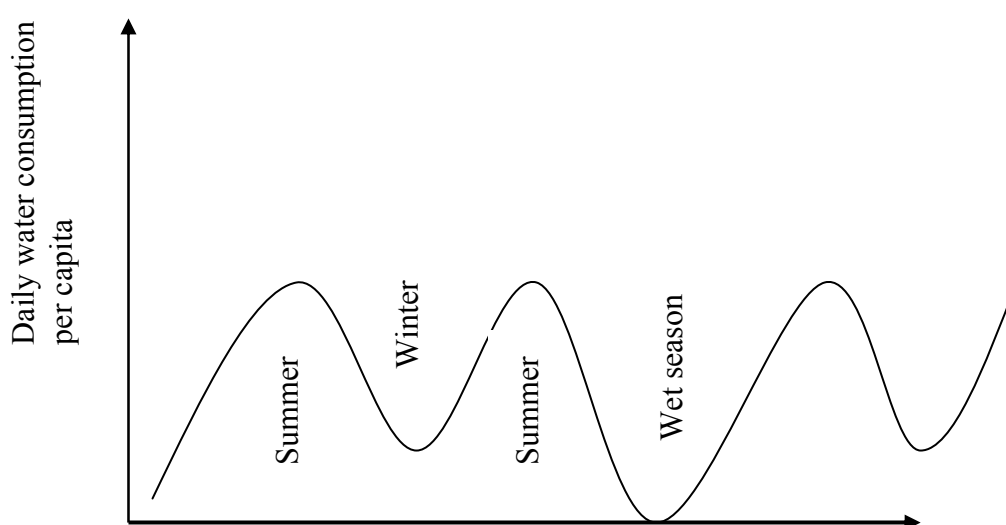
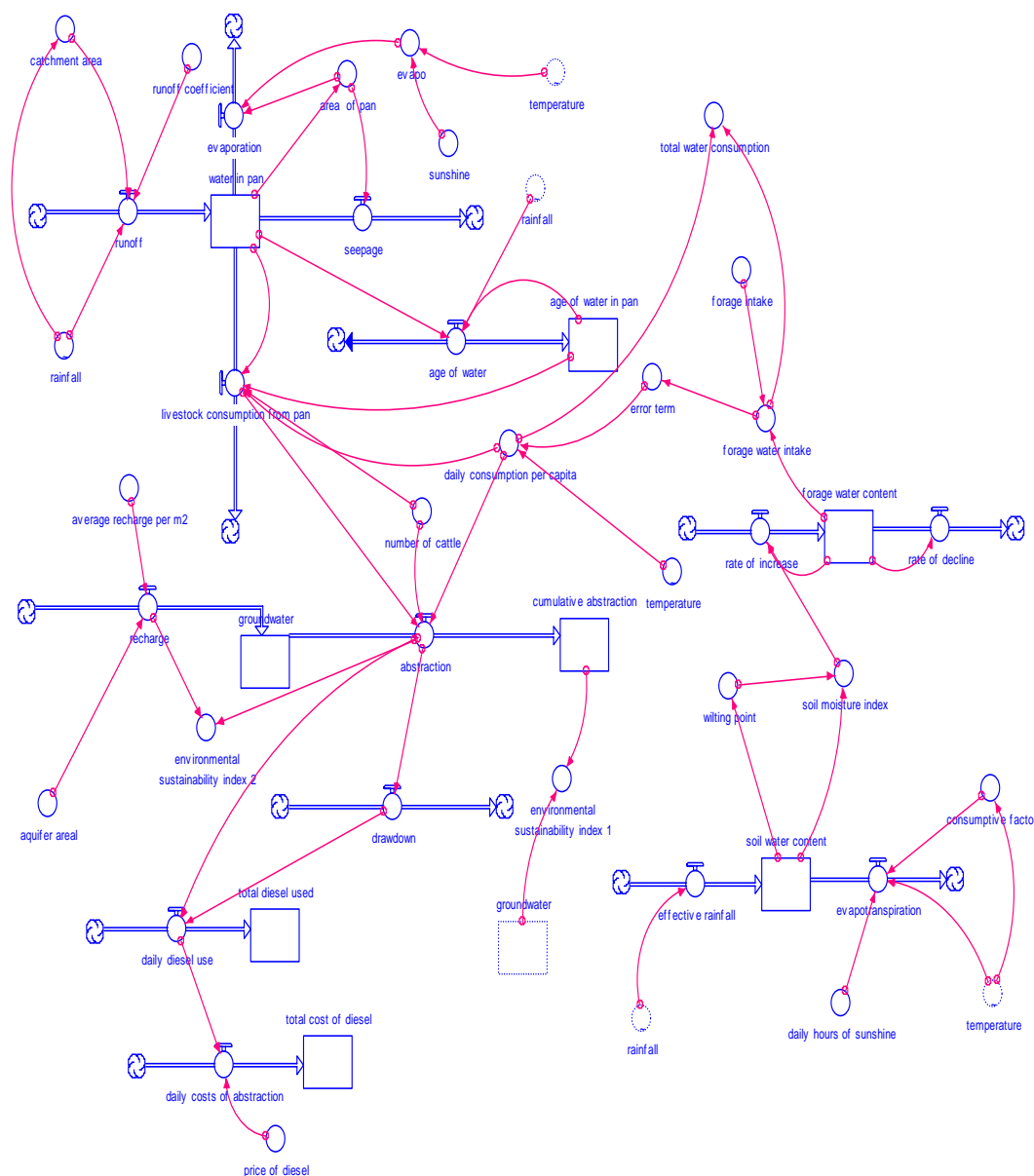

Figure 8.4: Cattle water demand for borehole water.

### Model structure for cattle water system model

As noted the structure of the model is constructed based on the following: description of the system, observation from the real system and discussions with farmers. All efforts were made to construct a structurally valid model which represents the true operations of the system and also to achieve the objectives and answer the questions posed. Figure 8.5 shows the complete livestock water supply model diagram, its structures and boundaries.



**Figure 8.5: Qualitative cattle water demand and supply model (using STELLA software)**

## **Model calibration and simulation of the function relationship between model variables**

After completing the structure of the livestock water demand and supply model, the next step is model calibration and simulation. Calibration simply deals with fitting the parameters of the equation. Wolstenholme (1992) noted that calibration entails attaching numbers to variables in the model. He stressed that this is not aimed at accurate predictions or solutions. However, Wolstenholme is not entirely correct by noting that calibration is not aimed at accurate prediction, as simulation involves imitating the behaviour of the system and ultimately determining the

robustness and the plausibility of the model. Probably, Wolstenholme's (1990:58) point of view is based on the observation that "exact correspondence between a model output and past data is perhaps significant for certain types of models such as econometric models which are used for absolute short term forecasting. For system dynamics models, which attempt to create scenarios based on assumptions about multiple relationships and policies (which might be totally different from those of the past) such emphasis on the past is seen as less important". However, in this study calibrating is done with precision as it is assumed that the present conditions will prevail in future except for the rainfall and temperature (variables for climate change). These are therefore the only variables that are deemed to change in future and other variables will only change due to their associated relationship with temperature and rainfall. The difference between calibration and simulation appears to be vague. Coyle (1996) described simulation as creating a set of equations to represent a particular system of interest and then run the developed equations to imitate the behaviour of the real system in future. His advice is that the equations developed should mimic the behaviour of the real system as much as possible.

In this study, model calibration or the functional relationships of the variables was done by either empirical analysis or regression analysis. In some cases, non-linear relationships were transformed into log-linear relationships and then the regression analysis carried out (Dobson, 1983; Gujarati, 1998; Krzanowski, 1998; McCuen and Snyder, 1986). As with other model calibrations done elsewhere, only stocks and flows are calibrated as they are the core variables in simulating the system. Appendix 2 shows equations used for model simulation.

## **Functional relationships between variables in the developed model**

The following section derives the mathematical relationships between the variables of the proposed cattle water demand model. As there are many relationships between variables, the sections of the model that are discussed are illustrated diagrammatically.

### **Cattle daily water consumption model**

Different models were derived to estimate and simulate daily cattle water consumption as follows: Autoregressive, simple linear equations and moving average model. For the autoregressive ARIMA (1 1 0) and ARIMA (2 1 0) models were used. In all these models, forage water content was assumed to be the error term. An autoregressive model could be thought to explain daily water consumption for cattle as water consumption is likely to be influenced by past consumption. The ARIMA models captured the fluctuations, though not perfectly. A simple linear regression model had a low R-squared and therefore could not be used. The model chosen was a moving average model which uses temperature only to model average water consumption. The advantage of using the averages is that they retain the most characteristics of time series data of serial correlation between previous and current values in a data set. Another advantage of using a moving averages model is that it uses temperature as the only explanatory variable. This is advantageous as in a model to assess the impact of climate change; temperature together with precipitation, are the model's main drivers. The ARIMA models are not selected because they use past consumption and temperature which could be questionable when using the model to project water demand in 2050. To be realistic, in modelling water consumption, averages were only taken for six days for both temperature and consumption. That is, it is assumed, water consumed will have an effect for the next six days. In this model temperature was used as the only explanatory variable while other variables such as forage water content were assumed to be in the error terms.

## Time series data modelling

Water consumption data was collected on a daily basis from a water meter fitted on a pipe that supplied water from storage tank to trough (Figure 8.6) and is thus time series data. Unlike cross sectional data, time series data is frequently influenced by the value of previous explanatory and dependent variables, in addition to the current values. Box *et al.*, (1994) point out that a prominent feature of time series data is that adjacent observations are dependent. Harrison *et al.*, (2003) reflect that given a univariate time series variable, its consecutive value contains information about the process that generated it. This process, whereby present values are affected by past events or values of their past events, is called the Markov process (Hipel and Mcleod, 1994).

McCuen and Snyder (1986) noted that when there is serial correlation between previous and current values then one can take advantage of this when modelling future phenomenon. Systems of this nature are best modelled by distribution lag and autoregressive models (Gujarati, 1998; Harrison *et al.*, 2003; Hipel and Mcleod, 1994; McCuen and Snyder, 1986). An autoregressive model is defined as a model that includes the lagged values of the dependent variables and its explanatory variables (Gujarati, 1998; Harrison *et al.*, 2003; Hipel and Mcleod, 1994; McCuen and Snyder, 1986). Autoregressive models can be distinguished from the distributed lag model in that they use historic values of the dependent variables and explanatory variables while the distributional lag model only use lagged values of the dependent variables. Autoregressive models can be divided into three groups (Hipel and McLeod, 1994), being autoregressive (AR), moving averages (MA) and autoregressive-moving averages (ARMA).

As pointed out, cattle water consumption data used in this study is time series data; therefore it is highly likely that current consumption is influenced by previous consumption. Incidentally, water consumption by the cattle is influenced by temperature, maybe previous temperature, water consumed from forage and previous water consumption. In Masama Ranch, cattle drink between 09:00 and 13:00. Therefore, it is likely that previous temperature, especially after consumption, between 13:00 and the next day will affect future consumption. On

the other hand, it is also possible that, previous temperature could affect future consumption as the livestock expects the previous temperature to be constant into the future and hence their memory is set on the previous temperature. The other possibility is that, previous temperature affects current consumption in the opposite direction. It has been found that daily forage intake is restricted by mechanism in the passage of forage from the rumen of the animal, therefore limiting daily forage intake depends on the forage taken previously (Meissner, 1997). It is therefore possible that previous water consumed affects future water consumption through the same mechanisms. If this is true, then previous consumption will affect future consumption through limits to intake. From the above argument it therefore means that if previous consumption was high, then future consumption will be low.



**Figure 8.6: Water meter used for recording daily water consumption.**

In modelling daily cattle water consumption, different methods or equations were adopted. Firstly, a simple linear model with temperature as the explanatory variable was derived. Secondly, the ARIMA (1 1 0) model was derived and used to simulate daily livestock water consumption. Lastly, moving averages were used to simulate daily livestock water consumption. The model that is adopted for this study is the linear moving averages with a relatively high R-squared. In addition, it is felt that the salient features of the time series data are not lost with the non-linear moving average model. Simply, the average model was chosen for its simplicity and accuracy in estimating daily water consumption.

Data collection for water consumption was carried out on a mixture of growing cattle, therefore, the consumption model is for an average cow. Before water consumption was modelled, observation of the data on daily water consumption was made to see if there was a correlation between previous consumption and future consumption. In addition, observation was made to see whether there was any correlation between temperature and daily consumption. The trend and pattern of consumption shows that there is some correlation between historic consumption and future consumption. In addition, discussion with farmers further revealed that when livestock had drunk excessively the previous day the next day they would either not come to the boreholes or come but drink a small amount compared to the previous day. Another interesting observation is that given similar temperatures but different seasons (summer and winter) the daily water consumption differs considerably. For instance, 25°C in summer results in higher consumption compared to a 25°C in winter. Thus previous temperature or consumption may be responsible for these differences. On the whole, there is markedly different daily water consumption between the summer and winter seasons.



## Simple linear regression model for water consumption

The model for cattle daily water consumption was selected from various developed models based on how best it estimated daily water consumption. Basically, the best model was selected based on the R-squared. The first model to be tested was daily water consumption and is only explained by temperature as shown in Equation 8.1.

$$WC_t = \alpha + \beta T_t \quad \text{[Equation 8.1]}$$

Where

$WC_t$  is consumption in time t

$\alpha$  is a constant

$\beta$  is a coefficient for temperature

$T_t$  is temperature in time t

The results from a simple linear regression model are as follows:

**Table 8-1: R-squared for linear cattle water demand model**

Model	R	R Square	Adjusted R Square	Std. Error of the Estimate
1	.559(a)	.313	.309	10.31957

a Predictors: (Constant), temperature

**Table 8-2: coefficients for the simple linear cattle water demand**

### Coefficients<sup>a</sup>

Model		Unstandardized Coefficients		Standardized Coefficients	t	Sig.
		B	Std. Error	Beta		
1	(Constant)	-9.010	5.139		-1.753	.081
	temperature	1.605	.182	.559	8.797	.000

a. Dependent Variable: water consumption

The equation of a simple linear model can be written as in Equation 8.2.

$$WC_t = 1.6T_t - 9 \quad \text{[Equation 8.2]}$$

From the results, the coefficient of temperature is statistical significant and also positively related to daily water consumption. However, the model is not statistical significant as revealed by the R-squared. Only 31% of the variation explained by the model. Therefore the model cannot be used due to its poor explanation of the variation. In addition, the non-linear model did not improve the performance of the model as the R-squared remained at 0.31.

### ARIMA model for cattle water consumption

An autoregressive model for cattle daily water consumption can be modelled as in Equation 8.3.

$$WC_t = \alpha + \beta_1 WC_{t-1} + \dots + \beta_k WC_{t-k} + \gamma_1 T_{t-1} + \dots + \gamma_k T_{t-k} + e_t \quad \text{[Equation 8.3]}$$

Where,

WC is water consumption;

$T_t$  is current temperature;

$\alpha$  = constant;

$\beta$  are the coefficients for water consumption;

$\gamma$  are the coefficients for temperatures;

t = current time;

k = previous time; and,

e= error term.

An ARIMA model takes the form of (p d q) where p signifies the number of lags, d is the difference between the dependent variables and q denotes the moving averages. The difference d is basically used to correct for the stationarity of the time series data. Most of the models assume that time series is stationary (Hipel and Mcleod, 1994). Stationary basically implies that “the mean value and its

variance are constant over time and the value of covariance between two time periods depends only on the distance or lags between the two time periods and not on the actual time at which the covariance is computed” (Gujarati, 1998:712). According to Hipel and Mcleod (1994) stationary can be viewed as a form of statistical equilibrium. They relate stationary as being “analogous to the concept of isotropy within the field of physics. In order to be able to derive physical laws that are deterministic, it is often assumed that the physical properties of a substance such as conductivity and elasticity are the same regardless of the direction or location of measurement” (Hipel and Mcleod, 1994:68). There are generally two types of stationary: weak and strong. These are discussed intensively with illustration by Gujarati (1998) and Hipel and Mcleod (1994). Gujarati (1998) remarked that if the assumption of stationary is not met then the hypothesis-testing procedures of either t-test or F-test and other tests become questionable. There are a number of tests that can be performed to detect whether the time series data is stationary (Gurajati, 1998; Hipel and Mcleod, 1994). The most commonly used method is plotting autocorrelation functions (hereafter ACF) against the lags. When the correlogram graph generally starts at a high value and declines slowly, according to Gurajati (1998) this is an indication of non-stationary. On the other hand if the values of the ACF decline rapidly with lags and become insignificant after a short lag period then it is an indication of stationarity. There are other tests and methods that can be employed to detect stationarity in time series data and they are discussed by Gujarati (1998).

If the time series data is not stationary, then non-stationarity can be removed by the operation of differencing (Gujarati, 1998; Hipel and Mcleod, 1994). This is simply taking the first difference of the variable as in Equation 8.4.

$$(WC_{t-n} - WC_{t-k})$$

**[Equation 8.4]**

Figure 8.7 and Figure 8.8 below show autocorrelation functions for the non-difference and difference time series data. From the graphs, it is clear that the non-difference graphs have patterns and properties that show that it is non-stationary time series data. This pattern is clear to pick up and this is when the autocorrelation functions take a long time to be statistically insignificant. With

water consumption it takes up to lag 16 and the autocorrelation functions are still significant. While for the differenced time series, the coefficients are statistically insignificant at lag 2. They are random and conform to the stationary properties.

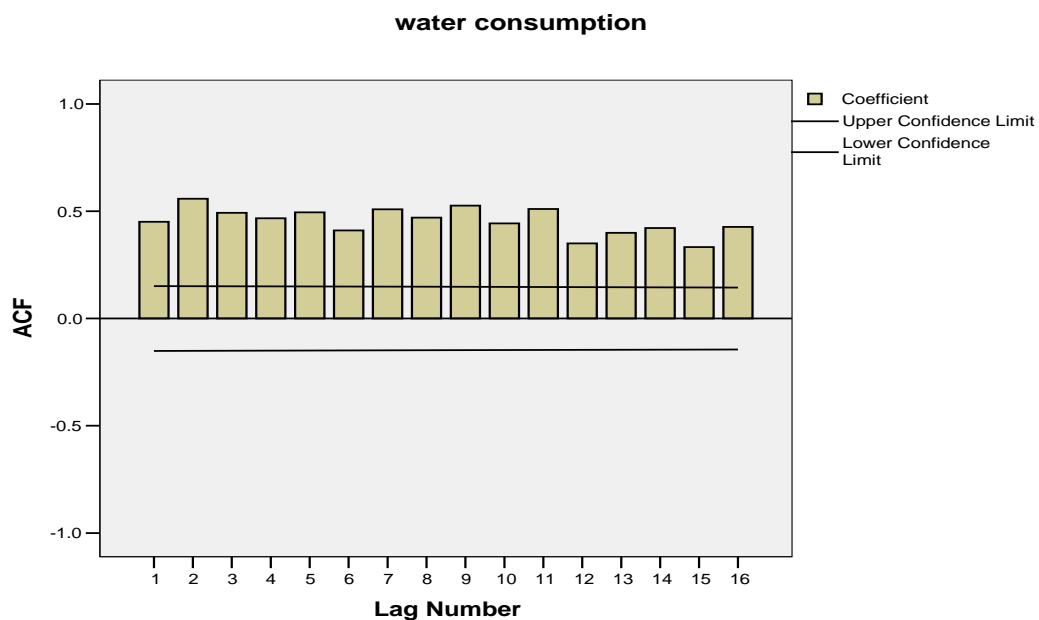

Figure 8.7: ACF for the non-difference daily water consumption

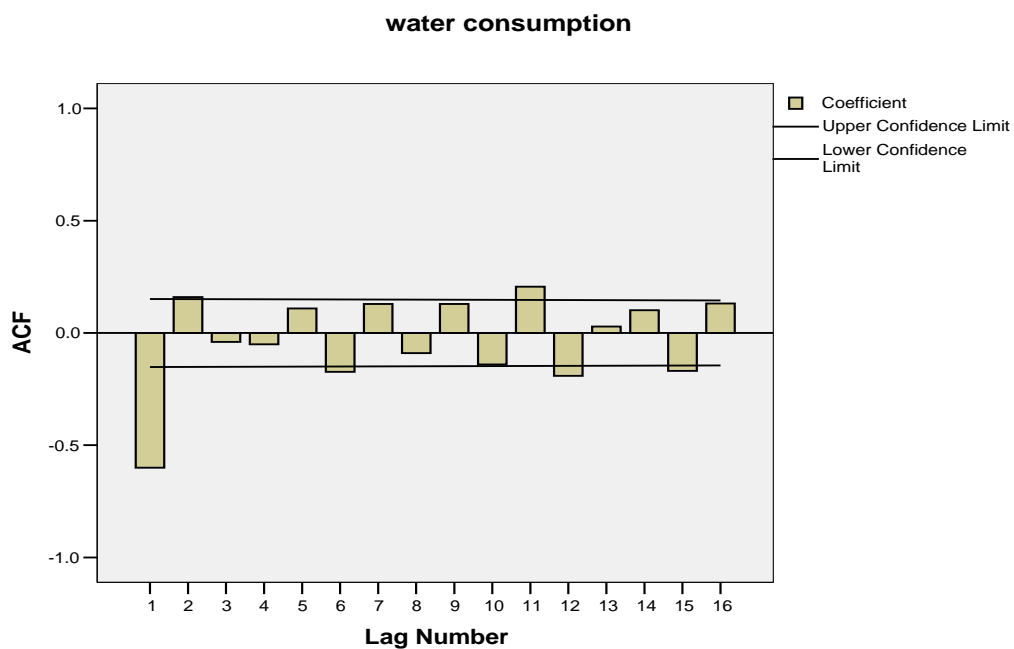

Figure 8.8: ACF for the difference daily water consumption

To derive the correlation of stationarity by taking the differences, the ARIMA (1 1 0) was run and Table 8-3 below shows the results. The estimates are the coefficients for the explanatory variables and the t values are the calculated t values.

**Table 8-3: Parameters estimate for the ARIMA (110)**

		Estimates	Std Error	T	Approx Sig
Non-Seasonal Lags	AR1	-.606	.061	-9.889	.000
Regression Coefficients	Temperature	.747	.246	3.041	.003
	temperature lag1	-.415	.246	-1.689	.093
Constant		-.059	.490	-.120	.905

Melard's algorithm was used for estimation.

The ARIMA (1 1 0) model can be written as in Equation 8.5.

$$WC_t = 0.39WC_{t-1} + 0.61WC_{t-2} + 0.74T_t - 0.415T_{t-1} - 0.059 \quad \text{[Equation 8.5]}$$

Except for the constant coefficient, all other coefficients are statistically different from zero as shown by the t-calculated. However, lag temperature is barely significant. From the model, it is clear that future consumption is positively correlated to consumption at time t-1 and t-2. That is, an average cow would consume 0.39% of previous consumption t-1, and 0.61% of previous consumption t-2. In addition, the cow will drink 0.75 for each unit of current temperature and will reduce consumption by 0.41 for each unit of previous temperature.

The coefficient of current temperature is positively related to current consumption. That is, an increase in current temperature will result in an increase in water intake. The coefficient has a value of 0.74, implying that for every unit increase in temperature, a cow will increase consumption by 0.74 litres. This is in line with findings from the literature that an increase in temperature will lead to an increase in water consumption. Interestingly, lag temperature for time t-1 temperature has a negative coefficient of -0.415. Thus, for every unit increase of

previous temperature, livestock will reduce there consumption by 0.415. The relationship between temperature t-1 and current consumption is difficult to explain. However, the rational for a negative relationship is basically that lag temperature t-1 had previously affected its previous current consumption positively, thus as animals have previously consumed more due to previous current consumption. It means that previous consumption will have an effect on current consumption. From the argument presented above, it is clear that temperature in time t affects consumption in time t positively and will later affect consumption t+1 negatively. From ARIMA (1 1 0) results, temperature t will have a positive impact on current consumption of 0.747 combined with other factors such as the difference between consumption t-1 and t-2, the temperature impact will induce livestock to reach their maximum water intake, thus in time t+1, the effect of temperature t will be negative due to its effect on previous water consumption.

The model was further expanded to ARIMA (2 1 0) and the results show (Table 8-4) that there is a strong correlation between previous consumption and current consumption. This is reflected by the strong statistical significance of the variables.

**Table 8-4: Parameters estimates for the ARIMA (2 1 0)**

		Estimates	Std Error	T	Approx Sig
Non-Seasonal Lags	AR1	-.812	.073	-11.135	.000
	AR2	-.338	.073	-4.637	.000
Regression Coefficients	Temperature	.842	.229	3.675	.000
	temperature lag1	-.330	.229	-1.438	.152
Constant		-.046	.347	-.133	.894

Melard's algorithm was used for estimation.

The ARIMA (2 1 0) can be written as in Equation 8.6.

$$WC_t = WC_{t-1} - 0.81*(WC_{t-1} - WC_{t-2}) - 0.338*(WC_{t-2} - WC_{t-3}) + 0.842T_t - 0.330_{t-1} - 0.046$$

**[Equation 8.6]**

Compared to ARIMA (1 1 0), ARIMA (2 1 0) overestimated daily water consumption more than ARIMA (1 1 0) as shown in the figure below. However, the coefficients are consistent with those obtained from ARIMA (1 1 0). Due to its failure to simulate the observed consumptions the coefficients and their interpretation are not discussed.

With the ARIMA model it is assumed that the residual is a function of other explanatory variables for livestock consumption, specifically forage water content. Thus it is assumed that forage water content accounts for the residual  $E_t$ .  $E_t$  as defined as the difference between calculated water consumption and observed water consumption.

$$E_t = a + bf \quad \text{[Equation 8.7]}$$

Where

f=forage water content

However, the behaviour of the error is extremely random such that the relationship between the two is extremely low with an R-squared of 0.008. Thus, other factors such as behaviour of the individual livestock in the herd may have an influence on the error term. To try to improve the performance of the model and at the same time include the values of the previous explanatory and dependent values, the moving averages were used to model daily water consumption.

### **Using moving average to simulate daily consumption**

The last model derived to simulate daily livestock water consumption is moving average with temperature as the explanatory variable. In these models water consumption averages are regressed against average temperature. The advantage of these models is that the autoregressive nature of time series data is still retained while at the same time the fluctuations are smoothed out. To retain some realism in modelling water consumption, averages are used only up to six days. The six day memory time was selected from averages ranging from two to seven days. Using a six day moving average to simulate daily water intake proved to give

better simulation results than other averages. It is assumed that the residual time period of water in livestock is six days or that water intake up to six days earlier has an impact on current water intake. Only temperature is used to model consumption and the forage water content is used to explain the error term  $e$ . As total water consumption is the sum of observed and forage water content this is a realistic assumption. Using the six day average, the following results were obtained, Table 8-5. This model is quite similar to the model used by Parker *et al.*, (2000). They used a 5 day average and argue that it is the minimum length of time at which the memory of the system was minimised (Parker *et al.*, 2000). In addition, daily water consumption for cattle is similar to the results of this study although this study used temperature as the only explanatory variable.

**Table 8-5: Parameter estimates for the average water demand model**

SUMMARY OUTPUT				
<i>Regression Statistics</i>				
Multiple R		0.7927		
R Square		0.6283		
Adjusted R Square		0.626		
Standard Error		5.7424		
Observations		165		
ANOVA				
	<i>Df</i>	<i>SS</i>	<i>MS</i>	<i>F</i>
Regression	1	9086.71	9086.71	275.56
Residual	163	5374.99	32.9754	
Total	164	14461.7		
	<i>Coefficients</i>	<i>Standard Error</i>	<i>t Stat</i>	<i>P-value</i>
Intercept	-20.28	3.69947	-6.8335	1.6E-10
X Variable 1	2.148	0.13206	16.6	7.3E-37

Thus the temperature model for average cattle water consumption can be written as in Equation 8.8.

$$WC = 2.1484temp - 20.28 \quad \text{[Equation 8.8]}$$

Like with the ARIMA (1 1 0) it is assumed that the error term  $e$ , is a function of forage water content. Thus, the error term for the moving average was regressed



against forage water content averages. The results for the error term regressed against forage water content are as depicted by Equation 8.9.

$$e = 4.658 fwc^3 - 21.478 fwc^2 + 24.288 fwc - 3.7995$$

$$R^2 = 0.4579$$

**[Equation 8.9]**

Thus the estimated water consumption can be derived using Equation 8.10.

$$WC_{est} = a + bT + e$$

**[Equation 8.10]**

Equation 8.10 can be written as in Equation 8.11.

$$WC_{est} = a + bT + fwc$$

**[Equation 8.11]**

Using the above equation, water consumption was estimated as in Figure 8.9. As pointed out this is the average consumption for six days.

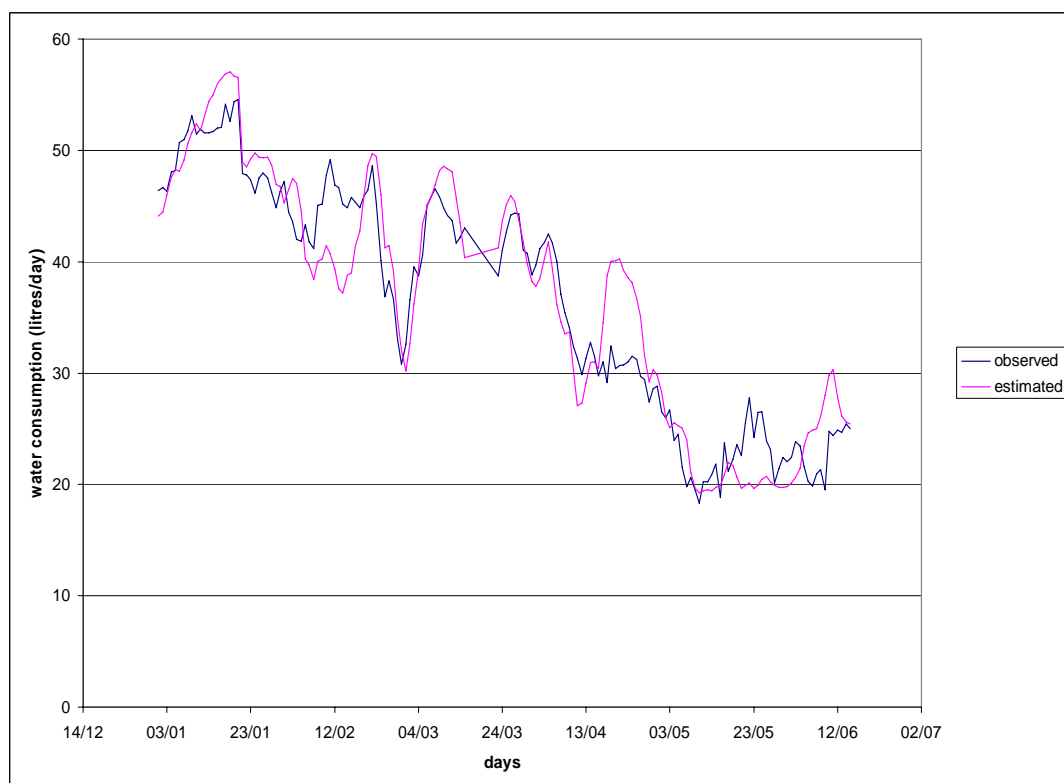

**Figure 8.9: Observed and estimated daily water intake**

From the analysis carried out, it is observed that daily water consumption is highly variable, perhaps due to the fact that temperature in the study is also highly variable. For instance, rainy days and cloudy days had low maximum temperature as opposed to the cloudless days. This greatly affected the per capita water consumption. The effect of temperature becomes more apparent at the end of the simulation period. This is the winter season and temperatures fall considerably compared to summer. During this period, consumption declines as cattle infrequently return to the borehole. Figure 8.10 simulates daily consumption. When these values are averaged over a six day period they closely follow the values in Figure 8.9. Thus, the average model simulates daily consumption accurately. Once again, at the end of the simulation period, consumption falls considerably.

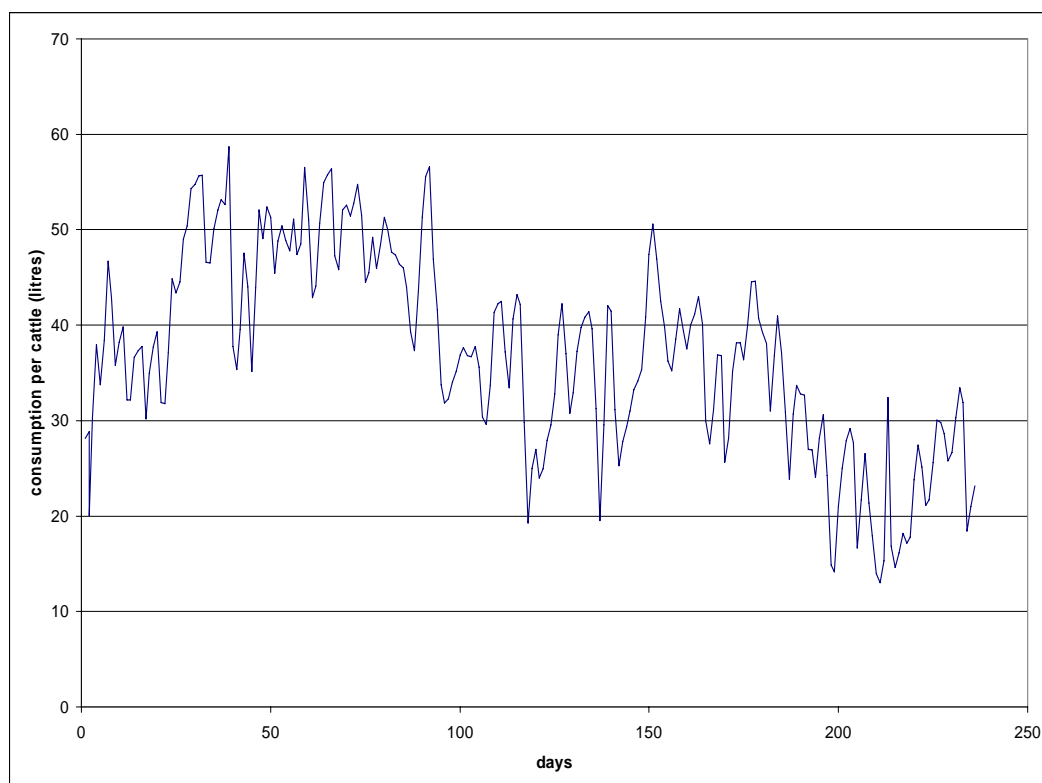

**Figure 8.10: Simulated daily water consumption**

### **Rainfall-runoff, water in pans and seepage**

Runoff into pans is a function of the following factors: rainfall intensity, condition of top layer and infiltration capacity of the soil, slope of the site and the physical and biological condition of that slope (Bhalotra, 1987). As pointed out earlier, in this study the amount of rainwater collected in pans is modelled as in Equation 8.12.

$$QP = R * CA * RC \quad \text{[Equation 8.12]}$$

Where,

QP is the quantity of water in the pan ( $m^3$ );

R is precipitation (mm);

CA is the catchment area ( $m^2$ ); and,

RC is the runoff coefficient (unitless).

In chapter six, I have already discussed how runoff coefficients are estimated and factors affecting runoff coefficients. In addition, the relationship between rainfall and runoff has also been discussed. In this study, a runoff coefficient of 0.3 corresponding to the rangeland, pasture, sandy loam has been chosen. Observation from the collection of rainwater in the pans and precipitation events reveals that precipitation events of less than 40 mm did not produce any significant runoff. Therefore, for precipitation below 40 mm, a runoff coefficient of zero is adopted. Figure 8.11 shows rainfall events during the data collection period which have been used for the calibration of a runoff coefficient.

Another important parameter in estimating quantity of water collected in the pan is the catchment area. A catchment basically defines an area from which surface runoff is channelled to the pan. It is defined by the topography and the slope toward the pan. In this study, the catchment area was determined after a rainfall event and was further collaborated from the quantity of water in the pan. Just like with the runoff coefficients, a threshold was used for rainfall events. Observation from the Masama Ranch and pans around the Khurutshe area was that runoff mostly follows cattle tracks to the pans.

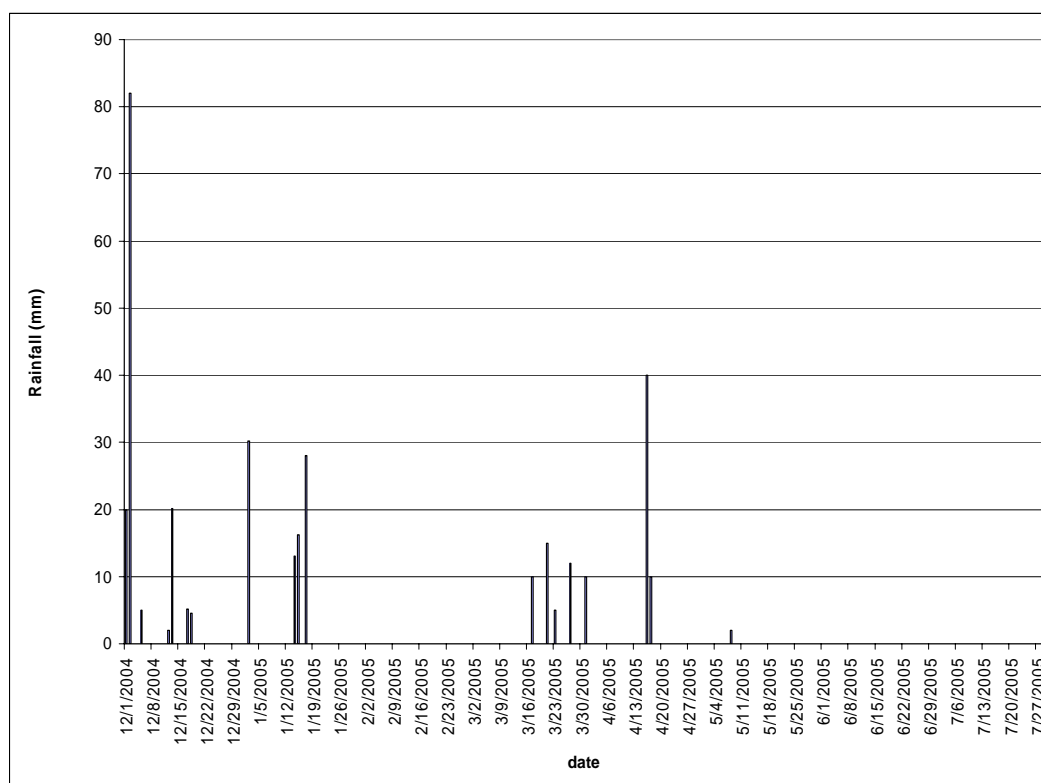

**Figure 8.11: Rainfall events in Masama ranch from (dec 04-august 05)**

To model and simulate the amount of water in the pan and changes of water in the pans properly it is imperative that the quantity of pan water is known on a daily basis. Therefore, to estimate the amount of water in the pan stakes were used to mark the boundary on a daily basis. The procedure was that as soon as it stopped raining, sticks were pinned on the water boundaries to mark area of circumference on a daily basis. To determine the seepage rate and water consumed by the cattle the same procedure of pinning sticks was repeated each day. Depth was estimated using a fish line stretched from one boundary to the other and measured by tape. Due to the evenness of the pans multiple depths were taken and averaged.

A simple water balance equation was adopted to estimate stock of water in the pan as in Equation 8.13 and Equation 8.14.

$$QW_t = QW_{t-1} + QP - CW - S - EV \quad \text{[Equation 8.13]}$$

$$QP = R \times CA \times RC \quad \text{[Equation 8.14]}$$

Where,

$QW_t$  is the current stock of water in pan ( $m^3$ );

$QW_{t-1}$  is the previous stock of water in pan ( $m^3$ );

$QP$  is the inflow from rainfall ( $m^3$ );

$CW$  is consumption by the cattle ( $m^3$ ); and,

$S$  is the seepage rate ( $m^3$ ); and,

$EV$  is evaporation rate ( $m^3$ ).

Using the above the water balance equation, water in the pan from the two rainfall events with significant runoff was simulated as depicted by Figure 8.12. From Figure 8.12 it can be seen that water in the pan declined rapidly at first with time.

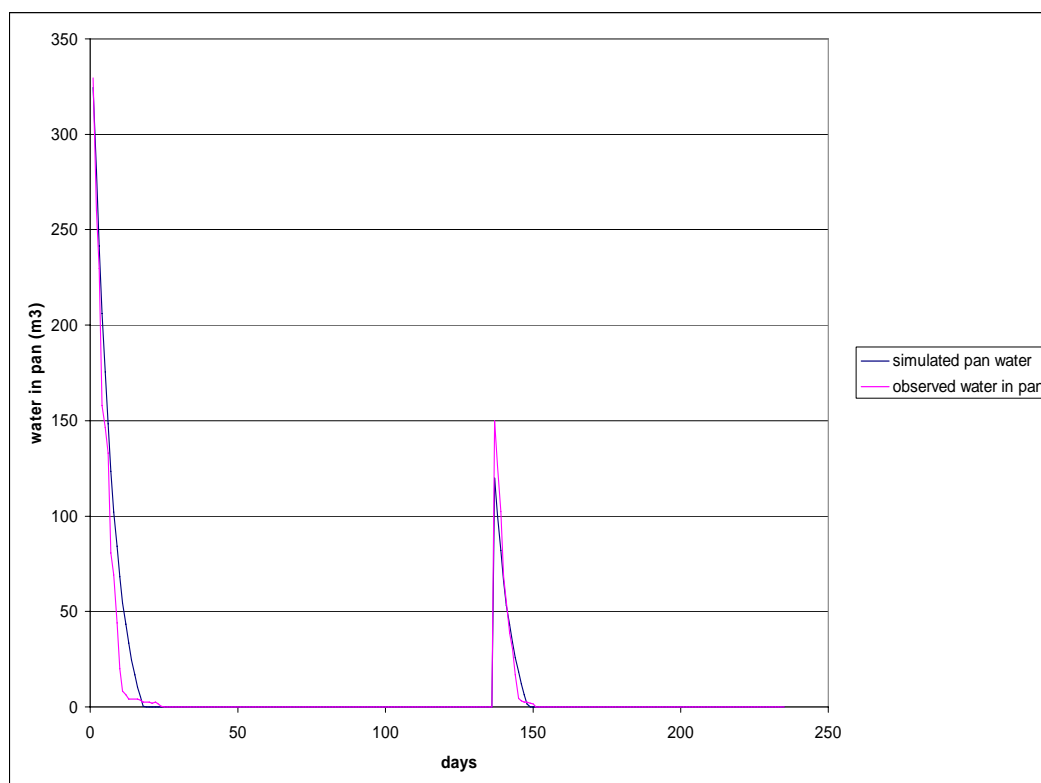

**Figure 8.12: Simulated water quantity in pan**

Intuitively, rate of seepage is a function of the soil type around the pans. It is expected that sandy and loam soil will have high infiltration rates relative to clay soils. Observation made from the majority of the pans in the Khurutshe area is that as the radius of the pans increases away from the centre, soil type changes from clay to loam clay and to sandy soil. As sandy soils have higher infiltration rates it follows that seepage is higher when pans are filled to capacity, then falls to lower values as the section of the pans diminished to the clay soil section. Figure 8.13 shows the composition of types of soil within a pan in the study area while Figure 8.14 a shows dry pan with clay soil.

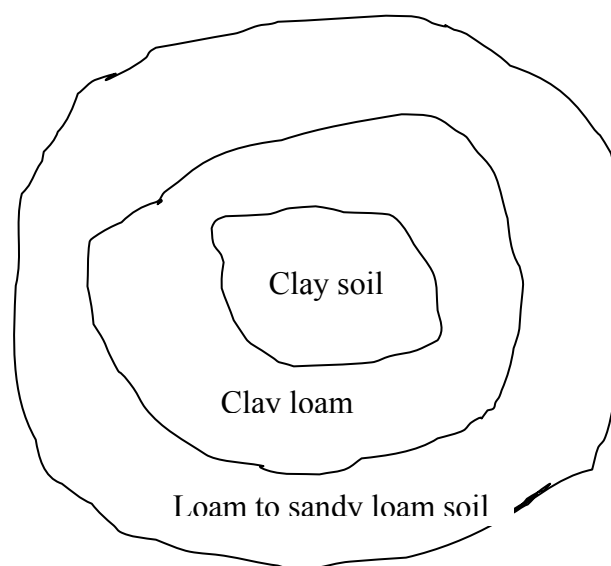

**Figure 8.13: Composition of soil types within a typical pan in Khurutshe area.**



**Figure 8.14: Dry pan in Masama Ranch.**

An empirical equation was derived for seepage based on the surface area of water in the pan. This equation was derived by statistical regression analysis with surface area being the independent variable. In order to estimate seepage, total

water loss from the pan was estimated. To determine the proportion of water accounted for by seepage, the proportion of water consumed by cattle was estimated using the derived equation for daily water intake and number of cattle. Secondly, using the derived evaporation equation (with temperature, sunshine) and surface area of water occupying the pan, proportion of water loss by evaporation was computed. Thus, the remaining loss is assumed to be accounted for by seepage. Using these assumptions, seepage was derived by Equation 8.15.

$$Sp = 0.00002A^2 - 0.0046A - 0.4282 \quad \text{[Equation 8.15]}$$

$$R^2 = 0.69$$

	A <sup>2</sup>	A	Constant
Standard error	0.000	0.013	3.945

Where,

Sp is the seepage rate; and,

A is the area of water in the pan (m<sup>2</sup>); and,

Constant in (m)

Using the above equation, seepage rate in the Masama Ranch was simulated as in Figure 8.15. Clearly, the seepage rate is extremely high in Masama Ranch such that the majority of the water collected in pans is lost through seepage. In addition, the equation derived underestimates the observed seepage rate. This may be explained by the assumption made that water lost from the pans is by cattle consumption, evaporation and seepage. However, wildlife may also contribute from water withdrawals in the pans. Masama Ranch and Khurutshe area has a large population of kudu which depend on pans for their water.



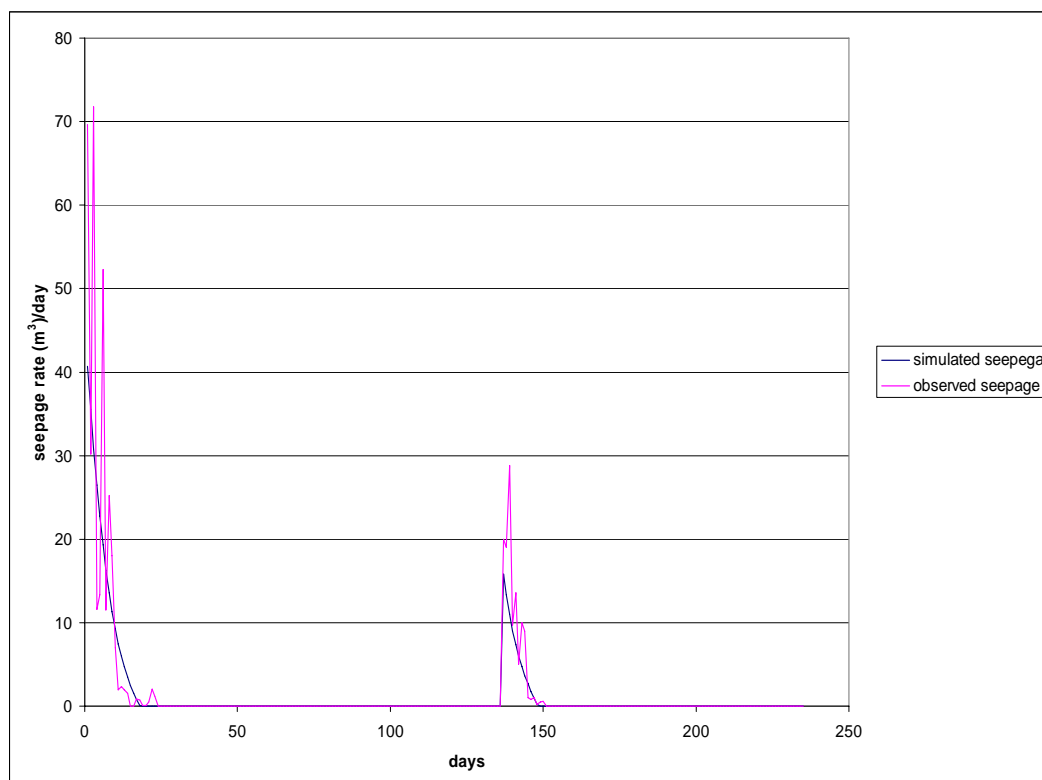

**Figure 8.15: Simulated seepage rate in the pan**

## Evaporation from pans

Evaporation is one of the most significant losses of surface water in the semi-arid environments. In the study, a Blaney-cridle evaporation method is adopted. This method is appropriate for this study as it uses temperature and hours of sunshine. These are the variables that are assumed to be the primary determinants of water supply and demand in semi-arid environments. Daily evaporation from the pans is a function of the surface area of water in the pans and also evaporation rates. Equation 8.16 was used to estimate evaporation from the pans.

$$EV = ev * A \quad \text{[Equation 8.16]}$$

where,

EV is total evaporation ( $m^3$ );

$ev$  is evaporation rates (mm); and,  
 $A$  is the surface area of the pan ( $m^2$ )

Daily evaporation rates were derived from class A evaporation pans. The observed evaporation rates (derived from class A evaporation pan) were then regressed against maximum temperature and daily hours of sunshine. The derived equation for evaporation rate using temperature and hours of sunshine is depicted by Equation 8.17.

$$ev = 2.34 \log T + 0.0035 \log S - 2.72 \quad \text{[Equation 8.17]}$$

$$R^2 = 0.65$$

	constant	T	S
Standard error	0.272	0.153	0.143

Where,

T is the maximum temperature

S is the hour of sunshine

The simulated water loss by evaporation is depicted in Figure 8.16 below. Comparatively, evaporation losses are quite substantial. The fluctuations are a result of variability in maximum temperature due to cloud cover.

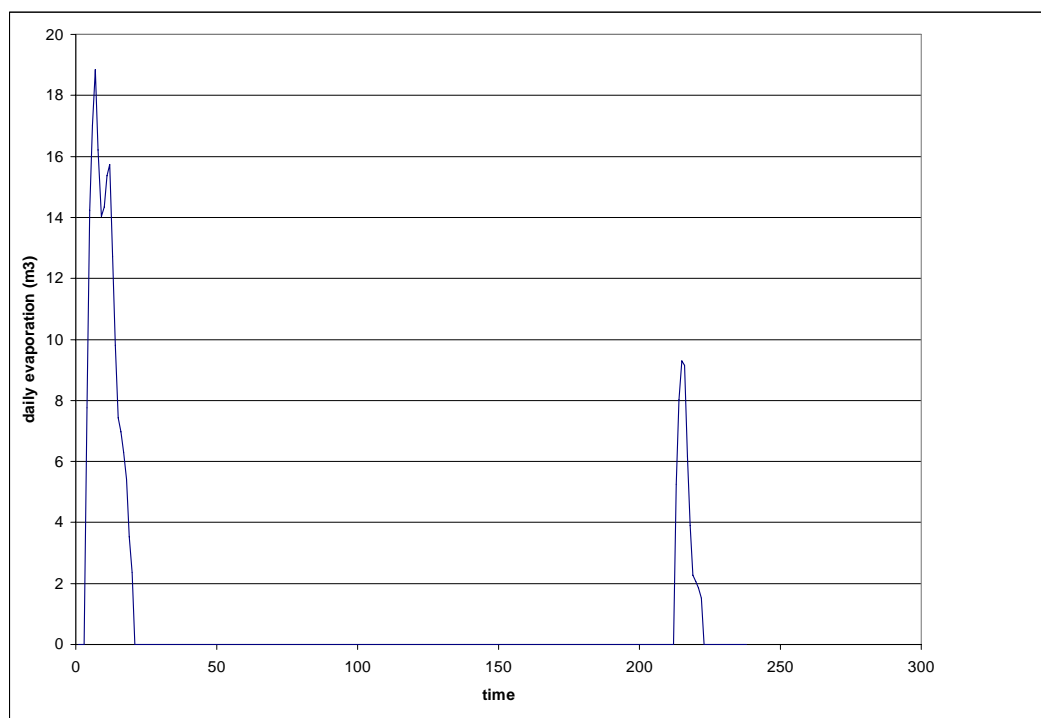

**Figure 8.16: Daily evaporation from pan**

### Consumption from the pans

Cattle consumption from the pan is a function of the quality of water in the pan. Quality of water in the pan can easily be determined by the period in which the water was held in the pan. In the study, an assumption was made that age of water in the pan became zero with a rainfall threshold of 40mm. That is, water in the pan was always renewed by incoming water if the runoff was significant. A discussion with the farmers reveals that consumption at the pan is influenced by the state of water in the pans. This is especially true when algae start to grow in the pan water. Determining an equation for cattle consumption from the pans was done by observing the percentage that constitutes total cattle consumption from the pans and the borehole. That is, as the water in the pans gets older animals shift from drinking from the pans to the borehole. Therefore, as the cattle drink less from the pans they drink more from the boreholes. The derived equations for seepage and evaporation losses were used to account for part of the decline from the pans. Then, the unaccounted for water loss was assumed to be the proportion of cattle consumption. However, using the derived equation for cattle water consumption, it was found that there was a deficit which was accounted for by

drinking from the borehole even when there was water in the pans. Therefore, a statistical regression analysis was performed with age of the water (independent variable) as an indicator for the quality of the water and the difference between total water demand and water consumption from the borehole as the dependent variable. The derived equation for consumption from the pans can be modelled by Equation 8.18 and Equation 8.19. Equation 8.19 represents capita consumption per cattle and that is why it is in litres.

$$WC_{pan} = f(age) \quad \text{[Equation 8.18]}$$

$$WC_{pan} = WC_{capita} - 0.000394 * age \quad \text{[Equation 8.19]}$$

Where,

$WC_{pan}$  is water consumption from the pan (liters);

$WC_{capita}$  is daily water consumption as a function of temperature (litres); and,

Age is the age of water in the pan which defines quality of pan water in days (dimensionless).

Thus, consumption from the pans declines progressively with time as the water quality deteriorates. In addition, it was observed that in the Kgatleng District, as long as a pan holds water, farmers stop going to the boreholes to water their livestock as they drink from the pans. Cattle are thus forced to drink the pan water even when the quality deteriorates. Using Equation 8.19, consumption from the pans was simulated as in Figure 8.17.

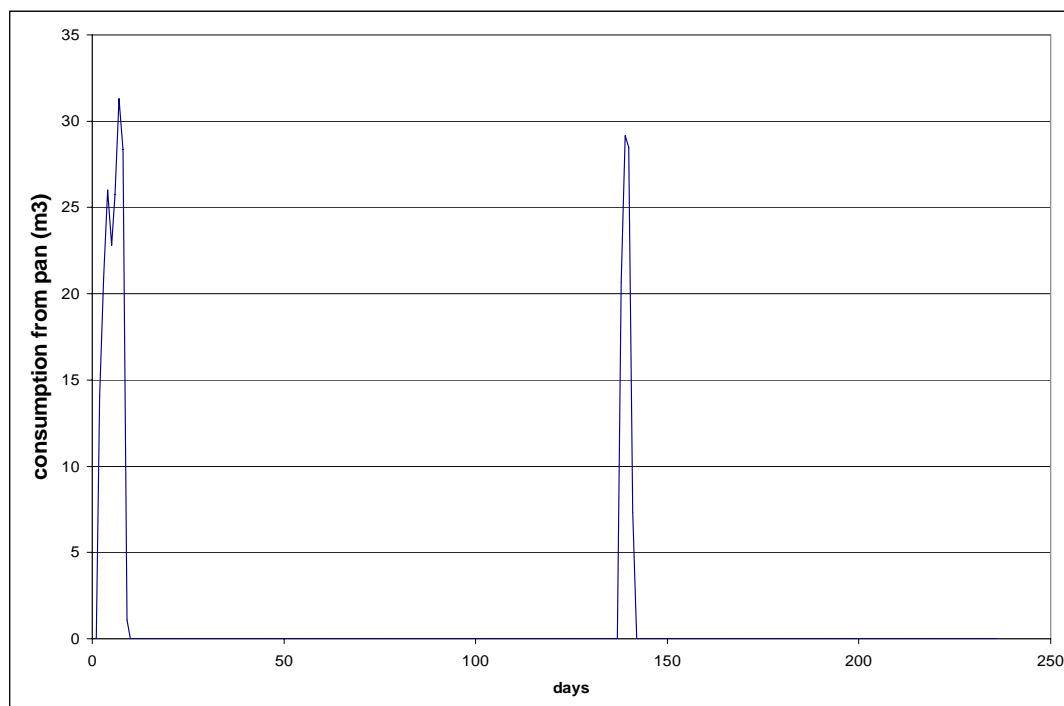

**Figure 8.17: Cattle consumption from the pan.**

### **Forage water content and rainfall in the study area**

In chapter six I discussed factors affecting forage water content and in summary they are stage of growth of forage, available soil water which in turn is a function of effective rainfall and evapotranspiration. For instance, when the rate of water loss by the forage is more than the amount of water drawn from the soil then wilting will take place. In this study, as the cattle are mostly grazers so forage refers to grass, though the study acknowledges that cattle can be browsers, particularly when the grass is limited and scarce.

To determine the amount of water in forage, collected grass samples were weighed and oven dried for 24 hours at 40°C. After 24 hours of oven drying, samples were then weighed. The difference between wet and dry weight was then taken as the weight of water in the samples. Forage samples were collected three times a week on Monday, Wednesday and Friday. The volume of water from the samples was then calculated using the density formula as follows:

$$D = \frac{M(\text{kg})}{v(\text{m}^3)} \quad \text{[Equation 8.20]}$$

Where,

D is density (kg/m<sup>3</sup>);

M is mass (kg); and,

V is volume (m<sup>3</sup>).

At 20 °C, pure water weighs 1000 kg/m<sup>3</sup> or 1kg/liter, this is used to estimate the amount of volume of water in the forage on a daily basis.

Forage water content was modelled as a function of soil moisture index and previous values of forage water content. Both linear and non-linear models were used to estimate forage water content (Equation 8.21 and Equation 8.22).

$$FWC_t = 0.00142 + 0.0175SMI + 0.98FWC_{t-1} \quad \text{[Equation 8.21]}$$

$$R^2 = 0.98$$

	Constant	SMI	FWC <sub>t-1</sub>
Standard error	0.00339	0.00395	0.007503

When forage water content falls below a certain percentage and a rainfall event is experienced it has been observed that forage water content grows exponentially until it reaches a maximum. Therefore a non-linear equation is used to model forage water content as follows (Equation 8.22).

$$FWC_t = 0.24 + 0.423 \ln(SMI) + FWC_{t-1} \quad \text{[Equation 8.22]}$$

In order to model forage water content, it is imperative that available soil water be estimated. This generally entails knowledge of effective rainfall and daily evapotranspiration. Using the SCS Blaney-Criddle method discussed in chapter six, evapotranspiration was estimated using Equation 8.23.

$$ET_a = 0.311T - 4.9 \left[ \frac{(1.8T + 32)\rho}{100} \right] \quad \text{[Equation 8.23]}$$

Where,

$\rho$  is the daily percentage of monthly sunshine hours.

Evapotranspiration was simulated over time, when available soil water was below the wilting point, evapotranspiration for grass was zero. Thus, Figure 8.18 depicts simulated evapotranspiration for grass during the data collection period. Months with the highest evapotranspiration are December and January. While April and May have lower evapotranspiration rates. Average evapotranspiration was then compared to the average observed as depicted in Figure 8.19. May and December are estimated accurately while April and March are underestimated and January is overestimated.

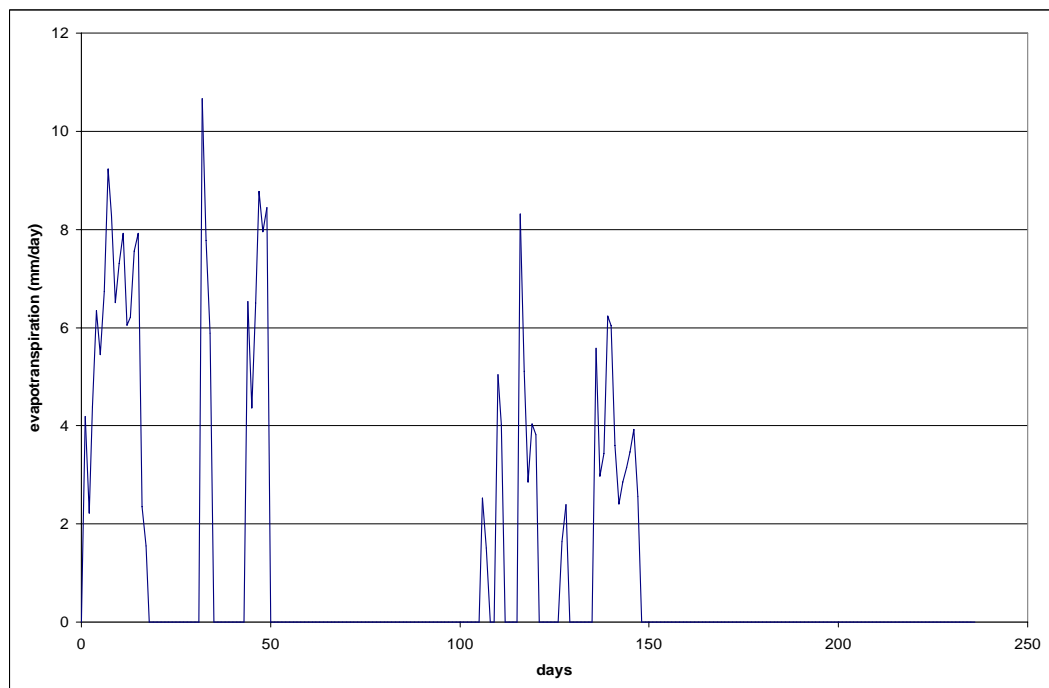

**Figure 8.18: Simulated evapotranspiration.**

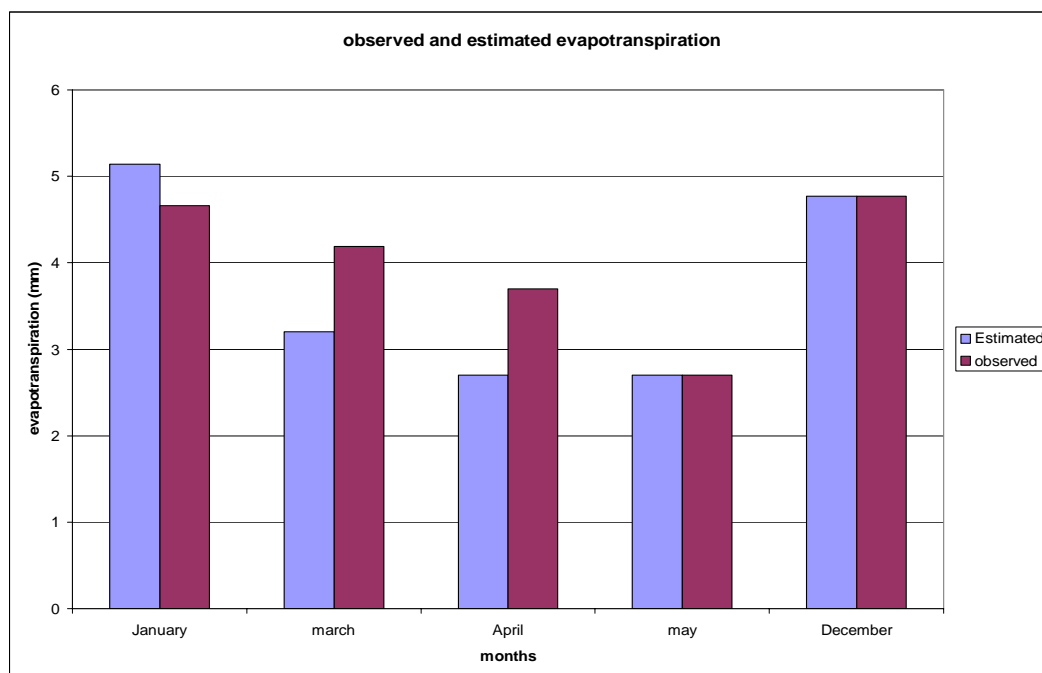

**Figure 8.19: Observed and estimated average evapotranspiration**

Figure 8.20 depicts forage water content over time. The increases are associated with rainfall events and the soil moisture index of one, while the declines are when soil moisture content is below the wilting point. Thus, where there is a decline it means that the forage cannot abstract water from the soils.



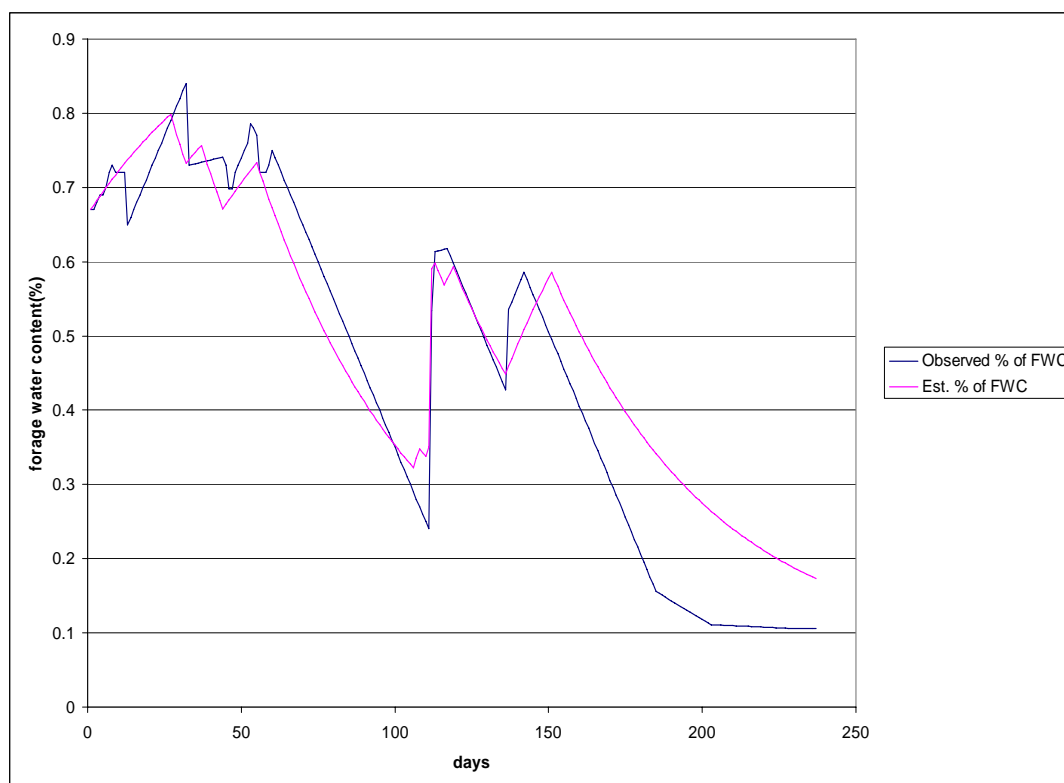

**Figure 8.20: Observed and estimated forage water content**

Water obtained from forage is a product of forage intake, which is estimated as 2.5% of body weight of the cattle and percentage of weight of water in forage. Based on the method above, the water obtained from forage is simulated as in Figure 8.21 below.

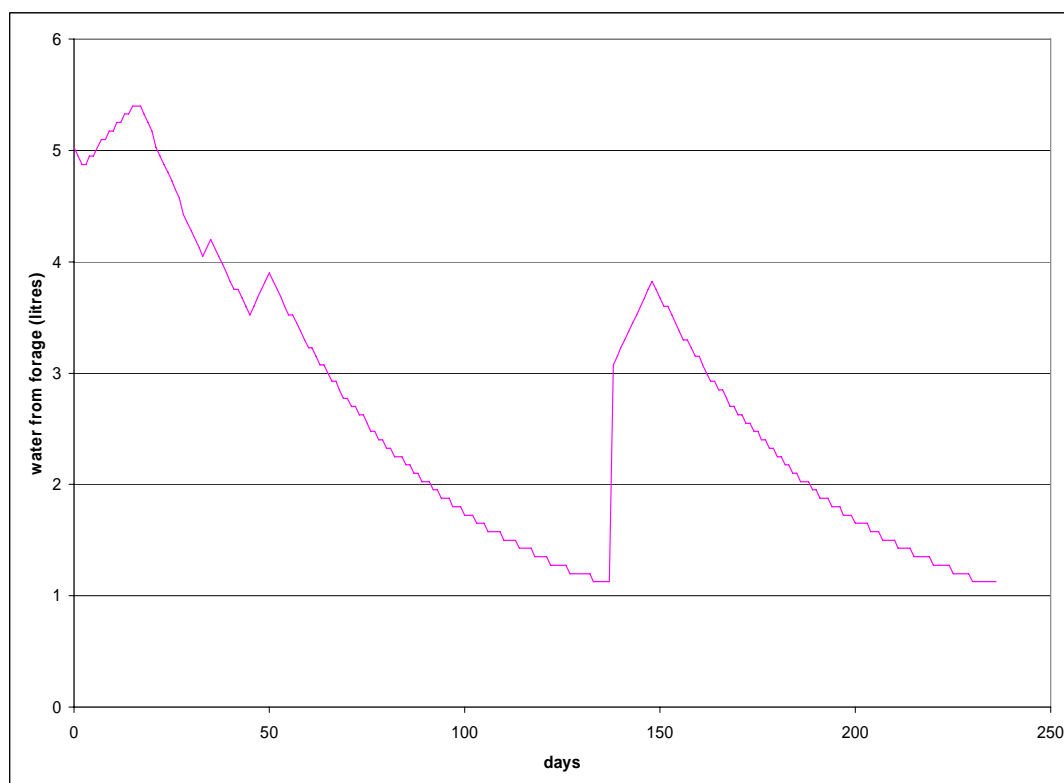

Figure 8.21: Water obtained from forage (litres)

## Estimating groundwater quantity in the Masama Ranch and recharge rates

Masama Ranch overlays one of the most promising and strategic aquifers in the country. The lithostratigraphy composition around the Masama Ranch is Ntane Sandstone and Ramaselwane Basalts, with the Ramaselwane Basalts comprising over 80% (GCS, 1999). The Ntane sandstone aquifer is unconfined in the eastern part of the Masama Ranch and confined beneath basalts in the western part of the Ranch. The Masama Ranch is sitting on top of the Masama fault and according to GCS (1999) the thickness of the basalts around the Masama fault is generally less than 50m.

Quantity of groundwater is estimated by Equation 8.24.

$$Q_{gro.water} = A * T * P$$

[Equation 8.24]

Where,

$Q_{\text{gro.water}}$  is potential maximum quantity of groundwater (cubic meters);

A is the area of the aquifer (in the study this is taken as the area of the Masama Ranch in square meters);

T is the aquifer thickness (meters); and,

P is the aquifer porosity (unitless).

Estimates for aquifer thickness have been determined by GSC (1999). The Masama Ranch is less than or equal to 100m, and this is where the Ntane Sandstone is buried beneath the Ramaselwane Basalts. The porosity of the aquifer in the Khurutshe area is approximately 20% (BGRM, 1994; GSC, 1999). The total area of the Masama Ranch is approximately 43 km<sup>2</sup> (GSC, 1999). Therefore, the total quantity of groundwater beneath the Masama Ranch is approximately 774 000 000 m<sup>3</sup>.

### **Groundwater recharge rates in the Masama Ranch**

Recharge rates estimates for the Khurutshe area have been estimated by GCS (1999). The difference in recharge rates owe to different formations. For instance, areas that are covered by the basalts experience little to no recharge (BGRM, 1994; GSC, 1999). The Masama Ranch recharge is low due to the presence of the basalts in the area. Thus, a recharge of 0.2 mm per year is adopted for Masama as advised by GSC (1999).

Using these recharge rates, an attempt is made to calculate daily recharge as the model is run on a daily basis [Equation 8.25].

$$R_d = A * \frac{R_a}{365} \quad \text{[Equation 8.25]}$$

Where,

A is the area of the aquifer;

$R_d$ = daily recharge; and,

$R_a$ = annual recharge as calculated by GCS (1999).

Using a recharge of 0.2mm per year daily recharge of groundwater on the aquifer beneath Masama Ranch is approximately 23.56 m<sup>3</sup> per day and 8599.4 m<sup>3</sup> per year.

### **Groundwater sustainability and cattle water consumption in Masama Ranch**

One of the main problems addressed by this study is the assessment of sustainability of groundwater utilisation in the Khurutshe area. However, estimating sustainability is not easy and there are uncertainties involved particularly from the recharge side. Recharge estimation in semi-arid environments is highly uncertain (Selaolo, 1998). There are two types of sustainability investigated. The first is calculated as the difference between recharge and abstraction rate. The second type of sustainability is a ratio of the total water available and abstraction rates. This type of sustainability is really relevant in situations where recharge rates are extremely low or zero and this measure generally deals with the depletion period of groundwater. The first measure of sustainability is suitable where recharge rates are high. But where recharge rates are low it could not economically make sense to match abstraction rates to recharge. In this study both measures are adopted because recharge in semi-arid environments is uncertain.

Using the rainfall and temperature data, sustainability index (as a ratio between recharge and abstraction rates) was simulated as depicted in Figure 8.22. As expected, environmental sustainability as the difference between recharge and abstraction rate, is influenced by two climatic variables (rainfall and temperature). Thus, rainfall plays an important role in groundwater resources sustainability in the country. During the summer months, groundwater utilisation is unsustainable as the demand for water increases and abstraction also increases, while during the winter season, sustainability of groundwater abstraction is achieved. In some parts of Kgatleng District, partly the eastern area where groundwater is not abundant and the borehole yields are low, farmers avoid watering their cattle on a daily basis, thus they achieve sustainability particularly in the summer. The situation depicted in Figure 8.22 duplicates what was described by the farmers that in

winter, boreholes are only used six hours a day compared to summer when boreholes can be used up to 18 hours a day. The sustainability index estimated here refers to a recharge rate of 0.2 mm per year. The sustainability index shown in Figure 8.22 is the difference between recharge and abstraction rates. Other measures of sustainability of groundwater utilisation will also be scrutinized in chapter eight for both the Masama Ranch and the Khurutshe area. Due to uncertainty, a weighted mean will also be adopted. Observation of the water table will also be used to investigate sustainability in the Khurutshe area.

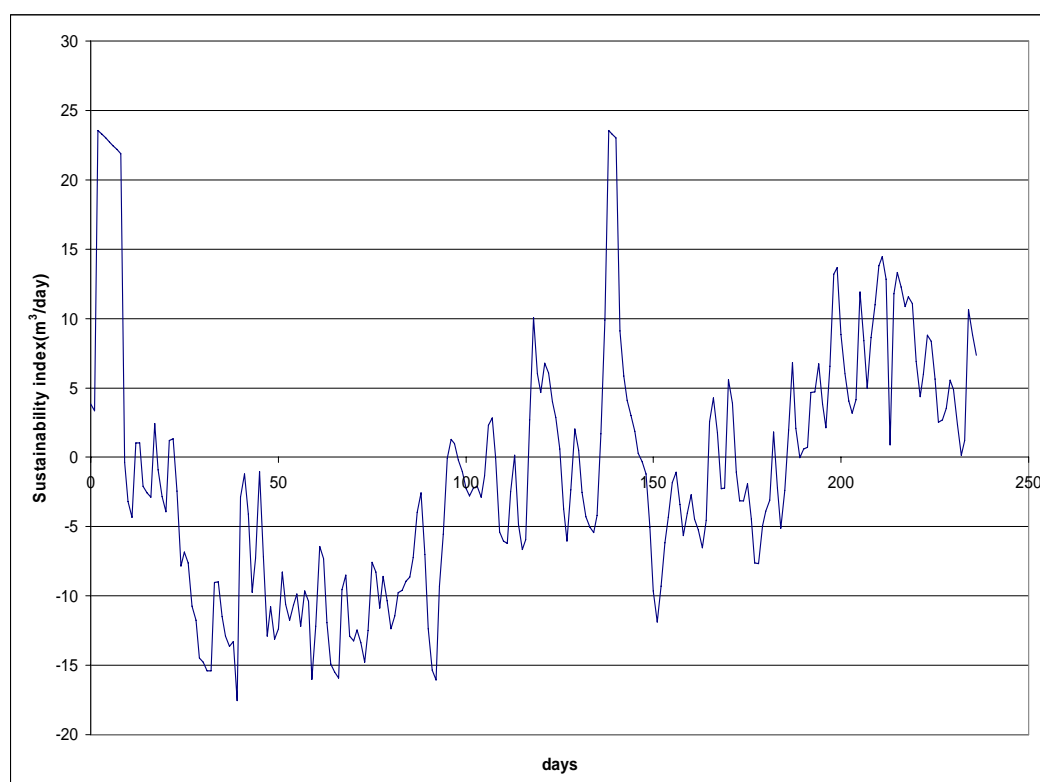

**Figure 8.22: Simulated sustainability index in Masama**

## **Evaluating the validity of the developed cattle water supply model**

Model validity is an assessment of how closely the simulation results mimic the results of the real system. Model validity in itself involves many aspects of testing (Anderson and Bates, 2002; Bossel, 1994; Coyle 1996; Wolstenholme, 1992). Because of the many aspects involved in model validity it has been concluded that

model validity is a complex task especially in system dynamics modelling where it entails user's confidence in the model (Wolstenholme, 1992). For instance, Coyle (1996:12) defines a valid model as "one which is well suited to its purpose and soundly constructed". While this definition may be correct, the question that one may pose is what if the model is well suited to a purpose and soundly constructed but gives incorrect results that are far from the reality. This argument basically reinforces the complexity of trying to validate the model and the numerous aspects involved. Consequently the following are some of the criteria that are used in validating a model (Bossel, 1994; Coyle, 1996; Wolstenholme, 1992). Wolstenholme (1992) divides them into three mutually exclusive groups: test of model structure; tests of model behaviour; and finally tests of policy implications.

- reproducing a reference mode of behaviour. If a model reproduces a reference mode of behaviour of the real system then there is a high level of confidence from the users. This is generally considered very important particularly in system dynamics models. Once the developed model simulates the stipulated reference mode of behaviour then it is considered valid. In fact, determining whether the model is really simulating the reference mode of behaviour of the system is the first task in evaluation of the model;
- the behaviour of the model is plausible. It has been observed that as long as the behaviour of the model is plausible then the user's confidence in the model increases. Behaviour of the model being plausible simply means that the model is producing what is expected. In addition, plausibility deals with the question of whether the model is not producing extreme values in simulation. One may argue that really there is little much distinction between this criterion and reference mode of behaviour;
- the model must have dimensional validity. This criterion deals with the units attached to the variables. The paramount issue here is that we should not add apples to oranges. Thus, each equation must be consistent in terms of units. Then if the criterion is met the user's confidence increases. Most of the software packages such as STELLA automatically check this criterion;

- Another aspect that must be met to increase user's confidence is structural validity. Structural validity is concerned with whether the causal and effect diagram constructed corresponds perfectly to the operation of the real system that one is trying to simulate. It is also suggested that a structurally valid model is one that satisfies the purpose for which it was built, and;
- Statistical validity which deals with statistical characteristic between output of the model and the output of the real system. If the two outputs have the same statistical characteristic or they are closely correlated then statistical characteristic has been achieved.

The validity of the cattle water demand-supply model has already been attempted simultaneous with model simulation. The criterion emphasised in the task was statistical validity. Other criteria such as structural and dimensional validity were achieved through discussion with the farmers and observation of the real system in operation. Structural validity has been achieved by building the model specifically for the objective of the study while at the same time guarding against leaving out vital variables of the system. Dimensional validity is automatically checked by the STELLA software.

In system dynamics, the model is valid if it simulates the reference mode of behaviour. Having observed the real cattle water demand-supply system it was envisaged that the reference mode of behaviour for this system is oscillation, as shown in Figure 8.4. That is, we have expected an oscillation in the abstraction of groundwater for the livestock sector. Figure 8.23 shows the simulated abstraction rate for groundwater in the Masama Ranch, where data was collected for a period of nine months, over a wet and dry season. From the graph, an oscillation pattern in abstraction of groundwater can be clearly seen. This is due to the effects of temperature and rainfall. However, the effects of each on the abstraction rate for cattle are different. Rainfall's influence is extreme such that abstraction rates fall to zero. Temperature's effect on abstraction does not result in abstraction declining to zero but the declines in abstraction rates are substantial. The abstraction rate figures reveal that towards the end of the simulation period, abstraction rates decline markedly. This coincides with the winter season. Even though the year in question had a mild winter, decline in the abstraction rate can

be observed. Therefore, the reference mode of behaviour for the model can be said to be valid.

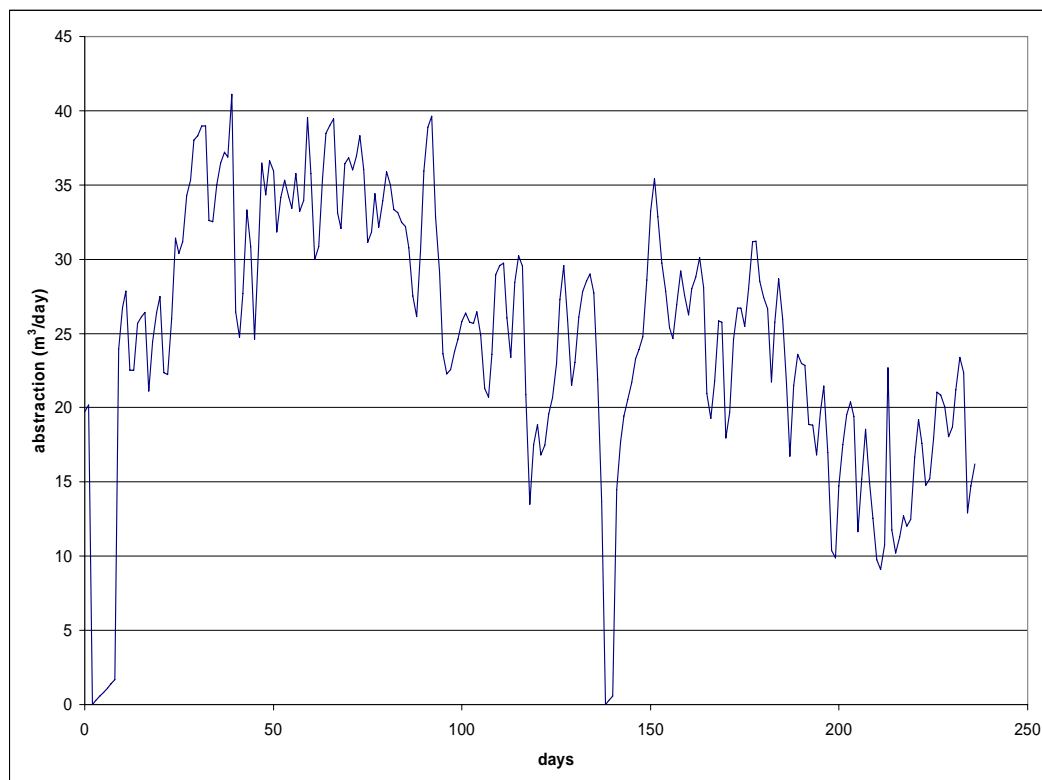

**Figure 8.23: Abstraction rate of groundwater for cattle consumption**

### **Sensitivity analysis of the model**

Sensitivity analysis is undertaken to assess the response of the simulated output to changes in variables. McCuen and Snyder (1986:404) define sensitivity as “the rate of change in one factor with respect to change in another factor”. Unlike other components of the model that require data for model formulation and calibration, sensitivity analysis does not require data. McCuen and Snyder (1986) advise that sensitivity analysis gives an opportunity to scrutinise the behaviour of the model that is free of the error variation that exists when dealing with measured data.

In this study, sensitivity analysis is undertaken using the incremental scenario for temperature. The observed temperature is increased by 10% and 15% to see the response of abstraction rate. Using increased temperature is appropriate for this study as climate change could result in increases in temperature. Figure 8.24



depicts abstraction rates under different temperatures. From the sensitivity analysis conducted, it is clear that increases in temperature results in significant increases in abstraction rates. Obviously, this will have an effect on sustainability of groundwater as it is dependent on the abstraction rate. Figure 8.25 below shows the sensitivity of sustainability index (ratio of recharge to abstraction) to increases in temperature. Once again, temperature increases affect sustainability due to change in water demand. The change for the sustainability of groundwater is also substantial.

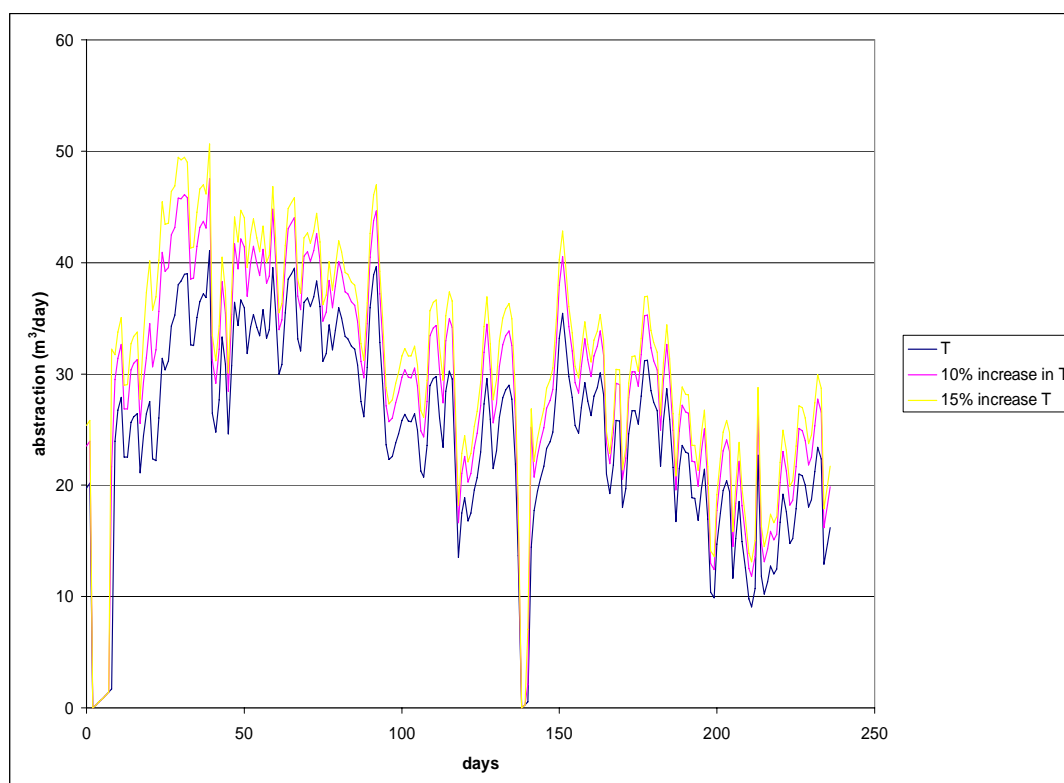

**Figure 8.24: Sensitivity analysis for abstraction rates.**

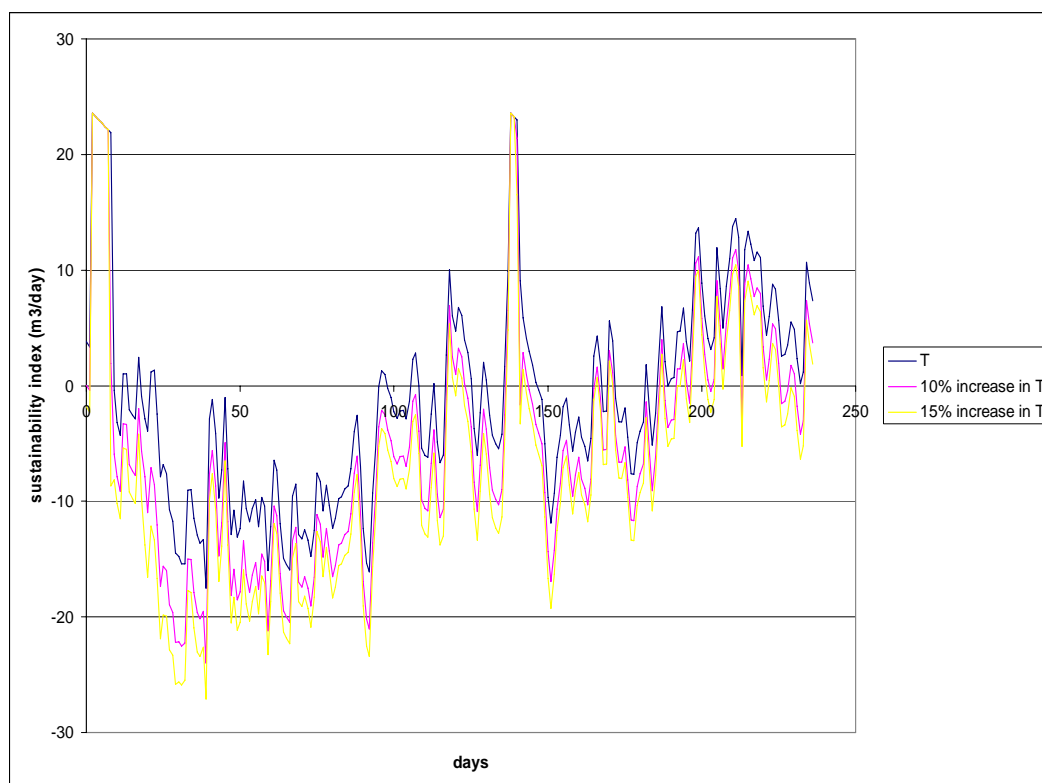

**Figure 8.25: Sensivity analysis for sustainability index**

Lastly, sensitivity analysis was conducted on the assumption made in developing the model. The first assumption that was made is that cattle eat 2.5% of their body weight. The assumption was made in order to estimate involuntary water consumption and overall total water consumption. A test was done on how sensitive total water demand and voluntary water demand are to this assumption. The sensitivity analysis was conducted by increasing forage intake to 5%. Obviously, doubling the forage intake from 2.5% to 5% doubles the involuntary water intake. The results obtained indicate that total water intake (voluntary + involuntary intake) increases by 6.7% on average (from January to October). The maximum increase during that period is 13.2% which coincides with the rainy months and the lowest increase being 2.12% coinciding with the non-rainy months. However, this increase in forage water intake as forage intake increases does not affect water voluntary intake, as it was derived by regressing observed water intake against temperature.

The second assumption that was made in developing the model was fixing the hours of sunshine per day to 8.5 hours. Hours of sunshine are needed for

estimating evaporation rates. The sensitivity of the evaporation was tested by increasing hours of sunshine to 13 hours which is the longest day in the country. Results indicate that evaporation is not very responsive to the major increase as it only increased by 0.43%. Thus, this assumption does not have any major impact on evaporation rates.

It is also imperative to test the robustness of the developed model. The robustness of the model basically defines the ability of the model to perform under different scenarios and assumption. It simply deals with the predictive power of the model given different data and also assumption. In this study, the robustness of the model was tested by using different data set from the one used to calibrate the model. Thirty day temperature and rainfall data was used to test the robustness of the model. The predictive power of the model was tested for abstraction and daily water consumption. The results indicate under independent data the model's performance in simulating abstraction, daily water demand is impressive for all the variables of interest. For instance, livestock water consumption was predicted using different rainfall and temperature and the results obtained from independent data were similar to those from the dependent data source. Lastly, it must be emphasised that the model developed here is site specific. For the model to be applied in another location, the following modifications must be made; the distance between water points and grazing area; farmer's water management strategies and seasonality.

## Summary

In this chapter I developed and tested a cattle water demand and supply model for the Khurutshe area of the Kgatleng District. Using prevailing climatic variables mainly temperature and rainfall, a simulation of cattle water demand and supply was conducted. Results from the simulation indicate that cattle water demand and supply is determined by prevailing climatic condition. The major findings from this chapter are that temperature highly influences water demand for cattle. In summer months, water demand more than doubles due to high temperature while in winter months demand falls as animals skip coming to the borehole. The high water demand during the summer has an effect on sustainability as manifested through local groundwater depletion resulting in a decline in the water table. On

the other hand, rainfall can affect water supply rather than demand. During the rainy seasons cattle drink from the pans whenever pans are filled. This temporarily relieves pressure on the groundwater resources. However, simulation results unveiled that pan water in the Khurutshe area which is on the sand veldt, is not a very important source of water for cattle (in contrast to the situation in the hard veldt).

Validation was based on the following aspects: plausibility of the simulation output, statistical character of the output, and the structural validity and reference mode of behaviour for the model. The model simulated the reference mode of behaviour of oscillation and is thus validated. In addition, all simulated stock and flow outputs match closely to those obtained in the real system, *i.e.*, the statistical characteristics of the simulated outputs and real system outputs. In addition, the model is structurally valid as the model was constructed to achieve the objectives of the study while at the same time not compromising or leaving out any vital variable of the system.

Sensitivity analysis was conducted to determine the model's performance. This was done by changing variables to determine whether the model performs as expected. In this study it was found to be more appropriate to do sensitivity analysis by changing temperature incrementally. Thus, temperature was increased arbitrary by 10% and 15% to see the responsiveness of water demand and consumption. As expected, increasing temperature resulted in an increase in water demand and abstraction of groundwater.

In the next chapter I investigate the impacts of climate change on cattle water demand and supply in the Khurutshe area, with emphasis on the Masama Ranch where field data was collected. This is done by perturbing the model with climate scenarios (rainfall and temperature) constructed in chapter four.

## Chapter 9 : Impacts of Climate Change on Cattle Water Resources

---

### Introduction

In this chapter I discuss the overall impacts of climate change on livestock water demand and supply. This is achieved by answering the primary question of this study: What impacts could climate change have on cattle water demand and supply in Khurutshe, Botswana? Issues specifically addressed to assess the impact of climate change on water demand and supply are: sustainability of abstraction rates for groundwater given current demand; the contribution of current supply options for cattle water demand and the effect of climate change on supply options; the effect of climate change on water demand and on supply options and how this could affect abstraction rates by 2050; and lastly, the impact of climate change on sustainability.

In assessing the impacts of climate change on water demand and supply two GCM models are used: HadCM3 and CSIRO Mk2. These two models were chosen primarily because of their characteristics in describing future climates. For instance, the HadCM3 projects a substantial increase in temperature and a relatively small change in precipitation by the year 2050 for the study area. On the other hand, the CSIRO Mk2 projects a small increase in temperature and a steep decline in precipitation for the study area. Because there is uncertainty in the GHGs emissions, three SRES emission scenarios are used as recommended by IPCC (1998). These are A1B, A1FT and A1T. These emission scenarios have been selected as they encompass the spectrum of GHG. For instance, the A1FT emission scenario is based on the assumption of a more fossil fuel intensive world; A1B a balanced use of all fuel sources and lastly, the A1T is based on the

assumption of non-fossil fuel. The mechanistic model developed in chapter eight is used to assess the impacts of climate change on water demand and supply of cattle in Khurutshe. Analysis conducted used a constant number of cattle for both the baseline and the year 2050. The constant number is 700 for Masama Ranch and 45 000 for Khurutshe. 700 cattle is the carrying capacity of Masama Ranch which is within the Khurutshe area and 45 000 cattle was estimated based on the number of boreholes in the Khurutshe area. A constant number of cattle was adapted for both the baseline and 2050 to reduce complexity in modelling, particularly the dynamics of cattle population. The impacts of climate change are defined as the difference between outputs of the baseline and 2050. These impacts can either be positive or negative, depending on temperature and rainfall which are the model's drivers.

For clarity and, to make graphs more readable, particularly when reporting numerous variables (*e.g.*, minimum, average and maximum values of variables) values projected by one GCM and emissions scenario are shown on the graph. The GCM selected is the HadCM3 and the corresponding emission scenario is A1FT. The reason for selecting HadCM3 A1FT is because it projects extreme values and other values for emission scenarios and GCMs will be between the HadCM3 A1FT and baseline values.

### **Baseline water demand and supply in a semi-arid grazing system**

In this section I discuss water demand and supply for a grazing system in a semi-arid environment. Issues discussed include: monthly demand; the effect of seasonality on demand; contribution of surface water from rain to cattle water demand over the baseline years; variability in the monthly abstract rates of groundwater; and sustainability issues specifically for the Masama Ranch and to the overall Khurutshe area.

## **Cattle water demand, abstraction rates under the baseline period**

Temperature is the most important determinant of water demand for cattle (Lardy and Stoltenow, 1999; Parker *et al.*, 2000). However, forage water content is also an important variable as it determines cattle's involuntary water intake. It is observed that there is a noticeable difference between demand in summer and winter months. In summer, water demand is nearly twice as great as winter. In winter it is cold and water loss by perspiration is low, therefore cattle do not need water on a daily basis nor do they drink consistently. In contrast, during the summer season, cattle consume water on a daily basis and in large quantities to replace water loss through perspiration. It is also observed that during the winter, even though cattle come to the borehole on a daily basis, when the consumption is high on one day, it will be low the next day. This information was provided by 33 farmers interviewed in the Kgatleng District on water demand and seasonality. In addition, Burgess (2003) observed that in Botswana during the winter season cattle wander over 30 kms from the borehole and stay away for days without returning to the boreholes. However, Burgess' observation cannot be relied upon as a pattern of water consumption during the winter season because while cattle can wonder for 30 kms from their boreholes they can still drink at any nearby borehole. Excludability from drinking on different boreholes is rarely enforced by farmers as was evident during data collection and discussion with farmers.

IPCC (2001; 2007) defines baseline period as a 30 year period from 1960-1990. This data set was used to estimate water consumption from boreholes, pans, forage water content and sustainability based on temperature and rainfall events. Figure 9.1 shows calculated per capita water consumption for Masama Ranch for all the months during the baseline period. The red colour represents hot (summer) months, yellow represents mild months and blue represents winter months. The average per capita demand are 48.1 and 29.2 litres day per day for summer and winter months, respectively. The annual average per capita consumption of 40.5 litres per day is close to the findings by Parker et al (2000) of 40.9 litres per day for beef cattle in the semi-arid, Texas High Plains. The average demand for this

study is the average demand for six days. These values correspond well with recorded daily per capita figures from numerous studies and recorded consumption in this study.

Table 9-1 gives values for estimated water consumption by Lardy and Stoltenow (1999) and this study. Though there are some differences, the values are quite close. For instance, at a temperature of 31 °C, the difference between Lardy and Stoltenow's estimated water demand and this study is 0.8 l while for temperatures 22 °C and 25 °C the differences are 7 and 9 l respectively. In addition, Lardy and Stoltenow (1999) show the dynamics of daily water demand between summer and winter months which show marked fluctuations in demand between seasons. This consumption corresponds with the observation made by SMEC (1991) that in Botswana, average consumption (summer and winter months) per animal is 45 litres per day. In the semi-arid environments of Texas, USA Parker *et al.*, (2000) estimated averaged per capita daily water intake at 40.9 l per day based on a 2 year period data. It must be pointed out that cattle in the Masama Ranch, and Botswana in general, are allowed limited time for water consumption. For instance, in Masama Ranch they are only allowed two hours of drinking and are then herded either to grazing points or the gates to the troughs are closed. A farmer who ferries water from Mochudi to his cattle post worked out that on average a 180 litres drum of water lasts three days for one bull, while other cattle drink less than bulls. This therefore works out to be 60 litres a day for a bull during summer months.

Figure 9.2 depicts total monthly water demand for the baseline period for Masama Ranch. Total monthly water demand is a product of per capita daily demand, days of a month and number of cattle. Water demand for the summer months is twice that of winter months (May, June, July and August). However, the lowest demands occur in June and July (mid-winter), while other months such as May and August are characterised by both low and high temperatures.



The model developed in the study was based on the data collected from the Masama Ranch. By changing variables such as cattle number and number of pans, the model was extended to the whole Khurutshe area.

**Table 9-1: Comparison of daily water consumption in litres with other studies**

Temperature	Water consumption (Lardy and Stoltenow, 1999)	Water consumption (this study)
22	34.02	27.0
25	37.8	28.3
31	52.92	52.1

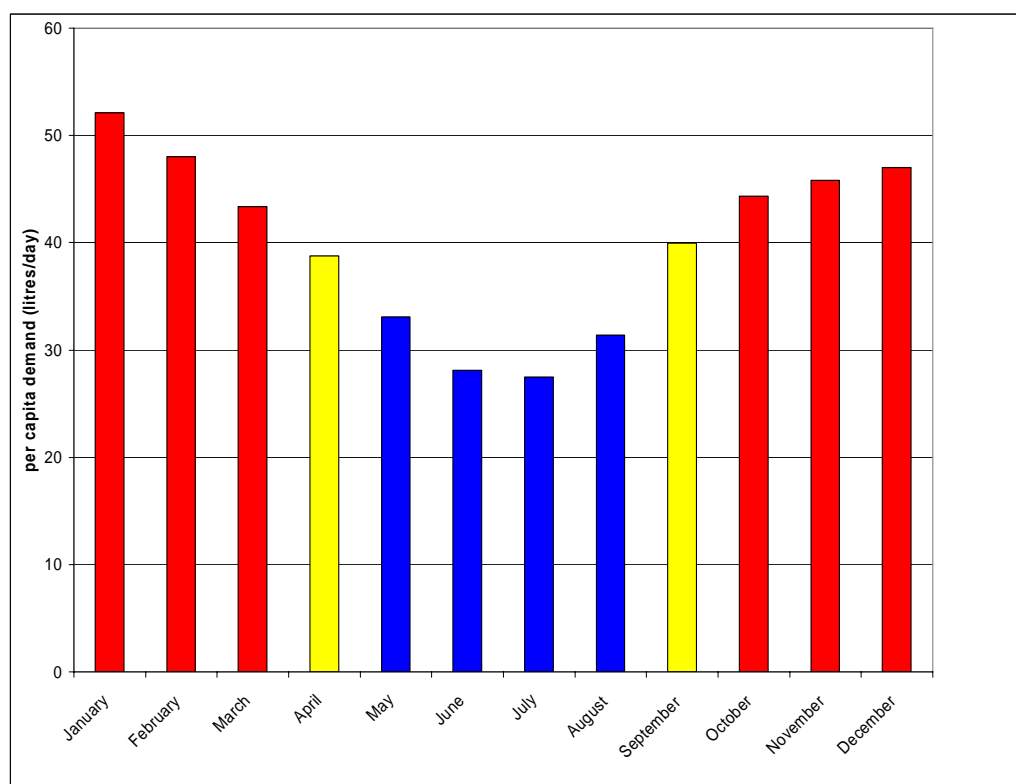

**Figure 9.1: per capita consumption for the baseline period**

Total monthly water demand for February and March are equal (Figure 9.2) and the same applies to October and November. However, in Figure 9.1, the daily demand per capita for these months are not equal. For instance, February has a

higher demand than March, this is due to the number of days. February demand is divided by fewer days compared to March. The same applies to the October and November demand, from Figure 9.1. Per capita demand for November is slightly higher than October.

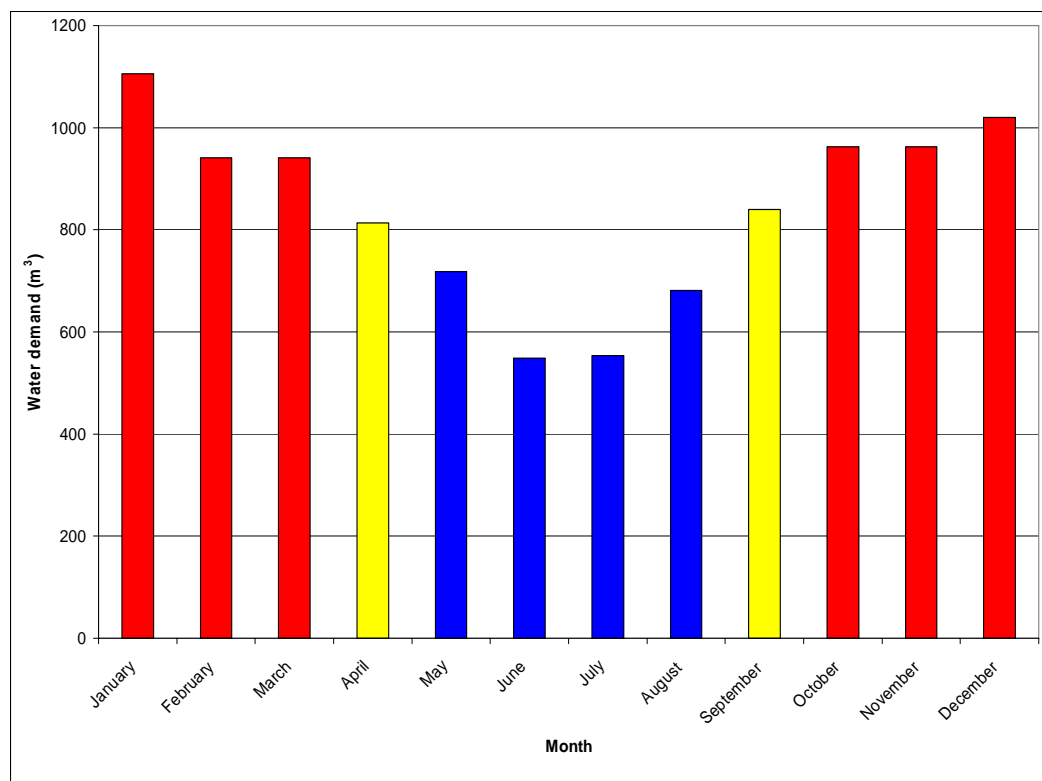

**Figure 9.2: monthly water demand for the baseline period for Masama Ranch**

In addition to determining monthly water demand for the baseline period, total water demand was also determined on an annual basis, which included supplies from boreholes and pan water. Intuitively and logically, total annual water demand should be constant over the baseline period. However, this is not the case, as some years were hotter and drier than others. For instance, drought years generally have high temperatures compared to wet year. Moreover, drought years have drier forage relative to years with above-normal rainfall. For these two reasons, water demand for drought years will exceed water demand for normal rainfall and above normal rainfall years. Figure 9.3 shows the variation in total annual water demand for the baseline period for Masama Ranch. As pointed out, there are some marked variations in total water demand during the baseline period. High water demand corresponds significantly with drought years of 1964, 1968, 1982 and 1983. Drought years are noted by the difference between borehole curve and total water curve. Where there is a considerable difference between the

two curves it was a wet year. On the other hand some years received good rainfall yet annual water demands has been relatively high. This is attributed to high temperatures which led to an increase in overall water demand.

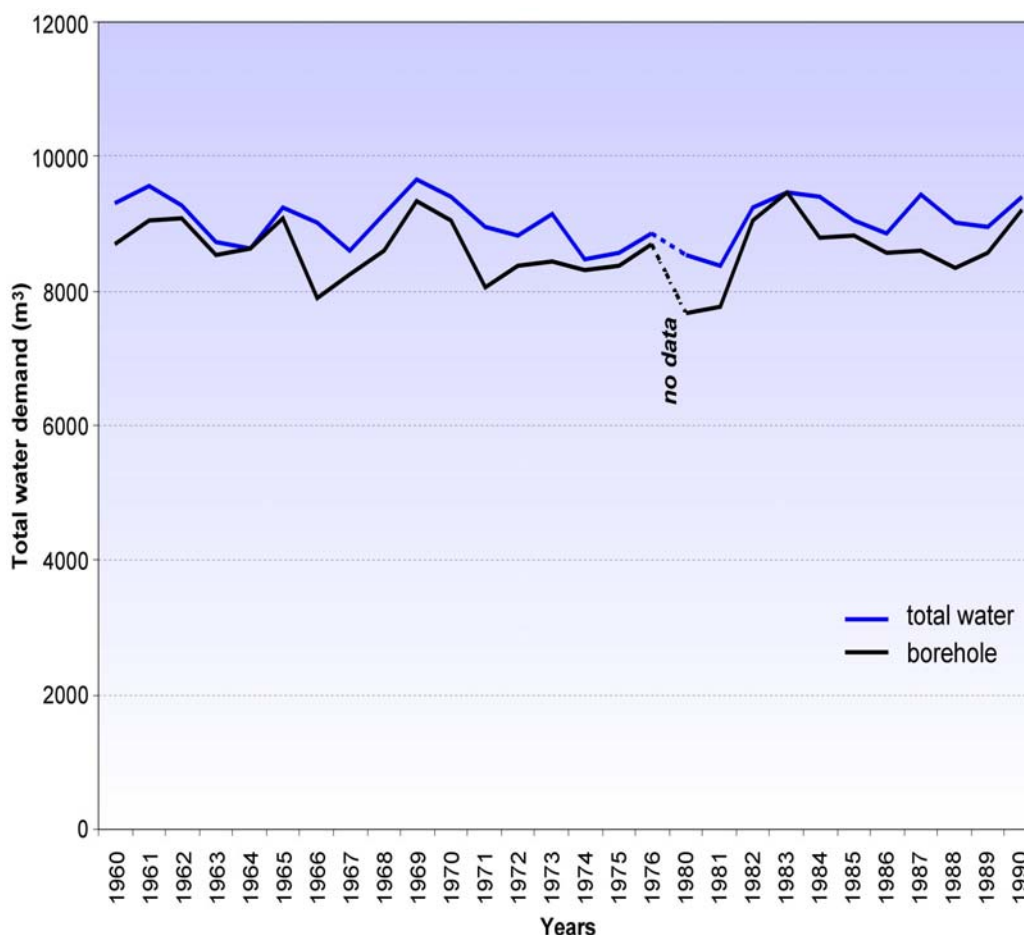

**Figure 9.3: Annual water demand between baseline years.**

The maximum, minimum and mean annual water demands during the baseline period are 9662, 8369 and 9039 m<sup>3</sup> respectively. As pointed out, variations in consumption are due to variation in temperature and the drought years which determine the forage water content and water demand from borehole and pans. From analysis, water demand for cattle is not constant on a yearly and monthly basis but fluctuates as a result of changes in temperature. Drought years generally have higher demands. These findings have serious implications for future water demand as climate change will affect the return period of drought in the country and also the magnitude of drought as noted in chapter five.

## **Contribution of pan water to annual livestock water demand and climate change**

The contribution of pan water is critical to this study as a change in rainfall affects the quantity of pan water supply for cattle which in turn increases reliance on borehole water supply. Thus, changes in quantities of pan water influence abstraction rates for groundwater and groundwater sustainability. The contribution of pan water to cattle water demand is a function of rainfall and the geological setting. As pointed out in earlier chapters, Botswana has two distinct geological settings: the sand and hard veldt (Harvey and Lewis, 1990). Kgatleng District is covered by both veldts. The eastern part of the District is predominantly the hard veldt while the western part including the Masama Ranch is dominated by the sand veldt. Thus, the contribution of pan water to cattle water demand in Masama Ranch is representative of the western part of the Kgatleng District only (Khurutshe area) and not the eastern part of the District.

Figure 9.4 shows the contribution of borehole and surface pan to cattle water demand on a monthly basis for the baseline period. Without doubt, borehole water is a major supplier of cattle water demand. The maximum contribution of surface pan water is 12.7% and the annual average contribution of pan water is 3.8% for the baseline period. But when the winter months May, June, July, and August are excluded from the mean contribution of surface water, the average contribution becomes 6.48%. On average, boreholes satisfy over 95% of cattle water demand. These findings are in contradiction to the findings by Mpotokwane (1999) and Oageng (1999) that during the rainy season, pan water can supply cattle for the entire rainy season or four months of the year. Farmers in the eastern part of Kgatleng District (hard veldt) noted that pans are an important source of water for cattle which was consistent with Mpotokwane's findings that pan water can supply cattle for all the rainy months.

There are several reasons for the inconsistencies between studies. Firstly, Masama Ranch is in the sand veldt and therefore runoff generated is inhibited by high rates

of infiltration of the Kahalari sands. Water collected in pans is quickly lost due to high infiltration rates. This was confirmed during data collection on daily quantity of water in pans after rainfall events. Most water was lost through seepage. Secondly, in the Masama Ranch and Khurutshe in general, pans are relatively small compared to the eastern part of the Kgatleng District. Thus, pans play a very small role in supplying water to the cattle in the Masama Ranch and generally in the sand veldt part of the country. As expected, in winter months the contribution of pans to water demand is negligible as rainfall is generally in the summer season. These results of contribution of pan water to cattle water demand apply to the Khurutshe area as the geological setting is similar.

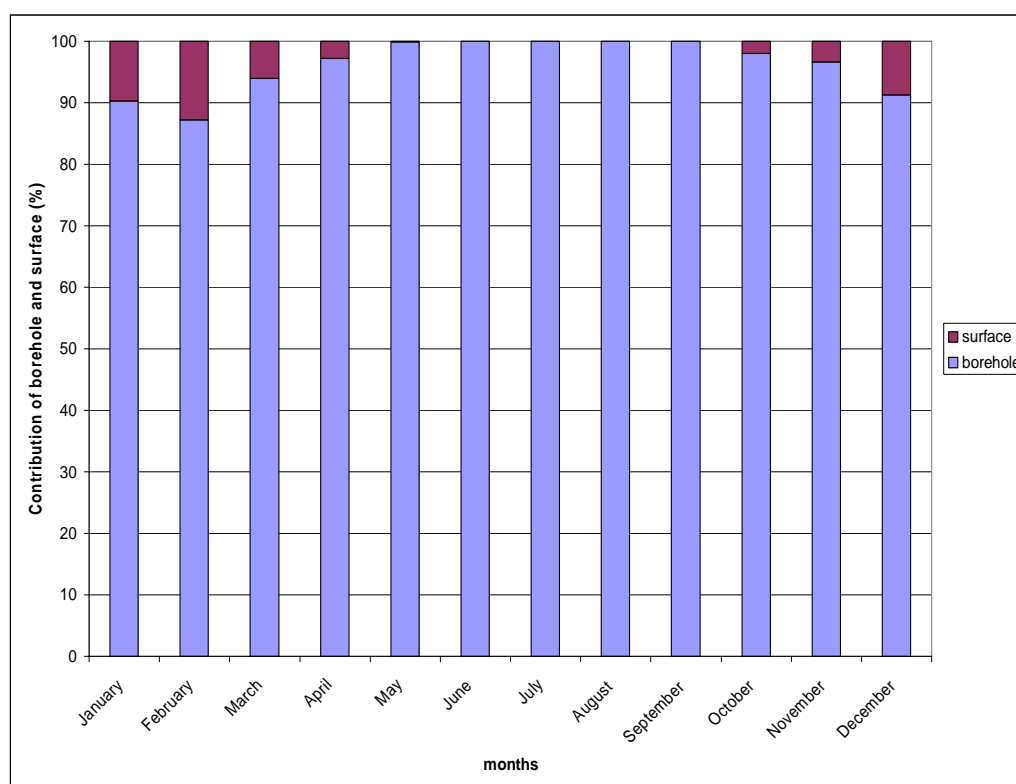

**Figure 9.4: Monthly contribution of surface and borehole to cattle water demand for the baseline period.**

Table 9-2 shows the standard deviation for the contribution of pan water to cattle water demand for the baseline period. The values were generated from monthly contribution of pan water for the baseline (1960-1990). The purpose of estimating standard deviation is to show the variation of the contribution of pan water to cattle water demand. From the constructed standard deviation it is clear that within months, the contribution of pan water is highly variable particularly for the

rainy months (January, February, March, November and December). In winter months there is no deviation from the mean because there was never water in the pans. During the baseline period there are some months in the rainy season where there was no contribution to cattle water demand. For instance, during the baseline period, some months of January contributed nothing to cattle water demand. Conversely, in some months pans contributed over 60%. Figure 9.5 shows the maximum contribution of pan water. Obviously, the minimum contribution for all the months is zero. In contrast, winter months are consistent with no contribution of pan water to cattle water demand for the entire baseline period.

**Table 9-2: Standard deviation for the contribution of pan water to cattle water demand for months**

Month	Standard deviation (m3)	Mean (m3)
January	177.2	107.0
February	164.5	120.2
March	106.7	57.2
April	58.2	22.4
May	5.7	1.06
June	0	0
July	0	0
August	0	0
September	0	0
October	58.7	19.4
November	99.4	32.7
December	138.3	85.5

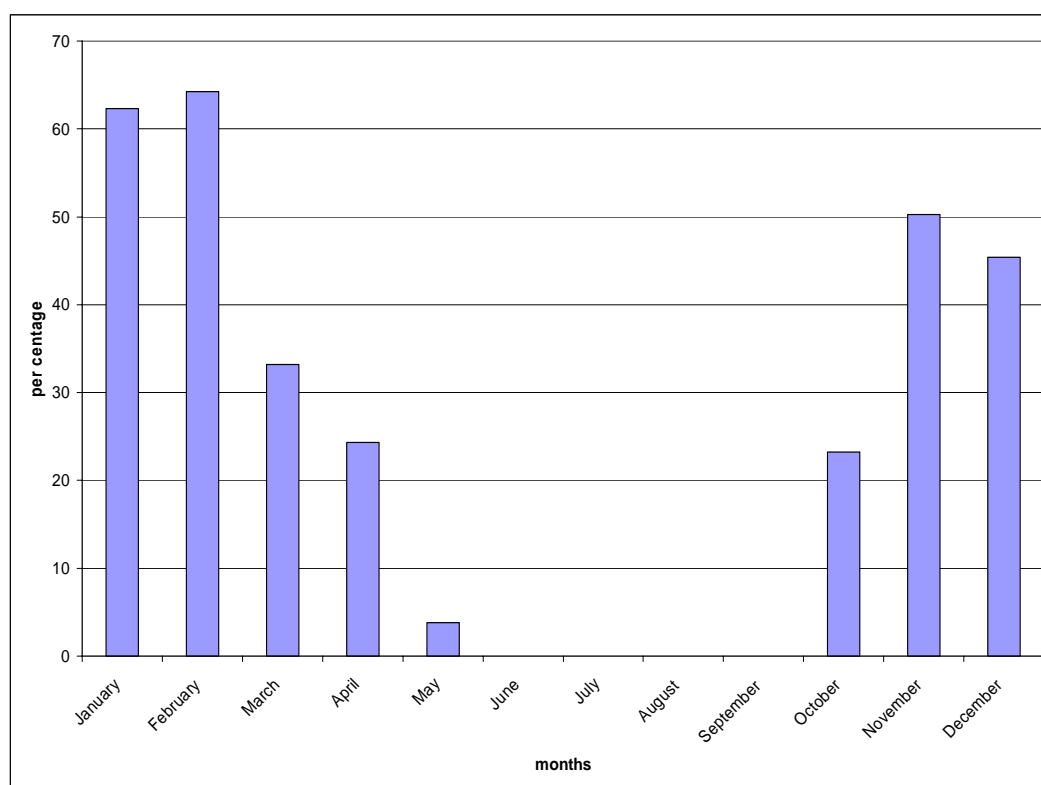
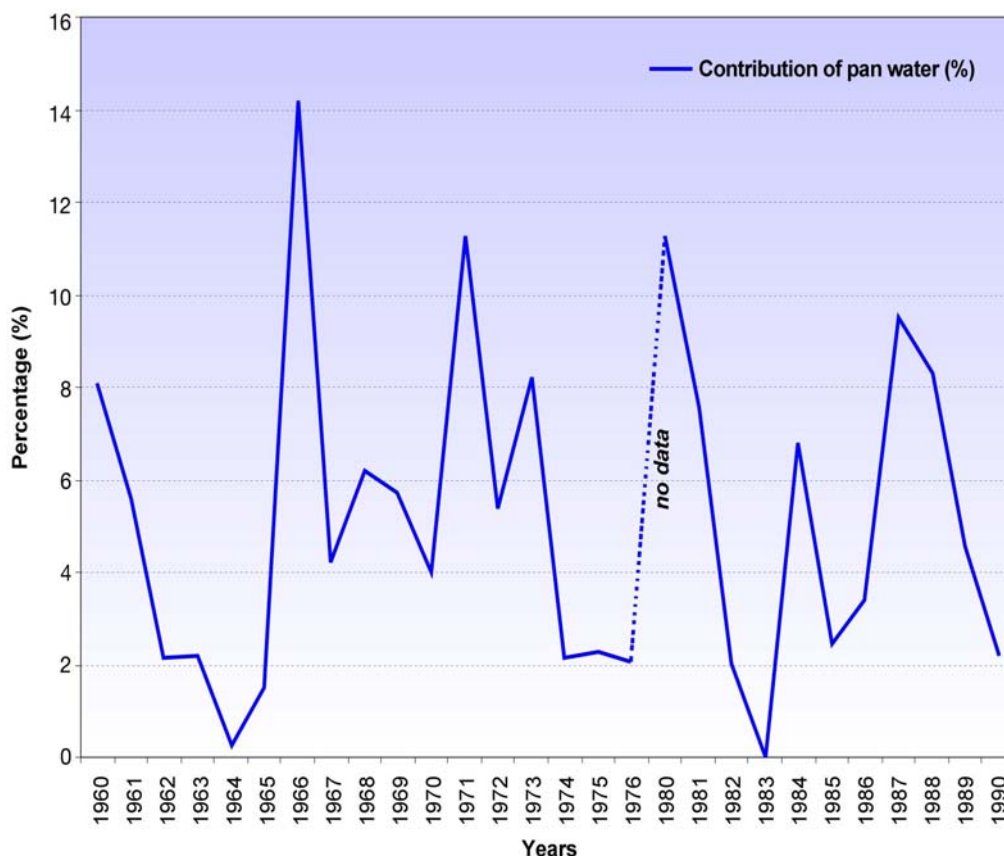

**Figure 9.5: Maximum contribution of pan water to cattle water demand**

An assessment was done of maximum contribution of surface pan water for the baseline period, 1960-1990, (Figure 9.5). Each month's maximum is based on all the data for all those months in the time-series. Based on Figure 9.4 and Figure 9.5, the contribution of pan water is highly variable but generally low. In some years, such as the severe drought years of 1964 and 1983 the contribution was zero, Figure 9.6. In other years of mild droughts the contribution was low. On a yearly basis, the maximum average contribution during the 30 year period was attained in 1966 with 14.2% followed by 1973 and 1980 with 11%, Figure 9.6.

Various studies have emphasised the importance of pans as water sources for cattle during rainy seasons (Arntzen *et al.*, 2003; Moleele and Mainah, 2002; Mpotokwane, 1999; Oageng, 1999). The Ministry of Agriculture also recognised the role of pans and encouraged their utilisation by subsidising their rehabilitation through fencing, excavation and lining to enhance water holding capacity (Oageng, 1999). However, during this study it was found that on average, the contribution of pans to annual cattle water demand ranged between 0 and 14%. This is owing to the low runoff and high seepage rates of the sand veldt. Based on

the findings of contribution of pan water to cattle water demand, it can be anticipated that changes in precipitation as a result of climate change would not have major impacts on the abstraction rates of groundwater on the sandveldt part of the country. Thus, it is anticipated that if there will be substantial impacts of climate change on abstraction rates of groundwater they will come through temperature and maybe forage water content through a combination of high temperature and a decline in rainfall.



**Figure 9.6: Annual contribution of pan water to annual water demand for the baseline period for Khurutshe area.**

### **Forage water content under the baseline period**

Water contained in forage is another source for cattle in semi-arid environments. Water obtained from forage is a product of the percentage of water in forage per gram of forage and daily forage intake. Water in forage is influenced by seasonality with a maximum during the rainy summers and minimum during the



drier winters. Thus, cattle derive the maximum amount of water from forage during the rainy season and little during winter. However, the winter is a period when per capita consumption of water declines. Figure 9.7 depicts grams of water per gram of forage per gram for the baseline period. This is based on a 30 day period. For instance, in January, the 73% maximum can be at the beginning of January while the 40% minimum can be at the end of January. Maximum, average and minimum forage water content values were computed on a monthly basis. The range between maximum and minimum values of forage water content means that forage water content can be highly variable in a month depending on soil water content which determines wilting of forage.

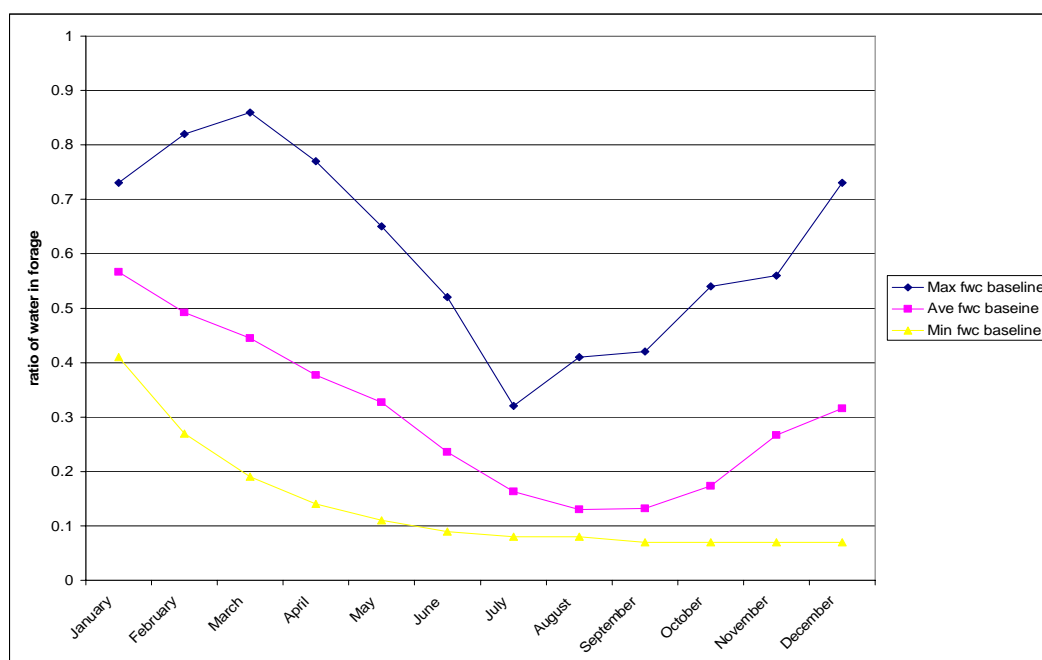

**Figure 9.7: Ratio of water in forage per gram for the baseline period**

### **Abstraction rates of groundwater and sustainability for the baseline period**

Groundwater abstraction is managed on the basis of meeting day-to-day cattle demands. That is, farmers recharge what has been withdrawn from storage tanks. Inevitably, abstraction rates mimic the pattern of the monthly water demand for cattle. Figure 9.8 depicts monthly abstraction during the baseline period. Summer months record the highest maximum abstractions. Winter months mark the lowest

maximum abstraction due to a decline in water demand. The average abstraction rates for groundwater are always lower than the maximum abstraction values as they are pulled down by the zero abstraction rates during the rainy seasons. Interestingly, as seen in Figure 9.8, the months that record the highest abstraction rates have minimum abstraction rates of zero, this is due to the availability of pan water when cattle drink from pans. Winter months, however have the lowest maximum abstraction and highest minimum abstraction rates compared to summer months. This is due to the fact that in winter, there is no surface water from pans and therefore abstraction rates do not fall to zero. An in-depth analysis of the maximum and minimum values of abstraction rates shows that they depict reference mode of behaviour of oscillation as described in chapter eight. During the hot summer months, the demand for water is high and it follows that abstraction rates are high to meet the demand. At the same time, there is occasional pan water available for the cattle thus, occasionally the demand for borehole water falls to zero as the animals drink freely from the pans. On the other hand, during the winter months, the demand for water falls due to lower temperatures but because there is no pan water available, abstraction does not fall to zero but to lower values which are higher than the zero abstraction rates associated with summer months.

The variations on abstraction rates for groundwater as estimated in this study are consistent with the findings by farmers who revealed that during the summer months, engine-pumps are used between 12 and 18 hours per day due to high water demand. Whereas during winter months, engine-pumps are only used for six hours on average per day. Furthermore, to corroborate the findings, farmers were asked what quantity of diesel was used in summer and winter months. They revealed that 200 litres of diesel lasted a month in summer and 2 to 3 months in winter.

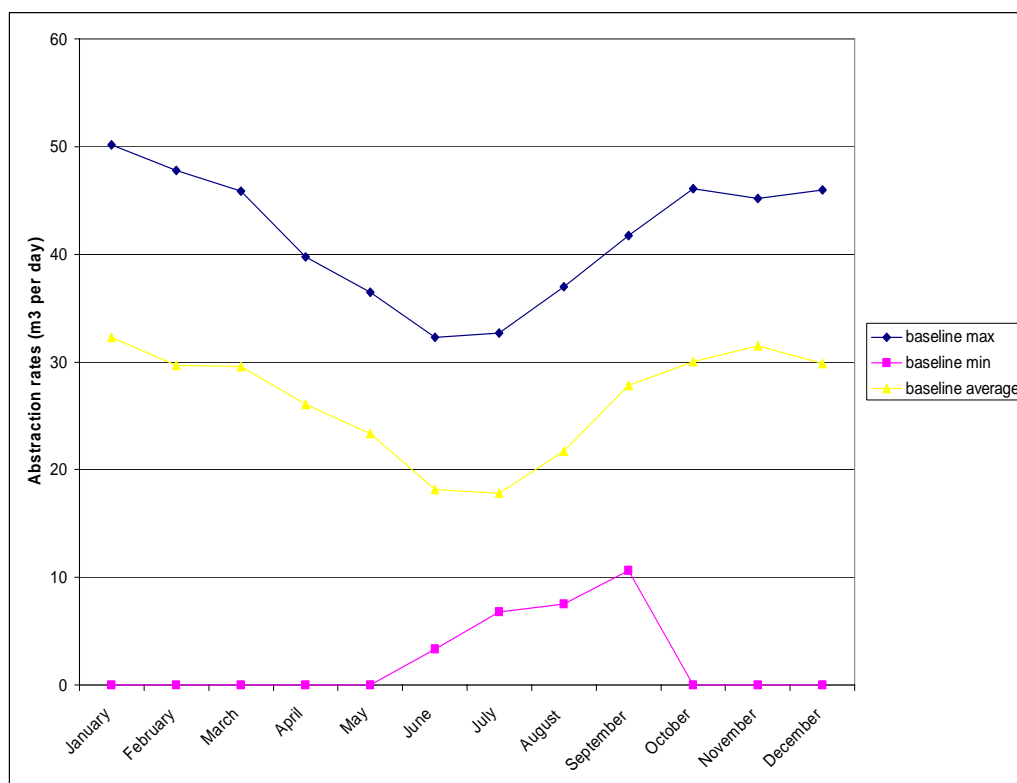

**Figure 9.8: Monthly abstraction rates for the Baseline period.**

To assess the impacts of rainfall and associated pan water on abstraction rates, the average monthly consumption was also calculated excluding all days with pan water available. Figure 9.9 depicts the effect of pan water on abstraction of groundwater to satisfy water demand. Hypothetically, without rainfall the daily abstraction for January, February, November and December would increase moderately. In winter there is no difference between the two values as no surface pan water is available to affect abstraction rates of groundwater. However, it should be emphasised that this is an incomplete assessment of the impacts of rainfall on abstraction. What is shown here is the direct effect of the lack of availability of surface water. There is also an indirect effect of no rainfall on abstraction rates through temperature. Based on observation from temperature and rainfall data used in this study rainy days are relatively cooler than days without rainfall events. Hence, with no rainfall, temperatures tend to increase and this affects water demand and consequently the abstraction of groundwater to meet the increased demand. Farmers also indicated that cloudy days have an effect on daily water demand. During cloudy days cattle rarely come to the boreholes.

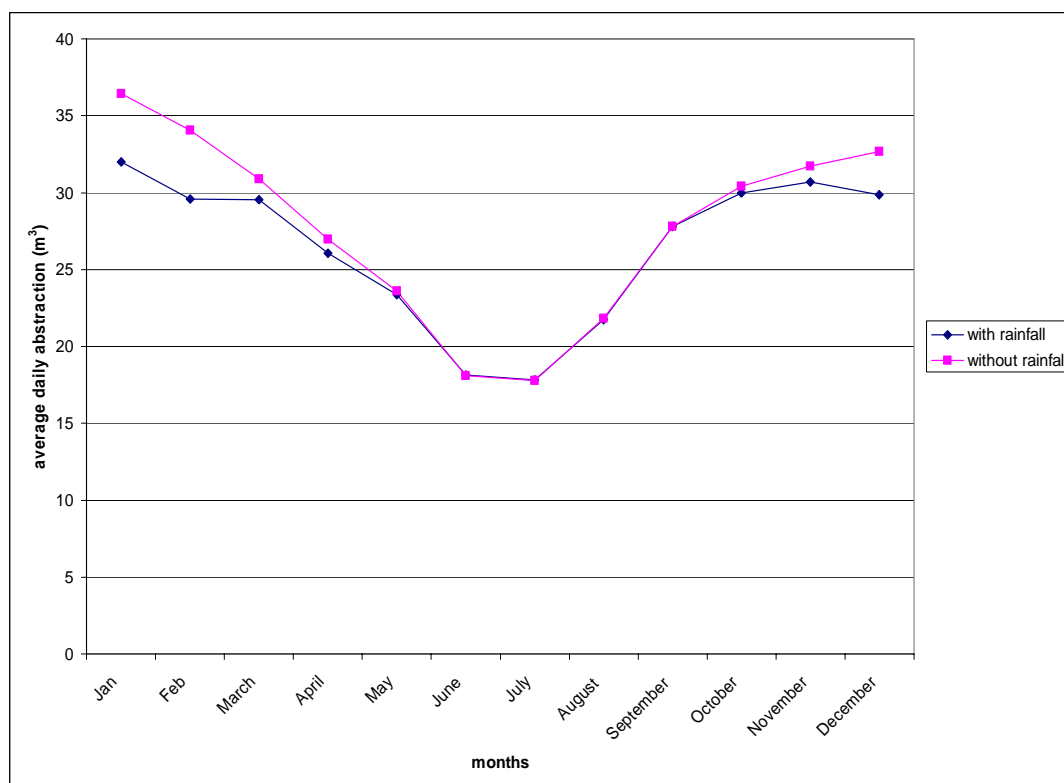

**Figure 9.9: Mean daily abstraction rates with and without pan water.**

Figure 9.10 depicts the maximum and average abstraction rates for each baseline year. Clearly, the maximum abstraction rates are consistent with the fluctuations in yearly demand as shown in Figure 9.3. Drought years have the highest maximum abstraction rates relative to the normal years while the wet years record the lowest maximum abstraction rates. This is a result of abnormally high temperatures that accompany drought years and negligible forage water content. Monthly maximum and average abstraction rate for the Khurutshe area is depicted in Figure 9.11 based on 45 000 cattle.

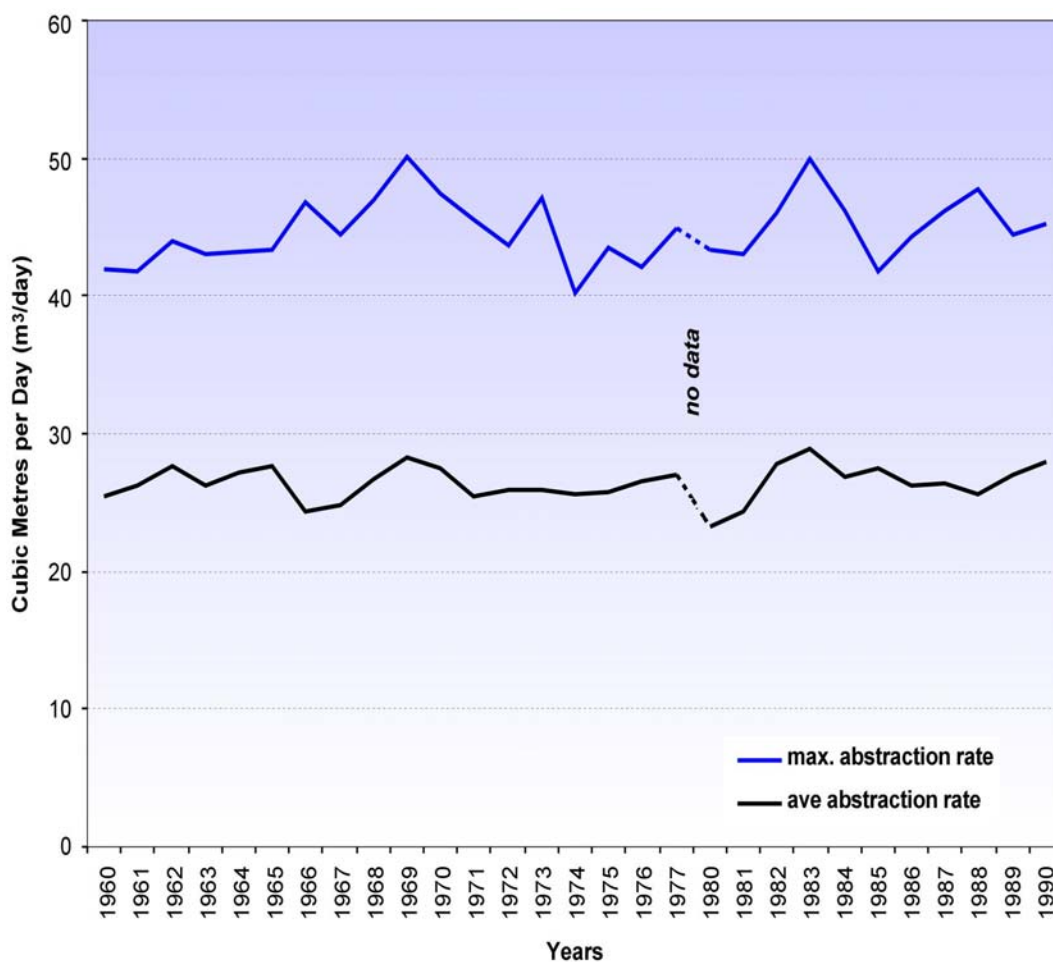

Figure 9.10: Max and average daily abstraction rate over the years for Masama Ranch

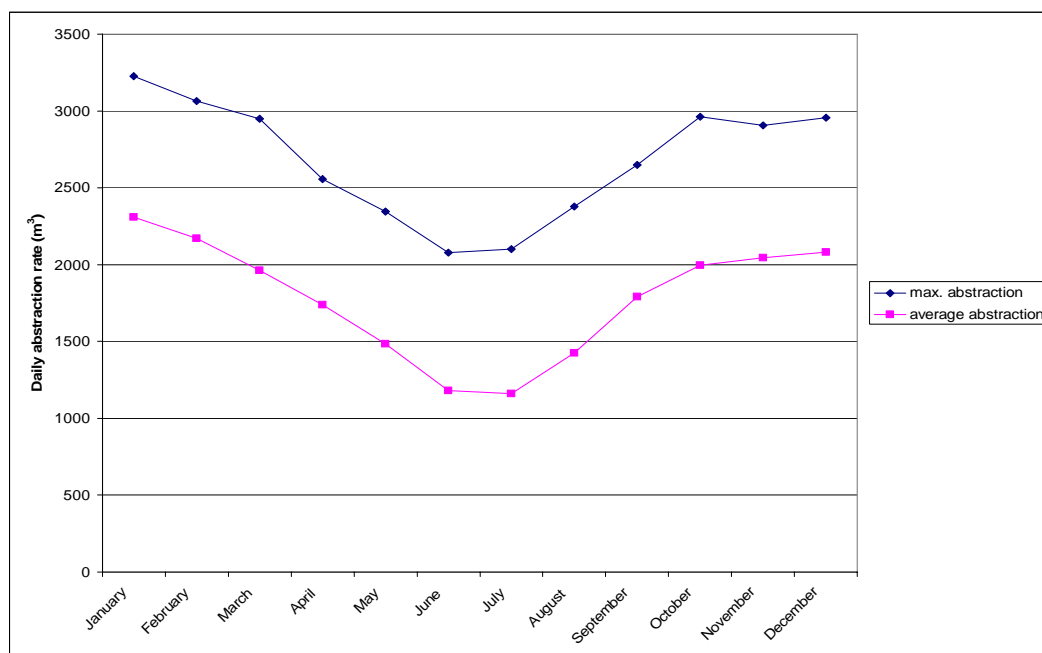

Figure 9.11: Daily abstraction rate in Khurutshe

One of the most important issues addressed in this study is the sustainability of current abstraction rates for the baseline period. As pointed out in other chapters, there are many sustainability indexes but I am using two, as proposed. First is the sustainability index based on the difference between recharge and abstraction rates. A negative signal indicates an unsustainable state while a positive index is sustainable. The second sustainability index uses a ratio of total groundwater available and the difference between recharge and abstraction rate, by Equation 9.1.

$$SI = \frac{TGA}{R - A} \quad \text{[Equation 9.1]}$$

Where,

SI is sustainability index ( $\text{m}^3$ );

TGA is the total groundwater available ( $\text{m}^3$ );

R is the recharge ( $\text{m}^3$ ); and,

A is the abstraction rate ( $\text{m}^3$ ).

The rationale for using (R-A) as the denominator is to take into account recharge, that is if A is used as the only denominator it assumes that recharge is zero which is not the case. Thus, this type of sustainability index measures the depletion period of groundwater, particularly if the denominator is negative. Using a recharge of 0.2mm per year for the Masama Ranch, Figure 9.12 shows the dynamics of the sustainability for the baseline period on a monthly basis. It is estimated as the difference between recharge and abstraction. Incidentally, summer months have abstraction rates that are higher than the daily recharge rate. Thus, during the summer months, groundwater abstraction is highly unsustainable. In fact, during the summer months, groundwater mining takes place at up to  $-8.7 \text{ m}^3$  per day with an average mining rate of  $-6.9 \text{ m}^3$  per day. However, a different scenario arises during the winter months where groundwater abstraction is sustainable. Instead of groundwater mining, there is a positive maximum recharge of  $5.7 \text{ m}^3$  per day during winter months. Disregarding seasonality, water abstraction in Masama Ranch is marginally unsustainable by  $-2.9 \text{ m}^3$  per day.

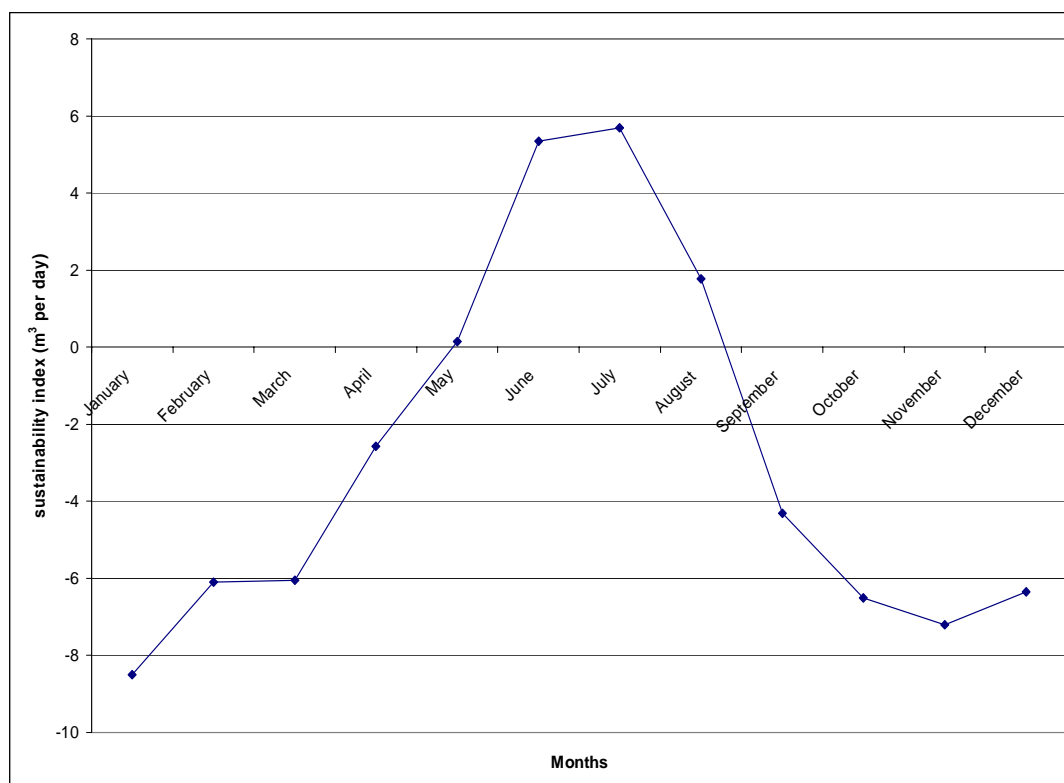
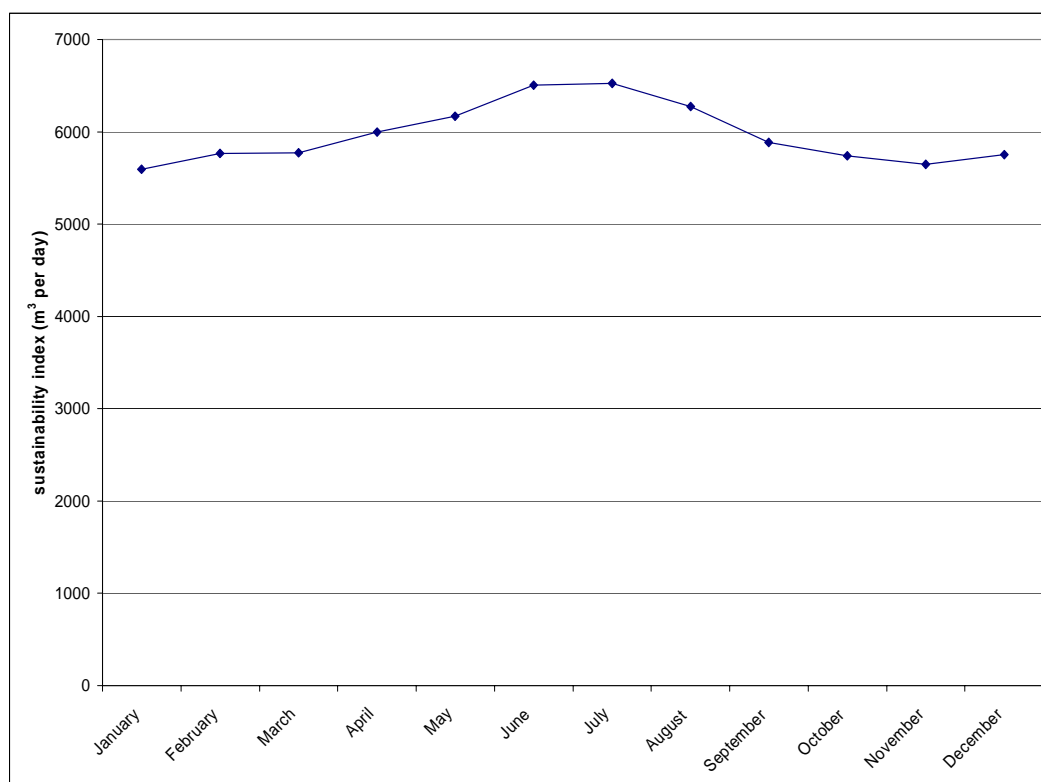

**Figure 9.12: Sustainability index for Masama Ranch for the baseline period.**

When the second measure of sustainability is used, (ratio between total groundwater and the recharge-abstraction rate difference) the sustainability for Masama Ranch is 185362 years. That is, it will take approximately 185362 years to deplete the groundwater beneath Masama Ranch under current conditions. Clearly, this can be perceived as sustainable. Results obtained can be interpreted as indicating localised depletion while at the large scale abstraction could be sustainable.

Estimating sustainability for the entire Khurutshe aquifer gives different results to those obtained for Masama Ranch. Due to the heterogeneity of the aquifer, a weighted area recharge of 1.6 mm per year is adopted for the entire aquifer as advised by GSC (1999). Figure 9.13 depicts the sustainability (difference between recharge and abstraction rates) for the Khurutshe area. In fact, cattle water abstraction is highly sustainable with a surplus of recharge of over 5000 m<sup>3</sup> per day. The average recharge of 1.6 mm per year as recommended by GCS (1999) is however highly questionable and raises skepticism for the following reasons. Firstly, it has been reported that water tables in the Khurutshe area are declining

by 0.61 m per year (Arntzen, *et al.*, 2003; DWA, 1994). Clearly, declining water tables are an indication that unsustainable groundwater mining is taking place (CSO, 2000; Custodio, 2000; Dottridge and Jaber, 1999). Secondly, farmers in the Khurutshe noted that during the summer period the borehole yield declined due to increased abstraction to meet increased demand. Lastly, it should be pointed out that the recommended recharge is the ideal recharge under normal rainfall conditions. However, the actual recharge will be different from the ideal. For instance, in drought years recharge will be less. The results obtained from the Masama Ranch and the Khurutshe area could indicate that groundwater abstraction is unsustainable at a local scale but generally sustainable at a large scale. This is in agreement with arguments by Calow *et al.*, (2002) that in Africa localised depletion is more likely to be the problem. However, depletion is not likely to occur at a larger scale as abstraction rates are lower than long term recharge rates (Calow *et al.*, 2002). Therefore, declining water tables could be a result of low transmissivity and therefore localised depletion and not for the entire aquifer. Still the effect of seasonality is distinct, in summer sustainability is 5590 m<sup>3</sup> per day while in winter it is 6525 m<sup>3</sup> per day.



**Figure 9.13: Sustainability for Khurutshe area for the baseline period.**



## **Cattle water demand and supply by the year 2050**

The section deals with projected water demand and water supply for the year 2050. Thus, this section entails the effect of climate change on water demand and supply. As noted besides cattle numbers and state of the cattle, climatic variables (temperature and rainfall) influence water demand and supply particularly in semi-arid environments (Bartholomew, 2004; Hoffman and Self, 1972; Mpotokwane, 1999; Oageng 1999; Parker *et al.*, 2000; Winchester and Morris, 1956). As pointed out, two GCMs are used: HadCM3 and CSIRO Mk2. To include the aspect of uncertainty, especially with regard to emissions, a range of scenarios that include the minimum, mean and maximum emissions are used: A1T, A1FT, and A1B. This section reinvestigates all aspects estimated under the baseline period for the year 2050. Thus, any change from the baseline period is attributable to climate change, specifically changes in rainfall and temperature.

### **Cattle water demand by 2050**

By the year 2050 water demand could be higher relative to the baseline period for the same number of cattle because of an increase in temperature. However, the projected water demand will vary with the type of emission scenarios used. The HadCM3 A1FT shows the highest water demand and it is followed by the HadCM3 A1T and lastly HadCM3 A1B (Figure 9.14). With the CSIRO Mk2 GCM projected water demands are also high but lower than those projected under the HadCM 3 GCM. Another interesting feature of the 2050 water demand is that winter months have substantially higher relative increases than summer months. HadCM3 and CSIRO Mk2 GCMs show that winter months will warm more than summer months. As temperature is a determinant of cattle water demand this explains a larger increase in water demand in winter over summer. Figure 9.14, and Figure 9.15 show monthly water demands and percentage change of water demand between the baseline and 2050 based on different emission scenarios for

Masama Ranch. The highest increase is with the HadCM3 A1FT emission scenario in June at 25.7%. In fact, all four winter months have increases greater than 20%. Incidentally, increases in water demand are a result of increased per capita demand. Consequently, average per capita consumption increases above the baseline by the same percentage as the increase in water demand. It is worthwhile to note that water demand depicted in Figure 9.14 is solely attributed to the increase in temperature and does not include rainfall, per se. This explains the constrained increase in demand under the CSIRO Mk2 model compared to the HadCM3's as CSIRO Mk2 projects a lower increase in temperature. All the models are in agreement; there could be an increase in water demand by the year 2050. These increases of 10% and 25% in summer and winter respectively, in water demand by 2050 also apply to the whole of the Khurutshe area. It should be noted that 10%-25% are from the most extreme scenarios. The other extreme scenarios give an increase of just 3%-11%. Figure 9.16 below shows water demand for cattle in the Khurutshe from the baseline period up to 2050. Thus over time water demand will increase as a result of increases in temperature.

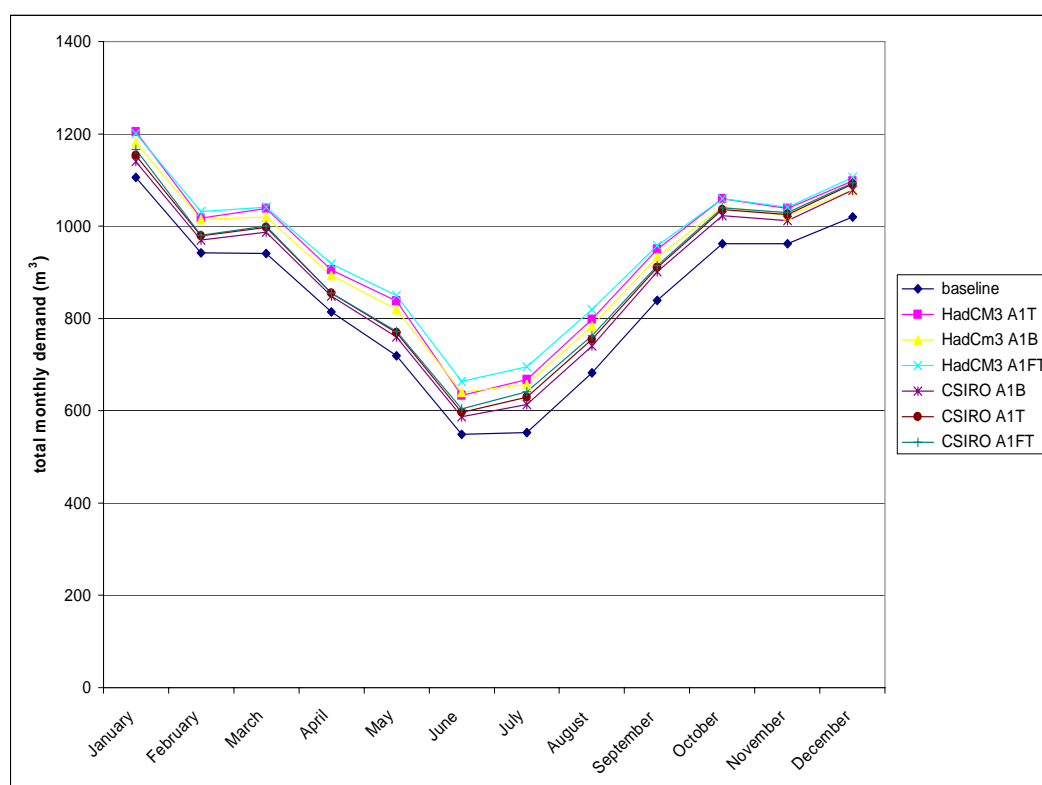

**Figure 9.14: Water demand by 2050 based on different emission scenario for Masama Ranch.**

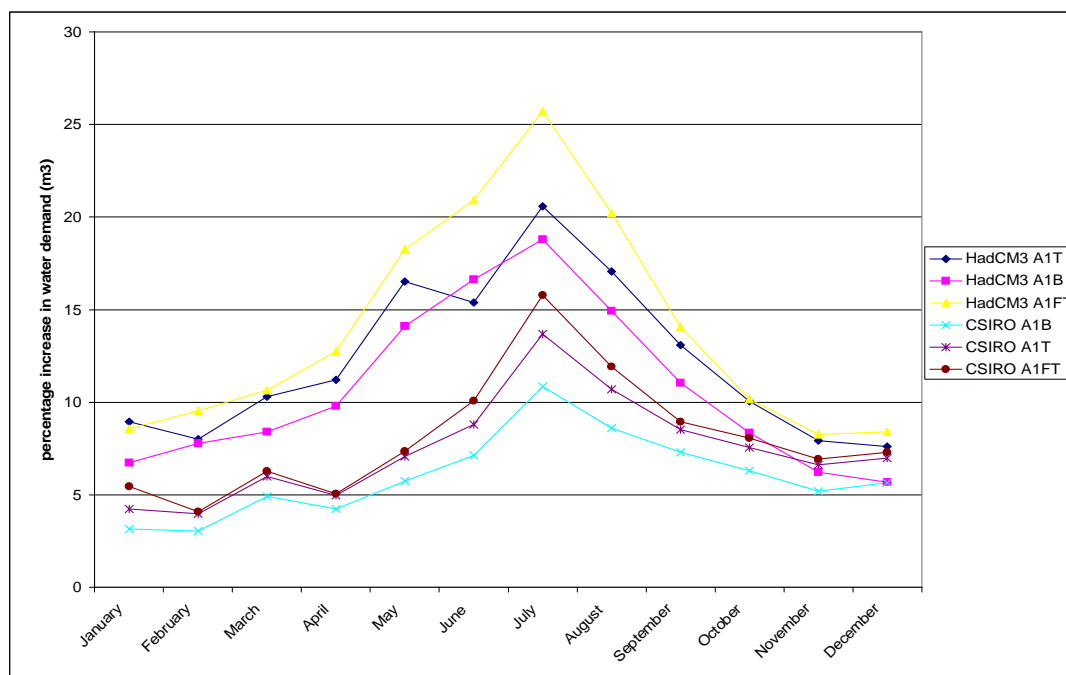

**Figure 9.15: Changes in water demand between 2050 and baseline period for Masama Ranch.**

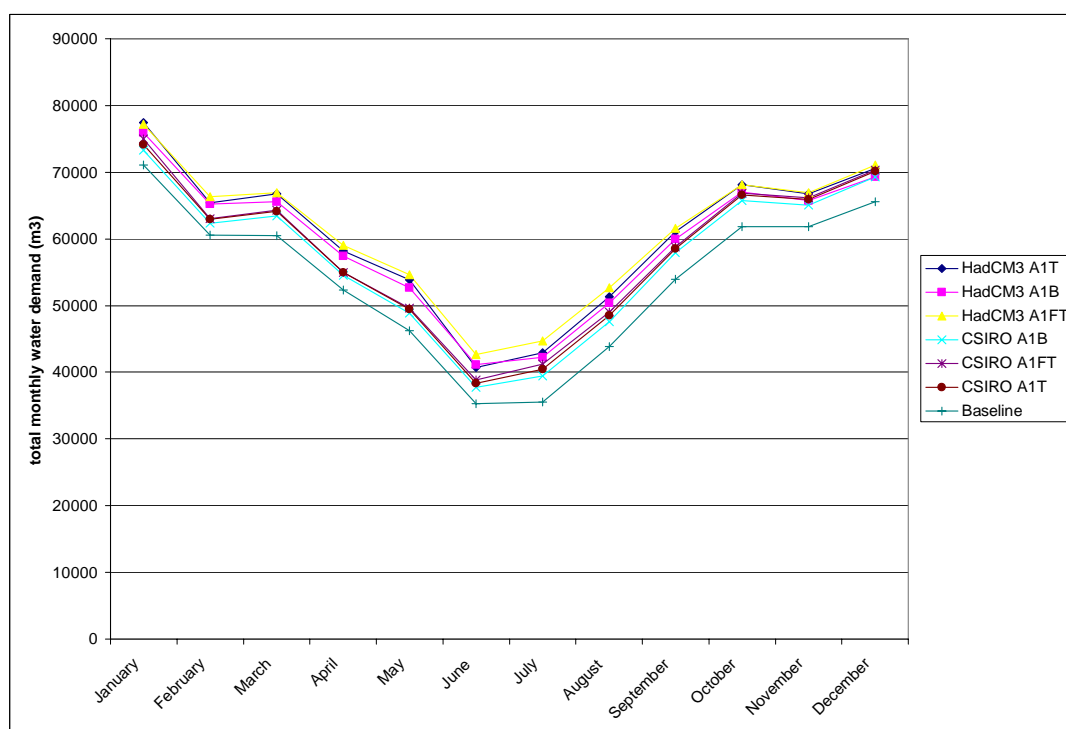
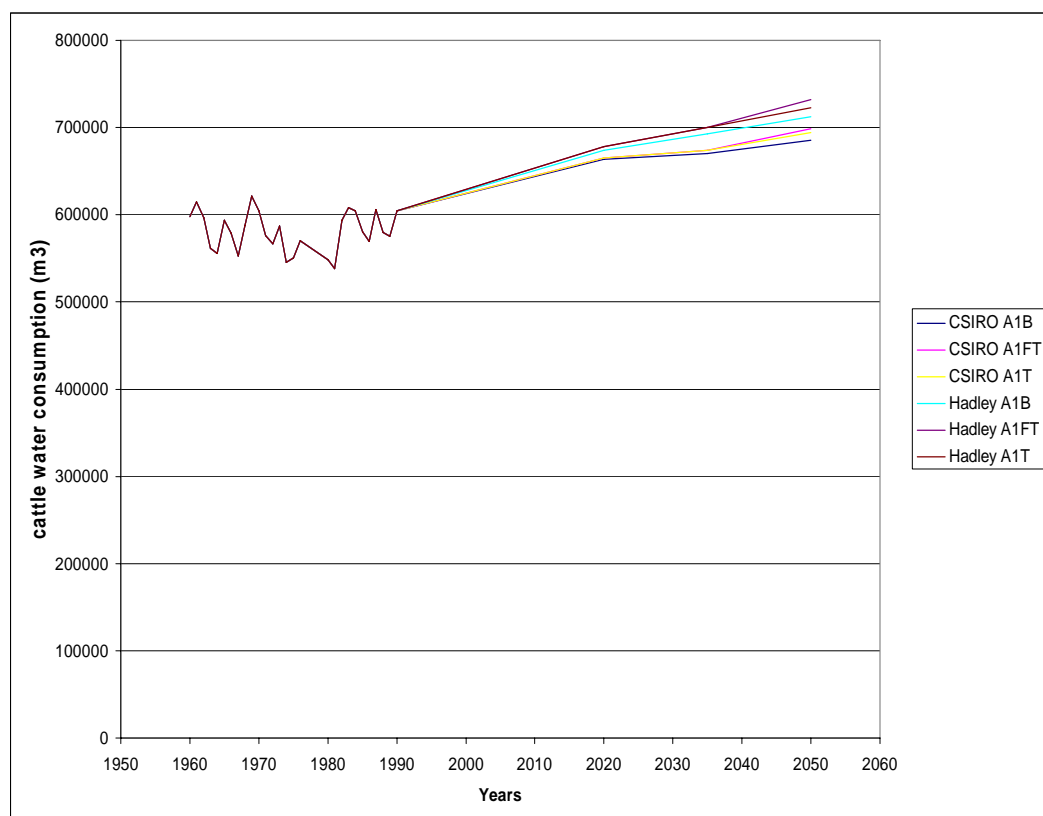

**Figure 9.16: Total monthly water demand for Khurutshe area for baseline and 2050**

Figure 9.17 depicts a growth in water demand over time. However, it is expected that some years will have drought and therefore the demand will be higher than projected in Figure 9.17. Table 9-3 below shows changes in water demand between the baseline and 2050 using the baseline average as the reference point in time.

**Table 9-3: increase in water demand by 2050 for Masama ranch**

GCM	SRES emission scenario	% increase
SIRO Mk2	A1B	17.9
	A1FT	20.18
	A1T	19.44
HadCM3	A1B	22.62
	A1FT	26.01
	A1T	24.4



**Figure 9.17: Water demand over time for Masama ranch**

### **Contribution of surface water supply to water demand by 2050**

The contribution of surface water could be affected by climate change as a result of a decline in precipitation and an increase of evaporation due to high

temperature by 2050. However, as pointed out earlier, it is doubtful if changes in the contribution of surface water will have any impact. The highest contribution under the baseline period was 12.7% and during the winter seasons the contribution of pan water was zero (Figure 9.4).

Figure 9.18 depicts percentage declines of contribution of pan water to cattle demand in 2050. By 2050, the contribution of pan water may decline by a maximum of 4.5% (contribution of pan water in February by 2050 will be 8.6% from 12.7% of the baseline contribution) while winter months will remain zero. A decline in the contribution of pan water results from a decline in precipitation. Unlike water demand, where the HadCM 3 GCM projected the highest increase in water demand, in this case, it is the CSIRO Mk2 GCM that projects a major decline in the contribution of surface water to water consumption (4.5%). However, the commonality is that the highest decline is associated with the A1FT emission scenario. Thus, the lowest decline in the contribution of surface water to cattle water demand is projected by the HadCM 3 GCM. January is the only month which the HadCM 3 projects to have an increase in contribution of pan water to cattle water supply. This is owing to the fact that HadCM 3 projects an increase in rainfall by 2050. Intuitively, the decline has to be compensated for by an increase in supply from borehole groundwater supply.

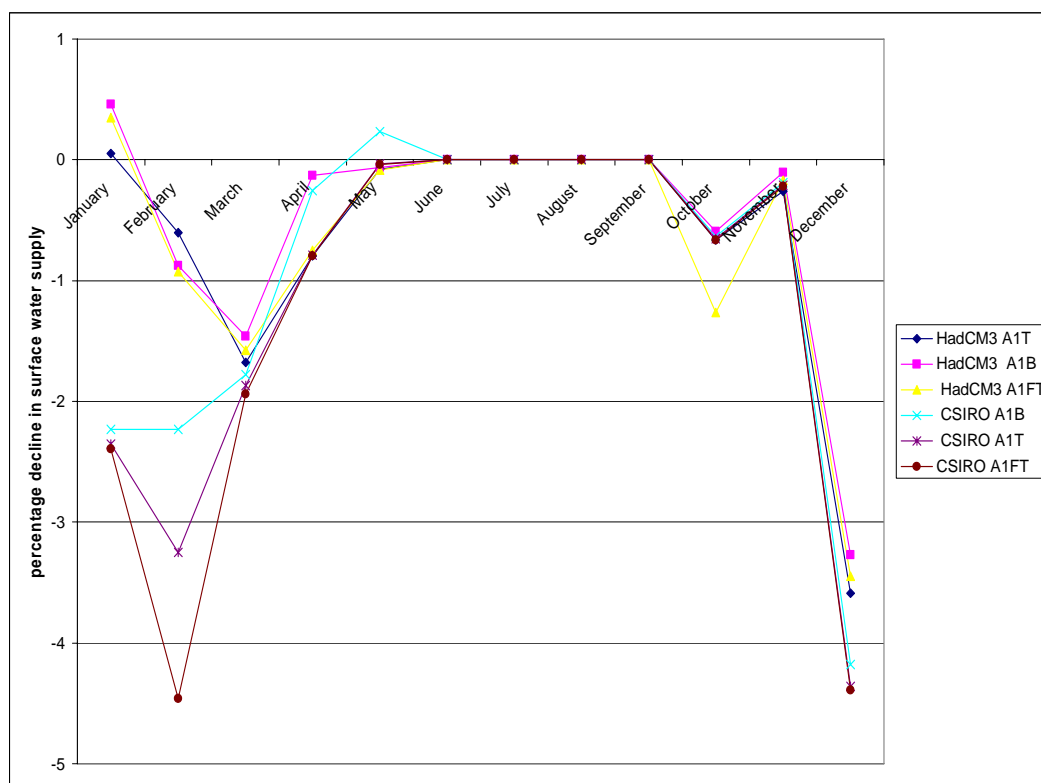
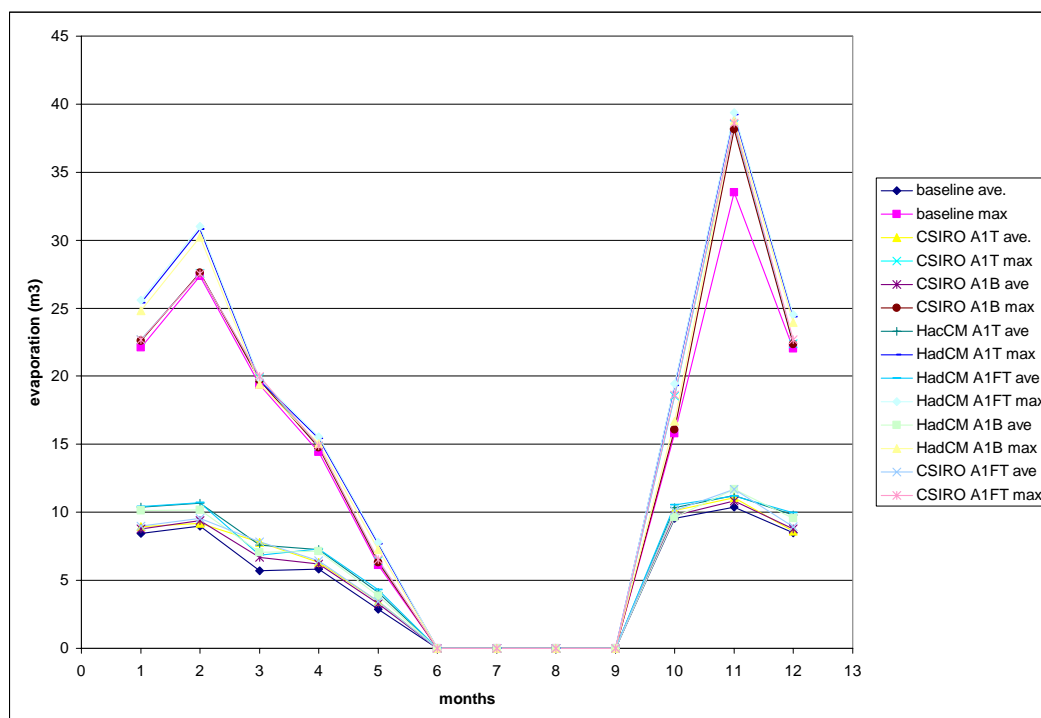

Figure 9.18: Percentage decline in supply of surface pan water to cattle water demand

### The impacts of climate change on evaporation rates by 2050

Evaporation might be affected by climate change through increases in temperature as indicated by the GCMs. Increases in temperature might increase evaporation rates from the pans. Using HadCM3 and CSIRO mk2 and SRES emission scenarios, the results indicate that by 2050, evaporation rates will increase by a high of 3 m<sup>3</sup> and 2 m<sup>3</sup> for maximum and average daily evaporation rates respectively, Figure 9.19. These results depend on the GCMs and SRES emission scenarios used. The HadCM3 A1FT shows a maximum increase while CSIRO shows a very small change in evaporation rates. This implication of this finding is that in addition to a decline in rainfall, water in the pans will be lost through an increase in evaporation rates.

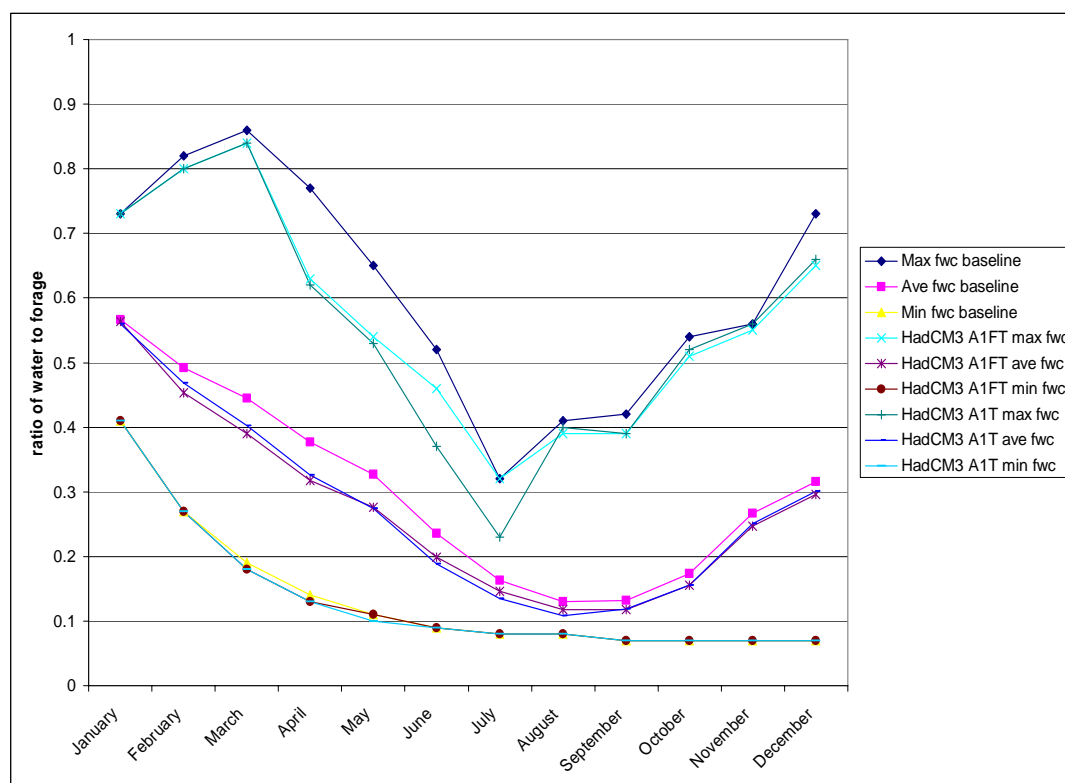

**Figure 9.19: Evaporation rates for the baseline and 2050 based on GCMs and SRES emission Scenarios**

### Forage water content for cattle water supply by 2050

Forage water content will be affected by climate change. It will be affected through increases in temperature and evapotranspiration. Increases in transpiration will affect ASW for forage thus, it is anticipated that forage will not be able to retain maximum forage water for the same period of time relative to the baseline period. Secondly, the impacts of climate change on forage water content will be through precipitation. Declines in precipitation will have an effect on ASW for forage and hence changes in values of forage water content compared to the baseline period. Thus, the amount of water derived from forage through ingestion will decline with increases in temperature and decline in rainfall. Figure 9.20 depicts the ratio of water in forage for the baseline and 2050 using HadCM3 and A1FT and A1T emission scenario. A1FT and A1T emission scenarios are shown here together instead of A1FT only because unlike in other variables where A1FT shows extreme value, it is A1T emission that shows the extreme values changes for forage water content. The values for other GCM and emission scenarios are between baseline and HadCM3 A1T. The reason for the A1T emission scenario showing higher values than A1FT is because, the A1FT projects a lower decline

in precipitation by 2050 hence its ASW falls at a lower rate compared to other emission scenarios. As forage water is a function of soil water it means forage water will decline at a lower rate. Both GCMs and all the emission scenarios show that by 2050 the ratio of water to forage could decline relative to the baseline period. Basically, cattle will be, in relative terms consuming drier forage. This will have an impact on the water demand from other sources.



**Figure 9.20: Forage water content for the baseline and 2050 using HadCM3 A1FT and A1T emission scenarios**

As has been implied earlier, there are a number of factors responsible for a decline in forage water content. Firstly, increases in temperature result in increased transpiration and therefore water loss from the soil is accelerated compared to the baseline period. Thus, forage is not able to retain water up to the maximum level due to the deficiency in ASW. Secondly, declines in precipitation affect the ASW quantities such that in the future, forage could transpire more than it draws water from the soil. The only changes from the forage water content are the maximum forage water content and average water content with no change on the minimum forage water content. It is difficult to explain a no change on the minimum forage water content in future. The only plausible explanation could be that minimum soil water is not affected by the changes. Figure 9.21 shows the percentage decline



for the ratio of water in forage by 2050. These changes in forage water content will affect cattle water demand and supply.

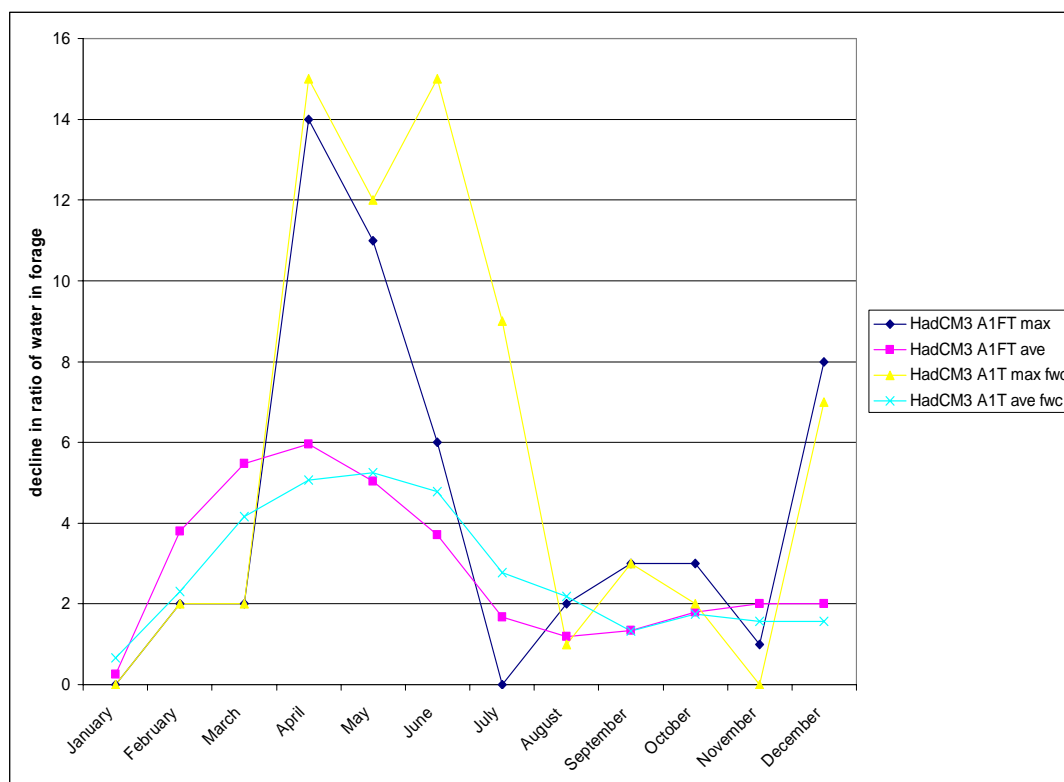

Figure 9.21: Change in ratio of water in forage between baseline and 2050

### Abstract rates of groundwater and sustainability by 2050

By the year 2050 abstraction of groundwater could increase by more than the increase in demand. This is because of declines in pan water due to decline rainfall, increase in evaporation and and the decline in water obtained from forage. However, the majority of change will be driven by temperature as the contribution of surface water to satisfy water demand is small. In addition, the changes and contribution of forage water content is also insignificant. Figure 9.22 and Figure 9.23 depict abstraction rates for Masama and Khurutshe to satisfy cattle demand for the baseline period and 2050. As noted in the introduction, only HadCM3 A1FT values are reported to enhance readability of the graph. Values of other GCM and emission scenarios can be visualised as in between the baseline and HadCM3 A1FT.

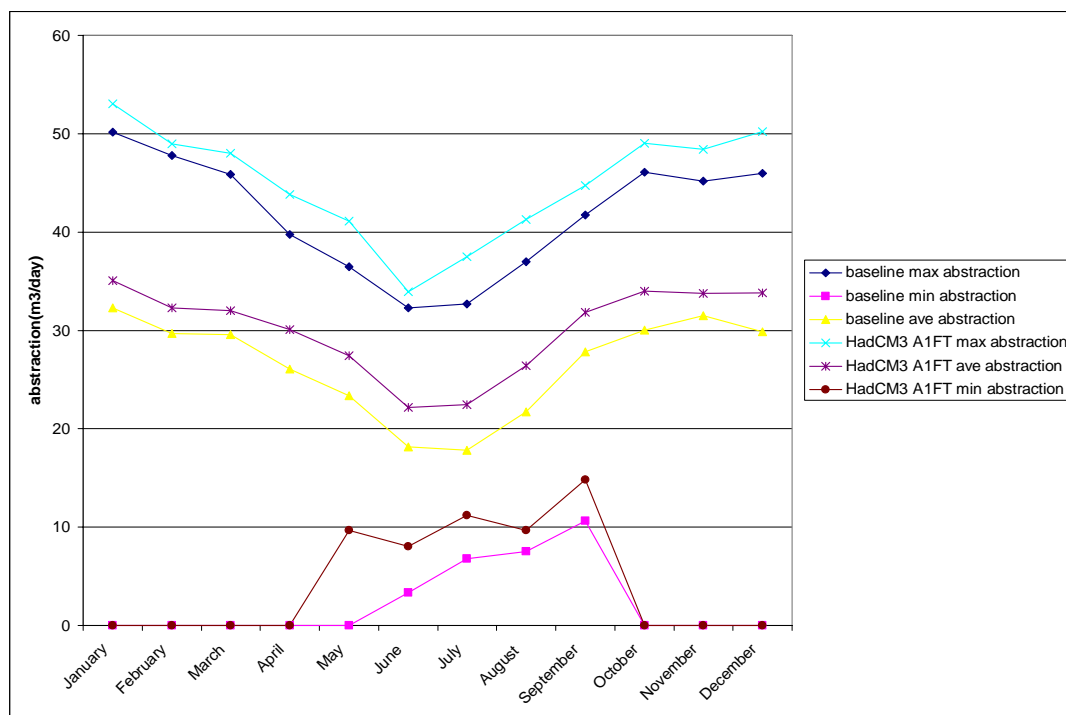

Figure 9.22: Daily abstraction rates for baseline and 2050 for Masama Ranch.

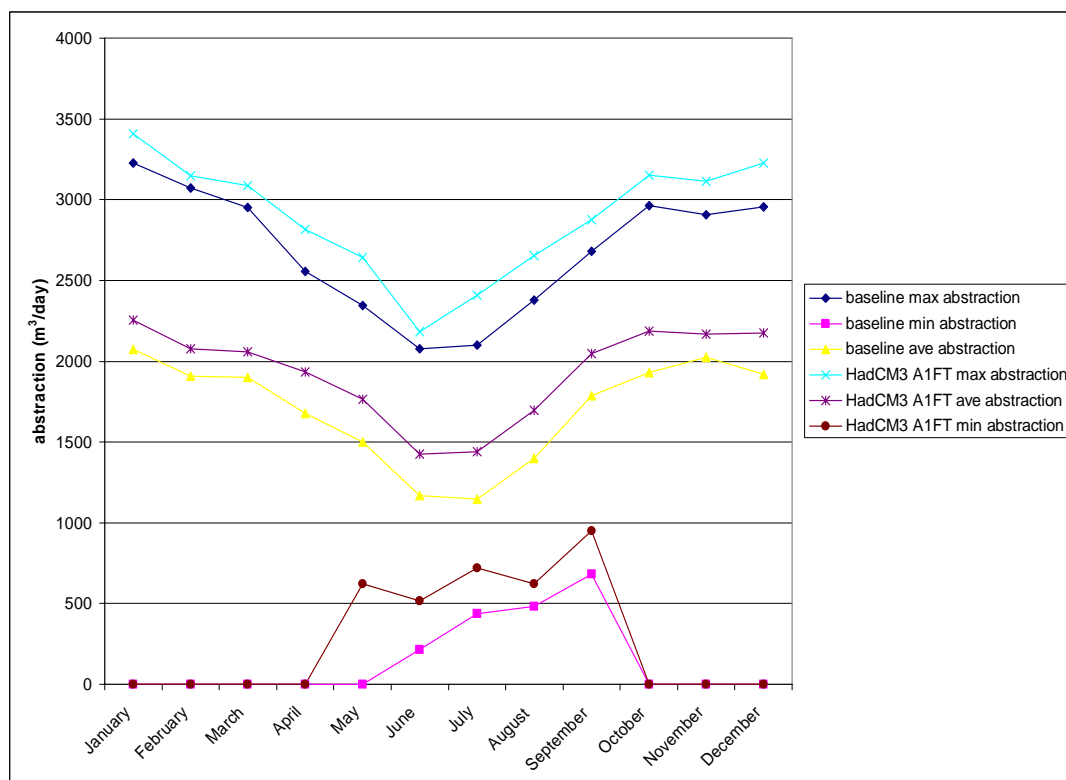
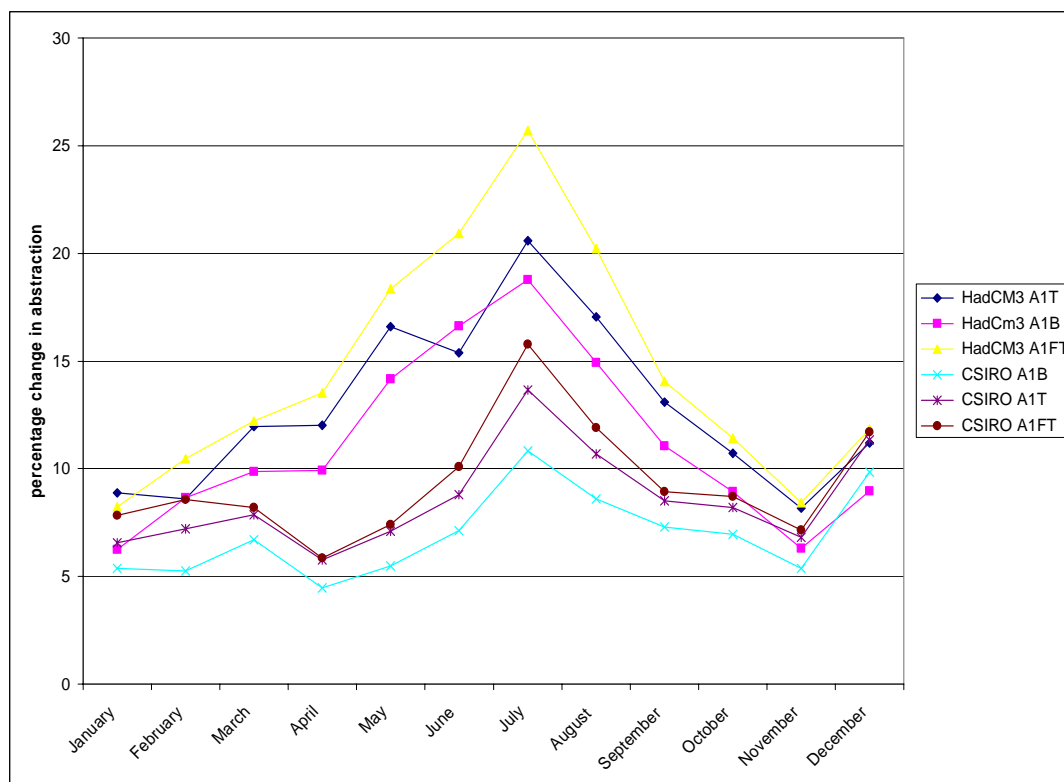

Figure 9.23: Daily abstraction rate for Khurutshe area.

The percentage increase in abstraction rate is more than the increase in water demand as shown in Figure 9.24. The increase in abstraction is more in summer while in winter it is identical to the increase in demand. This is because of the effects of pan water and forage water content.



**Figure 9.24: Changes in abstraction rate of groundwater**

### Groundwater sustainability by 2050

During the baseline period groundwater abstraction was marginally unsustainable for Masama Ranch at  $-2.9 \text{ m}^3$  per day while for Khurutshe, groundwater abstraction was sustainable. Thus, localised depletion may be the problem while at the large scale there is no problem of depletion. The results indicate that in summer, demand peaks and local depletion intensifies. By 2050 local depletion will intensify owing to increased water demand. Figure 9.25 shows the sustainability index for the Masama Ranch for the baseline and 2050. The number of months where groundwater abstraction was sustainable falls from four to only two (June and July). Furthermore, the unsustainability of groundwater abstraction

intensifies from  $-2.9 \text{ m}^3$  per day to  $-6.5 \text{ m}^3$  per day by 2050 based on HadCM3 A1FT, which shows an extreme value. Table 9-4 shows the annual sustainability index for groundwater between the baseline and 2050 estimated as the difference between annual abstraction and recharge. The results clearly indicate that unsustainable use of groundwater will worsen for the Masama ranch as a result of climate change. Thus, climate change could pose a challenge for water resource managers, especially groundwater management particularly at the local water points where local depletion is likely going to occur. On the other hand, Figure 9.26 depicts the sustainability index for the Khurutshe area using the mean  $1.6 \text{ mm}$  per year recharge rate. This index shows that groundwater utilisation for the cattle sector is sustainable. Thus, at the large scale, climate change may not affect sustainability of groundwater abstraction, particularly for the cattle sector. The results obtained for Khurutshe are in line with results from other studies (Calow *et al.*, 2000). They noted that regional depletion of an aquifer is not a likely problem in African semi-arid environment as abstraction rates do not usually exceed long term aquifer recharge. Localised depletion of groundwater is a result of low transmissivity which results in water being replaced at a lower rate than it is pumped out (Calow *et al.*, 2002). Thus, the decline of water tables by  $0.61 \text{ m}$  in Khurutshe area could just be localised depletion. Thus, with climate change and increased water demand, the rate of decline of the water table in the Khurutshe could accelerate.

**Table 9-4: Annual sustainability for groundwater abstraction in  $\text{m}^3$**

	Baseline	CSIRO A1T	HadCM3 A1T	CSIRO A1B	HadCM3 A1B	HadCM3 A1FT	CSIRO A1FT
Annual sustainability	-1062.95	-1869.78	-2243.31	-1718.01	-2010.69	-2393.03	-1944.33

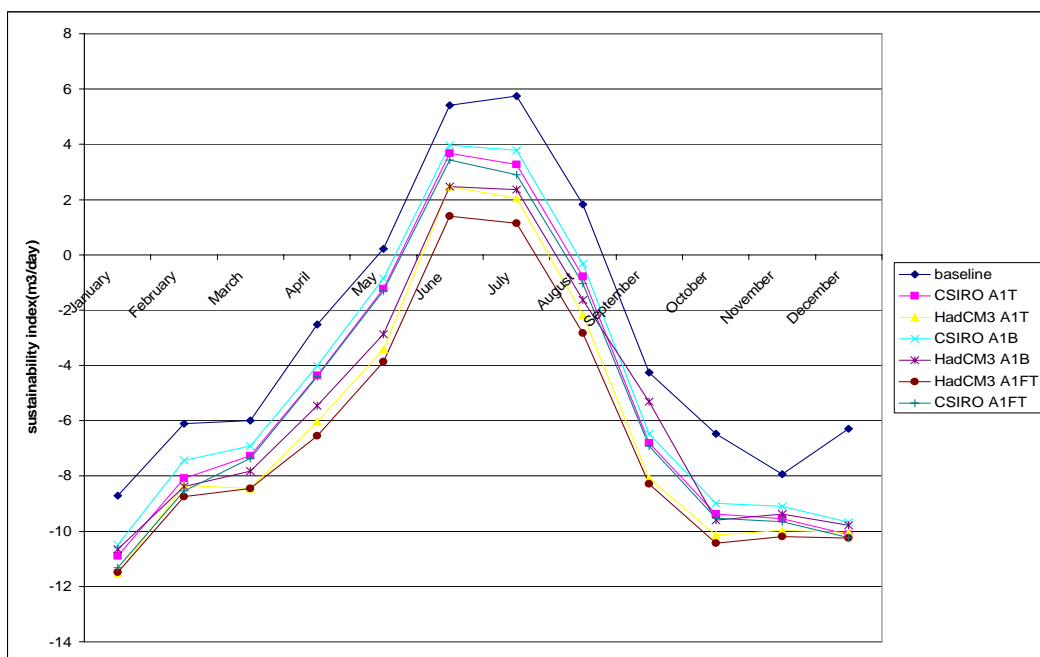

Figure 9.25: Groundwater sustainability for Masama Ranch

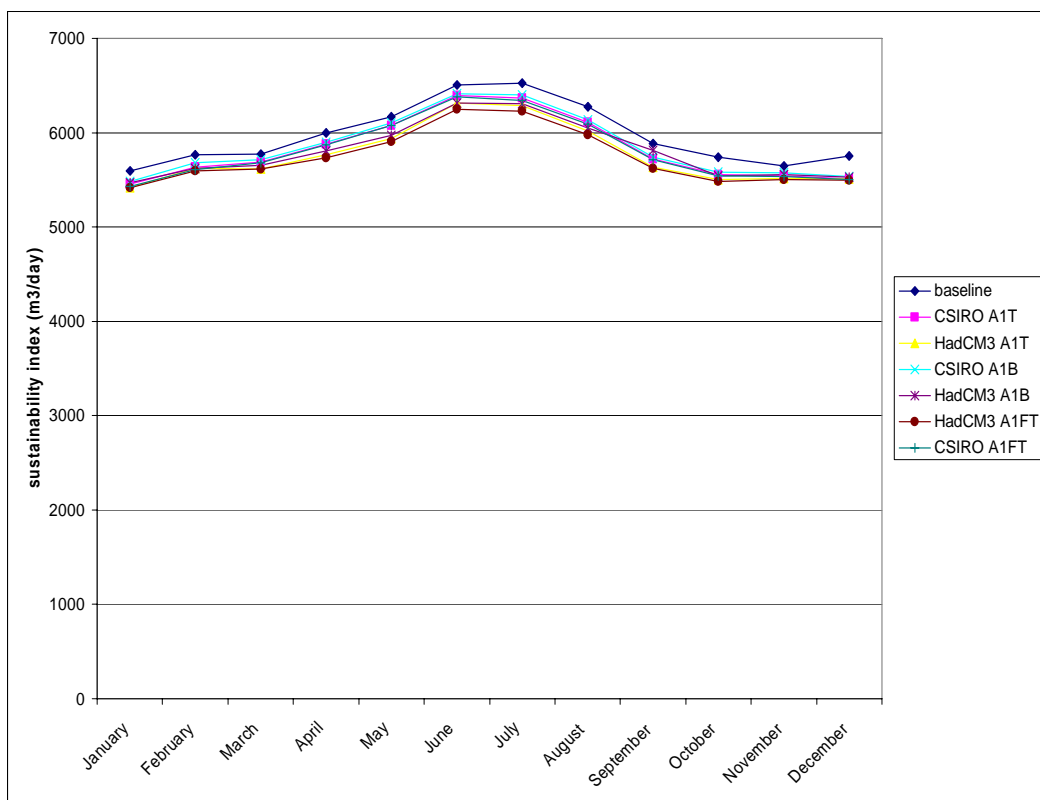

Figure 9.26: Groundwater sustainability for Khurutshe area

Using the recharge of 1.6mm per year, Table 9-5 shows cattle water demand as a percentage of recharge on a monthly basis for the Khurutshe area.

**Table 9-5: cattle water abstraction as a percentage of recharge**

GCM	Emission scenario	Percentage of monthly recharge	
		Summer	Winter
Baseline	1990	24.8	16.9
HadCM3	A1B	26.69	19.67
	A1FT	29.23	21.35
	A1T	27.53	20.61
CSIRO Mk2	A1B	26.35	18.36
	A1FT	26.86	18.9
	A1T	26.7	18.7

## Discussion of the findings

Though the link between climate change and water demand has been assumed to be insignificant (IPCC, 2001) and therefore research in the area has been neglected, the findings from this study are that climate change could significantly affect water demand and supply for cattle. Water demand for cattle will be affected by increases in temperature. In addition, climate change will affect demand through forage water content. As temperatures increase and rainfall declines, forage water content will be negatively affected. This will lead to a decline in cattle involuntary water intake which will lead to an increase in water demand from boreholes (voluntary water intake). Water supply for cattle will be affected by climate change in two ways. Firstly, a decline in rainfall as indicated by the GCMs will affect quantity of surface water supply available to cattle. Secondly, climate change might lead to an increase in daily evaporation rates for surface water resources. The implication of this impact is that the already reduced surface water (due to decline in rainfall) will further be reduced by an increase in evaporation rates. In addition, though not assessed in this study is the fact that climate change through decline in rainfall and an increase in evapotranspiration, may also affect recharge rates of groundwater, leading to increase local depletion, particularly in summer. The combined effect of climate change on cattle water resources is to wedge the gap between increasing demand and declining supply (by increasing demand and decreasing surface water for cattle).

HadCM3 and CSIRO Mk2 GCMs are in agreement that by 2050 temperature could be higher relative to the baseline period. In addition, these two GCMs

project that by 2050, rainfall will be lower than the baseline period in the researched area. Thus, the discussion on the effect of climate change on water demand and water supply is based on these changes. Overall, there will be an annual increase in water demand of over 20% depending on the type of GCM and SRES scenarios used and this will be completely from increases in temperatures. It should be pointed out that these findings apply where farmers do not control the number of days their cattle drink.

Overall, water demand by 2050 could increase but this varies with the seasons. Results from the two GCMs used and the SRES emission scenarios are all in agreement that winter months will experience substantial percentage increases in water demand relative to summer months. This is because the highest changes in temperature are experienced in winter. As winters become milder cattle could drink on a daily basis instead of the baseline water consumption behaviour where they drink either every second day or daily consumption. Baseline consumption is characterised by distinct fluctuations of high consumption followed by a very low consumption. This not only applies to the winter seasons but also to the summer season. The consumption behaviour characterised by distinct fluctuations in the summer season will also be replaced by high consumption on consecutively days as temperatures increase.

The second impact of climate change is through rainfall. Rainfall will mostly affect surface water supply for cattle though it might have effects on daily temperatures. Climate change could affect the quantity of pan water and therefore water available to cattle. These impacts on surface water supply are through decreases in rainfall and increases in evaporation rates. By 2050, the contribution of pan water to monthly water demand will decline by a maximum of 4.5% for the rainy season with no change for the winter. The implication of this is that farmers will increase extraction from the boreholes by 4.5% to meet demand. Thus, above the increase in water demand of 10% as a result of increase in temperature in summer, farmers will have to increase supply by a further 4.5% as a result of a decline in the contribution of pan water. Rainfall also directly impacts water demand through forage water content. Decline in rainfall will have an effect on forage water content which in turn will have an effect on daily water demand.

Increases in demand and decline in surface water will result in changes in abstraction rates of groundwater for cattle. Increases in abstraction rates to meet increase in demand and also to compensate for the decline in pan water (decreases in rainfall and an increase in evaporation rates) will have an effect on the sustainability of groundwater. While in winter months demand has been relatively low and therefore abstraction rates are sustainable, the results indicate that by 2050 some winter months will also become unsustainable. Therefore sustainability index increases from  $-2.9 \text{ m}^3$  per day to  $-6.5 \text{ m}^3$  per day. Hence, the magnitude of unsustainable state increases due to increases in temperature and decreases in rainfall (which affect pan water supply and forage water content). Unsustainability of groundwater occurs to the Masama Ranch only where groundwater recharge is low due to the presence of basalts. At the larger scale, which is for the Khurutshe area, the results indicate that groundwater utilisation is sustainable.

There is a general agreement that groundwater utilisation is unsustainable in Botswana. For instance, Kgathi (1998) argued that groundwater utilisation is 760 times higher than the recharge and therefore highly unsustainable. However, in most cases this perception is based on the assumptions that recharge rates in the country are zero. The results from this study indicate that groundwater utilisation is only unsustainable for Masama Ranch, while for the whole aquifer, groundwater is sustainable. Based on the results from this study especially from abstraction rates to meet demand, the following conclusions can be drawn for a 8 km radius borehole (the requirement that boreholes in the country should be 8 km apart). As long as the recharge rate is greater than 0.5 mm per year for 1000 cattle then groundwater utilisation to meet the demand will be sustainable. However, it is concluded that groundwater in the Khurutshe area may be sustainable, the observation of declining water tables indicate the contrary. And if the recharge rate is lower than 0.5 mm, which is true for some parts of the country, then groundwater utilisation for cattle will be unsustainable.

Measuring sustainability of groundwater in semi-arid environments is not an easy task. One of the factors that makes it difficult is measuring groundwater recharge.



For instance, there is an ongoing debate whether groundwater recharge is actually occurring in the sandveldt part of the country given high evapotranspiration rates and thick Kalahari sands (Gieske, 1992; Selaolo, 1998). In addition, sustainability is a devious term which encompasses social-economic and environmental issues, making it difficult to achieve. However, based on the safe yield concept, and using a recharge rate of 1.6 mm per year, the cattle sector is only using 20% of recharge, which is sustainable. Thus, from the findings of this study, climate change may not pose major problems at the large scale but could be highly significant at a local scale from local depletion. For instance, farmers in Kgatleng District, particularly on the eastern part of the District, and other parts of semi-arid environments of Africa, have a water scarcity problem. In summer, farmers generally limit the number of times their cattle drink to try and conserve the limited water supply. While in winter, farmers do not have the same problem as demand declines. However, from the findings, it is clear that by 2050 a substantial increase in temperature, especially in winter may increase water demand by up to 20%. Thus, declining borehole yield could also be experienced in winter.

To put the findings of this study into perspective, discussion should be made in reference to the other projected impacts on water resources arising from socio-economic factors. Delgado *et al.*, (1999) projects future increases in consumption of meat and milk in developing countries of 2.8 and 3.3 percent per year, respectively. Steinfeld *et al.*, (2006) on the other hand indicate a more than doubling in the growth rate in consumption of meat and milk from 229 million tonnes in 1999/01 to 456 million tonnes in 2050 and 580 to 1043 million, tonnes respectively. Factors that will be responsible for increases in consumption of meat and milk are growing human population and incomes, particularly China and India (Delgado *et al.*, 1999, Steinfeld *et al.*, 2006). According to them, as production generally follows consumption patterns it means that there will be an increase in the number of animals. As there is a positive relationship between total water demand and number of cattle, it means that there will be an increase in water demand. This increase, as projected, is likely going to dwarf the increase in cattle water demand arising from the influence of climate change.

Secondly, changes in management and composition of feed are going to affect cattle water demand patterns (Stenfeld *et al.*, 2006). They noted that though extensive grazing is still practised, there is a shift towards intensified use of feed and concentrates. Steinfeld *et al.*, (2006:45) highlights that “livestock production is projected to increase and with it the demand for feed”. It is estimated that animal feeds will grow at rates of between 1.6 to 1.9% annually and the actual growth will be close to one billion tonnes between 1997/99 to 2030 (Steinfeld *et al.*, 2006). Animal feeds require substantial amounts of water to grow. It is noted that the majority of the water used in livestock goes into feed production (Donkor and Wolder, undated; Stenfeld *et al.*, 2006). As a consequence of projected increased animal feeding, it is projected that there will be a substantial increase in demand for irrigation in sub-Saharan Africa of 27% by 2025 (Steinfeld, *et al.*, 2006). Overall, it is projected that there will be a 22% increase in global water withdrawals driven by domestic, industrial and livestock use.

Thus, an increase in livestock water demand from changes in the number of cattle due to income and human population growth may be more than the projected impacts of climate change on cattle water demand. However, it is important to note that the increase in cattle water demand as a result of climate change will be an additional strain in an already water scarce situation. Thus, climate change may amplify the effects of an increase in livestock production and production of feed leading to future water scarcity. As noted, future water demands for domestic and industrial use will also increase due to increases in population, incomes and industrial growth. Thus, the findings of this study, combined with projected increases in livestock numbers have enormous implications for future water resources and their management.

## The importance of groundwater in Botswana and abstraction management options

Groundwater is an important resource for semi-arid countries such as Botswana which have limited surface water supplies. The advantages of groundwater have been noted: it is an abundant water resource especially in semi-arid countries which have scarce surface water supplies; cheaply available, unlike surface water where the expense of construction of dams is incurred; and lastly, it is generally clean, not highly vulnerable to pollution and evaporation (Beier, 2004; Todd, 1980; Tuinhof *et al.*, 2003).

In the future, the importance of groundwater as source of urban water supply may intensify as surface water becomes scarce due to declining rainfall. Therefore, prudent groundwater management will be paramount. It is evident that with climate change there could be a dispute<sup>34</sup> over the use of surface water, especially trans-boundary or international rivers, as water scarcity takes its toll particularly for semi-arid, southern African countries. Thus these countries should focus on the long term sustainability of groundwater. Countries which are reliant on surface runoff into dams will be heavily affected by climate change (declines in rainfall and increased evapo-transpiration) and there is the distinct possibility that they will need to switch from dam supply to a groundwater supply. In fact, the eastern part of Botswana has reached a point where sites for dam construction are exhausted while urban water demand continues to grow. The only option left is to tap into the groundwater resource for urban water supply. As noted, wellfields have been developed in the Khurutshe aquifers and are connected to the NSWC pipeline to supply Gaborone during drought years when the Gaborone, Bokaa and Letsibogo dam cannot meet demand. The drought year of 2005 saw the operation of the NSWC to meet the demand of Gaborone. Thus, the importance of groundwater, especially in the Khurutshe cannot be over-emphasised as an adaptation strategy against the impacts of climate change on urban water supply. Given the importance of groundwater, its current and future utilisation must be managed in a sustainable manner if it is to be used as an effective adaptation strategy.

---

<sup>34</sup> e.g., Botswana and Namibia had conflict over the extraction of water from the Okavango river which Botswana appealed to the international community and won.

## **Groundwater abstraction management for cattle water demand**

Current groundwater abstraction rates in the Masama ranch are unsustainable. However, this phenomenon is likely to intensify by 2050 as a result of climate change. But management strategies could shift the regime from an unsustainable state to a sustainable one for cattle water demand. This needs to be done for two reasons: firstly, so that when the need arises, groundwater resources can be used as an adaptation strategy for climate change; and, secondly, to use groundwater into perpetuity for cattle raising. The dilemma is that the impacts of climate change on abstraction regimes for groundwater will probably lead to more unsustainable use in the future. At the same time, there might be a need for the groundwater to be used as an adaptation strategy to climate change for urban water supply. There are two measures that can be implemented to enhance current sustainability of groundwater abstraction in the Khurutshe area: controlling stocking rates depending on demand, and, tradable pumping permits. These management options can be applied to achieve sustainability at local (individual boreholes such as Masama Ranch) and large scale (Khurutshe area).

### **Controlling stocking rates**

To solve the problem of local depletion which is generally localised as noted by Calow *et al.*, (2002) farmers can control the stocking rates depending on the season. Stocking can be controlled such that water demand is equated to recharge. For instance, during the summer months, farmers can increase offtake rates (reducing their stocking) to reduce demand while in winter stocking rates can be increased as demand per capita declines to equate recharge to abstraction rates. In fact, most of the farmers in the Kgatleng District complain that during the summer season, their borehole yields decline due to increased abstraction to meet the demand while in winter they do not encounter the problem. Therefore, stocking rates could be reduced during summer and increased during the winter this will solve the problem of local depletion and at the same time achieve long term sustainability.

Using a recharge of 0.2 mm per year for the Masama Ranch, current abstraction rates are unsustainable by  $-2.9 \text{ m}^3$  per day. Table 9-6 shows the number of cattle that can be stocked in the Masama Ranch to achieve groundwater sustainability for the baseline and 2050, that is if the emphasis is on safe yield management. From the table below, it is clear that in winter the farm can be stocked to the carrying capacity and sustainability will still be achieved while in summer the stocking rate needs to be reduced by close to half for groundwater sustainability to be achieved. By 2050 there will be a need to further reduce the stocking rate to achieve sustainability of groundwater as result of climate change impacts on water demand. In chapter 2, it was noted that farmers in the Kgatleng District conserve water by controlling the number of times their cattle drink. Perhaps the control of stocking rates will be the best strategy given the associated costs of depriving cattle of water.

**Table 9-6: Stocking rate to achieve sustainability for baseline and 2050**

Model type	Emission scenario	Summer	Winter
	Baseline	447	700
HadCM3	A1B	419	700
	A1FT	410	700
	A1T	412	700
CSIRO Mk2	A1B	433	700
	A1FT	424	700
	A1T	429	700

Where,

Baseline is current; and,

HadCM3 and CSIRO Mk2 GCM represent 2050.

However, it should be emphasised that controlling stocking rates in order to manage groundwater sustainably is not going to be easy. Firstly, as indicated, projections are that livestock numbers might increase due to future increase in human population and income. Thus, it might be difficult for this management option to be implemented. Secondly, for this option to be viable there is a need to improve marketing structures for livestock. Currently, the Ministry of Agriculture encourages the sale of weaners and there is an improved market structure for cattle. Thirdly, for controlling stocking rate to be a viable option, there is also a

need to change management of livestock in the country from communal livestock rearing to commercial. Communal livestock rearing is not profit oriented and this regime discourages the sale of livestock. Thus as long as there is no change in management of cattle, controlling stocking rates as an option to conserve and manage groundwater sustainably might not work.

### **Tradable pumping permits**

This management option can be implemented to achieve sustainability at a larger scale. In addition to the fact that climate change may contribute to an increase in water demand and abstraction of groundwater, thus affecting sustainability of groundwater, it may also result in competition for water between cattle farming and urban water supply. To solve this problem tradable groundwater pumping permits could be implemented. Not only do tradable groundwater pumping permits ensure sustainability of groundwater use they may also solve the problem of competition between uses. Tradable groundwater pumping permits allow for abstraction of groundwater up to a certain level, as dictated by the permits (Perman *et al.*, 1997). They can be transferred from one individual to the other at a price determined by market forces of demand and supply (Perman *et al.*, 1997). However, if the individual, farmer and the urban water supplies have exhausted their permits they cannot abstract water until either they are given new permits or have obtained permits from another individual.

Permits are advantageous for ensuring groundwater sustainability for the following reasons: firstly, they encourage farmers to manage their stocking rate such that they do not exhaust their permits; and secondly, as total permits are set at total recharge it means there is no danger of unsustainable abstraction regimes. Thirdly, unlike other instruments such as command-and-control, permits have flexibility such that unused permits can either be banked for future use or they can be sold to those who have exhausted their permits (Perman *et al.*, 1997). Fourthly, groundwater pumping permits are advantageous as they enhance efficiency and innovation in technology to use less permits and sell the excess to those who have exhausted theirs. In this case study, permits could encourage improvements and efficiency of pans by reducing seepage and harnessing maximum surface runoff.

Therefore, the contribution of pans could be increased thereby reducing reliance on abstraction during the rainy season. Groundwater pumping permits have been used in the USA in a sustainable manner for solving allocation of water (surface and groundwater) issues (James, 2002; Kirsch and Characklis, undated).

Currently, competition for groundwater utilisation is steadily intensifying in the country and competition for resources generally encourages unsustainable regimes. For instance, cattle posts that are in the proximity of the diamond mining towns of Orapa, Letlhakane and Jwaneng and also Morupule coal mine are affected by depletion of groundwater. There are no instruments in place to tackle these issues. One of the areas that is likely going to join in competition is the Khurutshe area where the Masama Ranch is located. Besides being earmarked for supplying Gaborone during drought years, Khurutshe area has huge deposits of coal and a power station has been proposed with electricity to be exported to South Africa (Mmegi, 2006). Thus, in time, Masama Ranch and other cattle-posts will be exposed to the competition from Gaborone and possibly a coal power station. Above the impacts of climate change on cattle water demand in the region, these new entrants will intensify mining of groundwater in the Khurutshe area. As pointed out, the most efficient way to solve this problem which will ensure efficient utilisation of groundwater resources and at the same time protect users against other user's externalities (depletion of groundwater and rising cost of groundwater abstraction) will be through tradable pumping permits.

## Summary

The purpose of this chapter was to investigate the impacts of climate change by 2050 based on climate scenarios (temperature and rainfall) generated by SimCLIM using HadCM3 and CSIRO Mk2 GCMs. Three SRES emission scenarios being A1B, A1FT and A1T were used in generating climate scenarios by 2050. These three emission scenarios cover the extreme GHGs emission that is from the lowest, middle and highest emission path of GHGs. A system dynamics model was used in assessing the impacts of climate change.

The model demonstrate that by 2050 water demand for cattle could increase by as much as 25% in winter and 10% in the summer as a result of an increase in temperature. Overall, annual water demand for cattle could increase by more than 20%. While, the contribution of pan water to cattle water demand could decline by as much as 4.5% in summer while there is no change in the contribution of pan water in the winter. The implications being that abstraction of groundwater will increase, firstly, to meet the increase in demand and secondly to compensate for a decline in contribution of pan water. Thus an increase in abstraction will affect groundwater sustainability in the Masama Ranch. By 2050, groundwater unsustainable abstraction could intensify relative to the baseline period at the Masama Ranch. While for the whole Khurutshe area, the results indicate that cattle only use 24% of recharge and by 2050 the percentage will increase to 29%. However, the recharge rate of 1.6 mm per year raises some skepticism because water tables in the area are declining by 0.61 m per year. Declining water tables are generally associated with groundwater mining. By 2050, increases in water demand and declines in the contribution of rainfall may intensify the decline in water tables.

One of the groundwater management policies proposed by this study towards achieving sustainable development for groundwater utilisation is controlling stocking rates such that recharge and abstraction rates are equated or abstraction is below recharge, thus a safe yield management strategy. The stocking rates control policy will generally apply to the summer when demands are high. The effect of seasonality on stocking rate has also been demonstrated where in summer stocking rates will decline by as much as half compared to winter stocking rates. In addition, it is recommended that tradable groundwater pumping permits be implemented to enhance sustainability and also solve the future allocation of groundwater resource in the area between urban water supply and cattle farming.



## Chapter 10 : Conclusions and Summaries

---

### Introduction

The purpose of this thesis was to assess the impacts of climate change on cattle water demand and supply using a system dynamics model. The drivers of the cattle water system are climate variables: rainfall and temperature. The time horizon selected for assessing the impacts of climate change was 2050 using two GCMs: HadCM3 and CSIRO Mk2. The fundamental issue is the sustainability of current groundwater abstraction and what influences climate change may have on cattle water demand and supply by the year 2050.

In this chapter I summarise the rationale for doing this study and the contributions made to knowledge on the subject of cattle water demand and supply and climate change in semi-arid environments. In the following sections, I summarise chapters of this thesis highlighting the most important and salient features of each chapter. Findings on the impacts of climate change on cattle water demand and supply and policy recommendations for groundwater management are also summarised. Lastly, the strength, limitations and further research required on this subject are outlined.

### **Rational for choosing this topic and contribution to knowledge**

I identified a lack of in-depth research on the impacts of climate change on cattle water demand and supply. Considerable attention has been paid to the impacts of climate change on the supply-side of water resources: specifically on hydrology; precipitation; recharge; runoffs; and, river flow; while less work has been done on

the effects of climate change on water demand. For instance IPCC (1998) acknowledged that climate change will affect the demand for water but noted that most of the changes in demand will come from population growth, development and economic growth. On the other hand, the Comprehensive Assessment of Water Management in Agriculture (2007) points out that climate change will have strong implications for water and agriculture. In this thesis I have argued and demonstrated that to more fully understand the impacts of climate change on the water sector, it is essential that all impacts (on supply and demand) be assessed. I have argued that if we only focus on the supply-side of water resources as has previously been the case, an incomplete picture of the impacts of climate change on the water sector results. For instance, if we only look at the effect of climate change on recharge and ignore the influence of climate change on abstraction of groundwater the information is inadequate to comprehend the total impacts of climate change on groundwater and cannot facilitate effective groundwater management policies. Furthermore, the information cannot allow us to determine if national or localised groundwater depletion is occurring. In this study, I have found that climate change could lead to increased demand for water by cattle. This vital information together with the effects of climate change on groundwater recharge, give a more complete picture of the overall impacts of climate change on groundwater. Policies can then be implemented based on both the magnitude of increase in abstraction rates and decline in recharge rates resulting from climate change. Furthermore, vulnerability to water scarcity and mining can be assessed. Thus, in this study I have filled the gap in knowledge on climate change and water demand, particularly cattle water demand which is the major use of water resources in semi-arid environments of Africa. I acknowledge that insights on the effects of temperature on daily cattle water intake exists yet no attempt has been made to extend this knowledge to climate change hence the rationale for this thesis. Emphasis has been placed on climate change and the vulnerability of rural livelihood. However, I have argued that water sustainability forms an important part of rural livelihoods in semi-arid environments of Africa and thus required further study.

The next section summarises the chapter on cattle population in the country and water resources as noted highlighting important issues such as challenges faced by farmers in the Kgatleng District.

## **Cattle population and water resource in Botswana**

Botswana's cattle dynamics is linked with the development of the water sector, particularly the development of borehole technology which gave access to groundwater resources (Durraipah and Perkins, 1999; Harvey and Lewis, 1990; Oageng 1999; Peters, 1983). The cattle population increased dramatically after borehole technology, particularly in the Kgalagadi District and the sandveldt part of the country. Before borehole technology cattle ranching was limited to the hardveldt where surface water was available. Expansion of cattle ranching associated with borehole technology exacerbated environmental problems such as overgrazing which facilitated bush encroachment (Moleele, 1999) and declines in wildlife numbers, of both grazers and browsers such as wildebeest (Durraipah and Perkins, 1999). However, of particular interest to this study, has been the association between cattle and groundwater utilisation. The expansion of the national cattle herd has been accompanied by unprecedented abstraction of groundwater. This has led to declines in borehole yields which forced farmers to increase the depths of their boreholes. In other cases, salinity of water has increased due to increased abstraction.

There are two sources of water in Botswana: borehole and surface water from pans and rivers. Pans are seasonal and generally hold water during the rainy seasons. Obviously, boreholes can supply cattle with water throughout the year. The importance of pans has been acknowledged (Moleele and Mainah, 2002; Mpotokwane, 1999; Oageng, 1999). However, the development of pans (fencing, excavation and lining) has been shunned by most farmers as pans which hold water for a longer period of time attract stray animals which can lead to overgrazing of adjacent lands (water rights automatically give de facto right to grazing). Hence, pans are not used in an efficient manner. Kgatleng District is one of the first districts in the country to experience accelerated borehole drilling (Peters, 1983). It has reached its spatial limit satisfying the 8 km radius criteria of

borehole drilling. In addition, the District has limited groundwater resources besides the Khurutshe aquifers, such that in summer some farmers conserve water by controlling the frequency in which their cattle drink. With climate change, farmers in the Kgatleng District and probably in other semi-arid environments globally could face serious challenges with regard to water scarcity (both surface and groundwater). This correlation arises from a clear link that has been established in the water demand literature and from the analysis of data I collected on the amount of diesel used and water pumping hours in both summer and winter months. The next section summarises the methodology adapted in the thesis to assess the impacts of climate change on cattle water demand and supply.

## Methodology

In order to assess the impacts of climate change on cattle water demand, an impact assessment model is required. In this thesis, I adapted a system dynamics model using STELLA software. A system dynamics model as a methodological framework for this thesis was adapted for the two reasons. Firstly, it has been recognised that cattle grazing in a semi-arid environment is a system which is dynamic in nature. Therefore, it was suitable that a system dynamics model be adapted to assess the impacts of climate change on cattle water demand and supply. Two variables, temperature and rainfall are the determinants of cattle water demand and supply and therefore determine the abstraction rates of groundwater. In addition, a system's dynamics result from positive and negative feedbacks. These feedbacks make modelling of dynamics of systems complex. Thus, this complexity can only be managed by system dynamics models. For instance, in Botswana during the summer months farmers conserve water by determining the frequency of drinking of their cattle hence a negative feedback to the abstraction of groundwater.

To assess the impacts of climate change on cattle water demand and supply climate scenarios were constructed. Thus, the next section summarises the chapter on climate scenarios and their use for climate change impacts assessment in this thesis.

## Climate scenarios (rainfall and temperature)

A climate scenario is simply defined as how the future may unfold (IPCC, 1998). Climate scenarios are at the heart of climate impact assessment studies, generally because of a lack of knowledge, especially on the probability of occurrence of climatic events (IPCC, 1998). However, uncertainty still persists regarding future GHGs emission and radiative forcing of GHGs. The IPCC (1998) recommends that various GCMs be used to encompass a wide range of climate scenarios.

In this study, two GCMs were used to capture extreme changes *e.g.*, HadCM3 projects a higher increase in temperature and a lower decrease in rainfall, while CSIRO Mk2 projects a lower increase in temperature and a higher decrease in rainfall. In addition, three SRES emission scenarios; A1B, A1FT and A1T were examined. These emission scenarios also encompass extreme emissions (low and high). SimCLIM software was used to develop climate scenarios for 2050 using the baseline data for temperature and rainfall. Scenarios constructed indicate that by 2050 temperature may be higher with substantial increases in winter months of 3.6 °C and lower increases in summer months relative to winter. However, the hottest months will still be summer months. Rainfall on the other hand may decline by as much as 10% by 2050. From the constructed scenarios, climate change may affect the return period of extreme events. For instance, the return period for an extreme temperature of 38.6 °C in six days will be reduced from 133 years for the baseline to below three years by 2050. Six day was used as it is the memory time for daily water consumption. Intensity of drought and its return period may also be affected by climate change, as rainfall declines by 2050. From the constructed scenarios, the return period for mild drought (as defined earlier) will fall from 2 to 1.6 years.

In order to construct a model for cattle water demand and supply, components of the system are required, as noted rainfall determines abstraction of groundwater as a source of surface water (pan water). Thus in the next section I summarise rainfall patterns and pan water for cattle in the Khurutshe and Kgatleng District.

## Rainfall patterns and pans water for cattle

Rainfall is one of the components of cattle water demand and supply system in the semi-arid environments of Africa. Runoff from rainfall collects in pans and it is a vital resource of surface water for rural livelihoods in Africa where in most cases there are no water reticulation systems. In other cases, some farmers in the Kgatleng District are totally reliant on pans for watering their livestock (Mpotokwane, 1999; Oageng, 1999). The importance of pans and reliance of the rural population on pans for their livelihood has prompted the Government of Botswana under the Ministry of Agriculture, to come up with schemes for the construction of pans and their rehabilitation (lining and fencing). Though, the initiative is welcomed by the farmers with no boreholes, farmers with boreholes are reluctant to rehabilitate pans. Their argument has been that rehabilitated pans in the vicinity of their boreholes hold water for a long time and attract stray animals to the grazing area that leads to overstocking and overgrazing.

Though pans play an important role in rural livelihoods as a source of surface water for domestic uses, livestock and wildlife, their role is seasonal and erratic. The reason for the seasonality and erratic role of pans is because rainfall in the country is also erratic and seasonal. Rainfall is experienced in summer and very rarely during the winter. The extent to which a pan will hold water is a function of annual rainfall, geology, soils type and the size of the pan. In Kgatleng District, there are two types of geology; hardveldt and sandveldt. Loss of water by infiltration is high in the sandveldt compared to the hardveldt. In most cases farmers who rely on pans as a source of water are located on the hardveldt part of Kgatleng District.

Another important component of cattle water system is forage water content. In the next section I summarise forage water content and its influence on cattle water demand and supply.

## Forage water content

Daily water intake by cattle consists of voluntary and involuntary water intake. Involuntary water intake is the amount of water derived from forage. Just like pan water, the amount of water derived from forage is highly erratic and seasonal. During the rainy season more water is obtained from forage when cattle graze lush grass (Steinfeld *et al.*, 2006) while during the dry winter, cattle obtain little to no water from forage. However, even during the summer rainy season forage water content fluctuates considerably from the highest to the lowest value. This is because of the ASW and WP. ASW and WP are a function of precipitation and evapotranspiration. When ASW is below the WP, grasses wilt and cattle obtain little water from them. In order to model forage water content, it was essential that soil water content be estimated. This is because forage water content is dependent on soil water. Soil water was estimated using a simple soil water budget equation. Evapotranspiration was estimated using the Blaney-Criddle equation which uses temperature as the only climatic variable that determines evaporation. Based on ASW and WP a soil water index was derived which takes the value of one and zero. This index was then used to model forage water content. Involuntary water intake was calculated as a product of forage intake and forage water content.

Having discussed the important components of cattle water system (temperature, rainfall, pan water, forage water content and groundwater) a model was developed to assess the impacts of climate change on cattle water demand and supply. In the section I summarise the chapter on model development.

## Model development and validity

A cattle water system model was constructed with a specific aim of investigating the impacts of climate change on water demand and supply. The model boundary and structure was selected based on discussions and interviews with local farmers in Kgatleng District. The external drivers of the model are temperature and rainfall. Temperature influences daily per capita consumption of cattle while rainfall influences forage water content and pan water supply. These two variables can be affected by climate change. The model was constructed using STEELA

software. The reference mode of behaviour of the system, (abstraction of groundwater and daily water consumption) is viewed as oscillation, high during the summer but also with minimum or zero abstraction and low during the winter, but with no chance of falling to a minimum of zero in winter. The influence of rainfall is zero abstraction during the summer months, while the influence of temperature is high consumption during the summer and low consumption during the winter.

Model calibration was done based on data collected from the Masama Ranch in the Kgatleng District. Masama Ranch was selected for two reasons: firstly, it is fenced and therefore the number of cattle remains constant unlike other boreholes in the District which are not fenced and the number of cattle varies because of stray animals. Thus it was easier to collect accurate data on total daily water consumption and derive per capita consumptions figures. Moreover, the quantity of water in a pan could be easily estimated given a constant number of cattle. Secondly, the Masama Ranch was selected as it encompasses important aquifers in the country and is viewed as a resource to avert water scarcity in Gaborone. Thus, the management of the aquifer is of crucial importance to Gaborone's water supply. Model validity was based on statistical, structure, and reference mode of behaviour validity. In all cases, the model satisfied all the criteria selected to assess validity in chapter 8.

## **Results and recommendations**

### **Cattle water demand**

The model shows that by 2050, annual water demand for cattle in the Masama and Khurutshe area may increase by more than 20% from the baseline period given a constant number of cattle as shown in Table 10-1. The percentage increase in water demand is higher in winter and lower in summer. For instance, HadCM3 projects increases of more than 20% in winter and 10% in summer months by the years 2050. The increase in demand is solely due to an increase in temperature by 2050. The reason for a higher increase in winter months is because both the



HadCM3 and CSIRO Mk2 project a substantial increase in winter temperature compared to the summer. However, summer temperature will still be hotter than winter months.

**Table 10-1: Increase in water demand by 2050**

GCM	SRES emission scenario	% increase in water demand
	A1B	17.94
CSIRO Mk2	A1FT	20.18
	A1T	19.44
HadCM3	A1B	22.62
	A1FT	26.01
	A1T	24.40

### Surface water supply for cattle

Climate change will in all likelihood have an affect on water supply through a decline in rainfall. By 2050, the two GCMs used project a decline in rainfall. This will affect the pan water as a source in the rainy season. Table 10-2 shows the decline in the contribution of pan water to cattle water demand on a monthly basis. Summer months will have a greater decline in pan water. A higher decline is projected by CSIRO Mk2 A1FT which equals 4.46% in February while HadCM3 showed a lower decline compared to CSIRO Mk2. The effect of declining pan water will only be felt in summer while there will be no change in winter in contribution of pan water to cattle water demand. HadCM3 projects an insignificant increase in pan water in the month of January only. On an annual basis the decline of contribution of pan water to cattle water demand may range from 6% to 14.89%. The effect of increase in cattle water demand and the decline in contribution of pan water could lead to increased abstraction of groundwater to meet cattle demand.

**Table 10-2: decline in surface water supply to cattle water demand**

Months	HadCM3 A1T	HadCM3 A1B	HadCM3 A1FT	CSIRO A1B	CSIRO A1T	CSIRO A1FT
1	0.05	0.46	0.34	-2.23	-2.35	-2.39
2	-0.60	-0.87	-0.92	-2.23	-3.25	-4.46
3	-1.67	-1.45	-1.57	-1.77	-1.86	-1.94
4	-0.79	-0.12	-0.74	-0.25	-0.78	-0.79
5	-0.07	-0.06	-0.08	0.23	-0.03	-0.03
6	0	0	0	0	0	0
7	0	0	0	0	0	0
8	0	0	0	0	0	0
9	0	0	0	0	0	0
10	-0.66	-0.59	-1.26	-0.63	-0.65	-0.66
11	-0.26	-0.10	-0.16	-0.19	-0.21	-0.22
12	-3.58	-3.26	-3.44	-4.17	-4.36	-4.39
Annual	-7.61	-6.02	-7.86	-11.26	-13.52	-14.89

### Abstraction of groundwater

The increase in demand and decline in contribution of pan water will have implications for the abstraction and sustainability of groundwater. Table 10-3 shows the percentage increase in groundwater abstraction as a result of climate change by month. A close inspection of the percentage increase reveals that it is more than the percentage increase in demand. The increase in abstraction rate is greater than the demand because of decline in contribution of surface water and forage water content. It should be emphasised that the results of the contribution of pan water to cattle water demand apply only to the sandveldt part of the District. The results may be different in the hardveldt were seepage rates are lower and also the pans are larger compared to the sandveldts.

**Table 10-3: increase in groundwater abstraction rates.**

	HadCM3 A1T	HadCm3 A1B	HadCM3 A1FT	CSIRO A1B	CSIRO A1T	CSIRO A1FT
January	8.9	6.3	8.2	5.4	6.6	7.8
February	8.6	8.7	10.5	5.3	7.2	8.6
March	12.0	9.9	12.2	6.7	7.9	8.2
April	12.0	9.9	13.5	4.5	5.8	5.9
May	16.6	14.2	18.3	5.5	7.1	7.4
June	15.4	16.6	20.9	7.1	8.8	10.1
July	20.6	18.8	25.7	10.8	13.7	15.8
August	17.0	14.9	20.2	8.6	10.7	11.9
September	13.1	11.0	14.1	7.3	8.5	8.9
October	10.7	8.9	11.4	6.9	8.2	8.7
November	8.2	6.3	8.4	5.4	6.8	7.2
December	11.2	9.0	11.8	9.8	11.3	11.7

An increase in abstraction rates as a result of climate change is primarily due to increases in temperature that will have implication for sustainability of groundwater not only in the Khurutshe area of the Kgatleng District but to all semi-arid environments of Africa. Already, studies have indicated that during drought years and summer months when demand peaks, local depletion occurs (Calow *et al.*, 2002; Mati *et al.*, 2005). As indicated by the model, climate change may lead to cattle water demand increasing substantially during the winter season leading to depletion extending into the winter. Using a 0.2 mm per year recharge for the Masama Ranch (due to the presence of the basalts that inhibit recharge), the model indicates that unsustainable abstraction of groundwater is occurring in the Masama Ranch. While using a different average recharge rate of 1.5 mm per year for the whole of Khurutshe area, the model shows that abstraction rates for cattle is sustainable. However, the results for the whole Khurutshe aquifer are not consistent with the declining water tables of 0.6 meters per year. Still the results are consistent with other findings by Calow *et al.*, (2002) that the depletion of groundwater in semi-arid environments of Africa is unlikely as abstraction rates are lower than long-term recharge rates.

The results for Masama Ranch indicate that with climate change groundwater mining will intensify. By 2050, two months (June and July) may be the only months in a year that could have sustainable abstraction rates. Months that were

unsustainable will be even more unsustainable as depicted by the sustainability index. However, the exploitation of the Khurutshe aquifer's groundwater will still be sustainable. In fact, the model indicates that abstraction rates are only 25% of the recharge. This is in contrary to the study by Kgathi (1998) who argued that groundwater utilisation in the country is unsustainable. In addition, this study is in line with Calow *et al.*, (2002) that at the larger scale groundwater utilisation is sustainable as abstraction rates are lower than long-term recharge and that the problem maybe localised mining of groundwater resource. Their finding are in line with the findings of this study where it was found that at the localised area mining is occurring while at the larger scale there is no mining.

### **Implication of the findings in relation to semi-arid environments of Africa**

The findings of this study on the influence of climate change on livestock water demand and supply have immense implications for livestock water resources in semi-arid environments of Africa. As noted, livestock raising is the predominant economic activity in these regions and therefore water for livestock is of critical importance (Mati *et al.*, 2000). However, these semi-arid environments are already suffering mild to acute water scarcity. In most cases, acute water scarcity is experienced in areas during drought years when surface water from pans and rivers has been depleted (Calow *et al.*, 2002; Mati *et al.*, 2005).

The impacts of seasonal variability on water demand and supply in semi-arid environments of Africa is to wedge a gap between demand and supply. Supply declines from lack of rainfall, particularly surface water from pans and streams and, also from boreholes as a result of reduced recharge. At the same time, demand for water particularly for livestock increases during these dry seasons leading to acute water scarcity. According to Mati *et al.*, (2005) a lack of water has a serious impact on rural livelihood. The drought of 2000 in Kenya resulted in a loss of about 50% of the cattle population mostly from lack of water (Mati *et al.*, 2005). Discussion with farmers in the Kgatlang District revealed that farmers with no boreholes suffer heavy loss from drought when streams and pans dry. Mostly their animals are trapped in muddy river channels and perish.

Throughout the semi-arid environments of Africa, three groups of farmers can be identified: farmers with modern boreholes, farmers with hand-dug boreholes and farmers who rely on pans and stream. The vulnerability of each of these groups to water scarcity during the hot and dry season differs. Intuitively, farmers with modern boreholes are less vulnerable to water scarcity compared to those with hand-dug boreholes and those with no boreholes. As indicated by Nicholson (1987) the adaptation strategy to conserve water in these semi-arid environments is to control the frequency in which livestock drink, particularly for those farmers with enclosed water points such as boreholes and community managed pans which are fenced.

From the findings of this thesis, it is clear that climate change will worsen the current water situation in semi-arid environments of Africa. Cold months will become hotter leading to increased water demand for cattle. Therefore, future water demands for livestock are likely to be at peaks or close to them throughout the year. Thus, instead of experiencing acute water scarcity during the summer as a result of a peak in demand noted by Calow *et al.*, (2002) and from the findings of this study, acute water scarcity may extend into winter months as well. Currently, localised depletion is experienced during the summer months when demand is at a peak. In future, this phenomenon could be experienced year round. For those farmers with no boreholes and who therefore are reliant on surface water from pans, the impacts of climate change on water demand and supply could be catastrophic. Firstly, water supply from pans and stream is likely to be limited due to reduced rainfall and increased frequency of drought. At the same time, the available water might be depleted quickly as a result of the effect of increased temperature on daily water intake. Thus, pans are not going to hold water long enough for the next rainfall season. As a result, livestock losses from lack of water are likely going to be higher than the current baseline. The overall effect of climate change on cattle water demand and supply will have an adverse impact on rural livelihood sustainability.

## Management recommendations

It is recommended that for sustainability to be achieved especially at the local boreholes to avoid local depletion, stocking rates must be managed according to winter and summer demands. That is, when the demand increases due to an increase in temperature, stocking rates should be reduced to a point where total demand is equal to recharge. If a stocking rates policy is used, then by 2050, summer stocking rates will be much lower than baseline stocking rates.

Another recommendation to achieve groundwater sustainability is the use of tradable pumping permits particularly in the Khurutshe area. The aquifers in the Khurutshe have been connected to the NSWC to supply Gaborone and the surrounding villages during drought years. Due to declining rainfall as a result of climate change and increasing water demand in Gaborone the reliance on the aquifers as an adaptation strategy may increase. This may lead to more unsustainable use of the aquifer and competition between cattle farming and urban water supply. Therefore tradable groundwater pumping permits could be adopted as a management tool for efficient allocation, while at the same time achieving sustainability. In fact, permits can help to manage stocking rates to achieve sustainability.

Lastly, pans play a vital role as a source of water supply for livestock and wildlife particularly in the hardveldt parts of the country. This role extends to the boreholes by relieving pressure from abstraction of groundwater. It is therefore recommended that pans be managed more efficiently. This can be done through fencing, lining and excavation to increase their holding capacity. Lastly, community management of the pans must be emphasised for pans located on communal lands.

## Strength of this study

The importance of this study to literature on climate change and cattle water demand and supply is undisputable, not only to Khurutshe, Botswana but for all semi-arid environments of Africa, where cattle rearing is the most common economic activity and is dependent on groundwater. This study has established a clear link between climate variables (rainfall and temperature) and the rate of groundwater abstraction which no other study has previously done. The other strength of this study is the fact that other studies that have looked at climate change and water resources in a piece-meal fashion. That is, they focused on one aspect only, mostly supply. This study-methodology in contrast has taken an integrated approach by looking at both supply and demand. In addition, this study has demonstrated that if an integrated approach to assessment of the impacts of climate change is not undertaken, then the understanding of those impacts will be deficient. The other strength of the study lies in its informative results obtained on the impacts of climate change on cattle water demand and supply. This information can be used as a powerful tool for groundwater management policy-making, particularly integrated groundwater management in the face of climate change. Prior to this study no information was available on abstraction rates of groundwater for livestock and thus no policy on groundwater abstraction was available. However, this study has demonstrated that with climate change there might be stiff competition between different uses of groundwater particularly in the Khurutshe area where the study was conducted. Thus, this will require the development and implementation of comprehensive and effective allocation policies.

In addition, to the outlined strength of this study, it is worthwhile to note that this study adopted a holistic approach which took into account important phenomenon such as drought which affects livestock population and water for the livestock supply particularly livestock that are totally reliant on surface pan water.

## Limitations of the study

Modelling is simplification of reality and simplification involves adopting assumptions. Therefore some of the limitations of this study are a result of these assumptions. One limitation of this study is in regard to the recharge rates used. The recharge rates are long-term recharge rates based on long-term average precipitation. The problem with using this kind of recharge is that recharge rates fluctuate according to annual rainfall. Thus, using a long-term mean recharge rates over-estimates actual recharge during the drought years and years with above normal rainfall are underestimated. For more accurate results recharge rates should be modelled as a function of rainfall and other climatic variables (evapotranspiration). When using a constant average recharge rate skepticism arises particularly when using the same recharge for the year 2050 when climate scenarios (rainfall) have indicated that rainfall will be in decline. Therefore, if a recharge rate that is dependent on rainfall is used in the model, the results on sustainability will probably be different from that obtained.

Another limitation of the study is the assumption of using constant numbers of cattle for both Masama Ranch and Khurutshe area. It is generally known that carrying capacity is a function of biomass productivity which is a function of rainfall. In addition, with bush encroachment as noted by Moleele (1999) in Kgatleng District, it is possible that climate change carrying capacity and stocking rates may decline. Thus, the use of constant stocking rates and assuming that the stocking rates will be similar to the baseline may be wrong.

The third limitation of the study is the assumption made on the crop coefficient for grass. It is assumed that the crop coefficient is constant throughout the growth stage of the grass. While in reality the crop coefficient is not constant. On the other hand, it is observed that this assumption does not have any significant effect on the outcomes, as forage contribution to cattle water demand is low.

Lastly, declining water tables and local depletion are a function of storativity and transmissivity. In modelling, the impacts of climate change on cattle water demand and supply, a general groundwater sustainability index of a ratio between



recharge and abstraction has been used. However, there is another sustainability index which can give different results from the ratio between recharge and abstraction and this is localised depletion. Localised depletion is a function of the rate at which water is transported. If the transport process is slow then local depletion will take place. The issue in Botswana may be more of the case whereby local depletion is occurring rather than national depletion. Therefore, it is felt that both types of sustainability should have been given equal attention.

### **Future work required**

This thesis has been an eye-opener for me on issues that relate to climate change, groundwater abstraction for cattle water demand and future competition possibilities. I have learned that more work still needs to be done on climate change and its impact of cattle water demand and supply. More research needs to be conducted on policy issues, especially with regard to allocation of groundwater to different users with emphasis on the cattle sector and municipal water use. It has been noted that the Khurutshe aquifers have been earmarked to supply Gaborone and surrounding villages during drought years when the south-eastern part of Botswana experience acute water scarcity. Supply from the Khurutshe aquifers may result in equity and social implication for the rural livelihoods. Therefore, work is required on optimal allocation of groundwater resources, equity issues and the efficient economic instruments that can be employed for the best allocation outcome.

In addition, it has been noted that costs of cattle water supply are relatively higher than other costs such as supplementary feeds and labour costs. This study has already demonstrated that with climate change the demand and abstraction of groundwater may increase. Thus, research needs to be conducted on how climate change could influence the cost of water and which group of farmers will be heavily affected by changes in this cost as a result of climate change. For instance, in Kgatleng District, three groups of farmers can be identified as follows: farmers with modern boreholes; farmers with hand-dug wells; and, farmers who rely of pans and buying water from those with modern boreholes during dry seasons. It is

important to carry out research on how climate change may affect each group and assess rural livelihood sustainability.

It has been noted that farmers in the semi-arid environments of Africa control the frequency at which cattle drink particularly during the summer when water tables and borehole yield decline. This strategy is aimed at conserving water. As indicated in the thesis, this strategy is currently common during the hot season when cattle water demand is high. But as noted in the thesis, this may extend into the winter season as temperature increase. Therefore, it is vital that research be conducted on how increased control of the frequency of cattle drinking affects productivity of the cattle in terms of milk production, growth rate and overall productivity. All these factors are directly linked to rural household incomes. Thus, it is imperative to determine the effect of climate change on rural household income as a result of increases in water demand and decline in surface water supply and controlling the frequency of drinking of cattle as a way to conserve water. Research needs to identify alternative adaptation measures that can be implemented at a low costs.

Storativity and transmissivity are the most important variables that determine the rate of decline of water tables and also the borehole yield during the summer when demand is at its peak. It is therefore important that when the impacts of climate change on cattle water demand and supply are discussed and modelled these variables be included. In addition, a thorough investigation of the variables should be conducted and mapped to guide borehole drilling as an adaptation measure against localised depletion.

Lastly, possible groundwater management options have been highlighted to enhance sustainability and reduce competition between resources in the study. It is imperative that an economic assessment be carried out on these options at both the regional, local and household levels. Assessment could be in terms of the economic implications and their effectiveness.

## Appendix 1

SimCLIM is a computer model software for assessing the effects of climate variability and change in time and space. It was developed by International Global Change Institute (IGCI), University of Waikato. SimCLIM has an “open-framework” features that enable users to examine climate change and variability for a specific area and at any spatial resolution. In addition, this feature allows for impacts models to be attached to SimCLIM. Some of the tasks that SimCLIM is tailored to perform include:

- describe baseline climate
- examine current climate variability and extremes
- assess risks for both present and future
- create scenarios of climate and sea-level change
- conduct sensitivity analysis
- project sectoral impacts of climate and sea level change
- examine risks and uncertainties, and
- facilitate integrated impact analysis

In order to model climate variability and change over time and space, two types of climate data are required: long term monthly-mean to represent the baseline climatology and observed daily time-series data. This data will generally cover a 30 year period to conform to the WMO standard. Basically, the monthly-mean data can be used to develop spatially-interpolated climatologies while daily time series (rainfall and temperature) are used for the extreme event analysis tool and as input in impact models, especially when they are run on daily time steps. SimCLIM uses GCM patterns for downscaling the global climate change scenarios to the specific local spatial resolution. Time series climate scenarios can be projected from the baseline to 2100. This version of SimCLIM use in this study had three options for downscaling global climate change scenarios to local climate scenarios: HadCM3, CSIRO Mk2 and NIES.

## Data import

In order to carry out climate variability, change and extreme event analysis, observed daily time-series and long term monthly-mean data has to be loaded into SimCLIM. The software has a data import wizard icon that enables importation of data (Figure 10.1).

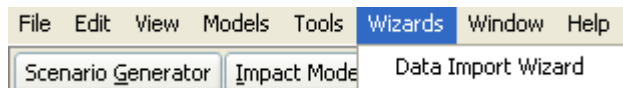

**Figure 10.1: data import wizard icon**

SimCLIM supports two formats of data for both daily and monthly import file. Only the daily data option is shown here. The first column is date in 8 digits (yearmonthday) and the second column is the climate data as shown.

```
19790101 33.3
19790102 29.2
19790103 30.6
19790104 30.5
19790105 30.2
19790106 30.9
```

The second format is where the first column is the year and the second column is the month and the rest are climate data. As noted these are daily data

```
1972 1 50 50 22 11 33 17 22 11 61 72 44 56 122 22 100 89 11 83 94 11 17
      94 67 117 100 100 56 61 72 61 56
1972 2 6 22 39 0 89 44 83 83 56 56 44 56 17 22 56 11 6 28 11 100 50 33 56
      0 -17 -22 22 28 33 -999 -999
1972 3 94 22 -67 11 11 -56 100 39 -39 -50 50 22 -6 17 22 22 39 11 -33 44
      72 56 11 -28 -22 17 0 11 83 56 111
1972 4 56 56 61 39 22 11 39 39 50 83 128 100 144 83 78 67 128 211 161
      111 106 89 89 83 78 128 106 156 156 156 -999
```

These data are imported to the site data editor icon which requires site information in terms of latitude and longitude, site ID etc (Figure 10.2).

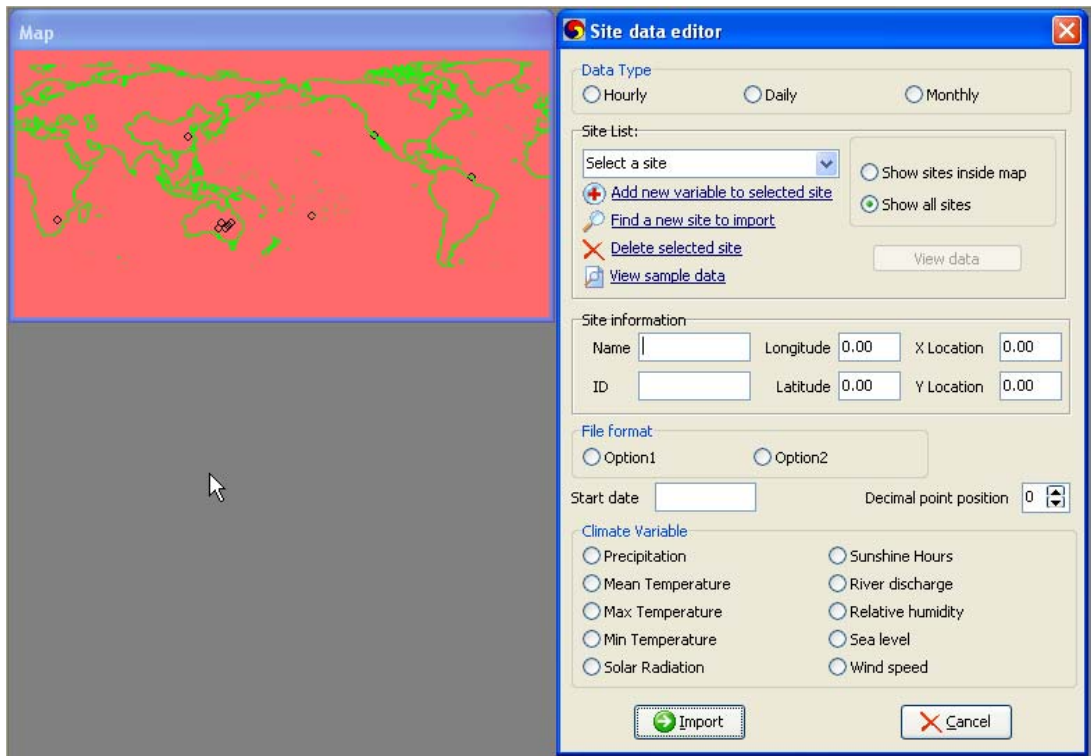

Figure 10.2: Site data editor

### ***Spatial climate scenario generator***

Spatial climate scenarios can be generated based on the imported observed site specific data. In order to generate a scenario, a spatial scenario generator icon must be activated which in turn activates the icon for climate variables (Figure 10.3).

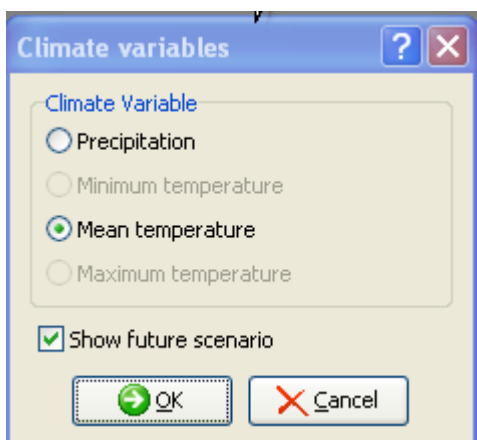
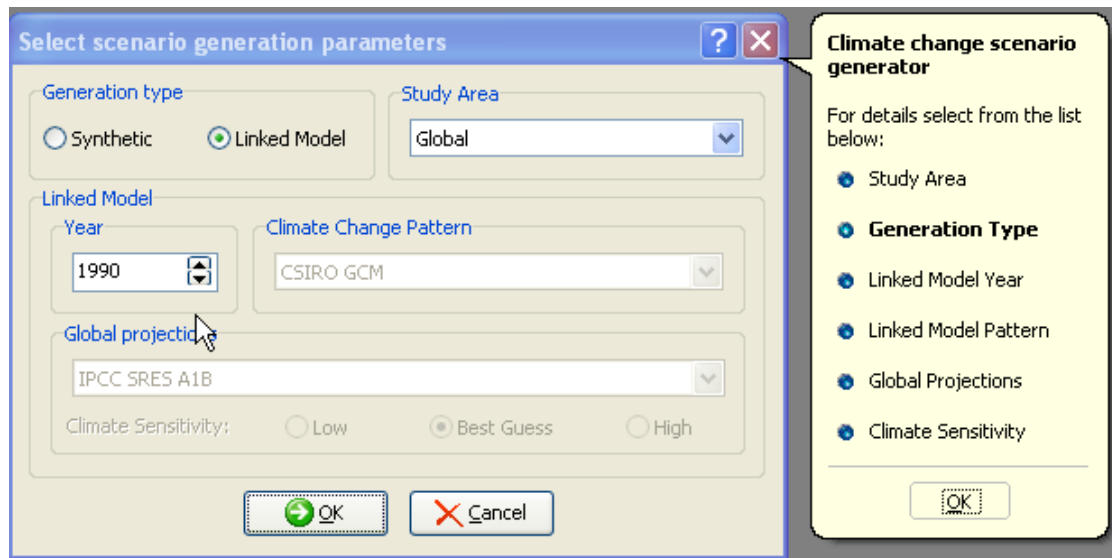

Figure 10.3: Climate variables icon

A scenario generation parameters dialogue box will be displayed where the user has to choose the generation type they want to use. In addition, the year to which a scenario must be generated, the GCMs, SRES emission scenario and the climate sensitivity must be specified. The GCMs, SRES and climate sensitivity have all been defined in the thesis (Figure 10.4).



**Figure 10.4: Scenario generation parameters**

The difference between the generation types (synthetic and linked model) is that the synthetic scenario generator enables users to make incremental adjustments to temperature and precipitation in percentages. On the other hand, a linked model uses the changes to perturb the present climate (1990 baseline) creating climate scenarios for the year chosen (2050) as follows:

Future temperature = present temperature + (MAGICC value \* Standardised GCM pattern of temperature change, in °C)

Future precipitation = present precipitation \* (MAGICC value \* Standardised GCM pattern of precipitation change, in %)

## **Generalised Extreme event Analysis**

Site specific baseline daily or hourly time series data required for the generalised extreme event analysis tool. The generalised extreme event analysis is activated from the impacts models icon. From the extreme analysis, the following must be specified; data type (hourly or daily), site of interest, climate data of interest (T max, T min, Precip, streamflow, sea level, wind) in days, specific historical period, and PWM calculation order (Figure 10.5).

The screenshot shows the 'Extreme Analysis' software interface. The window title is 'Extreme Analysis'. The interface includes the following elements:

- Data Type:** Radio buttons for 'Hourly' and 'Daily' (selected).
- Station database:** Radio button for 'Observed'.
- Site list:** A dropdown menu labeled 'Select a site' and radio buttons for 'Show sites inside selected area' (selected) and 'Show all available sites'.
- Month, Season, Fixed Date, Scenario:** Input fields for these parameters, with 'Scenario' set to '1990'.
- Climate Data Selection:** Tabs for 'T Max', 'T Min', 'Precip', 'Streamflow', 'Sea level', and 'Wind'. 'T Max' is selected, and a spinner box shows '1' day(s).
- Extreme event definition:** Radio buttons for 'on total' (selected), 'on highest', and 'on lowest'.
- Historical Period:** Input fields for 'Use climate data form historical period' with two date placeholders '//'.
- PWM Calculation:** A dropdown menu for 'Select PWM calculation order' set to '0'.
- GEV Distribution Table:**

	U	A	K	Z	R2
Values					
- Buttons:** 'Run' and 'Close' buttons at the bottom.

**Figure 10.5: Extreme event analysis interface.**

The result will be represented in a table and by clicking on the table a visualization of graph will be shown as below (Figure 10.6).

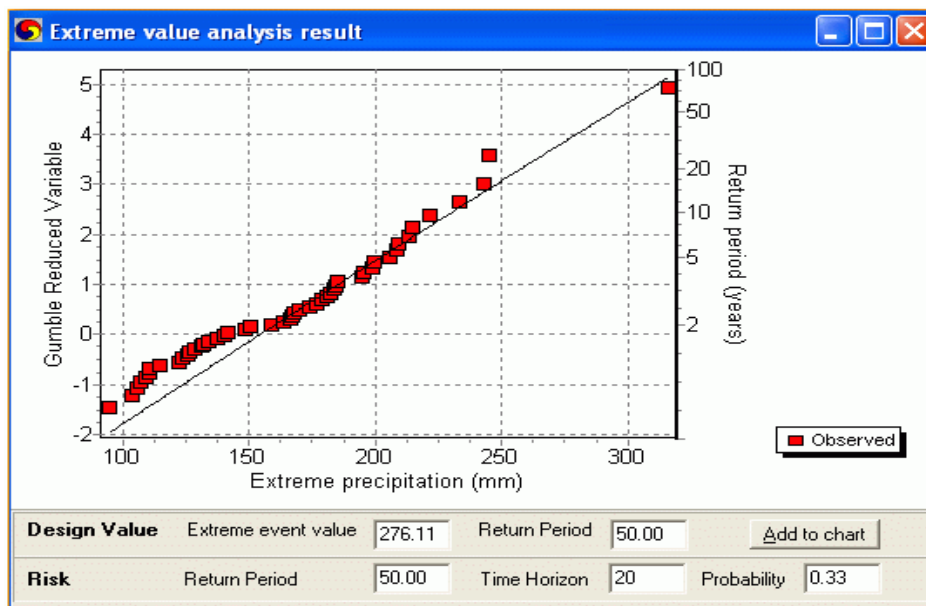
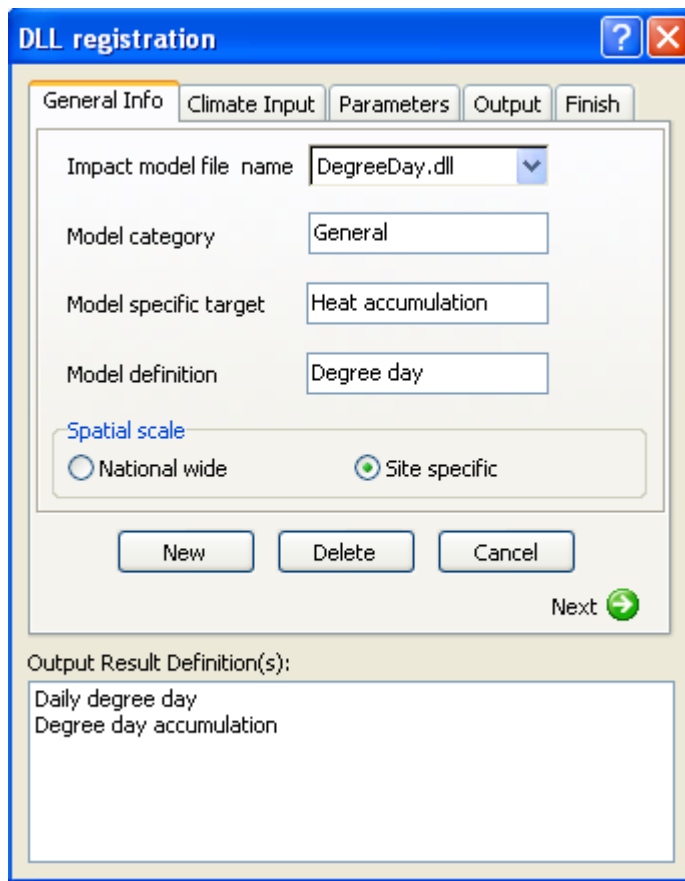

Figure 10.6: Extreme value analysis result graph

### ***Impact model component of SimCLIM***

Though not used in this study, SimCLIM as noted has an “open-framework” that allows the user to attach impacts model to scenario generated such that the impact model can be run simultaneously with scenario generation. The climate scenario generated is used to perturb the impact model. That is, the climate change scenario generator drives an impact model. The impacts models are developed as Dynamic Link library (DLL) files and therefore the impact model can be developed independently from SimCLIM. The templates for the impact models are developed in Delphi. The developed impacts models are for the following major sectors: coastal zones, human health, agriculture and water. To attach models to SimCLIM one simply goes to the Tools menu and clicks on the impact model importer (Figure 10.7).





**Figure 10.7: DLL registration interface.**

This information and the graphs on SimCLIM is taken from SimCLIM factsheet (CLIMsystems Ltd).

## **Appendix 2**

STELLA equations and climatic data used in validating the model for Masama Ranch.

1.  $\text{age\_of\_water\_in\_pan}(t) = \text{age\_of\_water\_in\_pan}(t - dt) + (\text{age\_of\_water}) * dt$

INIT  $\text{age\_of\_water\_in\_pan} = 0$

INFLOWS:

2.  $\text{age\_of\_water} = \text{IF} (\text{water\_in\_pan}=0) \text{ THEN } -\text{age\_of\_water\_in\_pan} \text{ ELSE } \text{IF}(\text{rainfall}\geq 40) \text{ THEN } -\text{age\_of\_water\_in\_pan} \text{ ELSE } (DT)$

3.  $\text{cumulative\_abstraction}(t) = \text{cumulative\_abstraction}(t - dt) + (\text{abstraction}) * dt$

INIT  $\text{cumulative\_abstraction} = 1$

INFLOWS:

4.  $\text{Abstraction} = (\text{daily\_consumption\_per\_capita} * \text{number\_of\_cattle}) / 1000 - \text{livestock\_consumption\_from\_pan}$

5.  $\text{Forage\_water\_content}(t) = \text{forage\_water\_content}(t - dt) + (\text{rate\_of\_increase} - \text{rate\_of\_decline}) * dt$

INIT  $\text{forage\_water\_content} = 0.67$

INFLOWS:

6.  $\text{rate\_of\_increase} = \text{IF} (\text{forage\_water\_content} < 0.4) \text{ AND } \text{soil\_moisture\_index} = 1 \text{ THEN } 0.1675 * 2.7^{0.4694 * \text{soil\_moisture\_index}} \text{ ELSE } (0.00142 + 0.0175 * \text{soil\_moisture\_index})$

OUTFLOWS:

7.  $\text{rate\_of\_decline} = 0.02 * \text{forage\_water\_content}$

8.  $\text{groundwater}(t) = \text{groundwater}(t - dt) + (\text{recharge} - \text{abstraction}) * dt$

INIT  $\text{groundwater} = 774000000$

INFLOWS:

9.  $\text{recharge} = \text{aquifer\_areal} * \text{average\_recharge\_per\_m}^2$

OUTFLOWS:

10.  $\text{abstraction} = (\text{daily\_consumption\_per\_capita} * \text{number\_of\_cattle}) / 1000 - \text{livestock\_consumption\_from\_pan}$

11.  $\text{soil\_water\_content}(t) = \text{soil\_water\_content}(t - dt) + (\text{effective\_rainfall} - \text{evapotranspiration}) * dt$

INIT soil\_water\_content = 0

INFLOWS:

12. effective\_rainfall = IF(rainfall=0) THEN 0 ELSE (rainfall-3)

OUTFLOWS:

13. evapotranspiration =

consumptive\_factor\*(1.8\*temperature+32)\*daily\_hours\_of\_sunshine/100

INFLOWS:

14. water\_in\_pan(t) = water\_in\_pan(t - dt) + (runoff - seepage - livestock\_consumption\_from\_pan) \* dt

INIT water\_in\_pan = 0

INFLOWS:

15. runoff = (catchment\_area\*runoff\_coefficient\*rainfall)/1000

OUTFLOWS:

16. seepage = 0.00007\*area\_of\_pan^1.8

17. livestock\_consumption\_from\_pan = IF (water\_in\_pan=0) THEN 0 ELSE IF (water\_in\_pan>=(daily\_consumption\_per\_capita/1000\*number\_of\_cattle)) THEN (daily\_consumption\_per\_capita/1000-(0.000399\*age\_of\_water\_in\_pan))\*number\_of\_cattle ELSE (water\_in\_pan)

UNATTACHED:

18. area\_of\_pan = IF(water\_in\_pan=0) THEN 0 ELSE 75.288\*water\_in\_pan^0.528

19. average\_recharge\_per\_m2 = (0.0002/365)

20. catchment\_area = IF (rainfall<=29) then 0 else 13226.3

21. consumptive\_factor = (0.3118\*temperature-4.9)

22. daily\_consumption\_per\_capita = (2.148\*temperature-20.18) + error\_term

23. daily\_hours\_of\_sunshine = 1.23

24. environmental\_sustainability\_index\_1 = groundwater/cumulative\_abstraction

25. environmental\_sustainability\_index\_2 = recharge-abstraction

26. error\_term = (4.658\*forage\_water\_intake^3-

21.478\*forage\_water\_intake^2+24.288\*forage\_water\_intake-3.799)

forage\_intake = 9

27. forage\_water\_intake = forage\_water\_content\*forage\_intake

```
number_of_cattle = 700
runoff_coefficient = 0.3
28. soil_moisture_index = IF(soil_water_content-wilting_point)<wilting_point
THEN 0 ELSE 1
29. total_water_consumption =
daily_consumption_per_capita+forage_water_intake
30. wilting_point = IF(soil_water_content=110) THEN 0 ELSE 0.2
```