

Seng Tong, Chong; Yu Jin, Ng; Azam Abdul Rahman; Noor & MohdKasim, Zalina
Cognitive Grammar on “smash”: Perspectives from Langacker’s Framework

COGNITIVE GRAMMAR ON “SMASH”: PERSPECTIVES FROM LANGACKER’S FRAMEWORK

Chong Seng Tong, Ng Yu Jin, Noor Azam Abdul Rahman &
Zalina MohdKasim
Universiti Tenaga Nasional, Malaysia

Abstract

The language system allows us to express perceived events in different ways using different linguistic resources. Ability to perform this task goes beyond the notion of prescriptive grammar, which makes no connection between language and the cognitive mind. Cognitive grammar focuses on the way we construct our ideas. Meaning is equated with conceptualization. Semantic structures are characterized Based on the ideas and theses posited by Langacker with regards to Cognitive Grammar, we seek to illustrate how our cognitive minds help us manipulate the use of language, especially the grammatical items.

Keywords: Cognitive Grammar, Langacker, Pedagogy, Smash

INTRODUCTION

Before adopting the framework of the cognitive linguistics, it is useful to take a closer look at the definition of Cognitive Grammar. According to Langacker (1990, 1999) Cognitive Grammar is an alternative model of linguistic categorization that seeks to relate language to cognitive processing, where linguistic expression is analyzed at its semantic value that reflects not only the content of a conceived situation but also how the content is structured and construed. Cognitive Grammar acknowledges human’s mental capacity of establishing relationship between entities, grouping entities, performing flexible mental scanning, forming image schemas and performing metaphorical projections. Cognitive grammar takes a nonstandard view of linguistic semantics and grammatical structure. (Langacker 1986, p.1). Meaning is equated with conceptualization. Semantic structures are characterized. Thus, meaning is equated with conceptualization.

Cognitive Grammar operates on the convention that a lexical item represents the “commonality in form and meaning observable across usage events”, namely our “actual utterances in their full detail and contextual understanding”. This commonality is reinforced and established by means of

Direct all correspondence to:
yudic2000@yahoo.com
shirlyrizki@yahoo.com

decontextualisation and schematization. Decontextualization involves filtering the non-recurrent features and schematization involves abstracting fine details to allow for identification of commonality (Langacker, 1999:2).

Langacker proposes the following theses for Cognitive Grammar:

- a) Economy must be consistent with psychological reality. The grammar of a language represents conventional linguistic knowledge and includes all linguistic structures learned as established 'units'. 'Content unit' coexist in the grammar with subsuming schemas.
- b) Only 'semantic', 'phonological' and bipolar 'symbolic' units are posited. Sharp dichotomies are usually found only by arbitrarily selecting examples from opposite ends of a continuum.
- c) Syntax is not autonomous, but 'symbolic', forming a continuum with lexicon and morphology. Syntactic units are 'bipolar' with semantic and phonological poles.
- d) Semantic structure is language specific, involving layers of 'conventional imagery'. 'Semantic structure' is conventionalized conceptual structure, and 'grammar' is the conventional symbolization of semantic structure.
- e) Grammatical morphemes are meaningful, and are present because of their semantic contribution.
- f) Grammatical structure is almost entirely overt. There are no underlying structures or derivations are posited.
- g) Lexicon and grammar form a continuum of symbolic structures. This continuum contains no sharp dichotomies based on generality, regularity, or analyzability.

Langacker (1990, pp.101-102)

The diagram below illustrates Langacker's basic concepts in Cognitive Grammar:

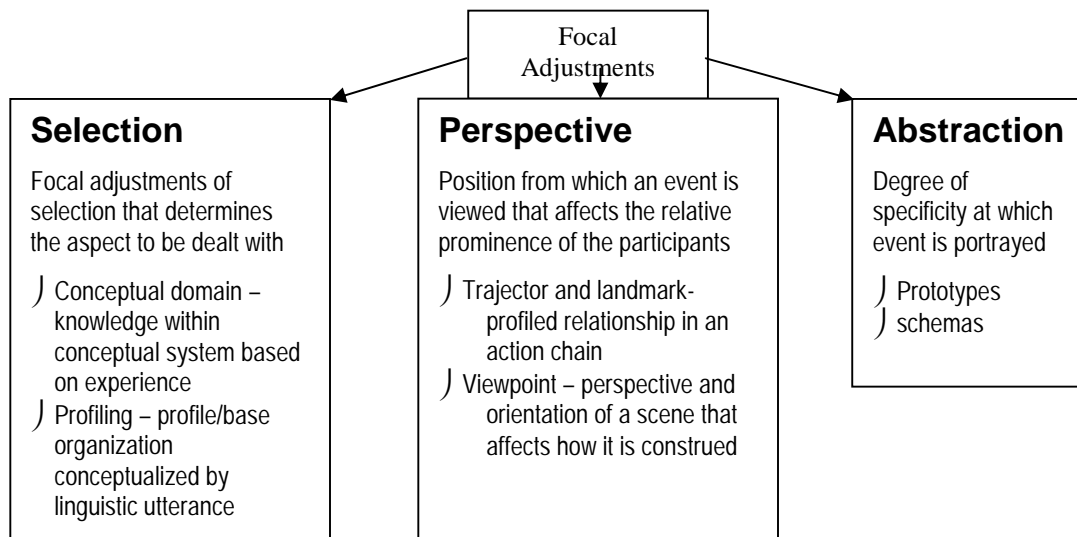

Figure 1: Focal adjustments based on Langacker's(1987) Framework

different ways using different linguistic resources. Learning the parts of grammar facilitates better language expression with language accuracy. “Knowing how to build and use certain structures makes it possible to communicate common types of meaning successfully” (Swan, 2009, p.151). Should students know how to differentiate the grammatical items successfully, it is evident that they are able to ‘cognitively’ acquire the target structures to excel in grammar learning.

Many people think that the language they understand in this way is more powerfully learnt (because they had to make some cognitive effort as they uncovered its patterns) than it would have been if they were told the grammar rules first and did not have to make such an effort.

(Harmer, 2007, p.82)

Grammar teaching is undoubtedly a case of consciousness raising despite some limitation (Ellis, 2009). Ellis (2009) adds that “consciousness-raising is not an alternative to communication activities, but a supplement” (p.174). Thus, learners need to learn the linguistic structures to function at desired competence.

Because of the importance of linguistic form in second language communication and the amount of attention currently being given to the role of form-focused instruction in language teaching, we can expect these issues to continue to be at the forefront of applied linguistic theory and research for the foreseeable future.

(Richards, 2009, p.164)

This paper examines an example of teaching verbs using Langacker’s cognitive grammar and illustrates how learners may learn grammar using cognitive linguistics method.

OBJECTIVE AND SCOPE OF ANALYSIS

This paper seeks to:

-) Compare and contrast five given sentences
 - **Jack smashed the vase**
 - **The vase was smashed by Jack**
 - **The vase was smashed**
 - **The vase smashed**
 - **The vase is smashed**

-) Apply the framework of Cognitive Grammar posited by Langacker
-) Relate the outcome of study to the basics of Cognitive Grammar

ANALYSIS

With regards to the active and passive sentences that will be analyzed in this paper, we would like to highlight that cognitive linguists would contest the views of the traditional linguists who propose that; (1) there is a multilevel syntagmatic structure for passive clauses where the basic deep structure is active voice, (2) the objects of *by* in passive are actually the demoted subject in the deep structure and (3) the grammatical morphemes are meaningless entities.

All the five sentences above, despite having the same content schema, are semantically distinct in terms of their image schemas due to their analyzability.

Schematic Abstraction

These are the sentences that will be analyzed:

- a) **Jack smashed the vase**
- b) **The vase was smashed by Jack**
- c) **The vase was smashed**
- d) **The vase smashed**
- e) **The vase is smashed**

All the sentences above display the same basic content schema. The focal adjustment of selection determines that all five sentences invoke a complex matrix of basic domains namely **space** (vision, touch, kinesthesia) and **pitch** (hearing). All the sentences are of **relational predication where the interconnection between two entities is profiled** (Langacker, 1990), therefore, the schematic content image can be based on sentence (a) as shown below:

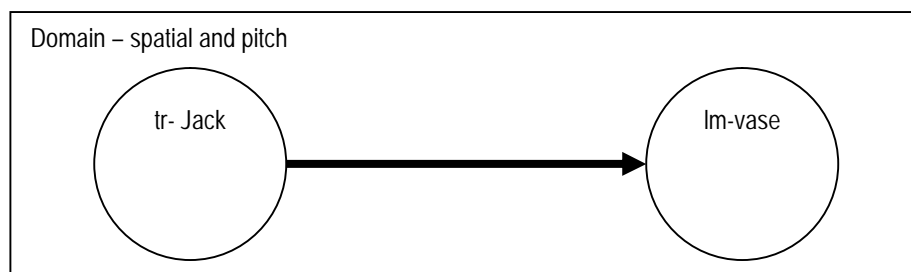

Figure 2: Schematic content image

The entities that are interconnected here are things that are prototypical of nouns, namely, ‘Jack’ and ‘vase’ that are of nominal predication by nature. These nominal function as the trajectory and landmark for the relational predications above. ‘Landmark’ refers to the entity construed as the referent point while ‘trajector’ refers to the entity located with respect to landmark (Langacker, 1990, pp.9-10).

Based on the proposed taxonomy of relational predication, Langacker (1990) highlights the rule that **a finite clause always profiles a process**. This indicates that all the sentences above are that of **processual predications**, involving **a series of relational configurations that extend through conceived time and are scanned sequentially** (Langacker, 1990) such as shown in the diagram below:

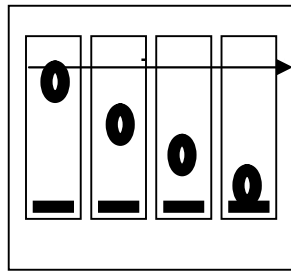

Figure 3: Processual predications

Of all the sentences given, only (a) and (d) feature the verb ‘smashed’ as a process. The verb ‘smashed’ found in (b), (c) and (e) is participial in nature and is of complex atemporal predication. Hence, we will start my analysis with the two sentences that feature “smashed” as verbs.

Comparison of Transitive and Intransitive Verbs

Consider these sentences:

- a) Jack smashed the vase
- d) The vase smashed

In both sentences above, the verb ‘smashed’ functions as the clausal verb that forms a finite clause. In explaining the differences between the two sentences, it is useful to adopt the pattern of semantic extension as posited by Cognitive linguists, where the **verb assumes a special semantic value** (Langacker 1990) and **can be construed in three different ways**. Therefore, ‘smashed’ in the context of the two sentences, (a) and (d) can be interpreted in three different ways below:

Jack smashed the vase

d) The vase smashed

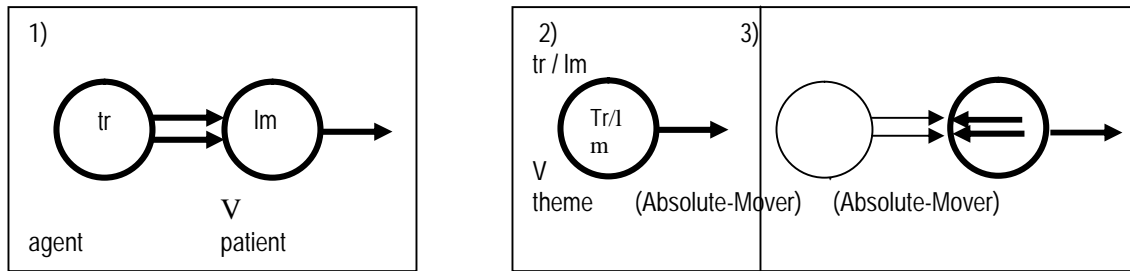

Figure 4: Verbs construed in three different ways

In sentence (a) above, the verb ‘smashed’ acts a transitive verb where ‘Jack’ functions as an agent/trajectory that applies force onto the landmark/object thus inducing its motion. In this context, we can see that the transitive verb ‘smashed’ impacts an object directly. A patient is prototypical for a direct object whereas an agent is prototypical for a subject. It is clear that in the sentence ‘Jack smashed the vase’; ‘vase’ functions solely as the landmark and ‘Jack’ takes on full responsibility of an agent.

In sentence (d), the verb ‘smashed’ acts as an intransitive verb. There are two interpretations to this sentence, it can be taken as self-inflicted or inflicted by an unknown agent. In (2), the image presents an absolute motion suggesting total lack of agent as well as lack of energy transmission. Note that the landmark shifts its prototypical function as a patient to accommodate the absence of the agent and instrument. According to Langacker, when ‘we conceptualize a process without reference to causation or energy transfer, it receives an absolute construal’, this is known as thematic process (1990: 30). Langacker posits that whenever the mover is profiled as the relational figure, it increases in saliency and will acquire an agent-like functionality.

However, Langacker posits that lexicon and grammar form a continuum of symbolic structures that contains **no sharp dichotomies based on generality, regularity, or analyzability** and, **while simplicity is good, we should be more concerned with psychological reality**. Thus, giving greater saliency to the object ‘vase’ would seem unnatural as it is an inanimate object. Therefore, by means of analyzability, the image schema in (3) would best describe sentence (d) where the existence of an agent is implied although it remains ‘unprofiled’.

The two sentences may not differ in content but they differ in the level of specificity where sentence (a) gives a full account of an event, sentence (d) backgrounds the agent. Assuming that both sentences are describing the same event, we would say that sentence (a) and sentence (d)

go beyond simple statements and be regarded as a great linguistic performance. Sentence (d) not only backgrounds the involvement of ‘Jack’ in the perceived incident successfully; it also manages to manipulate the use of intransitive verb to imply that the vase had smashed by itself. If the speaker intends to background Jack’s agentive role to gain profit or recognition from Jack, we would say that the speaker has performed a thoughtful linguistic maneuver.

Sentence (a) might be an innocent description but if the speaker foregrounds Jack’s role in the hope to background other details, such as to hide the fact that the speaker had also done something wrong and is trying to elude punishment, then, this speaker too, has displayed great cognitive ability through language. This proves the position of the cognitive grammarians that language use is closely linked to cognitive ability.

In conclusion, the difference between the two sentences here displays our cognitive ability to construe a perceived event in different perspectives and ability to decide level of specificity in which we wish to communicate by foregrounding and backgrounding certain participants in the conceived event.

Comparison of Active and Passive Structures

Consider again the following sentences:

- (a) Jack smashed the vase
- (b) The vase was smashed by Jack

Sentence (a) and (b) are both of processual predication. However, the construal of both events differs in terms of profiling. In (a), the trajectory (Jack) is profiled, whereas, in (b), it is the landmark (vase) that is profiled, hence distinguishing the subject and object in both sentences. Sentence (b) ‘The vase was smashed by Jack’ is a passive construction while sentence (a) ‘Jack smashed the vase’ is an active sentence. In both cases, the verbs used are that of perfective by nature.

Our use of language depends on what we want to express and how we choose to express it. In sentence (a), the speaker is highlighting Jack’s agentive role in relation to the condition of the vase. However, in sentence (b), Jack’s action of smashing the vase is construed as of secondary importance as compared to the state of the vase.

The diagrams below demonstrate the profiling of both processes:

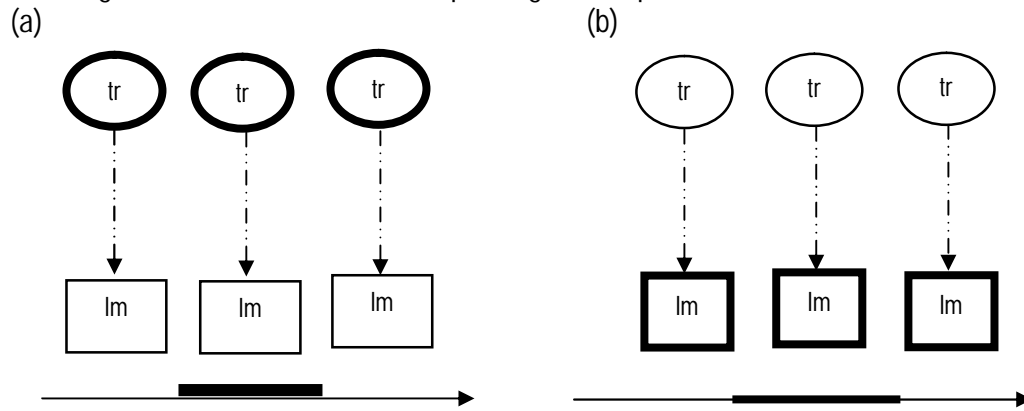

Figure 5: The profiling of both processes

As illustrated by the two diagrams, the composite structures of sentence (a) and sentence (b) look almost identical and differ only in terms of figure and ground relation. This shows that the actual content is exactly the same. The distinction lies in a matter of perspective and selection. There is no rule as to when a structure should or should not be used less in certain formalities. This explains the interest of the cognitive grammarians who seek to analyze linguistic expressions at its semantic value that reflects not only the content of a conceived situation but also how the content is structured and construed. This proves the notion that semantic structure is language specific, involving layers of conventional imagery. Another difference between these two sentences lies in the notion that grammatical structure is almost entirely overt. We will base my analysis on the two diagrams below:

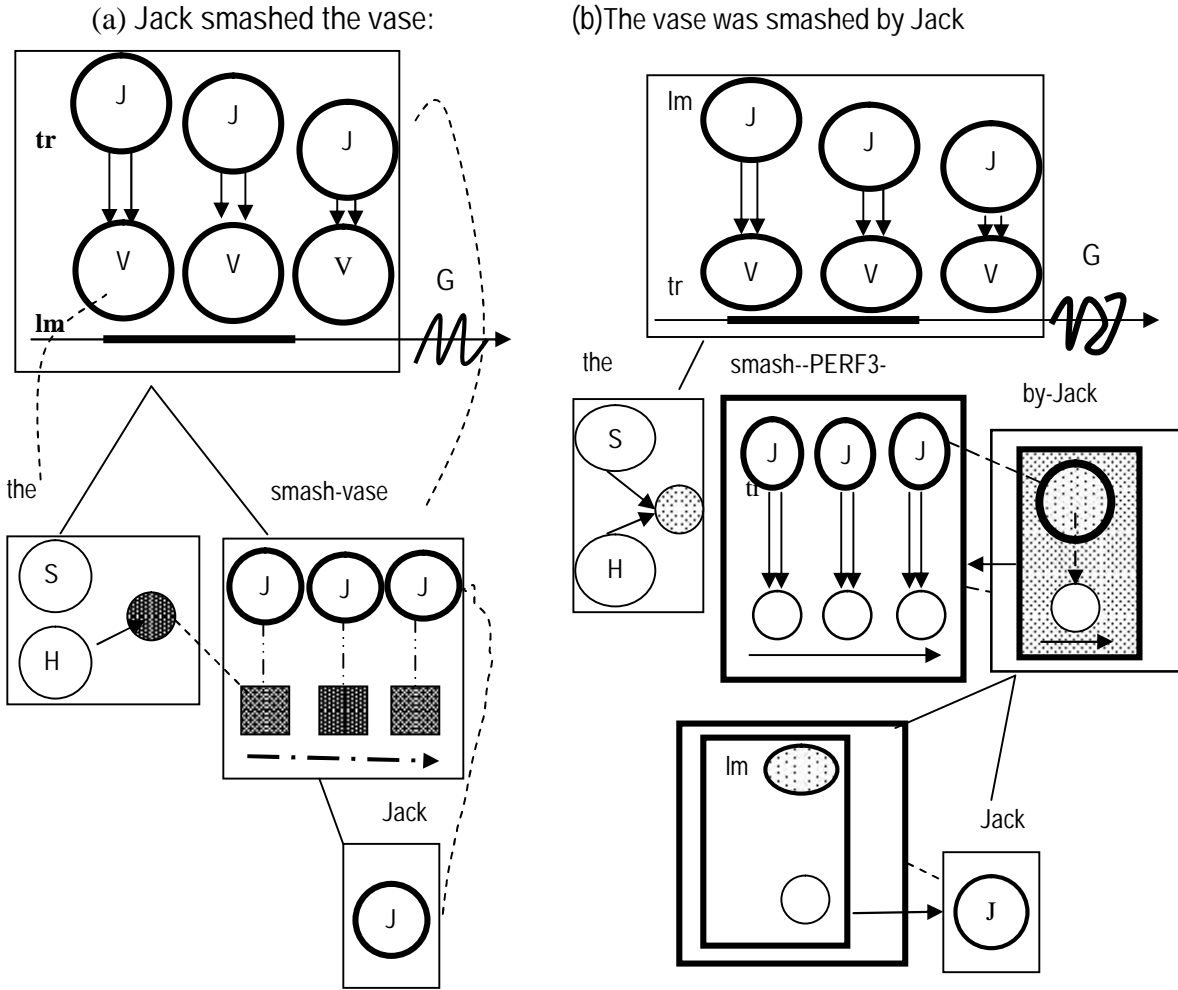

Figure 6: Entirely overt grammatical structure

Note that despite arriving at similar composite structures, meaning is achieved by means of two very different paths. Cognitive Grammar posits that schematic units and content units combine to make up composite structure to form syntactic structures; therefore, a passive structure is a structure in its own right.

The tree structure below illustrates how the composite structure of the passive construction (b) is formed and assumes that the active structure can be explained in the exact manner:

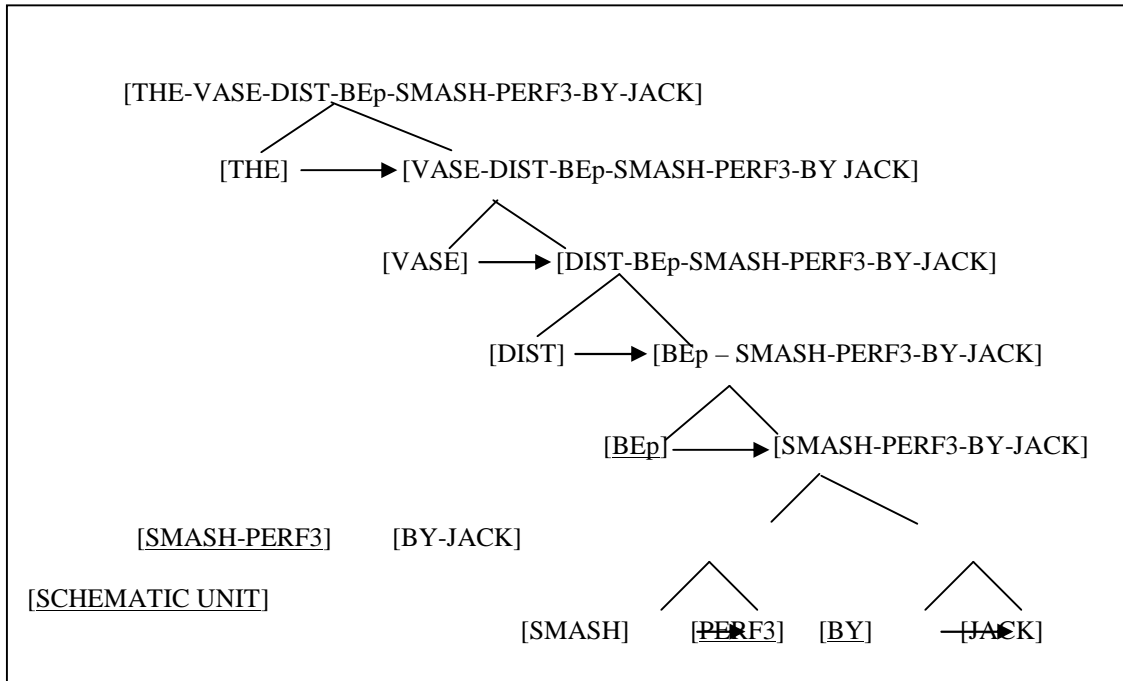

Figure 7: The composite structure of the passive construction

From the comparison of sentence (a) and (b), it can be concluded that our choice of structure depends on how we construe a perceived event and from which perspective we want to convey such information. It can also be said that the sentence structure of passive construction can be explained without the complexity of analysis that goes beyond the surface structure. Most importantly, highlighting the differences between the two structures helps us to distinguish subtle semantic distinctions between the two sentences. Thus, we can scientifically counter the notion posited by traditional linguists that the passive structure conveys exactly the semantic meaning of the active structure with reference to its deep structure.

Comparison of Perfective ‘smashed’ and Imperfective ‘be’

Observe the following sentences:

- a. Jack smashed the vase
- b. The vase was (be) smashed by Jack

The verb ‘smashed’ in (a) as pointed out earlier is a process and it functions as the clausal head that forms a finite clause. In sentence (a), the verb ‘smash’ is canonical and thus described as a perfective verb.

However, the verb ‘smashed’ in (b) is the participial [PERF3] that profiles a complex atemporal relation. Though it scans all the component states of a process, it captures them by means of a summary scanning thus adopting a complex atemporal relation. Hence the need for the verb ‘be’ to retemporalize the atemporal by means of imposing the sequential scanning of the process. Since [PERF3] functions as a passive construction that includes perfective verbs such as ‘smash’, the verb ‘be’ takes on a schematic role and is neutralized in terms of perfectivity. The diagram below illustrates how [PERF3] combines with [BEp] to form the participial ‘smashed’:

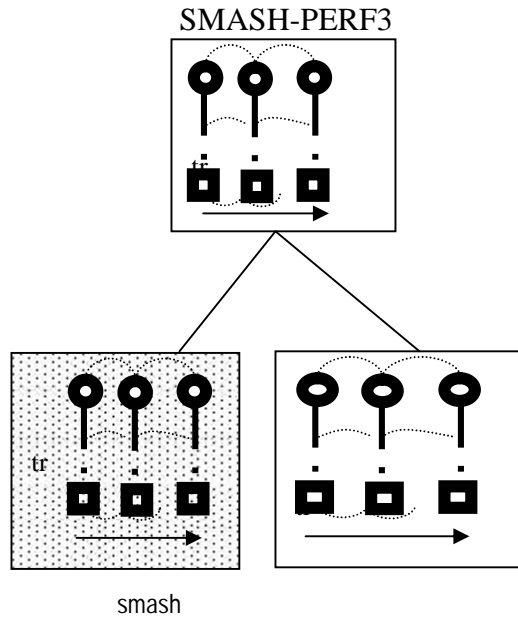

Figure 8: The combination

The tree diagram earlier shows how [BEp-smash-PERF3] + [by-Jack] helps in forming sentence (b). The indicator [DIST] helps to place the whole event within scope of predication as it specifies whether [BEp] should be replaced by ‘is’ or ‘was’. This reflects the meaningful semantic contribution of these morphemes. How then, do we determine the perfectivity of a passive construction? Since the [BEp] is neutralized, it takes on the perfectivity of the participle. Therefore, sentence (b) is perfective in orientation just as that of sentence (a) and can be represented by the diagram below:

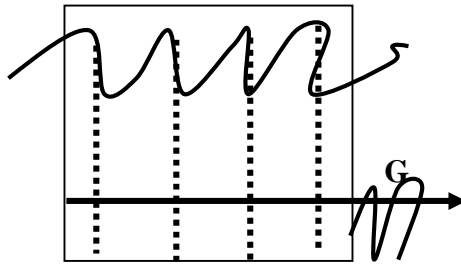

Figure 9: Sentence imperfective orientation

To conclude, although the verb ‘be’ is prototypical of the imperfective verbs, the passive construction renders it neutral, thus allowing the perfectizing of the imperfective ‘be’. This is why the cognitive linguists noted that syntax is not autonomous but rather symbolic in nature.

Comparison of ‘is smashed’ and ‘was smashed’

Finally, consider these sentences:

- (c) The vase was smashed
- (e) The vase is smashed

The verb ‘smashed’ in the sentences above is also participial in nature. The participial ‘smashed’ in (c) and (e) is of [PERF1]. It profiles a final state in the process of ‘smash’. Therefore, it profiles a stative relation and it takes on the function of an adjective. Thus, ‘the vase is smashed’ can be equated to sentences such as ‘the vase is nice’ as both sentences are descriptive in nature. What [PERF1] does here is rather schematic and it proves that the human cognition is able to transform one conceptual structure into another. Just like the schematic process of the [ER] predicate that transforms a process into a thing (as in ‘smash’ to ‘smasher’), a schematic process for a [PERF1] predicate is to transform process into state. Hence, the process ‘smash’ is turned into a resultant state ‘smashed’ that can be equated to ‘nice’ that is adjectival in function. The diagram below is suggested by Langacker to describe [PERF1] sentences such as ‘The vase is smashed’:

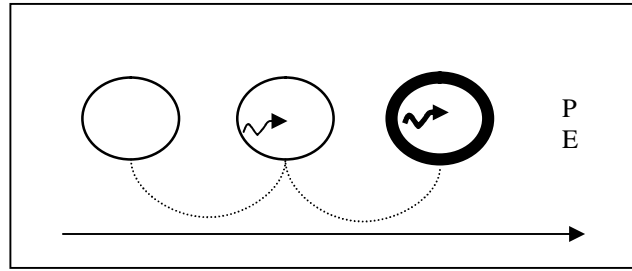

Figure 10: [PERF1]

Langacker (1990, p.136) also posits that the verb ‘be’ is a schematic imperfective process. Assuming that the both sentences feature ‘smashed’ as adjectives, it would be logical to assume that both sentences are imperfectives since ‘be’ acts as the verb stem for both sentences. The following diagrams can represent the imperfective orientation.

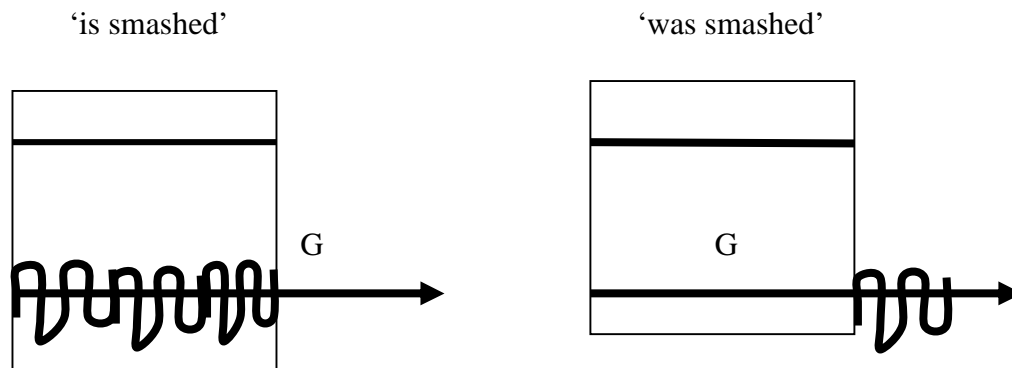

Figure 11: Imperfective orientation

CONCLUSION

Most fundamentally, Cognitive Grammar makes contact with discourse through the basic claim that all linguistic units are abstracted from usage events, i.e., actual instances of language use (Langacker, 2001, p.244). From the above analysis, we can conclude that these sentences have the same content image; however, each sentence is semantically distinct from each other in many ways. The most apparent differences are that of how one construes a conceived situation. These sentences differ in how the entities are foregrounded and backgrounded. Level of specificity also plays an important role in deciding a particular construal of an event. We can be very specific or ambiguous to suit our purpose. The way we speak also

reflects how we conceptualize certain events; we tend to give more saliency to the object of our interest thus rendering the importance of other entities as secondary. Profiling the focal selection our interest is normal. We can also adopt a passive construction if we want to highlight the landmark instead of the trajectory or if we decide to be ambiguous.

Analyzing the sentences above can also help us to understand the ideas posited by the cognitive linguists; it helps clarify grey matters such as in deciding the perfectivity or imperfectivity of a verb. It also illustrates the position of cognitive grammarians that linguistic expression is closely related to thought and meaning. We can also identify the semantic contributions of lexical items such as 'be', 'by' and inflections, such as -ed in participles. Cognitive grammar explains issues in grammar by means of image schemas and logical thinking. It also encourages us to analyze the lexicon as a continuum; therefore, it gives better insight especially in cases where there is ambiguity and lack of specificity. We would also say that since sentence (d) is the most abstract, it is the most general and it can also be a schematic representation of the rest of the sentences.

THE AUTHORS

Seng Tong Chong is a faculty member at UNITEN. His research interests are in literary linguistics and comparative literature.

Yu Jin Ng teaches at UNITEN. His research areas are in corpus linguistics and English for specific purposes.

Noor Azam Abdul Rahman is a theoretical linguist. Currently he heads the department of languages and social sciences, UNITEN.

ZalinaMohd.Kasim is lecturer at University Putra Malaysia. She works on cognitive linguistics.

REFERENCES

- Ellis, R. (2009). Grammar teaching – Practice or consciousness-raising? In J.C. Richards & W.A. Renandya (Eds.), *Methodology in language teaching: An anthology of current practice* (pp. 167 – 174). Cambridge: Cambridge University Press.
- Harmer, J. (2007). *How to teach English*. Essex, UK: Pearson Longman.
- Langacker R.W. (1986). An introduction to cognitive grammar. *Cognitive Science*, 10, (pp1-40).
- Langacker, R.W. (1990). *Concept, Image and Symbol: the cognitive Basis of Grammar* Berlin, Germany: Mouton de Gruyter.
- Langacker, R.W. (1999). *Grammar and Conceptualization*. Berlin, Germany: Mouton de Gruyter.
- Langacker, R.W. (1987). *The foundations of cognitive grammar: Volume I: Theoretical Prerequisites*. Stanford, CA: Stanford University Press

- Langacker, R.W. (2001). Discourse in cognitive grammar. *Cognitive Linguistics* 12(2), 143-188.
- Richards, J.C. (2009). Addressing the grammar gap in task work. In J.C. Richards & W.A. Renandya (Eds.), *Methodology in language teaching: An anthology of current practice* (pp. 153 – 166). Cambridge: Cambridge University Press.
- Swan, M. (2009). Seven bad reasons for teaching grammar – and two good ones. In J.C. Richards & W.A. Renandya (Eds.), *Methodology in language teaching: An anthology of current practice* (pp. 148 – 152). Cambridge: Cambridge University Press.