

## Measurements of the time-dependent specific heat of amorphous materials

M. T. Loponen, R. C. Dynes, V. Narayanamurti, and J. P. Garno

*Bell Laboratories, Murray Hill, New Jersey 07974*

(Received 15 July 1981)

The time dependence of the specific heat of several amorphous materials, such as  $\alpha$ -SiO<sub>2</sub>,  $\alpha$ -As<sub>2</sub>S<sub>3</sub>, and  $\alpha$ -As, has been studied in the temperature range 0.1–1 K. It is found that below 0.3 K in all the materials studied the short-time specific heat at about 10  $\mu$ sec is considerably smaller than the long-time specific heat, but larger than the Debye value. Above 0.3 K most of the specific heat is coupled to the phonons already at 10  $\mu$ sec. However, measurements at very long time scales reveal that the specific heat has a component with a logarithmic time dependence, as proposed by the tunneling model, although only part of the total specific heat can be ascribed to it.

### I. INTRODUCTION

The thermal properties of glasses differ remarkably from those of crystalline materials at low temperatures. The specific heat is larger than the Debye value, and the thermal conductivity is orders of magnitude lower than in crystals.<sup>1</sup> Below 1 K the specific heat shows a quasilinear temperature dependence,  $C \propto T^\alpha$ , with  $\alpha$  varying from 1.2 to 1.5. The thermal conductivity becomes proportional to  $T^2$ . In crystals both the specific heat and the thermal conductivity are proportional to  $T^3$  at low temperatures.

To explain the excess specific heat and the thermal conductivity, it was proposed by Anderson *et al.*<sup>2</sup> and by Phillips<sup>3</sup> that the glasses have tunneling excitations with a wide distribution of relaxation times and energies. The existence of two-level systems in glasses has been established with various ultrasonic experiments,<sup>4,5</sup> but it has not been possible to determine the actual physical nature of these systems or the structure of the relaxation-time spectrum.

A consequence of the tunneling model would be time-dependent specific heat. In a specific-heat measurement the tunneling states couple into the phonons gradually. Thus the phonon temperature after a heat pulse decreases as a function of time as more energy is absorbed into the tunneling states. For a uniform distribution of tunneling states, the effective specific heat should depend logarithmically on time.

There have been several attempts to measure the specific heat at fast time scales. Goubau and Tait<sup>6</sup> studied amorphous SiO<sub>2</sub> (G.E. No. 101) and a plastic [polymethylmethacrylate (PMMA)] on time

scales of the order of 100  $\mu$ sec. Both the maximum temperature increase for a given heat pulse and the diffusivity were measured and employed in the determination of the specific heat. On this time scale, a reduction of 20–40% was found in the specific heat of an  $\alpha$ -SiO<sub>2</sub> sample around 0.8 K. At lower temperatures, however, the reduction disappeared in disagreement with the theory. Later the experiment was repeated by Kummer *et al.*<sup>7</sup> on amorphous SiO<sub>2</sub> (Suprasil W) on submicrosecond time scales. Owing to the experimental technique, only the diffusivity was measured. Only a small reduction in the diffusion time was observed, instead of the expected order-of-magnitude effect at 0.1 K. Also Lewis and Lasjaunias<sup>8</sup> have studied the diffusion of heat pulses in glasses, without finding a definite indication of time-dependent specific heat.

To obtain information on the fast-time behavior of the specific heat in amorphous materials, we have performed direct specific-heat measurements on time scales 10  $\mu$ sec–100 msec. Some of the results have been briefly reported in Ref. 9. In addition to results on  $\alpha$ -SiO<sub>2</sub> and crystalline Ge, we also present data for  $\alpha$ -As<sub>2</sub>S<sub>3</sub> and  $\alpha$ -As for purposes of comparison. In addition to the short-time measurements, we have also made very-long-time thermal relaxation measurements<sup>10</sup> (up to 10<sup>4</sup> sec) to obtain a full picture of the time dependence of the specific heat.

The paper is divided into five sections. The tunneling model is discussed in Sec. II. In Sec. III we describe the experimental technique, and the results are given in Sec. IV. The consequences of the experimental data are considered in Sec. V. We also include an appendix, where heat-pulse data on iron-doped Pyrex glass is analyzed.

## II. THE PREDICTIONS OF THE TUNNELING MODEL

According to current models, the low-temperature properties of glasses are a result of a distribution of tunneling states. A tunneling state consists of an atom or a group of atoms in a double-well potential. The eigenstates of the system are separated by

$$E = (\Delta^2 + \Delta_0^2)^{1/2}, \quad (1)$$

where  $\Delta$  is the asymmetry of the wells, and  $\Delta_0$  is the coupling energy,  $\Delta_0 = E_0 \exp(-\lambda)$ , where  $E_0$  is the zero-point energy and  $\lambda$  is the tunneling parameter, related to the tunneling barrier height and thickness. The transition from one state to the other occurs by emission or absorption of a phonon of energy  $\hbar\omega = E$ . The relaxation rate of the excited state is<sup>2,3,11,12</sup>

$$r = \left[ \frac{\gamma_l^2}{v_l^5} + 2 \frac{\gamma_t^2}{v_t^5} \right] \frac{E^3}{2\pi\rho\hbar^4} \exp\{-2[\lambda - \lambda_{\min}(E)]\} \times \coth \left[ \frac{E}{2k_B T} \right]. \quad (2)$$

The deformation potential coupling energy is denoted by  $\gamma$  ( $l$  and  $t$  are for longitudinal and transverse phonons, respectively), and  $\lambda_{\min}(E)$  is the smallest possible value of  $\lambda$  for a given  $E$ . This is the case for symmetric wells ( $\Delta = 0$ ).

It is further assumed that the distribution of the tunneling states is uniform in  $\Delta$  and  $\lambda$ , i.e.,

$$P(\Delta, \lambda) d\Delta d\lambda = \bar{P} d\Delta d\lambda. \quad (3)$$

Expressed in terms of energy  $E$  and relaxation rate  $r$ , the density of states becomes<sup>11</sup>

$$\bar{P} d\Delta d\lambda = P(E, r) dE dr = \frac{(\bar{P}/2) dE dr}{r(1 - r/r_{\max})^{1/2}}, \quad (4)$$

where  $r_{\max}$  is the rate corresponding to  $\lambda = \lambda_{\min}$ . It can be seen that for times  $t \gg r_{\max}^{-1}$  the time dependence of the integral of  $P(E, r)$ , from  $1/t$  to  $r_{\max}$ , is proportional to  $\log t$ . In this limit the excess specific heat  $C_1(t)$  due to the tunneling states is given by<sup>12</sup>

$$C_1(t) = \frac{\pi^2}{12} \bar{P} k_B^2 T \log_{10}(4r_{\max} t). \quad (5)$$

The thermal conductivity is determined by the inverse mean free path  $l^{-1}$  of the phonons<sup>2,3,11,12</sup>:

$$l_{l,t}^{-1}(E) = (\pi E / \hbar \rho v_{l,t}^3) \bar{P} \gamma_{l,t}^2 \tanh(E/2k_B T). \quad (6)$$

The  $T^2$  law for the thermal conductivity follows from the linear  $E$  dependence of  $l^{-1}$  for  $E > 2kT$  and from the  $T^3$  specific heat of the Debye phonons that carry the heat.

From ultrasonic experiments<sup>13</sup> it has been determined that for  $a$ -SiO<sub>2</sub> Suprasil W,  $\gamma_l = 1.6$  eV,  $\gamma_t = \gamma_l/1.5$ , and  $\bar{P} = 2.1 \times 10^{38} \text{ J}^{-1} \text{ cm}^{-3}$ . However, there is considerable variance in the experimental results, and the value of  $\bar{P}$  is uncertain. Thermal conductivity is consistent<sup>12,13</sup> with the value  $\bar{P} = 3.2 \times 10^{38} \text{ J}^{-1} \text{ cm}^{-3}$ . One result suggests even<sup>4</sup>  $\bar{P} = 6.9 \times 10^{38} \text{ J}^{-1} \text{ cm}^{-3}$ , in considerable disagreement with the thermal conductivity. In Fig. 1 we plot the predicted time-dependent specific heat  $C(t) = C_1(t) + C_D$  scaled with the measured specific heat at  $t = 1$  sec [ $C(1 \text{ sec})$ ] for Suprasil W at 0.1 and 0.4 K as a function of  $\log t$  using these three values of  $\bar{P}$ . The long-time specific-heat measurements are usually done in the time scale of 1–100 sec. The calculated curves, however, do not reach the experimentally observed values until much longer time scales. The only exception is the curve for the abnormally large value of  $\bar{P} = 6.9 \times 10^{38} \text{ J}^{-1} \text{ cm}^{-3}$ .

In electric echo measurements<sup>14</sup> it has been found that for  $a$ -SiO<sub>2</sub> with high OH concentrations, there exist two sets of tunneling states with different  $\gamma$ 's. This does not change Fig. 1 significantly, and the discrepancy between the experimen-

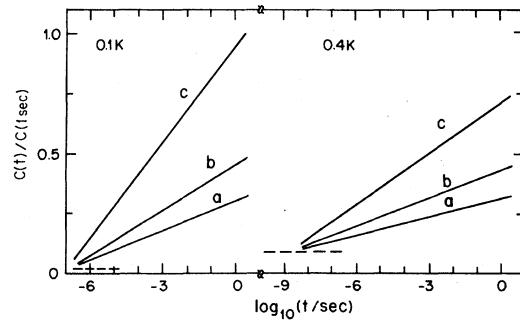

FIG. 1. Ratio of the calculated time-dependent specific heat to the measured long-time specific heat at  $t = 1$  sec,  $C(t)/C(1 \text{ sec})$  as a function of  $\log_{10} t$  for  $a$ -SiO<sub>2</sub> Suprasil W at the temperatures of 0.1 and 0.4 K. The curves are calculated from the tunneling model [ $C(t) = C_D + C_1(t)$ ] with Eq. (5) using  $\gamma_l = 1.5\gamma_t = 1.6$  eV and  $\bar{P} = 2.1 \times 10^{38} \text{ J}^{-1} \text{ cm}^{-3}$  (a),  $3.8 \times 10^{38} \text{ J}^{-1} \text{ cm}^{-3}$  (b), and  $6.5 \times 10^{38} \text{ J}^{-1} \text{ cm}^{-3}$  (c). The dashed lines show  $C_D/C_L$ .

tal values of  $\gamma$  and  $\bar{P}$  and between the long-time specific heat remains.

When compared to experiments, the original tunneling model can describe most of the observations qualitatively, but on a quantitative basis the agreement is not as good. The excess specific heat does not behave exactly as  $T$  at low temperatures, but rather as  $T^\alpha$  with  $\alpha = 1.2 - 1.5$ .<sup>15-17</sup> At temperatures above about 0.5 K the specific heat is larger than the low-temperature extrapolation. It has been customary<sup>1,18</sup> to fit the data with a polynomial,  $C = \tilde{C}_3 T^3 + \tilde{C}_1 T$ , but this may be misleading since in several cases its validity is limited between 0.1 and 0.7 K. In thermal conductivity, the agreement with theory is much better. The experimental temperature dependence at low temperatures is  $T^\beta$  with  $\beta = 1.8 - 1.95$ ,<sup>1,15,13,19</sup> not far from the predicted value of 2. At a few degrees the thermal conductivity saturates (the "plateau"). No satisfactory explanation has so far been given to this phenomenon.

To improve the agreement with experiment, it has been proposed that the density of states is weakly energy dependent,  $P(E) = \bar{P} + \eta E^2$ . Originally this modification was introduced to explain the sound velocity data.<sup>20</sup> Later it was extended to interpret also the  $T^3$  excess specific heat and the plateau in thermal conductivity.<sup>21,22</sup> We shall see later that in spite of the apparent success of this modification, the tunneling model alone possibly cannot describe all the excess specific heat.

Black<sup>12</sup> has speculated that in addition to the standard states discussed above, there are also "anomalous" states with  $\lambda = \lambda_a$ . These states would have a density of states

$$n_a = P_a [1 - (\Delta_{a0}/E)^2]^{-1/2}, \quad (7)$$

and phonon mean free path ( $\alpha = l, t$ )

$$l_{a,\alpha}^{-1} = \frac{\pi E}{\hbar \rho v_\alpha^3} n_a(E) \gamma_{a,\alpha}^2 \left[ \frac{\Delta_{a0}}{E} \right] \tanh \left[ \frac{E}{2k_B T} \right]. \quad (8)$$

The subscript  $a$  refers to the parameters of the anomalous states. The phonon mean free path does not have the correct frequency dependence, and therefore the coupling of these states to the phonons must be much weaker than that of the "fastest" [ $\lambda = \lambda_{\min}(E)$ ] tunneling states. Recently, Cohen and Grest<sup>23</sup> have proposed an essentially similar modification to the density of states, starting from their free-volume model.

### III. EXPERIMENTAL TECHNIQUE

We have studied the short-time behavior of the specific heat directly by measuring the temperature of the sample after a known heat pulse. A flat, thin sample of the material to be studied was mounted on four glass-fiber posts, as shown in Fig. 2. A thin gold film heater was evaporated uniformly on one side of the square sample, to cover as much of the surface as possible so as to ensure uniform heating. The superconductor-oxide-normal-metal thin-film tunnel-junction thermometer was made on the opposite side.

In the specific-heat measurement, the tunnel junction was biased with constant current in the nonlinear region of the  $I$ - $V$  curves below the current rise at the superconducting energy gap. The bias voltage was then a function of temperature. The electron-phonon interaction is sufficiently strong in the metal films, so that on this time scale, the electron temperature follows the phonon temperature. A measurement of the electron temperature, then, is a good measure of the phonon temperature. A short heat pulse  $\Delta Q$  was now applied to the heater. In case of no time dependence in the specific heat,  $C_L$ , the decay of the temperature increase  $\Delta T_0(t)$  should relax exponentially after the initial heat diffusion across the sample, i.e.,

$$\Delta T_0(t) = \Delta T_0 \exp(-t/\tau), \quad (9)$$

where  $\Delta T_0 = \Delta Q / m C_L$  (the instantaneous temperature rise at  $t=0$ ), and  $\tau$  is given by  $m C_L / K$ ;  $m$  is the mass of the sample and  $K$  is the thermal conductance of the glass-fiber posts. However, when the specific heat is time dependent, the temperature increase  $\Delta T(t)$  in the beginning of the relaxation is

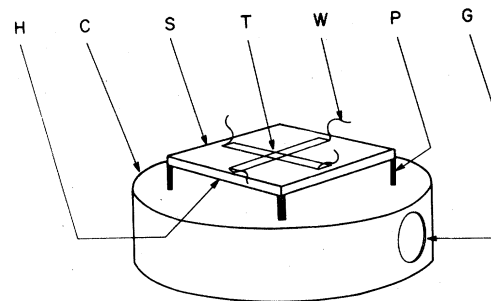

FIG. 2. Experimental setup.  $H$ : heater (at the bottom of the sample);  $C$ : copper block;  $S$ : sample;  $T$ : tunnel junction;  $W$ : wire;  $P$ : glass-fiber post;  $G$ : germanium resistor.

larger than that given by Eq. (9), since all the states do not couple into the measurement immediately. This overshoot of  $\Delta T(t)$  above the exponentially decaying temperature increase  $\Delta T_0(t)$  is interpreted as an indication of a time-dependent specific heat  $C(t)$ . The instantaneous value of  $C(t)$  is given by  $C(t) = C_L \Delta T_0(t) / \Delta T(t)$ . At long time  $\Delta T(t)$  is found to behave according to Eq. (9), as shown in Fig. 3. There the relaxation of  $\Delta T(t)$  is shown for two temperatures at long time scales. The data is from the measurements with the  $\text{SiO}_2$  sample (see Sec. IV). It must be pointed out, however, that a small logarithmic time dependence in the specific heat causes negligible deviation from exponentiality. Even for the curves  $c$  in Fig. 1 the deviation would hardly exceed the experimental accuracy. This is due to the fact that as  $C(t)$  increases,  $\Delta T(t)$  decreases and  $\tau$  increases. These two changes tend to cancel each other to some degree.

The shortest time scale of the measurement is limited by the diffusion time of the heat pulse across the sample. This sets limits on the thickness of the sample and consequently on the total heat capacity. Since only relatively thin samples can be used, the addenda must be kept small. In our case, both the thermometer and heater were thin nonmagnetic metal films. The leads (superconducting SnIn, 0.05 mm in diameter) were at-

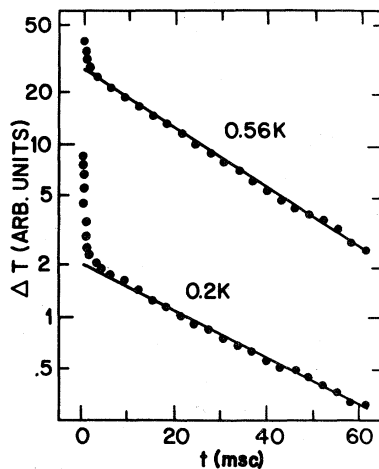

FIG. 3. Exponential behavior of  $\Delta T(t)$  at long time scales. The data is taken from the measurements on  $\alpha\text{-SiO}_2$ . The time constant is determined by the heat capacity of the sample and the thermal conductance of the posts. The exponential decay extrapolates to  $\Delta T_0 = \Delta Q / C_L$  at zero time, from which the long-time heat capacity  $C_L$  can be determined.

tached to the sample with tiny amounts of epoxy. Contact between the films and these wires was made by carefully scraping the epoxy from the top of the wire and evaporating the films directly onto this region. The sample was glued with a very small amount of epoxy to four glass-fiber posts (0.2 mm in diameter, 1 mm long). A calibrated Ge thermometer was attached to the sample holder, which was located inside a separate vacuum chamber in the cryostat.

The most reliable way to make the heater was to evaporate first a thin (100 Å) gold film; thereafter thicker narrow contact gold strips were evaporated along the two sides of the square sample.

The tunnel junction ( $\sim 0.2 \text{ mm}^2$  in size) was of Al- $\text{Al}_2\text{O}_3$ -Ag for experiments at temperatures below 1 K, and of Al- $\text{Al}_2\text{O}_3$ -Pb at higher temperatures. Typical junction resistance was 10  $\Omega$  in the normal state. Much higher resistances ( $\sim 1 \text{ k}\Omega$ ) limited the response time of the junction to the RC time and much smaller ones (1 m $\Omega$ ) caused too much self-heating. Typically, the power dissipated in these thermometers was  $\sim 5 \text{ pW}$  at 0.1 K and  $\sim 500 \text{ pW}$  at 1 K.

The response of the tunnel junction to the heat pulse was detected as a change of the bias voltage. The signal was first amplified with a PAR 113 preamplifier (when necessary a faster amplifier was used) and digitized with a Biomation 8100 transient recorder. On the order of 1000 measurements were collected in a Nicolet 1070 signal averager. The temperature increase due to the heat pulse was varied from 0.1 mK to 0.1 K. This very low  $\Delta T_0$  was possible because of the high sensitivity of the junction ( $\sim 20 \mu\text{V/K}$  typically).

While testing various arrangements for this experiment, it was found that spurious effects could result for several reasons. Use of Constantan (an alloy with a high density of spins) as a heater increased the specific heat<sup>24</sup> even at short time scales at low temperatures. Considerable time dependence in  $\Delta T(t)$  was also ascribed to the high specific heat of silver paste, which was used early in the experiment to attach the leads. It was subsequently avoided and the epoxy technique described above was adopted. It was also found that when pencil graphite rather than glass fiber was used as support posts, spurious results were obtained.

A particularly annoying problem was caused by nonuniform heating of the sample. However, the overshoot in  $\Delta T(t)$  arising from this source could be separated from the real time-dependent specific

heat, since its magnitude was constant as a function of temperature and its relaxation time scaled with the diffusion time. Therefore, when the temperature is increased to about 4 K, all the time dependence in the specific heat is masked by the long diffusion time of the heat pulse across the sample, but the purely geometrical effect due to nonuniform heating remains although its time scale, determined by the transverse diffusion time, also gets longer. Some samples were also fabricated by epoxying sapphire plates to the glass plate, thus altering the thermal relaxation time in the lateral direction. Comparing these experiments, it was possible to separate the real time dependence from experimental artifacts.

Another possible source of error was due to the epoxy used to attach the wires. Although its magnitude was kept as small as possible, it still might have given an erroneous overshoot in  $\Delta T(t)$  of a few tens of percent in the worst case. The relaxation time for this overshoot is roughly similar to that due to nonuniform heating, since the epoxy drops were close to the edges of the samples. The magnitude of the overshoot in  $\Delta T(t)$  is proportional to  $m_e C_e / m C_L$ , where the subscript  $e$  refers to the epoxy. We have measured the specific heat of the epoxy (Stycast 1266) separately. It resembles that of glasses, as can be expected, and therefore the ratio  $C_e / C_{\text{tot}}$  is not a strong function of temperature. Thus, the same procedure used to correct for the nonuniform heating was also used to correct for the effects of the epoxy.

At very long time scales the relaxation of the specific heat can be studied by connecting the sample loosely to the thermal bath and monitoring the relaxation of the sample temperature. This measurement was first performed on glasses by Zimmermann and Weber.<sup>10</sup> Our measurement at very long time scales was performed as follows. The sample with mass  $m$  was connected to the mixing chamber of a dilution cryostat with a thermal link which had a conductance  $K$ . A heater and a thermometer were attached to the sample. Using the heater the sample temperature was increased to  $T_i$ , above the equilibrium temperature  $T_0$ . After equilibrium was reached, the heating was stopped. If the specific heat were not time dependent, the relaxation of the sample temperature would be exponential, with the time constant  $\tau$  given by  $m C_L / K$  (note that in this experiment  $\tau$  is orders of magnitude longer than in the short-time experiment, and now also the measurements are done at times much greater than  $\tau$ ). However, when the

specific heat depends on time, there is energy release from the relaxing excitations, and consequently the decay of the temperature is nonexponential. The temperature difference  $\Delta T(t) = T(t) - T_0$  is given by<sup>10</sup>

$$\Delta T(t) = \Delta T_1(t) + \Delta T_2(t), \quad (10)$$

where

$$\Delta T_1 = K^{-1} \int_{T_0}^{T_i} m [dC(t)/dt] dt,$$

and

$$\Delta T_2 = -m C_L K^{-1} dT(t)/dt.$$

The first term is due to the time dependence of the specific heat and the second is caused by the cooling of the sample. The tunneling model predicts that<sup>10</sup>

$$\Delta T_1(t) = K^{-1} \frac{\pi^2}{24} V \bar{P} k_B^2 (T_i^2 - T_0^2) t^{-1}. \quad (11)$$

Thus the temperature difference  $\Delta T_1(t)$  gives directly the density of the tunneling states,  $\bar{P}$ , independent of the coupling constant  $\gamma$ .

In our measurement the sample was supported by eight glass-fiber posts, 5–10 mm long. The thermometer also in this measurement was an Al-Al<sub>2</sub>O<sub>3</sub>-Ag tunnel junction. The superconducting transition temperature of the thermometer limited the range of  $T_i$  below  $\sim 1.2$  K. To eliminate dc drift the tunnel junction was monitored with an ac bridge. The measuring current was typically 0.1  $\mu\text{A}_{\text{rms}}$  at 500 Hz. The balance of the bridge was followed with a PAR 124A lock-in amplifier. The accuracy of the measurement was determined by drifts which corresponded to a temperature uncertainty of less than 0.05 mK.

## IV. EXPERIMENTAL RESULTS

### A. *a*-SiO<sub>2</sub>

Amorphous silica is one of the most widely studied amorphous materials. Unfortunately, it also exists as a variety of types, differing in impurity concentration. It has a large excess specific heat, extending to temperatures above 1 K. Stephens<sup>18</sup> fitted his specific heat data of amorphous silica (Vitreosil) to  $\bar{C}_1 T + \bar{C}_3 T^3$  with  $\bar{C}_1 = 1.2 \mu\text{J/g K}^2$  and  $\bar{C}_3 = 1.8 \mu\text{J/g K}^4$ . The  $T^3$ -dependent part of the specific heat is considerably larger than the Debye specific heat  $C_D = 0.8 T^3 \mu\text{J/g K}^4$ . Later Lasjaunias *et al.*<sup>16</sup> extended the

measurement with Suprasil W and Suprasil to 0.025 K, and found the polynomial fit inadequate. Rather the excess specific heat was proportional to  $T^\alpha$  with  $\alpha \approx 1.3$  below 0.5 K. At higher temperatures the temperature dependence was increased. In Suprasil the behavior of  $C(T)$  between 0.5 and 1 K seemed to approximate a  $T^2$  temperature dependence, but in Suprasil W an additional Schottky-type anomaly of unknown origin (with  $\Delta/k_B \sim 4.3$  K) was found to increase  $C(T)$  around 1 K.<sup>17</sup>

We have studied Suprasil W (manufactured by Heraeus-Schott, Germany) which has a negligible OH concentration. For the short-time measurement the sample was 0.21 mm thick and  $6.4 \times 6.4$  mm<sup>2</sup> wide, weighing 0.183 g. It was cut from the same piece of glass as the samples used by Golding *et al.*<sup>13,14</sup> for ultrasonic experiments. Some of the results have previously been discussed in Ref. 9. For comparison we also studied a sample of  $\alpha$ -SiO<sub>2</sub> with a high (1500 ppm) OH concentration, Suprasil II, at temperatures around 1.5 K.

The experimental long- and short-time specific heats the Suprasil W are shown in Fig. 4. The

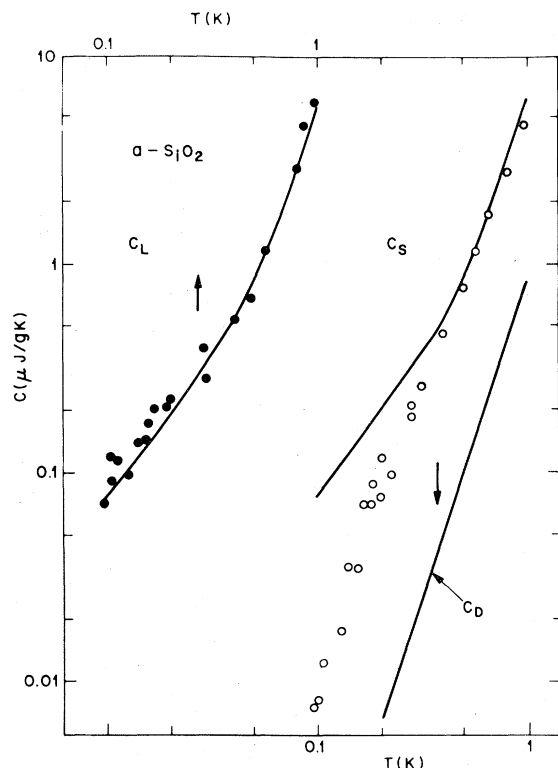

FIG. 4. Long-time specific heat  $C_L$  (left-hand side) and the short-time specific heat  $C_S$  (right-hand side) of the  $\alpha$ -SiO<sub>2</sub> (Suprasil W) sample (0.0184 g). The upper solid line shows the long-time specific heat of Lasjaunias *et al.* (Ref. 16), and  $C_D$  is the Debye specific heat.

long-time specific heat  $C_L$  is determined from  $\Delta Q/\Delta T_0$  by extrapolating the long time exponentially decaying signal to zero time from the time scale of 5 to 50 msec (see Fig. 3). It agrees reasonably well with the measurement of Lasjaunias *et al.*<sup>16</sup> However, due to the finite accuracy of the measurement, the data should not be interpreted to indicate the nonexistence of any time dependence above 10 msec. Since there is already a difference of 10% between the two long-time specific-heat measurements on Suprasil W,<sup>16,17</sup> it is clear that the  $C_L$  data cannot be used to rule out a weak time dependence in the specific heat at long times. That this is the case will be clear from the very-long-time data to be presented later.

The short-time specific heat  $C_S$  is calculated with the peak value of  $\Delta T(t)$ , obtained after the initial heat diffusion across the sample at about 15  $\mu$ sec. The  $C_S$  data shown in Fig. 4 is obtained by multiplying the specific-heat values of Lasjaunias *et al.*<sup>16</sup> by the experimental ratio  $\Delta T_0/\Delta T_{\max}$ . The effect of nonuniform heating is corrected by multiplying the  $C_S$  value by a constant factor of 1.5. In Ref. 9 this correction was not done, and consequently the  $C_S$  values were somewhat too small.

At all temperatures the short-time specific heat is considerably larger than the Debye value. It seems to follow approximately a  $T^3$  temperature dependence. However, below 0.2 K, where the decoupling is largest, the data perhaps indicate an even stronger temperature dependence.

In Suprasil W, the actual overshoot in  $\Delta T(t)$  due to the time dependence of the specific heat is about 15% at 1.5 K. It relaxes with a time constant of about 100  $\mu$ sec. As the temperature is lowered, the overshoot remains about the same or even decreases, until below 0.3 K the decoupling at short times starts rapidly increasing. At 0.1 K about 90% of the specific heat is decoupled at 15  $\mu$ sec. The sample of Suprasil II showed no overshoot in  $\Delta T(t)$  at 1.5 K. In particular it can be stated that with an accuracy better than 5% there is no exponentially decaying part in  $\Delta T(t)$  which would have a time constant of the order of 100  $\mu$ sec.

To study the time dependence of  $C(t)$ , we plot the line shape measured at 0.1 K in two ways. The raw data is shown in Fig. 5. It has to be corrected to compensate for the overshoot due to the nonuniform heating. There is some uncertainty in the time dependence of this artifact at 0.1 K, but the effect is small enough so that it does not affect the conclusions. In Fig. 6(a) we have plotted

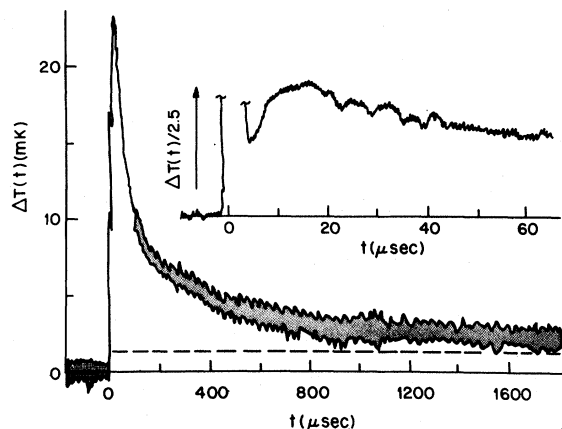

FIG. 5. Fast-time temperature response  $\Delta T(t)$  at 0.1 K measured on  $a\text{-SiO}_2$ . Two separately measured time scales are shown. The dashed line indicates the extrapolated long-time behavior  $\Delta T_0(t)$  of  $\Delta T(t)$ .

$\Delta T_0(t)/\Delta T(t) = C(t)/C_L$  vs  $\log_{10}t$ . A straight line in this picture corresponds to a logarithmic time dependence (see Fig. 1), predicted by the tunneling model. In Fig. 6(b) we have plotted  $\log_{10}[\Delta T(t)/\Delta T_0(t) - 1]$  vs  $t$ . A straight line in this picture would correspond to an exponential decay of the overshoot in  $\Delta T(t)$ , and thus a single relaxation time for the excitations decoupled at fast time scales. Neither model explains the data very well. Clearly a distribution of relaxation times exists, but it is neither in accordance in Eq. (4), resulting from the tunneling model and leading to logarithmic time dependence of the specific heat, nor a  $\delta$  function leading to a single relaxation time. The distribution is less uniform than assumed in the model. Especially between 100  $\mu\text{sec}$  and 10 msec

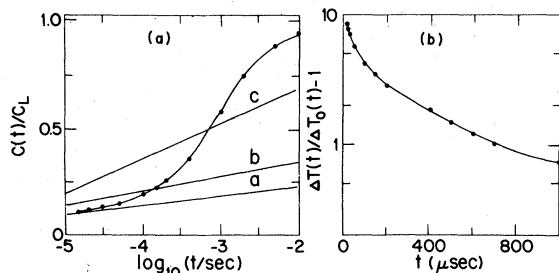

FIG. 6. Temperature response  $\Delta T(t)$  shown in Fig. 5 plotted as (a)  $C(t)/C_L = \Delta T_0(t)/\Delta T(t)$  vs  $\log_{10}t$  and as (b)  $[\Delta T(t)/\Delta T_0(t) - 1]$  vs  $t$ . The solid circles represent the actual experimental data. Case (a) shows the comparison with the tunneling model (lines  $a$ ,  $b$  and  $c$  are the same as in Fig. 1 for 0.1 K). A straight line in the case (b) would correspond to a single relaxation time.

the coupling is much larger than predicted by the tunneling model. However, below 100  $\mu\text{sec}$  the data is in qualitative agreement with the tunneling model, as can be seen by comparing the experimental points with the lines labeled  $a$  and  $b$  in Fig. 6(a).

At temperatures above 0.1 K the overshoot in  $\Delta T(t)$  due to the time-dependent specific heat rapidly decreases and soon becomes of equal magnitude as that due to the nonuniform heating. This makes the line-shape analysis difficult above 0.2 K.

The decoupling of the specific heat is, however, not seen in the diffusivity, as determined from the rising edge of the heat pulse. At 0.1 K,  $\Delta T(t)$  reaches its half-maximum at about 3  $\mu\text{sec}$ , whereas the value calculated with the thermal conductivity  $\kappa$  and the short-time specific heat  $C_S$  is only 0.4  $\mu\text{sec}$ . This result is consistent with the earlier diffusivity measurements<sup>6,7</sup> where only small deviations from the long-time specific heat were implied from the leading edge arrival times.

The very-long-time experiment on Suprasil W was performed at  $T_0 = 0.1, 0.2,$  and  $0.4$  K with similar results at each temperature. At 0.2 K the relaxation time  $\tau = K/C$  was 4.5 sec and the thermal conductance of the posts was 53 nW/K. The specific heat calculated from  $\tau$  and  $K$  was 0.21  $\mu\text{J/g K}$  at 0.2 K, in good agreement with the values 0.19  $\mu\text{J/g K}$  and 0.2  $\mu\text{J/g K}$ , obtained from Refs. 16 and 17, respectively. The 1.13-g samples used for the long-time measurement were cut from the same piece as that used for the short-time measurement.

Our data for the relaxation of the temperature towards  $T_0$  after thermalization at  $T_i$  confirmed the results of Zimmermann and Weber.<sup>10</sup> Only for small  $T_i - T_0 \lesssim 10$  mK was the relaxation exponential. For larger  $T_i - T_0$  there was a substantial  $1/t$  dependence in  $\Delta T(t)$  at long times. To obtain reproducible results it was necessary to keep the sample at  $T_i$  for long enough times, at least of the order of the time range over which the temperature decay was followed.

In Fig. 7 we show the observed temperature difference  $\Delta T_1(t)$  for several  $T_i$ . The raw data of  $T(t) - T_0$  has been corrected by adding  $-(C/K)dT/dt$  to eliminate the effect of the cooling of the sample. The data points can be compared with the theoretical curves drawn with  $\bar{P} = 3.3 \times 10^{38} \text{ J}^{-1} \text{ cm}^{-3}$ . This value of  $\bar{P}$  is the same as the result of Ref. 10. The agreement with the ultrasonic measurements<sup>13</sup> is remarkable con-

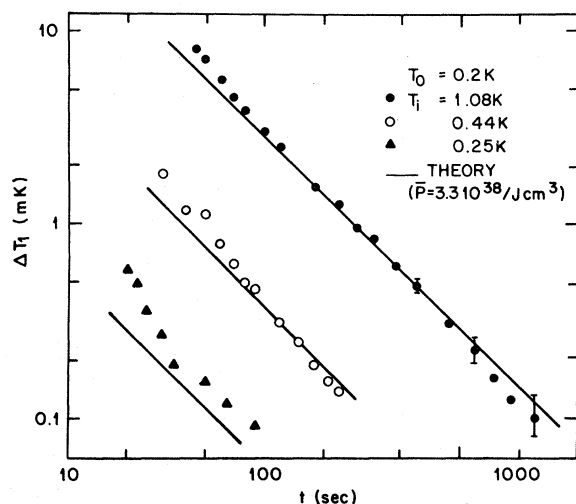

FIG. 7. Thermal relaxation of a 1.13-g sample of Suprasil W at long times. The equilibrium temperature  $T_0$  was 0.2 K and the initial temperatures  $T_i$  were 1.1 K, 0.44 K, and 0.25 K. The sample was thermally anchored to its surroundings with a thermal link which had a conductance of 53 nW/K at 0.2 K. The data shown has been corrected to take into account the cooling of the sample by subtracting  $(mC_L/K)(dT/dt)$  from the measured temperature differences  $T(t) - T_0$ .

sidering the difference between the time scales of the measurements.

### B. $\alpha$ -As<sub>2</sub>S<sub>3</sub>

Amorphous arsenic trisulfide has a much smaller excess heat capacity than  $\alpha$ -SiO<sub>2</sub>. The amount of excess however, strongly depends on the impurity concentration. We have studied  $\alpha$ -As<sub>2</sub>S<sub>3</sub> produced by Di Salvo at Bell Laboratories. It has the smallest reported impurity concentration (< 1 ppm Fe), and also the smallest excess heat capacity.<sup>18</sup> The heat capacity between 0.1 and 0.7 K, measured by Stephens (Ref. 18, sample IV), is  $C = 9.77T^3 \mu\text{J/g K}^4 + 0.44T \mu\text{J/g K}^2$ , and  $C_D = 7.9T^3 \mu\text{J/g K}^4$ . Consequently, it is not a surprise that the observed time dependence is also smaller. In Fig. 8 the long-time and short-time heat capacities measured with our technique are shown. The sample was 1 mm thick, weighing 0.132 g. The short-time values refer to the time of 30  $\mu\text{sec}$ . At 0.1 K about 40% of the total specific heat is decoupled. No decoupling is seen above 0.3 K. As in  $\alpha$ -SiO<sub>2</sub>,  $C_S$  is larger than  $C_D$ . The same result was obtained with another sample, only 0.155 mm thick. This indicates that the time

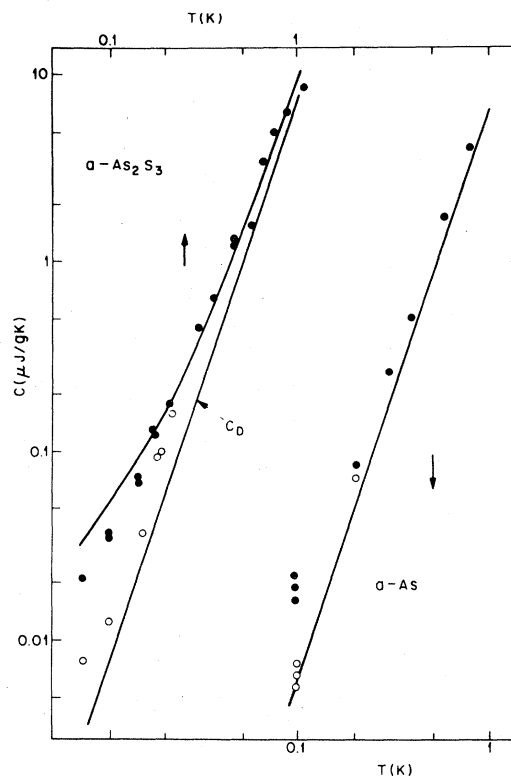

FIG. 8. Long-time specific heat  $C_L$  (solid circles) and the short-time specific heat  $C_S$  (open circles) of  $\alpha$ -As<sub>2</sub>S<sub>3</sub> (left) and  $\alpha$ -As (right). The weights of the samples were 0.132 and 0.0838 g, respectively. The thick curves are the specific heats from the measurements of Stephens ( $\alpha$ -As<sub>2</sub>S<sub>3</sub>, Ref. 18) and Jones *et al.* ( $\alpha$ -As, Ref. 22), and  $C_D$  is the Debye specific heat.

dependence below 30  $\mu\text{sec}$  is relatively weak. In  $\alpha$ -As<sub>2</sub>S<sub>3</sub> the overshoot in  $\Delta T(t)$  disappears roughly exponentially. The effective time constant is about 60  $\mu\text{sec}$  at 0.1 K.

The long-time specific heat, corresponding to a time scale of a few tens of milliseconds, is in good agreement with the data of Stephens<sup>18</sup> above 0.2 K. At 0.1 K our result is about 30% smaller. This may indicate that also for  $\alpha$ -As<sub>2</sub>S<sub>3</sub> the excess specific heat cannot be represented as  $\tilde{C}_1 T^1 + \tilde{C}_3 T^3$ , but rather as  $\tilde{C}_1 T^\alpha$  with  $\alpha \approx 1.5$ . The amount of impurities may also vary from sample to sample and cause differences in the measured specific heat.

Above 0.3 K the diffusion times of the heat pulses in  $\alpha$ -As<sub>2</sub>S<sub>3</sub> agree well with the values calculated with Stephens's data on specific heat and thermal conductivity.<sup>18</sup> At 0.1 K, the measured diffusion time for the 1 mm sample is, however, only 15–30% smaller than the calculated value



and about 3 times larger than calculated with  $C_D$ . Thus also in  $a\text{-As}_2\text{S}_3$  the decoupling of the excess specific heat is not seen in the diffusive properties of the heat pulse.

### C. $a\text{-As}$

Amorphous arsenic can be prepared only by condensation from vapor. This manufacturing process results in a product with microcavities, which limit the phonon mean free path to about  $25\ \mu\text{m}$ . Consequently the thermal conductivity below  $0.3\ \text{K}$  is proportional to  $T^3$ , not to  $T^2$  as in other glasses.<sup>22</sup> The specific heat has earlier been measured only to  $0.35\ \text{K}$ .<sup>22</sup> It did not show any excess specific heat above the Debye value. If this were true even at lower temperatures,  $a\text{-As}$  would be an important exception to the universal behavior of all the other glasses. An  $a\text{-As}$  sample (produced by MCD Ltd and kindly supplied to us by P. C. Taylor, U.S. Naval Research Laboratory),  $0.2\ \text{mm}$  thick, weighing  $0.084\ \text{g}$ , was studied for its specific heat. Owing to the extreme brittleness of the material, the sample had to be sandwiched between two sapphire plates with epoxy. Unfortunately the weight of the epoxy was unknown. It was estimated to be  $< 3\ \text{mg}$ .

The experimental  $C_L$  and  $C_S$  for  $a\text{-As}$  are shown in Fig. 8. Unlike the previous measurement, these data show a clear although small deviation from the  $T^3$  dependence in  $C_L$  below  $0.3\ \text{K}$ . At higher temperatures  $C_L$  is about 30% larger than in the previous measurement. The difference is larger than the estimated effect due to epoxy. The values of  $C_S$  follow approximately a cubic temperature dependence. The overshoot in  $\Delta T(t)$  disappears roughly exponentially, with a time constant  $\tau \approx 300\ \mu\text{sec}$  at  $0.1\ \text{K}$ .

Because the amount of epoxy was unknown, the possibility of an experimental artifact must be considered. (a) If the effect were due to the epoxy used to glue the sample to the sapphire plates, the relaxation time  $\tau$  would be much shorter than  $300\ \mu\text{sec}$  at  $0.1\ \text{K}$ . This can be determined from other measurements where the effect of the epoxy has been studied. (b) If the epoxy at the edges of the sample (used to glue the wires and the posts) had caused the overshoot, then its relative magnitude should be proportional to  $m_e C_e / mC$  between  $0.1$  and  $0.3\ \text{K}$ . (The thermal conductance of the sample is proportional to  $T^3$  in both lateral and transverse directions, since both  $a\text{-As}$  and sapphire have

$\kappa \propto T^3$  in this temperature range.) However, the overshoot is not seen at  $0.3\ \text{K}$ . Thus we conclude that most probably  $a\text{-As}$  also has excess specific heat, as other glasses, although its magnitude is smaller.

### D. $c\text{-Ge}$

As a test of this technique for short-time specific-heat determination, measurements were performed on high-purity crystalline germanium. It was expected that only the Debye  $T^3$ -dependent specific heat of the  $0.645\text{-g}$  sample would be observed. The results are shown in Fig. 9. The short-time specific heat  $C_S$  agrees with  $C_D$ , but some addenda, up to  $C_L = 2C_S$  at  $0.1\ \text{K}$ , is seen in  $C_L$  at the lowermost temperatures.

Originally, it was argued that all of the addenda were due to internal impurities in Ge.<sup>9</sup> However, later it turned out that too large drops of epoxy

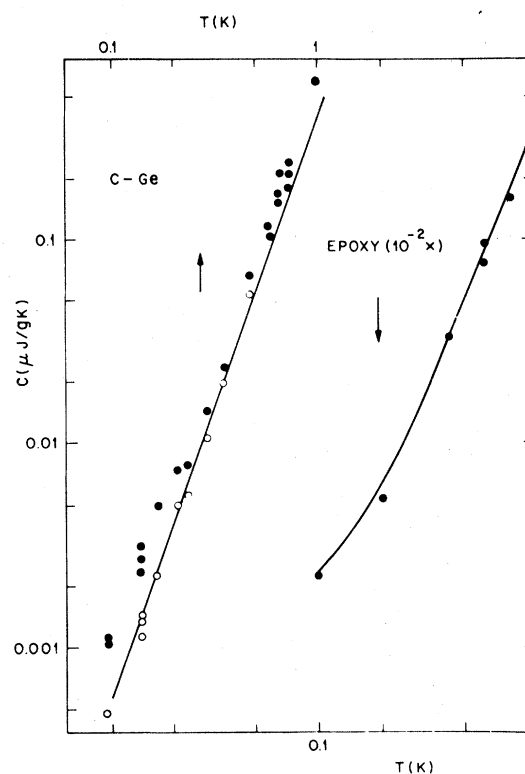

FIG. 9. Left-hand side: the long-time specific heat  $C_L$  (solid circles) and the short-time specific heat  $C_S$  (open circles) of  $c\text{-Ge}$ ;  $C_D$  is the Debye heat capacity. The sample weighed  $0.645\ \text{g}$ . Right-hand side: the long-time specific heat  $C_L$  of the epoxy Stycast 1266; the sample was  $8.7\ \text{mg}$ .

had accidentally been used to attach the wires to the crystal. The long-time specific heat of the epoxy (Stycast 1266), measured separately, is also shown in Fig. 9. The data can be approximated with  $C_L = 30T^3 \mu\text{J/g K}^4 + 2T \mu\text{J/g K}^2$ . Within our accuracy, the additional 1 mg of epoxy corresponds to about half of the observed addenda in the specific heat. Thus only part of the addenda might be due to impurities in the Ge crystal.

The correct  $T^3$  behavior of the fast-time specific heat of the Ge crystal is of great importance to this specific-heat measurement. First, it shows that the thermometry is correct. Second, and even more important, it shows that the tunnel-junction thermometer measures correct temperatures in a 10- $\mu\text{sec}$  time scale.

## V. DISCUSSION

The experimental results discussed above can be combined to yield a consistent picture of the time dependence of the specific heat. The states proposed in the original tunneling model do exist over 10 orders of magnitude in time, from less than 1  $\mu\text{sec}$  to greater than  $10^4$  sec. This is shown by the long-time thermal relaxation which reproduces the predictions of the model. Also  $C(t)$  of Suprasil W at 0.1 K seems to approach a logarithmic time dependence below 100  $\mu\text{sec}$ , although the time span there is rather limited. However, only part of the total specific heat can be ascribed to the tunneling states of the original model. Using  $\bar{P} = 3 \times 10^{38} \text{ J}^{-1} \text{ cm}^{-3}$  and  $\gamma_l = 1.5 \text{ eV}$  one can estimate that about 40% and 30% of  $C(1 \text{ sec})$  at 0.1 K and at 0.4 K, respectively, is due to these states.

A major part of the specific heat in glasses thus is not due to the original tunneling states. This "anomalous" specific heat is coupled to the phonons already at 10  $\mu\text{sec}$  above about 0.3 K. At lower temperatures there is, however, considerable decoupling, and at 0.1 K the anomalous specific heat seems to be decoupled in all the materials studied. The relaxation time spectrum of these excitation is relatively narrow, only a few decades wide at 0.1 K. With the present data, it cannot be concluded whether the anomalous specific heat below and above 0.3 K arises from a single source, or whether more than one model is needed.

To explain the anomalous excess specific heat Black has proposed additional tunneling states, with a narrow distribution of  $\lambda$ .<sup>12</sup> It was, however, recognized by Black that for these states it may be difficult to satisfy both the  $T^2$ -dependent ther-

mal conductivity and the fast coupling times over a large temperature range. Another kind of anomalous states has been proposed by Geszti.<sup>25</sup> He assumes a set of weakly coupled tunneling states, with  $\gamma \approx 0.25 \text{ eV}$ , which would have a low maximum value of the  $\lambda$  parameter<sup>26</sup>  $\lambda_{\text{max}}$  and therefore a high minimum energy  $E_{\text{min}} = E_0 \exp(-\lambda_{\text{max}})$ . Consequently, these states would have a narrow relaxation time spectrum. However, more studies are needed to establish how much of the observations might be consistently explained with this modification.

It has also been proposed that the excess specific heat around 1 K would be due to local fluctuations in the sound velocity.<sup>27</sup> These fluctuations would enhance the phonon specific heat about the Debye value. Also this model deserves more study. At the present we can only state that it is not in contradiction with our short-time specific-heat data, which shows that the excess specific heat is not generally decoupled at temperatures about  $\sim 0.3 \text{ K}$ . However, this model provides no explanation to the observed nonuniform distribution of the relaxation times at lower temperatures.

In Suprasil W additional time dependence in the specific heat was observed around 1 K. The magnitude of this effect was about 15% of the total specific heat and it relaxed with a time constant of  $\sim 100 \mu\text{sec}$ . It seems natural to ascribe this phenomenon to the anomalous Schottky specific heat observed in Suprasil W at these temperatures. The relatively long relaxation time of the excitations explains why they evidently have no effect on the thermal conductivity.<sup>17</sup>

It can be also noticed that the modification  $P(E) = \bar{P} + \alpha E^2$  does not affect the time dependence of the tunneling states. Therefore it is not a possible explanation for the excess "cubic" specific heat.

Recently, a short-time specific-heat measurement of *a*-SiO<sub>2</sub> Suprasil I has been published by Meissner and Spitzmann.<sup>28</sup> Technically, Suprasil I differs from Suprasil W with its larger OH concentration. These measurements extend only down to about 0.4 K, but they are performed on thinner samples than ours and therefore the time scale begins at 1–10  $\mu\text{sec}$ . Owing to a different experimental arrangement, the time scale is limited to below 0.2–0.5 msec. The major difference in the results of the two experiments is around 1 K, where a complete decoupling of the excess specific heat below 30  $\mu\text{sec}$  is seen in Ref. 28. This temperature overshoot relaxed exponentially, with a

time constant of about 100  $\mu\text{sec}$ . At the same temperature and time scale we observed a decoupling of about 15% in Suprasil W and *no* decoupling in Suprasil II, which for its impurity concentration resembles Suprasil I. Thus this discrepancy cannot be due to the different materials. We believe that the effect seen by Meissner and Spitzmann is due to some experimental artifact, i.e., nonuniform heating of the sample or some uncontrolled addenda.

One possible source of error is the thin pencil-graphite thermometer used by these investigators. Using the data for carbon thermometers,<sup>18</sup> one can estimate that the heat capacity of the 1- $\mu\text{m}$  layer of graphite may be comparable to that of the glass of the same area. For instance, at 1 K the heat capacity of the 1  $\mu\text{m} \times 4 \text{ mm}^2$ , graphite thermometer is 1–2 nJ/K, whereas the heat capacity of an equally large piece of the sample, 50  $\mu\text{m} \times 4 \text{ mm}^2$ , is  $\sim 1$  nJ/K. At lower temperatures the ratio becomes even more unfavorable. Thus the relaxation of the impurities in the pencil graphite may be responsible for the time dependence observed in Ref. 28. Measurements on a crystalline material, such as Ge, with pencil-graphite thermometers are necessary to help resolve this question. At lower temperatures the data in Ref. 28 is interpreted to behave approximately according to the tunneling model with parameters identical to the case in Fig. 1. However, this data cannot be relied on before the discrepancy at higher temperatures is resolved.

The diffusivity measured at low temperatures seems to remain an unsolved problem. As noted earlier, the measured diffusion times for the heat pulses are not consistent with the short-time specific heat measured in this investigation. This cannot be understood at present. From the detailed balance, the diffusivity of the phonons can be related to the absorption rate  $r_a$  and emission rate  $r$  (in the case of a single emission rate):

$$D = \frac{\kappa}{\rho C} = \frac{1}{3}vl \left[ \frac{C_D}{C} \right] = \frac{1}{3}vl \frac{r}{r_a + r}, \quad (12)$$

where  $v$  is the average sound velocity and  $l$  the average mean free path. This formula is valid for times much longer than  $r_a^{-1}$  or  $r^{-1}$ . Thus the specific heat of the excitations causes a reduction in  $D$  of the phonons due to the finite time the energy is in a nonpropagating state. When there is a distribution of relaxation times, the situation is more complicated, but in any case the diffusivity constant is determined by the specific heat that is coupled to the phonons. Therefore, the diffusivity

analysis in Ref. 28 is not on a solid basis. A minimum value for the diffusivity must be

$$D = \frac{1}{3}vl \left[ \frac{C_D}{C_S} \right]. \quad (13)$$

Thus also the diffusivity is expected to show the decoupling of the specific heat. This idea has been employed in several attempts to determine the time-dependent specific heat,<sup>6,7,8,12</sup> but the results have remained negative or inconclusive.

## VI. CONCLUSION

In conclusion, our data on the time dependence of the specific heat of glasses shows that part of the total specific heat of glasses can be ascribed to the original tunneling model. This part has an extremely wide distribution of relaxation times and shows the predicted logarithmic time dependence. In addition to those states there is a substantial contribution to the specific heat from some other source. This anomalous part has a narrower spectrum of relaxation times. At low temperatures ( $\leq 0.3$  K) it decouples from the phonons at short time scales whereas at higher temperatures it is strongly coupled to the phonons at a time scale  $\sim 10 \mu\text{sec}$ . More work is necessary to elucidate the nature of these anomalous excitations.

## APPENDIX

To examine the propagation of heat pulses in one system with a certain time-dependent specific heat, we studied the glass Pyrex #7740. It has a considerable specific heat anomaly at low temperatures due to iron spins that occur as a natural impurity in the glass.<sup>1,18</sup> The time scale for the decoupling of these impurities, however, was much longer than that for the glassy excitations discussed above. Thus samples had to be made considerably longer, up to 23 mm, to see the effect of the iron spins at the rising edge of the heat pulse.

We use an Ohmic heater and an Al bolometer. The sample (of the same batch as used in Refs. 1 and 18 and kindly supplied by Professor Pohl of Cornell University) was a 23-mm-long rod, weakly coupled to the mixing chamber of the dilution cryostat close to the thermometer. Examples of the observed heat pulses at various temperatures are shown in Fig. 10. Below 2 K the heat pulses could no more be described with a simple diffusion equation. Below 0.4 K the pulses appeared to be

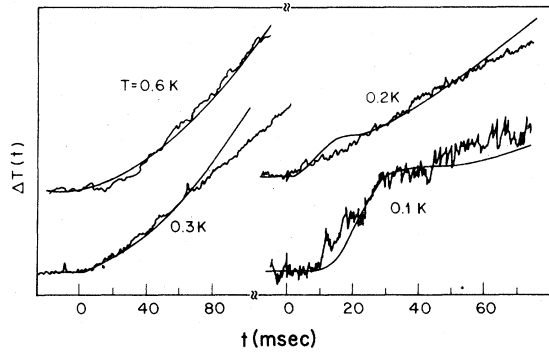

FIG. 10. Heat pulses measured with the 23-mm-long sample of Pyrex #7740 at various temperatures. The curves are calculated with Eq. (13) as explained in the text.

linear at the rising edge. At 0.3 K there was a "transition" to flat pulses, with the arrival time of the leading edge,  $t^*$ , approximately equal to that of the glass without iron impurities. The arrival time of the leading edge is shown in Fig. 11 as a function of  $T$ . The values of  $t^*$  calculated using both the full specific heat,  $C_T$ , and the estimate specific heat<sup>18</sup> without the iron anomaly,  $C_G$ , are also shown in Fig. 11. For comparison we also show the results of a laser-excited measurement on a 1 mm-long sample, scaled with the ratio of the lengths squared. These data show no effect due to the spins.

The diffusive propagation of the heat pulse in a two-component system in the dominant photon approximation can be analyzed using the diffusion equations (1 refers to the glass and 2 to the iron spins).

$$\begin{aligned} \dot{T}_1 &= (\kappa_1/C_1)T_{1xx} - r_2(C_2/C_1)(T_1 - T_2) \\ &\quad + A\delta(t)\delta(x), \\ \dot{T}_2 &= -r_2(T_2 - T_1). \end{aligned} \quad (14)$$

The excitation term is denoted by  $A\delta(t)\delta(x)$ , the

$$\begin{aligned} \Delta T(x=L, \tau) \propto \sum_{n=0}^{\infty} (-1)^n (2 - \delta_{no}) F^{-1} \{ (n^2 + c - d + F) \exp[-\tau(n^2 + c + d + F)/2] \\ - (n^2 + c - d - F) \exp[-\tau(n^2 + c + d - F)/2] \}, \end{aligned} \quad (15)$$

where  $F = [(n^2 + c + d)^2 - 4dn^2]^{1/2}$  and  $L$  is the length of the sample. The values of  $t^*$  calculated with Eq. (15) are shown in Fig. 11. Below 0.3 K the specific heat of the impurities is scaled from the measurement of Stephens<sup>18</sup> on Pyrex #9700. The relaxation rate of the spins is taken to be  $r_2 = 100(T/K)/\text{sec}$ , to obtain the best fit to the

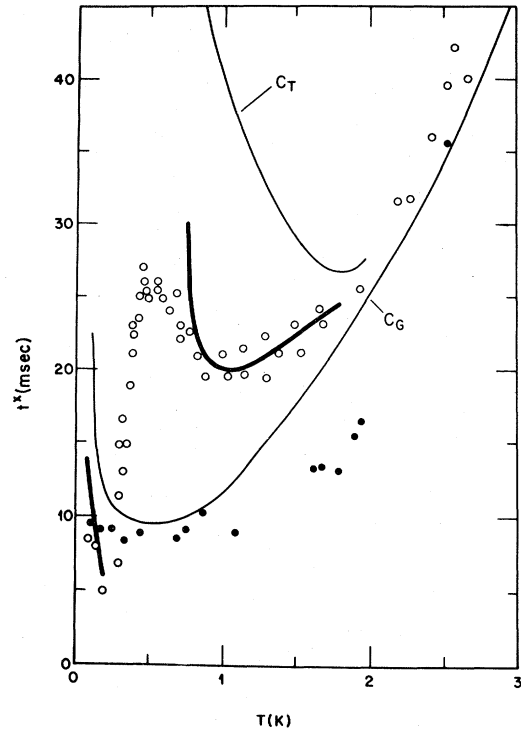

FIG. 11. Arrival time of the leading edge of the heat pulses,  $t^*$ , measured with the 23-mm sample of Pyrex #7740 (open circles).  $C_T$ :  $t^*$  calculated with the total specific heat of Pyrex #7740.  $C_G$ :  $t^*$  calculated with the estimated specific heat of the glass without the iron anomaly. Thick line:  $t^*$  obtained from the curves calculated with Eq. 15. The solid dots are the results of a laser excitation experiment on a 1-mm-thick sample, scaled with the ratio of the lengths squared.

relaxation rate of the impurities is  $r_2$ , and  $\kappa_1$  is the thermal conductivity. Using the Laplace technique we obtain, writing

$$\tau = (\kappa_1 \pi^2 / C_1 L^2) t = r_D / t, \quad d = r_1 / r_D$$

and  $c = C_2 r_2 / C_1 r_D$ ,

measured line shapes. This is the only adjustable parameter in the calculation.

It can be seen that the agreement is satisfactory above 0.6 K and again below 0.2 K, but only qualitative around 0.3 K where the pulse changes due to the decoupling of the iron spins. This can also be seen when comparing the measured and calculated

line shapes. The discrepancy is possibly due to the dominant phonon approximation in Eq. (14) or to the assumption of a single relaxation time for the spins. However, the measurement shows that the line shapes of the heat pulses are considerably changed also at the leading edge when a large part of the specific heat is decoupled from the phonons.

Thus it should be possible to determine the short-time specific heat from  $t^*$  also in the case of glasses. However, in practice the results have remained unclear, possibly indicating that the diffusion (or the thermalization) of the phonons in a short-time-scale measurement is not yet properly understood.

- 
- <sup>1</sup>R. C. Zeller and R. O. Pohl, *Phys. Rev. B* **4**, 2029 (1971).
- <sup>2</sup>P. W. Anderson, B. I. Halperin and, C. M. Varma, *Philos. Mag.* **25**, 1 (1972).
- <sup>3</sup>W. A. Phillips, *J. Low Temp. Phys.* **7**, 351 (1972).
- <sup>4</sup>S. Hunklinger and W. Arnold, in *Physical Acoustics*, edited by W. P. Mason and R. N. Thurston (Academic, New York, 1976), Vol. 12, p. 155.
- <sup>5</sup>J. E. Graebner and B. Golding, *Phys. Rev. B* **19**, 964 (1979).
- <sup>6</sup>W. M. Goubau and R. H. Tait, *Phys. Rev. Lett.* **34**, 1220 (1975).
- <sup>7</sup>R. B. Kummer, R. C. Dynes, and V. Narayanamurti, *Phys. Rev. Lett.* **40**, 1187 (1978).
- <sup>8</sup>J. E. Lewis and J. C. Lasjaunias, in *Phonon Scattering in Condensed Matter*, edited by H. J. Maris (Plenum, New York, 1979).
- <sup>9</sup>M. T. Loonen, R. C. Dynes, V. Narayanamurti, and J. P. Garno, *Phys. Rev. Lett.* **45**, 457 (1980).
- <sup>10</sup>J. Zimmerman and G. Weber, *Phys. Rev. Lett.* **46**, 661 (1981).
- <sup>11</sup>J. Jackle, *Z. Phys.* **257**, 212 (1972).
- <sup>12</sup>L. Black, *Phys. Rev. B* **17**, 2740 (1978).
- <sup>13</sup>B. Golding, J. E. Graebner, and R. J. Schutz, *Phys. Rev. Lett.* **14**, 1660 (1976).
- <sup>14</sup>B. Golding, M. D. Schickfus, S. Hunklinger, and K. Dransfeld *Phys. Rev. Lett.* **43**, 1817 (1979). See this paper for impurity content of different forms of fused silica.
- <sup>15</sup>J. C. Lasjaunias, A. Ravex, M. Vandorpe, and S. Hunklinger, *Solid State Commun.* **17**, 1045 (1975).
- <sup>16</sup>J. C. Lasjaunias, D. Thoulouse and F. Pernot, *Solid State Commun.* **14**, 957 (1974).
- <sup>18</sup>R. B. Stephens, *Phys. Rev. B* **8**, 2896 (1973); **13**, 852 (1975).
- <sup>19</sup>P. J. Anthony and A. C. Anderson, *Phys. Rev. B* **14**, 5198 (1976).
- <sup>20</sup>L. Piche, R. Maynard, S. Hunklinger, and J. Jackle, *Phys. Rev. Lett.* **32**, 1426 (1974).
- <sup>21</sup>M. P. Zaitlin and A. C. Anderson, *Phys. Rev. B* **14**, 5198 (1976).
- <sup>22</sup>D. P. Jones, N. Thomas, and W. A. Phillips. *Philos. Mag.* **38**, 271 (1978).
- <sup>23</sup>M. H. Cohen and C. G. Grest, *Phys. Rev. Lett.* **45**, 1271 (1980).
- <sup>24</sup>J. C. Ho, H. R. O'Neal, and N. E. Phillips, *Rev. Sci. Instrum.* **34**, 782 (1963).
- <sup>25</sup>T. Gestzti (unpublished).
- <sup>26</sup>J. C. Lasjaunias, R. Maynard, and M. Vandorpe, *J. Phys. (Paris)* **37**, C6-973 (1978).
- <sup>27</sup>R. I. Fagaly and R. G. Bohn (unpublished); *Phys. Lett.* **77A**, 85 (1980).
- <sup>28</sup>M. Meissner and K. Spitzmann, *Phys. Rev. Lett.* **46**, 265 (1981).

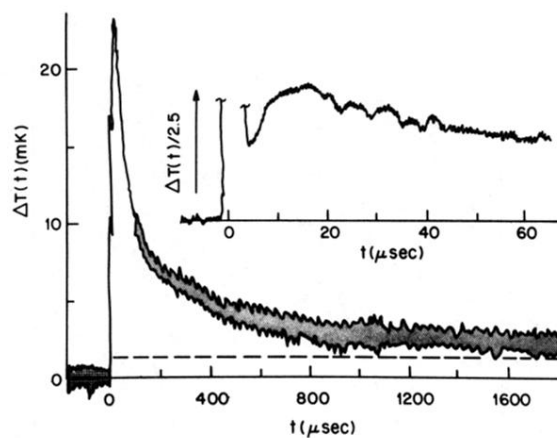

FIG. 5. Fast-time temperature response  $\Delta T(t)$  at 0.1 K measured on  $a\text{-SiO}_2$ . Two separately measured time scales are shown. The dashed line indicates the extrapolated long-time behavior  $\Delta T_0(t)$  of  $\Delta T(t)$ .