



SKRIPSI – ME141501

**SISTEM MONITORING SUHU TERINTEGRASI
BERBASIS *WIRELESS SENSOR NETWORK* DI *REEFER
STORAGE***

**Ardian Yudha
NRP 4211 100 002**

**Dosen Pembimbing
Sutopo Purwono Fitri, S.T, M.Eng, Ph.D
Ir. Alam Baheramasyah, M.Sc**

**JURUSAN TEKNIK SISTEM PERKAPALAN
FAKULTAS TEKNOLOGI KELAUTAN
INSTITUT TEKNOLOGI SEPULUH NOPEMBER
SURABAYA
2016**



FINAL PROJECT – ME141501

**INTEGRATED TEMPERATURE MONITORING SYSTEM
BASED ON WIRELESS SENSOR NETWORK IN REEFER
STORAGE**

**Ardian Yudha
NRP 4211 100 002**

**Supervisors
Sutopo Purwono Fitri, S.T, M.Eng, Ph.D
Ir. Alam Baheramasyah, M.Sc**

**DEPARTMENT OF MARINE ENGINEERING
FACULTY OF MARINE TECHNOLOGY
SEPULUH NOPEMBER INSTITUTE OF TECHNOLOGY
SURABAYA
2016**

APPROVAL SHEET

INTEGRATED TEMPERATURE MONITORING SYSTEM BASED ON WIRELESS SENSOR NETWORK IN REEFER STORAGE

FINAL PROJECT

Presented in Partial Fulfillment of the Requirements
for the Degree of *Sarjana Teknik*
in
Study Field Marine Machinery and System (MMS)
Study Program S-1 Department of Marine Engineering
Faculty of Marine Technology
Sepuluh Nopember Institute of Technology

Written by:
Ardian Yudha
NRP 4211 100 002

Approved by Supervisors:

1. Sutopo Purwono Fitri, ST., M.Eng., Ph.D
NIP. 1975 1006 2002 12 1003
2. Ir. Alam Baheramsyah, M.Sc
NIP. 1968 0129 1992 03 1001



SURABAYA
January 2016

APPROVAL SHEET

**INTEGRATED TEMPERATURE MONITORING SYSTEM
BASED ON WIRELESS SENSOR NETWORK IN REEFER
STORAGE**

FINAL PROJECT

Presented in Partial Fulfillment of the Requirements
for the Degree of *Sarjana Teknik*

in

Study Field Marine Machinery and System (MMS)
Study Program S-1 Department of Marine Engineering
Faculty of Marine Technology
Sepuluh Nopember Institute of Technology

Written by:
Ardian Yudha
NRP 4211 100 002

Approved by Head of Department of Marine Engineering:

Dr. Eng. M. Badrus Zaman, ST, MT
NIP. 1977 0802 2008 01 1007



SURABAYA

January 2016

DECLARATION OF HONOUR

I the undersigned hereby declare to the fact that:

This thesis report was not contained acts of plagiarism, and declare voluntarily that all data, concept, design, writing materials, and every matter in the report is the property of the Laboratory of Marine Machinery and System (MMS) at the Department of Marine Engineering ITS which is the result of my research studies and is entitled to be used for the implementation of the activities of further research and development.

Name : Ardian Yudha
NRP : 4211100002
Title : Integrated Temperature Monitoring
System Based on Wireless Sensor
Network in Reefer Storage
Department : Marine Engineering

If in the future there is a proven plagiarism action, then I will take full responsibility and accept the sanction given by ITS in accordance with applicable regulations.

Surabaya, January 22, 2016

(Ardian Yudha)

SISTEM MONITORING SUHU TERINTEGRASI BERBASIS WIRELESS SENSOR NETWORK DI REEFER STORAGE

Nama : Ardian Yudha
NRP : 4211 100 002
Dosen Pembimbing 1 : Sutopo Purwono F, ST., M.Eng., Ph.D
Dosen Pembimbing 2 : Ir. Alam Baheramasyah, M.Sc

ABSTRAK

Semakin meningkatnya jumlah distribusi produk hortikultura yang mudah membusuk, semakin meningkat pula penggunaan kapal kontainer berpendingin (reefer storage). Hal ini dibutuhkan untuk menjaga suhu buah dan sayuran sesuai kebutuhan. Di dalam industri cold chain, banyaknya tahap dan lamanya waktu penyimpanan dan pendistribusian menyebabkan ketidakstabilan suhu, sehingga perlu adanya monitoring suhu secara periodik, terutama di dalam reefer storage. Hal ini dilakukan untuk menjaga kesegaran dan kualitas dari produk. Di dalam penelitian ini, Wireless Sensor Network (WSN) digunakan sebagai salah satu inovasi sistem monitoring suhu.

Penelitian ini bertujuan untuk mengadakan percobaan dan menganalisa efektifitas sistem monitoring suhu menggunakan Wireless Sensor Network dibandingkan dengan sensor termokopel, serta mengidentifikasi lokasi sensor suhu di dalam reefer storage berdasarkan perencanaan peletakan kargo. Penelitian ini menggunakan pisang sebagai kargo yang harus dijaga suhunya antara 12 – 16 °C. Percobaan pertama menggunakan sensor termokopel tipe K dan data logger Labjack T7 Pro. Percobaan kedua menggunakan beberapa sensor node, koordinator, repeater, dan modul penerima.

Di dalam sistem WSN diterapkan sebuah topologi star. Selama 4 jam percobaan dengan interval pengambilan data selama 2 detik, sistem ini mampu mentransfer 6,446 data suhu.

Selain itu, sensor WSN mampu membaca suhu 12 – 16 °C dengan eror sebesar 0.68 °C atau 4.7 % dari suhu rata-rata, hal ini mengacu pada nilai standard error selama proses kalibrasi. Di lain pihak, sensor termokopel mampu membaca 7,200 data suhu secara real-time. Sebagai tambahan, lokasi-lokasi kritis di dalam reefer storage terdapat pada sisi atas dan tengah dari kargo. Berdasarkan hal-hal tersebut, implementasi Wireless Sensor Network di dalam reefer storage akan lebih efektif dibandingkan dengan sensor termokopel dalam hal kemampuan monitoring secara real-time yang sama serta dalam hal jangkauan transmisi data dari sensor ke modul penerima yang sejauh 100 meter.

Kata Kunci: *Produk Hortikultura, Reefer Storage, Wireless Sensor Network (WSN), Termokopel, Topologi Star, Perencanaan Peletakan Kargo*

INTEGRATED TEMPERATURE MONITORING SYSTEM BASED ON WIRELESS SENSOR NETWORK IN REEFER STORAGE

Name : Ardian Yudha
NRP : 4211 100 002
Supervisor 1 : Sutopo Purwono F, ST., M.Eng., Ph.D
Supervisor 2 : Ir. Alam Baheramasyah, M.Sc

ABSTRACT

The increasing number of perishable horticultural product distribution leads to the increasing number of the use of reefer storage/container vessels. It is needed to keep the temperature suitable for fruits and vegetables. In the cold chain industry, some steps and long time needed in the storing and distribution process cause unstable temperature, so the periodical temperature monitoring is needed, especially in vessels' storages. This is done in order to maintain the freshness and quality of the products. In this study, a Wireless Sensor Network (WSN) was implemented as one of the monitoring systems.

This study was aimed to conduct experimentally and analyze the effectiveness of the temperature monitoring system using Wireless Sensor Network compared to the thermocouple sensors, as well as to identify the location of the temperature sensors in the reefer storage based on the stowage plan. This study was based on the setting temperature of bananas around 12 – 16 °C. The first experiment used thermocouple sensors type K and Labjack T7 Pro data logger. The second experiment used WSN sensor nodes, the coordinator, the repeater, and the receiver module.

In the WSN system, a star topology was applied. During experiments conducted for 4 hours with the interval around 2 seconds, this system could transfer 6,446 temperature data. Furthermore, WSN sensor nodes can read temperature in the



range of 12 – 16 °C with the uncertainty error around 0.68 °C or 4.7 % from the mean temperature according to the standard error in the calibration process. On the other hand, thermocouple sensors could read 7,200 temperature data completely and real-time. In addition, the critical locations in reefer storage were on the top side and middle side of the cargo. Based on these findings, the implementation of Wireless Sensor Network in reefer storage was found to be more effective than thermocouple sensors in terms of the similar capability to monitor real-time data and of the range of the data transmission from the sensors to the receiver which is around 100 meters.

Keywords: *Horticultural Product, Reefer Storage, Wireless Sensor Network (WSN), Thermocouple, Star Topology, Stowage Plan*

ACKNOWLEDGEMENTS

Alhamdulillah. All praises to The Almighty God, Allah SWT, for always bestowing His best blessings for me to get this research done.

Foremost, I wish to express my sincere gratitude to Mr. Sutopo Purwono Fitri, S.T, M.Eng, Ph.D, my first research supervisor as well as my academic advisor, for the continuous support of my bachelor study and research, for his patient, motivation, enthusiasm, and immense knowledge. I place on record, my sincere thank you to Mr. Ir. Alam Baheramsyah, M.Sc, my second research supervisor, for the continuous encouragement. Their guidance helped me in all the time of research and writing of this thesis.

Besides my supervisors, I would like to thank the rest of my thesis examiners: Mr. Ir. Soemartojo WA, Mr. Ir. Hari Prastowo, M.Sc, Mr. Taufik Fajar Nugroho, S.T, M.Sc, and Mr. Beny Cahyono, S.T, M.T, for their valuable guidance, hard questions, and constructive feedbacks during the process and examination of this thesis.

An enormous amount of gratitude and love is awarded to my dearest Kartoyudho Family and Sudiro Family, though that would not be enough compared to their never-ending love, pray, and support. I also take this opportunity to thank you to Yolanda Putri Yuda, my sister in crime, for helping me and positively supporting me.

The last but not least, thank you so much to Arlita Alif Viany for spending her time proofreading this thesis, Moch. Qusyairi and Fayun Bondan Maghfiroh for being my good research mates, Emmy Pratiwi and Taufiqurrahman for kindly helping me during my process, and all lab mates and AMPIBI'11 especially my karaoke, culinary, trip, and hang-out fellows for satisfying my right brain performance during my study. I am fortunate to have you guys.

TABLE OF CONTENT

APPROVAL SHEET	i
ABSTRACT	v
ABSTRAK	vii
ACKNOWLEDGEMENTS	ix
TABLE OF CONTENT	xi
ILLUSTRATION	xv
TABLE	xvii
CHAPTER I	
INTRODUCTION	1
1.1 Background of the Study	1
1.2 Research Problems	2
1.3 Scope of the Study	2
1.4 Research Objectives	3
1.5 Research Benefits	3
CHAPTER II	
THEORITICAL FRAMEWORK	5
2.1 Paper Review	5
2.2 Reefer Storage	6
2.3 Reefer Storage's Working Principle	8
2.3.1 Compression	8
2.3.2 Condensation	8
2.3.3 Expansion	8
2.3.4 Evaporation	9
2.4 Cold Chain	9
2.5 Cooling Temperature of Horticultural Products	10
2.6 Wireless Sensor Network (WSN)	14
2.7 Application of Wireless Sensor Network (WSN)	15
2.8 Components of Wireless Sensor Network	18
2.9 Working Principle of Wireless Sensor Network	18
2.10 Topology of Wireless Sensor Network	19

2.11	Thermocouple	22
2.12	Working Principle of Thermocouple	23
2.13	Processing Analog-Digital Converter	24
2.14	Formula for Voltage-Temperature Value Conversion	24
2.15	Stowage.....	26

CHAPTER III

RESEARCH METHODOLOGY	29	
3.1	Study of Literature	29
3.2	Empirical Studies of Wireless Sensor Network (WSN) & Thermocouple	29
3.3	Experiment of Temperature Monitoring System Based on WSN Method	30
3.4	Experiment of Temperature Monitoring System Based on Thermocouple Sensors.....	31
3.5	Data Analysis	31
3.6	Method Comparison.....	32
3.7	Conclusion	32
3.8	The Flow Chart of the Research Methodology	33
3.9	The Experiment Plot of Wireless Sensor Network Method	34
3.10	The Experiment Plot of Thermocouple Sensors Method	34

CHAPTER IV

RESEARCH PREPARATION AND PROCESS.....	35	
4.1	Experimental Apparatus.....	35
4.1.2	Cold Storage.....	35
4.1.3	WSN Apparatus	36
4.1.4	Thermocouple Apparatus	36
4.2	Data Collection Methods	36
4.2.1	Data Collection Method Based on Thermocouple Sensors.....	37
4.2.2	Data Collection Method Based on Wireless Sensor Network.....	37
4.3	Variables of Data Collection.....	38

4.4	Experimental Preparation of Thermocouple	39
4.4.1	Apparatus Installation	39
4.4.2	Installation & Configuration of Data Logger	40
4.4.3	An Initial Data Collection for Data Logger Calibration.....	43
4.4.4	Temperature Data Conversion	43
4.5	Experiment Preparation of Wireless Sensor Network.....	46
4.5.1	WSN Apparatus Installation	46
4.6	Apparatus Calibration	50
4.7	Stowage Plan and Stuffing	51
4.8	Thermocouple Sensors and Sensor Nodes Placement.....	53
4.9	Air Flow Rate Measurement	56
4.10	Experimental Procedure of Temperature Monitoring Based on Thermocouple Sensors	58
4.11	Experimental Procedure of Temperature Monitoring Based on Wireless Sensor Network	59
4.12	Star Topology of the WSN Experiment	60

CHAPTER V

	RESEARCH FINDINGS AND DATA ANALYSIS	63
5.1	Results of Apparatus Calibration	63
5.2	Findings of Experiment Based on Thermocouple Sensors (Monitoring 1)	68
5.3	Findings of Experiment Based on Thermocouple Sensors (Monitoring 2)	72
5.4	Findings of Experiment Based on Wireless Sensor Network (WSN)	74
5.5	Analysis of the Critical Location Based on Experiment Using Thermocouple.....	76
5.6	Analysis of Humidity Based on Experiment Using Wireless Sensor Network.....	78
5.7	Analysis of the Selection of WSN Apparatus	81
5.8	Method Comparison.....	83

CHAPTER VI

CONCLUSIONS AND SUGGESTIONS	87
6.1 Conclusions.....	87
6.2 Suggestions	88
REFERENCES.....	89
APPENDICES.....	91
BIOGRAPHY.....	101

ILLUSTRATION

Figure 2.1	Cold Storage Refrigeration System Piping Diagram	6
Figure 2.2	Cold Chain Process.....	10
Figure 2.3	Bus Topology	19
Figure 2.4	Star Topology	20
Figure 2.5	Tree Topology	20
Figure 2.6	Ring Topology.....	21
Figure 2.7	Mesh Topology.....	22
Figure 2.8	Thermocouple.....	22
Figure 2.9	Thermocouple.....	23
Figure 2.10	Interpolation Method.....	25
Figure 2.11	Incorrect-stuffing of the Container Cargo	27
Figure 2.12	Correct-stuffing of the Container Cargo.....	27
Figure 2.13	Top View of Cargo Stuffing.....	28
Figure 3.1	The Flow Chart of the Research Methodology	33
Figure 3.2	The Experiment Plot of Wireless Sensor Network Method.....	34
Figure 3.3	The Experiment Plot of Thermocouple Sensors Method.....	34
Figure 4.1	Cold Storage at MMS's Workshop	35
Figure 4.2	Thermocouple Scheme	37
Figure 4.3	Wireless Sensor Network Scheme.....	38
Figure 4.4	Apparatus Installation of Experiment Using Thermocouple.....	40
Figure 4.5	Main Display of Select Devices at Kipling	40
Figure 4.6	Connectivity Display of USB Menu at Kipling.....	41
Figure 4.7	Devices Information Display at Kipling.....	42
Figure 4.8	Configuration Display at Analog Input Menu.....	42
Figure 4.9	Main Display of LJLogM.....	43
Figure 4.10	Automatic Voltage-Temperature Conversion Code	45
Figure 4.11	WSN Apparatus Installation.....	46
Figure 4.12	Sensor Node Located in the Top Side of Cold Storage.....	47
Figure 4.13	Coordinator of WSN System.....	48

Figure 4.14	Repeater.....	48
Figure 4.15	Receiver Module	49
Figure 4.16	Program GUI.....	49
Figure 4.17	Apparatus Calibration.....	50
Figure 4.18	(a) Shelf Design, (b) Cargo Stuffing Plan in Reefer Storage.....	52
Figure 4.19	Bananas as Cargo in Reefer Storage.....	53
Figure 4.20	Thermocouple Placement in the Cargo	54
Figure 4.21	Top View of Sensors Placement.....	54
Figure 4.22	Front View of Sensors Placement	55
Figure 4.23	Modification of the Evaporator	57
Figure 4.24	Anemometer	57
Figure 4.25	Labjack T7 Pro Installation during Experiment	58
Figure 4.26	Receiver Module Connected to the Laptop	60
Figure 4.27	Scheme of Star Topology	62
Figure 5.1	Chart of Sensors Calibration	64
Figure 5.2	Chart Based on Mean Data of Sensors Calibration ..	65
Figure 5.3	Chart Based on Mean Data and Standard Error of Sensors Calibration.....	67
Figure 5.4	Chart of Thermocouple-based Experiment Results ..	69
Figure 5.5	Second Monitoring Results of Thermocouple-based Experiment	73
Figure 5.6	Chart of WSN-based Temperature Monitoring Experiment	75
Figure 5.7	Air Flow Direction Released by the Evaporator	78
Figure 5.8	Humidity Chart of WSN Experiment	79
Figure 5.9	Comparison Chart between Temperature & Humidity.....	80
Figure 5.10	Comparison Chart between Node 1 and AIN 0.....	84
Figure 5.11	Comparison Chart between Node 2 and AIN 1	84
Figure 5.12	Comparison Chart between Node 3 and AIN 7	85
Figure 5.13	Comparison Chart between Node 4 and AIN 3	85
Figure 5.14	Comparison Chart between Node 5 and AIN 6.....	86
Figure 7.1	WSN System with Coordinator	97
Figure 7.2	Detail Chart of Error Standard.....	98

TABLE

Table 2.1	Insulation Panel Materials	6
Table 2.2	Summary of Recommended CA or MA conditions during transport and/or storage of selected fruits	11
Table 2.3	Summary of Recommended CA or MA conditions during transport and/or storage of selected vegetables	12
Table 4.1	Experiments Variables.....	39
Table 4.2	Voltage Data Sample	44
Table 5.1	Data Sample Taken from Temperature Setting 25°C.....	63
Table 5.2	Mean of Data Sample	64
Table 5.3	Table of Standard Deviation Calculation	66
Table 5.4	Table of Standard Deviation and Standard Error Calculation.....	67
Table 5.5	Data Sample of Thermocouple-based Experiment (Monitoring 1)	68
Table 5.6	Table of Equilibrium Time of Thermocouple Monitoring System	71
Table 5.7	Data Sample of Thermocouple-based Experiment (Monitoring 2)	72
Table 5.8	Temperature Data Sample of Wireless Sensor Network (WSN)-based Experiment.....	74
Table 5.9	Comparison of Temperature Data (Right & Left Sides)	76
Table 5.10	Comparison of Temperature Data (Top & Bottom Sides)	77
Table 5.11	Humidity Data Sample of Wireless Sensor Network (WSN)-based Experiment	79
Table 5.12	Comparison Data between IR Temperature sensor Placed inside and outside the Cardboard	82
Table 5.13	Standard Error Based on Data Sample from the First 30 Minutes.....	83
Table 5.14	Standard Error Based on Data Sample from the Last 30 Minutes	83

Table 7.1	Thermocouple Components Specifications	91
Table 7.2	Sensor Nodes Components Specifications	92

CHAPTER I INTRODUCTION

1.1 Background of the Study

These days, the number of import and export done by local and international entrepreneurs is increasing. The increasing number of the product distribution leads to the increasing number of the use of commercial vessel transports, such as reefer storage vessels.

Reefer storage is not only used to import and export but also to distribute products in large quantity to long distance areas, such as fruits and vegetables. Because fruits and vegetables are perishable, the use of reefer container is needed in order to keep the temperature suitable for the fruits and vegetables.

The process of saving the products into containers should start from harvesting, pre-cooling, warehouse-refrigerating, and using reefer storage to distribute the products to consumers as the end users. Some steps and long time needed in the saving process cause unstable temperature, so the periodical temperature monitoring is needed, especially in vessels' storages. This is done in order to maintain the freshness and quality of the fruits and vegetables.

The current monitoring process is mostly applying manual method, such as thermostat sensor in the containers, while we need to monitor the products periodically. Furthermore, monitoring process is not only needed by the ship operators but also other parties, especially the stakeholders related to the products, such as the distributors, markets, and shipping companies. Based on the aforementioned problems, an easily and quickly accessible monitoring method is needed.

The currently used temperature monitoring technology is RFID (Radio Frequency Identification) that is an identification method by using RFID label or transponder to read and save long-distance data. This technology can be applied to monitor the temperature in the containers and the data can be connected to the

land by using radio frequency. However, this technology costs much money, so it will increase the operational cost if we keep using it.

As a response to the aforementioned issues, we need an innovative affordable technology to easily and quickly monitor the temperature by using and developing existing technology. For instance, we can apply a wireless sensor network-based online temperature monitoring.

1.2 Research Problems

According to the background of the study, this final project has the following research problems.

1. How experiments on the temperature monitoring based on Wireless Sensor Network in the reefer storage should be conducted.
2. How the temperature sensor in the reefer storage should be placed based on the pattern of cargo stuffing.
3. How the use of temperature monitoring system by using Wireless Sensor Network is more efficient compared to thermocouple method.

1.3 Scope of the Study

According to the research problem, this final project has the following scopes.

1. The experiment is conducted only in the cold storage in the workshop of Marine Machinery and System Laboratory, Department of Marine Engineering, FTK-ITS.
2. The number of sensor nodes in the Wireless Sensor Network is equal to the thermocouple points attached in the experiment.
3. The topology used in this research is Star Topology.
4. The thermocouple method is designed to compare the efficiency and effectiveness of the use of Wireless Sensor Network.

5. The experiment is done to identify the monitoring system without identifying the controlling system.

1.4 Research Objectives

In accordance with the background of the study, this final project has these following objectives.

1. To conduct and to analyze the effectiveness of an experiment on the temperature monitoring system using Wireless Sensor Network based on the WSN scheme/topology.
2. To conduct an experiment on the temperature monitoring system by using thermocouple sensor as the comparison.
3. To identify the location of the temperature sensor in the reefer storage based on the stowage planning.

1.5 Research Benefits

This final project will be able to give these following benefits.

1. In general, this final project can be used by all stakeholders in the cold chain industry, especially those who concern the cargo condition in the reefer storage by collecting real time data as the reference of the cargo quality.
2. This final project can be used as a reference for the reefer storage designer, especially reefer container in order to get a modern design of reefer storage.



“This page is intentionally left blank”

CHAPTER II THEORITICAL FRAMEWORK

2.1 Paper Review

Boonsawat et al. stated that Wireless Sensor Networks (WSN) is a computing technology that can be used to detect the environmental properties such as temperature, and had applied the network to the building. WSN is a combination of an embedded system with wireless communication that allows the transmission of data between the sensor nodes through ad-hoc wireless network. The applied network was used to monitor the temperature in all the classes exist in the Sirindhorm International Institute of Technology (SIIT). The purpose was to determine the energy consumption data from the use of Air Condition (AC). By applying WSN, this could be a reference to control the excessive energy consumption.

The system implemented here used XBee standards-based IEEE 802.15.4/ZigBee Wireless Personal Area Network (WPAN) by considering the low-power, low-maintenance, and self-organizing of WSN. The simality of this research with the research that will be done is to take advantage of the Wireless Sensor Network technology to monitor the temperature in the room, while the difference is that WSN technology in this study was only used to monitor the temperature of the building with the aim of saving energy, while the research that will be done aims to monitor the temperature in reefer storage for controlling the temperature of fruits in it.

Mayalarp et al. explained that the purpose of the study was to evaluate the performance of ZigBee Mesh Networks based on XBee Networks modules. Mesh was suitable with the network in a dynamic and broad area. There was also an explanation about the application of mesh networks which could be applied in the building and construction automation system, foodstuff storage room, in a set of robots, and the vision-based wireless sensor network. The consideration to use XBee itself was because they

are cheap and widely available in the market. Based on the previous statements regarding the application of WSN for groceries storage space, the research on the application of WSN in reefer storage was appropriate.

Patil et al. described that besides being a monitoring tool, WSN could be used as a controlling tool. The application of the system was to control the temperature which had many applications such as controlling water temperature, industrial machinery tools, and within the industry itself. Next, this technology can be developed to be applied as a protection when there is a fire.

2.2 Reefer Storage

Reefer storage is a space used to save perishable products, such as fruits, vegetables, and other horticultural products. By cooling down the temperature of a product, the activity of enzymes and microbes within the products will be reduced, so that damage and deterioration can be inhibited. Controlling the cooling process of fruits and vegetables is a critical factor because it can cause chilling injury when it is below a certain temperature (Pratama, 2013).

Reefer storage can be described as a large structure of building that has a function as a refrigerator. This low temperature building can certainly be used properly if the room is closed. This means that there is no air circulation (air in and out) and using refrigeration equipment (refrigerator) emits cold air to keep the temperature low.

There are insulating panels in the structure of a reefer storage, the following Table 2.1 are some of the materials that can be used to make insulation panels.

Table 2.1. Insulation Panel Materials

Panel Type	U value, W/m ² °C	Weight, kg/m ²	Water Adsorption Possibility
Polystyrene	0.34	11.2	1.00%

Styrofoam	0.24	13.3	0.50%
Polyurethane	0.3	13.3	2%
Mineral Wool	0.38	19	50%

Source: Pratama, 2013

Reefer Storage has these following major components.

1. Evaporator
2. Compressor
3. Condenser
4. Expansion Device

In addition to the aforementioned main components, reefer storage also has some accessories, such as these following components.

1. Receiver
2. Filter Drier
3. Moisture Indicator
4. Solenoid Valve
5. Shut-off Valve
6. Pressure Gauge (LPG dan HPG)
7. Pressure Control (DPC)

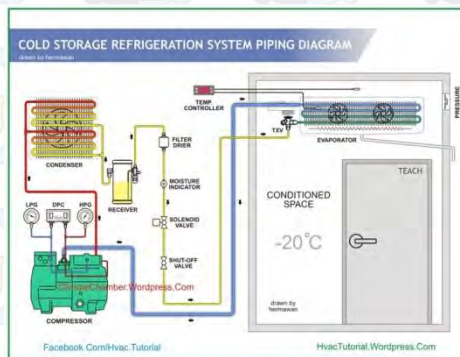

Figure 2.1. Cold Storage Refrigeration System Piping Diagram

Source: <https://climatechamber.wordpress.com/category/cold-storage-freezer/>

2.3 Reefer Storage's Working Principle

In its system, the cooling system has four steps of cooling process. Refrigerant is circulated repeatedly with changes to support the cooling process. Four changes in the refrigerant are compression, condensation, expansion, and evaporation (liquid, vapor, gas, and liquid back) (Purnomo, 2013).

2.3.1 Compression

In the process of compression, refrigerant is pressed in the compressor until it becomes liquid at high temperature. The refrigerant gas sucked by the compressor will make the pressure remain low in the evaporator. To make a refrigerant liquid into a gas dynamically at low temperatures (0°C), the refrigerant gas is pressed in the cylinder, and turned into high, so the temperature and pressure rise, and will easily become a liquid refrigerant although the cooling process is in higher temperatures. And the compressed refrigerant gas is supplied to the next component which is cooled in a condenser.

2.3.2 Condensation

In the process of condensation, refrigerant is changed from a gas to a liquid and cooled down from high temperature in the condenser into lower temperature. A refrigerant that has high temperature and pressure is emitted into fluid in the condenser and transmitted to the receiver dryer to be filtered. It is also called heat condensation process. High heat from the refrigerant can be released by the condenser so that refrigerant is cooled down.

2.3.3 Expansion

In the process of expansion, the pressure of the refrigerant's liquid is lowered by the expansion valve. It is called expansion process, in which the pressurized gas is easily atomized in the evaporator so that refrigerant turns into gas, and the expansion valve regulates the flow of refrigerant's liquid while lowering its pressure. In the evaporator, this atomized

refrigerant's liquid is regulated by the cooling rate which should be done under temperature carburetion. Therefore, it is important to control the amount of refrigerant needed by performing proper checks.

2.3.4 Evaporation

In the process of evaporation, refrigerant is changed from liquid to gas in the evaporator. Refrigerant's liquid is atomized by its suction during the process of evaporation which needs latent heat from the air around the. The air released heat to be cooled down, and flowed into the space in the cold storage by the cooling fan while lowering the temperature of the room. The refrigerant's liquid is supplied from the expansion valve in the evaporator and then once turned into refrigerant vapor, and the change occurs repeatedly from liquid to gas. The pressure and the temperature in the change are always related, if the pressure is set then the temperature will also be set. For carburetion which is done when the temperature is lower than the change (liquid to gas), in the condition as above, the pressure in the evaporator must also be made low. Therefore, the atomized refrigerant gas should be reduced continuously out of evaporator by the compressor suction.

2.4 Cold Chain

Cold Chain is included as a part of the supply chain which is aimed to keep the temperature of the products so that the products are well maintained during the distribution process. The failure of the cold chain system is a failure of the entire activity experienced by a whole series of supply chain in maintaining the temperature range according to the product (Halim, 2013).

In order to get a proper cold chain system, there are four critical stages that must be observed very well in the frozen products' cold chain system, namely:

1. Handling during the initial processing.
2. Storing and processing when they arrive on land.

3. Handling during transportation to the country of destination.
4. Handling during loading-unloading and distribution systems to the customer (Halim, 2013).

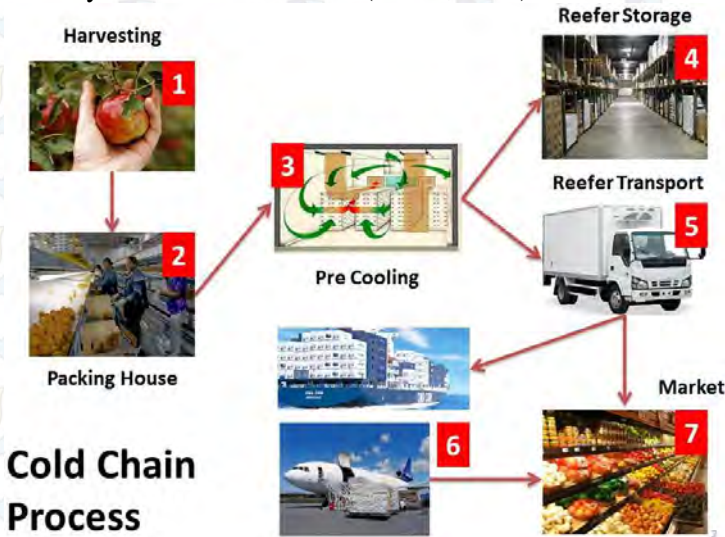

Figure 2.2. Cold Chain Process

Cold chain generally consists of freezing, storing in cold warehouses, transporting by means of refrigerated transport, placed in the cold cabinet in the shop/market, and eventually storing in the freezer at home.

2.5 Cooling Temperature of Horticultural Products

Watkins (2012) said that in order to maintain product quality of fruits and vegetables, periodic observation of the temperature in the storage room is needed so the temperature can be maintained properly in accordance with the required temperature range of each product. The cooling temperature range of fruits and vegetables can be seen in the following Table 2.2 and Table 2.3.

Table 2.2. Summary of Recommended CA or MA conditions during transport and/or storage of selected fruits

Commodity	Temperature Range* (°F)	CA†	
		%O ₂	%CO ₂
Apple	32---41	1---2	0---3
Apricot	32---41	2---3	2---3
Avocado	41---55	2---5	3---10
Banana	54---61	2---5	2---5
Blackberry	32---41	5---10	15---20
Blueberry	32---41	2---5	12---20
Cherimoya and atemoya	46---59	3---5	5---10
Cherry, sweet	32---41	3---10	10---15
Cranberry	36---41	1---2	0---5
Durian	54---68	3---5	5---15
Fig	32---41	5---10	15---20
Grape	32---41	2---5	1---3
		5---10	10---15
Grapefruit	50---59	3---10	5---10
Kiwifruit	32---41	1---2	3---5
Lemon and lime	50---59	5---10	0---10
Lychee (litchi)	41---54	3---5	3---5
Mango	50---59	3---7	5---8
Nectarine	32---41	1---2	3---5
		4---6	15---17
Nuts and dried fruits	32---50	0---1	0---100
Olive	41---50	2---3	0---1

Orange	41--50	5--10	0--5
Papaya	50--59	2--5	5--8
Peach, clingstone	32--41	1--2	3--5
Peach, freestone	32--41	1--2	3--5
		4--6	15--17
Pear, Asian	32--41	2--4	0--3
Pear, European	32--41	1--3	0--3
Persimmon	32--41	3--5	5--8
Pineapple	46--55	2--5	5--10
Plum	32--41	1--2	0--5
Pomegranate	41--50	3--5	5--10
Rambutan	46--59	3--5	7--12
Raspberry	32--41	5--10	15--20
Strawberry	32--41	5--10	15--20
Sweetsop (custard apple)	54--68	3--5	5--10

Source: Production Guide for Storage of Organic Fruits and Vegetables (Watkins et al., 2012)

Table 2.3. Summary of Recommended CA or MA conditions during transport and/or storage of selected vegetables

Vegetable	Optimum temperature (°F)*	Temperature range (°F)*	% O ₂ †	% CO ₂ †
Artichokes	32	32 to 41	2 to 3	2 to 3
Asparagus	36	34 to 41	Air	10 to 14
Beans (green snap)	46	41 to 50	2 to 3	4 to 7
Beans	46	41 to 50	8 to 10	20 to 30

(processing)				
Broccoli	32	32 to 41	1 to 2	5 to 10
Brussels sprouts	32	32 to 41	1 to 2	5 to 7
Cabbage	32	32 to 41	2 to 3	3 to 6
Cantaloupes	37	36 to 45	3 to 5	10 to 20
Cauliflower	32	32 to 41	2 to 3	3 to 4
Celeriac	32	32 to 41	2 to 4	2 to 3
Celery	32	32 to 41	1 to 4	3 to 5
Chinese cabbage	32	32 to 41	1 to 2	0 to 5
Cucumbers (fresh)	54	46 to 54	1 to 4	0
Cucumbers (pickling)	39	34 to 39	3 to 5	3 to 5
Herbs‡	34	32 to 41	5 to 10	4 to 6
Leeks	32	32 to 41	1 to 2	2 to 5
Lettuce (crisphead)	32	32 to 41	1 to 3	0
Lettuce (cut or shredded)	32	32 to 41	1 to 5	5 to 20
Lettuce (leaf)	32	32 to 41	1 to 3	0
Mushrooms	32	32 to 41	3 to 21	5 to 15
Okra	50	45 to 54	Air	4 to 10
Onions (bulb)	32	32 to 41	1 to 2	0 to 10
Onions (bunching)	32	32 to 41	2 to 3	0 to 5
Parsley	32	32 to 41	8 to 10	8 to 10
Pepper (bell)	46	41 to 54	2 to 5	2 to 5
Pepper (chili)	46	41 to 54	3 to 5	0 to 5
Pepper (processing)	41	41 to 50	3 to 5	10 to 20
Radish	32	32 to 41	1 to 2	2 to 3

(topped)				
Spinach	32	32 to 41	7 to 10	5 to 10
Sugar peas	32	32 to 50	2 to 3	2 to 3
Sweet corn	32	32 to 41	2 to 4	5 to 10
Tomatoes (green)	54	54 to 68	3 to 5	2 to 3
Tomatoes (ripe)	50	50 to 59	3 to 5	3 to 5
Witloof chicory	32	32 to 41	3 to 4	4 to 5

Source: Production Guide for Storage of Organic Fruits and Vegetables (Watkins et al., 2012)

2.6 Wireless Sensor Network (WSN)

Sensor is a device that has a function to convert physical quantities into other physical quantities such as electricity. A collection of several wireless sensors where each is placed in a special and its configuration is set can be called by Wireless Sensor Network (WSN) (Budi, 2012).

WSN is a wireless network that utilizes sensors to monitor physical or environmental conditions such as temperature, humidity, vibration, noise, electromagnetic waves, pressure, and others. This network was first developed on the basis of the needs in the military as a means of monitoring during the war. Currently WSN developed in the field of industrial and civil. In addition to one or more of a sensor, each node in a WSN is usually equipped with transceiver radio or other wireless communication device, a microcontroller, and an energy source, such as a battery.

The capabilities of wireless sensor made WSN widely used in monitoring. WSN can be used with a simple sensor that monitors a phenomenon, whereas for the complex sensor, each WSN will have more than one sensor so that it can do a lot of phenomenon monitoring. If WSN is connected to a gateway that can access the Internet, the WSN can be accessed and collaborate with other systems.

Some characteristics of wireless sensor networks, among others, are as follows.

- 1) The power is limited which can be saved or processed
- 2) The ability to survive in an environment that is not easy to reach and is controlled continuously
- 3) The ability to resolve the error of the node
- 4) The mobility of nodes
- 5) The dynamic network topology
- 6) Spread on a large scale

2.7 Application of Wireless Sensor Network (WSN)

Here are a few applications of Wireless Sensor Network (WSN):

1) Process Management

Area monitoring is a common application of WSN. In the monitoring of area, WSN is used more than one area where there are few phenomena that will be monitored. An example of the application in the military is the use of sensors to detect enemy intrusion; in the civil field is gas geo-fencing or oil pipelines. Area monitoring is the most important.

2) Health Care Monitoring

There are two types of medical applications: it can be used as wearable and implanted/implemented device. Wearable device is used on the surface of the human body or just near the user. Implantable medical device is inserted in the human body. There are many other applications such as the measurement of body position and location of the person, the overall monitoring of the patients in hospitals and at homes. Body-area network can collect information about health, fitness, and energy expenditure of individuals.

3) Environmental/Earth Sensing

There are many applications in monitoring environmental parameters, such as given below.

The background of the page is a repeating pattern of light blue gears, each containing a yellow lotus flower. The gears are arranged in a grid, and the lotus flowers are centered within each gear. The overall effect is a decorative, technical-themed background.

a. Air Pollution Monitoring

Wireless Sensor Networks have been deployed in several cities (Stockholm, London, and Brisbane). Its function is to monitor the concentration of harmful gases for the citizens.

b. Forest Fire Detection

Sensor Network Node can be installed in the forest to detect when a fire occurs. The nodes can be equipped with sensors to measure temperature, humidity, and gases produced by the fire in a tree or vegetation. Early detection is very important for fire-fighting measures; because of Wireless Sensor Networks, firefighters will be able to know when the fire broke out and how it spreads.

c. Landslides Detection

A landslide detection system uses a wireless sensor network to detect small movements on the ground and change various parameters which may occur before or during landslide. Through the collected data, it is possible to determine the occurrence of landslides long before they actually happen.

d. Water Quality Monitoring

Water quality monitoring involves analysis of the properties of water in dams, rivers, lakes, oceans, and underground water reserves. The use of many distributed wireless sensor enables the creation of a more accurate map of the water status, and allow the permanent deployment of monitoring stations in the difficult-to-access locations, without the need for manual data collection.



e. Natural Disasters Prevention

Wireless Sensor Networks can effectively act to prevent the consequences of natural disasters, such as floods. Wireless nodes have been successfully deployed in the river where the change of water level must be monitored in realtime.

4) Industrial Monitoring

a. Machine Health Monitoring

Wireless Sensor Networks have been deployed to condition-based machine maintenances (CBM) because they offer significant cost savings and enable new functions.

b. Data Logging

Wireless Sensor Network are also used for data collection for monitoring environmental information, this could be as simple as monitoring the temperature in the refrigerator to the water level in the overflow tank at nuclear power plants. Statistical information then, can be used to show how the system works.

c. Wasted Water Monitoring

Monitoring the quality and level of water covering a lot of activities such as checking the quality of underground water or surface water and ensure a country's infrastructure for the benefit of humans and animals. It can be used to protect water wastage.

d. Structural Health Monitoring

Wireless Sensor Networks can be used to monitor the condition of civil infrastructure and geo-physical processes closely associated to realtime, and for a long time through data logging, using the appropriate sensor is connected.

2.8 Components of Wireless Sensor Network

Wireless Sensor Network (WSN) generally has several components such as the following (Budi, 2012).

- a. Transceiver: has a function to receive/send data to other devices such as concentrator, WiFi modem, and RF modem.
- b. Microcontroller: has a function to perform the function of calculation, control and process several devices that are connected to the microcontroller.
- c. Power Source: has a function as a source of energy for WSN system as a whole.
- d. External Memory: has a function as an additional memory for WSN system, basically a microcontroller unit has its own memory unit.
- e. Sensor: has a function for sensing physical quantities to be measured. Sensor is a device that is able to convert one form of energy into another form of energy, in this case the change of the measured amount of energy into electrical energy which is then converted by the ADC into a row of quantized pulses that can be read by the microcontroller.

2.9 Working Principle of Wireless Sensor Network

Wireless Sensor Network (WSN) has a working principle wherein board sensors collect data such as light intensity, temperature, humidity, or the movement of objects in the room. Then mote transmits the sensing data to the gateway. Then gateway processes incoming sensing data and sends it to the server. After that the server will process the data from the gateway to display.

If the sensor reports the parameters that are passed through the limits specified, the server will give the command to the controller. Controller here has a function to control the switches to raise and lower the performance of electrical equipment.

2.10 Topology of Wireless Sensor Network

In its application, Wireless Sensor Network (WSN) has some types of topology that can be used. The topologies are as follows.

1) Bus Topology

In this topology, there is a node sends message to another node on the network sends a broadcast message onto the network that all other nodes see, but only the intended recipient actually accepts and processes the message (Sharma et al., 2013).

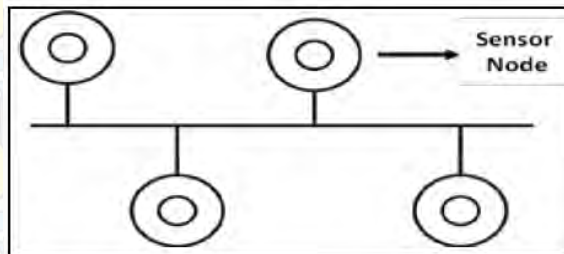

Figure 2.3. Bus Topology
Source: Sharma et al., 2013

2) Star Topology

Star networks are connected to a centralized communication hub and the nodes cannot communicate directly with each other (Sharma et al., 2013). The advantage of this topology is the existence of a separate cable for each workstation to the server makes the bandwidth in the wired communications will be widened so it will improve overall network performance. Moreover, if there is a disruption in the cable path interference will only occur in the communication between the workstation concerned by the server, and the others will not be impaired. The weakness of this topology is a need of more cables than other topologies.

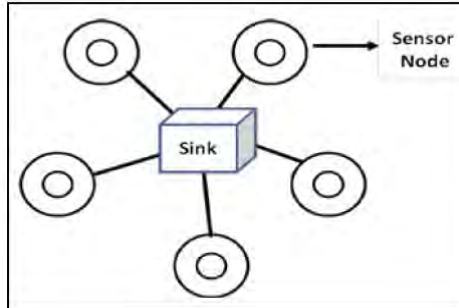

Figure 2.4. Star Topology
Source: Sharma et al., 2013

3) Tree Topology

Tree networks are also known as graded network topology. This topology is typically used for interconnection of central with a different hierarchy. The lower hierarchy is depicted on the lower location and the higher hierarchy is depicted on the higher location. As seen in Figure 2.5, the lower hierarchy typically forms star network (Sharma et al., 2013). This topology is suitable used for computer network system.

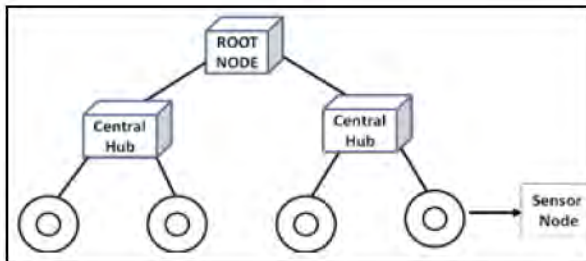

Figure 2.5. Tree Topology
Source: Sharma et al., 2013

4) Ring Topology

Ring topology is a topology where every node is connected to two other nodes and forms a circular path like a ring. A failure in node breaks the loop and can take down the entire network (Sharma et al., 2013). In order to anticipate the weakness, FDDI network sends all messages clockwise and counter-clockwise simultaneously.

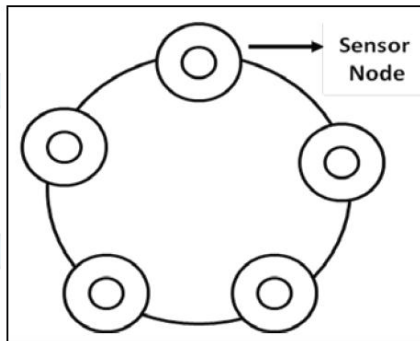

Figure 2.6. Ring Topology
Source: Sharma et al., 2013

5) Mesh Topology

Mesh topologies involve message can take any of several paths from source to destination. This network in which every node connects to every other is called a full mesh and there is partial mesh networks also exist in which some nodes connect only indirectly to others (Sharma et al., 2013). The complexity of the network is proportional to the increasing number of central installed. Thus, in addition to the less economical, it is also relatively expensive to operate.

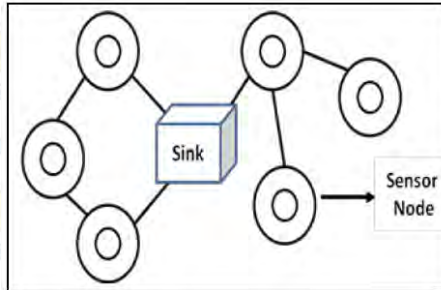

Figure 2.7. Mesh Topology
Source: Sharma et al., 2013

2.11 Thermocouple

Thermocouple is the type of temperature sensor used to detect or measure the temperature through two different types of metal conductors which are combined at the ends, giving rise to the effect of thermoelectric. Thermocouple is one type of the most popular temperature sensor and commonly used in a variety of circuits or electrical and electronic equipment related to temperature.



Figure 2.8. Thermocouple

Source: <http://artikel-teknologi.com/prinsip-kerja-thermocouple/>

Some of the advantages of thermocouple that make it popular are a rapid response to changes in temperature and also wide range of operational temperatures ranging between -200°C up to 2000°C . In addition to fast response and wide temperature range, Thermocouples are also resistant to shock/vibration and easy to use.

2.12 Working Principle of Thermocouple

Thermocouple working principle is quite easy and simple. Basically thermocouple consists of two wires of different kinds of metal conductors and coupled ends. One type of metallic conductors contained in Thermocouple will serve as a reference to a constant temperature (fixed), while the other one as a metallic conductor that detects heat.

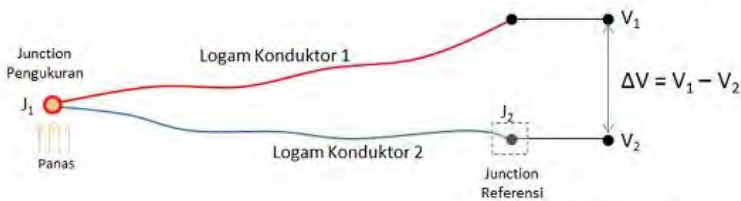

Figure 2.9. Thermocouple

Source: Kho, 2015

Based on Figure 2.9, when the two intersections or junctions have the same temperature, then the potential difference or electrical voltage through the two intersections is 0 or $V_1 = V_2$. However, when the intersection is connected in series given the high temperature or linked to the object of measurement, there will be a temperature difference between two junctions which then produces an electric voltage whose value is proportional to the temperature of the heat it receives or $V_1 - V_2$. Induced electrical voltage is generally about $1\ \mu\text{V} - 70\ \mu\text{V}$ at each degree centigrade. The voltage is then converted in accordance with a predetermined reference table.

2.13 Processing Analog-Digital Converter

In an industry, physical quantities such as temperature, pressure, fluid flow rate must be controlled. Generally, the controlling system uses PC, PLC, or SCADA. Basically, the physical quantities must be known by a digital system. The physical quantities converted into electrical quantities using sensors. The sensor output is usually in the form of voltage or current (4-20mA default). Then, the voltage/current is converted into a digital scale using ADC (Analog to Digital Converter) component.

1) Analog to Digital Converter (ADC)

ADC is a component that converts analog scale (in this case is the voltage that corresponds to the temperature) and converted into a digital scale. ADC has several important characteristics as follows:

- a. Input voltage range
- b. Bit resolution
- c. Sampling rate

2) Digital to Analog Converter (DAC)

DAC is the opposite of the ADC, which converts a digital scale into an analog scale (eg, voltage). They have same parameter such as bits of resolution. Normally, sampling rate is not stated in the DAC, since the digital-to-analog conversion takes place very quickly and simply depending on the speed of digital data that is sent to the DAC components.

2.14 Formula for Voltage-Temperature Value Conversion

The output of thermocouple is a voltage value which is very small (in the order of millivolts). In its application for reading temperature, the voltage value (millivolts) needs to be converted into temperature value (degree celcius). One of the ways is by using a conversion formula based on the tabulation of

several types of thermocouple. Those tables contain of several millivolts voltage converted from standard temperature values. These tables are used as references to determine temperature from millivolts manually.

Thermocouple reference tables are based on a reference junction of 0 degree celcius. If the reference junction is not at 0 degree celcius, then a correction factor must be applied. The following are the steps for calculating temperature from voltage (reference junction = 0 degree celcius):

1. Selecting the correct reference table for the thermocouple type in use. For examples: J, K, S, T, etc.
2. Locating the millivolt reading in the body of the table, and then reading from the margins the temperature value.

The thermocouple reference table can only be used directly to determine the temperature if the millivolts voltage is suitable to the value shown in it. For more accurate measurement, an interpolation can be made between two values. The following picture illustrates how the interpolation method is used to arrive at temperature values.

Milivolts Reading from table

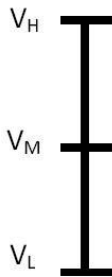

Temperature Reading from table

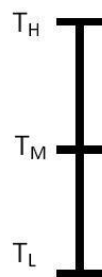

Figure 2.10. Interpolation Method

Source: <http://www.instrumentationtoolbox.com/2011/05/convertng-thermocouple-milivolts-to.html#axzz3wF5QLiTK>

Based on Figure 2.10, the following is the interpolation formula that can be used for the temperature measurement.

$$\frac{V_M - V_L}{V_H - V_L} = \frac{T_M - T_L}{T_H - T_L}$$

$$T_M = T_L + \frac{(V_M - V_L)(T_H - T_L)}{(V_H - V_L)}$$

Where:

- V_M = the measured voltage
- V_H = the higher voltage read from the table
- V_L = the lower voltage read from the table
- T_M = the calculated temperature
- T_H = the higher temperature read from the table
- T_L = the lower temperature read from the table

In addition, if the reference junction is greater than 0 degree celcius, it is needed to add the millivolt reading of the reference junction to the measured voltage while calculating temperature from voltage.

2.15 Stowage

In a container or reefer storage, stuffing cargo in it should be noted that the deployment of the temperature inside the container spread evenly. The evenly-spread temperature influences the preservation of the temperature quality required by horticultural products. It is also associated with the placement of the sensor node of WSN system where multiple sensor nodes placed in various corners of the container can read the same temperature or close to the same. Here is the laying of the cargo that is set by the Meditteranean Shipping Company:

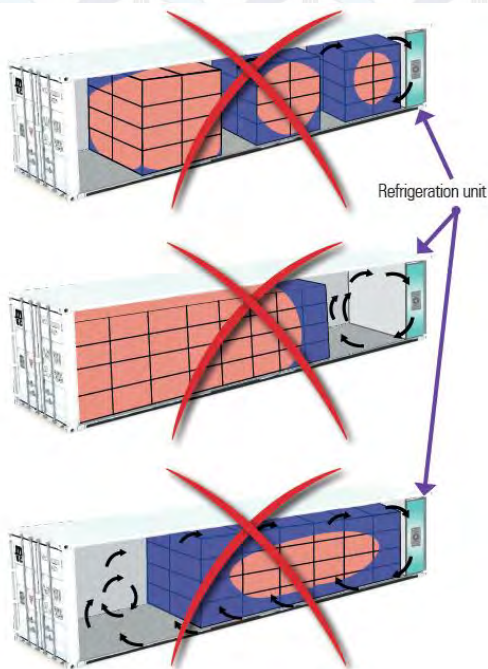

Figure 2.11. Incorrect-stuffing of the Container Cargo
Source: Mediterranean Shipping Company

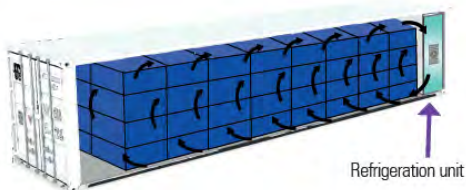

Figure 2.12. Correct-stuffing of the Container Cargo
Source: Mediterranean Shipping Company

In laying the cargo in the container should be noted that the container should be fully loaded and there is no gap among

the cargos. This is to keep the temperature equalization in the container as shown in Figure 2.12. If the cargo is not fully loaded, we need to give the additional fillers. The required cargo laying can also be seen in Figure 2.13 below.

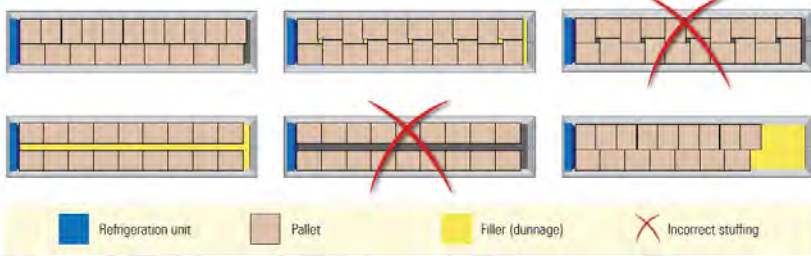

Figure 2.13. Top View of Cargo Stuffing
Source: Mediterranean Shipping Company

CHAPTER III RESEARCH METHODOLOGY

Experimental research was used as the research design of this study. In order to support the success of this research, it is necessary to choose a research methodology that can be used as a reference in the implementation of the research. This methodology contains some steps performed in the process of problems resolution contained in the research, starting from problem identification to preparing this final report. The stages that will be done to support this study are as follows.

3.1 Study of Literature

The first stage to do is doing study of literature by collecting and learning the supporting sources obtained from the library of Marine Machinery and System Laboratory of Marine Engineering Department; the library of Marine Technology Faculty; the central library of Sepuluh Nopember Institute of Technology; and the internet. These are the sources of this research:

- a. Books
- b. Journals
- c. Papers
- d. Articles
- e. Theses

Meanwhile, the literatures that will be studied are the Wireless Sensor Network (WSN), Reefer Storage, as well as Thermocouple sensor. In addition, researcher will also do a review of similar studies that had been conducted by other researchers.

3.2 Empirical Studies of Wireless Sensor Network (WSN) & Thermocouple

On this stage, researcher would collect the data that could support this thesis such as temperature and humidity required by

the products in the reefer storage, which in this case are fruits. The data will be used as a reference at a temperature monitoring experiments using both methods, the Wireless Sensor Network and Thermocouple sensors.

Preliminary Analysis and Requirement Specification

Once the data collection was done, empirical studies followed by an analysis of the initial monitoring system that would be used, in this case the Wireless Sensor Network and thermocouple sensors, analysis the specifications of components of both methods, and assessment and design to the layout of the sensor node and variables that would be used. The variables are as follows:

- a. Wireless Sensor Network (WSN) Method
 - Network topology: Star Network
 - Stowage / Stuffing
- b. Thermocouple Sensors Method
 - Stowage / Stuffing
 - Assumption of critical location

3.3 Experiment of Temperature Monitoring System Based on WSN Method

After the initial analysis was carried out, and the assessment and design layout of the sensor node, stowage/stuffing plan, variations of the network topology in the reefer storage were done, the next step is to conduct the first experiment using WSN. Before conducting the experiment, calibration of sensor nodes were carried out to ensure temperature sensing radius capabilities by installing sensor nodes and then performing a pre-trial temperature monitoring by selecting one farthest point in reefer storage to read the temperature. By using the ability of sensor nodes to read the temperature on the farthest radius means all points in reefer storage can be read properly. If the sensor nodes were not able to reach the farthest distance, the laying of the sensor nodes needed to be fixed.

After the installation was done, the sensor nodes were connected to the operator/data collector in the Laboratory of Marine Machinery and Systems wirelessly, using Wi-Fi. In the first experiment, the network was Star Network. It also carried a variation of placement of goods in the reefer storage. The results obtained were temperature and humidity values which would be read in the software that had been provided in realtime.

3.4 Experiment of Temperature Monitoring System Based on Thermocouple Sensors

The first experiment would be followed by a second experiment. That is temperature monitoring experiment using thermocouple sensors. In the second experiment, the laying of thermocouple sensors used based on the data of the sensor nodes' reading capabilities in the WSN method. The thermocouple sensors were connected to the data logger via cable, before the data were entered into the laptop/PC that had been provided to read the value of the temperature in the reefer storage. Data logger and laptop/PC would be placed close to the reefer storage. In this second experiment, the results obtained in the form of temperature values are read in real time based on variations in the arrangement of items and the assumption of critical locations that had been carried out.

3.5 Data Analysis

In this stage, the data of temperature and humidity that had been obtained from the results of both experiments would be processed and analyzed, mainly based on existing variables. The data are analyzed separately. They are the data analysis of the experiment results of the first experiment and the second experiment. The data that were analyzed previously were processed into comparison charts in accordance with the variation of the stowage and critical location on the thermocouple sensors method. The analysis of both of these data would be compared.

3.6 Method Comparison

In this stage, the data analyses of the two methods that had been analyzed earlier were compared. The final result of the method comparison is to know the efficiency and effectiveness of the temperature monitoring using WSN compared to the thermocouple sensors method.

3.7 Conclusion

After finishing all stages and making methods comparison, the conclusion of this thesis was drawn. This conclusion was expected to answer the purposes of the experiments that had been carried out. Then, there are also some suggestions that will be useful for the further similar studies.

3.8 The Flow Chart of the Research Methodology

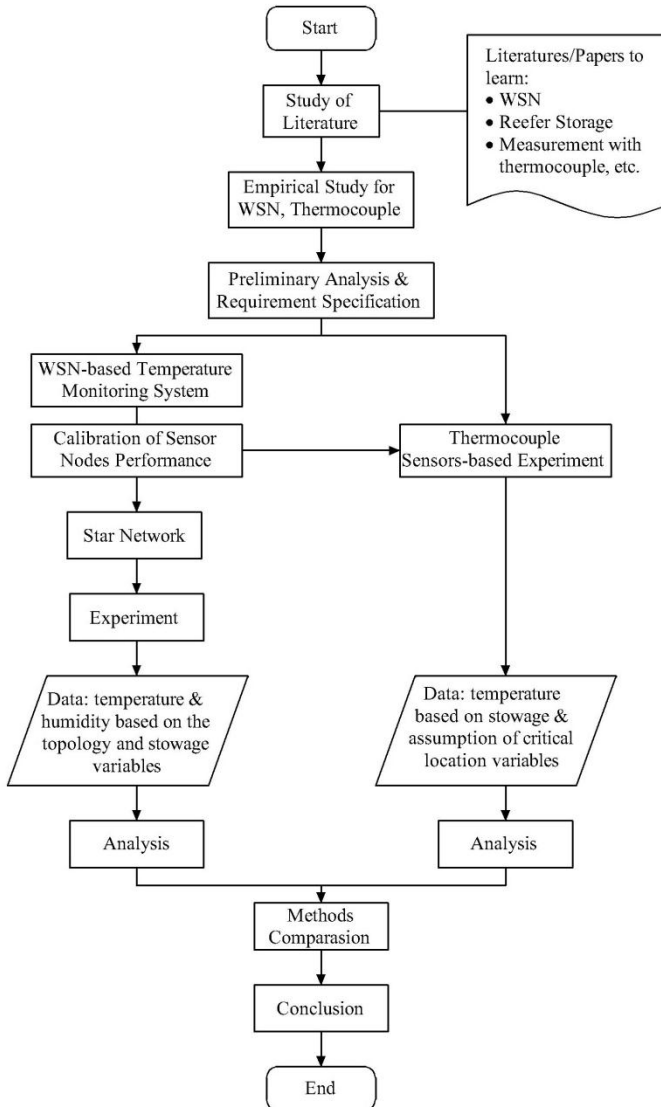

Figure 3.1. The Flow Chart of the Research Methodology

3.9 The Experiment Plot of Wireless Sensor Network Method

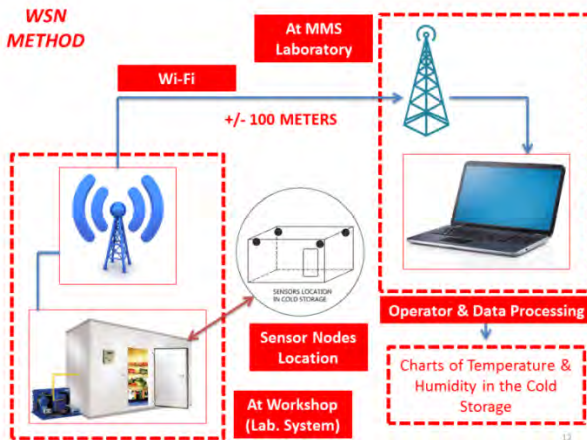

Figure 3.2. The Experiment Plot of Wireless Sensor Network Method

3.10 The Experiment Plot of Thermocouple Sensors Method

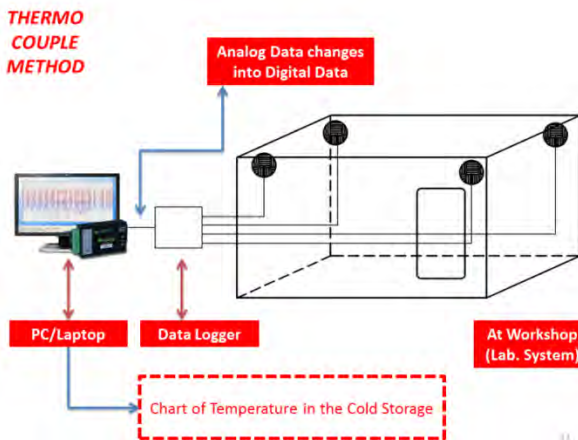

Figure 3.3. The Experiment Plot of Thermocouple Sensors Method

CHAPTER IV

RESEARCH PREPARATION AND PROCESS

This chapter describes the preparation and process of temperature and humidity data collection through the experiments of temperature monitoring system based on wireless sensor network and thermocouple sensors. Then, the data were processed and analyzed. The analysis results of both methods were compared to obtain more effective method to apply.

4.1 Experimental Apparatus

In order to support the temperature monitoring experiments based on wireless sensor network and thermocouple sensors in reefer storage, the following apparatus were used.

4.1.1 Cold Storage

Cold storage is a tool used for storing goods/products which needs to be stored and cooled down such as vegetables and fruits. Cold storage is the main component utilized for temperature monitoring experiments using both of wireless sensor networks and thermocouple sensors.



Figure 4.1. Cold Storage at MMS's Workshop

As seen on Figure 4.1, a cold storage has these following dimensions.

- Cold Storage : 2400 x 1160 x 2500 (mm)
- Freezer : 1230 x 960 x 2300 (mm)
- Chiller : 830 x 960 x 2300 (mm)

4.1.2 WSN Apparatus

Wireless Sensor Network experiment has these following equipments.

- a. Sensor Nodes: using DT-Sense SHT11 module and IR Temperature Sensor module; has a function to read the data of temperature and humidity in the reefer storage.
- b. Coordinator: using Arduino Mega 2560; has a function as the main controller to receive the data from sensor nodes and transmit it to the receiver.
- c. XBee Pro (transmitter and receiver): has a function as a wireless communication connected to WSN.
- d. Repeater: has a function to strengthen the transmission of the data from the sensors to the receiver.
- e. Program GUI: has a function to display the temperature and humidity monitoring data.
- f. Admin/Server: has a function as a computer connected to the receiver.

4.1.3 Thermocouple Apparatus

Thermocouple experiment has these following equipments.

- a. Thermocouple: using thermocouple type K; has a function to read the data of temperature in the reefer storage.
- b. Data logger: using LabJack T7 Pro; has a function as a data reader/logger connected to thermocouple sensors.

4.2 Data Collection Methods

Before conducting the experiment of both methods, it is necessary to get familiar with the methods used to collect the

data. The following schemes are the overviews of the implemented data collection methods.

4.2.1 Data Collection Method Based on Thermocouple Sensors

At this thermocouple data collection method, the data were taken from the thermocouple readings at several critical points in the reefer storage, and then they were logged in the data logger and displayed through the LJLogM software. As shown in Figure 4.2, the laptop and the data logger were placed close to the reefer storage and connected to thermocouple probes.

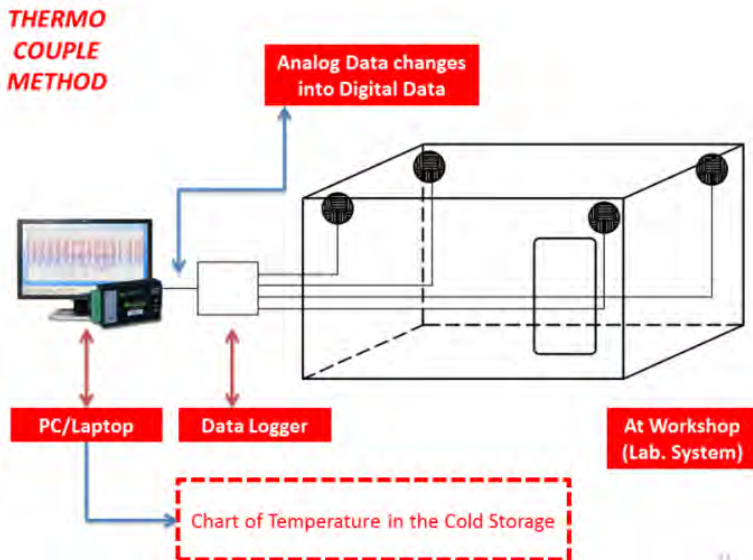

Figure 4.2. Thermocouple Scheme

4.2.2 Data Collection Method Based on Wireless Sensor Network

In the temperature and humidity data collection method, the data were taken from the readings made by sensor nodes that were installed at several points in the reefer storage. Those sensor nodes have XBee components that are useful to emit readable

data wirelessly. Then, the data were received by XBee receiver located far from the reefer storage, in this case was in Marine Machinery and Systems Laboratory. During the transmission process, the data were transmitted wirelessly using access point so they were sent to the receiver properly. Afterwards, those received data were displayed in the software installed in a laptop which was connected via a USB cable. Figure 4.3 is the WSN system schematic illustration.

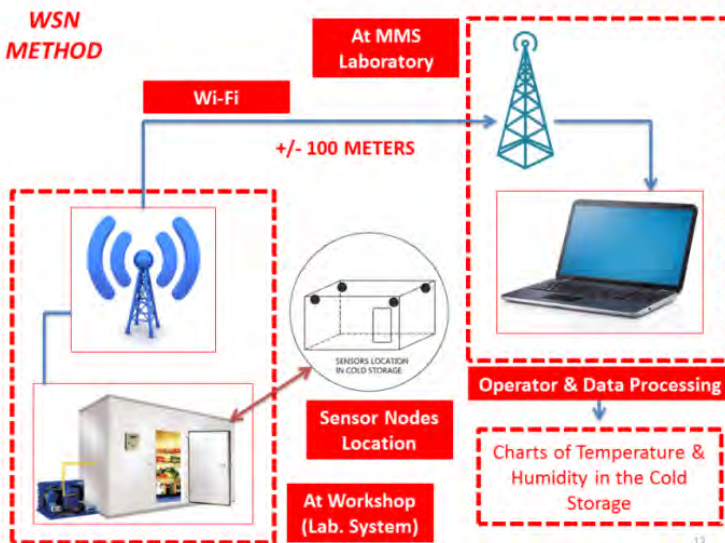

Figure 4.3. Wireless Sensor Network Scheme

4.3 Variables of Data Collection

In the experiments of temperature and humidity monitoring using thermocouple and wireless sensor network, there were some various things to determine the temperature and humidity readings on each variable. The following variables were used to support the experiments.

Table 4.1.Experiments Variables

Variables	Experiment Based on Thermocouple	Experiment Based on Wireless Sensor Network (WSN)
Control	Location of thermocouple sensors	Location of sensor nodes
Manipulation	<ul style="list-style-type: none"> • Stuffing • Assumption of thermocouple probes critical location 	<ul style="list-style-type: none"> • Topology Star • Using Coordinator • Stuffing
Response	<ul style="list-style-type: none"> • Temperature • Time 	<ul style="list-style-type: none"> • Temperature • Humidity • Time

4.4 Experimental Preparation of Thermocouple

Before conducting experiment of temperature monitoring based on thermocouple sensors, there were several things done as a preparation. One of them was arranging the experiment's equipments and installing and configuring the thermocouple equipments. The following were the preparation details of the experiment.

4.4.1 Apparatus Installation

The first thing to do in preparation for experiment using thermocouple sensors was assembling and installing the equipments required, such as thermocouple probes, a data logger, and a laptop. In figure 4.4 is the equipments installation of the experiment.



Figure 4.4. Apparatus Installation of Experiment Using Thermocouple

4.4.2 Installation & Configuration of Data Logger

After assembling and installing the equipments, the data logger supporting softwares of Labjack T7 Pro were installed to the laptop that was used in the experiment. They are Kipling and LJLogM softwares. Then, the installation was continued by configuring the data logger at Kipling by connecting the data logger to the laptop which was used to display the temperature data. The following were the configuration steps that had been implemented.



Figure 4.5. Main Display of Select Devices at Kipling

In the configuration of the Labjack T7 Pro data logger, the first step was starting Kipling software which was installed before. The initial view of Kipling when it first started was shown in Figure 4.5 where the data logger was detected on that software after it was installed on the laptop. The next step was entering the USB menu displayed on the initial view of Kipling by clicking it. It could be done if the laptop and the data logger were connected through the USB cable. It could also be connected via Ethernet and Wifi depending on researcher. The step was shown in Figure 4.6.



Figure 4.6. Connectivity Display of USB Menu at Kipling

After entering the USB menu, the Kipling display changed into Figure 4.7. There were several menus to operate and configure the data logger. In the device information menu, it should be ensured that the data logger had worked and connected properly. It could be seen on the Calibration Status which was read 'Good' and on the Device Temperature which showed that the temperature value was legible.



Figure 4.7. Devices Information Display at Kipling

The next step was entering the Analog Input menu to set the configuration of thermocouple probes attached to the data logger. Two things that needed to be set here were the type of attached thermocouple probes and the desired error range. As shown in Figure 4.8, there were several analog inputs ranging AIN0 – AIN13 that could be configured. The legible temperatures were voltage values (millivolts) that needed to be converted into the temperature values ($^{\circ}\text{C}$). The values conversion was done on the LJLogM software.

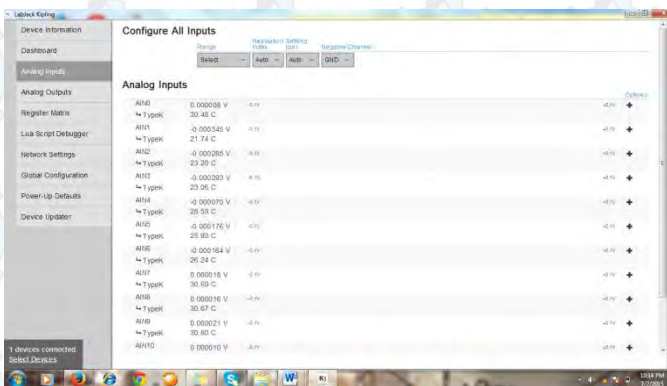

Figure 4.8. Configuration Display at Analog Input Menu

4.4.3 An Initial Data Collection for Data Logger Calibration

After configuring the data logger, the next step was performing the initial trial of LJLogM software which would be used to display the temperature data read by thermocouple sensors. For example, temperature monitoring was performed using two thermocouple sensors conducted at Marine Machinery and System Laboratory where the Air Conditioners were set to 27°C. The initial temperature data that had been read were shown on the display of LJLogM in Figure 4.9.

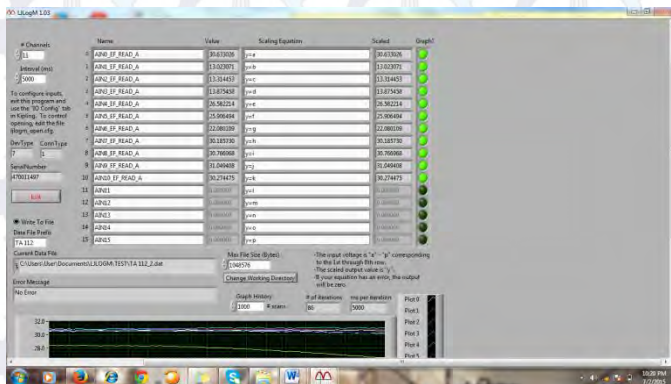

Figure 4.9. Main Display of LJLogM

While using LJLogM software, data conversion was needed to set where the data read by the thermocouple sensors were voltage data with units of millivolts. Therefore, data conversion was done to change voltage into temperature with units of °C by replacing the name of port's code. For example, Port 1 which was named AIN0 was changed into AIN0_EF_READ_A and so on. The conversions were shown in Figure 4.9.

4.4.4 Temperature Data Conversion

In the experiment using thermocouple, the data read by the Labjack T7 Pro data logger for the application of

thermocouple type K were displayed in millivolts (mv) so that the data displayed on LJLogM were small even close to 0 mv. In order to know the readable temperature values, they needed to be converted from voltage into temperature values. According to the Voltage-Temperature conversion method in Chapter 2, researched used the type K thermocouple reference table and calculated the temperature values by applying an interpolation method. The following were several millivolts voltage data sample read by thermocouple for 30 seconds.

Table 4.2. Voltage Data Sample

Time (s)	Voltage (mV)	Time (s)	Voltage (mV)
2	1.0612	18	1.0508
4	1.0595	20	1.0509
6	1.0578	22	1.0481
8	1.0569	24	1.0463
10	1.0560	26	1.0439
12	1.0552	28	1.0427
14	1.0542	30	1.0395
16	1.0535		

After recording the data sample, the interpolation method was applied. The following was the example of the calculation of the first data sample ($V_M = 1.0612$ mV).

$$T_M = T_L + \frac{(V_M - V_L)(T_H - T_L)}{(V_H - V_L)}$$

According to the type K thermocouple reference table, the value of V_M is between 1.041 mV and 1.081 mV and the value of T_M should be between 26 °C and 27 °C. Based on these, the value of T_M could be calculated.

$$\begin{array}{ll} V_M & = 1.0612 \text{ mV} & T_M & = \text{calculated} \\ V_H & = 1.081 \text{ mV} & T_H & = 27 \text{ }^\circ\text{C} \\ V_L & = 1.041 \text{ mV} & T_L & = 26 \text{ }^\circ\text{C} \end{array}$$

$$T_M = T_L + \frac{(V_M - V_L)(T_H - T_L)}{(V_H - V_L)}$$

$$T_M = 26 + \frac{(1.0612 - 1.041)(27 - 26)}{(1.081 - 1.041)}$$

$$T_M = 26 + \frac{(0.0202)(1)}{(0.04)} = 26 + 0.0505 = 26.505$$

Thus, the temperature value of thermocouple reading was 26.505 °C or could be 26.51 °C.

# Channels	Name	Value
11	AIN0_EF_READ_A	30.633026
	AIN1_EF_READ_A	13.023071
	AIN2_EF_READ_A	13.314453
	AIN3_EF_READ_A	13.875458
	AIN4_EF_READ_A	26.582214
	AIN5_EF_READ_A	25.906484

To configure inputs, exit this program and use the "IO Config" tab in Kipling. To control

Figure 4.10. Automatic Voltage-Temperature Conversion Code

In order to ease recording or reading the temperature data, the conversion from voltage value to temperature value could be set automatically by setting the AIN code shown in LJLogM software. For example, Port 1 showed AIN0 as the default code. It should be replaced by AIN0_EF_READ_A to convert the data. If Port 1 (with AIN0 code) first showed 1.0612 mV, it would change into 26.51 °C and all data which were recorded would be automatically saved in temperature value (°C).

4.5 Experiment Preparation of Wireless Sensor Network

Before conducting experiment of temperature monitoring based on wireless sensor network, there were several things done as a preparation. One of them was preparing the experiment's apparatus and installing and configuring them. The following were the preparation details of the experiment.

4.5.1 WSN Apparatus Installation

The first thing to do in preparation for experiment using wireless sensor network was assembling and installing the equipments required, such as sensor nodes, a coordinator, a repeater, a receiver module, and a laptop. Figure 4.11 is the apparatus installation of the experiment.

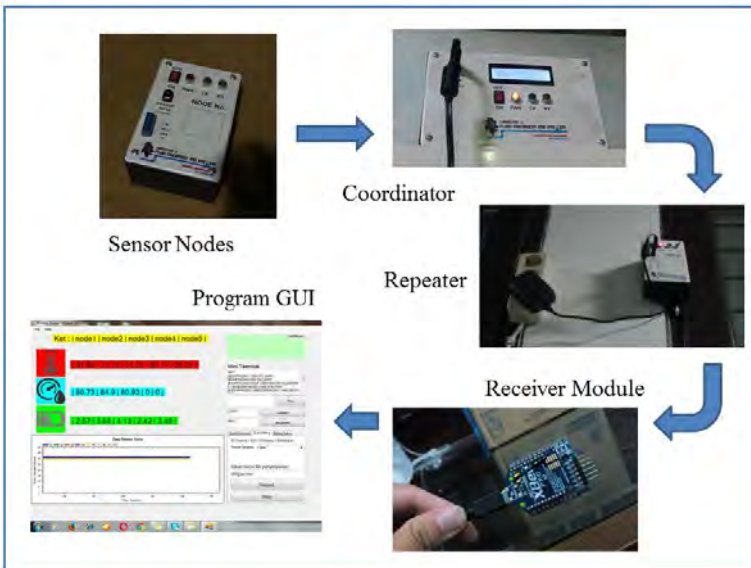

Figure 4.11. WSN Apparatus Installation

Based on Figure 4.11, the following are the details of the installation process of WSN apparatus.

- 1) This experiment used 5 sensor nodes to read the data of temperature and humidity. These all nodes were placed inside the cold storage located in the workshop of Marine Machinery and System Laboratory and the placement location was based on the thermocouple sensors placement. These sensor nodes read the data and transmit them to one coordinator located outside the cold storage.



Figure 4.12. Sensor Node Located in the Top Side of Cold Storage

Those 5 nodes were named Node 1 – Node 5 which had the following details:

- a. Node 1, Node 2, Node 3 used DT-sense SHT11 module as the sensor, these were used to read both of temperature and humidity.
 - b. Node 4 and Node 5 used IR-Temperature Sensor module as the sensor, these were used to read temperature only.
- 2) One coordinator was installed in this experiment which has a function to receive and collect all the data read by sensor nodes, and then transmit them to the receiver. The following is the coordinator which was placed outside the cold storage in the workshop of Marine Machinery and System Laboratory.



Figure 4.13.Coordinator of WSN System

- 3) In order to strengthen the transmission process of the data from the coordinator to the receiver module, it was necessary to install the repeater. This repeater was placed in the other building where the receiver module was located and it was outside Marine Machinery and System Laboratory (100 – 150 meters from the workshop).

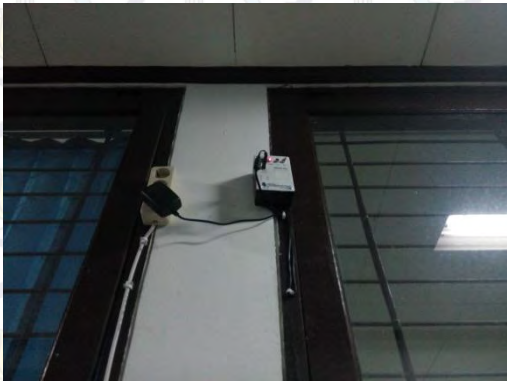

Figure 4.14.Repeater

- 4) All data transmitted by the coordinator were received by the receiver module which was connected to the laptop and was

located inside the laboratory of Marine Machinery and System. Then, these data were displayed through a software named Program GUI.



Figure 4.15. Receiver Module

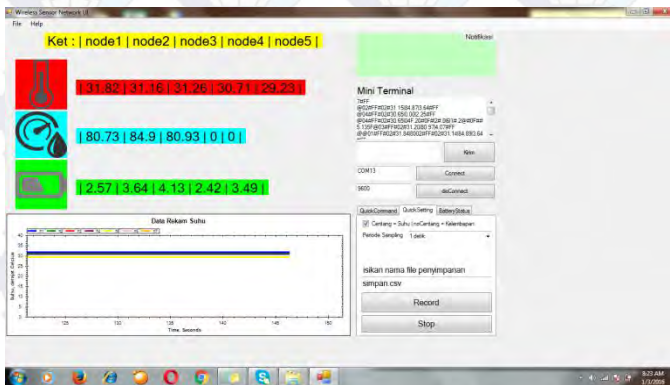

Figure 4.16. Program GUI

Figure 4.15 is the receiver module which has two kinds of light. The first light is yellow. It would turn on when the receiver had already been connected to the laptop. The second one is the red light which works like a flipflop and it turned on as a code of the command for the coordinator to transmit

the data. Figure 4.16 is Program GUI, a software used to display all the data of temperature, humidity, and also battery that were received by the receiver module. These data would be recorded through this software and saved into the Excel file.

4.6 Apparatus Calibration

Before conducting experiment using both of thermocouple sensors and WSN sensor nodes, the sensors were calibrated. This calibration was performed to identify whether or not the sensors could work properly and can read the temperature appropriately. The researcher hereby applied the calibration process to the experimental main apparatus which were the thermocouple type K, DT-sense SHT11 sensor module, IR (infrared) temperature sensor module, and the reefer storage's thermocouple sensor. By this calibration, the performance of all sensors to read temperature at the same time and condition were compared, as well as their error standard referred to the reefer storage's thermocouple sensor were found out.



Figure 4.17. Apparatus Calibration

Figure 4.17 shows one of the procedures of apparatus calibration. The following steps were the calibration process done by the researcher.

1. All sensors were placed on the same place (under the evaporator) and connected to each system like as Labjack T7 Pro for the thermocouple type K and the coordinator and receiver module of WSN system for the sensor nodes.
2. The softwares of each system were started. In addition, in order to record the temperature data read by the reefer storage's thermocouple sensor, a digital camera was used.
3. The reefer storage's evaporator was set on 27 °C with the differential of 1 °C and the data were recorded during this condition only.
4. After all preparations were done, all the record buttons (of LJLogM software, WSN Program GUI, and digital camera) were clicked at the same time. The softwares were set to record the data every 2 seconds.

The researcher had collected around 90 temperature data for each sensor after taking 3 minutes for recording temperature. Afterwards, the data were processed and analyzed, as well as the deviation standards were calculated. The calibration results can be seen on Chapter 5.

4.7 Stowage Plan and Stuffing

In addition to the pre-experiment preparation in the form of software configuration and data logger and thermocouples calibration, cargo stowaging or stuffing in reefer storage was also planned and performed. It was performed because cargo was the most important part of the experiment.

According to the rules about cargo stowaging and stuffing in reefer storage, in this research, a shelf where several fruit cardboards would be stuffed was designed. The design referred to the dimension of freezer in reefer storage so there would be suitable cargo stuffing results.

Based on the planned design, the shelf had dimensions about 750 mm length, 500 mm width, and 1500 mm height, where there were three layers in it. In order to complete the stowage

plan, there were 14 fruit cardboards which were chosen. All cardboards had the same dimension about 500 mm length, 310 mm width, and 170 mm height. Figure 4.18 (a) and 4.18 (b) were the results of stowage and cargo stuffing plan in reefer storage.



Figure 4.18 (a) Shelf Design, (b) Cargo Stuffing Plan in Reefer Storage

After making a shelf and planning the cargo stuffing, the preparation was followed by filling the cargo, where the fruit cardboards were filled with some bananas as cargos. These bananas represented the fruits belonged to horticultural products which needed cooling process. These bananas could emit etilen gas and experienced respiration so that they were perishable. Thus, they would be cooled down and their temperature should be

kept to prevent spoilage, so that the quality would be well preserved. According to the Production Guide for Storage of Organic Fruits and Vegetables, the bananas temperature should be kept in the range of 54 – 61 F or 12 – 16 °C. That range was a reference for the experiments that were done. Figure 4.19 was the cargo filling process.



Figure 4.19. Bananas as Cargo in Reefer Storage

4.8 Thermocouple Sensors and Sensor Nodes Placement

In order to complete the preparation of the temperature monitoring experiment based on thermocouple sensors, the next step was placing the thermocouple sensors into some points in reefer storage. The placement referred to the critical location of the temperature spread within reefer storage. These critical locations (the researcher determined five locations) were used not only for placing the thermocouple sensors, but also for placing the sensor nodes in the experiment using wireless sensor network so that both of thermocouple sensors and sensor nodes could read the temperature at the same location.

In addition, there were three additional thermocouple sensors placed inside the cold storage and also inserted to the banana in order to find out how long the bananas need to be cooled down starting from the normal temperature to the

temperature required (related to the pre-cooling time) as seen on Figure 4.20.



Figure 4.20. Thermocouple Placement in the Cargo

For more details, Figure 4.21 and 4.22 were the overview of thermocouple sensors placement within reefer storage. This placement plan was also used to determine the location of WSN sensor nodes.

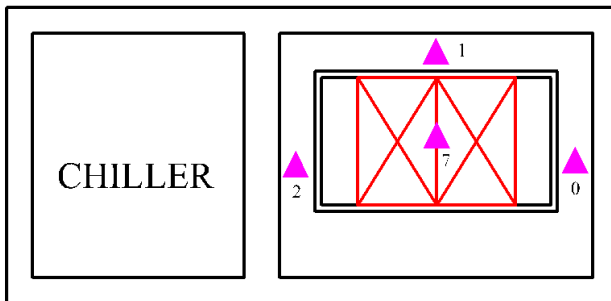

Figure 4.21. Top View of Sensors Placement

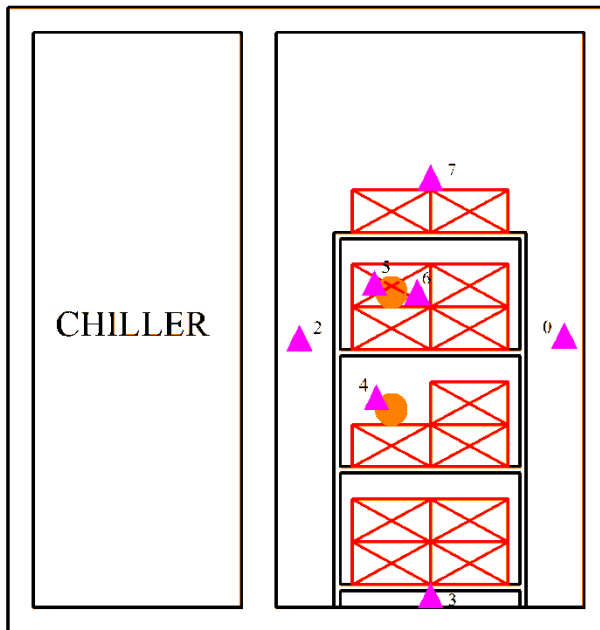

Figure 4.22. Front View of Sensors Placement

Explanations:

1) Placement of Termocouple Sensors

AIN 0 = on the left side of cargo

AIN 1 = behind the shelf

AIN 2 = on the right side of cargo

AIN 3 = under the shelf

AIN 4 = inserted to a banana outside the cardboard (3rd layer)

AIN 5 = inserted to a banana inside the cardboard (2nd layer)

AIN 6 = inside the cardboard (2nd layer)

AIN 7 = on the top side of cargo

2) Placement of Sensor Nodes

Node 1 = on the left side of cargo (similar to AIN 0)

Node 2 = on the right side of cargo (similar to AIN 2)

- Node 3 = on the top side of cargo (similar to AIN 7)
 Node 4 = under the shelf (similar to AIN 3)
 Node 5 = inside the cardboard (similar to AIN 6)

Those thermocouples were connected to eight ports of Labjack T7 Pro data logger, namely AIN0 – AIN7, to transmit the temperature data wirely. On the other hand, sensor nodes wirelessly transmitted the data to the coordinator. Furthermore, the experiment based on thermocouple sensors was conducted to read the temperature from every port and so did the experiment based on wireless sensor network.

4.9 Air Flow Rate Measurement

In order to complete the preparation, air flow rate measurement was done. This measurement was aimed to control the air flow rate released by the evaporator. Before doing the measurement, the researcher calculated air flow rate needed by reefer storage. This calculation was based on air flow rate of Daikin 40ft reefer container. The following was the calculation.

Daikin 40ft Reefer Container

Air flow rate = 96.3 m³/min
 Volume = 63.25 m³

Reefer Storage Workshop MMS

P x L x T = 1 x 1.25 x 2.3 m
 Volume = 2.875 m³
 Air flow rate = (2.875 / 63.25) x 96.3
 = 4.377 m³/min
 = 262.62 m³/h
 = 0.073 m³/s

Based on the aforementioned calculation, reefer storage needs air flow rate only 262.62 m³/h. However, the specification of reefer storage's evaporator shows that air flow rate released is 1224 m³/h or 0.34 m³/s. Thus, reefer storage in Workshop of

Marine Machinery and System had been modified by the previous researcher. The modification was done by closing the evaporator by adding a case which has smaller rectangular hole where the cooling air released as seen on Figure 4.23.



Figure 4.23. Modification of the Evaporator

The modification is completed by a plate that can be controlled. It can be used to reduce air flow rate as needed. In order to control air flow rate value $0.073 \text{ m}^3/\text{s}$, the researcher hereby used anemometer, a tool to measure the air velocity value, as seen on Figure 4.24.



Figure 4.24. Anemometer

4.10 Experimental Procedure of Temperature Monitoring Based on Thermocouple Sensors

The first temperature monitoring experiment was conducted based on thermocouple sensors. In this experiment, the temperature of thermocouples installed to some points within reefer storage were read by Labjack T7 Pro data logger and the values were displayed on LJLogM software as seen in Figure 4.25.



Figure 4.25. Labjack T7 Pro Installation during Experiment

During this experiment, reefer storage should cool down the freezer in the range of 12 – 16 °C as required. Then, it was set in 14 °C with the differential of 2 °C. There were two times of monitoring data using thermocouple sensors. The first monitoring was started from normal temperature (31 °C). It was conducted to record temperature data every two seconds (interval) and waited until all temperatures reached equilibrium. There were two kinds of equilibrium used in this experiment. The first equilibrium occurred when all thermocouple sensors located in AIN 0 – AIN 3 and AIN 6 – AIN 7 showed the equal temperature (and had already been in the range of 12 – 16 °C). Furthermore, the second equilibrium occurred when all thermocouple sensors including AIN 4 – AIN 5 showed equal temperature (and had already been

in the range of 12 – 16 °C). This monitoring was aimed to find out the time needed by banana with normal temperature to be pre-cooled and to determine which type of cargo could be cooled down faster.

The second monitoring was recorded from maximum required temperature (16 °C). It was done at the same time with the monitoring experiment using WSN sensor nodes. Both of them took several hours data monitoring. The data used as the sample of methods comparison. As mentioned on Table 4.1, the manipulated variables used in this experiment were the stowage plan and the assumption of critical locations, where there were two kinds of stowage varied. They were cargo with and without cardboards. Moreover, the critical locations were assumed in some points of freezer as seen in Figure 4.21 and 4.22. All the data were recorded into an excel file of Microsoft Excel.

4.11 Experimental Procedure of Temperature Monitoring Based on Wireless Sensor Network

The second temperature monitoring experiment was conducted based on wireless sensor network by using sensor nodes to read the temperature and humidity in reefer storage. To apply Wireless Sensor Network, the researcher used several apparatus. There were five sensor nodes, a coordinator, a repeater, a receiver, and a software named Program GUI (see Figure 4.11).

This experiment was conducted at the same time with the first experiment using thermocouple sensors, so the experimental procedure was same which reefer storage was set in the range of 12 – 16 °C (in 14 °C with the differential of 2 °C). The temperature data were monitored starting from the maximum required temperature (16 °C) every two seconds and recorded for several hours.

The difference between this experiment and the experiment using thermocouple was this worked wirelessly. The nodes placed in reefer storage read temperature and then transmitted the data to the coordinator wirelessly. After that, the

coordinator transmitted the data to the receiver module which was placed far from them (over 100 meters length). In this case, reefer storage was in the workshop of MMS (Marine Machinery and System) Laboratory and the receiver module was in MMS Laboratory itself as seen in Figure 4.26.



Figure 4.26. Receiver Module Connected to the Laptop

In this experiment, the researcher applied star topology which has a coordinator where all the sensor nodes could directly transmit the data to it.

4.12 Star Topology of the WSN Experiment

Star topology is one of several topologies that are used to describe a network. In this topology, every sensor node was connected wirelessly to a centralized communication hub (in this case was called a coordinator). They could not connect with each other. The researcher used 2 places to conduct the experiment of wireless sensor network, they were Marine Machinery and System laboratory and workshop.

Reefer storage used as the main media of this experiment was placed inside the workshop, where all sensor nodes were located within it. Beside that, the coordinator was also located on the top-outside of reefer storage in the workshop. On the other

hand, the repeater and the receiver module were placed in the laboratory of MMS which is located over 100 meters from the workshop. The scheme of this topology can be seen in Figure 4.27.

Star topology itself could be built up by programming the components of the apparatus. For example, sensor nodes are completed by sensors to read temperature and XBee Transceivers which are used as transmitting and receiving modules. In order to make them work as seen on the scheme, those components need to be programmed.

In this WSN system, the sensor nodes were programmed to read and transmit the data. The coordinator was programmed to give the nodes a command to transmit the data and also to continue transmitting the data (this apparatus was not completed by any sensor), so did the repeater and the receiver module. They were programmed to continue or strengthen the data transmission (for repeater) and to receive the data (for receiver).

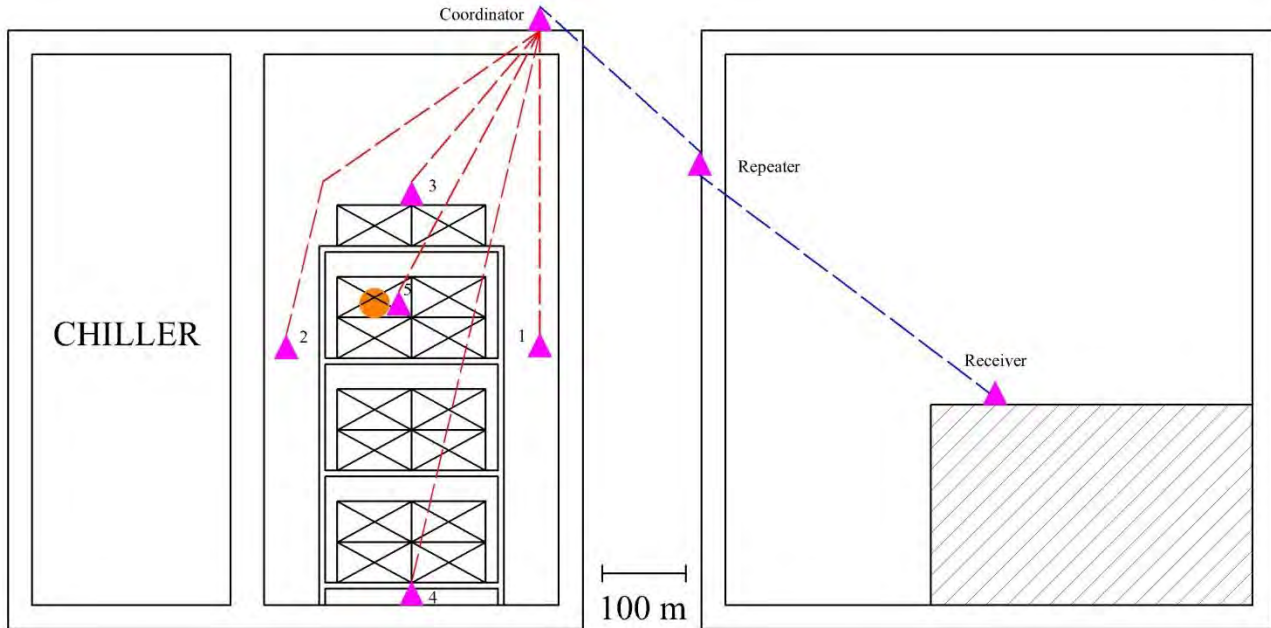

IN WORKSHOP

IN LAB MMS

Figure 4.27. Scheme of Star Topology

CHAPTER V RESEARCH FINDINGS AND DATA ANALYSIS

5.1 Results of Apparatus Calibration

There were four kinds of sensors that have been calibrated, they were thermocouple sensors Type K, reefer storage's thermocouple sensor, DT-sense SHT11 sensor module, and IR temperature sensor. All sensors were placed on the same place based on the location of reefer storage's thermocouple sensor. They were used to monitor temperature in several temperature conditions. Those conditions were 25 °C, 13 °C, 5 °C, 0 °C, and -20 °C based on the temperature setting of the reefer storage. The data were recorded every 2 seconds for around 3 minutes when the temperature read by reefer storage's thermocouple sensor were constant. The following was the sample of the data recorded by the researcher.

Table 5.1.Data Sample Taken from Temperature Setting 25 °C

Time	SHT11	IR	Type K	Thermo
11:31:30 AM	26.31	24.03	28.08	25.00
11:31:32 AM	26.31	24.03	27.03	25.00
11:31:34 AM	26.31	24.03	25.59	25.00
11:31:36 AM	26.31	24.03	26.92	25.00
11:31:38 AM	26.31	24.03	28.73	25.00
11:31:41 AM	26.31	24.03	27.34	25.00
11:31:43 AM	26.31	24.03	26.10	25.00
11:31:45 AM	26.31	24.03	26.82	25.00
11:31:47 AM	26.31	24.03	27.92	25.00

A data measurement was done owing to the lack of precise data shown by any single data. They were processed by calculating the mean temperature and the deviation standard of each sensor. The following was the calculation of the data.

Table 5.2. Mean of Data Sample

	-20	0	5	13	25
SHT 11	-18.91	0.73	6.45	15.23	26.31
IR	-21.11	-0.36	5.20	13.62	24.09
Type K	-17.61	3.14	8.06	15.93	27.29
Thermo	-20.00	0.00	5.00	13.00	25.00
Mean	-19.41	0.88	6.18	14.45	25.67

Based on the aforementioned data table, Figure 5.1 shows the chart characteristics of the temperature monitored in five temperature condition.

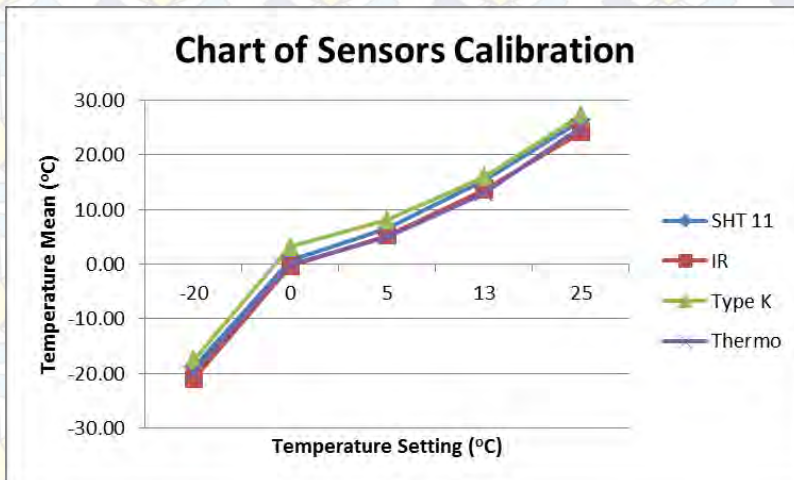

Figure 5.1. Chart of Sensors Calibration

As seen on Figure 5.1, they have similar lines which there are a number of measurements that are very close to each other. These ranges in values represent the uncertainty error occurred in the measurement. In order to find out if the sensors' performances reading temperature were different, the chart was transformed into a line graph showing the mean temperature values as seen below.

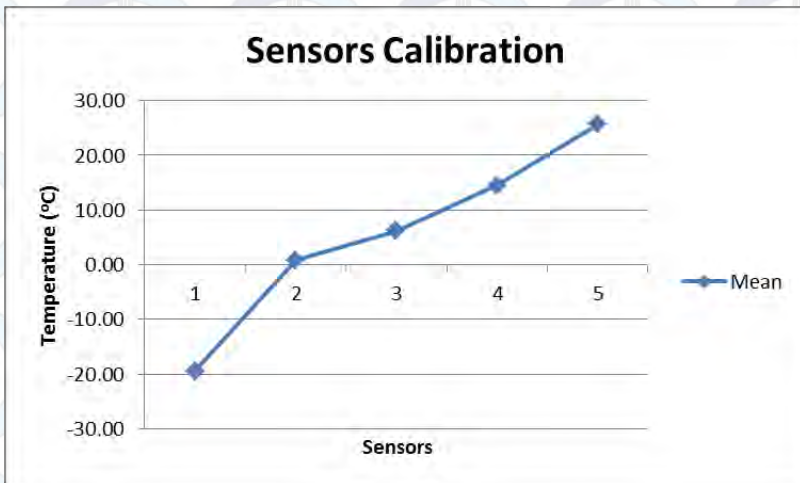

Figure 5.2. Chart Based on Mean Data of Sensors Calibration

These mean values could not be used to determine the difference of the sensors' performances in reading temperature and the true value of the temperature. It still needed additional information to indicate how close the means are likely to reflect the true values, and that is error bars information.

There are two ways that can be used to describe the uncertainty error in the measurements. The first way is based on the standard deviation of a single measurement and the other one is based on the standard deviation of the mean or standard error. The researcher hereby used standard error to statistically describe the uncertainty error. To calculate the standard error, firstly was by calculating the value of standard deviation. After it was calculated, the standard error could be calculated by dividing the value of standard deviation with the square root of number of measurements that made up the mean (N).

$$\text{Standard error} = \frac{\text{Standard deviation}}{\sqrt{N}}$$

Based on the formula, the greater the number of measurements, the smaller the standard error would be. This reflects the greater confidence that the researchers have in the mean value as they make more measurements. The following was the formula and the sample of standard deviation calculation applied in 20 °C.

$$s = \sqrt{\frac{n \sum_{i=1}^n x_1^2 - (\sum_{i=1}^n x_1)^2}{n(n-1)}}$$

Table 5.3. Table of Standard Deviation Calculation

i	x1	x1 ²
1	-18.91	357.71
2	-21.11	445.47
3	-17.61	310.26
4	-20.00	400.00
Sum	-77.63	1513.45

Where:

So, the standard deviation is

$$s = \sqrt{\frac{4(1513.45) - (-77.63)^2}{4(4-1)}}$$

$$s = \sqrt{\frac{6053.78 - 6026.99}{12}} = 1.49$$

and the standard error is

$$\text{Standard error} = \frac{1.49}{\sqrt{4}} = 0.75$$

The details value of standard deviation and standard error can be seen on the following table.

Table 5.4. Table of Standard Deviation and Standard Error Calculation

	-20	0	5	13	25
SHT 11	-18.91	0.73	6.45	15.23	26.31
IR	-21.11	-0.36	5.20	13.62	24.09
Type K	-17.61	3.14	8.06	15.93	27.29
Thermo	-20.00	0.00	5.00	13.00	25.00
Mean	-19.41	0.88	6.18	14.45	25.67
S.Dev	1.49	1.57	1.41	1.36	1.41
S.Error	0.75	0.79	0.70	0.68	0.70

From the data above, the sensors calibration chart could be transformed into the chart completed by the standard error as seen in Figure 5.3.

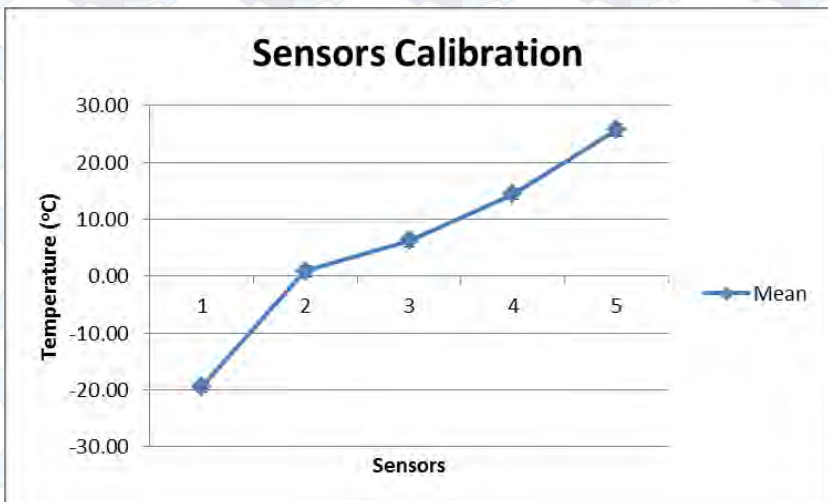

Figure 5.3. Chart Based on Mean Data and Standard Error of Sensors Calibration

In several conditions of temperature that have been done, the temperature data in 13 °C condition was the most precise data since it has the smallest value of standard error compared to the other temperature conditions. These data could be used as the reference of monitoring system in this research.

5.2 Findings of Experiment Based on Thermocouple Sensors (Monitoring 1)

Based on the first experiment, the result data shown in Table 5.5 were the first 30 seconds data sample taken from 14,543 total data. As mentioned in the experimental procedure in Chapter 4, the data were collected in the interval of 2 seconds so that there were 30 rows of data sample for 30 seconds. The researcher took more than 8 hours during the monitoring process in order to make sure that all thermocouples' temperature had been lower than the maximum required-temperature for banana (lower than 16 °C).

Table 5.5. Data Sample of Thermocouple-based Experiment (Monitoring 1)

	Left	Behind	Right	Bottom	Cargo 1	Cargo 2	Box	Top
Time (s)	AIN 0	AIN 1	AIN 2	AIN 3	AIN 4	AIN 5	AIN 6	AIN 7
1	30.30	29.99	30.28	29.69	33.21	34.03	32.23	29.77
3	30.20	29.95	30.21	29.64	33.21	34.05	32.25	29.66
5	30.13	29.87	30.11	29.52	33.22	34.06	32.28	29.59
7	29.99	29.75	30.06	29.42	33.23	34.06	32.25	29.45
9	29.96	29.72	29.99	29.33	33.24	34.07	32.25	29.38
11	29.80	29.56	29.86	29.21	33.19	34.06	32.20	29.22
13	29.76	29.49	29.78	29.13	33.22	34.05	32.24	29.12
15	29.66	29.37	29.69	29.04	33.22	34.07	32.20	29.02
17	29.54	29.31	29.61	28.94	33.20	34.06	32.17	28.95
19	29.47	29.23	29.51	28.87	33.24	34.07	32.17	28.86
21	29.37	29.12	29.42	28.73	33.23	34.09	32.17	28.76
23	29.28	29.04	29.39	28.67	33.20	34.07	32.16	28.65
25	29.16	28.95	29.27	28.57	33.20	34.06	32.15	28.55
27	29.09	28.84	29.21	28.46	33.23	34.07	32.16	28.45
29	28.97	28.75	29.12	28.36	33.20	34.07	32.10	28.33

Thermocouple-based Experiment

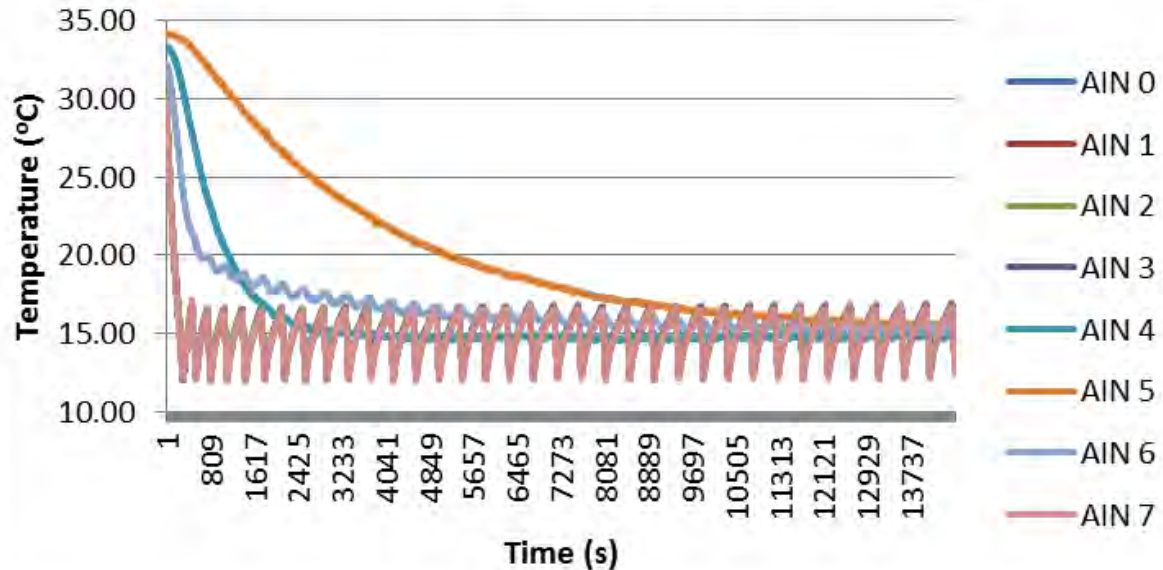

Figure 5.4. Chart of Thermocouple-based Experiment Results

The whole data were processed into one chart. Then, those charts were analyzed. Figure 5.4 was the chart based on the results of this experiment. It can be seen that thermocouple sensors read the temperature differently. There were two kinds of fluctuation of the chart, they were fluctuating chart and decreasing chart. The following were the explanations about the chart:

1. Temperature shown by AIN 0 – AIN 3 and AIN 7 have similar charts. When they were cooled down, the temperatures were decreasing. However, the chart shows that there were some fluctuations during the process. It occurred because in its operation, reefer storage's temperature was set over 14 °C with the differential about 2 °C (or in the range of 12 – 16 °C). The evaporator of the reefer storage would automatically turn on when the temperature read by the thermocouple was higher than 16 °C. Then, it would automatically turn off when the temperature was lower than 12 °C. It caused the air flow circulation inside the reefer storage would be fluctuating. As the results, thermocouple sensors in those points (AIN 0 – AIN 3 and AIN 7) would also read and transmit the fluctuating data. (see Figure 4.22 and Figure 4.23 for the thermocouple placement)
2. Temperature shown by AIN 6 was little bit different from others. It was decreasing longer and slower than AIN 0 – AIN 3 and AIN 7 and then continued by the fluctuating chart. The fluctuation was less than the others. It occurred because thermocouple of AIN 6 was placed inside the cardboard. It caused the cooling air flow entered the cardboard slowly and made the temperature inside the cardboard decreased longer than others. On the other hand, cooling air flow which had entered the cardboard would be trapped inside and made a slow air flow circulation. It influenced to the less fluctuation occurred within it.
3. Temperature shown by thermocouple of AIN 4 and AIN 5 were decreasing differently. Thermocouple of AIN 4 was

decreasing faster than AIN 5. The decreasing chart occurred because both of them were inserted to the cargo (in this case was banana). According to the thermocouple placement, AIN 4 was placed outside the cardboard while AIN 5 was inside the cardboard. It influenced to the differences of cooling process of the cargo.

Table 5.6. Table of Equilibrium Time of Thermocouple Monitoring System

Time (s)	AIN 0	AIN 1	AIN 2	AIN 3	AIN 4	AIN 5	AIN 6	AIN 7
23081	15.85	15.77	15.74	15.73	14.77	15.99	15.34	15.65
23083	15.87	15.77	15.76	15.72	14.76	15.98	15.34	15.69
23085	15.86	15.79	15.78	15.77	14.77	15.97	15.35	15.68
23087	15.87	15.81	15.80	15.77	14.76	16.00	15.32	15.67
23089	15.87	15.80	15.84	15.75	14.76	15.99	15.34	15.71
23091	15.88	15.81	15.82	15.78	14.78	15.98	15.33	15.72
23093	15.90	15.81	15.81	15.77	14.76	15.98	15.33	15.70
23095	15.89	15.77	15.80	15.74	14.72	15.95	15.33	15.71
23097	15.91	15.82	15.84	15.82	14.77	15.99	15.33	15.72
23099	15.91	15.85	15.83	15.81	14.76	15.97	15.37	15.72

In addition, based on the result of the first monitoring system using thermocouple sensors, there were some equilibrium conditions as follows:

- 1) Temperature read by thermocouple located inside the cardboard (AIN 6) reached the maximum required temperature over 14,497 seconds or 4 hours.
- 2) Temperature read by thermocouple sensor inserted to the cargo (banana) outside the cardboard (AIN 4) reached the maximum required temperature over 4,343 seconds or 1.2 hours, much faster than the thermocouple inserted to the cargo inside the cardboard (AIN 5) which reached it over 23,087 seconds or 6.4 hours. It means that the stowage planning would be better if the cargo were placed outside the

cardboard (conditionally). This condition could also be used as the reference of the pre-cooling time needed before the distribution process was done.

5.3 Findings of Experiment Based on Thermocouple Sensors (Monitoring 2)

The second monitoring system using thermocouple sensors was aimed at comparing the experiment using wireless sensor network. The difference in the second monitoring using thermocouple sensors was that it only used 5 thermocouple sensors which were placed at the same place of the nodes. They were thermocouple AIN0 (right side), AIN2 (left side), AIN3 (bottom side), AIN5 (inside the cardboard), and AIN6 (top side). Beside that, the temperature used to start recording the data was different. It was started when all thermocouple sensors (except AIN5) reached the maximum required temperature, that is 16 °C. This monitoring had been done for 4 hours and 7,200 data had been successfully recorded. The following was the data sample.

Table 5.7. Data Sample of Thermocouple-based Experiment (Monitoring 2)

	Right	Left	Top	Bottom	Cardboard
Time	AIN 0	AIN 2	AIN 7	AIN 3	AIN 6
5:03:39 AM	16.96	16.77	13.43	14.88	23.60
5:03:41 AM	16.91	16.70	13.35	14.86	23.56
5:03:43 AM	16.85	16.67	13.32	14.77	23.53
5:03:45 AM	16.77	16.62	13.31	14.73	23.46
5:03:48 AM	16.72	16.59	13.26	14.69	23.42
5:03:50 AM	16.71	16.53	13.20	14.65	23.43
5:03:52 AM	16.67	16.50	13.18	14.61	23.40
5:03:54 AM	16.63	16.49	13.16	14.56	23.35
5:03:56 AM	16.58	16.52	13.11	14.55	23.32
5:03:59 AM	16.52	16.36	13.04	14.50	23.31
5:04:01 AM	16.49	16.35	13.04	14.42	23.30
5:04:03 AM	16.42	16.29	12.99	14.35	23.27
5:04:05 AM	16.33	16.22	12.94	14.36	23.21

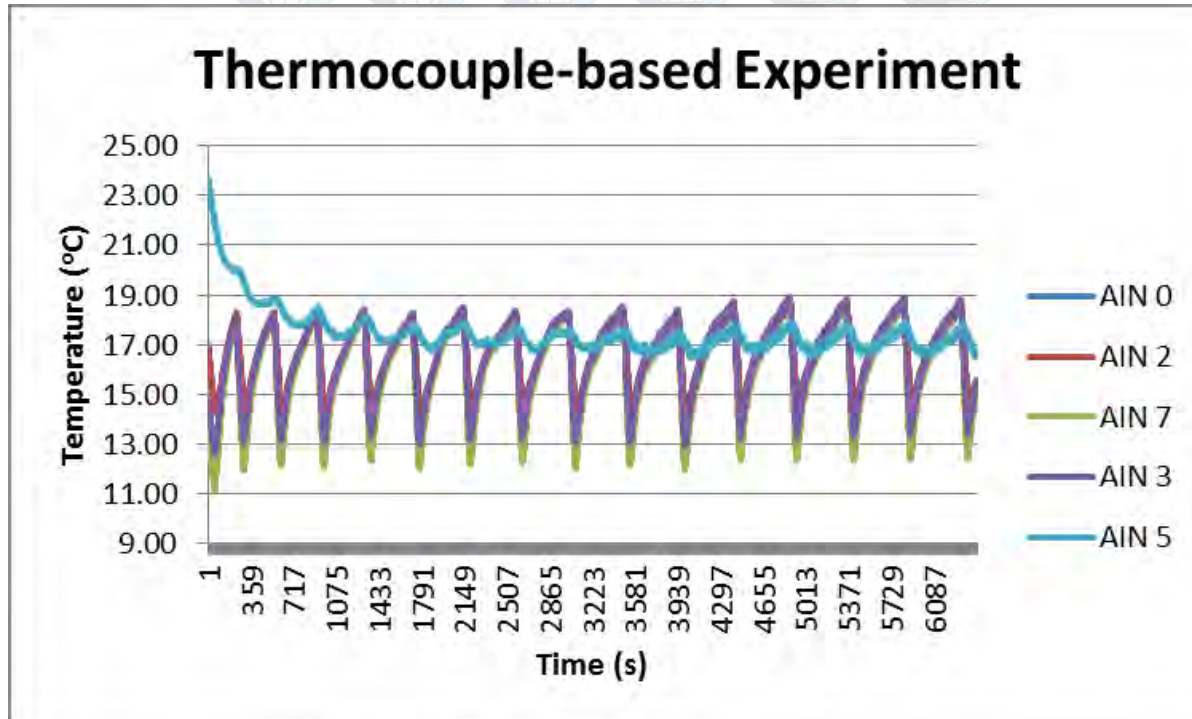

Figure 5.5. Second Monitoring Results of Thermocouple-based Experiment

Based on Table 5.7 and Figure 5.5, the temperature read by AIN0 and AIN2 were quite similar. The thermocouple placed on the top of the cargo was the lowest temperature because it was cooled down directly under the evaporator. Furthermore, temperature read by the thermocouple placed on the bottom side of the cargo were lower than in AIN0 and AIN2. However, they were higher than AIN6 or thermocouple placed under the evaporator. On the other hand, temperature read by the thermocouple inside the cardboard or AIN5 had the highest temperature. It occurred since the holes of the cardboards were small hence the cooling air flow was flowing slowly into it.

5.4 Findings of Experiment Based on Wireless Sensor Network (WSN)

Table 5.8. Temperature Data Sample of Wireless Sensor Network (WSN)-based Experiment

	Right	Left	Top	Bottom	Cargo
Time	Node 1	Node 2	Node 3	Node 4	Node 5
5:03:39 AM	16.66	16.00	11.97	19.47	19.17
5:03:41 AM	16.66	16.00	11.88	19.47	19.25
5:03:43 AM	16.55	15.95	11.78	19.47	19.25
5:03:45 AM	16.48	15.88	11.78	19.47	19.09
5:03:48 AM	16.48	15.88	11.67	16.29	19.09
5:03:50 AM	16.37	15.76	11.67	16.29	19.09
5:03:52 AM	16.37	15.76	11.60	16.29	19.03
5:03:54 AM	16.28	15.70	11.50	16.29	19.03
5:03:56 AM	16.17	15.70	11.50	16.29	19.07
5:03:59 AM	16.17	15.60	11.43	16.29	18.85
5:04:01 AM	16.09	15.60	11.43	16.29	18.85
5:04:03 AM	16.09	15.48	11.35	16.29	18.85
5:04:05 AM	16.00	15.40	11.35	16.29	18.85

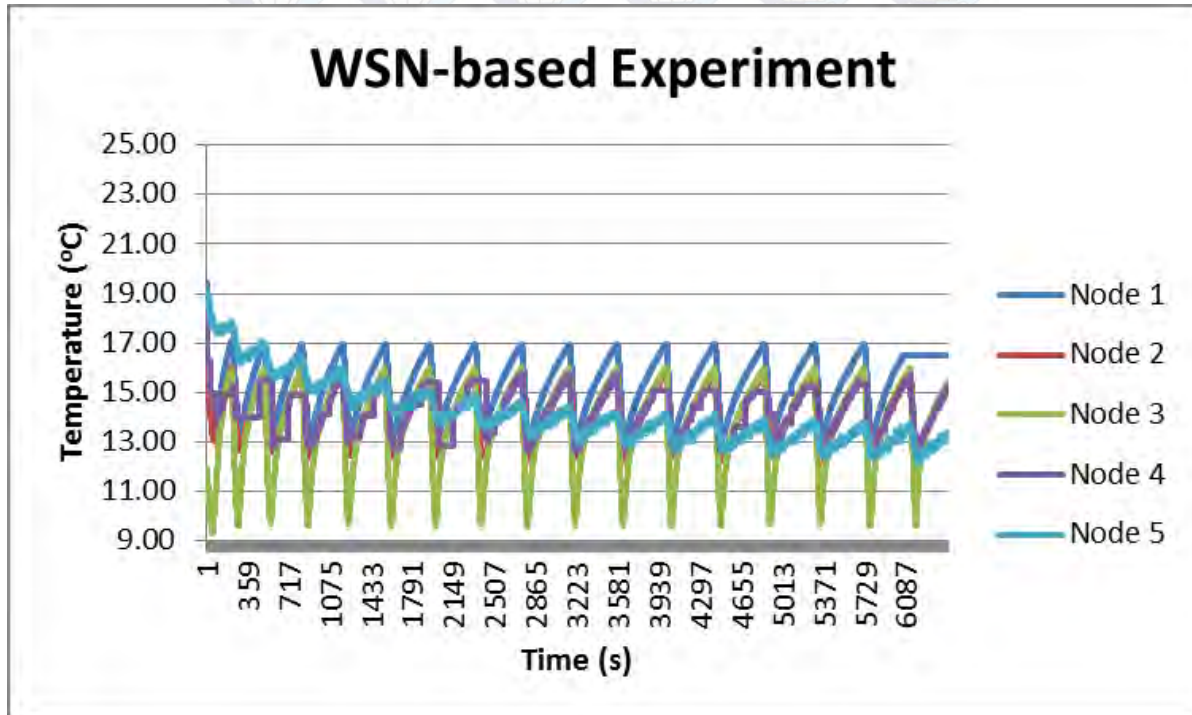

Figure 5.6. Chart of WSN-based Temperature Monitoring Experiment

The experiment based on wireless sensor network was done at the same time with the experiment based on thermocouple sensors. As explained in previousve, this experiment had been conducted for 4 hours starting from the maximum required temperature. According to the sensors placement on Chapter 4, there were 5 sensor nodes used here. There were 2 types of sensor, they are DT-sense SHT11 sensor module (Node 1 – 3) which can be used to read both of temperature and humidity, and IR temperature sensor module (Node 4 and Node 5) which uses infrared to read temperature.

There were 6,446 data that had been successfully recorded. Based on Table 5.8 and Figure 5.6, temperature read by Node 1 and 2 placed on the right and the left side of the cargo were quiet similar. Node 3 has the lowest temperature because it was placed on the top side of the cargo and directly cooled down under the evaporator. Node 4 and Node 5 were higher than others. It occurred because Node 5 was placed inside the cardboard so the cooling air flow entered it slowly.

5.5 Analysis of the Critical Location Based on Experiment Using Thermocouple

The critical location here was the location where temperature read by the sensors were not similar to others. This is analyzed based on the comparison data of experiments using wireless sensor network and thermocouple sensors, especially from the first 16° C read by them.

Table 5.9.Comparison of Temperature Data (Right & Left Sides)

Time	Right		Left	
	Node 1	AIN 0	Node 2	AIN 1
5:03:39 AM	16.66	16.96	16.00	16.77
5:03:41 AM	16.66	16.91	16.00	16.70
5:03:43 AM	16.55	16.85	15.95	16.67
5:03:45 AM	16.48	16.77	15.88	16.62
5:03:48 AM	16.48	16.72	15.88	16.59

Table 5.10. Comparison of Temperature Data (Top & Bottom Sides)

Time	Top		Bottom	
	Node 3	AIN 7	Node 4	AIN 3
5:03:39 AM	11.97	13.43	19.47	14.88
5:03:41 AM	11.88	13.35	19.47	14.86
5:03:43 AM	11.78	13.32	19.47	14.77
5:03:45 AM	11.78	13.31	19.47	14.73
5:03:48 AM	11.67	13.26	16.29	14.69

According to Table 5.9 and Table 5.10, the first data were recorded when all points had reached around or less than 16 °C. If these data represents the equilibrium time of all points, it can be seen that sensors placed in the middle of reefer storage (left and right) reached 16 °C slower than the other sides (top and bottom). On the other hand, at that time, the sensor placed on the top side of reefer storage was lower than the bottom side. It can also be seen on Figure 5.5 and Figure 5.6 that temperatures on the top side were reaching the lowest temperature. It occurred because the cooling air released by the evaporator flowed from the top to the bottom. When the evaporator turned on, the cooling air flow would be released and went down. Moreover, when the evaporator turned off, the blower still blowed air down. It means that the highest cargo would get the cooling air longer than others and the lowest cargo would get the cooling air left before.

Based on the aforementioned analysis, the critical location of the cargo should be on the top side of reefer storage because the cargo would possibly reach temperature lower than the required temperature and it leads to some problems, such as low quality of the cargo, occurred in the distribution process, especially for the distribution on board which might take longer time. In addition, the critical location might potentially happen in the middle side of reefer storage so the cargo would take longer time to be cooled down. The following was the overview of air

flow released by the evaporator. The evaporator is on the top side of reefer storage.

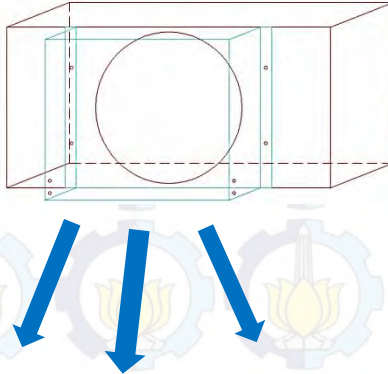

Figure 5.7. Air Flow Direction Released by the Evaporator

By knowing the critical location inside reefer storage, the recommendation for stuffing cargo (stowage plan) can be determined. According to the experiments and the correct recommendation of the cargo stuffing released by Mediteranian Shipping Company (see Chapter 2.15), stuffing plan should look at the possible air flow circulation. Users need to tighten the stuffing (stowage) of each cargo and make sure that there is no space/gap which will lead air flow to circulate there. Beside that, there is another possible recommendation to implement, especially for reefer storage designers or producers. They need to re-design the air flow circulation so all sides of reefer storage can reach the equal temperature in its operation.

5.6 Analysis of Humidity Based on Experiment Using Wireless Sensor Network

Humidity was also read during the experiment based on wireless sensor network. This value of humidity could be read by sensor nodes which is completed by DT-sense SHT11 sensor module. Humidity is the amount of water vapor in the air. In this experiment, humidity was recorded to know its characteristic

compared to temperature in reefer storage. The data sample can be seen in Table 5.11 and Figure 5.8.

Table 5.11. Humidity Data Sample of Wireless Sensor Network (WSN)-based Experiment

Time	Humidity 1	Humidity 2	Humidity 3
5:03:39 AM	46.19	45.50	56.44
5:03:41 AM	46.19	45.50	56.39
5:03:43 AM	46.18	45.69	56.38
5:03:45 AM	46.17	45.59	56.38
5:03:48 AM	46.17	45.59	56.33
5:03:50 AM	46.19	45.57	56.33
5:03:52 AM	46.19	45.57	56.35
5:03:54 AM	46.18	45.47	56.40
5:03:56 AM	46.19	45.47	56.40
5:03:59 AM	46.19	45.42	56.42
5:04:01 AM	46.12	45.42	56.42
5:04:03 AM	46.12	45.28	56.43
5:04:05 AM	46.14	45.24	56.43

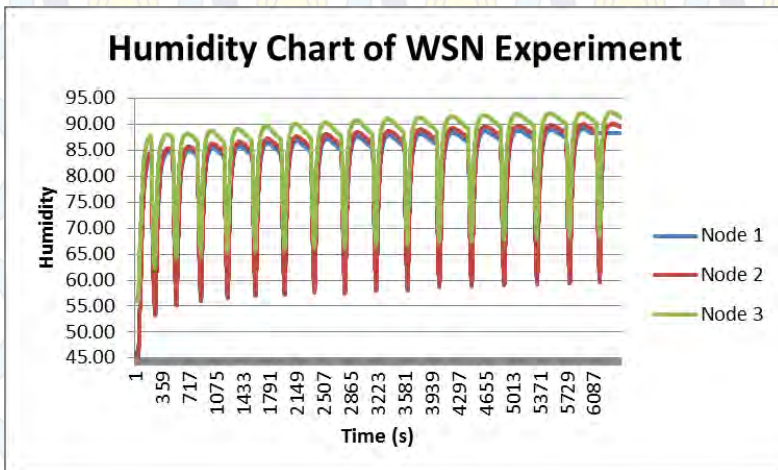

Figure 5.8. Humidity Chart of WSN Experiment

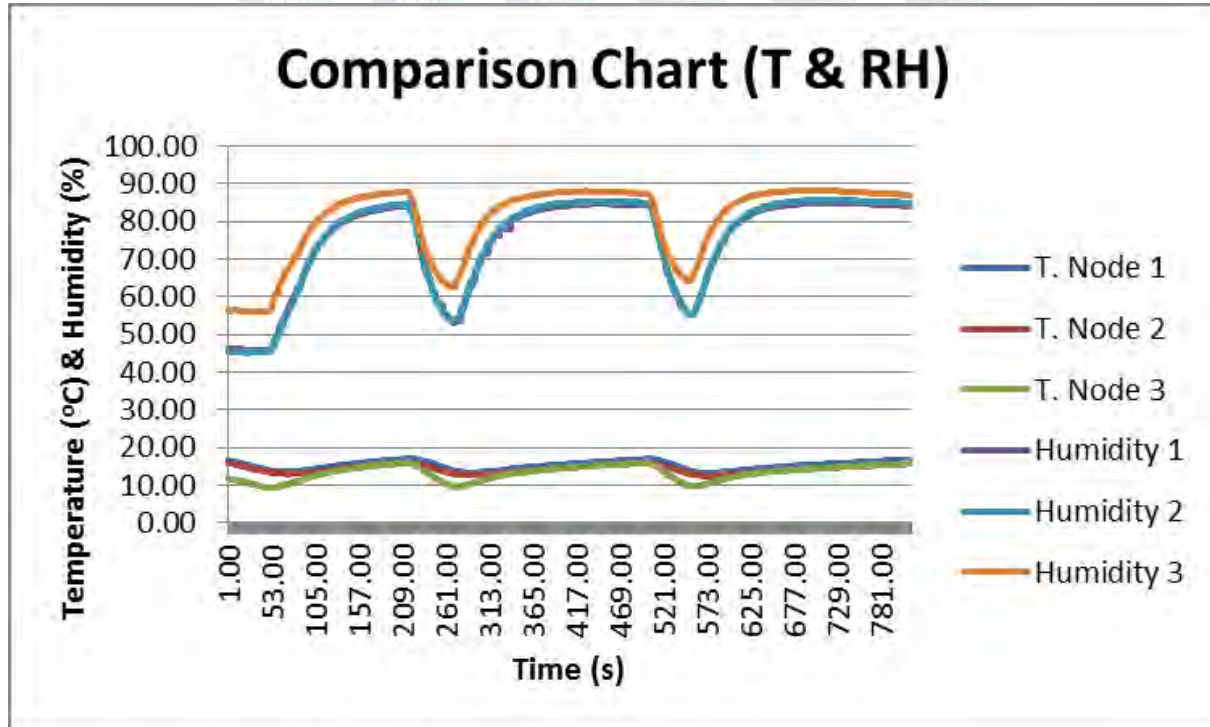

Figure 5.9. Comparison Chart between Temperature & Humidity



Based on the comparison chart shown in Figure 5.9, the relationship between temperature and humidity in reefer storage is directly proportional. When temperature increases, the value of humidity increases as well, and vice versa. It occurred because when temperature of reefer storage decreases, water vapor content in the air is reduced. Furthermore, Figure 5.8 shows the trend of the chart increases. It does not match with the trend of temperature chart. It might happen because there was some water vapor ticked and left on the surface of the sensors so humidity read by the sensors was increasing although the chart is fluctuating.

Based on Figure 5.8, humidity values read by the sensors were in the range of 55 – 95 %. They were not in accordance with the recommended humidity. They should be kept in the range of 85 – 95 % RH for compatible fresh fruits and vegetables during 7-days storage. It might occur because of the system of the cooling process done by reefer storage.

5.7 Analysis of the Selection of WSN Apparatus

Based on the aforementioned findings, there are several things that could be analyzed especially about the performance of wireless sensor network compared to thermocouple sensors. It leads to the recommended selection of the apparatus of wireless sensor network.

1. Temperature Reading Capability of DT-sense SHT11 sensor module and IR temperature sensor module.

Both of SHT11 and IR temperature sensor module have capability to read temperature. Their differences are about the performance or sensitivity in reading temperature. SHT11 is stronger and more sensitive than IR temperature sensor module (referred to the results of the experiment). IR only uses infrared sensor and the maximum distance required for an IR temperature sensor module to read the data were 4 centimeters. During the performance, IR temperature sensor

should be placed close to the media such as the cargo. It could not read the air without media to reflect the sensor properly.

Table 5.12. Comparison Data between IR Temperature sensor Placed inside and outside the Cardboard

Time	Bottom		Cargo	
	Node 4	AIN 3	Node 5	AIN 6
9:02:27 AM	15.01	14.91	13.15	16.74
9:02:29 AM	15.01	14.83	13.15	16.74
9:02:31 AM	15.01	15.00	13.15	16.65
9:02:34 AM	15.01	14.90	13.15	16.73
9:02:36 AM	15.01	14.93	13.17	16.66
9:02:38 AM	15.01	14.93	13.17	16.66
9:02:41 AM	15.01	14.90	13.25	16.67
9:02:43 AM	14.99	14.94	13.17	16.76
9:02:46 AM	15.01	14.98	13.17	16.78
9:02:48 AM	15.01	15.00	13.21	16.72
9:02:50 AM	14.95	15.02	13.21	16.77
9:02:53 AM	14.95	15.11	13.21	16.59
9:02:55 AM	14.89	15.12	13.05	16.49
9:02:57 AM	15.09	15.29	13.31	16.56
9:03:00 AM	15.09	15.32	13.31	16.55
9:03:02 AM	14.95	15.14	13.25	16.61

2. IR temperature sensor module's performance to read temperature inside and outside the cargo.

Based on Table 5.12, IR temperature sensor was better to read temperature inside the cargo (Node 4) than outside the cargo (Node 5) because it met a media of banana therefore the sensor could reach the temperature properly. On the other hand, it was hard to read the data when it was placed outside the cargo, especially in condition where there was no other media outside the cargo that could be used to reflect the

infrared sensor. This caused the incompatibility temperature data transmitted to the receiver compared to the thermocouple sensors.

5.8 Method Comparison

After finishing the experiments, both methods were compared by comparing the results of temperature values read by all sensors. The comparison was done by observing at the gaps between two methods. The results were transformed into the charts consisting of each location of the sensors. There were 5 charts that can be identified. According to those charts, the gaps of both methods were analyzed if they were appropriate to the error standard calculated during the apparatus calibration process (see Chapter 5.1). The following were the standard error taken from the first and the last 30 seconds of the measurements, as well as the comparison charts.

Table 5.13. Standard Error Based on the Data Sample from the First 30 Minutes

	Temp 1	Temp 2	Temp 3	Temp 4	Temp 5
Node	16.49	15.02	15.24	15.05	13.24
AIN	15.41	15.33	14.72	15.16	16.63
Mean	15.95	15.18	14.98	15.11	14.93
S.Dev	0.76	0.21	0.37	0.08	2.40
S.Error	0.54	0.15	0.26	0.05	1.70

Table 5.14. Standard Error Based on the Data Sample from the Last 30 Minutes

	Temp 1	Temp 2	Temp 3	Temp 4	Temp 5
Node	15.85	15.28	11.16	16.63	18.81
AIN	16.24	16.09	12.79	14.21	23.13
Mean	16.05	15.69	11.98	15.42	20.97
S.Dev	0.27	0.58	1.15	1.71	3.05
S.Error	0.19	0.41	0.81	1.21	2.16

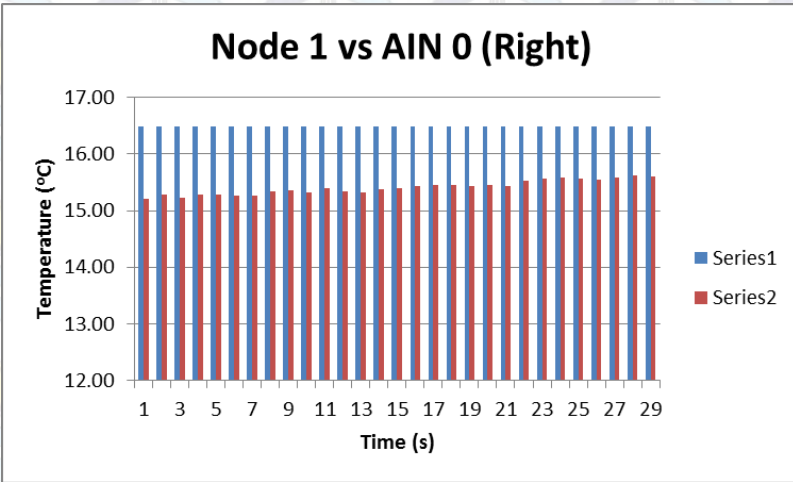

Figure 5.10. Comparison Chart between Node 1 and AIN 0

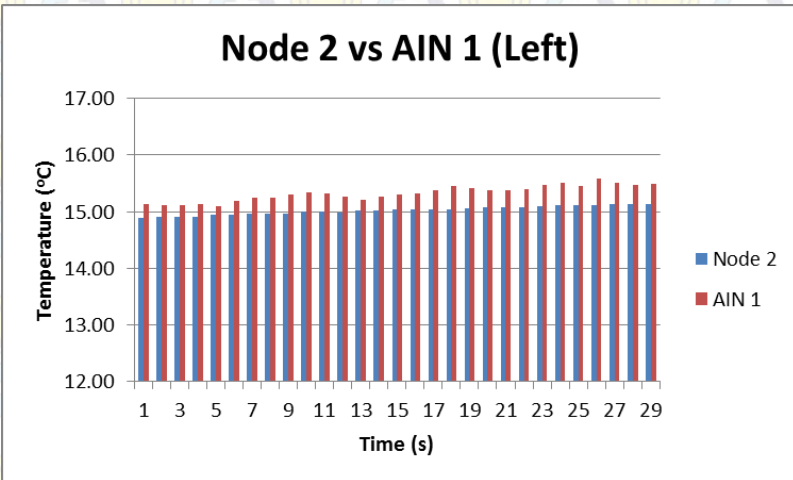

Figure 5.11. Comparison Chart between Node 2 and AIN 1

The error standard of Node 1 and AIN 0 should be in the range of 0.19 – 0.54 (see Figure 5.10) and Node 2 and AIN 1 should be in the range 0.15 – 0.41 (see Figure 5.11).

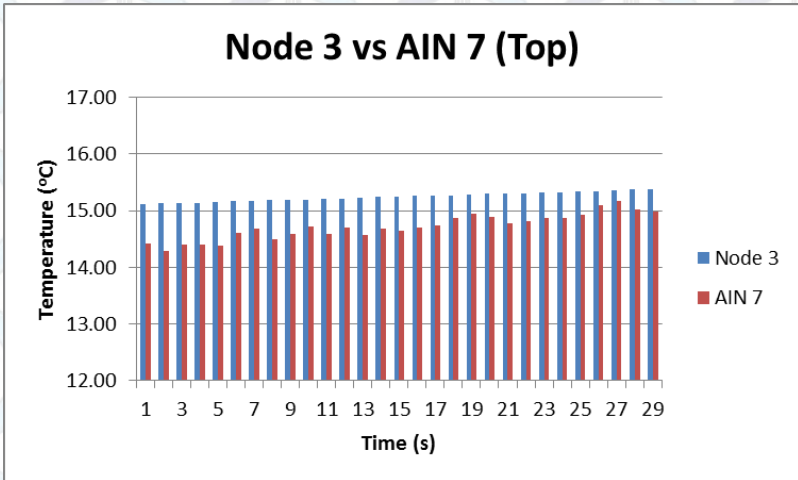

Figure 5.12. Comparison Chart between Node 3 and AIN 7

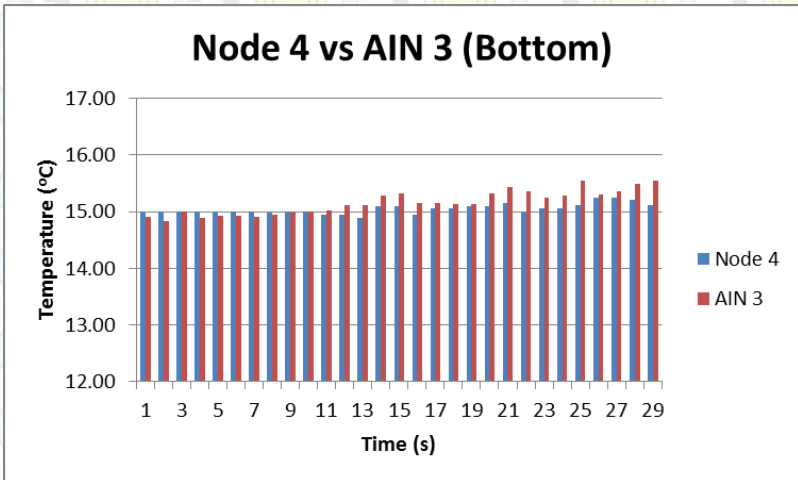

Figure 5.13. Comparison Chart between Node 4 and AIN 3

The error standard of Node 3 and AIN 7 should be in the range of 0.26 – 0.81 (see Figure 5.12) and Node 4 and AIN 3 should be in the range 0.05 – 1.21 (see Figure 5.13).

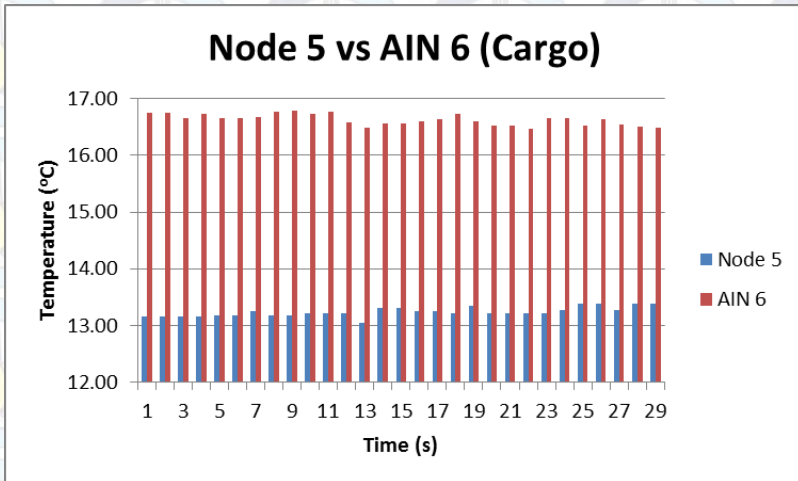

Figure 5.14. Comparison Chart between Node 5 and AIN 6

The error standard of Node 5 and AIN 6 should be in the range of 1.70 – 2.16 (see Figure 5.14). Based on the aforementioned analysis, temperature values read by both of thermocouple sensors and WSN sensor nodes were confidently valid because they were still appropriate to the standard error done in the calibration process (see Chapter 5.1). However, there were Node 4 and AIN 3 (based on the last 30 minutes) and also Node 5 and AIN 6 showing the high gaps in their standard error. It occurred because they used IR Temperature sensor modules which could not read temperature properly if there was no media supporting them. It caused the high gaps between Node 5 and AIN 6 because it was placed under the shelf, it might not read the right temperature at that time.

Based on the analysis, WSN system can still be used by users to monitor data in reefer storage, seems like the usage of thermocouple sensors. In addition, these data proved that DT-sense SHT11 sensor module will be better to use compared to IR temperature sensor module.

CHAPTER VI CONCLUSIONS AND SUGGESTIONS

6.1 Conclusions

Based on the experiments of temperature monitoring system using wireless sensor network and thermocouple sensors in reefer storage, the following conclusions were made.

1. Temperature monitoring system based on wireless sensor network had been done in Star Topology. The results show that this system could transfer the data realtime proven by 6,446 temperature data monitored for 4 hours with the interval of monitoring around 2 seconds. This was done wirelessly with the distance around 100 meters. Furthermore, WSN sensor nodes can read temperature in the range of 12 – 16 °C with the uncertainty error around 0.68 °C according to the standard error in the calibration process.
2. Temperature monitoring system based on thermocouple sensors type K and Labjack T7 Pro data logger had been done. Based on the quality and quantity, it could read the data completely and realtime proven by 7,200 temperature data taken from 4 hours monitoring experiment with the interval of 2 seconds. Based on these, wireless sensor network has similar quality compared to the thermocouple sensors and could be more effective in terms of the range of the data transmission from the sensors to the receiver (around 100 meters).
3. The critical location in reefer storage owned by Laboratory of Marine Machinery and System were on the top side and middle side of the cargo. The evaporator located on the top side of reefer storage flows cooling air directly to the top cargo and could cause temperature on it lower than the required temperature. However, the highest temperature was

found inside the cardboard. These findings can be used as the references to determine the appropriate stuffing plan and the proper cardboard used to save the cargo.

6.2 Suggestions

Based on the experiments conducted in reefer storage using wireless sensor network and thermocouple sensor, there are several suggestions as follows.

1. In the same type of reefer storage, the cargo, bananas, need to be pre-cooled for more than 6 hours prior the distribution process.
2. Based on the critical location, the stuffing plan should be determined by tighten the cargo stuffing and make sure that there is no blank space for air to circulate. Beside that, the designers or producers of reefer storage might be possible to re-design the air flow circulation inside reefer storage.
3. Wireless sensor network investigation can be continued experimentally by applying the other topology such as mesh topology on board ship.
4. WSN system applied in this research can be expanded into other types of network. One of them is by turning WSN system using coordinator to WSN system without coordinator.
5. This network might be expanded to the wireless system using internet connection/wifi.

REFERENCES

- Boonsawat, V., Ekchamanonta, J., Bumrunghet, K., & Kittipiyakul, S. *XBee Wireless Sensor Networks for Temperature Monitoring*. School of Information, Computer, and Communication Technology, Sirindhorn International Institute of Technology, Thammasat University, Pathum-Thani, Thailand.
- Budi, Setyo. 2012. *Pengenalan Wireless Sensor Network*. SKI-2, Universitas Brawijaya, Malang.
- Halim, Gamma. 2013. *Pemilihan Sistem Rantai Dingin (Cold Chain) Daging Segar yang Memenuhi Persyaratan Halal*. Tugas Akhir S-1, Teknik Sistem Perkapalan, FTK-ITS, Surabaya.
- Kho, Dickson. *Pengertian Termokopel (Thermocouple) dan Prinsip Kerjanya*. Accessed from: <http://teknikelektronika.com/pengertian-termokopel-thermocouple-dan-prinsip-kerjanya/>
- Mayalarp, V., Limpaswadpaisarn, N., Poombansao, T., & Kittipiyakul, S. *Wireless Mesh Networking with XBee*. School of Information, Computer, and Communication Technology, Sirindhorn International Institute of Technology, Thammasat University, Pathum-Thani, Thailand.
- Patil, S.S., Sarade, S.S., & Chavan, S.V. *Zigbee Based Sensor Networks for Temperature Monitoring and Controlling*. Department of Electrical Engineering, ADCET ASHTA/RIT Sakharale/Shivaji University, Kolhapur, India.
- Pratama, Filza Firmansyah. 2013. *Cold Storage*. Accessed from: <http://filzatepeteu.blogspot.co.id/2013/09/cold-storage.html>

Purnomo, Bayu Gilang. 2013. *Cara Kerja Sistem Pendingin*. Accessed from: <http://purnama-bgp.blogspot.co.id/2013/07/cara-kerja-sistem-pendingin.html>

Sharma, D., Verma, S., & Sharma, K. 2013. *Network Topologies in Wireless Sensor Networks: A Review*. Dept. of ECE, NITTR, Chandigarh, UT, India.

Watkins, Chris B. & Nock, Jacqueline F. 2012. *Production Guide for Storage of Organic Fruits and Vegetables*. Department of Horticulture, Comell University.

APPENDICES

Appendix I

Table 7.1. Thermocouple Components Specifications

No.	Name & Picture of Components	Specifications
1	Labjack T7 Pro 	<ul style="list-style-type: none"> • 14 Built-in Analog Inputs, expandable to 84 analog inputs with Mux80 add-on • Analog input ranges: $\pm 10V$, $\pm 1V$, $\pm 0.1V$ and $\pm 0.01V$ • 16-bit high-speed ADC (up to 100k samples/s) • 24-bit low-speed ADC (resolution as low as 1uV noise-free) • 23 digital I/O • Watchdog system • Up to 10 counters • 2 analog outputs (12-bit, 0-5V) • Serial protocols: SPI, I2C, and more ... • Up to 8 PWM, quadrature, pulse width, and more ... • Thermocouples, load cells, bridges, and more ... • Industrial temperature range (-40 to +85C) • Compatibility with most SCADA Modbus TCP enabled systems for both wired and wireless operation • Capable of standalone operation via Lua Scripting
2	EI1034	Easy to use and very accurate









<p>Temperature Probe</p> 	<p>temperature probe from Electronic Innovations Corp. Features a waterproof stainless-steel probe, a high-level linear output of 10 mV per degree F, a typical accuracy of ± 0.4 degrees F (± 0.22 degrees C) at room temperature, and a range of 0 to +230 degrees F (-17 to +110 degrees C, with U3/UE9).</p>
--	--



Table 7.2.Sensor Nodes Components Specifications

No.	Name & Picture of Components	Specifications
1	<p>IR temperature sensor module</p> 	<ul style="list-style-type: none"> • Power supply: 3V to 5V DC • Measurement temperature: -33 to +220 °C • Accuracy at read temp 15~35°C / ambient 25°C: +/-0.6°C • Full range accuracy: +/-2%, 2°C • Resolution: 0.0625°C (full range) • Response time (90%): 1 second • Distance:Spot ratio: 1:1 • Emissivity: 0.01~1 step 0.01 • Update frequency: 1.4Hz • Wave length: 5um-14um • On-board voltage regulator and communications interface • Dimensions: 35(W) x 14(H) x 12(D)mm
2	<p>DT-Sensor SHT11 Module</p>	<ul style="list-style-type: none"> • Based on the relative temperature and humidity

		<p>sensors of Sensirion SHT11.</p> <ul style="list-style-type: none"> • Read temperature from -40°C (-40°F) to $+123,8^{\circ}\text{C}$ ($+254,9^{\circ}\text{F}$) and relative humidity from 0%RH to 100%RH. • Has an accuracy temperature reading up to $\pm 0,5^{\circ}\text{C}$ on 25°C and an accuracy relative humidity reading up to $\pm 3,5\%$ RH. • Has a serial interface synchronous 2-wire, not I2C. • Interface line has been equipped with a series of lock-up sensors condition prevention. • Requires +5V DC power supply with low power consumption $30\mu\text{W}$. • The module has an 8-pin DIP from factor of 0.6", thus simplifying installation.
3	<p>Arduino Stalker V3.0</p> 	<ul style="list-style-type: none"> • Arduino compatible, based on Seeeduino • Onboard microcontroller: ATmega328P • Onboard Real Time Clock chip with a supercap as a backup power source • Serial interface with DTR for auto reset during programming when operating in standalone mode. • MicroSD card socket • I2C Pin header (operation

		<p>voltage is selectable: 5.0V or 3.3V)</p> <ul style="list-style-type: none"> • User defined LED • Bee series socket - 2*10 pin 2.0mm pitch (which will mate with - one at a time - any of the wireless modules: XBee, BluetoothBee, GPSBee or RFBee.) • Please note that The IO Ports work in 0~3.3v level only.
4	<p>XBee Tranceiver</p> 	<ul style="list-style-type: none"> • Power supply: 2.7 - 3.6VDC • Data rate: 250 kbps • Working Frequency: 2,4GHZ • Interface: Serial UART • Reach: indoor 90m, outdoor 3,2km
5	<p>Arduino Mega 2560</p> 	<ul style="list-style-type: none"> • Power supply: 7VDC - 12VDC • Number of port i/o : 14 pin I/O (6 pin for output PWM) • Interface Port UART TTL, I2C, SPI and USB (Virtual Com) • USB Programming Port
6	<p>Arduino Wifi Shield</p> 	<ul style="list-style-type: none"> • Wifi Chip: WizFi210 • Radio Protocol: IEEE 802.11b/g/n Compatible • Supported Data Rates: 11, 5.5, 2, 1 Mbps (IEEE 802.11b) • Modulation: DSSS and CCK • RF Operating Frequency: 2.4 - 2.497 GHz • Antenna Options: Chip antenna

		<p>and U.FL connector for external antenna</p> <ul style="list-style-type: none"> • Networking Protocols: UDP, TCP/IP (IPv4), DHCP, ARP, DNS, HTTP/HTTPS Client and Server(*) • Power Consumption(Typical): Standby = 34.0 μA Receive = 125.0 mA Transmit = 135.0 mA • RF Output Power (Typical): 8dBm \pm 1dBm • Security Protocols: WEP, WPA/WPA2-PSK, Enterprise, EAP-FAST, EAP-TLS, EAP-TTLS, PEAP • I/O Interface: UART, SPI(*), I2C(*), WAKE, ALARM, GPIOs • Power Source: 3.3V • Dimensions(except Antenna): 59 x 54 mm
7	<p>USB to 232 Serial Adapter with Cable (Parallax)</p> 	<ul style="list-style-type: none"> • USB Version 1.1 and 2.0 compatible • Connects to your computer with a USB A to Mini-B cable (not included) • DB9 male socket to connect to your board's serial programming and debugging port • FTDI Drivers for most Windows PC operating systems are included with Parallax programming environment

		<ul style="list-style-type: none"> software Drivers for different operating systems are available from FTDI chip
8	<p>WIZ110SR Serial to Ethernet Gateway</p> 	<ul style="list-style-type: none"> WIZnet W5100 Hardwired TCP/IP Embedded Ethernet Controller <ul style="list-style-type: none"> Supports: TCP, UDP, ICMP, IPv4 ARP, IGMP, PPPoE, Ethernet 10BaseT/100BaseTX Ethernet PHY embedded GC89L591A0-MQ44I (fast 80C52 compatible) MCU <ul style="list-style-type: none"> internal 62K Flash, 16K SRAM, 2K EEPROM Simple configuration over serial interface Supports password for security 10/100 Ethernet Interface and max 230kbps Serial Interface 5VDC input voltage <ul style="list-style-type: none"> Center-positive 5.5x2.1mm barrel connector Under 180mA current consumption
9	<p>Battery Lipo 11.1 V 2200 mAh</p> 	<ul style="list-style-type: none"> Product Type:lipo battery pack Capacity: 2200mAh Voltage: 11.1V Max Continuous Discharge: 25C (55A) Max Burst Discharge: 50C (110A)

		<ul style="list-style-type: none"> • Weight: 184 g • Dimensions: 106*34*24 mm • Balance Plug: JST-XH • Discharge Plug: T plug • Charge Rate: 1-3C Recommended, 5C Max
--	--	--

Based on the aforementioned specifications, there was one type of Wireless Sensor Network system. It was WSN systems with coordinator. The overview of the system can be seen in the following scheme.

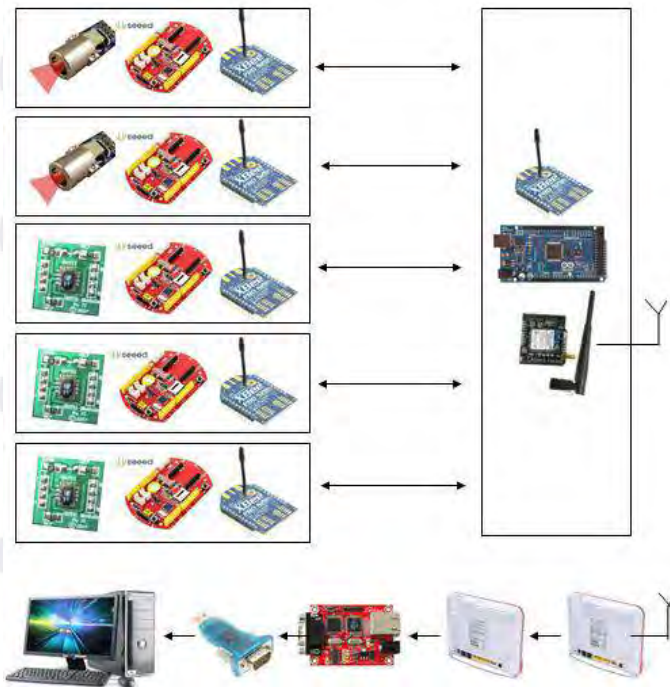

Figure 7.1.WSN System with Coordinator

Appendix II

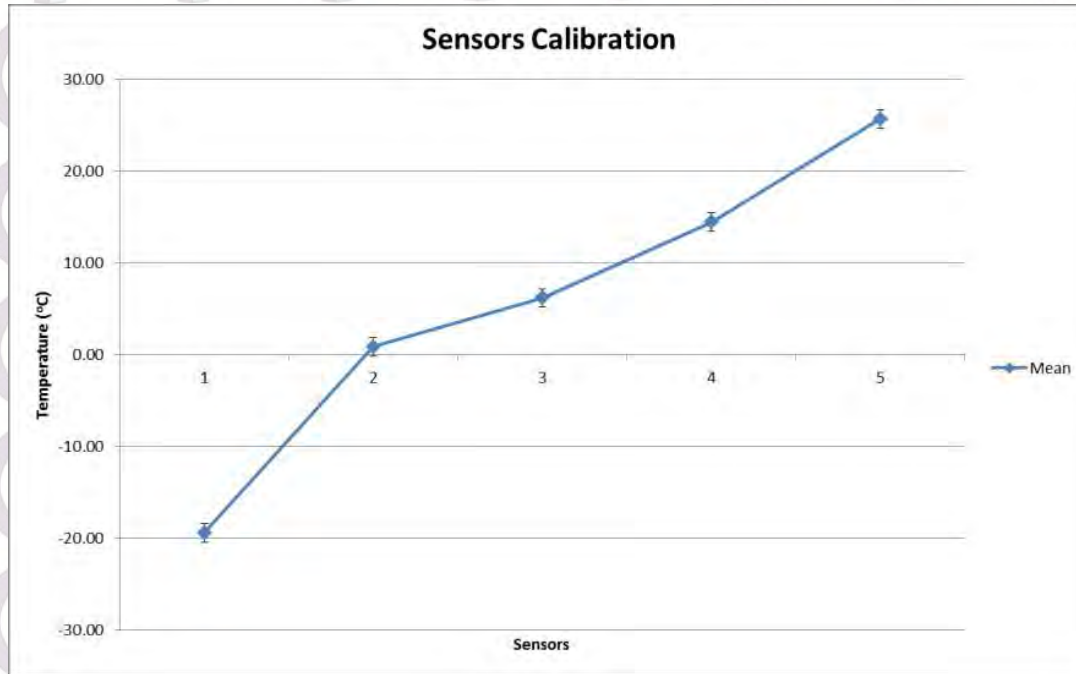

Figure 7.2.Detail Chart of Error Standard

Biography



Ardian Yudha was born in Lumajang, East Java, on Friday, July 09, 1993. He is the first son of a father named Munaji and a mother named Kadarwati. Ardian spent six-year primary study at SDN Gesang 01. He entered this elementary school in 1999 and graduated in 2005. Right after, he had his secondary level of study at SMPN 1 Tempeh and graduated in 2008. He, then, continued his study to SMAN 1 Lumajang and graduated in 2011. In the same year, he continued studying to Sepuluh Nopember Institute of Technology majoring in Marine Engineering, Faculty of Marine Technology and graduated on March, 2016.

During his study at Sepuluh Nopember Institute of Technology, Ardian was a member and a laboratory assistant of Marine Machinery and System Laboratory and also actively participated in some organizations and social communities, such as becoming staff of Research and Technology Department (2012-2013) and head of Information Media Department (2013-2014) in Marine Engineering Student's Union. Besides, he once became an ITS delegate in Sawasdee Camp 2013 held by King Mongkut's University of Technology Thonburi in Thailand, an Indonesian delegate in Intercultural Discovery Exchange in Asia (IDEA) Project 2014 held by National Taiwan University's International Sheer Organization in Taipei, and a speaker as well as the best poster presenter in International Conference on Advanced Science and Technology (ICAST) 2015 held by Kumamoto University-ITS Surabaya.

Ardian was the scholar of American Bureau of Shipping Award 2013 and 2014, and Nippon Kaiji Kyokai Award 2015.

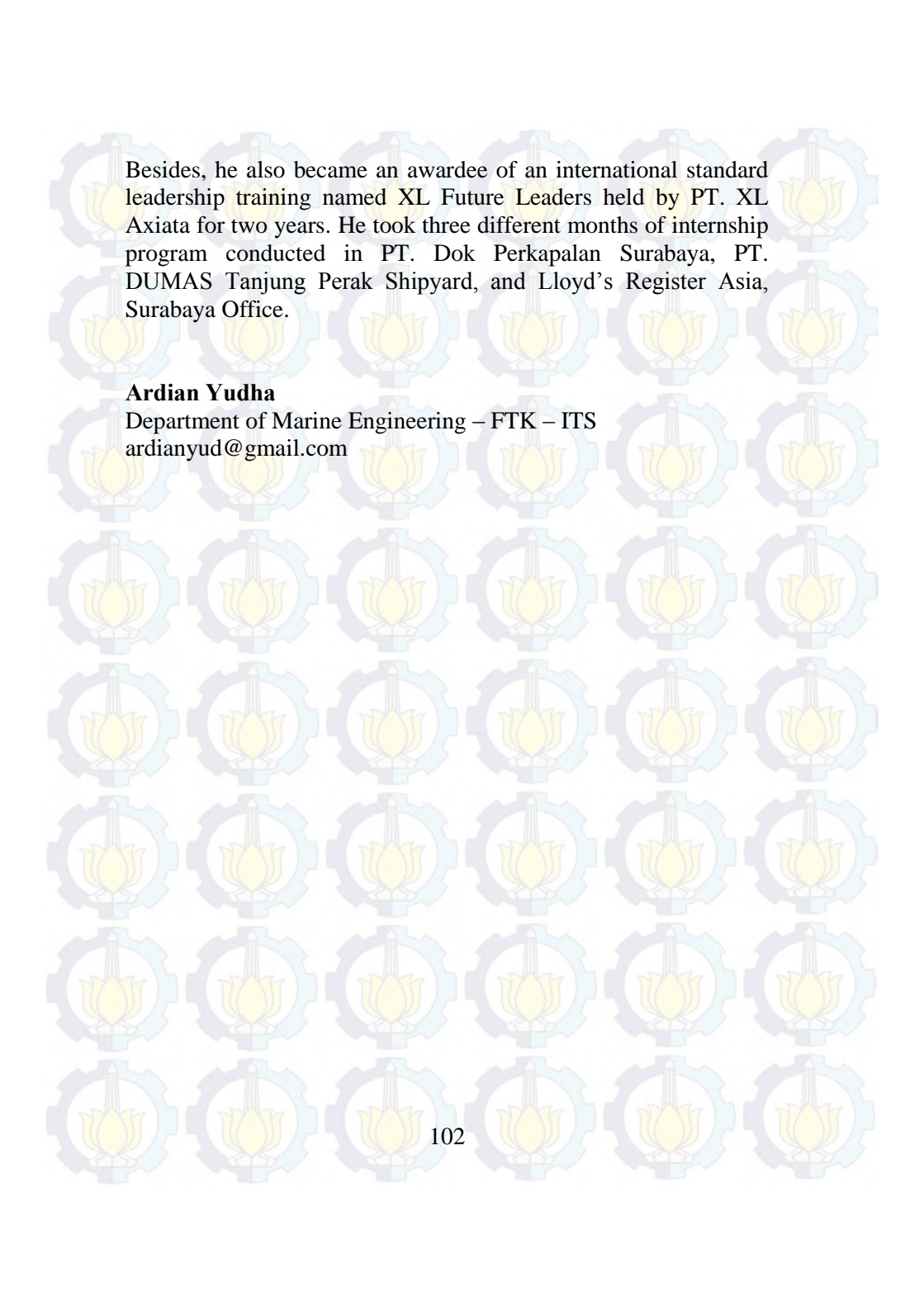
The background of the page is a repeating pattern of a light blue gear with a yellow lotus flower inside. The gear is positioned around the lotus, and the pattern covers the entire page.

Besides, he also became an awardee of an international standard leadership training named XL Future Leaders held by PT. XL Axiata for two years. He took three different months of internship program conducted in PT. Dok Perkapalan Surabaya, PT. DUMAS Tanjung Perak Shipyard, and Lloyd's Register Asia, Surabaya Office.

Ardian Yudha

Department of Marine Engineering – FTK – ITS
ardianyud@gmail.com