

On: 12 March 2015, At: 06:59

Publisher: Routledge

Informa Ltd Registered in England and Wales Registered Number: 1072954 Registered office: Mortimer House, 37-41 Mortimer Street, London W1T 3JH, UK

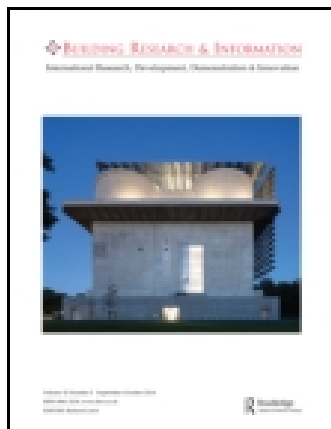

## Building Research & Information

Publication details, including instructions for authors and subscription information:

<http://www.tandfonline.com/loi/rbri20>

### Solid-wall U-values: heat flux measurements compared with standard assumptions

Francis G. N. Li<sup>a</sup>, A.Z.P. Smith<sup>a</sup>, Phillip Biddulph<sup>a</sup>, Ian G. Hamilton<sup>a</sup>, Robert Lowe<sup>a</sup>, Anna Mavrogianni<sup>a</sup>, Eleni Oikonomou<sup>a</sup>, Rokia Raslan<sup>a</sup>, Samuel Stamp<sup>a</sup>, Andrew Stone<sup>a</sup>, A.J. Summerfield<sup>a</sup>, David Veitch<sup>a</sup>, Virginia Gori<sup>a</sup> & Tadj Oreszczyn<sup>a</sup>

<sup>a</sup> UCL Energy Institute, University College London, Central House, 14 Upper Woburn Place, London WC1H 0NN, UK

Published online: 16 Oct 2014.



[Click for updates](#)

To cite this article: Francis G. N. Li, A.Z.P. Smith, Phillip Biddulph, Ian G. Hamilton, Robert Lowe, Anna Mavrogianni, Eleni Oikonomou, Rokia Raslan, Samuel Stamp, Andrew Stone, A.J. Summerfield, David Veitch, Virginia Gori & Tadj Oreszczyn (2015) Solid-wall U-values: heat flux measurements compared with standard assumptions, *Building Research & Information*, 43:2, 238-252, DOI: [10.1080/09613218.2014.967977](https://doi.org/10.1080/09613218.2014.967977)

To link to this article: <http://dx.doi.org/10.1080/09613218.2014.967977>

PLEASE SCROLL DOWN FOR ARTICLE

Taylor & Francis makes every effort to ensure the accuracy of all the information (the "Content") contained in the publications on our platform. Taylor & Francis, our agents, and our licensors make no representations or warranties whatsoever as to the accuracy, completeness, or suitability for any purpose of the Content. Versions of published Taylor & Francis and Routledge Open articles and Taylor & Francis and Routledge Open Select articles posted to institutional or subject repositories or any other third-party website are without warranty from Taylor & Francis of any kind, either expressed or implied, including, but not limited to, warranties of merchantability, fitness for a particular purpose, or non-infringement. Any opinions and views expressed in this article are the opinions and views of the authors, and are not the views of or endorsed by Taylor & Francis. The accuracy of the Content should not be relied upon and should be independently verified with primary sources of information. Taylor & Francis shall not be liable for any losses, actions, claims, proceedings, demands, costs, expenses, damages, and other liabilities whatsoever or howsoever caused arising directly or indirectly in connection with, in relation to or arising out of the use of the Content.

This article may be used for research, teaching, and private study purposes. Terms & Conditions of access and use can be found at <http://www.tandfonline.com/page/terms-and-conditions>

It is essential that you check the license status of any given Open and Open Select article to confirm conditions of access and use.

RESEARCH PAPER

# Solid-wall $U$ -values: heat flux measurements compared with standard assumptions

Francis G. N. Li, A.Z.P. Smith, Phillip Biddulph, Ian G. Hamilton, Robert Lowe, Anna Mavrogianni, Eleni Oikonomou, Rokia Raslan, Samuel Stamp, Andrew Stone, A.J. Summerfield, David Veitch, Virginia Gori and Tadj Oreszczyn

UCL Energy Institute, University College London, Central House, 14 Upper Woburn Place, London WC1H 0NN, UK  
E-mails: [francis.li@ucl.ac.uk](mailto:francis.li@ucl.ac.uk), [andrew.smith@ucl.ac.uk](mailto:andrew.smith@ucl.ac.uk), [p.biddulph@ucl.ac.uk](mailto:p.biddulph@ucl.ac.uk), [i.hamilton@ucl.ac.uk](mailto:i.hamilton@ucl.ac.uk), [robert.lowe@ucl.ac.uk](mailto:robert.lowe@ucl.ac.uk), [a.mavrogianni@ucl.ac.uk](mailto:a.mavrogianni@ucl.ac.uk), [e.oikonomou@ucl.ac.uk](mailto:e.oikonomou@ucl.ac.uk), [r.raslan@ucl.ac.uk](mailto:r.raslan@ucl.ac.uk), [samuel.stamp10@ucl.ac.uk](mailto:samuel.stamp10@ucl.ac.uk), [andrew.stone@ucl.ac.uk](mailto:andrew.stone@ucl.ac.uk), [a.summerfield@ucl.ac.uk](mailto:a.summerfield@ucl.ac.uk), [david.veitch10@ucl.ac.uk](mailto:david.veitch10@ucl.ac.uk), [virginia.gori.12@ucl.ac.uk](mailto:virginia.gori.12@ucl.ac.uk) and [t.oreszczyn@ucl.ac.uk](mailto:t.oreszczyn@ucl.ac.uk)

The assumed  $U$ -values of solid walls represent a significant source of uncertainty when estimating the energy performance of dwellings. The typical  $U$ -value for UK solid walls used for stock-level energy demand estimates and energy certification is  $2.1 \text{ Wm}^{-2} \text{ K}^{-1}$ . A re-analysis (based on 40 brick solid walls and 18 stone walls) using a lumped thermal mass and inverse parameter estimation technique gives a mean value of  $1.3 \pm 0.4 \text{ Wm}^{-2} \text{ K}^{-1}$  for both solid wall types. Among the many implications for policy, this suggests that standard UK solid-wall  $U$ -values may be inappropriate for energy certification or for evaluating the investment economics of solid-wall insulation. For stock-level energy modelling, changing the assumed  $U$ -value for solid walls reduces the estimated mean annual space heating demand by 16%, and causes a proportion of the stock to change Energy Performance Certification (EPC) band. The analysis shows that the diversity of energy use in domestic buildings may be as much influenced by heterogeneity in the physical characteristics of individual building components as it is by variation in occupant behaviour. Policy assessment and guidance material needs to acknowledge and account for this variation in physical building characteristics through regular grounding in empirical field data.

**Keywords:** buildings, energy demand, epidemiology, heat flux measurements, solid walls, thermal conductivity,  $U$ -value

## Introduction

Approximately 5.7 million solid-walled houses exist in England, comprising 25% of the housing stock (CLG, 2012b). The vast majority of these dwellings have no wall insulation of any sort and present a real challenge for meeting energy efficiency targets set by the UK Government. The English Housing Survey (EHS) defines solid-wall construction as a building where external load-bearing walls are made of brick, block, stone or flint with no cavity (DCLG, 2012). Solid-walled dwellings are known to have lower levels of energy performance, and are more likely to have lower indoor temperatures than newer dwellings built with cavity walls. Proposals to address the energy performance of solid-walled homes have included internal or external insulation, glazing replacement, draught-proofing and heating

system upgrades (Dowson, Poole, Harrison, & Susman, 2012; Lowe, 2007). One of the main challenges to the case for undertaking these energy efficiency improvements is the uncertainty around the impact the measures will have on energy demand and thermal comfort (Dowson et al., 2012; Kelly et al., 2013). This uncertainty is due to the gap in understanding how the diversity in the physical characteristics of solid walls affects their thermal performance, and the socio-technical interactions between solid-wall dwelling systems and household occupants. Further, this gap also means that the energy modelling used to predict potential savings is not sufficiently capturing this uncertainty and is hindered by outdated or incorrect assumptions on the physical characteristics and occupant practices particular to solid-wall dwellings.

### Tackling solid-wall dwellings

In England, the shift to the use of solid-wall brick construction began during the great rebuilding from mid-16th century (Hoskins, 1953). For the present English housing stock, the overwhelming fraction of solid-walled dwellings, constructed mostly of brick, derives from the expansion of population from the mid-18th century to the beginning of the First World War (roughly six-fold from 1750 to 1900). In addition to the growth of the urban population, the expansion in solid brick housing was made possible for a number of reasons, including: improvements in industrial manufacturing of the brick stock through better mixing and moulding machines, the repeal of the brick tax in 1850, along with improved quarrying for deep clays that allowed for strong, dense bricks. Typically, these houses were constructed with brick walls of 9 inch (approximately 230 mm) thickness or greater, which supported two-storey constructions. Solid walls continued to be the most common construction for the domestic sector until the British housing boom of the 1920s and 1930s. Within this context, solid-walled dwellings are of particular concern because it is estimated that 70% of such buildings only have 9-inch thick walls and offer poor thermal performance (DCLG, 2012).

Solid-walled dwellings represent a key challenge for UK energy and buildings policy. British national decarbonization targets for 2050 legislate an 80% reduction in emissions on 1990 levels from all sectors of the economy (DECC, 2009). Key policy documents and their supporting studies show that the buildings sector needs to be almost completely decarbonized by 2050 in order to meet these legally binding targets (UK CCC, 2010; Usher & Strachan, 2011). Solid-walled dwellings are estimated to emit approximately 45 MtCO<sub>2</sub>/annum or 36% of total stock emissions. The UK Committee on Climate Change (UK CCC) has estimated that 2.3 million solid-wall dwellings would need to be insulated by 2022 in order to meet interim climate change targets (UK CCC, 2012).

Solid-wall properties are classed as hard-to-treat (HTT) homes because of the difficulty of applying standard energy efficiency measures (DEFRA, 2008). Solid-wall insulation (SWI) is applied either as an internal insulation, which may consist of thermal laminates, stud systems, breathable natural insulations and insulating paint, or external insulation, comprising insulated render and/or built-up rainscreen and cladding. The impact of insulating solid walls on energy demand is subject to a number of areas of uncertainty relating to: assumed physical characteristics used in modelling; design and installation issues that often degrade SWI performance; the role SWI plays in changing the whole building heat loss, including ventilation; the way the addition of SWI impacts on the operation of the heating systems and the thermal

comfort of the occupants; and the additional opportunities created for ‘comfort taking’.

As solid walls form both a large fraction of heat-related UK building CO<sub>2</sub> emissions and are known to be expensive and difficult to insulate, there is significant interest in establishing a robust understanding of their thermal performance. The most widely used estimate of the *U*-value – the measure of thermal conductivity – of a UK solid-wall property is 2.1 Wm<sup>-2</sup> K<sup>-1</sup>, which is found in guidelines published by the Chartered Institute of Building Services Engineers (CIBSE) (2006), and is used in the UK Standard Assessment Procedure (SAP) and reduced SAP (RdSAP) (BRE, 2012), which are demand estimation methodologies based on the Building Research Establishment Domestic Energy Model (BREDEM) model (Anderson et al., 2007). Both SAP and BREDEM are ISO 13790:2008-compatible models (ISO, 2008), with SAP used to fulfil the UK requirements for domestic energy certification under the European Union Energy Performance of Buildings Directive (European Commission, 2008).

The core assumptions and algorithms of SAP form the foundation of the evidence base from which UK policies on domestic energy are assessed and formulated. Several sensitivity studies of SAP have identified the importance of wall *U*-values in determining SAP ratings. For example, Stone, Shipworth, Biddulph, and Oreszczyn (2014) demonstrated that the heating system efficiency, external wall *U*-value and dwelling geometry account for approximately 75% of the observed variance in the energy performance rating of gas central heat houses in England. A key area of uncertainty is the solid-wall *U*-value that SAP uses as a default assumption. Laurent et al. (2013) noted that similar limitations apply to normative calculations used in other European Union countries.

There is growing evidence that solid-wall *U*-values are much lower than previously assumed (Baker, 2011; Rye & Scott, 2012). It is possible to propose a range of hypotheses to do with wall thickness, thermal conductivity, moisture content, mixed materials, air cavities, surface heat transfer coefficients and others to explain these differences. However, what is clear is the gap in knowledge related to how variation in solid-wall construction within the stock affects thermal performance.

The assumed *U*-values of solid walls in the UK are therefore a significant source of uncertainty when estimating energy savings, and carbon emission reductions, and when evaluating the investment economics of SWI. The growing body of evidence on the diversity of performance of UK solid walls is challenging current estimates of the impact on national energy demand of deploying SWI. If the thermal performance of UK solid walls is in reality greater than has been assumed to date, then the energy-saving and

decarbonization benefits of SWI are in fact lower than expected, which reduces the value of SWI in contributing to UK climate change mitigation targets. Another potential impact relates to UK building energy performance certification. A large number of Energy Performance Certificates (EPCs) may have been produced using inaccurate estimates of solid-wall  $U$ -values, with the result that solid-wall properties may have both their current energy performance and their potential for improvement erroneously reported.

### Aims and objectives

Several studies in recent years have attempted to measure the *in situ*  $U$ -values of solid walls in order to study the potential impact of insulation as a means of improving their thermal performance. These include the Energy Saving Trust (EST) Solid Wall Insulation Field Trials (Stevens & Russill, 2013) and studies by Glasgow Caledonian University (GCU) for Historic Scotland (Baker, 2011) and the Society for the Protection of Ancient Buildings (SPAB) (Rye, Scott, & Hubbard, 2012; Rye & Scott, 2012). All these studies found that the mean or median  $U$ -values measured for solid-walled construction were significantly lower than  $2.1 \text{ Wm}^{-2} \text{ K}^{-1}$  (around  $1.3\text{--}1.4 \text{ Wm}^{-2} \text{ K}^{-1}$ ). As discussed above, the implications of a discrepancy between real-world  $U$ -values and  $U$ -values assumed in energy modelling and standard UK building assessment protocols are significant for UK energy policy.

The major objectives of this paper are as follows:

- To provide valuable additional evidence on the subject of real-world solid-wall  $U$ -values. This is based on the presentation of additional analysis from the results of the EST Solid Wall Insulation Field Trials (SWIFT). The authors were not involved in the EST SWIFT but were commissioned by the UK Department of Energy and Climate Change (DECC) to provide a third-party audit of the data. The work presents a reinterpretation of the raw monitored data from SWIFT using a novel transient analysis methodology developed by Biddulph *et al.* (2014) that calculates not only the effective  $U$ -value but also the effective thermal mass of the construction.
- To assess the materiality of the change in  $U$ -value implied by the research study results on UK energy policy. The findings of the analysis are used as inputs into a standard building energy stock model to determine the impact these assumptions may have on estimates of national energy demand, energy savings from building retrofits, energy efficiency targets and building energy performance certification.

- To present an in-depth discussion of the factors that might contribute towards the observed variation in measured *in situ* solid-wall  $U$ -values in terms of both the physical properties of the walls themselves and the way in which they are monitored. The discussion also reviews additional evidence that might corroborate or challenge the emerging view that solid walls in the UK housing stock have  $U$ -values below those quoted in the CIBSE guides and other guidance.

### Review and re-analysis of field trial data

#### Data selection

Data from a 2011/12 solid-wall field trial conducted by DECC and EST were provided for review and analysis. The data comprised heat flux measurements, temperature monitoring, energy meter data, physical survey information of the dwelling, and photographs along with the final report produced by the Building Services Research and Information Association (BSRIA) for EST (Birchall, Pearson, & Brown, 2011). In total, 93 properties thought to have solid walls were selected for monitoring and surveying using a range of installed equipment.

Wall heat transfer measurements were collected in accordance with ISO 9869:1994 (Birchall *et al.*, 2011). The wall was instrumented with a heat flux meter (HFM) and thermistor temperature sensors (ISO, 2014); the data were averaged over five minutes and recorded on Eltek 401 data loggers (Eltek, 2013). The HFM (Hukseflux HFP01; Hukseflux, 2013) was placed on the inside surface of the wall. Silicon grease was used to achieve good thermal contact between the HFM and the wall surface, while a thin polyvinylchloride (PVC) film was applied to protect the wall surface. The thermistors were placed in the air near the internal and external surfaces of the wall.

In addition, indoor air temperature and humidity sensors (measuring at five-minute intervals) in three zones (typically the living room, hall and bedroom) and external temperature and humidity sensors (also recording at five-minute intervals) were recorded.

The monitoring of occupied dwellings faces a number of challenges in terms of both sample selection and the process of physically installing transducers and other sensors into the selected buildings. The following steps were taken to filter the raw data:

- Buildings identified in the BSRIA report as being clad with facade material or with any form of explicit air cavity construction were removed from the data sample. From those buildings that

remained, photographic information was used to select brick and stone walled buildings.

- Data from problematic flux meters or thermometers were excluded from the analysis. For example, in some cases there are data readings showing regular high-temperature spikes. These are almost certain to be the result of sensor placement in close proximity to heat emitters such as domestic wet radiators and/or cases where sensors are located in areas of direct solar exposure.

A remaining sample of 40 brick and 18 stone walled buildings was selected for further analysis.

### **$U$ -value calculations**

Two methods for the calculation of  $U$ -values from *in situ* measurements were applied to the selected analysis sample described above: a running average method following standard ISO 9869-1:2014 (ISO, 2014); and a new method based on a lumped thermal mass model and a Bayesian-based parameter optimization technique (Biddulph et al., 2014).

#### **Average method**

The average method assumes steady-state heat flow to infer the thermal resistance ( $R$ ), and therefore thermal transmittance ( $U$ ), of a building element. The thermal resistance is defined (ISO 9869:1994) as the ratio of the mean temperature difference measured between the two sides of the element – in this case indoor ( $T_{in}$ ) and external ( $T_{ext}$ ) air temperature – and the mean

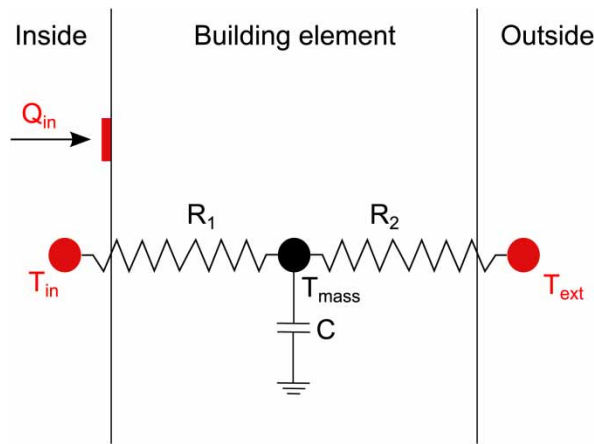

**Figure 1** The single thermal mass model, its unknown parameters and the measured data.

*Note:* This model is applicable during the heating season. The unknown parameters are two thermal resistances ( $R_1$ ,  $R_2$ ), one thermal mass ( $C$ ), and the initial temperature of the thermal mass ( $T_{mass}^{init}$ ). The measured data – used to predict the model parameters – are the heat flux entering the internal surface of the element ( $Q_{in}$ ) and the internal and external air temperatures ( $T_{in}$ ,  $T_{ext}$ )

measured heat flow ( $Q_{in}$ ) passing through the element:

$$R = \frac{1}{U} = \frac{\sum_{j=1}^n (T_{in,j} - T_{ext,j})}{\sum_{j=1}^n Q_{in,j}} \quad (1)$$

To ensure that the hypothesis of steady-state conditions is met, and therefore that the effects of the thermal mass are zero on average, sufficiently long data series have to be analysed and whole days have to be sampled in order to capture the full diurnal cycle (ISO 9869:1994). The ISO 9869 (1994) standard states that monitoring campaigns have to last from a minimum of three days up to more than seven days. However, it is common practice to extend the monitoring period to two weeks or more to achieve satisfactory results and stable conditions (Baker, 2011). Fluctuations in internal and external conditions immediately prior to and during the *in situ* survey have an influence on the monitoring campaign length, as do small temperature differences between the two sides of the element under study. Therefore, it is preferable that internal and external conditions are kept as constant as possible during the monitoring period, although it is difficult to achieve full control of the internal temperature in occupied properties and impractical to control external temperature. To decrease the impact of errors on the results, measurements preferably have to be collected when the temperature difference is equal or greater than  $10^\circ\text{C}$  (Desogus, Mura, & Ricciu, 2011).

#### **Lumped thermal mass method**

Biddulph et al. (2014) developed a novel combination of a lumped thermal mass model and a Bayesian-based inverse optimization technique to infer the thermal properties of a building element from *in situ* measurements. The lumped thermal mass model is used to model the building element analysed and infer the relationship among the parameters involved. The Bayesian data analysis is adopted for parameter optimization and consequently  $R$ - and  $U$ -value prediction.

In this paper, a single lumped thermal mass model is described and adopted for data analysis (Figure 1). The model has four unknown parameters: two thermal resistances ( $R_1$ ,  $R_2$ ), one thermal mass ( $C$ ) and the initial temperature of the thermal mass ( $T_{mass}^{init}$ ). Once the thermal mass temperature ( $T_{mass}$ ) (*i.e.* the virtual temperature of the lumped thermal mass) at the current time step ( $p$ ) (*i.e.* the current data recording index) is known, the thermal mass temperature at the next time step ( $p+1$ ) (*i.e.* the data recording index after one-time step duration,  $\tau$ ) can be predicted recursively:

$$T_{mass}^{p+1} = \frac{T_{in}^{p+1}/R_1 + T_{ext}^{p+1}/R_2 + C T_{mass}^p/\tau}{1/R_1 + 1/R_2 + C/\tau} \quad (2)$$

At each time step  $p$ , the heat flux entering the building element ( $Q_{in}^p$ ) can be predicted using the predicted thermal mass temperature ( $T_{mass}^p$ ) and the measured indoor air temperature ( $T_{in}^p$ ) at the same time step:

$$Q_{in}^p = \frac{(T_{in}^p - T_{mass}^p)}{R_1} \quad (3)$$

The predicted heat flux time series is then analysed using the Bayesian optimization technique to determine the set of parameters that enables the model to reproduce best the measured heat flux.

Once the best set of parameters has been identified, the overall thermal resistance ( $R$ ) of the element and its thermal transmittance ( $U$ ) can be predicted using:

$$R = \frac{1}{U} = R_1 + R_2 \quad (4)$$

The modelling error made for the two methods was computed for comparison. The statistical error on the  $U$ -value estimate by using the average method was reported to be of the order of  $\pm 15\%$  (Birchall et al., 2011), while the statistical error on the  $U$ -values determined from the lumped thermal mass method was less than  $\pm 0.4\%$ , with the remaining sources of error being the flux meters themselves, accurate to  $\pm 5\%$ , and the thermometer readings, accurate to  $\pm 0.1^\circ\text{C}$  (Biddulph et al., 2014).

#### Measurement uncertainties

Uncertainties in heat flux and temperature measurements arise due to the following:

- Variation in the quality of the thermal contact of the heat flux sensors with the walls being tested. In occupied buildings this is complicated by factors such as rough internal surfaces, *i.e.* embossed wallpaper and the need to avoid damage to the wall surfaces.
- Variation in the temperature difference across the tested wall, arising from internal and external air temperature variations; and insulation. Dynamic techniques for identifying the solar heat gain component from buildings measured in real outdoor conditions are covered by Baker and van Dijk (2008) under the PASSYS project, as well as more recently by Stamp, Lowe, and Altamirano-Medina (2013a).
- Obtaining unobstructed one-dimensional heat flow measurements. The presence of windows, locations of radiators and furniture, and junctions with other walls all restrict the positioning of equipment and complicate the interpretation of

data. For example, placing sensors near the junction of external and internal walls rather than in the centre of the walls can have a significant effect on local internal temperature and heat flux readings. In fact, in many occupied buildings the fundamental concept of one-dimensional heat flow represented in a  $U$ -value calculation becomes difficult to envisage as there is very little unobstructed plane wall that is exposed to well-mixed internal air temperature. Instead, most walls have significant areas of two- or three-dimensional heat flow or are obstructed by furniture or general household clutter. The current authors' re-analysis of the EST SWIFT data suggests that temperatures varied significantly over the internal surfaces of walls that were measured. This is significant because the concept of  $U$ -value assumes well-defined environmental temperatures on both sides of the construction element under analysis. Heat flux and internal temperature were measured at two locations in each EST sample dwelling. In many cases, heat flux measurements show significant divergence at times when the heating system was on – direct evidence of complex temperature fields, which make it difficult to be sure that measured internal temperatures relate correctly to measured heat fluxes. The experimental approach carried out by BSRIA in the EST SWIFT holds the potential for sources of systemic error and scatter that could potentially impart a downward bias on  $U$ -value estimates. It is not clear whether BSRIA used thermal imaging techniques in EST SWIFT project (*e.g.* according to BS EN 13187 or ISO 6781) in order to identify optimal locations for the positioning of measurement sensors (BSI Group, 1999; ISO, 1983), although such an approach should definitely be considered for any future work as it is standard practice even with ISO 9869.

- The EST SWIFT did not systematically record information on the overall thicknesses of the walls being measured, which represents a significant potential source of variation in wall  $U$ -values. That the authors cannot quantify this uncertainty is an unfortunate limitation of carrying out secondary analysis on primary data collected by a third party. The detailed physical dimensions and built construction within the tested walls were unknown and also not collected by BSRIA as this would have required invasive or destructive testing of the wall being measured.

#### $U$ -value analysis results

The distribution of  $U$ -values estimated using the lumped thermal mass method is illustrated in Figure 2. The average of the two flux meters installed on both walls is taken as the  $U$ -value for the wall. The mean-measured  $U$ -value of the sample for those walls

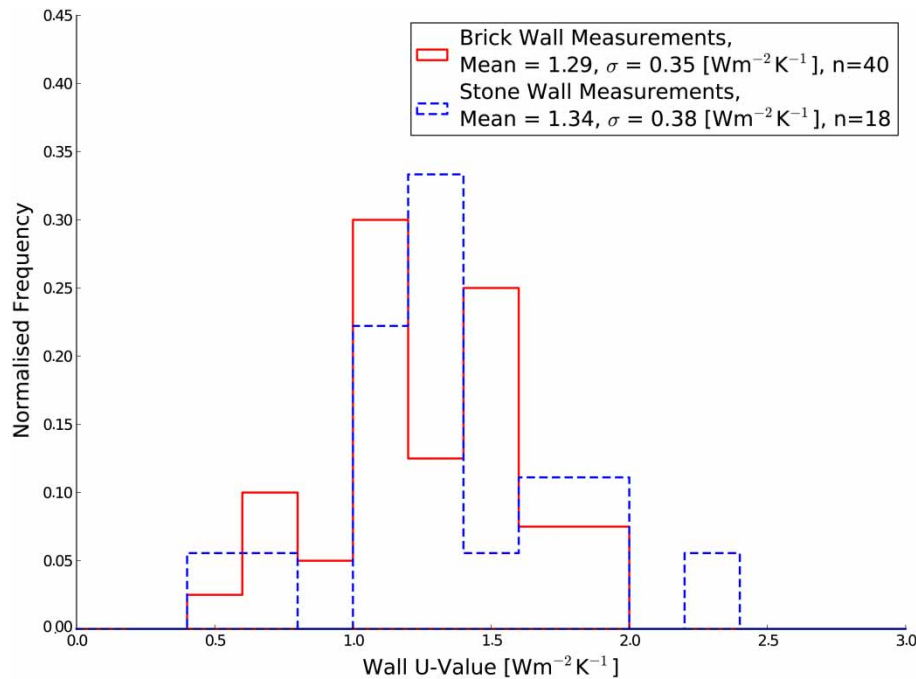

**Figure 2** Distribution of calculated  $U$ -values from 58 heat flux plate measurements on solid brick and stone walls

that appear to be of solid brick construction was  $1.29 \text{ Wm}^{-2} \text{ K}^{-1}$ , and  $1.34 \text{ Wm}^{-2} \text{ K}^{-1}$  for stone, with standard deviations of about  $0.35$  and  $0.38 \text{ Wm}^{-2} \text{ K}^{-1}$  respectively. Figure 2 shows that the distributions in both brick and stone walls are actually very similar. In this sample only one brick wall property had a  $U$ -value equal to or greater than  $2.1 \text{ Wm}^{-2} \text{ K}^{-1}$ .

The mean calculated  $U$ -value of this limited sample for the walls using the standard average method was  $1.32 \pm 0.39 \text{ Wm}^{-2} \text{ K}^{-1}$  for brick and  $1.31 \pm 0.55 \text{ Wm}^{-2} \text{ K}^{-1}$  for stone (Figure 3). There was very good agreement between the two analysis methods for each wall. The  $U$ -value quoted in the BSRIA report for the whole EST SWIFT sample, including stone and brick walled dwellings, is  $1.4 \text{ Wm}^{-2} \text{ K}^{-1}$ .

The lumped thermal mass  $U$ -value calculation method can provide an estimate of the  $U$ -value using a much shorter duration time series compared with the widely employed ISO 9869 method, although this of course does not diminish the value of additional data collection over longer timescales where this is possible. It also has the advantage of calculating an effective thermal mass of the wall. The mean effective thermal mass was  $197 \pm 117 \text{ KJm}^{-2} \text{ K}^{-1}$  for the brick walls and  $329 \pm 115 \text{ KJm}^{-2} \text{ K}^{-1}$  for the stone walls. Figure 3 shows a plot of the  $U$ -value versus the effective thermal mass for both the stone and brick solid walls calculated from the heat flux plate and temperature measurements, plus best-fit lines through the data. Brick can have a range of different densities; theoretically one would expect an increase

in density to cause an increase in both the thermal mass and the thermal conductivity and hence  $U$ -value. CIBSE Guide A (CIBSE, 2006) has a set of standard thermal conductivities and thermal capacities for bricks of different densities ( $1200$ – $2000 \text{ kg m}^{-3}$ ). If these values are used to calculate the variation in  $U$ -value (of a solid  $220 \text{ mm}$  brick wall with  $13 \text{ mm}$  dense plaster, which is a typical wall construction defined in CIBSE Guide A) and thermal mass, the dashed straight line labelled ‘theory’ on Figure 3 is arrived at. The solid lines represent fits to the data. It can be seen immediately that the brick and stone walled properties fall into different statistical clusters, with the theoretical value of a ‘solid wall’ found in the literature falling somewhere between the two. Note the effective thermal mass estimated with the lumped thermal mass analysis technique is not directly comparable with the thermal mass calculated using information on the density, heat capacity and dimensions of the wall materials, but the authors would expect it to vary in a qualitatively similar way.

### Stock-level energy consumption

A BREDEM-based stock model, the Cambridge Housing Model (CHM) version 3.0, was used to assess the impact that changing the assumed  $U$ -value of solid-walled homes could have on the energy consumption of the English housing stock. The stock model, described in detail by Hughes, Palmer, and Pope (2013), uses a modified version of SAP2009 to

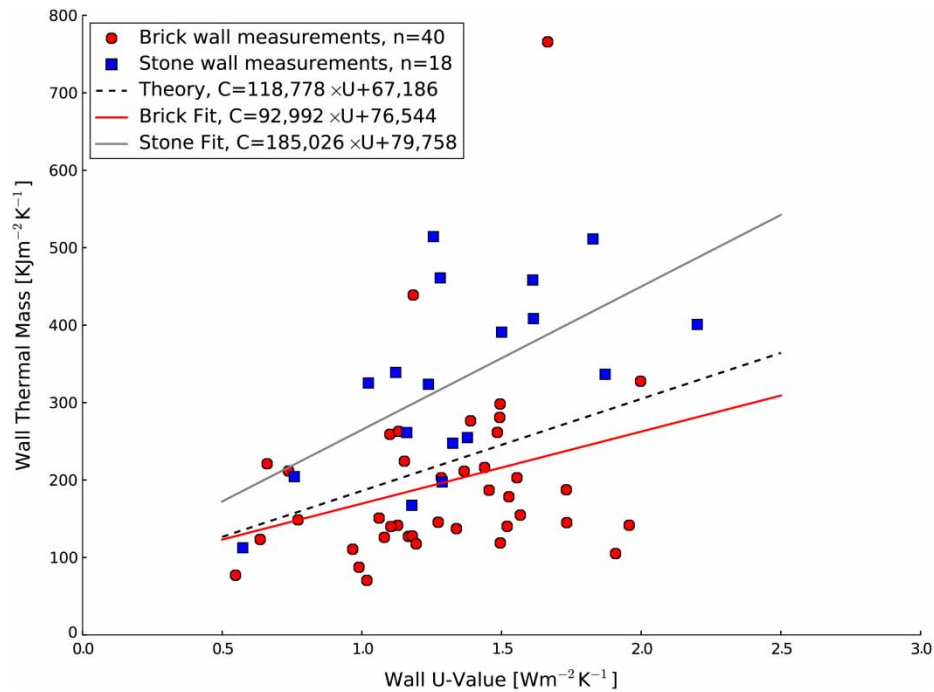

**Figure 3** Calculated  $U$ -value and effective thermal capacity of brick and solid walls using the lumped thermal mass method compared with the theoretical thermal mass of brick using CIBSE Guide A values

calculate energy demand (along with other outputs, such as  $\text{CO}_2$  emissions). The minor modifications of SAP2009 in the CHM were designed to make the results more representative of real energy use (whereas a standard SAP calculation is designed to benchmark a dwelling), which includes using occupancy derived from the EHS instead of the SAP floor area correlation; a lower heating demand temperature in CHM; and using regional climate data instead of average English climate data in CHM. For further details see the CHM version 3.0 user guide (Hughes et al., 2013). The stock model was populated with 2009 EHS data. The EHS is a cross-sectional survey that is representative of English houses and households therein and contains information on approximately 16,000 dwelling variants (CLG, 2012a). It provides information on dwelling fabric characteristics (*i.e.* construction material of the walls, roof, flooring, windows and doors), heat system type and presence of ventilation, which are used as inputs into the energy stock model. The EST SWIFT sample of 93 properties was selected on the basis of access to properties and so may not be representative of the English housing stock as a whole.

Results from the  $U$ -value analysis of the SWIFT data are used to replace the standard solid-wall  $U$ -values used in CHM. The impact that these assumptions have can then be examined for stock level space heating energy demand estimates. Using the CHM stock energy model, solid-wall dwellings classed by

the EHS as having solid brick walls (9 inch/approximately 230 mm or greater) were selected as a sample. Estimates of the stock level space heating energy demand is made under three conditions:

- using the standard value for solid brick walls
- using the SWIFT mean  $U$ -value for solid brick walls
- using a randomly selected  $U$ -value using the empirical SWIFT distribution, which accounts for the uncertainty in the measured  $U$ -values

The CHM has standard assumptions about the  $U$ -value of solid walls that are aligned with those of the RdSAP methodology. Solid-walled buildings constructed post-1976 are assumed to have a  $U$ -value of  $1.29 \text{ Wm}^{-2} \text{ K}^{-1}$ , while older buildings are allocated  $U$ -values that indicate poorer performance with age, tapering out to a worst-case value of  $2.1 \text{ Wm}^{-2} \text{ K}^{-1}$ . For the purposes of the analysis presented here, dwellings with a solid-wall  $U$ -value of more than  $1.29 \text{ Wm}^{-2} \text{ K}^{-1}$  (*i.e.* anything built before 1976) were modified. Values for post-1976 dwellings were not changed, as these are unlikely to be of solid-wall construction. For case 'c' the  $U$ -value of each solid wall was replaced randomly according to a normal distribution with the specified mean and standard deviation. A lower limit of  $0.25 \text{ Wm}^{-2} \text{ K}^{-1}$  (the  $U$ -value



of a modern solid brick wall according to RdSAP) for the solid-wall  $U$ -value was set for any values where the sampling gave rise to any negative  $U$ -values. This affected only 21 out of 14,951 cases, which corresponds to only 0.14% of the data, and is unlikely to have affected observations.

### Impact of altering assumed $U$ -values

Figure 4 shows the distribution of energy demand for solid-wall properties using the EHS. It can be seen immediately that applying different  $U$ -value estimates (under cases a–c) to the EHS solid-wall dwelling stock causes a change in the proportion of dwellings (vertical axis) found at each heating demand level (horizontal axis). For example, comparing the base case (case a, black line) and the SWIFT value cases (cases b and c, red and blue lines), it can be observed that the curves shift to the left. This means that under these cases, an increased proportion of the solid-wall stock is found to consume less heating energy. When taken in aggregate, the impact on the solid-wall dwelling stock of changing the solid-wall  $U$ -value from the standard value of  $2.1 \text{ Wm}^{-2} \text{ K}^{-1}$  to  $1.3 \text{ Wm}^{-2} \text{ K}^{-1}$  is a change in the mean predicted annual heating demand of 16% or  $0.1 \text{ Wm}^{-2} \text{ K}^{-1}$ , which corresponds to a change in mean English heat demand of about 2%.

The impact of variation in solid-wall  $U$ -values on total heat demand (as opposed to mean heat demand) is discussed below. The range in solid-wall  $U$ -values of the

order discussed in this paper is almost certainly small compared with the heat loss of the UK housing stock as a whole. Reducing the represented  $U$ -value of solid walls in the stock from  $2.1$  to  $1.3 \text{ Wm}^{-2} \text{ K}^{-1}$  (*i.e.* scenario ‘b’) would reduce the heat loss of the English domestic stock by approximately  $400 \text{ MW K}^{-1}$ . This compares with a modelled total heat loss for the English stock in excess of  $6 \text{ GW K}^{-1}$  (Palmer & Cooper, 2013). Assuming that internal temperatures were the same in both cases, this difference in heat loss results in a difference in total English domestic space heating demand of 6% (or 13 TWh/year) (Table 1). However, given the many uncertainties associated with modelling energy demand in solid-wall dwellings, it is likely that these effects may not be detected at the level of the stock as a whole.

### Implications for Energy Performance Certificates (EPCs)

The same stock model was used to calculate the impact of changing the solid-wall  $U$ -value on the A–G banding of EPCs. Figure 5 shows the number of solid-walled dwellings that moved up to the next EPC band as a result of changing their estimated  $U$ -value from  $2.1$  to  $1.3 \text{ Wm}^{-2} \text{ K}^{-1}$ . Approximately one-third of all solid-wall dwellings move one EPC band when this change is applied. Note that no dwellings change by more than one band. A total of 20% of dwellings initially rated as D became rated as C, and 10% of those rated as E became rated as D following this change in estimated  $U$ -value.

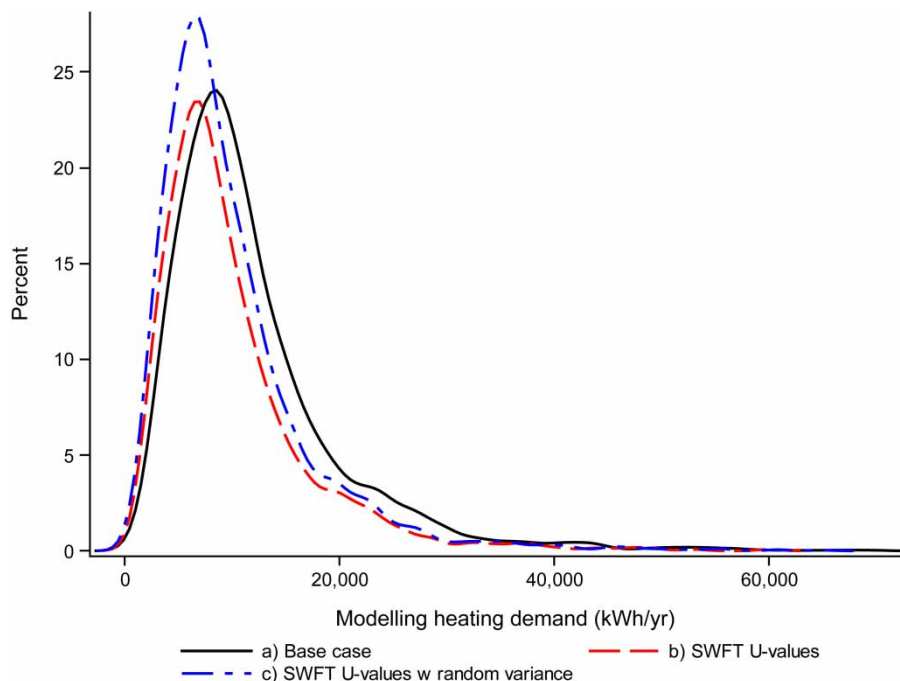

**Figure 4** Distribution of modelled space heating energy demand (gas plus electricity) for English solid-wall dwellings using standard  $U$ -values (a), SWIFT mean  $U$ -values (b), and with uncertainty variation in SWIFT  $U$ -values (c)

**Table 1** Total predicted annual space heating demand for English stock under three different  $U$ -value scenarios

$U$ -value scenarios	Total space heating demand (TWh/year)		
	Non-solid wall	Solid wall	All
(a) Base case	126.2	77.7	203.9
(b) SWIFT $U$ -values	126.2	65.3	191.4
(c) SWIFT $U$ -values with random variance	126.2	65.1	191.3

### Discussion of the findings

A number of physical and experimental factors can be hypothesized to account for the variation seen in  $U$ -value measurements carried out as part of the EST SWIFT.

#### Physical factors

As noted above, the standard  $U$ -value assumption used in UK building performance assessment for solid brick walls is  $2.1 \text{ W}^{-1} \text{ m}^2 \text{ K}$ . It is straightforward to construct a calculation that yields a figure at or close to this value, assuming a wall that is completely solid, is exposed on the outer side, with a corresponding gradient of moisture content and conductivity, and has a density in the region of  $1800 \text{ kg m}^{-3}$ . However, the

process of investigating the results of the EST SWIFT data yielded a number of real-world insights regarding solid wall and in particular brick construction that could explain the diversity of  $U$ -values calculated in this paper.

Standard solid brick wall  $U$ -values are based on an assumed wall thickness of 220 mm brick and approximately 12 mm of dense plaster. Modern bricks are 220 mm long and so this assumption would be logical for a modern brick wall.<sup>1</sup> However, there are two historic reasons why older properties would be expected to have wall thickness that deviate from this assumed standard.

The first historical reason relates to changes in construction standards over time that has affected the thicknesses of typical walls in buildings of different heights. A thicker wall of a given material has a lower  $U$ -value than a thinner wall of the same material: the  $U$ -value of the material itself is inversely proportional to its thickness (ISO, 2007b). The inverse proportionality is not true of solid walls as a whole, because they are made up of a sandwich of different layers – plaster and brick, or stone – but it is true of the brick or stone layer itself. Following the Great Fire of London in 1666 brick properties over two stories were required to be constructed with walls that were more than one brick thick. The required thickness of load-bearing masonry walls in England therefore increases with the height of the building. While two-storey buildings can be built with walls of

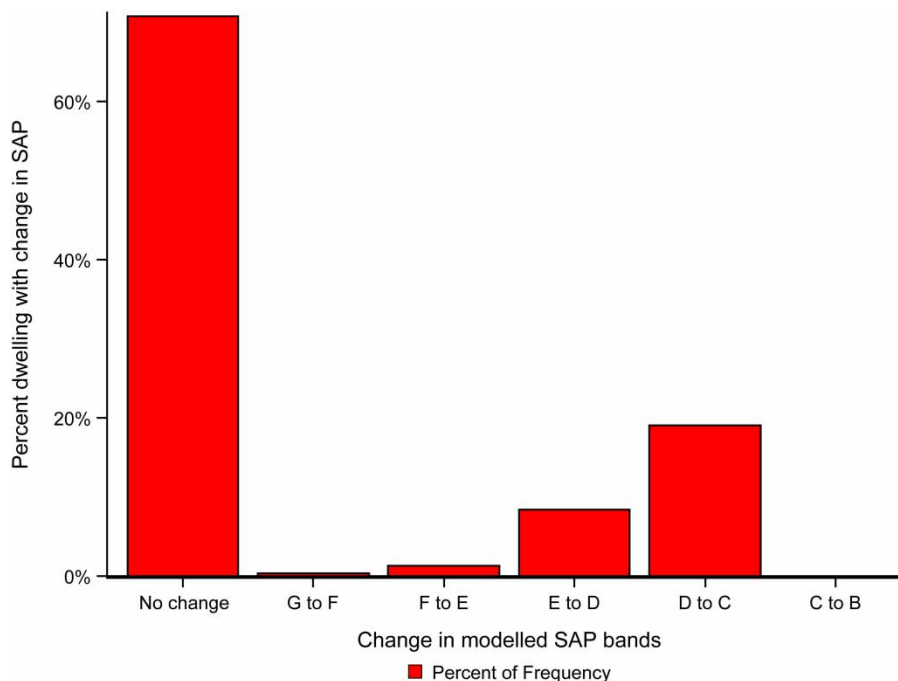
**Figure 5** Percentage of solid-wall dwellings that would move up an EPC band if the  $U$ -value for the solid wall were changed from  $2.1 \text{ Wm}^{-2} \text{ K}^{-1}$  (scenario 'b')

just over 200 mm thickness, three-storey buildings require a minimum of 300 mm and four-storey buildings require walls of at least 400 mm. While the mean thicknesses of the walls in the EST SWIFT were not systematically recorded, it is obvious that the mean thickness of solid walls in the UK housing stock is likely to be greater than the nominal 220 mm of a single brick wall. It is possible that when CIBSE guidelines<sup>2</sup> on *U*-values were written, the authors deliberately quoted a conservative value for a 220 mm brick wall as a worst case to ensure that heating systems designed on this basis were not undersized.

The second historical reason relates to variation in wall thickness brought about by changes in the size of typical bricks. The introduction of the brick tax in 1784 stimulated the production of larger bricks to reduce the tax paid per brick in a given wall size. Although there has been no systematic study of the length of bricks, past works have suggested that the majority of brick lengths are greater than 220 mm, particularly in properties built before 1850 (Lloyd, 1925).

Small changes to other properties of walls: density of brick and plaster, exposure to wind (Bankvall, 1977), moisture penetration (CIBSE, 2006; ISO, 2007a), and, most importantly, the occurrence of small air cavities within nominally solid walls can result in *U*-values in the range measured in the EST SWIFT. The chemist and linguist Benjamin Lee Whorf proposed that language affects perception (Whorf, 2012). The current authors suspect that the use of the term ‘solid wall’ is a classic example of Whorfian mis-labelling, which has helped to mislead a generation of building scientists about the likely thermal properties of such walls. So-called ‘solid walls’ are in fact often not completely solid. Brick walls can be built up in a variety of different patterns, but are typically constructed with a mixture of brick types, with some going straight through the full depth of the wall, known as headers, and some laid side by side, known as stretchers. In order to allow walls to be constructed with a regular type of mortar bond, the total width of two adjacent stretchers is less than the length of a header by the width of a mortar joint, which is typically 5–10 mm. Although some mortar will intrude into the space as snots from joints between stretchers, the practical constraints of bricklaying mean that this gap is often not filled with mortar. There is a high probability that solid-wall segments built with stretchers contain air gaps.

If stretchers are assumed to comprise 50–80% of the wall surface, with air gaps of the order of  $\approx 10$  mm, then a straightforward calculation with identical assumptions regarding brick density etc. yields *U*-value estimates in the range of 1.65–1.8  $W^{-1} m^2 K$ .

‘Solid’ stone walls may also contain residual air cavities for similar reasons. Walls built with stone are often thicker overall than single-brick walls and often employ rubble-filled cores. It is almost certain that there are voids within these cores that would increase the thermal resistance of the element relative to that of a completely solid wall. The differences in the observed thermal properties of brick and stone walls (as discussed above in the context of Figure 3), and differences in the potential causal mechanisms for variation within the observed *U*-values for each wall type, highlight the risks of using the blanket term ‘solid walls’ without due consideration in a building physics context.

The presence of residual cavities in solid walls is not the only possible source of variability in real *U*-values. Plausible variations in brick density, moisture content, the thermal properties of the plaster and external rendering used could easily explain a further reduction of the order of 0.2  $W^{-1} m^2 K$  in *U*-value. Note that some of these factors will interact, e.g. residual cavities may lead to reduced rain penetration and higher inner stretcher temperature resulting in lower moisture content, which in turn will result in lower local thermal conductivity.

Figure 6 and Table 2 show the sensitivity of a *U*-value calculation to different assumed resistances as a result of changing various parameters over reasonably conservative ranges taken from CIBSE Guide A and assuming the length of bricks changes from 220 to 230 mm and how this changes with the air gaps in wall construction. UK bricks can vary slightly in size, not only due to manufacturing tolerances but also whether they are built to metric (220 mm) or imperial (9 inch, approximately 230 mm) standards. Using Figure 6 it is easy to hypothesize the range of *U*-values presented in this paper.

Figure 6 illustrates the impact of varying air gaps. The black line represents the *U*-Value of a wall with ‘standard’ properties, but with an ever-increasing air gap in the middle of the structure. The width of the wall increases as the air gap increases. The ranges of estimates for the factors that are used to estimate the *U*-value are shown as a coloured band. To keep the diagram simple, the effects of each parameter range are added to the previous band to show the maximum possible range of *U*-values available. Crucially, most factors tend to reduce the estimate of *U*-value.

#### **Corroborating evidence from other sources**

This section examines other investigative techniques that could be used to shed additional light on the causal mechanisms between observed *U*-values and those found in the literature. To carry greatest

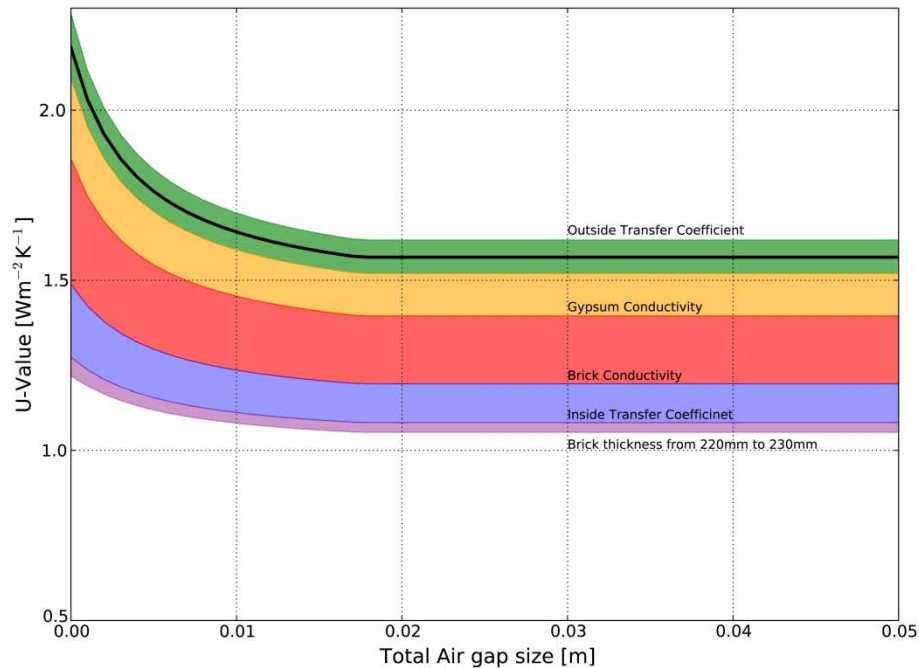

**Figure 6** *U*-value estimates as a function of internal air gap width in a 220 mm solid brick and 13 mm dense plaster wall

weight, such corroborating evidence would need to be based on measurements that make use of different physical principles than those used for direct measurements of *U*-value made by GCU and EST. Two other sources of evidence that might corroborate or cast doubt on the results obtained from direct measurements of heat flux described in this paper were identified: co-heating tests and the analysis of annual gas and electricity use.

The strength of co-heating testing is that it directly measures the heat loss through the whole of the dwelling envelope, and therefore overcomes one of the main limitations of measurements made with a small number of heat flux and temperature sensors. However, there are several weaknesses:

- Co-heating testing measures the total heat loss through all parts of the thermal envelope of the building and through ventilation. Estimates of heat loss through walls can only be made by making additional assumptions about heat loss through other elements of the envelope, but these may be as problematic as the walls themselves.
- The errors in co-heating testing are complex and not well understood (Stamp et al., 2013b) – it is therefore currently impossible to provide good estimates of error bands on whole-house heat loss coefficients made by this method. A brief, but comprehensive, overview of systematic and random errors in co-heating testing can be found

**Table 2** Estimates of the standard *R*-value, *R*-value ranges and corresponding *U*-value ranges for the parameters used in the calculation of the *U*-value shown in Figure 5

Material	<i>R</i> -value standard ( $\text{m}^2 \text{K W}^{-1}$ )	<i>R</i> -value range ( $\text{m}^2 \text{K W}^{-1}$ )	<i>U</i> -value range ( $\text{W m}^{-2} \text{K}^{-1}$ )
Inside air	0.13	0.13–0.18	2.18–1.97
Outside air	0.04	0.02–0.06	2.28–2.10
Brick (conductivity)	0.26	0.35–0.26	1.81–2.18
Brick (depth 220–230 mm)	0.26	0.26–0.27	2.18–2.12
Dense plaster	0.026	0.081–0.026	1.95–2.18
Air gap	0	0–0.18	2.18–1.57

Source: Ranges of the conductivities and *R*-values were taken from CIBSE (2006).

in Johnston, Miles-Shenton, Farmer, and Wingfield (2013).

- Some key sources of error in estimates of solid-wall  $U$ -values also affect co-heating testing. For example, achieving a uniform internal temperature in solid-walled houses is difficult. Typically it is done with internal fans. Unfortunately such fans are likely to impact significantly on the internal boundary layer, resulting in increased  $U$ -values for all elements. Variation in the level of solar radiation incident on the building also introduces experimental error. Ideally, the solar heat component needs to be separated out from fabric heat losses using parameter identification techniques such as those described in Baker and van Dijk (2008).
- Very little co-heating testing of existing solid-walled properties has been done and published (several commercial solid-wall co-heating tests have been undertaken by different organizations in the UK), so only a limited body of evidence exists. A study of 39 co-heating tests performed by researchers at Leeds Metropolitan University represents perhaps the single largest UK study to date (Gorse, Glew, Miles-Shenton, Farmer, & Fletcher, 2013).

The authors are aware of only one solid-walled house in the UK that has been subjected to a co-heating test (Stamp et al., 2013a, 2013b). In broad terms, and subject to the substantial caveats listed above, the result is consistent with the results of heat flux measurements (Baker, 2011).

Analysis of annualized gas meter data records versus age of property provides evidence that for older properties current modelling predictions *overestimate* the energy use when using SAP and its standard assumptions compared with annualized meter data and newer buildings to use more energy than SAP models predict (Laurent et al., 2013; Sunikka-Blank & Galvin, 2012). This discrepancy has historically been attributed to higher temperatures being maintained in newer, better insulated buildings but in fact may be in part attributable to solid walls losing less heat than previously assumed.

## Conclusions

While there is some evidence that the sample monitored in the EST SWIFT may not be fully representative of English solid-walled properties as a whole, the weight of evidence from this study and other measurements is that the mean  $U$ -value of English solid-walled properties is significantly lower than the CIBSE Guide A value of  $2.1 \text{ Wm}^{-2} \text{ K}^{-1}$ , and that the distribution of  $U$ -values

is so large that the on-going use of a single mean cannot be justified when assessing individual properties. The critical factor in the apparent inconsistency between CIBSE guidelines and the results of the EST SWIFT is the widespread treatment of UK solid-wall construction as being homogenous throughout the building stock by the standard methods used in regulatory assessment of buildings and, consequently, by much of the building modelling community. While this variation in solid-wall construction is no doubt well understood by UK building historians, building conservators and architectural archaeologists, the implications for building thermal performance are poorly understood and current assessment methods do not adequately account for them. Nevertheless, this paper demonstrates that plausible variations in the properties of thermal elements such as the thickness and density of brick and plaster, exposure to wind, moisture penetration, coupled with the occurrence of small air cavities within nominally solid walls, can result in  $U$ -values in the range measured in the EST SWIFT.

This paper also demonstrates that heat flux measurements are difficult to undertake in occupied properties and there are possible sources of error. Some sources of error could lead to under-predictions of the  $U$ -value. These include poor thermal contact between the solid wall and the heat flux sensor, difficulty in locating the sensor in an unobstructed element of the wall, and thermal bridging from adjacent partition walls. The use of a lumped thermal mass  $U$ -value calculation method agreed well with the normally used running average ISO standard method (ISO, 2014). In addition, it enables reliable results to be provided in less controlled conditions over shorter time periods and provide an estimate of the thermal mass of the construction. But it does not overcome basic problems such as non-uniform internal temperatures, variable boundary layers, and thermal bridging.

The implications of actual real world  $U$ -values for solid walls being in the region of  $1.3 \text{ Wm}^{-2} \text{ K}^{-1}$  rather than  $2.1 \text{ Wm}^{-2} \text{ K}^{-1}$  are important for understanding stock level energy demand. If real world solid walls are more thermally resistive than was previously understood to be the case, then this significantly reduces the energy savings achievable from SWI.

The cost-effectiveness of SWI may reduce if the actual  $U$ -value is lower than  $2.1 \text{ Wm}^{-2} \text{ K}^{-1}$ , however, the authors suspect that this reduction may turn out to be small compared with the effects of some of the other assumptions/uncertainties in a cost-effectiveness calculation for many solid-walled properties in England. For example:

- Many cost-effectiveness calculations assume that some of the benefit of solid-walled insulation is taken as ‘comfort’. The ‘comfort taking’ or

'rebound' factor is itself normally deduced from the discrepancy between actual and theoretical savings. But if, in the case of solid walls, the theoretical estimate of savings was based on an overestimate of the starting  $U$ -value, this approach could have led to an overestimate of comfort taking. In revising the starting  $U$ -value downwards, it may also be necessary to revise downward the estimate of comfort taking. More generally, estimates of comfort taking based on well-insulated constructions may not be transferrable to poorly insulated constructions. There are good reasons to suspect that theoretical calculations overestimate the  $U$ -values for poorly insulated walls and underestimate the  $U$ -value for well-insulated walls (Lowe, Wingfield, Bell, & Bell, 2007). Finally, it is hard to understand why no explicit economic value is put on higher levels of comfort that result from SWI.

- The addition of SWI is likely to not only change the fabric heat loss but also the ventilation heat loss. Calculations like SAP do not automatically give a credit for insulation reducing the ventilation rate.

It must also be noted that solid walls are insulated for reasons other than to save energy. The most important reasons are to reduce the incidence of condensation and mould on internal surfaces. These drivers are not significantly weakened by an improvement in uninsulated solid-wall  $U$ -values. A brief review of the uncertainties associated with costs of future heat supply suggests that all such cost-effectiveness estimates are subject to significant sources of uncertainty (Dolman, Abu-Ebid, & Stambaugh, 2012; Li, 2013; Spiers et al., 2010), and that the bands of uncertainty overlap. It is not obvious that SWI is more expensive than other means of supplying heat in the future. It is, however, likely that the supply chain for SWI is very largely independent of investments in energy supply. Viewed strategically, there may still be a strong case for incentivising deployment of SWI.

Finally, this paper, taken together with an earlier similar result on the performance of cavity walls (Lowe et al., 2007), highlights the importance of mounting a national programme of measuring key basic parameters underpinning UK domestic energy performance modelling to remove sources of uncertainty. UK policy-making for the built environment has spent decades operating on the basis that the  $U$ -value of a brick wall was something that was simple and well understood, when in fact this appears not to be the case. This work highlights the importance of evidence-based policy-making and reinforces the case for core assumptions in modelling tools and calculation regimes to be challenged and subjected to rigorous scrutiny. This paper clearly demonstrates that there is a very wide diversity of measured  $U$ -values in solid walls. Similar

diversities in other critically important physical characteristics of building properties are likely to occur and not be adequately captured in our normative models. Historically, poor agreement between actual results and modelled results has been attributed to occupant behaviour, for example the diversity of internal temperatures maintained in dwellings. The tale of solid-wall  $U$ -values suggests this is not the case and that the diversity in physical building characteristics may be as significant as the diversity in occupant behaviour as a source of explanations for such anomalies.

## Acknowledgements

The authors are grateful for the support that Department of Energy and Climate Change (DECC), Energy Saving Trust (EST) and the Building Services Research and Information Association (BISRIA) have provided in terms of access to the raw data for the field trials and help in its interpretation. We would also like to thank the five anonymous *Building Research & Information* reviewers whose comments and feedback on earlier drafts contributed significantly to strengthening the final publication.

## Funding

This work was supported by DECC under the 'Analysis of Solid Wall Field Trial Data' project; the Engineering and Physical Sciences Research Council (EPSRC), EDF Energy and EDF ECLEER 'People Energy and Buildings: Distribution, Diversity and Dynamics' under Grant EP/H051112/1; EPSRC 'New Empirically-Based Models of Energy Use in the Building Stock' under EP/I038810/1; EPSRC 'Research Councils UK (RCUK) Centre for Energy Epidemiology' under EP/K011839/1; and EPSRC 'The UK Doctoral Training Centre in Energy Demand Reduction and the Built Environment' under EP/H009612/1.

## References

- Anderson, B. R., Chapman, P. F., Cutland, N. G., Dickson, C. M., Doran, S. M., Henderson, G., ... Shorrock, L. D. (2007). *BREDEM-8 - Model description*. Watford: Garston.
- Baker, P. (2011). *U-values and traditional buildings, in situ measurements and their comparisons to calculated values*. Edinburgh: Historic Scotland.
- Baker, P. H., & van Dijk, H. A. L. (2008). PASLINK and dynamic outdoor testing of building components. *Building and Environment*, 43(2), 143–151. doi:10.1016/j.buildenv.2006.10.009
- Bankvall, C. (1977). Forced convection: Practical thermal conductivity in an insulated structure under the influence from workmanship and wind. In *ATSM symposium on Advances in Heat Transmission Measurement on Thermal Insulation Material Systems*. Philadelphia, Pennsylvania, USA: ATSM International.

- Biddulph, P., Gori, V., Elwell, C. A., Scott, C., Rye, C., Lowe, R., & Oreszczyn, T. (2014). Inferring the thermal resistance and effective thermal mass of a wall using frequent temperature and heat flux measurements. *Energy and Buildings*, 78, 10–16. doi:10.1016/j.enbuild.2014.04.004
- Birchall, S., Pearson, C., & Brown, R. (2011). *Solid wall insulation field trial – Baseline performance of the property sample*. Bracknell: BSRIA.
- BRE. (2012). *The government's Standard Assessment Procedure (SAP) for energy rating of dwellings*. Garston, Watford: Department of Energy and Climate Change.
- BSI Group. (1999). *BS EN 13187:1999 – Thermal performance of buildings. Qualitative detection of thermal irregularities in building envelopes. Infrared method*. London: BSI Group.
- CIBSE. (2006). Thermal properties of building structures. In K. J. Butcher (Ed.), *Guide A: Environmental design* (pp. 5–48) (7th ed.). Norwich: CIBSE.
- CLG. (2012a). *English housing survey 2010/11*. London: Department for Communities and Local Government.
- CLG. (2012b). *English housing survey, 2010: Housing stock data*. London: HMSO.
- DCLG. (2012). *English Housing Survey. Household Report 2010–2011*. London: DCLG.
- DECC. (2009). *The UK low carbon transition plan: National strategy for climate and energy*. London: Department for Environment and Climate Change, The Stationery Office.
- DEFRA. (2008). *Energy analysis focus report a study of hard to treat homes using the English house condition survey*. London: Department of Environment and Rural Affairs.
- Desogus, G., Mura, S., & Ricci, R. (2011). Comparing different approaches to *in situ* measurement of building components thermal resistance. *Energy and Buildings*, 43(10), 2613–2620. doi:10.1016/j.enbuild.2011.05.025
- Dolman, M., Abu-Ebid, M., & Stambaugh, J. (2012). *Decarbonising heat in buildings: 2030–2050, a summary report for the committee on climate change*. Cambridge: Committee on Climate Change.
- Dowson, M., Poole, A., Harrison, D., & Susman, G. (2012). Domestic UK retrofit challenge: Barriers, incentives and current performance leading into the Green Deal. *Energy Policy*, 50, 294–305. doi:10.1016/j.enpol.2012.07.019
- Elttek. (2013). Squirrel 450/850 Series Data Logger. Retrieved from [http://www.eltekdataloggers.co.uk/450\\_logger.shtml](http://www.eltekdataloggers.co.uk/450_logger.shtml)
- European Commission. (2008). *Directive of the European parliament and of the council on the energy performance of buildings (Recast)*. Brussels: European Commission.
- Gorse, C. A., Glew, D., Miles-Shenton, D., Farmer, D., & Fletcher, M. (2013). *Building Performance: Fabric, Impact and Implications*. In Sustainable Building 2013 Hong Kong Regional Conference: Urban Density & Sustainability, Hong Kong SAR. Leeds: Leeds Metropolitan University.
- Hoskins, W. G. (1953). The rebuilding of rural England, 1570–1640. *Past and Present*, 4(1), 44–59. doi:10.1093/past/4.1.44
- Hughes, M., Palmer, J., & Pope, P. (2013). *A guide to the Cambridge housing model*. London: Department of Energy and Climate Change.
- Hukseflux. (2013). HFP01 Product Brochure.
- ISO. (1983). *ISO 6781:1983 – Thermal insulation – Qualitative detection of thermal irregularities in building envelopes – Infrared method*. Geneva: International Organization for Standardization (ISO).
- ISO. (2007a). *ISO 10456:2007 – Building materials and products – Hygrothermal properties – Tabulated design values and procedures for determining declared and design thermal values*. Geneva: International Organization for Standardization (ISO).
- ISO. (2007b). *ISO 6946:2007 – Building components and building elements – Thermal resistance and thermal transmittance – Calculation method*. Geneva: International Organization for Standardization (ISO).
- ISO. (2008). *ISO 13790:2008 – Energy performance of buildings – Calculation of energy use for space heating and cooling*. Geneva: International Organization for Standardization (ISO).
- ISO. (2014). *ISO 9869–1:2014 Thermal insulation – Building elements – In-situ measurement of thermal resistance and thermal transmittance – Part 1: Heat flow meter method* (No. ISO 9869:1994). Geneva: International Organization for Standardization (ISO).
- Johnston, D., Miles-Shenton, D., Farmer, D., & Wingfield, J. (2013). *Whole house heat loss test method (Cobeating)*. Leeds: Leeds Metropolitan University.
- Kelly, S., Shipworth, M., Shipworth, D., Gentry, M., Wright, A., Pollitt, M., ... Lomas, K. (2013). Predicting the diversity of internal temperatures from the English residential sector using panel methods. *Applied Energy*, 102, 601–621. doi:10.1016/j.apenergy.2012.08.015
- Laurent, M. H., Allibe, B., Tigchelaar, T., Oreszczyn, T., Hamilton, I. G., & Galvin, R. (2013). Back to reality: How domestic energy efficiency policies in four European countries can be improved by using empirical data instead of normative calculations. In *ECEEE Summer Study: Rethink, Renew, Restart* (Vol. In Press).
- Li, F. G. N. (2013, July 28). Spatially explicit techno-economic optimisation modelling of UK heating futures. UCL (University College London).
- Lloyd, N. (1925). *A history of English brickwork: With examples and notes of the architectural use and manipulation of brick from mediaeval times to the end of the Georgian period* (p. 449). London: H. G. Montgomery.
- Lowe, R. J. (2007). Technical options and strategies for decarbonizing UK housing. *Building Research & Information*, 35(4), 412–425.
- Lowe, R. J., Wingfield, J., Bell, M., & Bell, J. M. (2007). Evidence for heat losses via party wall cavities in masonry construction. *Building Service Engineering Research and Technology*, 28(2), 161–181. doi:10.1177/0143624407077196
- Palmer, J., & Cooper, I. (2013). *United Kingdom housing energy fact file 2012* (p. 145). London: Department of Energy and Climate Change.
- Rye, C., & Scott, C. (2012). *The SPAB research report 1: The U-value report*. London: SPAB.
- Rye, C., Scott, C., & Hubbard, D. (2012). *The SPAB building performance survey 2012 interim report*. London: SPAB.
- Spiers, J., Gross, R., Deshmukh, S., Heptonstall, P., Munuera, L., Leach, M., & Torriti, J. (2010). *Building a roadmap for heat: 2050 scenarios and heat delivery in the UK*. London: CHPA.
- Stamp, S., Lowe, R., & Altamirano-Medina, H. (2013a). *An investigation into the role of thermal mass on the accuracy of co-heating tests through simulations & field results*. In Proceedings of BS2013: 13th Conference of International Building Performance Simulation Association, Chambéry, France, August 26–28. Chambéry, France.
- Stamp, S., Lowe, R. J., & Altamirano-Medina, H. (2013b). Using simulated co-heating tests to understand weather driven sources of uncertainty within the co-heating test method. In *ECEEE Summer Study: Rethink, Renew, Restart*. ECEEE.
- Stevens, G., & Russill, J. (2013). Do U-value insulation?. England's field trial of solid wall insulation. In *ECEEE Summer Study: Rethink, Renew, Restart*. ECEEE.
- Stone, A., Shipworth, D., Biddulph, P., & Oreszczyn, T. (2014). Key factors determining the energy rating of existing English houses. *Building Research & Information, In Print*, 1–14. doi:10.1080/09613218.2014.905383
- Sunikka-Blank, M., & Galvin, R. (2012). Introducing the pre-bound effect: The gap between performance and actual energy consumption. *Building Research & Information*, 40(3), 260–273. doi:10.1080/09613218.2012.690952
- UK CCC. (2010). *Fourth carbon budget* (p. 375). London: UK Committee on Climate Change.
- UK CCC. (2012). *Meeting carbon budgets – 2012 Progress report to parliament*. London: UK Committee on Climate Change.

Usher, P., & Strachan, N. (2011, January 1). UK MARKAL Modelling – Examining Decarbonisation Pathways in the 2020s on the Way to Meeting the 2050 Emissions Target. UCL Energy Institute, University College London.

Whorf, B. L. (2012). *Language, thought, and reality, second edition selected writings of Benjamin Lee Whorf*. Edited by J. B. Carroll, S. C. Levinson, & P. Lee (Eds.), (p. 424). Cambridge, MA: MIT Press.

## Endnotes

<sup>1</sup>The thickness of 220 mm was used as a conservative estimate to capture variation in brick production.

<sup>2</sup>The authors have not identified the original source of this figure, but it is likely to go back at least 50 years, and the original source is likely to have been CIBSE's precursor, the Institute of Heating and Ventilating Engineers (IHVE).

## Appendix A

**Table A1** Nomenclature

Symbol	Description	Units
$U$	Thermal transmittance of the element ( $U$ -value)	$\text{W m}^{-2} \text{K}^{-1}$
$R$	Thermal resistance of the element ( $R$ -value)	$\text{m}^2 \text{KW}^{-1}$
$R_1, R_2$	Thermal resistances predicted by the single lumped thermal mass method	$\text{m}^2 \text{KW}^{-1}$
$T_{\text{mass}}, T_{\text{in}}, T_{\text{ext}}$	Temperature of the thermal mass of the element; temperature of the internal and external surface of the element respectively	$^{\circ}\text{C}$
$Q_{\text{in}}$	Heat flux entering the internal surface of the element	$\text{W m}^{-2}$
$C$	Thermal mass of the wall	$\text{J m}^{-2} \text{K}^{-1}$
$t$	Time step duration ( <i>i.e.</i> time between two successive data readings)	S
$P$	Current time step ( <i>i.e.</i> current recording index)	–
$p + 1$	Next time step ( <i>i.e.</i> recording index after one time step duration)	–