



Zhou, J., Morris, K. A., & Lancaster, M. J. (2007). General design of multiway multisection power dividers by interconnecting two-way dividers. *IEEE Transactions on Microwave Theory and Techniques*, 55(10), 2208 - 2215. 10.1109/TMTT.2007.906541

Link to published version (if available):  
[10.1109/TMTT.2007.906541](https://doi.org/10.1109/TMTT.2007.906541)

[Link to publication record in Explore Bristol Research](#)  
PDF-document

## University of Bristol - Explore Bristol Research

### General rights

This document is made available in accordance with publisher policies. Please cite only the published version using the reference above. Full terms of use are available:  
<http://www.bristol.ac.uk/pure/about/ebr-terms.html>

### Take down policy

Explore Bristol Research is a digital archive and the intention is that deposited content should not be removed. However, if you believe that this version of the work breaches copyright law please contact [open-access@bristol.ac.uk](mailto:open-access@bristol.ac.uk) and include the following information in your message:

- Your contact details
- Bibliographic details for the item, including a URL
- An outline of the nature of the complaint

On receipt of your message the Open Access Team will immediately investigate your claim, make an initial judgement of the validity of the claim and, where appropriate, withdraw the item in question from public view.

# General Design of Multiway Multisection Power Dividers by Interconnecting Two-Way Dividers

Jiafeng Zhou, Kevin A. Morris, and Michael J. Lancaster, *Senior Member, IEEE*

**Abstract**—It is common practice to design multiway power dividers by interconnecting two-way power dividers. Transmission lines are used to link the two-way dividers. This paper investigates the performance of the interconnected power divider and the effects of the interconnecting transmission lines. In particular, it will be shown that the performance of multiway dividers constructed by interconnecting even-number-section two-way dividers deteriorates significantly as the number of output ports increases. The interconnecting lines can be used to improve the performance of such dividers.

**Index Terms**—Broadband, power combiner, power divider, power splitter, quarter-wavelength, transmission lines, Wilkinson.

## I. INTRODUCTION

**P**OWER dividers or combiners/splitters are passive microwave components used for distributing or combining microwave signals. Multiway power dividers are needed in many microwave applications such as phased antenna arrays and power amplifiers. There are many ways to design power dividers. Wilkinson-type dividers [1] are widely used. However, an  $N$ -way Wilkinson power divider is planar only when  $N = 2$ , and is not planar for  $N \geq 3$ . Planar multiway dividers can usually be realized by interconnecting multiple two-way Wilkinson dividers.

In an interconnected multiway divider, usually it is physically difficult to link the two-way dividers directly with each other. Unwanted cross-coupling may also exist if the two-way dividers are too close to each other. To keep them apart, extra transmission lines are usually needed to link the two-way dividers. Although many have reported the design [2], [3] and improvement [4]–[6] of Wilkinson dividers, it is interesting to note that few have investigated the interconnection of multiway dividers in detail. It seems that the lengths of the interconnecting transmission lines are randomly chosen [7], [8]. This paper will investigate the performance of interconnected multiway dividers and the effects the interconnecting lines have on the performance of the multiway dividers.

Manuscript received April 19, 2007; revised July 16, 2007. This work was supported by the European Commission.

J. Zhou and K. A. Morris are with the Department of Electronic and Electrical Engineering, University of Bristol, Bristol BS8 1UB, U.K. (e-mail: j.zhou@bristol.ac.uk).

M. J. Lancaster is with the Department of Electronic, Electrical and Computer Engineering, The University of Birmingham, Edgbaston, Birmingham B15 2TT, U.K.

Color versions of one or more of the figures in this paper are available online at <http://ieeexplore.ieee.org>.

Digital Object Identifier 10.1109/TMTT.2007.906541

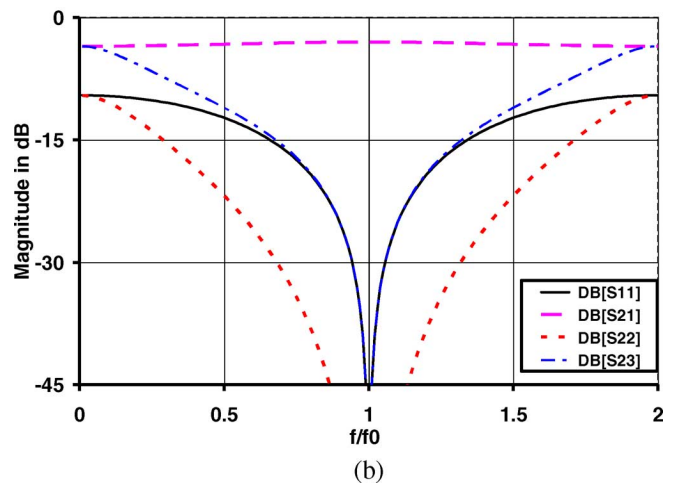
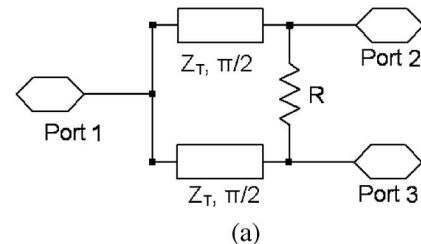

Fig. 1. (a) Schematic layout of the traditional two-way Wilkinson divider and (b) its typical performance.

## II. FOUR-WAY SINGLE-SECTION DIVIDER

The simplest scenario of an interconnected multiway divider is a four-way construction produced by linking three two-way dividers.

### A. Two-Way Wilkinson Divider

The traditional two-way Wilkinson divider is shown in Fig. 1(a). It is composed of a pair of quarter-wavelength transmission lines with a characteristic impedance of  $Z_T = \sqrt{2}Z_0$  and an isolation resistor of  $R = 2Z_0$ , where  $Z_0$ , usually  $50 \Omega$ , is the matched impedance of the divider. The typical performance of the two-way Wilkinson divider is shown in Fig. 1(b). Since all three ports in the divider are perfectly matched at the center frequency  $f_0$ , in the ideal case, the reflection is zero from all ports. Due to the limited-bandwidth approximation of the quarter-wavelength transmission lines, the input impedance seen from each port is generally not  $Z_0$  at other frequencies, and the return loss is, therefore, not infinite. The usable bandwidth of a single-section Wilkinson divider can be taken as  $f_H/f_L = 1.44 : 1$  for VSWR  $< 1.22$  (reflection  $< -20$  dB) and isolation  $< -20$  dB [9].

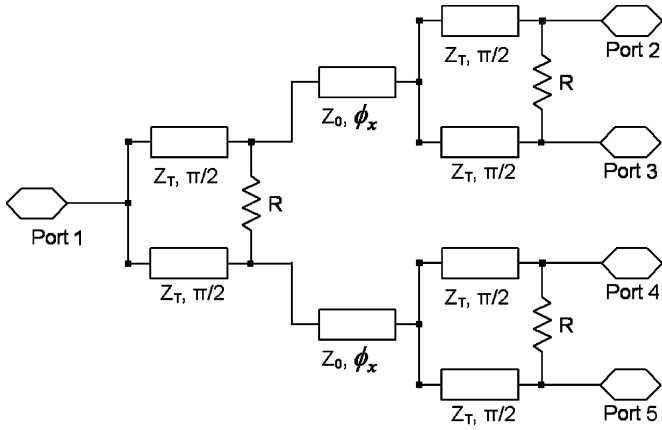

Fig. 2. Schematic layout of a four-way divider made by interconnecting three two-way dividers, linked with transmission lines.

In the Wilkinson divider, the resistor plays a key role in providing the output-port match and isolation. Ideally, the resistor should have no phase difference across it to provide the best isolation; otherwise, the isolation of the output ports will not be infinite at the center frequency.

### B. Design of a Four-Way Divider

A four-way divider can be realized in a two-stage structure by interconnecting three two-way Wilkinson dividers, as shown in Fig. 2. As indicated above, the output ports of a two-way Wilkinson divider should be kept as close as possible to minimize the phase shift across the resistor. Otherwise, extra transmission lines would be needed to connect the resistor to the ports, which introduce unwanted phase shift. It is, therefore, physically difficult to interconnect the two-way dividers directly without affecting each other. In practice, transmission lines with impedance  $Z_0$  are usually used to link the two-way dividers. For simplicity, the two lines used are of equal length.

It should be noted that transmission lines may also be needed to connect the input and output ports to microwave components outside the divider. These transmission lines have little effect on the performance because a load with an impedance of  $Z_0$  transformed by any length of an ideal transmission line with a characteristic impedance of  $Z_0$  is always  $Z_0$  at all frequencies.

### C. Reflection Seen at the Input

Since the resistor has no contribution to the input reflection coefficient, the input impedance of the traditional two-way Wilkinson divider can be obtained by calculating two loads transformed by the quarter-wavelength transmission lines in parallel, which is given by

$$Z_{I1}(\bar{f}) = \frac{Z_T Z_0 + jZ_T \tan(\beta l)}{2 jZ_0 \tan(\beta l) + Z_T} \quad (1)$$

where  $l$  is the length of the transmission line and  $\beta$  is the phase constant. At the center frequency  $f_0$ , the electrical length of the transmission line is  $\beta l = \phi_0 = \pi/2$ . At frequency  $f$ , or the normalized frequency  $\bar{f} = f/f_0$  ( $0 \leq \bar{f} < 2$ ), the electrical

length is given by  $\theta = \beta l = \bar{f}(\pi/2)$ . The reflection coefficient of the two-way divider seen at the input can be calculated by

$$S_{11}(\bar{f}) = \frac{Z_{I1}(\bar{f}) - Z_0}{Z_{I1}(\bar{f}) + Z_0} = \frac{-1}{3 + j2\sqrt{2} \tan \theta}. \quad (2)$$

For the four-way divider, if the two two-way dividers in the second stage are connected directly to the output ports of the first stage, the input impedance of the four-way divider can be calculated as a two-way divider loaded with frequency-dependent impedances given by (1).

Assuming that the electrical length of the interconnecting transmission lines is  $\phi_x$  at  $f_0$ , the electrical length at  $\bar{f}$  is given by  $\theta_x = \bar{f}\phi_x$ . The input impedance of the four-way divider seen at the input port can be calculated by

$$Z_{I2}(\bar{f}) = \frac{Z_T Z_x(\bar{f}) + jZ_T \tan \theta}{2 jZ_x(\bar{f}) \tan \theta + Z_T} \quad (3)$$

where

$$Z_x(\bar{f}) = Z_0 \frac{Z_{I1}(\bar{f}) + jZ_0 \tan \theta_x}{jZ_{I1}(\bar{f}) \tan \theta_x + Z_0}. \quad (4)$$

Using (1)–(4), the reflection coefficient of the four-way divider is given by

$$S_{11}(\bar{f}) = \frac{Z_{I2}(\bar{f}) - Z_0}{Z_{I2}(\bar{f}) + Z_0} = \frac{2\sqrt{2} \tan \theta \tan \theta_x - 3}{S_{RE} + jS_{IM}} \quad (5)$$

where

$$S_{RE} = 5 - 6\sqrt{2} \tan \theta_x \tan \theta - 4 \tan^2 \theta$$

$$S_{IM} = 6\sqrt{2} \tan \theta + 4 \tan \theta_x - 4 \tan \theta_x \tan^2 \theta.$$

The reflection coefficient at the input port of the four-way divider has a few interesting characteristics that can be deduced from (5) as follows.

- $S_{11} = 0$  when  $\theta = \pi/2$ , or  $\bar{f} = 1$ , as  $\tan \theta$  is infinite, i.e., the input port of the four-way divider is always matched at the center frequency. Other nulls of  $S_{11}$  are dependent on  $\phi_x$ , and given by  $2\sqrt{2} \tan(\bar{f}\pi/2) \tan(\bar{f}\phi_x) = 3$ .
- $|S_{11}(\bar{f})| \equiv |S_{11}(2 - \bar{f})|$  only when  $\phi_x = n\pi/2$  ( $n = 0, 1, 2, \dots$ ). The reflection from the divider is symmetrical about  $\bar{f} = 1$  only when the interconnecting transmission line is zero length or multiple quarter-wavelength. This property is important because it points out the optimal length of the transmission line to achieve good reflection. More details will be given below.

The calculated input reflection, i.e.,  $S_{11}$  of the four-way divider, is shown in Fig. 3(a) with different lengths of interconnecting lines of  $\phi_x = 0, \pi/4, \pi/2$ , and  $\pi$ . It can be seen that, in the band  $1.18:0.82$  ( $f_H/f_L = 1.44:1$ ), the usable band of the two-way divider, as given in Section II-A), the input reflection is the lowest when  $\phi_x = 0$ , and is the second lowest when  $\phi_x = \pi$ . It will be shown in Section IV that generally the performance of the four-way divider is optimal when  $\phi_x = n\pi$  ( $n = 0, 1, 2, \dots$ ). In Fig. 3(a), the reflection is symmetrical only when  $\phi_x = 0, \pi/2$ , or  $\pi$ , and is not symmetrical when

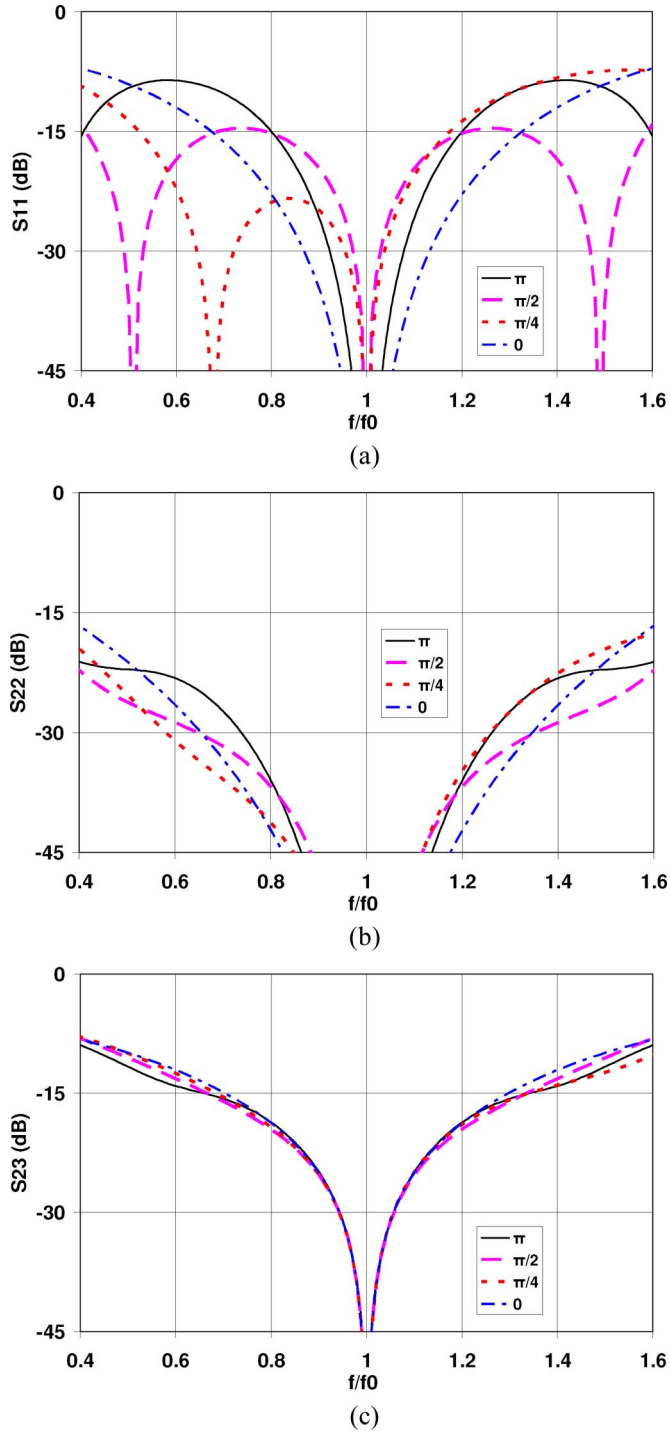

Fig. 3. Calculated: (a) input reflection  $S_{11}$ , (b) output reflection  $S_{22}$ , and (c) isolation  $S_{23}$  of the four-way divider with different lengths of interconnecting transmission lines.

$\phi_x = \pi/4$ , as indicated above. Indeed, the length of the interconnecting transmission line has significant effects on the performance of the divider.

#### D. Reflection and Isolation of the Output Ports

The reflection and isolation at the two output ports of the two-way divider can be calculated by network analysis. To calculate the reflection and isolation, the input port can be regarded

as a resistor to ground with an impedance of  $Z_0$ . Thus, the three-port network is simplified to a two-port network. The network between the output ports can be represented by two sub-networks connected in parallel. One of the sub-networks is the isolation resistor; the other consists of two quarter-wavelength transmission lines with a  $Z_0\Omega$  resistor to ground in between. The reflection coefficient at the output ports can be expressed as

$$S_{22}(\bar{f}) = S_{33}(\bar{f}) = \frac{1}{8 \tan^2 \theta - j8\sqrt{2} \tan \theta - 3}. \quad (6)$$

The isolation is given by

$$S_{23}(\bar{f}) = \frac{-2 - j2\sqrt{2} \tan \theta}{8 \tan^2 \theta - j8\sqrt{2} \tan \theta - 3}. \quad (7)$$

The reflection and isolation of the four-way divider can be calculated in a similar way described above. They can be computed, and the expression will be much more complicated than (6) and (7). However, by comparing (6) and (2), it can be seen that the reflection from the output port of a two-way divider is very small in the usable band. The relationship of the magnitudes of the input and output reflection coefficient is given by

$$|S_{11}(\bar{f})/S_{22}(\bar{f})| = \sqrt{8 \tan^2 \theta + 1}. \quad (8)$$

From (8), it can be seen that the magnitude of the output reflection is always better than the input reflection in the whole band. For the 1.18:0.82 band of interest, the output reflection is at most  $-39.8$  dB. At any frequency in this band, the reflection seen at the output is at least 19.8 dB better than that at the input port. Therefore, the impedance seen at the output is well matched to  $Z_0$  in the band of interest.

The input of the second stage elementary two-way divider is loaded with the output impedance of the first stage one transformed by the interconnecting transmission line. Since the output impedance of the two-way divider is very close to  $Z_0$ , as deduced above, the isolation between adjacent output ports of the four-way divider is, therefore, very similar to a two-way one, and is not significantly affected by the interconnecting transmission lines. Due to the way the dividers are connected, the isolation between nonadjacent output ports is better than that of adjacent ports.

The calculated reflection  $S_{22}$  is shown in Fig. 3(b), when  $\phi_x = 0, \pi/4, \pi/2$ , and  $\pi$ . It can be seen that the output reflection is well below  $-20$  dB in the band of interest. Due to symmetry, the reflection at other output ports is the same as port 2. The isolation  $S_{23}$  is shown in Fig. 3(c), when  $\phi_x = 0, \pi/4, \pi/2$ , and  $\pi$ . It can be seen that the isolation is affected negligibly, as indicated above.

#### E. Transmission

In these equal power dividers, a signal enters the input port, and is split into equal-amplitude equal-phase output signals at the output ports. Since each end of each isolation resistor is at the same potential, no current flows through it and, therefore, the resistors are decoupled from the input. Thus, the transmission coefficient maintains high values with little loss as long as the

input and output are well matched. If the reflection is better than  $-20$  dB from the input and output ports, the transmission will be better than  $-0.09$  dB if the network is lossless, except for the resistors.

Due to symmetry, the transmission coefficients to all output ports are equal magnitude and equal phase.

### III. MULTIWAY SINGLE-SECTION DIVIDERS

The input impedance of a multiway divider can be calculated in a similar way to the four-way one described above. More generally, the input impedance of an  $N$ -stage  $2^N$ -way divider constructed by interconnecting  $2^N - 1$  two-way dividers can be calculated by the recursive function

$$Z_{I_i}(\bar{f}) = \frac{Z_T Z_x(\bar{f}) + jZ_T \tan \theta}{2 jZ_x(\bar{f}) \tan \theta + Z_T} \quad (9)$$

where

$$Z_x(\bar{f}) = \begin{cases} Z_0 \frac{Z_{I_{i-1}}(\bar{f}) + jZ_0 \tan \theta_{i-1}}{jZ_{I_{i-1}}(\bar{f}) \tan \theta_{i-1} + Z_0}, & \text{if } i > 1 \\ Z_0, & \text{if } i = 1 \end{cases} \quad (9a)$$

where  $\bar{f}$ ,  $Z_T$ , and  $\theta$  are defined above, and  $\theta_{i-1} = \bar{f} \cdot \phi_{i-1} \cdot \phi_{i-1}$  is the electronic length of transmission lines interconnecting the  $i$ th and  $(i - 1)$ th stage of the divider.

For  $N > 2$ , the expression to calculate the input reflection coefficient will be much more complicated than that given in (5). It is probably more straightforward to simulate the response by circuit simulation using commercial software (e.g., Agilent Technologies' ADS [10] or Applied Wave Research's Microwave Office [11]). However, the theory above still applies that the lengths of the interconnecting transmission lines mainly affect the input reflection coefficient, and the response is symmetrical about the center frequency only when  $\phi_i = n\pi/2$ . The transmission  $S_{21}$ , output reflection  $S_{22}$ , and isolation  $S_{23}$  are much less sensitive to the length of the interconnecting transmission lines.

## IV. MULTISECTION POWER DIVIDERS

### A. Multisection Two-Way Divider

As discussed above, a single-section divider usually has usable bandwidth of approximately 1.44 : 1. To achieve wider bandwidth, the design of broadband multisection two-way power dividers was introduced in [9] and was widely used in many applications [12], [13]. The design of broadband dividers with Butterworth and Chebyshev responses are detailed in [9] and [14]. The Butterworth type has a maximally flat performance in the specified band. The Chebyshev type has a wider usable band with equal-magnitude ripples in the band, and is favored when wide bandwidth is the main interest.

For an  $M$ -section Chebyshev two-way divider, the input reflection coefficient has  $M$  nulls in the specified band. In particular, when  $M$  is an even number, the reflection coefficient at the center frequency is not null. The magnitude of the reflection coefficient is the value of the ripple, and can be determined in the design procedure.

It will be shown below that the performance of an  $N$ -stage ( $2^N$ -way)  $M$ -section divider deteriorates dramatically while  $N$

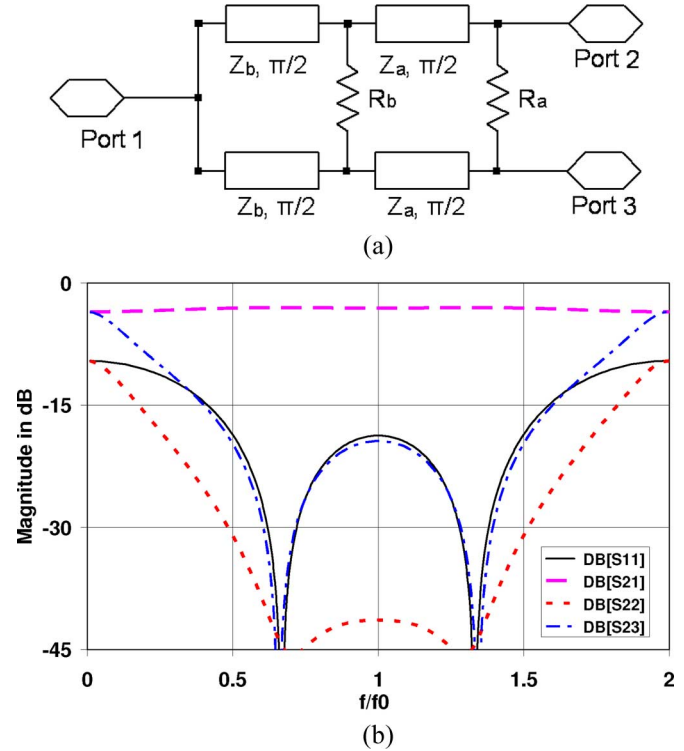

Fig. 4. (a) Layout and (b) simulated response of the two-way two-section divider with  $f_H/f_L = 3 : 1$ .

increases, especially when  $M$  is an even number. By choosing the interconnecting transmission lines to be quarter-wavelength, the performance of the even-number-section divider can be significantly improved.

### B. Two-Section Two-Way Divider

The schematic layout of a two-way two-section divider is shown in Fig. 4(a). The two-section divider has two pairs of quarter-wavelength transmission lines with characteristic impedance of  $Z_a$  and  $Z_b$ . Two resistors, i.e.,  $R_a$  and  $R_b$ , are associated with the transmission lines. The method to calculate the values of  $Z_a$ ,  $Z_b$ ,  $R_a$ , and  $R_b$  is detailed in [9] and [14]. To design a two-section divider with  $f_H/f_L = 3 : 1$ , these values are found to be  $Z_a = 63.1 \Omega$ ,  $Z_b = 79.3 \Omega$ ,  $R_a = 197 \Omega$ , and  $R_b = 113 \Omega$ , assuming  $Z_0 = 50 \Omega$ .

The response of the two-section two-way divider can be calculated in a similar way described in Section II. The calculated response of the divider is shown in Fig. 4(b). The input reflection  $S_{11}$  is  $-18.7$  dB at the center frequency.

### C. Design of Multiway Multisection Dividers

Multiway dividers can be designed by interconnecting the two-way dividers. The response of such a divider can be calculated in a similar way as discussed in Section IV-B. While the output port reflection and isolation are not affected significantly, the input reflection coefficient is quite different, and can be calculated using a recursive equation similar to (9). Although the expression will be much more complicated, it can be easily evaluated by computer. It still applies that the performance of the divider is symmetrical about the center frequency only when the interconnecting transmission lines are zero length or multiple

quarter-wavelength. Some other useful characteristics are analyzed below.

As explained in Section IV-A, the two-section divider is not perfectly matched at its center frequency. It can be calculated that, at the center frequency  $\bar{f} = 1$ , the impedance seen at the input port is given by

$$Z_{I1}(f_0) = (Z_b/Z_a)^2 \cdot Z_0/2. \quad (10)$$

For an  $N$ -stage ( $2^N$ -way) two-section divider constructed by interconnecting  $2^N - 1$  dividers directly, the input impedance at the center frequency is given by

$$Z_{IN}(f_0) = (Z_b/Z_a)^{2N} \cdot Z_0/2^N. \quad (11)$$

It is evident from (11) that the mismatch at the center frequency deteriorates exponentially with the number of stages of the divider. The calculated input reflection of the 64-way two-section divider with  $f_H/f_L = 3 : 1$  without interconnecting transmission lines is shown in Fig. 5(a). For the 64-way divider, the input reflection is as low as  $-4.4$  dB at the center frequency, which is not good enough for most applications. Calculation indicates that the input reflections are  $-9.5$  and  $-5.6$  dB at the center frequency for the eight- and 32-way dividers, respectively.

It was proposed above that it is usually physically necessary to use transmission lines to interconnect the two-way dividers. It was also proven by calculation that the performance of the dividers can be significantly affected by the transmission line interconnections. It will be shown below that the interconnecting transmission lines are useful to tune the performance of the multisection dividers.

If a pair of quarter-wavelength transmission lines is added between adjacent stages of the two-section divider, the input impedance at the center frequency seen at the first stage is identical to the output impedance seen at the output port of the second stage. Taking a four-way two-section divider for an example, the input impedance seen at the input port of the second stage two-way divider is given by (10). If quarter-wavelength transmission lines with a characteristic impedance of  $Z_0$  are added after the first stage, the input impedance seen at the input port of the first stage can be calculated in a similar way to (10), and is given by

$$Z(f_0) = \frac{(Z_b/Z_a)^2}{2} \frac{Z_0^2}{(Z_b/Z_a)^2 \cdot Z_0/2} = Z_0. \quad (12)$$

The input port is perfectly matched at the center frequency! Hence, the reflection is optimal around the center frequency. More generally, the electrical length of the transmission lines added can be  $\phi_i = (2n + 1)\pi/2$ . Obviously it can be easily extrapolated that any two adjacent stages in an  $N$ -stage divider can be "paired" to provide best matching. Therefore, the following conditions result.

1) The input impedance, seen at the input port of even-number-stage even-number-section dividers, can be perfectly matched in the vicinity of the center frequency by adding quarter-wavelength (or  $\phi_i = (2n + 1)\pi/2$ ) transmission lines between adjacent stages.

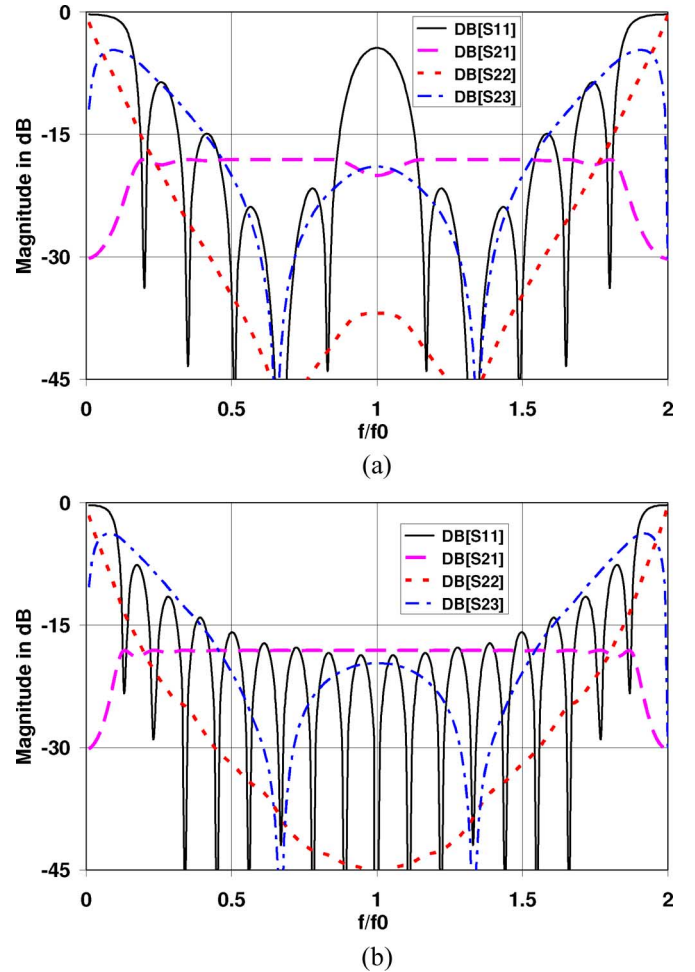

Fig. 5. Calculated response of the 64-way two-section divider when all two-way dividers are interconnected: (a) directly and (b) by quarter-wavelength transmission lines.

- 2) The input impedance, seen at the input port of odd-number-stage even-number-section dividers, can be matched to be similar to that of a single even-number-section two-way divider in the vicinity of the center frequency by adding quarter-wavelength (or  $\phi_i = (2n + 1)\pi/2$ ) transmission lines between adjacent stages.
- 3) Although the input port is always perfectly matched for odd-number-section dividers, including the single-section dividers detailed in Sections II and III, the input impedance is optimal by adding half-wavelength ( $\phi_i = 0$  or  $n\pi$ ) transmission lines between adjacent stages. For even-number-stage odd-number-section dividers, the input impedance is well matched in the vicinity of the center frequency. For odd-number-stage odd-number-section dividers, the input impedance is similar to a single-stage divider around the center frequency.

It should be pointed out that the above are sufficient conditions to achieve optimal responses. They are not necessary conditions to achieve the best match at the center frequency. For example, the input of a 16-way divider is perfectly matched at the center frequency if all stages are interconnected with quarter-wavelength transmission lines. It is also perfectly matched at

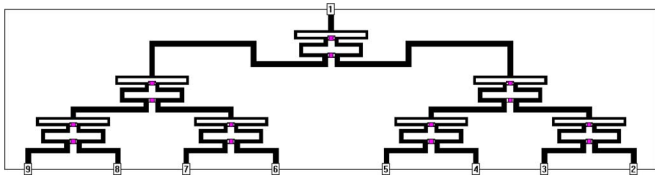

Fig. 6. Layout of the eight-way two-section divider, where the two-way dividers are connected by transmission lines with electrical lengths of  $3\pi/2$  and  $\pi/2$  (not to scale).

the center frequency if quarter-wavelength transmission lines are added only between the second and third stages.

The response of even-number-section dividers is generally most optimal when all adjacent stages are interconnected by quarter-wavelength ( $\phi_i = \pi/2$ ) transmission lines. The response of odd-number-section dividers is generally most optimal when all adjacent stages are interconnected directly ( $\phi_i = 0$ ), or by using half-wavelength ( $\phi_i = \pi$ ) transmission lines if direct interconnection is physically difficult. This has been confirmed by the calculated responses of the four-way divider discussed in Section II, where  $\phi_x = 0$  and  $\phi_x = \pi$  have better performance than the other cases do. Due to the nature of the quarter-wavelength transformers, the optimal bandwidth of the divider will be reduced if longer interconnecting transmission lines, rather than quarter-wavelength or half-wavelength ones, are used.

The calculated response of a 64-way divider interconnected by quarter-wavelength transmission lines at all stages is shown in Fig. 5(b). Compared to Fig. 5(a), it can be seen that the reflection at the input port is significantly improved by adding the interconnecting transmission lines. On the other hand, the output reflection is much better than the input reflection, and generally around 20 dB lower in both Fig. 5(a) and (b). The isolation is very similar in both cases. In fact, this isolation is also similar to that of the single-stage two-section divider shown in Fig. 4(b). This again confirms the theory derived in Section II-D, i.e., the reflection and isolation are not significantly affected in the interconnected multiway dividers. The overall performance of the 64-way divider meets the specified 3 : 1 bandwidth of the single-stage two-section divider very well. The input reflection is better than  $-17.2$  dB, the isolation is better than  $-19.7$  dB, and the output reflection is better than  $-32.0$  dB in the band of interest.

#### D. Experimental Results

To validate the theory above, an eight-way two-section divider was designed and tested. The layout of the circuit is shown in Fig. 6. As indicated above, for this two-section divider, the interconnecting transmission lines should be quarter-wavelength or  $\phi_i = (2n+1)\pi/2$  to achieve optimal performance. In the design, transmission lines with electrical lengths of  $3\pi/2$  and  $\pi/2$  were chosen to interconnect the two-way dividers at different stages, respectively.

The divider was designed at *C*-band with a center frequency of 5.75 GHz. The circuit was designed in a microstrip structure to be constructed on Duroid RO4003 laminate. The laminate has a dielectric constant of 3.38, a loss tangent of 0.0027,

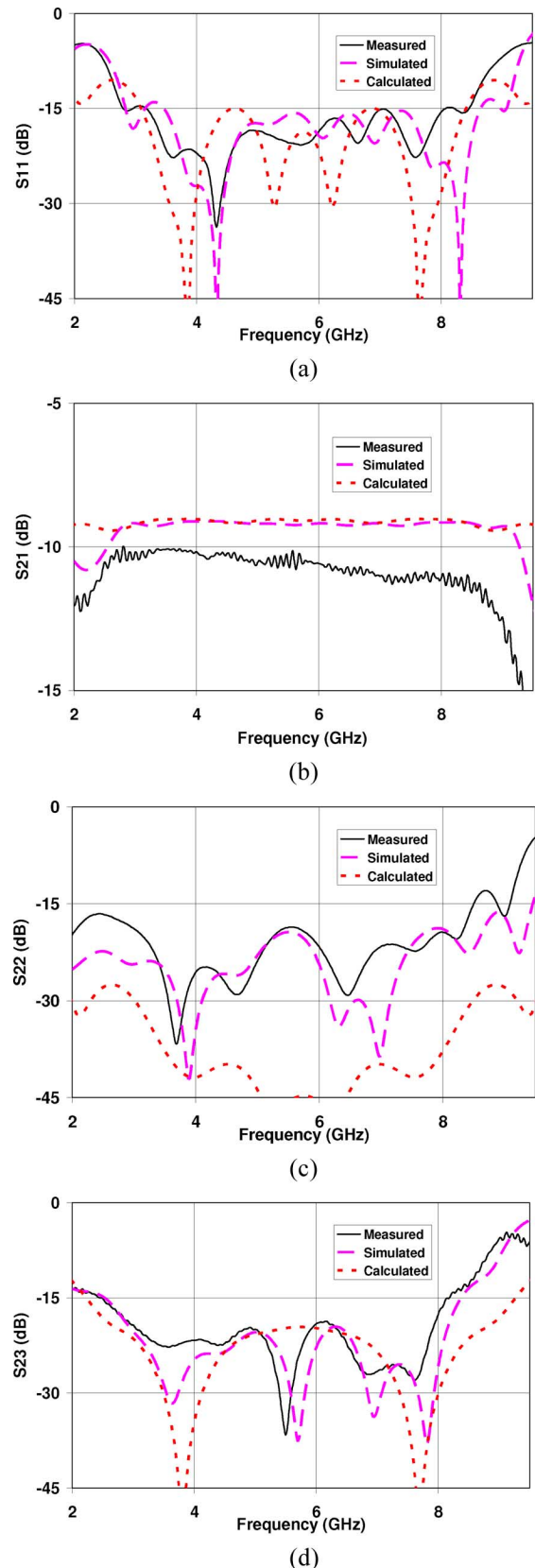

Fig. 7. (a) Input reflection, (b) transmission, (c) output reflection, and (d) isolation of the eight-way two-section divider with  $3\pi/2$ - and  $\pi/2$ -long interconnecting transmission lines between different stages.

and a thickness of 0.305 mm. Two pairs of bended transmission lines are used to construct the elementary two-way two-section

divider, as shown in Fig. 6. Different linewidths are used to realize the required characteristic impedances. The isolation resistors used in practice are  $200\ \Omega$  and  $110\ \Omega$ , respectively.

To compensate for the nonideal T-junction and bend effects of the transmission lines, the lengths of the interconnecting lines and the dimensions of the two-way divider were further optimized by EM software [15] to achieve optimal performance.

The calculated, simulated, and measured performance of the divider is shown in Fig. 7. It can be seen that the calculated isolation is  $-18.7\ \text{dB}$  at the center frequency, the same as the two-way two-section one. The reflection at the center frequency would be  $-9.5\ \text{dB}$  if the two-way dividers were connected directly. The measured performance is in good agreement with the calculated and simulated performance. The input reflection is better than  $-15.5\ \text{dB}$ , the output reflection is better than  $-19\ \text{dB}$ , and the isolation is better than  $-19\ \text{dB}$  as well in the band of interest. The minimum measured insertion loss is  $-10\ \text{dB}$ , including the loss of the input and output connectors, only  $1\ \text{dB}$  on top of the  $-9\ \text{dB}$  intrinsic loss of an eight-way divider.

## V. CONCLUSIONS AND FUTURE WORK

The general design of multiway multisection dividers by interconnecting two-way dividers is described in this paper. Transmission lines are needed to interconnect the dividers. These transmission lines not only provide the physical link among the two-way dividers, but can also be used to tune the performance of the dividers. It is proven by calculation that the response of the dividers is symmetrical about the center frequency only when the electric lengths of the interconnecting transmission lines are multiple quarter-wavelength. The multiway divider can achieve a similar usable bandwidth to that of its two-way dividers by properly choosing the lengths of the interconnecting transmission lines. It is also indicated in the paper that the interconnection has much less effect on the reflection and the isolation between the output ports.

In particular, the input reflection of a multiway even-number-section divider is optimal when the interconnecting transmission lines are quarter-wavelength or an odd-number of quarter-wavelengths. Without these interconnecting lines, the input reflection deteriorates rapidly. The input reflection of a multiway odd-number-section divider is optimal when the interconnecting transmission lines are zero-length or multiple-half-wavelength.

It is expected that this paper can provide general guidance on the design of multiway multisection dividers. It is anticipated that the analysis method can also be applied to analyze unequal power dividers and other interconnected microwave components, such as filters and couplers.

## ACKNOWLEDGMENT

The authors would like to thank Microlab RF Ltd., Hereford, U.K., for fabricating the circuit.

## REFERENCES

- [1] E. J. Wilkinson, "An  $N$ -way hybrid power divider," *IEEE Trans. Microw. Theory Tech.*, vol. MTT-8, no. 1, pp. 116–118, Jan. 1960.
- [2] Q. Guo, Y. Ma, and J. Ju, "A novel broadband high-power combiner," in *Proc. Asia-Pacific Microw. Conf.*, Dec. 2005, vol. 5, no. 4–7.
- [3] R. P. Tetarenko, "Broad-band properties of a class of TEM-mode hybrid," *IEEE Trans. Microw. Theory Tech.*, vol. MTT-19, no. 11, pp. 887–889, Nov. 1971.
- [4] M. Chongcheawchamman, S. Patisang, M. Krairiksh, and I. D. Robertson, "Tri-band Wilkinson power divider using a three-section transmission-line transformer," *IEEE Microw. Wireless Compon. Lett.*, vol. 16, no. 8, pp. 452–454, Aug. 2006.
- [5] B. Piernas and M. Hirata, "Enhanced miniaturized Wilkinson power divider," in *IEEE MTT-S Int. Microw. Symp. Dig.*, Jun. 8–13, 2003, vol. 2, pp. 1255–1258.
- [6] H. R. Ahn and I. Wolff, "General design equations of three-port unequal power-dividers terminated by arbitrary impedances," in *IEEE MTT-S Int. Microw. Symp. Dig.*, Jun. 11–16, 2000, vol. 2, pp. 1137–1140.
- [7] D. Antsos, R. Crist, and L. Sukamto, "A novel Wilkinson power divider with predictable performance at  $K$ - and  $Ka$ -band," in *IEEE MTT-S Int. Microw. Symp. Dig.*, May 23–27, 1994, pp. 907–910.
- [8] K. J. Herrick and L. P. B. Katehi, " $W$ -band micromachined circuit combining networks," *IEEE Trans. Microw. Theory Tech.*, vol. 50, no. 6, pp. 1647–1651, Jun. 2002.
- [9] S. B. Cohn, "A class of broadband three-port TEM-mode hybrids," *IEEE Trans. Microw. Theory Tech.*, vol. MTT-19, no. 2, pp. 110–116, Feb. 1968.
- [10] Advanced Design System (ADS). Agilent Technol., Palo Alto, CA, 2005.
- [11] Microwave Office. Appl. Wave Res. Inc., El Segundo, CA, 2007.
- [12] Y. Yang, C. Zhang, S. Lin, and A. E. Fathy, "Development of an ultra wideband Vivaldi antenna array," in *IEEE AP-S Int. Symp.*, Jul. 3–8, 2005, vol. 1A, pp. 606–609.
- [13] H. Oraizi and A.-R. Sharifi, "Design and optimization of broadband asymmetrical multisection Wilkinson power divider," *IEEE Trans. Microw. Theory Tech.*, vol. 54, no. 5, pp. 2220–2231, May 2006.
- [14] G. L. Matthaei, L. Young, and E. M. T. Jones, *Microwave Filter, Impedance Matching Networks, and Coupling Structure*. New York: McGraw-Hill, 1980.
- [15] Sonnet Software. ver. 9.52, Sonnet Software Inc., North Syracuse, NY, 2003.



**Jiafeng Zhou** was born in Jiangsu, China. He received the B.Sc. degree in radio physics from Nanjing University, Nanjing, China, in 1997, and the Ph.D. degree from The University of Birmingham, Edgbaston, Birmingham, U.K., in 2004. His doctoral research concerned high-temperature superconductor microwave filters.

Beginning in July 1997, for two and a half years he was with the National Meteorological Satellite Centre of China, Beijing, China, where he was mainly involved with communications of the ground station and Chinese geostationary meteorological satellites. From August 2004 to April 2006, he was a Research Fellow with The University of Birmingham, where his research concerned phased arrays for reflector observing systems. He is currently with the Department of Electronic and Electrical Engineering, University of Bristol, Bristol, U.K. His current research interests include microwave power amplifiers and linearization.



**Kevin A. Morris** received the B.Eng. and Ph.D. degrees in electronics and communications engineering from the University of Bristol, Bristol, U.K., in 1995 and 1999, respectively.

In 1998, he was a Research Associate with the Centre for Communications Research (CCR), University of Bristol, during which time he was involved with a number of projects including the EPSRC PACT LINK Program and the IST project SUNBEAM. In 2001, he became a Lecturer in RF engineering at the University of Bristol, and in August 2007, became a Senior Lecturer. He is currently involved with a number of research programs within the U.K., including the Mobile VCE Core 4 Research Program. He has authored or coauthored 14 academic papers. He co-holds three patents. His research interests are in the area of RF hardware design with specific interest in the design of efficient linear broadband power amplifiers for use within future communications systems.





**Michael J. Lancaster** (M'91–SM'04) received the Physics and Ph.D. degrees from Bath University, Bath, U.K., in 1980 and 1984, respectively. His doctoral research concerned nonlinear underwater acoustics.

Upon leaving Bath University, he joined the Surface Acoustic Wave Group, Department of Engineering Science, Oxford University, as a Research Fellow, where his research concerned the design of novel surface acoustic wave (SAW) devices including filters and filter banks. These devices

worked in the 10-MHz–1-GHz frequency range. In 1987, he became a Lecturer with the School of Electronic and Electrical Engineering, The University of Birmingham, Edgbaston, Birmingham, U.K. Shortly after, he began the study of the science and applications of high-temperature superconductors (HTSs), involved mainly with microwave frequencies. He currently heads the Emerging Device Technology Research Center, The University of Birmingham. His current research interests include microwave filters and antennas, as well as the high-frequency properties and applications of a number of novel and diverse materials.