

Condensation Risk – Impact of Improvements to Part L and Robust Details on Part C

Project Reference Number: CI 71/6/1 BD2414

Interim report number 7: Final report on project fieldwork

Malcolm Bell, Melanie Smith & Dominic Miles-Shenton
Buildings and Sustainability Research Group
Leeds Metropolitan University

Interim report to ODPM Building Regulations Division under the Building Operational Performance Framework

Project Title:

CONDENSATION RISK – IMPACT OF IMPROVEMENTS TO PART L AND ROBUST DETAILS ON PART C

Reference Number: CI 71/6/1 BD2414

Milestone number C1:M7

Interim report number 7: Final report on project fieldwork

Report prepared by	Proposal checked by	Proposal approved by
Malcolm Bell, Melanie Smith and Dominic Miles-Shenton (Leeds Met)	Name: Tadj Oreszczyn (UCL)	Name
Organisation: Centre for the Built Environment, Leeds Metropolitan University, Brunswick Terrace, Leeds LS2 8BU	Organisation: Bartlett School of Graduate Studies, University College London, Gower Street, London WC1E 6BT	Faber Maunsell
Project Manager: Malcolm Bell	Project Mentor: Tadj Oreszczyn	Lead Contractor
Signature	Signature	Signature
Date: 14 February 2005	Date 14 February 2005	Date

TABLE OF CONTENTS

Executive summary	5
Acknowledgements.....	8
Reproduction of Robust Details.....	8
CHAPTER 1 - Introduction	9
Report status	10
CHAPTER 2 – Fieldwork Methodology	11
Workshop phase.....	11
Site selection phase.....	11
Design review phase	14
Site assessment phase	15
Data storage	16
Developer feedback.....	16
CHAPTER 3 - Results of Design and Construction Assessments	17
Design information.....	17
Design and construction	20
Ground floor – wall junctions	20
Intermediate floor – wall junctions	28
Balconies	33
Windows and door openings	35
Room-in-the-roof details	43
Insulating around cavity trays	50
Timber panel construction	55
Airtightness and vapour control	57
CHAPTER 4 - Discussion, conclusions & selection of details for the modelling phase	67
Prevalence of problems.....	67
Limitations of the field study	68
Summary of key findings	69
Implications for Robust Detail guidance	72
Selection of details for condensation modelling	73
References	75
Appendix 1	77
Appendix 2.....	81

Executive summary

This report sets out, in draft¹, the results of the fieldwork phase of research into the impacts of the 2002 revisions to Part L of the building regulations (Approved Document L1 - DTLR, 2001), and the adoption of Robust Details (RDs - DEFRA 2001) on the extent of condensation risk in the construction of dwellings (Oreszczyn and Bell, 2003). The objective of the fieldwork was to explore the practical application of the revised Part L and its associated robust details by housing developers. This was done through a qualitative evaluation of the design and construction of 16 housing schemes designed in accordance with the revised part L and making use of robust details². The results of the analysis are to be used to enable condensation modelling that takes into account not only the guidance of robust details but also the way in which construction details were actually designed and, perhaps more importantly, constructed. To this end the report identifies 7 areas of construction detailing (yielding some 15 separate detail models) that are to be included in the condensation modelling phase of the project.

The analysis was undertaken in two phases, a desk study of the design material provided by developers and an assessment of the way details were constructed, including observations on the way design information was communicated to the construction team and used on site. A draft version of the report was sent, for comment, to the developers involved and their comments are included in the discussion in Chapter 4. In seeking to understand and place in perspective the results of the fieldwork it is important to understand the general issues raised by the specific observations and to avoid classifying the problems identified as “errors, defects or mistakes”. Like all general problems of quality management, the underlying issues are ones of system, not of individual or developer culpability. The qualitative analysis of data from the 16 sites investigated has led to the following broad findings relating to design and construction

- a) The level of knowledge and understanding relating to robust details was generally low. This is particularly true at the construction end of the process with the very existence of robust details for part L (as opposed to part E – sound) not widely recognised by many people on the sites studied. Knowledge, within the design community, of the existence of Part L RDs was more widespread but many drawings lacked sufficient detail to be certain of the extent to which designers understood the principles involved or how to apply the guidance effectively.
- b) The communication of detailed design requirements from designer to constructor (particularly the operative constructing a particular detail) was not always very clear. On some sites this stemmed from a lack of detailed design material. In a number of cases operatives worked from large scale (1:50 or 1:100) general arrangement drawings rather than large scale details and, to some extent, details seemed to be worked out on site. In other cases large scale details were available but not always as accessible as they might be.
- c) The placement of insulation, particularly where rigid boards were used, often allowed the circulation of air around the insulation, resulting in a reduction in thermal performance.
- d) Gaps in the insulation layer were common, particularly around difficult details, leading to reduced insulation at critical points and increasing the risk of surface and interstitial condensation. In general, wherever small areas required insulation, or awkward cuts were required, insulation was omitted or substantial gaps left.

¹ This version of the fieldwork report is presented, for comment, to the developers who took part in the investigation and to those who took part in the initial project workshop.

² Robust details (DEFRA 2001) are specified in Approved Document L1 (DTLR 2001) as providing a compliance route for the thermal bridging and airtightness requirements set out in paragraphs 1.30 to 1.35.

- e) The use of proprietary cavity closures in masonry construction was common but many were uninsulated. Given the frequency of this observation, it is likely that they were used in the erroneous belief that they eliminated the thermal bridge and satisfied the guidance in the RD document.
- f) The goal of creating a continuous air and/or vapour control layer was not reliably achieved on almost all of the sites visited. In masonry construction the use of plasterboard on dabs was universal but in one case only was it possible to see a reasonable attempt to create a continuous ribbon of adhesive around boards and at penetrations. On timber frame sites, although reasonable attempts were made to install an air/vapour control layer, some parts of the structure, particularly at isolated multiple stud sections, had no barrier at all. Ensuring continuity of barriers at junctions was a general problem throughout.
- g) Damage to or ill-fitting air/vapour control layers were often observed with little attempt at repair or sealing. The areas behind bathroom and kitchen fittings or inside services duct spaces were the most vulnerable. This is of particular concern given the intermittently high vapour pressures in these locations. Damage resulting from services penetrations was a particular problem despite attempts at sealing. The approach taken to the design of service penetrations (a “puncture and seal” approach) does not appear to result in robust design or construction. Very often sealing is carried out where services enter secondary spaces, such as floor voids but not where they penetrate the air/vapour barrier itself.
- h) Detailing around major structural elements did not appear to allow for the thermal bridging effects. This was particularly true of the detailing around multiple timber studs and structural steel sections.
- i) Some thermal bridging resulted from the misalignment of components such as windows and doors with respect to the placement of insulation. In a number of cases the construction of bay windows involved fixing the frame to the outer leaf of brick work, resulting in a significant thermal bridge.

Although the research did not set out to provide a statistical picture of the house building industry’s response to Part L 2002 and robust details, an assessment was made of the prevalence of the problem areas that were observed. Some 20 key problem areas were identified with 16 of these being observed on at least half the potential number of sites³.

Throughout the field work it was clear that much more needs to be done to disseminate the requirements of Robust Details and that the form and content of the document should be revised. A table of detailed improvements is provided in appendix 1. As well as extending the coverage of the details themselves, it was concluded that much more emphasis is needed on the principles that lie behind the details, together with expected performance characteristics. Many of the problems identified resulted from operations that were made more difficult by obstructions. In order to reduce this problem and make details more “buildable” it is suggested that the RD guidance include an indication of the order in which operations should to be carried out.

Appendix 2 contains a list of the seven areas of construction that are to be subjected to condensation modelling. The set of details chosen was designed to reflect the prevalence of problems, the generality of problems across construction types, the important junctions involved and to ensure an assessment that involved all forms of construction included in the study.

³ In this context, potential, is defined as the number of sites on which a particular problem could have been observed, taking into account the stage of construction at the time of site visits as well as construction type. For example, if the problem were one relating to the first floor junction in timber frame construction, the potential was taken to be equal to the total number of timber frame sites that had reached first floor stage at the time of the site visits. See table 4.1 in chapter 4.

In reading the results of the fieldwork it is important to realise that it does not claim to be representative of UK dwelling construction post the 2002 edition of Part L⁴. However, its usefulness lies in the considerable insight it provides into some of the design and construction issues that need to be addressed by all those involved in the house building industry if the quality and performance of new dwellings is to be improved.

⁴ To make such a claim would require a much larger and randomly selected sample drawn from a reliable sampling frame.

Acknowledgements

We would like to acknowledge the help and support of those developers who took part in the study. We are very grateful for the enthusiasm with which they took part and the invaluable help received by designers and site staff who were very generous with their time. We are grateful also for the anonymous use of illustrative design material, the copyright in which lies with the designers. The views expressed in this report are those of the authors and are not intended to represent those of the Office of the Deputy Prime Minister. Responsibility for any errors or omissions lies, as always, with the authors.

Reproduction of Robust Details

The illustrations of robust details used in this report are taken from *DEFRA (2001) Limiting Thermal Bridging and Air Leakage. Robust Details for Dwellings and Similar Buildings. Department for the Environment, Food and Rural Affairs. London, TSO.* They are reproduced under the general permissions granted in that document. They remain copyright of the Queen's Printer and Controller of Her Majesty's Stationery Office, to whom we are grateful for the use of the material.

CHAPTER 1 - Introduction

1. This report constitutes milestone M6, "Draft fieldwork report", of the ODPM Project; *Condensation Risk – Impact of Improvements to Part L and Robust Details on Part C* (Oreszczyn and Bell, 2003); project reference CI 71/6/1 (BD2414).
2. The 2002 edition of Part L of the Building Regulations and its Approved Document L1 for dwellings introduced lower U values and strengthened the requirements for air-tightness. This project was established in order to address the implications of these changes for condensation risk (dealt with under Part C of the Regulations). As part of the review of Part L (DTLR, 2001) DEFRA and DTLR published a set of construction details (Robust Details, DEFRA, 2001) that were to be used in conjunction with the Approved Documents L1 and L2 (ADL1, ADL2) to assist the construction industry in reducing thermal bridging and improving the airtightness of the thermal envelope. The Robust Details document contains some 130 details, covering six construction types. These details form the cornerstone of ADL1 in that they provide the principal compliance route for dwellings with respect to thermal bridging and airtightness. One of the key objectives of the research project in general and the fieldwork element in particular was to establish how Robust Details were being applied by designers and how they were being implemented in construction on site. The results of this analysis are to be used to define a representative set of details that will be subjected to detailed condensation analysis using both simple (steady state) and the more complex dynamic simulation methods. This report collates the findings of the field work and identifies the areas of detail design and construction that are to be subject to condensation analysis.
3. The project began with an industry workshop (held in December 2003) the aim of which was to identify those construction details which were perceived by the industry as being the most problematic in terms of incorporating them into the design of residential properties, construct on site or to create problems once built. The information gained from this workshop was used in the formulation of site selection and data collection procedures. Data relating to the design and construction of 2002 compliant developments where Robust Details were used was collected from 16 development sites, and was analysed so as to build up a picture of the implementation of the 2002 regulations and the use of Robust Details. Following the analysis, seven areas of construction detail and associated Robust Details were selected for detailed modelling. The field work was carried out between the beginning of May and the end of September 2004 by a team from Leeds Metropolitan University and the modelling work is being conducted by a team at University College London.
4. The work covered in this report supports research task 2 as set out in the project proposal (Oreszczyn and Bell, 2003). Details of the sub-tasks and related interim reports are set out in table 1.1:

Task	Task title	Contained in Interim Report
2.1	Workshops	Interim report number 1: Initial workshop & site selection criteria (Smith, M. and Bell, M. 2004)
2.2	Site survey	As below
2.2.1	Establish criteria for site selection	Interim report number 1: Initial workshop & site selection criteria (Smith, M. and Bell, M. 2004)

2.2.2	Identify sites and negotiate access including access to design data	Interim report number 2: site descriptions and review of initial modelling (Davies, M. et al 2004)
2.2.3	Review initial modelling work	Interim report number 2: site descriptions and review of initial modelling (Davies, M. et al 2004)
2.2.4	Desk study of details – as designed	Interim report number 4: Review of construction details (Smith, M., Bell, M. and Miles-Shenton, D. 2004)
2.2.5	Define survey protocol and conduct pilot studies	Interim report number 2: site descriptions and review of initial modelling (Davies, M. et al 2004) Interim report number 4: Review of construction details (Smith, M., Bell, M. and Miles-Shenton, D. 2004)
2.2.6	Site survey and logging of data	Interim report number 4: Review of construction details (Smith, M., Bell, M. and Miles-Shenton, D. 2004) Interim report number 5: Site survey descriptions and preliminary findings (Bell, M., Smith, M. and Miles-Shenton, D. 2004)
2.2.7	Data analysis	Interim report number 5: Site survey descriptions and preliminary findings (Bell, M., Smith, M. and Miles-Shenton, D. 2004)
2.2.8	Interim report	This report

Table 1.1 Details of tasks and related reports.

Report status

5. This report is presented incorporating comments on the draft report by the developers who took part in the field work, and by the Building Regulations Division of the Office of the Deputy Prime Minister.

CHAPTER 2 – Fieldwork Methodology

6. The objectives of this part of the project were to investigate actual construction details, as designed and constructed and to estimate the possible influence of such things as buildability and workmanship on the performance of Robust Details (RDs). To respond to these objectives, the fieldwork element has focussed on emerging practices in the use of domestic Robust Details following the 2002 revision of Part L of the Building Regulations for England and Wales (DTLR, 2001). Both design and the construction practices in the application of Robust Details have been established within the confines of the project, with particular reference to the impact of practice on condensation risk.
7. The fieldwork element was conducted in four phases
 - An industry workshop to review Robust Details and to establish key issues,
 - Site selection
 - Analysis and review of construction design drawings
 - Surveys of construction on the selected sites

Workshop phase

8. A workshop was held in December 2003 at Leeds Metropolitan University. Workshop participants included private sector housing developers, social housing developers, representatives from the timber frame and steel frame industries, building control officers and approved inspectors, and representatives from industry material suppliers and trade associations. The results of the workshop are reported in Smith and Bell (2004).
9. During the workshop sessions, the experience and opinions of the participants regarding design and construction issues were explored. The participants were asked to discuss a number of questions relating to their practical experience of the use of Robust Details on site and changes in design and site practice due to the improved measures contained in Part L of the Building Regulations. In particular, any details that were causing difficulties or concerns were to be identified. Following this, a number of vulnerable Robust Details were selected for preliminary investigation by the research team.
10. During the analysis phase of the fieldwork, the findings of the workshop were revisited and reviewed.

Site selection phase

11. Over 20 housing developments were identified yielding 16 sites suitable for data collection. The selection was based on the need for developments to be designed to 2002 Part L requirements and the desire to cover representative areas of England, the four main construction types, and a mixture of private and social development.
12. Sites were selected according to the following general criteria agreed at the workshop:
 - a. the sites must to be designed and constructed under approvals issued in accordance with the 2002 edition of Building Regulation Part L1 and to adopt Robust Details as the compliance route for thermal bridging and airtightness (paragraphs 1.31 and 1.34 ADL1),
 - b. the developments to be designed and under construction between February and September 2004,
 - c. four main constructional types - masonry full-fill, masonry partial-fill, timber frame and steel frame - were to be represented,

- d. four geographical areas of England were to be represented (North East, North West, South East and South West),
 - e. both large and smaller developers were to be included, and
 - f. sites were to be a mix of social and private developments.
13. The key characteristics of the sites selected, together with an outline of the data available and the number of site visits undertaken are set out in table 2.1. A key to the abbreviations used in the table is provided in box 1 below.

Key to table 2.1

P/F = Masonry construction with the cavity partial-filled with insulation

F/F = Masonry construction with the cavity fully-filled with insulation

T/F = Timber framed construction

S/F = Steel framed construction

Fdn = Foundation

Bkwk = brickwork. In this case (only) this may include stonework and reconstituted stonework

1st lift and 2nd lift refer to heights of scaffolding. Generally 1st lift is the external walls to first floor level, and 2nd lift at first floor level and so on.

1st fix is the stage of construction where the framework for floors, walls and/or roofs are being placed.

2nd fix is the stage of construction where the internal claddings to floors, walls, ceilings and/or roofs are being placed e.g. plasterboard, floorboarding etc.

GA = general arrangement drawings, showing show where properties are to be placed on the site, and general layout plans for the properties, usually at 1:100 or 1:50 scale, sometimes with a section through the dwelling. These do not show in sufficient detail how the construction will actually be put together.

Detail drawings = drawings at a suitable scale, usually at 1:5, 1:10 or at most 1:20, which show all the different elements involved and how they will be assembled on site.

Site reference	Type of Development	Region	Private /Social	Type	Construction stage seen on site	No. of visits to site	Detail of drawings received GA = general arrangement
C1	6 terraced houses	NE	Private	P/F	1. Fdn bkwb 2. 2 nd lift	2 site visits	GA drawings only, no detail except 1:20 partial section
C2	3 storey flats	NE	Private	P/F	2 nd lift	1 site visit	GA drawings plus details
C3	3 & 4 storey flats, 3 storey terraces	NW	Private	T/F	Fdns to 2 nd fix	1 site visit	GA drawings plus details
C4	5 storey flats, 3 storey houses, duplex flats	NW	Private	T/F	Slabs to completion	1 site visit	GA drawings plus details
C5	85 dwellings houses & flats	NE	Social	P/F	Slabs to 1 st fix	1 site visit	Site plan & details only, no GA drawings
C6	2 & 3 storey flats and houses	SW	Social	P/F	Slabs to 1 st fix	1 site visit	Site plan & details only, no GA drawings
C7	3 detached houses	NE	Private	P/F	1. fdn & slabs 2. no change; 3. 2 nd lift	3 site visits	GA drawings only, no details
C8	95 terraced, semi-detached and flats	SE	Social	T/F	Fdns to 2 nd fix	1 site visit	GA drawings plus details
C9	77 dwellings, flats, semis, terraced	SE	Social	T/F	Fdns to 1 st fix	1 site visit	GA drawings plus details
C10	30 semis and terraced houses	NE	Private	F/F	Fdns to 2 nd fix	1 site visit	GA drawings only, no details
C11	48 flats in four storeys	NE	Private	T/F	2 nd lift to 2 nd fix	1 site visit	GA drawings only, no details
C12	20 detached houses	NW	Private	P/F	Fnd bkwb, 2 nd fix & completion	1 site visit	No drawings received
C13	104 semis & detached houses	NW	Private	S/F	Slabs to completion	2 site visits	GA drawings and developer's details
C14	130 terraced, semi & detached houses	NW	Private	S/F & P/F	Slabs to 1 st fix	1 site visit	No drawings received
C16	46 plots	SW	Private	F/F	Slabs to completion	1 site visit	No drawings received
C20	3 blocks of four storey flats	NE	Social	P/F	2 nd lift	1 site visit	GA drawings and details
Summary 16 sites		NW 5 NE 7 SW 2 SE 2	Social 5 Private 11	FF 2 PF 8 TF 5 SF 2	Fdn bkwb/slab 16 Shell 16 1 st fix 12 2 nd fix/completion 8	Site visits 20 No of sites 16	Drawings received from designers 13 Drawings not received from designers 3

Table 2.1 Summary of site descriptions.

Design review phase

14. The drawings produced for a building contract will usually include plans, sections, elevations and detail drawings. Webb and Barton (2001) suggested that not all drawings produced are necessarily given to all parties, including Building Control Officers, and this was also the case in the current project with a sometimes confusing array of drawings and variations of interpretation among developers as to what is considered to constitute the appropriate level of design detail for successful construction. The nature of the design material available to the research team for each site is indicated in table 2.1.
15. Sets of design plans in paper or electronic format were received from thirteen of the developers and a desktop study of these was made. The availability of the drawings on site was also assessed for each of these sites. For the remaining three sites, as no plans were received from the developers, the design details available on the sites were inspected at the time of the site visits, and information taken from these as appropriate.
16. The main objective aspects of the design review was to provide a comparison between the designed construction details, particularly at junctions of elements, and the published Robust Details (DEFRA, 2001). Designers' construction drawings were analysed so as to establish the Robust Details or equivalents used and a qualitative assessment was undertaken taken with regard to clarity and buildability.
17. The design information received from developers was assessed by working from the general to the particular, beginning with the site layout plans to assess the scale and style of the development, followed by the general arrangement (GA) drawings to identify materials and the general location of main components (lintels, cavity trays, insulation layers etc.) and the method used to demonstrate compliance with Part L1 identified. Where provided, large scale detail drawings were assessed and compared with the relevant Robust Detail.
18. Drawings are created at different scales and therefore different levels of detail are possible. Site layouts are typically at 1:200, general arrangements of floor plans and sections are typically at 1:50, and detail drawings at 1:10. The scale of drawing produced is an important determinant of the level of analysis that can be conducted. Less than half the design material assessed involved the submission of large scale details and in these cases an assessment of design intent has had to rely on the GA drawings at scales of 1:50 or 1:100, which are often too small to supply the detail required for the full communication of design intent.
19. Design and construction do not always follow linear chronological orders. Delays are normal, as are complications. Site work can, and often does, start before design drawings are fully in place. Detail design may not exist and may be worked out on site. The design reviews therefore at times included an interpretation of the design intent based on site observations. Such site observations enabled an assessment of the extent to which this results in construction that departs significantly from any Robust Detail specified on a GA drawing or adopted through site design.
20. Subject to the level of detail supplied on the drawings and construction details, the relevant Robust Detail was compared to the proposed work. Obvious omissions or shortfalls were noted. Otherwise, where the design solution was simply different to the Robust Details, these were noted and the relevant drawings referenced. Where a particular Robust Detail was specified on the drawings, or the design solution was the same as a published Robust Detail, this again was identified.
21. In addition to assessing the extent to which Robust Details were used and the level of detail provided, the design assessment sought to look qualitatively at those aspects that could impact on condensation risk. In the main these assessments focused on the extent of thermal bridging observed in the drawings and the likelihood that buildability problems

- would lead to critical construction defects. It is realised however that although thermal bridging is an important element in determining the likely extent of surface and interstitial condensation, it is not the only consideration. The selection of details for modelling sought to take into account the qualitative assessments from both the design and construction reviews.
22. The design reviews and site assessment protocols and methodology were based on the approaches developed by Webb and Barton (2001), Webb et al (2001), and by Johnston et al (2004) for assessment of airtightness of buildings. These were developed and modified to satisfy the requirements of this Project. The assessment comprised a series of data sheets detailing the arrangement of materials, components and construction in the following areas:
- a. General construction of primary elements
 - b. Ground floor/external wall junction
 - c. External walls
 - d. External doors and windows
 - e. Intermediate floor/external wall junction
 - f. Roof/eaves/ceiling junction
 - g. Method of dealing with services penetrations of the thermal envelope
23. These data sheets provided information on material, dimensions and lambda (thermal conductivity) values, as given on the design drawings, for the external shell of the building including the party walls where applicable. The type of construction proposed, for example beam and block ground floor or suspended timber ground floor, partial-fill masonry walls or steel framed, ventilated roof void or ventilated rafter batten roof, was identified. Where there was a relevant Robust Detail, either specified or implied, the reference number from the published document was added. More detail on the design review process is provided in Smith et al (2004). The completed design review for each site was then used as the starting point for the site assessment.

Site assessment phase

24. Twenty site visits were made to the 16 sites. Each site was visited at least once to enable a survey of relevant details. Photographic, textural and hand sketched data was recorded and added to the data base.
25. During the piloting of the site assessment checklist, the team noted that whilst it is important to note faults or shortfall in the construction design or implementation, it was important to gain some indication of how often this fault or shortfall occurs across the site. When a fault or shortfall as identified, similar elements in the same and different plots were inspected to identify whether this is a common or infrequent occurrence.
26. Different size and types of sites require different visiting arrangements depending on the construction programme, for example site C1 was visited twice. It is a small site of 6 terraced properties being constructed as a single block. At the first visit, the properties were up to ground level, with the first lift started. At the second visit, the brickwork on the second lift was underway. This compares with larger developments, constructed in phases, with two or three gangs of operatives working at any one time. On such sites, properties can be viewed at different stages during a single visit. Three smaller sites needed more than one visit so that the researchers could survey different details as the properties progressed.
27. The methodology of site assessment, including a typical example of a completed site assessment, is discussed in Bell et al (2004). This identified the site assessment protocol

- and recording of data by digital camera and hand-drawn sketches. As far as possible in the time available, the research team visited all available plots on each site. This yielded between 3 and 48 dwellings/plots in a single visit. A general check list was used based on the headings adopted for the design assessments but as the construction detail observed displayed considerable variety the checklisting approach was used flexibly so as to ensure that it was tailored to the requirements of each site visited.
28. Assessment of construction practices on site was made using a site assessment process that was compatible with the design review checklist used. The site assessment checklist for each site therefore used the completed design review checklist as the starting point so as to provide the design information necessary for site assessment. The actual construction details are compared to the design information given, or to the relevant Robust Details (this was of particular relevance where large scale details are not available). Descriptions and measurements were taken and sketches produced on the check-sheet for later desktop analysis. Photographs of relevant details were taken and stored electronically for reference and analysis. Where appropriate, image files were linked to the assessment database.

Data storage

29. In order to ensure anonymity, the data storage system was designed so that the useful information can be retrieved without identifying any specific site or developer by name. Records containing contact details, site location and developer details, are held in such a way as to be available for project management purposes but password protected. All identifying information will be expunged following closure of the project. The database contains information obtained from drawings and site visits including over 1300 photographs, scanned drawing details, on-site sketches and AutoCAD drawing files.
30. The data storage system is held on a PC within the Centre for the Built Environment at Leeds Metropolitan University. Full administrative privileges are only available to members of the group who need to input data, run filters and queries.

Developer feedback

31. A draft version of this report was sent to all developers for comment. Detailed comments were received from one developer and these are included in the discussion in chapter 4.

CHAPTER 3 - Results of Design and Construction Assessments

32. In this chapter we present the results of the observations on both design and construction. Our observations on design relate primarily to the level of design information provided and the way in which it was communicated to construction teams. In presenting the results on potential construction problem areas, we have focused on the end result of the design and construction process rather than attempting to separate detail design from construction. Although in all cases it was possible to identify design and construction as separate phases the relative impacts of each on the final form a detail takes are almost impossible to separate. The level of design information varies considerably, changes are made to the design on site, even when very clearly specified and, particularly when design information is sparse, details are designed on site as work proceeds.
33. Many of the areas of concern bear similarities to parallel work on the airtightness of buildings constructed to Part L 2002 (see, for example, Borland, Prescott and Lloyd, 2004). Specific elements include wall/roof junctions, wall/ground floor slab junctions, opening/wall junctions, and cavity barriers where lack of continuity of insulation, perforation of air barriers, and lack of continuous air barriers have implications for condensation risk.
34. In a number of cases there are concerns that the consideration of buildability issues during design is problematic and likely to result in defects in the placement of insulation, leading to increased thermal bridging, air voids and air paths within the structure, all of which may increase the risk of both surface and interstitial condensation. The modelling phase of the project will seek to identify the extent to which such problems give rise to significant condensation risk.

Design information

35. The level of design data received for each site is summarised in Table 1 above. The most striking characteristic of the design information available was the considerable variation in the level of detail provided. Of the thirteen sets of drawings received only eight included large scale (1:10 or 1:5) construction details of the type used in the Robust Details publication. The remaining five worked with smaller scale (1:50 or 1:100) site layout and general arrangement drawings with specification notes to fill in some of the detail. The extent to which this is likely to hamper the successful interpretation of Robust Details in both design and construction is discussed below.
36. Where detailed drawings are not produced, a common finding has been the inclusion of rather vague references to the requirements of Part L1 such as “Airtightness to Part L of the Building Regulations” and “Robust standard details to be conformed to”. This immediately raises the crucial issue of intent and execution in that the design drawings contain an intention to comply with ADL1, but do not indicate how this is to be done. This is important since Building Control Officers may not request further information but accept these general statements as showing compliance with Part L, whilst site staff may not be fully conversant with the details contained in the Robust Details document and, even if they were, it is questionable whether they have the time to interpret and apply the details effectively. In any case not one of the sites visited kept a site copy of the Robust Details document. The statements on GA drawings regarding compliance with Part L1 are therefore considered to be at best vague, and at worst meaningless since they provide a false sense that everything is as it should be. It is clear that reliance on this level of detail is unlikely to produce robust construction.
37. Discussions with site staff about the level of understanding of Robust Details revealed that the site managers and operatives generally understand “Robust Details” to be those relating to Part E. The concept that “RD = sound” is almost universal amongst site

- personnel. This level of awareness in relation to Part E may be the result of strong industry involvement (through the House Builders Federation) in their development. In contrast, the level of awareness of Part L is much, much lower. Only one site manager questioned said that there were Robust Details for both acoustic and thermal insulation.
38. In some of the cases studied, there appears to be a number of general and, almost certainly, tacit assumptions being made about the extent and location of knowledge of Robust Detail requirements. The designer assumes that the building control officer understands Robust Details, and vice versa. The designer assumes that the contractor understands Robust Details and that the details on site will be checked by building control. The developer assumes that the site manager can understand the robust construction techniques from the level of design information issued. The site manager assumes that the operatives will be able to build to robust standards using the drawings in the site office. These are wide ranging assumptions and the observations made during the fieldwork questions their validity.
39. When questioned about the way information about design was disseminated from head office to site manager to operative, the site managers gave mixed responses. Generally the site manager is given the drawings to study but, as noted above, this may not include details. The relevant drawings are then used to brief, either by trade or operation, the various operatives involved. The drawings are usually then filed for future reference and may not be easily accessible. When asked about specific training of the operatives in relation to the requirements of Robust Details or other relevant parts of the design, the manager's response in seven of the sixteen sites visited was that the operatives are tradesmen experienced at their work and did not need additional training. Given the relatively recent introduction of the Part L Robust Details, this assumption of knowledge, coupled with considerable variability in the way access to drawings and details is provided, may not be well founded and could lead to a high level of defects. Moreover the training and staff development opportunities provided by the application of Robust Details and other well thought out details may well be lost.
40. Even when good large scale detailed drawings were provided and communicated to site staff, inconsistencies can create difficulties. The problem is often one of issuing different versions of drawings to different trades with consequent uncertainties over what is required.
41. An example of this is illustrated on two sites. The drawing information is included in figures 3.01 and 3.02. Here different trades were supplied with a ground floor/foundation/external wall detail. For two trades (Groundworks detail 01 and Bricklayer detail 01) the position of the bottom of the cavity wall insulation was vague, shown positively from dpc/top of slab level, with accompanying text sending the reader to a further design sheet for information as to where to start the cavity wall insulation (figure 3.01). A third trade detail drawing (Joiner detail 01) showed the cavity wall insulation correctly starting at the base of the ground floor slab insulation (figure 3.02). Site observations revealed an inconsistency in construction, with some in accordance with the drawn information on the ground-work and bricklayer detail, resulting in thermal bridging, and some following the more robust joiner version.

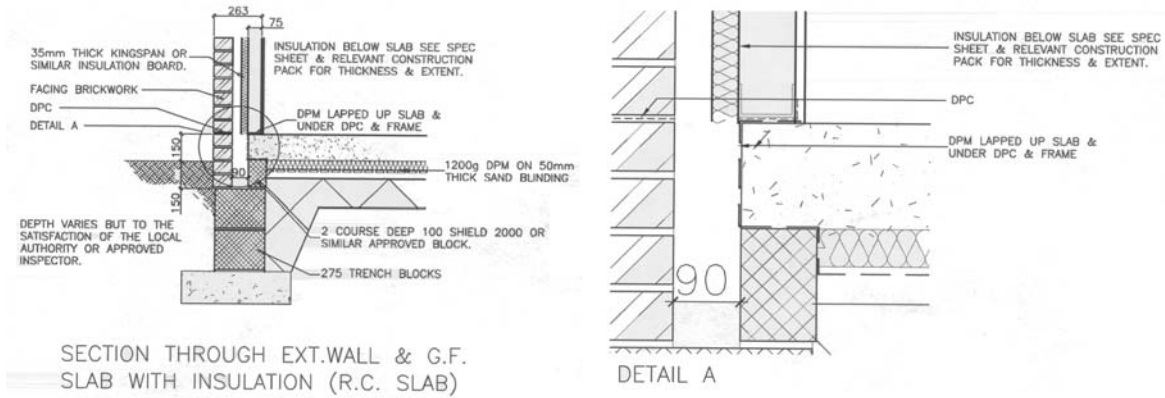

Figure 3.01 Extracts from working drawings, showing details for groundworks and bricklayer.

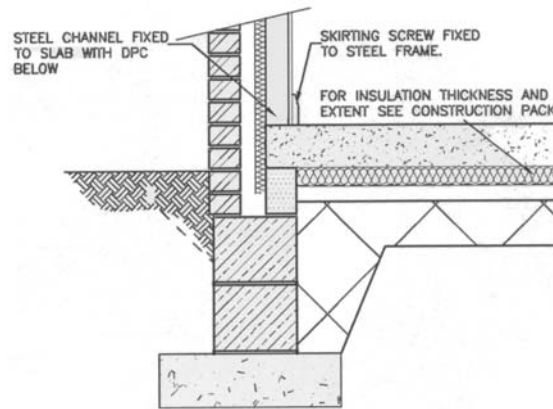

Figure 3.02 Extract from working drawings, showing details for joiner.

42. Despite the problems indicated above, the team also observed cases where Robust Details were well applied with well thought out detailed drawings and an ability to modify details based on the principles contained in the document. In one case where a specific detail does not exist (timber frame - ground floor/wall junction with insulation below the slab) the designer had modified a supporting wall design to minimise the potential thermal bridge by including a suitable lightweight block. Similarly, examples of good site team communication were observed. For example, on the sites of one developer, large scale details were displayed on the site office wall for everyone to consult, thus enabling quick and easy access to the information required.
43. Creating defect free construction requires not only the provision of detailed design information to the operatives who are to carry out certain operations but also a more general awareness of the requirements among others who may have an impact on the work in question. This is of particular relevance in the case of one trade following another, for example services installers following joiners. Figure 3.03 shows how the work of an electrician resulted in gaps in the insulation despite the initial efforts of the joiner to ensure a good fit.

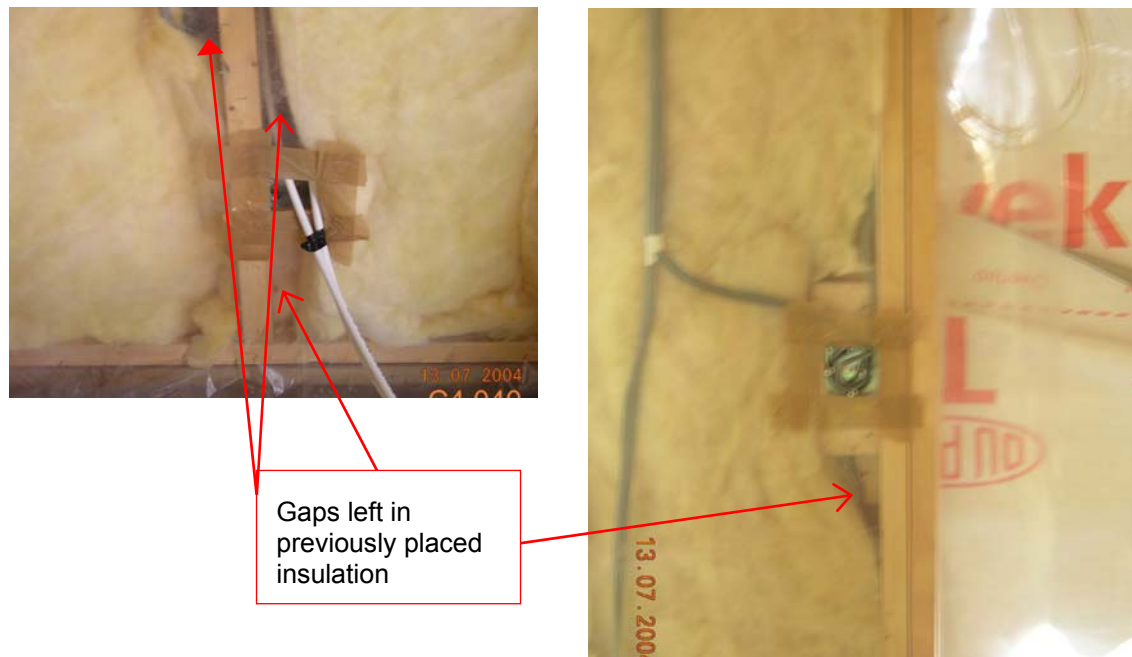

Figure 3.03 Insulation laid by one trade is moved by a following trade to create gaps.

Design and construction

44. The results of the assessment of design and construction have been classified into the following groups.
- Ground floor – wall junctions
 - Intermediate floor – wall junctions
 - Balconies
 - Windows and door openings
 - Room-in-the-roof details
 - Insulating around cavity trays
 - Timber frame panels
 - Airtightness

Ground floor – wall junctions

45. Observations relating to the detailing of the junctions between ground floors and external walls focused on the problems of minimising thermal bridging. Three main areas emerged:
- Design and placement of edge insulation
 - Levelling of timber frame panels on in-situ reinforced concrete suspended floor slabs
 - Misalignment of steel frames and substructure.

Design and placement of edge insulation

46. Concrete ground floor construction was used on all sites visited. In over half of cases (9 sites) an in-situ suspended slab was constructed over hardcore fill with floor insulation placed below the slab. This arrangement was adopted for both cavity masonry (full and partial fill) and timber frame wall construction. However, in 8 of the 9 sites the detail did not correspond directly with the Robust Details document. In the case of timber frame no specific detail is provided in the document to allow for an in-situ suspended concrete ground floor with insulation below the slab and in the case of cavity masonry the relevant details (RDs 3.17 and 4.17 – see figure 3.04) were not used. Figures 3.05 and 3.06 show typical arrangements in timber frame and partial fill cavity masonry. Figure 3.07 illustrates the one case to adopt a robust detail (RD 4.17).

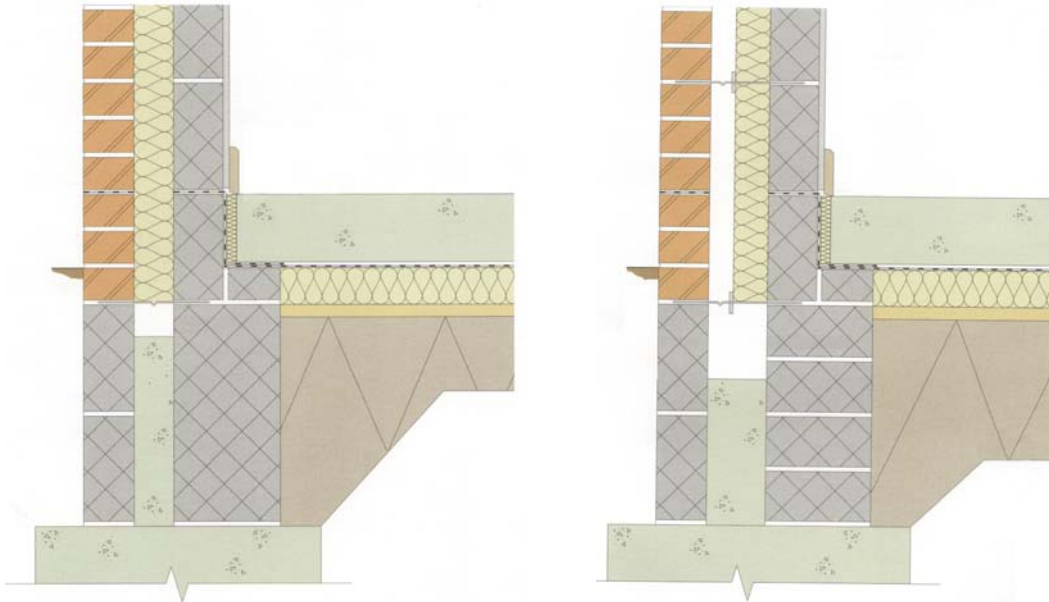

Figure 3.04 Robust Details 3.17 and 4.17.

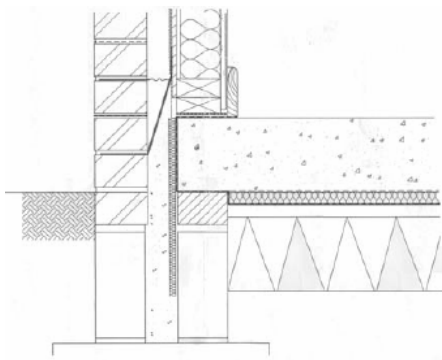

Figure 3.05 Typical ground floor slab perimeter detail for timber frame.

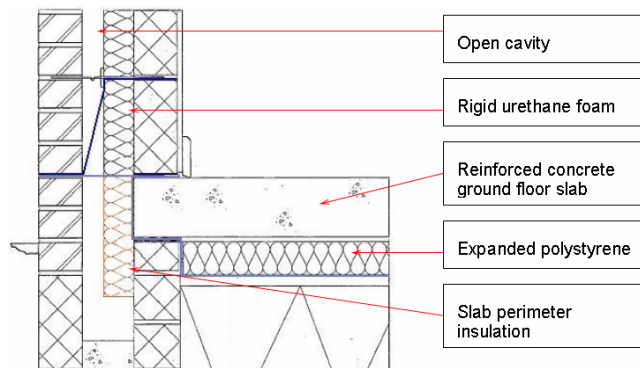

Figure 3.06 Typical ground floor slab perimeter detail partial-fill masonry construction.

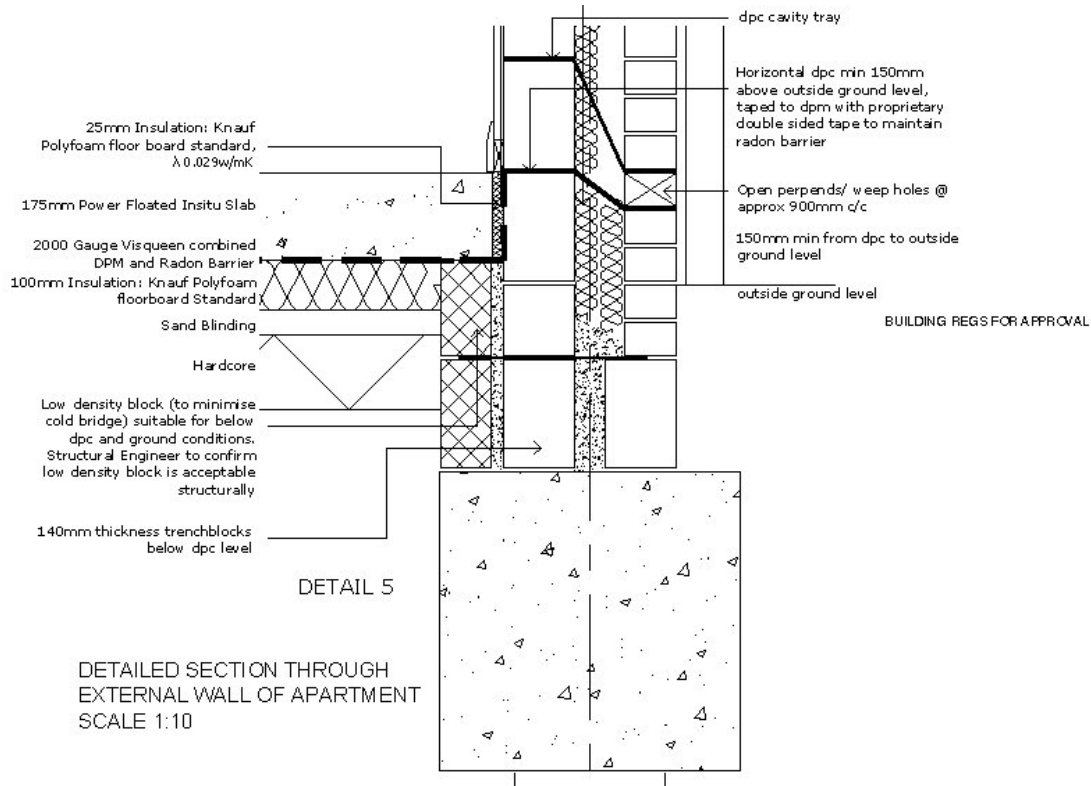

Figure 3.07 Ground floor slab detail – partial fill masonry site.

47. In the eight non-standard cases, the placement of edge insulation in the cavity and the use of a suitable lightweight block below the slab are important if thermal bridging is to be minimised. However site observations indicated that in many cases the required edge insulation extending below dpc level was not installed. This is illustrated in figures 3.08 and 3.09 where partial-fill insulation rests on a wall tie at dpc level but no edge insulation exists below this level¹. On some sites, edge insulation was in place, partly to act as a former for casting the slab but then either completely or partially removed, leaving a gap in this edge insulation (see figure 3.10). Similar problems were also evident on sites using pre-cast suspended concrete beam and block floors where edge insulation in the cavity, in addition to insulation at the edges of a floor screed, would be required, as shown in figure 3.11, this was often missing. The omission of edge insulation at level thresholds to patio and entrance doors was another common problem irrespective of construction. Figure 3.12 shows a typical arrangement together with the relevant Robust Detail (RD 8.06). There were examples of well constructed details (see figure 3.13) but these tended to be in the minority.

¹ In making these observations we are aware that construction may be incomplete however in the cases observed wall insulation was in place making it almost impossible to fit edge insulation below previously installed wall insulation.



Figures 3.08 and 3.09 Partial-fill masonry construction, slab edge detail.



Figure 3.10 Gap in slab edge insulation in timber frame construction.



Figure 3.11 Perimeter insulation missing below dpc in masonry construction.



Figure 3.12 Omission of edge insulation at patio door reveal – and RD 8.06.

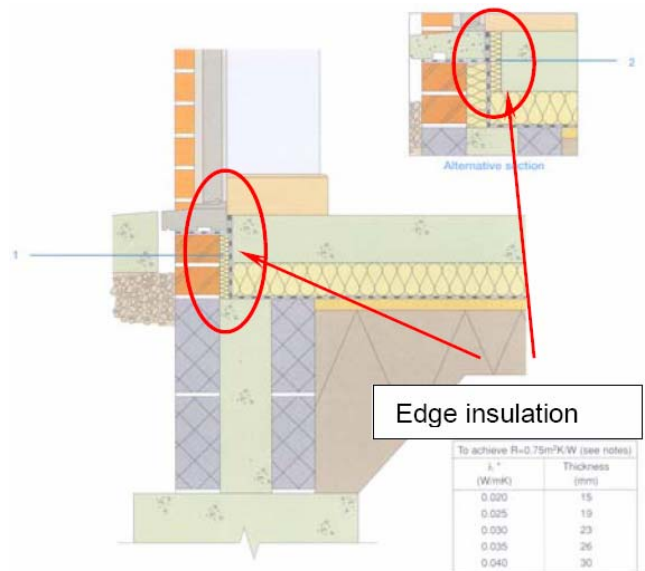

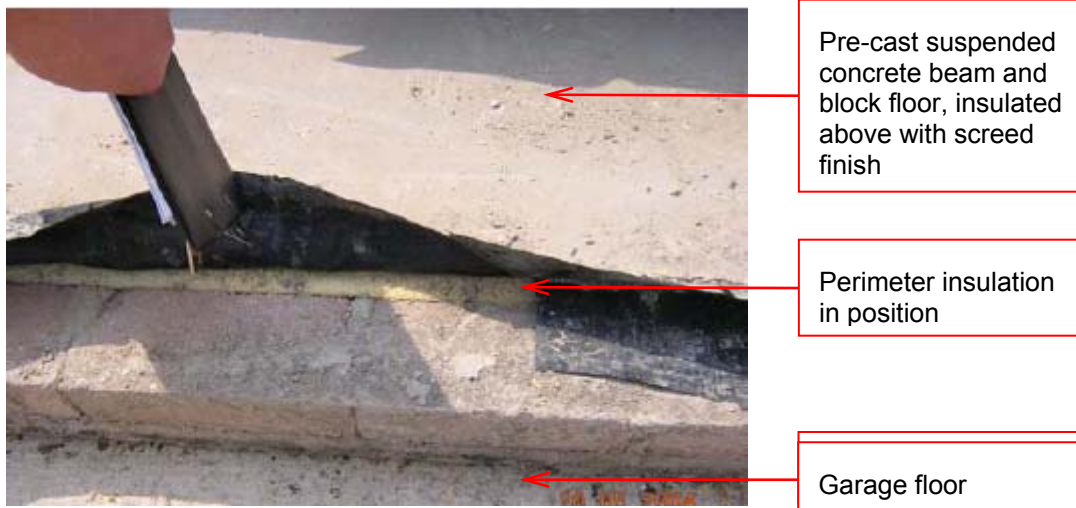
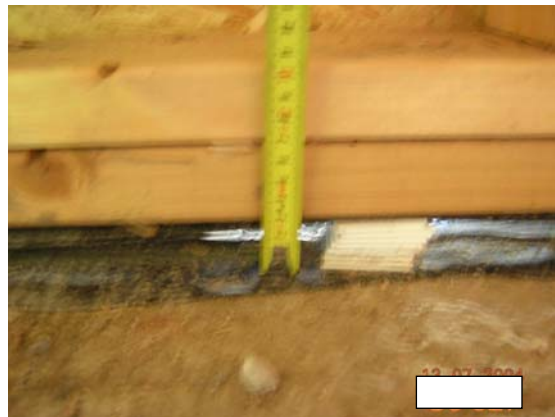

Figure 3.13 Ground floor with perimeter insulation in place.

Levelling of timber frame panels

48. Despite the quality benefits that off-site manufacture is able to achieve, problems can arise at the interface between site construction and pre-manufactured components. This is primarily a problem of ensuring acceptable tolerances, particularly in site based construction. Observations on one of the timber frame sites where the frame was constructed off an in-situ suspended RC slab demonstrated the nature of the problems that can arise. In this case the timber frame wall panels were placed on floor slabs which were not perfectly level. In order to take account of the undulations in the surface, plastic spacers were used under the sole plate. A typical arrangement is illustrated in figure 3.14. In some cases the gaps under the timber frame were up to 30mm (see figure 3.15) and were still evident after the frame was insulated and the vapour control layer fixed immediately prior to dry lining. Although it is possible that remedial work could have taken place just before the plasterboard was fixed, there was little evidence of this.



Figures 3.14 and 3.15 Plastic spacers used to level timber frame.

49. The significance of such gaps lies in the potential created for reduced airtightness and thermal performance both of which will tend to result in local cooling of the floor slab and the space behind the skirting board with increased risk of surface and interstitial condensation. Figure 3.16 shows a sketch of the detail, as constructed, with edge insulation missing. Carlsson et al (1980) show clearly how this problem can be overcome through the use of a gasket between the slab and the sole plate of the wall.

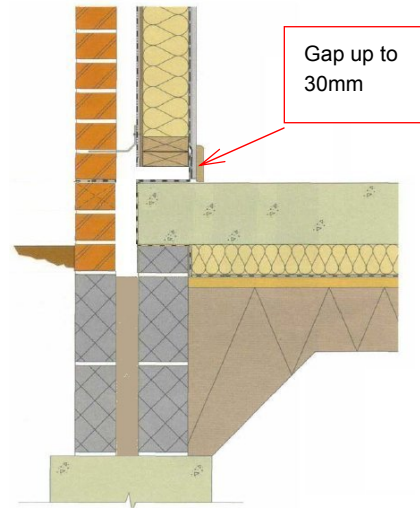

Figure 3.16 Timber frame on in-situ RC suspended slab - as constructed¹. (this figure is intended to stress the modified from

Setting out tolerance for steel frame construction

50. All ground floor/wall junction details in the Robust Details document relating to steel frame construction (details 7.07 to 7.11) rely on the continuation of the cavity insulation below floor level and this is the approach used in the designs adopted on the sites studied (see figure 3.17) However, the effectiveness of the insulation is dependant, to some extent on its closeness of fit and the avoidance of discontinuities. In order to achieve a good fit it is important that the frame lines up with the outside edge of the slab or kerb (as indicated in figure 3.17). On one of the steel frame sites visited this was not achieved. Figure 3.18 shows a mismatch between the plan shape of the base and that of the frame. This meant that, on at least one elevation, the base of the frame was not in alignment with the edge of the base resulting in a set back from the edge of around 50mm at one end of a wall section narrowing to almost zero at the other².

¹ This figure is meant to stress the “as constructed” application of Robust Details relating to ground floor/wall junctions in timber frame construction (details 6.11 to 6.15). It must be understood, however that it is **not** a Robust Detail and has no equivalent in the Robust Detail document.

² In the case observed there would not appear to be any structural implications of the misalignment since the frame channel was fully supported, but it may not have been within the range of normal tolerances and deviations in BS 5606, Accuracy in Building.

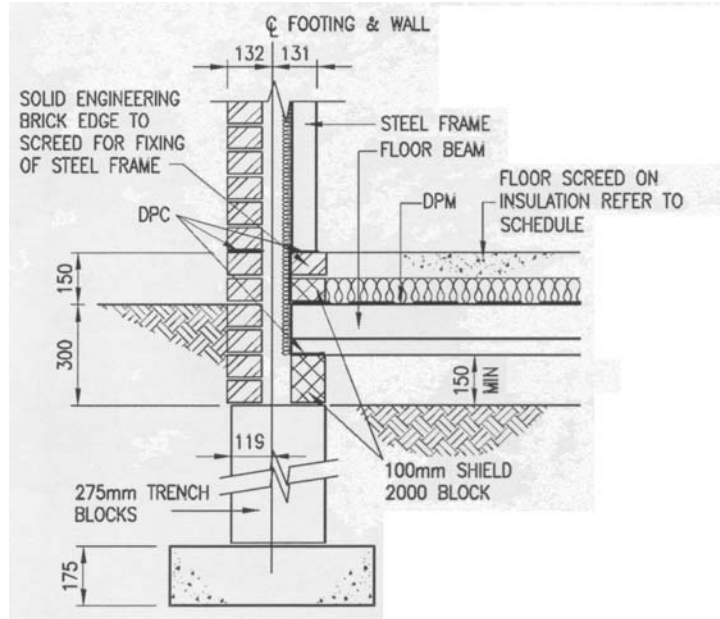

Figure 3.17 Ground floor detail in steel frame construction.



Figure 3.18 Slab not square in steel frame construction.

51. Whatever the cause of the misalignment (setting out of the base or manufacturing errors in the steel frame) its effect was to make it very difficult to maintain continuity in the external insulation. The practical response to this problem was two-fold; either the wall insulation was stopped at dpc level and a separate piece of insulation placed in the

cavity, leaving gaps in insulation, or the wall insulation was bent over the protruding slab leaving an air space around the base of the steel frame. The sketches in figures 3.19 and 3.20 illustrate this together with examples of site observations. Although the resulting gaps appear to be small, they have implications for the effectiveness of the insulation around the junction and airtightness. The integrity of the insulation layer is of particular importance in warm steel frame construction since it has an additional function as the prime air and vapour control layer.

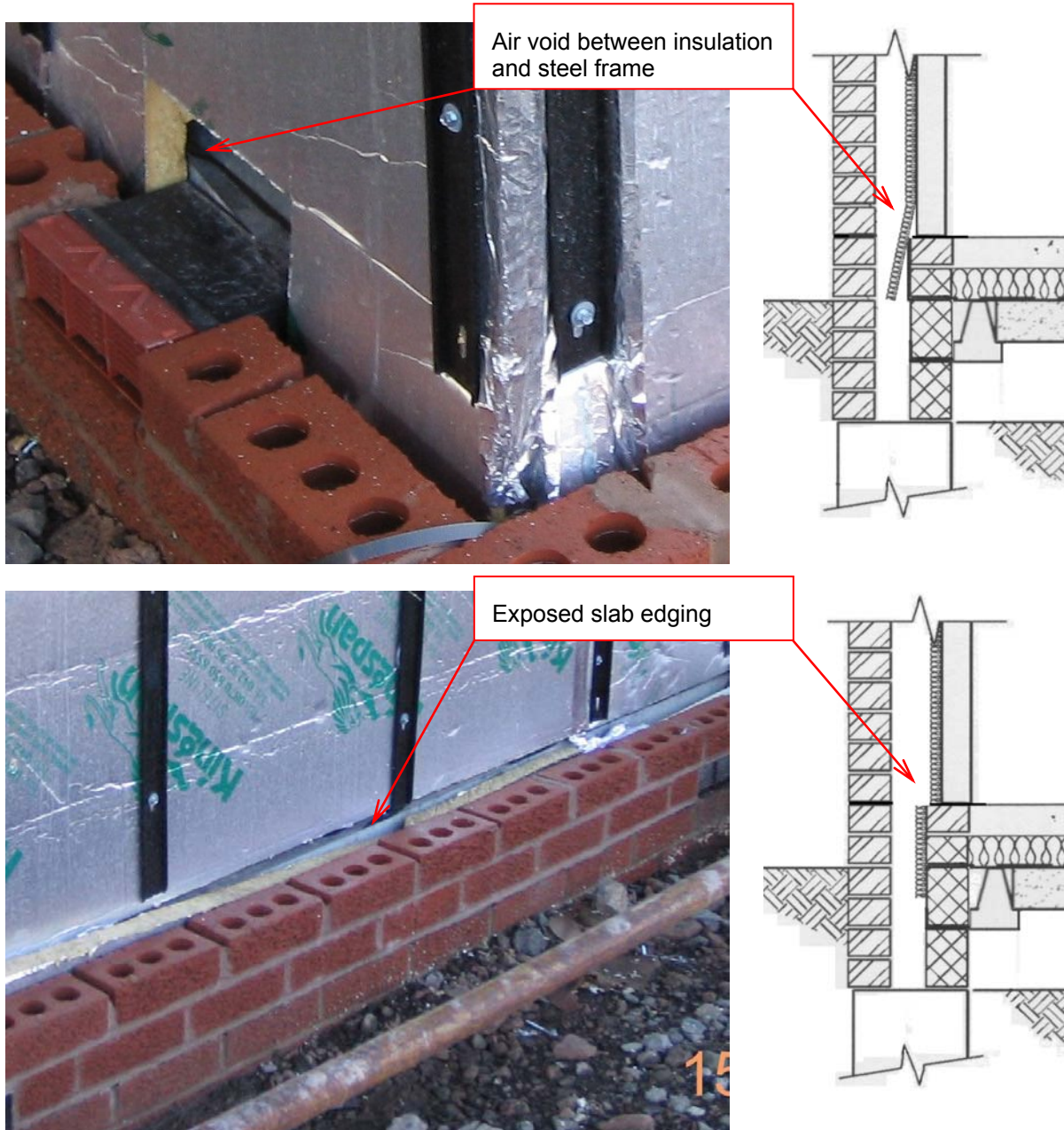

Figure 3.19 and 3.20 Placement of cavity wall insulation, above and below slab, in steel frame construction with misalignments of steel frame and slab.

52. In addition to the overall tolerance mismatch between frame and base, problems occurred at door openings. In setting out the base, the floor slab/screed is extended over the wall substructure to enable the creation of a level threshold and this is normally cast

as an integral part of the base prior to frame erection. If there are minor setting out errors in casting the base (or minor changes to the frame in manufacture) the threshold does not line up with the door opening in the frame resulting in holes in the floor at the threshold as illustrated in figure 3.21. Although this could be rectified when the steel frame and its insulation was erected, it is often left until a much later time when satisfactory remedial work is more difficult to carry out. We did not observe cases where it was rectified. We have highlighted this as a problem in steel frame construction, but it was observed also in other forms. As with other similar defects its significance lies in the potential for small areas that could be susceptible to surface and interstitial condensation.



Figure 3.21 Gap at level threshold.

Intermediate floor – wall junctions

53. Intermediate floor junctions can be a source of insulation discontinuity and reduced airtightness. Design and site observations have identified the following issues:

- Perimeter insulation in timber frame construction.
- Discontinuity of external insulation in steel frame construction.
- Built-in floor joists in masonry construction.

Perimeter insulation in timber frame construction.

54. The design of intermediate floor – wall junctions in timber frame construction is covered by Robust Detail 6.18, which is illustrated in Figure 3.22. In order to minimise thermal bridging insulation is shown within the perimeter structure. Where large scale design details were available they tended to show the appropriate placement of insulation, as illustrated in figure 3.23. However, in the case of one set of drawings for timber frame flats where floor voids contained some acoustic insulation, the need for full depth perimeter insulation was not always clear (see figure 3.24).

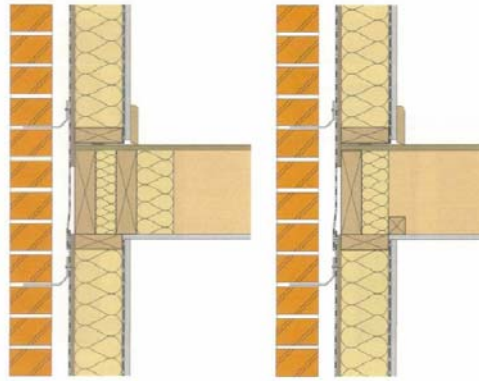

Joists parallel with the wall

Joists normal to the wall

Figure 3.22 Robust detail 6.18.

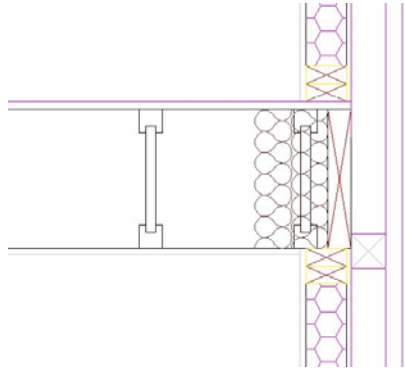
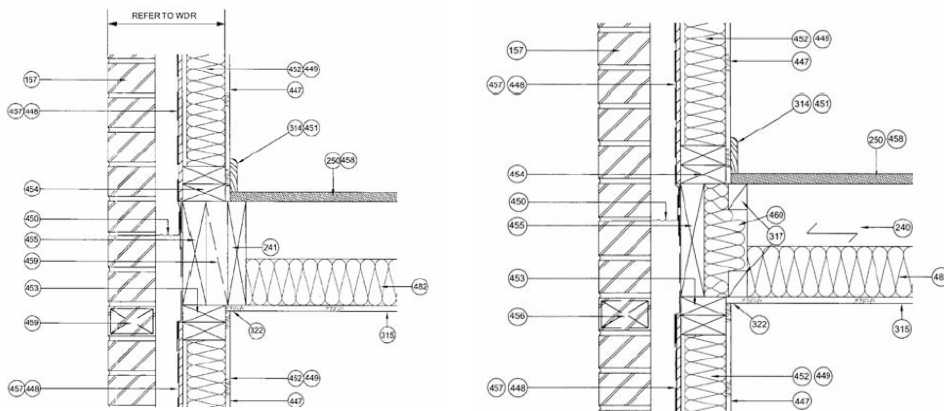

Figure 3.23 Floor junction detail – single dwelling.



Joists parallel with the wall

Joists normal to the wall

Figure 3.24 Floor junction between flats.

55. Despite the perimeter insulation shown in design drawings, site observations revealed little evidence that it was actually placed. Figure 3.25 shows external walls with wall insulation and vapour control layers in place but no perimeter insulation at intermediate floor level. Although it is possible that insulation would be placed at a later date, this was considered unlikely as it would have required a second visit by the insulation gang. In any case the proliferation of services runs (figure 3.25) would make placement difficult as would the narrow space between the multiple joist and the wall. On some sites there seems to have been an assumption that the timber I-beam floor cassettes would have perimeter insulation fitted at the factory. In one case the site team had an opportunity to check this assumption through a hole in the perimeter space, which was cut for a gas pipe. As shown in figure 3.26 no insulation was evident. Evidence from another timber frame site where access to the floor edge¹ was available provided another example of an uninsulated void (see figure 3.27). The lack of perimeter insulation would seem to be a general problem since in none of the timber frame sites visited was the placement of perimeter insulation observed.



Figure 3.25 High concentration of services and close proximity of I-beam to external wall reduce both access and the likelihood of effective insulation at intermediate floor perimeter.

¹ Access to the floor edge was available where a stair window spanned between upper and lower floors.



Figure 3.26 Holes made in double I-beams reveal lack of perimeter insulation.



Figure 3.27 Uninsulated edge beam to timber frame intermediate floor.

Discontinuity of external insulation in steel frame construction

56. As already indicated, warm frame steel frame design relies heavily on the integrity of the external insulation to avoid moisture and thermal degradation problems. In warm steel frame, the primary air barrier is provided by the insulation layer. Thus, gaps in the continuity of this layer will result in coincident air leaks and thermal bridges. Moreover, as our observations establish, there is a tendency for defects in the insulation layer to occur close to framing members – where local thermal conductivities are highest. The coincidence of gaps in insulation, leakage paths and framing members maximises the impact of such defects. In general, on both sites included in the research, the close butting and taping of insulation boards was done with reasonable care. However, as indicated in the ground floor section above, this was not always possible. Figure 3.28 shows the relevant Robust Detail (RD 7.13) for the intermediate floor junction compared with the detail as designed and constructed. The designer thought it necessary to introduce a cavity tray¹, the fitting of which meant that a gap of some 22 mm (the thickness of the floor boarding, which is sandwiched between the upper and lower frame sections) in the insulation layer. Given a perfect fit and a good seal between the frame and the floor covering this may not be particularly significant but site observations indicated that the gap in the insulation could be almost 40 mm and the joint between tray and insulation remained unsealed, providing a potential air leakage path. Air pressure tests carried out on the same site for a related project (see figure 3.29 reproduced from Johnston et al 2004) identified considerable leakage at this junction.

¹ It is presumed that this was made necessary by the introduction of a cavity barrier. However the drawings are not very clear on this point and the external brickwork was still to be built at the time of the site visits.

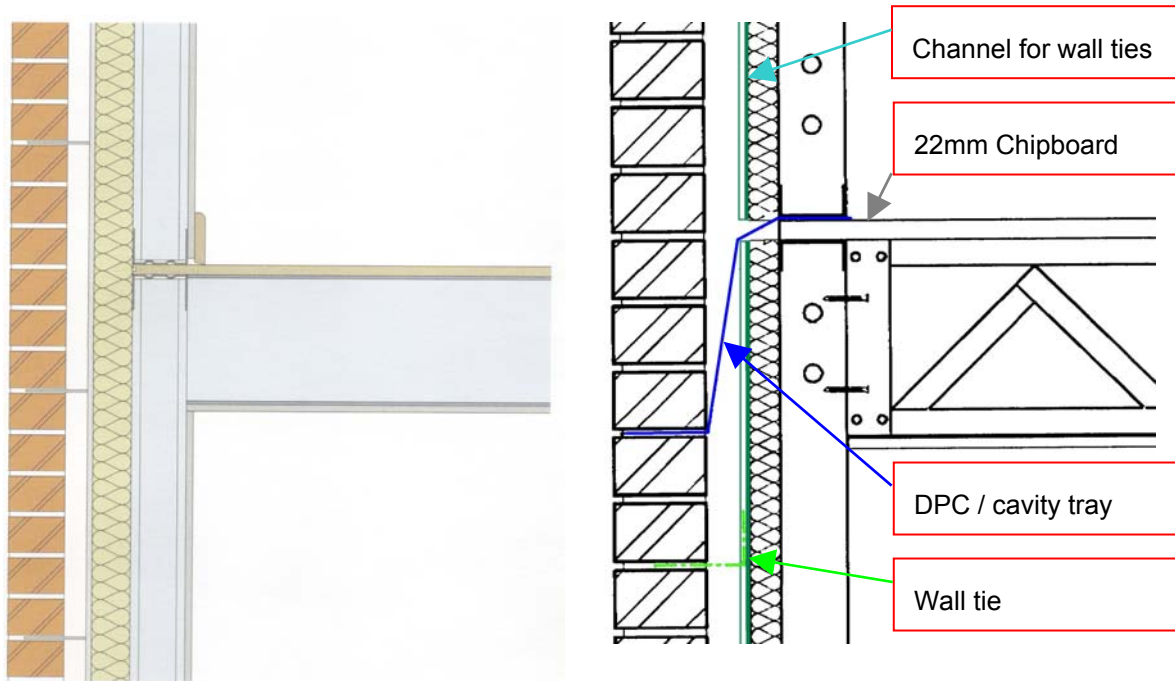

Figure 3.28 Robust Detail 7.13 and typical design detail of an intermediate floor for lightweight steel frame construction.



Figure 3.29 Air leakage through intermediate floor junction (Johnston et al, 2004).

Built-in floor joists in masonry construction

57. Although most of the masonry sites visited followed the advice in the Robust Details document and used joist hangers for intermediate floors, five sites did not, preferring to build them in. The problems of adequately sealing the penetrations is well known and site observations in this project (and an associated project on airtightness see Johnston et al 2004) indicated that these have not, in the main, been resolved satisfactorily. Figure 3.30 is typical of the problems faced. In addition to the airtightness problem, one site provided

an illustration of the difficulties of insulating across the joist ends. In figure 3.31 the joist ends protrude into the partially filled cavity but instead of trimming the joists to a tight fit the insulation has been cut back, not only reducing the insulation thickness but also leaving room for air flow which bypasses the insulation. This is, perhaps, something of a curio in this project and the problem is not particularly severe but it is conceivable that in extreme cases, even greater thicknesses of insulation could be removed.

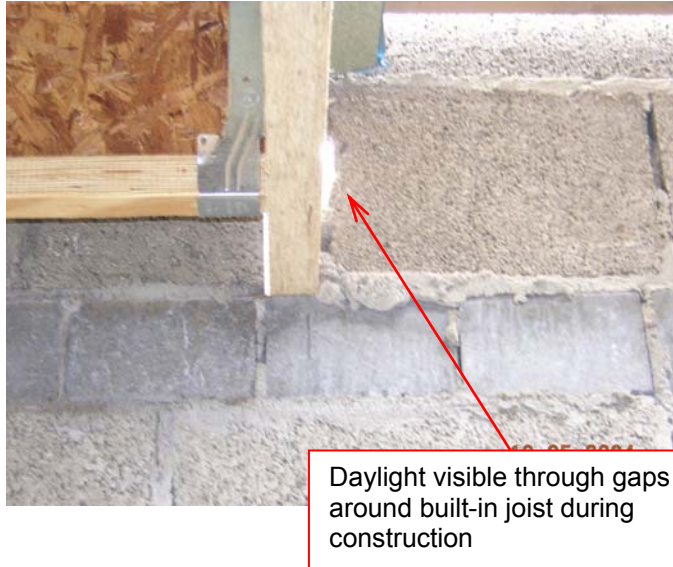

Figure 3.30 Built-in joists in masonry external walls¹.



Figure 3.31 Partial-fill insulation in masonry construction, cut around joist ends.

Balconies

58. There is no separate Robust Detail for a balcony; balconies are referred to in the Robust Details publication at the intermediate floor details for all the differing construction types. These contain a textural note only which states, "Balconies may be built so long as the wall insulation layer is not broken. The balcony/supports may be tied back through the insulation so long as any penetrations are sealed". These details are not easy to design and it is suggested here that more guidance is required (and particularly example drawings) on the principles of continuity of thermal insulation and of air and vapour barriers.
59. Four sites had balconies in their designs, three of which raise some concerns. The fourth development had balconies which were not supported by tying through to the inner leaf, instead being supported by pillars and brackets wholly external to the insulation layer, and therefore did not raise specific issues for this project.
60. Figure 3.32 shows one example of design where the lack of perimeter insulation below the parapet wall results in a thermal bridge through the timber frame. In addition, the area around the steel beam below the balcony door shows a lack of consideration of insulation requirements; RSJs are further also discussed later.

¹ At this point one is tempted to quote Romeo "But, soft! what light through yonder window breaks?" (Shakespeare, 1596, Act 2 Scene 2.)

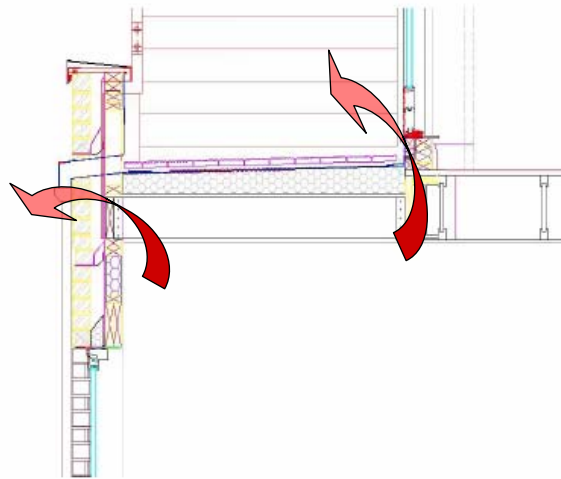

Figure 3.32 Example of balcony drawing detail, with potential thermal bridges indicated (arrows).

61. In general site observations indicated that a reasonable level of care had been taken to minimise the bridging problems created by through fixings. However for structural reasons fixings for two types of balcony consisted of substantial steel sections that penetrate the insulation layer. Figures 3.33 and 3.34 show some of the fixings used on a partial-fill masonry site and a timber frame site respectively. Although it is not within the remit of this project to carry out the detailed three dimensional analysis that would be required to understand the impact of such fixings, revisions to Robust Details should provide more guidance so that designers are able to minimise the risks involved.



Figure 3.33 Balcony support through partial-fill masonry construction.



Figure 3.34 Balcony support through timber-frame construction.

Windows and door openings

62. Site observations of construction at window and door openings revealed the following general problems:
- Widespread use of uninsulated propriety cavity closers and other problems of closure design;
 - Inadequate filling of cavities around openings in masonry cavity construction;
 - Location of window and door frames with respect to alignment with the insulation layer;
 - High timber ratio to timber frame construction window heads

Cavity closure

63. In the majority of cases where cavity masonry construction was adopted (both fully filled and partially filled) openings were designed using propriety cavity closers at sills and jambs. These usually consisted of plastic box section extrusions that fitted into the cavity to a depth of between 40 and 50 mm with fixing flanges overlapping the brick and block work reveals. Although on some sites the box sections were filled with a foam insulant, in the majority of sites sections were uninsulated. This is illustrated in figures 3.35 and 3.36.



Figures 3.35 and 3.36 Uninsulated closers.

64. The use of propriety cavity closers is recognised in the Robust Detail document (see Robust Details 3.12 and 4.12) and where they are used a minimum resistance path of $0.45 \text{ m}^2\text{K/W}$ is specified (based on manufacturer's certified data)¹. While it is recognised that a carefully designed uninsulated closer could achieve this value across its full width, it is highly unlikely that this would be achieved in practice. The minimum frame/cavity overlap is specified as 30mm in the Robust Detail, but this minimum is not always achieved; even where it is adopted $0.45 \text{ m}^2\text{K/W}$ would be very difficult to achieve. A problem with specifying minimums (or maximums) is that it is these figures which are generally aimed for (and therefore often missed, rather than a better standard. Even if a resistance path of $0.45 \text{ m}^2\text{K/W}$ could be demonstrated with an uninsulated closure, the general level of thermal bridging at the sill and jamb is likely to be significant. The modelling phase of this research project will address this issue in assessing the thermal effect as well as condensation risk.
65. Not all sites adopted the propriety closure, some sites using glass or mineral fibre bats wedged into the jamb cavity to be held in place by the window frame as illustrated in figures 3.37 and 3.38 – although from time to time the result was not very pretty. On one site an apparently idiosyncratic mixture of propriety cavity closer and return block was used in the same construction. This is shown in figure 3.39. In this case a well insulated closer was used for the window reveals (a point we discuss below) but in the case of the connected door opening a return block with a rather thin (about 10mm) and ill fitting insulated vertical dpc was used. The impact of the return block is to bypass the partial-fill insulation, resulting in a thermal bridge, the insulated dpc not withstanding.

¹ The use of a resistance path calculation to determine the extent of thermal bridging is referred to in the 1995 edition of The Building Regulations Approved Document L – Appendix D (based on BRE IP 12/94 - Ward, 1994). This approach is not used in the 2002 edition but refers to Robust Details, which make reference to the method.



Figures 3.37 and 3.38 Alternatives to proprietary cavity closers.

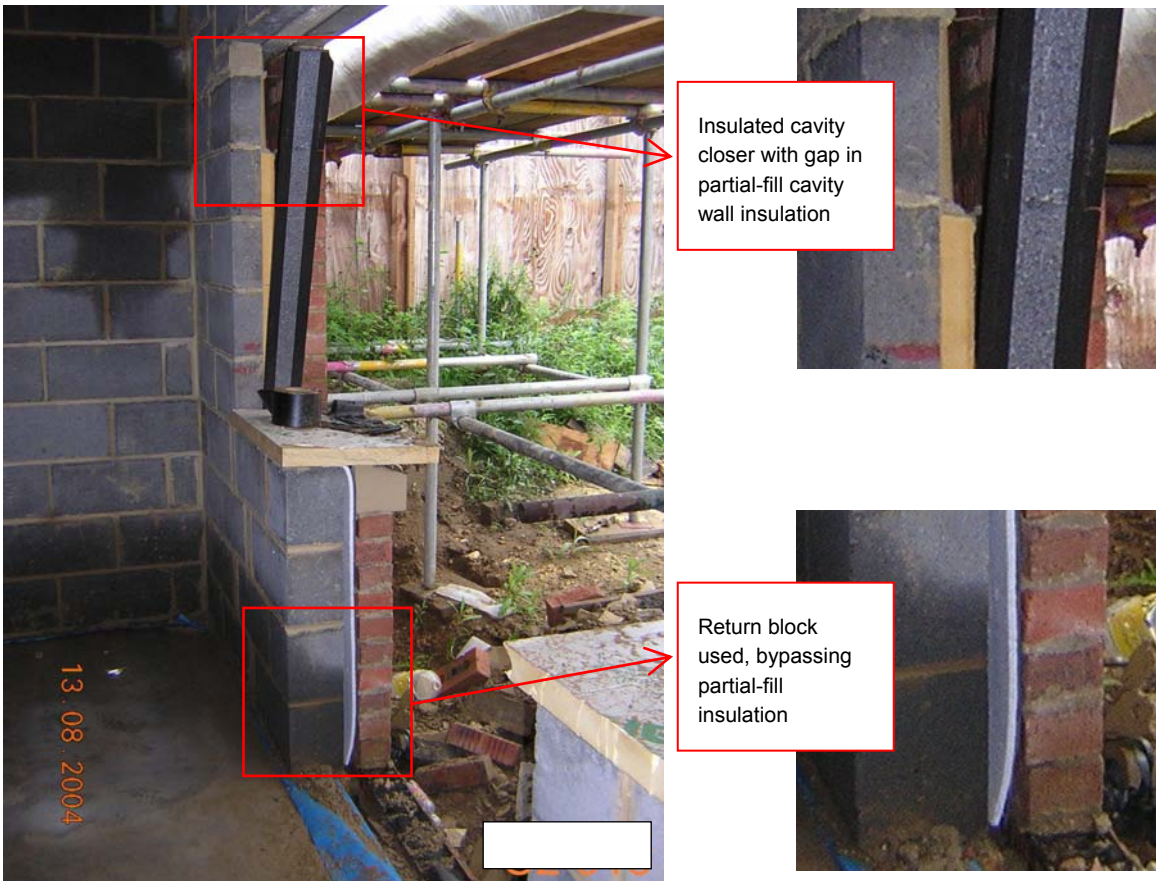

Figure 3.39 Inconsistencies in cavity closure detailing.

66. At a more general level the observations relating to cavity closures raises some questions relating to the development of Robust Details using such closures. From the point of view of design robustness the use of the resistance path concept based on data relating to the closure only is, at the very least, ambiguous since the resistance path depends not only on the characteristics of the closure but also on the location of the

window frame. The calculations involved are highly detailed and there is no evidence from the design material examined that designers gave the problem any consideration at all. Rather, there appears to be a general acceptance that uninsulated closures are adequate. This calls into question the use of the concept but even if the concept were to be retained in further editions of Robust Details, some thought would need to be given to the threshold value for both condensation risk and thermal performance. The value of $0.45 \text{ m}^2\text{K/W}$ is the value adopted for the 1995 edition of the ADL when wall U values were $0.45 \text{ W/m}^2\text{K}$. Yet as U values fall the significance of bridging increases and one would have expected that Robust Details would have increased the resistance path threshold to accommodate this. As U values fall, further increases in the threshold, or a more fundamental change in the way thermal bridging is dealt with, will be necessary. It is interesting to note that in the review of Part L for 2005 the proposal to include a significantly more rigorous approach to thermal bridging in the Approved Documents and in a revised Standard Assessment Procedure (see draft SAP 2005 – Anderson 2004) may reduce the incidence of this kind of problem.

Cavity fill around openings

67. The problem of ensuring that full-fill cavities are completely filled with insulation and that partial-fill insulation bats are fitted with no gaps has been generally recognised for some years. The observations in the cases studies provide a number of examples of this problem, particularly around window openings. Figures 3.40 and 3.41 show a fully filled cavity in which the filling work has been completed before the internal blockwork had been completed to sill level. This appeared to be a reasonably common occurrence and although it was not possible to ascertain whether insulation bats were placed in the cavity as blockwork was built up to the sill, it is likely that, at least in some cases, the additional insulation would be missed out. This would lead to increased thermal bridging and, depending on the thermal properties of the internal blockwork, increased risk of surface condensation problems.



Figures 3.40 and 3.41 Blown fibre, full-fill cavity wall insulation at incomplete sills

68. A similar problem was observed in a number of cases involving partial fill. Figures 3.42 and 3.43 illustrate a window jamb arrangement in which a gap of some 50mm between the cavity closure and the partial-fill cavity insulation was observed. A similar problem was shown in Figure 3.39. In other cases partial fill was loosely fitted and combined with other problems, such as mortar build up on cavity trays, to reduce thermal performance and increase not only condensation risk but also other moisture problems (see figure 3.44). Over all, this type of problem was recorded in 5 out of the 12 masonry cavity sites visited and, since we did not have access to open construction at window and door reveals on all sites, the number of observations may be an underestimate of the frequency of occurrence.



Figure 3.42 Gap observed between cavity closer and partial-fill cavity wall insulation.

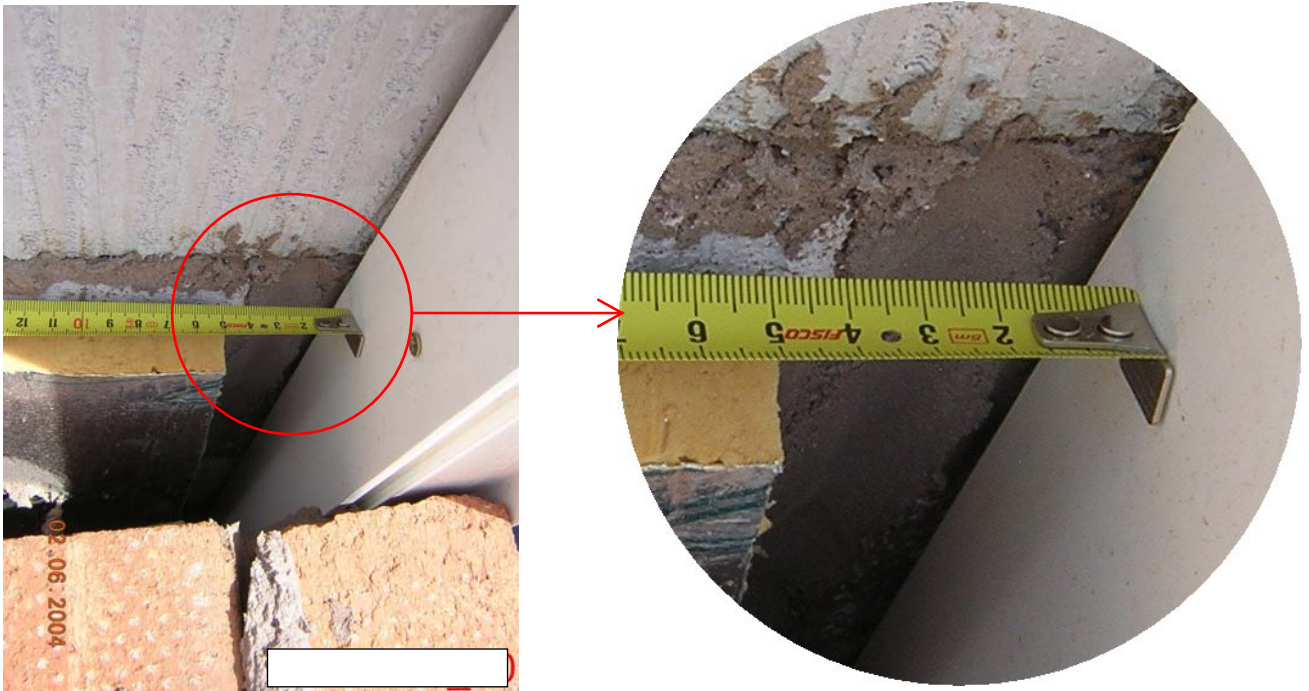

Figure 3.43 Up to 50mm of uninsulated area around jambs and reveals, causing potential thermal bridging problems.



Figure 3.44 Partial-fill cavity insulation – gaps and mortar build-up on cavity tray.

Location of window and door frames

69. The location of the frame with respect to an insulation layer is an important determinant of the extent of thermal bridging, even in otherwise well designed, bridge-minimised, reveals. This point is well illustrated by an analysis of frame location (Roberts, 2004) in the context of a low energy housing scheme (Lowe and Bell, 2002). Figure 3.45 shows the thermal analysis of a head detail produced for one of the house types in the scheme. In its original form the detail adopted the practice advocated by Robust Details (e.g. RD 3.12 figure 3.46) of ensuring a minimum of a 30mm overlap between frame and closer layer. The construction was; 105mm brick – 150mm fully filled (mineral fibre) cavity – 100mm medium density block; separate lintels are used and insulation taken to the back of a liner board so that bridging at the reveal is minimised and the frame set to give a 35mm offset from the front face of the external brick work¹. Given a frame depth of 100mm this resulted in the minimum 30mm overlap required by Robust Details.

¹ Although it is indicative of reality, figure 3.45 is essentially a simplified model produced for illustrative purposes. The insulation is assumed to completely fill all cavity voids consistently throughout this simulation. As this model discounts any hydration effects, the cavity tray provides a relatively insubstantial thermal influence and for the purpose of this simulation has been omitted to aid clarity.

window frame was an improvement in overall wall U value (including thermal bridging) of about 13% (from 0.3 W/m²K to 0.26 W/m²K).

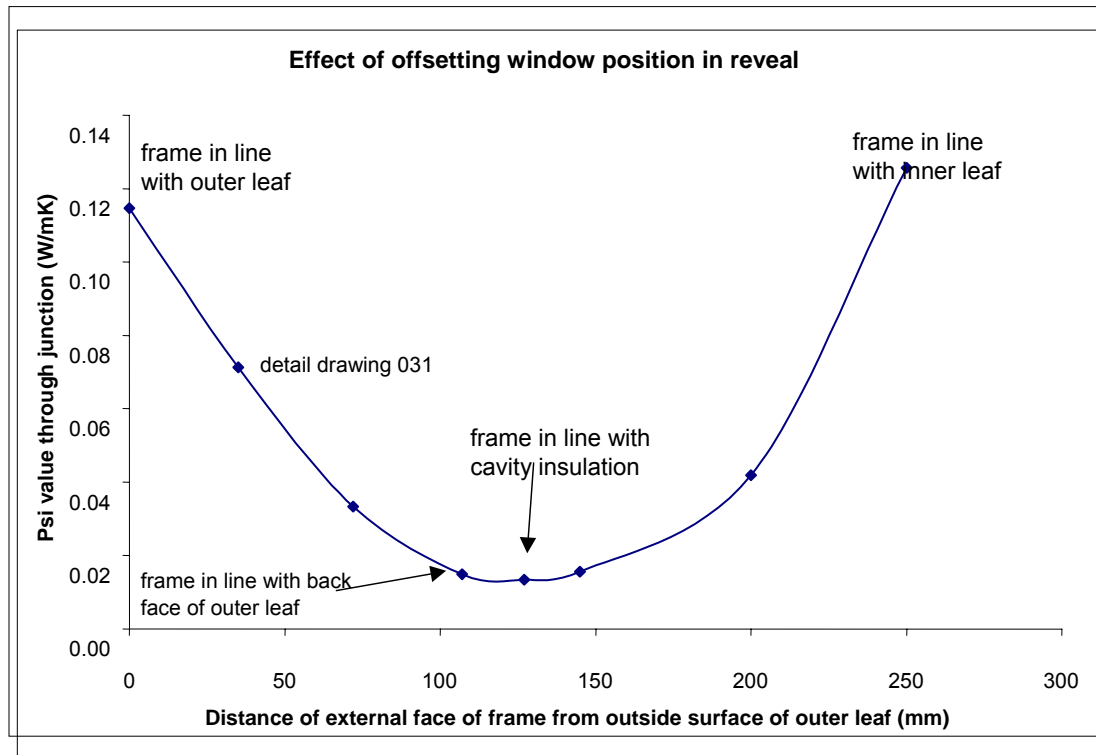

Figure 3.47 Effect of offsetting window position in reveal on Ψ (psi) value of head junction. (source Roberts, 2004)

71. Although design drawings, where sufficiently detailed, tended to adhere to the recommendations of Robust Details, site observations suggested practice that was a little more variable with instances of inadequate overlap distances being observed on 5 out of 10 masonry sites where window openings were observed in detail. Where windows are placed in main wall sections, overlap distances of 30 mm were more likely to be achieved than in the case of bay windows. These situations gave rise to particular concern. The more so because they are not explicitly included in the Robust Details document. Figures 3.48 and 3.49 illustrate a typical arrangement in which, having constructed the wall of the bay window, the bay window frame is put into position and secured to the outside leaf of the main wall with reveal straps. This results in the sill being positioned on the outside leaf with very little or no overlap of the frame with the insulation layer at all. This arrangement must occur also at the window head if the bay continues for another storey. No insulating reveals were stated to be intended, but there was insufficient tolerance to be able to apply a significant insulating layer. The bridging in these locations is likely to be very large with a considerable risk of surface condensation adjacent to the window frames in all areas but particularly at the jamb and head.



Figures 3.48 and 3.49 No overlap of insulation layer at a bay window.

72. Problems of window location and insulation at cavity closures were observed also in steel frame construction. Figure 3.50 shows a door frame set forward of the external insulation layer by about 40mm. Although the insulation is fully taped, as recommended by RD 7.06, the fact that the cavity closure has been pushed well back in to the cavity creates a discontinuity of insulation. This, together with the location of the frame significantly reduces the resistance path from inside to outside. In addition, unless an air/vapour control layer is introduced in the jamb the detail will reduce overall airtightness.

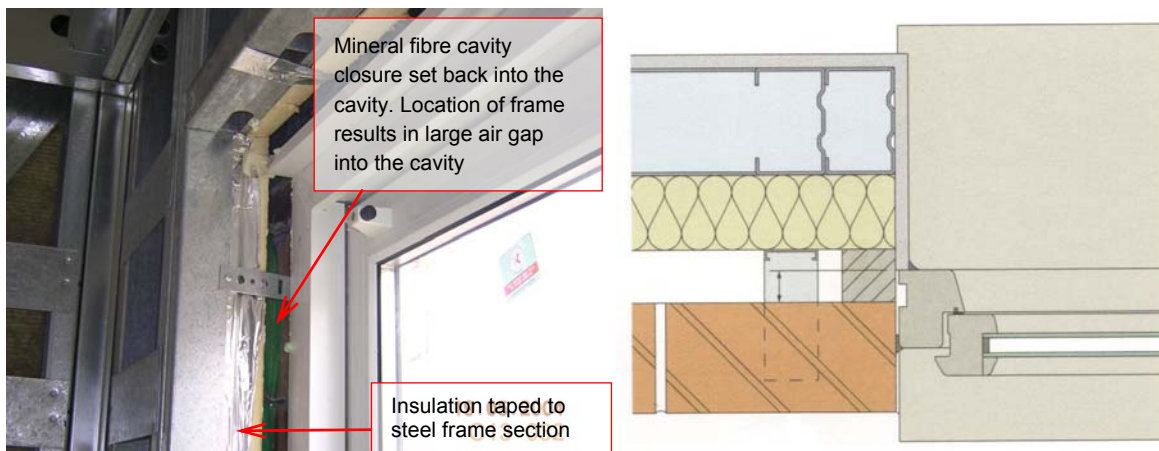

Figure 3.50 Door opening in steel frame construction (as constructed) compared with robust detail 7.06.

Room-in-the-roof details

73. Following the publication, in the last six or seven years, of government planning policies designed to increase housing densities, the mix of house types has included many more three and four storey forms usually terraces, flats and semi-detached. This has led to an

increase in the use of pitched roof spaces to provide habitable volume and of the 16 sites visited some 10 sites had dwelling types with habitable space in the roof. Generally, the use of a pitched roof space is geometrically more complex than in other parts of the structure, involving roof lights and dormer windows together with different approaches to providing insulation (eg insulation above the rafters, insulation between the rafters with ventilated battens over, insulation below the rafters) in addition to any different elemental U value standards. Achieving well sealed, bridge free construction presents both designer and constructor with a considerable challenge as they seek to deal with awkward junctions involving changes in level, changes of material and varying thickness of base constructions as well as the different angles involved. Despite these complexities the design drawings made available to the research team (and those observed to be in use by operatives) contained few details as to how these areas were to be treated. For example, only one developer provided a large scale detail of construction and fitting of roof windows (a copy of the manufacturer's standard detail). In other cases operatives were using general arrangement drawings.

74. In attempting to unpick the difficulties for room-in-the-roof construction and observations of construction practice we have identified the following general areas for consideration:
- Construction of the main roof structure and fabric;
 - Detailing at eaves;
 - Detailing around rooflights;
 - Construction of dormer windows.

Main roof structure and fabric

75. The fitting of insulation, particularly when rigid boards were used, was the most common general problem observed, together with the lack of air/vapour control layers in sloping roof sections. Many of the problems were accentuated around roof lights and dormers and the particular difficulties in these areas will be dealt with in those sub sections. The constructions that are most unforgiving if insulation is not tightly fitted tend to be those that adopt a ventilated rafter void with all the insulation fixed between the rafters. Figure 3.51 shows a typical arrangement with 70mm (sometimes as 2 layers of 35mm) polyurethane foam board fixed between rafters, plywood racking board and 12mm plasterboard finish¹. Problems arise with this form of construction where there is no air barrier, or where the air barrier is discontinuous, particularly since gaps around the insulation boards are common, many of which can be large (see figure 3.52).

¹ This construction would give a U value of around 0.3 W/m²K and although this would not comply with ADL1 elemental method it is within the limiting U values (0.35 W/m²K for parts of the roof) and, it is assumed that the designer has adopted the target U value method with compensation provided elsewhere in the thermal envelope.



Figure 3.51 Ventilated rafter void all insulation between rafters.



Figure 3.52 Gaps around insulation boards between rafters.

76. From the point of view of condensation the ventilated rafter void reduces the risk considerably, but if insulation gaps are large, particularly if coupled with additional thermal bridging surface condensation risk may be increased. Figure 3.53 illustrates one such area where the gap left between the edge rafter and gable wall not only produced a thermal bridge because of the cavity but also combines with the structural thermal bridge through the brickwork which forms the outer skin of the main house external wall. In addition, the lack of an air barrier exacerbates the problem because it not only reduces the general airtightness of the envelope but also allows air flow around the insulation boards, resulting in reduced thermal performance.



Figure 3.53 Gap in insulation adjacent to gable wall and structural thermal bridge (arrows).

77. An alternative ventilated rafter construction is illustrated in figures 3.54 and 3.55. In this case the construction is a little more forgiving in that the insulated lining will reduce bridging through the timbers and any associated gaps (although on this site the fitting of insulation boards was of very high quality). The lack of an air barrier may remain a problem but with racking ply in place (if used instead of alternative bracing) and taped joints a reasonable air and vapour barrier could be achieved. No taping of joints of roof insulation was observed on any site.

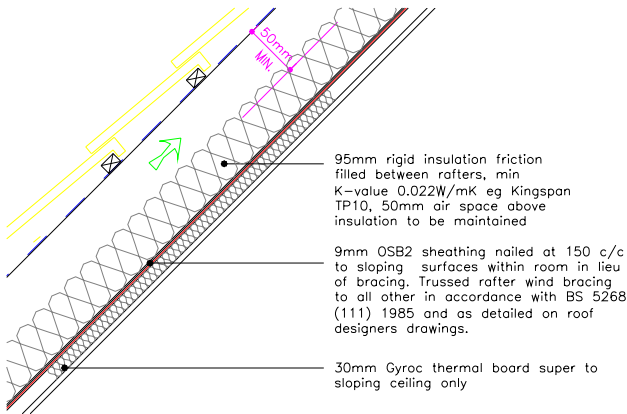

Figure 3.54 Ventilated rafter void with insulation between and under rafters.



Figure 3.55 Insulation prior to fitting of insulated lining.

78. In the room-in-the-roof structures encountered, steel purlins were a common feature used as part of a composite type construction with rafters at the lower level and trusses above to complete the roof pitch. Given the high conductivity of steel, insulation detailing around the purlins is critical. This arrangement can be seen in figure 3.51. Figure 3.56 illustrates the key features of the apparent design of the purlin and surrounding construction. In the design illustrated the ceiling level provided the space for the area under the purlin to be reasonably well insulated but if the insulation was installed from above, as would be the case with the main loft, it would be very difficult to place. It could be placed from below, as the plasterboard ceiling is installed, but the general observations during site visits would suggest that such small areas of insulation are often overlooked. Unfortunately no direct observations were made of either ceiling erection or of loft insulating so it is not possible to be certain of the final state in the dwellings surveyed but the detail remains vulnerable. In another case however, it is clear that if constructed as designed (see figure 3.57) a very real condensation risk would exist¹.

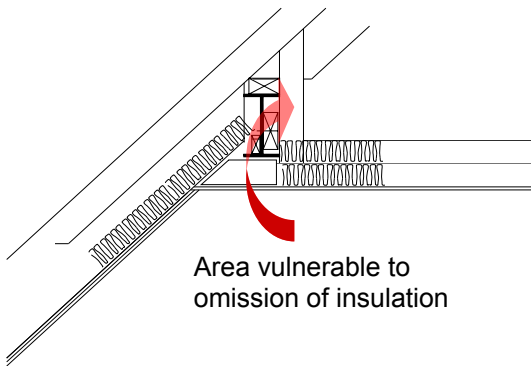

Figure 3.56 Steel purlin design - vulnerable to poor insulation placement and potential condensation risk².

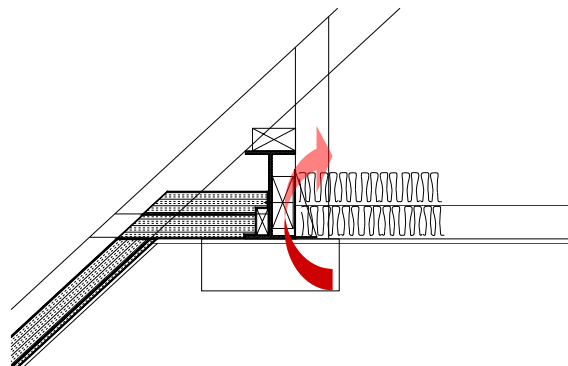

Figure 3.57 Steel purlin design – significant thermal bridge and high condensation risk³.

¹ In passing, this particular thermal bridge appears to be the largest, in terms of contribution to fabric heat loss, to be featured in this report. A rough calculation suggests that the additional heat loss is of a similar order to the heat loss through the fenestration, and effectively doubles the heat loss through the roof.

² Construction in this figure is based on site observation, no detailed drawings were available

³ Construction extracted from design drawings.

Detailing at eaves

79. Maintaining the continuity of insulation at eaves was achieved in a reasonable number of cases where observation was possible. Figure 3.58 is typical of the arrangement in cavity masonry sites and figure 3.55 shows the care taken to fill small gaps at the eaves junction on one of the timber frame sites. However, concerns remain about the level of detailing in relation to airtightness since eaves junctions had little provision for air sealing. The arrangement shown in figure 3.58 is likely to be particularly leaky since the roof wall junction is likely to remain unfinished as the eaves area forms a void useable for loft type storage only. This is not the case in the timber frame example shown in figure 3.55 and as far as can be established this detail follows the recommended robust eaves detail for this type of roof (RD 6.03). However airtightness remains a problem.
80. The robust detail is reproduced in Figure 3.59. The only resistance to air flow within and through the inter-floor space is the mineral wool packing. This raises two key problems; first, this space is very difficult to inspect and vulnerable to insulation being omitted¹ and second, if insulation was placed, achieving a significant resistance to air flow is fraught with difficulties even if it could be shown that tight packing is able to achieve the air flow resistance required. The configuration in the case of a ventilated rafter void is particularly prone to the inducement of air flow, not only through the rafter void, as intended, but also through the floor void from eaves to eaves. The likely condensation risk at eaves may be increased as moist internal air and vapour travelling through the floor void condenses on the underside of the roofing felt or the propriety roof vent with consequent wetting of any insulation, the top of the timber frame and rafter or joist ends.



Figure 3.58 Cavity wall – roof junction.

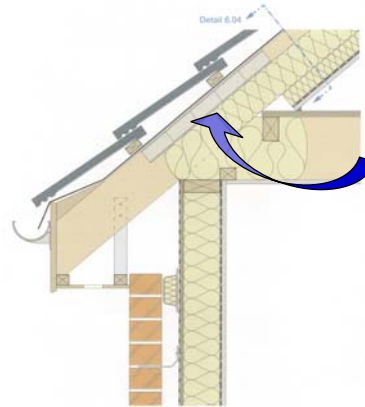

Figure 3.59 Robust Detail 6.03 – timber frame wall – roof junction.

Detailing around rooflights

81. Rooflight manufacturers' technical details generally include the use of their own fixtures and fittings; however, site observations have shown that although external fittings and flashings are often obtained from the manufacturers, the internal linings and finishings seen in this study were all manufactured on site rather than purchased 'pre-formed'. From a thermal performance point of view, the evolution of rooflight design has resulted in a less than optimal placement of the frame. Figure 3.60 shows the main framing of a rooflight set above the level of the insulation layer². In order to minimise thermal bridging

¹ As with other small, awkward areas of insulation it would have to be filled at the same time as some other operation such as fitting the ceiling or the floor rather than during the general insulation process.

² Note our comments in the window section above concerning the placement of window and door frames with respect to the insulation layer.

and reduce the risk of surface condensation around the rooflight frame, the fitting of insulation around the structural opening and up to the frame edge requires particular care both in design and construction. Robust Detail 8.03 (see figure 3.61), demonstrates the insulation detailing required.



Figure 3.60 Rooflight fixed above external insulation to rafters.

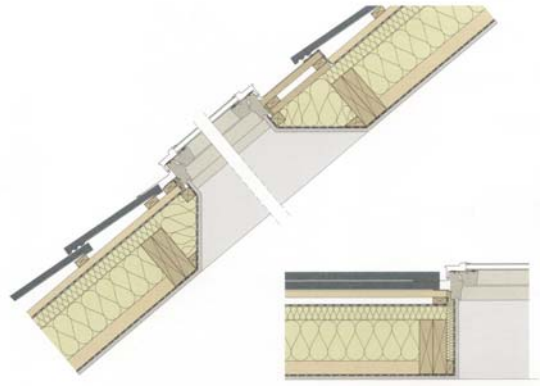

Figure 3.61 Robust Detail 8.03 – Rooflight detail (ventilated batten void).

82. Although, as with other site observations, it is hard to know for certain if defects will be identified and rectified by site quality control, the observations made during visits suggested that the insertion of small strips of insulation and the accurate cutting of boards around rooflight openings was not always done with the level of care required. Figure 3.62 shows a typical gap in external insulation and figure 3.63 shows a framing board at the “sill” of the rooflight, which, when investigated proved to have no insulation in the space behind nor evidence of an air/vapour barrier. This would certainly give rise to airtightness problems and poor thermal performance, both of which may lead to increased condensation risk. A number of observations of the space available for lining insulation to the sides of rooflight openings suggested that achieving the required resistance ($R \geq 0.34 \text{ m}^2\text{K/W}$) would be difficult especially if decorative linings were also to be applied. As a general observation missing insulation (particularly when small strips are required) around roof lights was a common occurrence on most sites.



Figure 3.62 Gaps in external insulation around



Figure 3.63 Lower lining section, uninsulated

rooflight.

behind.

Construction of dormer windows

83. Most of the dormer windows observed were of traditional timber constructed with pitched roofs or barrel roofs using a preformed plastic shell supported by timber framing. Dormer sides were framed in 100mm x 50mm timber with an external plywood skin, insulation (mainly polyurethane board) and plasterboard finish. As with the main roof slopes vapour control layers were not always used¹ nor were joints between the boards and framing timber taped. The U value of many dormer sides, as designed, were often higher than 0.35 W/m²K, 100mm of mineral wool was frequently specified, which even with a value of thermal conductivity for mineral fibre as low as 0.036 W/mK would require some 115mm². In practice polyurethane foam board was often substituted, although installed thicknesses seemed to vary between 35mm and 70 mm.



Figure 3.64 Small triangle of external wall difficult to fill with insulation.

84. As in other cases the main problems related to the fitting of the insulation board. Figures 3.65 and 3.66 illustrate typical fitting problems with gaps around boards and missing insulation in small sections, sections that can be very small indeed requiring considerable attention to detail (see figure 3.64). The missing insulation in the corner section (figure 3.66) is of particular concern since this is one of the most exposed areas of the external envelope.

¹ Anecdotally it would appear that when PU foam boards are used there seems to be a belief that they provide their own vapour control and that no additional layer is required. When mineral fibre insulation was used vapour control layers were almost always applied. Although it is true that PU foam board has high vapour resistance, the gaps around the boards will allow vapour and moist air to reach the cold outer skin with increased condensation risk. The rigidity and incompressibility of PU ensures that unless great care is taken in installing it, where it is fitted between structural members, gaps are almost inevitable.

² As with the sloping sections of the roof, compliance by the target U value method would enable compensation, particularly since dormer sides constitute a very small proportion of the total thermal envelope.



Figure 3.65 Irregular fitting of 35mm insulation boards.



Figure 3.66 Omission of insulation at small strip in the corner.

Insulating around cavity trays

85. Cavities are inevitably bridged for various reasons. Cavity trays are used in construction wherever cavities are bridged, for instance at window and door heads, bay windows, canopies and other projections. The purpose of the tray is to ensure that moisture running down the cavity is drained away to the outside. However, in walls where insulation is placed in the cavity or fixed to the external face of a steel or timber frame it is important to maintain the continuity of the insulation above and below the bridge and details designed accordingly. Our site observations revealed that there were a number of situations where continuity of insulation layers and of air/vapour barriers were likely to be compromised if insufficient care was not taken in construction. Two problem areas were identified at cavity bridges during the review of design and construction:

- cavity trays over gas barriers, and
- bay windows, extensions and other projections

Cavity trays over gas barriers

86. Gas barriers across the external wall cavities are common for contaminated sites, and green-field sites that contain naturally occurring gases such as methane or radon. Since such membranes necessarily bridge the cavity, a low level cavity tray is required. In some of the cases studied the detailing problems had been considered at design stage and dealt with reasonably successfully but in others the details were worked out on site (possibly because the need for a gas barrier was not discovered until after construction had begun) with less success. The particular problem in relation to gas barriers is the fact that the cavity tray has to be placed very close to ground level leading to problems of insulating a very small strip of wall.

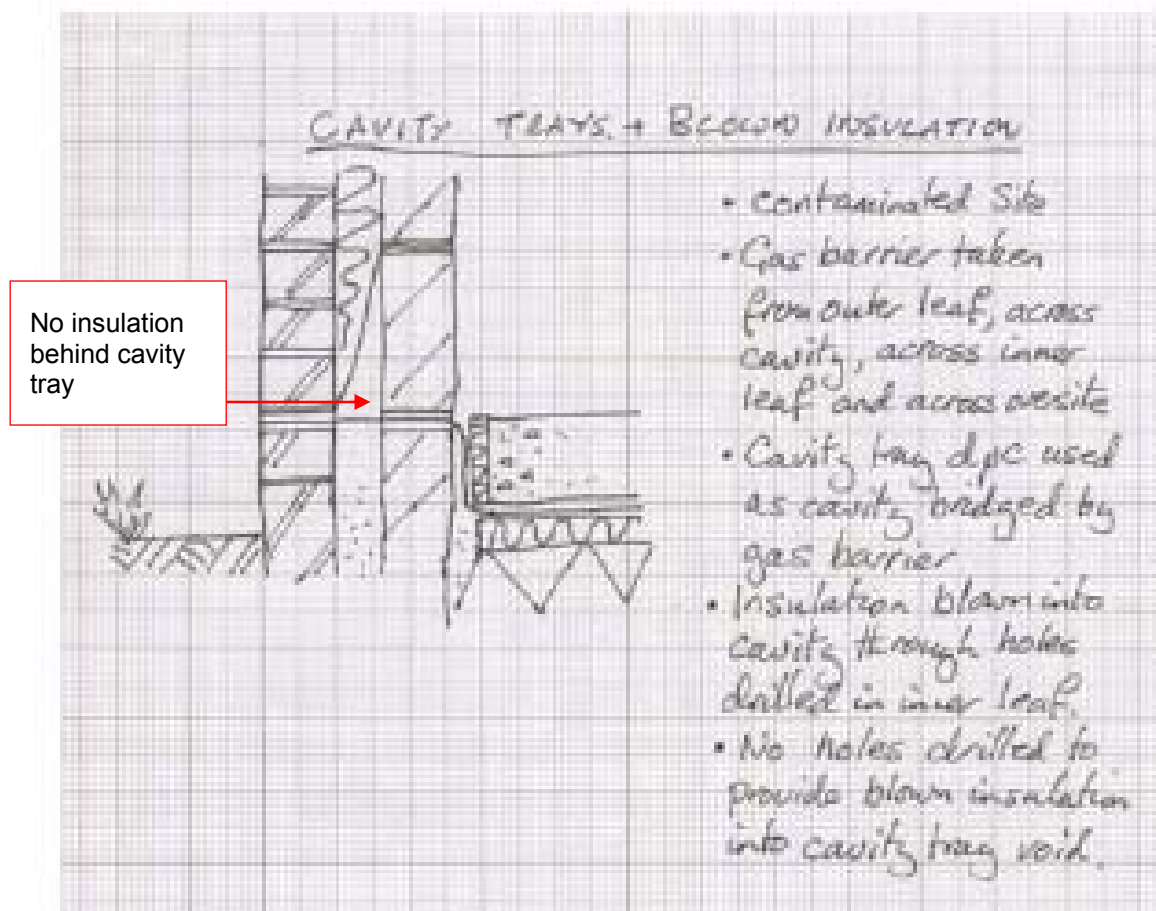

Figure 3.67 Gas barrier and cavity tray at ground floor/external wall junction.

87. The site sketch in Figure 3.67 illustrates the arrangement on one of the full-fill masonry sites. Given that cavity insulation was to be injected from the inside upon completion of the wall, filling this area would be very difficult and, in practice almost certainly omitted. In this case it would be more appropriate to ensure that insulation was placed at the same time as the cavity tray was fitted. Figure 3.68 shows clearly that this was not done, as well as illustrating the age-old problem of keeping the cavity clean. Similar difficulties arise with the placement of partial-fill insulation (see figure 3.69) since if not well fitted below the tray its performance is reduced considerably, almost to the point where it may as well not be placed at all. The effect in both the cases illustrated would be to increase the potential for localised temperature variation, the more so since, as we have discussed above, cavity insulation is often omitted at ground floor slab level. Of course, once the gas barrier is in place the lack of insulation below is hidden from view.



Figure 3.68 Injected insulation unlikely behind cavity tray. Mortar droppings will impair performance.



Figure 3.69 Partial fill insulation displaced by cavity tray resulting in gaps around insulation.

Bay windows and other projections

88. The site sketch in figure 3.70 shows a typical arrangement of lintel and cavity tray at bay windows and other projections. In the case of injected full-fill cavity insulation, filling the space below the can be difficult, particularly if there are restrictions such as floor joists. As in the case of cavity trays at gas barriers, placing insulation below the tray as the wall is built would be the only way of reliably avoiding this problem but there was little evidence on full-fill masonry sites that this approach was adopted. Similarly, observations of fill holes indicated that, in a number of cases injection had not taken place below trays. The problem can also manifest itself in partial-fill cavity masonry if access to the space below the tray is restricted; however in this type of construction the problem is more likely to be one of quality of fit rather than omission.

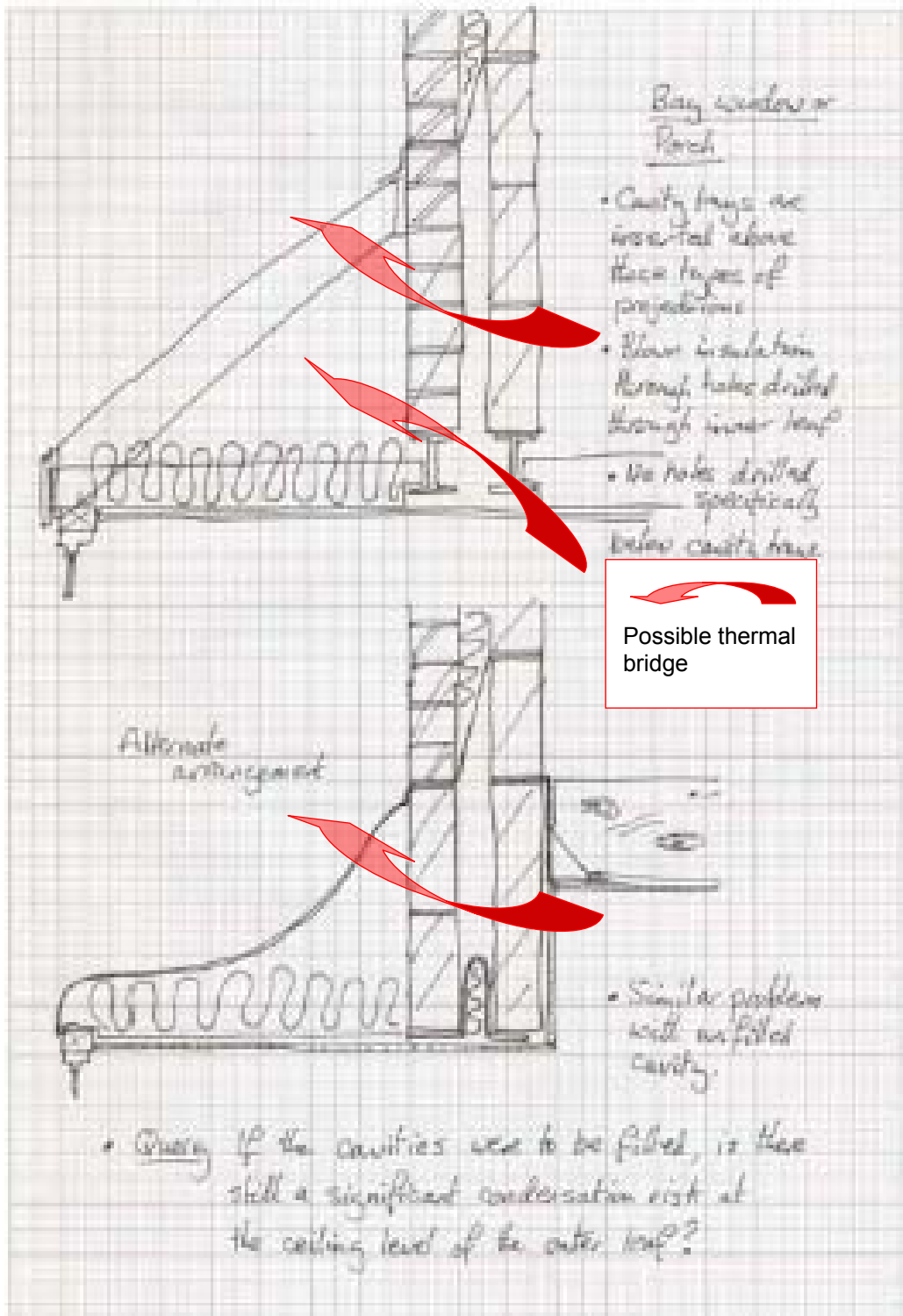

Figure 3.70 Cavity tray arrangements at projections.

Steelwork

89. Where loads are high, the steel work required is often substantial and insulated lintels are not suitable (top sketch in Figure 3.70). Although there are concerns that insulated combination lintels are either unsuitable or ineffective¹, of greater concern is the detailing around larger steel sections. Some of these concerns were raised in the context of room-in-the-roof constructions. The Robust Details document gives no guidance on detailing around structural steel and the analysis of design and construction would suggest that the design issues are not well understood. Unless additional insulation were provided at ceiling level across the flanges of the steel beams, the arrangement of the steel work in the top sketch in figure 3.70 and the would give rise to increased condensation risk even if cavity insulation was in place. Similarly, detailing around the steel work in the photograph in figure 3.71 presents a considerable detail design challenge².



Figure 3.71 Steel work at large openings.

90. Figure 3.72 shows a different arrangement where the thermal bridge is, perhaps less obvious. In this case the ground floor “projection” fits between two flanking walls. However the flanking walls do not extend to the foundations but, in order to create a large unobstructed space below, they are supported by steel sections within the first floor void. The internal view of the construction in figure 3.73 shows the steel beam with some insulation between the flanges and the sloping roof with insulation at rafter level. Although this may seem like a reasonable detail, due to the fact that there is no insulation below and around the steel (as opposed to between the flanges) considerable heat loss would be expected into the brickwork above resulting in a relatively low surface temperature of the flange and increased condensation risk. Since steel has a very low thermal resistance the insulation between the flanges has almost no effect on heat flow or the surface temperature of the lower flange.

¹ Robust details considers insulated combination lintels to be acceptable even though it is possible to show that the insulation has a very small effect and the high conductivity of the steel results in a significant thermal bridge.

² It is unfortunate that no large scale detail was available for this example.



Figures 3.72 and 3.73 Thermal bridging through structural steel in first floor space.

Timber panel construction

91. Although many of the problems already identified have manifested themselves in most types of construction our observations of timber frame construction indicate the need for more attention to be given to the placement of insulation and to the high concentrations of through timber in many frame designs.

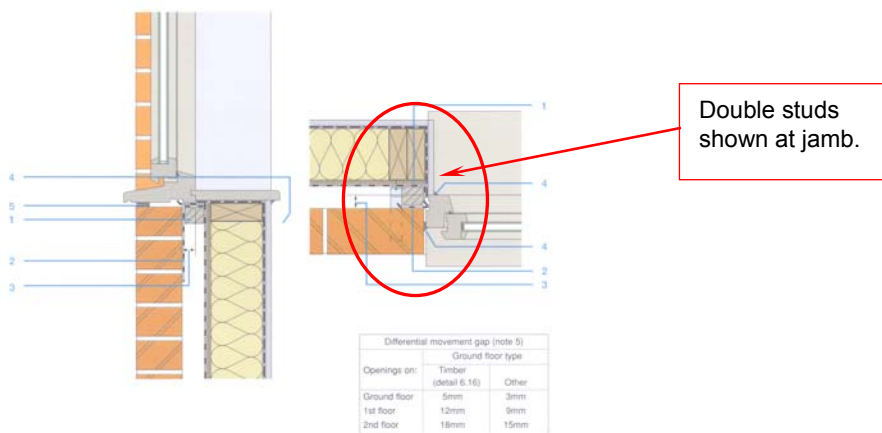

Figure 3.74 Robust Detail 6.10; Jamb and sill details in timber frame construction.

92. Thermal bridging in timber frame walls is often allowed for by specifying an appropriate timber fraction in the calculation of U values¹. However the timber fractions used in the calculations often underestimate the amount of timber present (Bell and Overend 2001). Similarly, the impacts of the concentrations of timber that occur around openings and at areas of point loading in the structure have not been extensively analysed from the point of view of thermal and moisture performance. The highest concentration of timber (studs or head/sole plates) shown in any of the details in section 6 (timber frame) of the Robust Details document, is a doubling of the relevant timber section. This can be seen in figure 3.74, showing the double stud at a door or window jamb (RD 6.10). In practice, timber concentrations at openings and other areas where structural strengthening is provided (not all of which are structurally efficient) can be much higher than shown in the Robust Details document. Figures 3.75 and 3.76 show examples of timber concentrations ranging from 6 studs adjacent to and below a window opening to a corner arrangement that includes 11 studs supporting the double I-beams above.

¹ This is done using the combined areas method as set out in BS EN ISO 6946: 1997



Figure 3.75 High timber concentration at window jamb.



Figure 3.76 High timber concentration at corner post.

93. Other examples include difficulties at corners in general and at other junctions. Figures 3.77 and 3.78 show a particular instance where timber detailing has ignored the thermal performance of the junction. The sketch (figure 3.78) not only indicates the amount of timber but also the small gap in the framing that would require assiduous attention to detail on site if it were to be filled. The existence of such small strips where insulation is omitted is something that was observed time and time again, figures 3.79 and 3.80 are typical examples. The impact of such air gaps may be considerable since the resistance of the cavity is about three times less than that of an equivalent section of timber and many times less than that provided by insulation.



Figure 3.77 High timber concentration at opening to balcony.

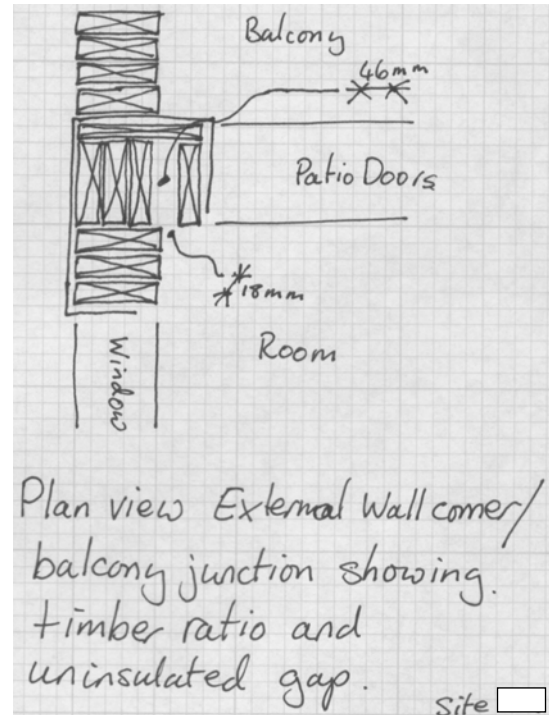

Figure 3.78 High timber concentration at opening to balcony.

94. This issue seems to have been given little attention by the timber frame industry. Given that the housing designer and constructor is bound to rely on the detailed design and erection expertise provided by timber frame suppliers, this is not a problem that can be addressed by developers alone. Further editions of Part L Robust Standard Details should seek to address the design implications in terms of reducing the impact of the thermal bridge and the possible condensation risks involved.



Figure 3.79 Small gap between studs (also, note high timber concentration at corner).



Figure 3.80 Unfilled gap between studs.

Airtightness and vapour control

95. Although a number of comments have been made in other sections about airtightness and vapour control, this section seeks to deal with the issues in a more general way. The control of water vapour, either by diffusion or bulk air movement is crucial to the reduction of condensation risk (particularly interstitial condensation) and site observations sought to identify problems in this area. As expected, there were instances of both good and less good practice¹ but overall, the maintenance of continuity and the general integrity of vapour control layers, receives only moderate attention, particularly when it gets in the way of services, when damage occurs or when wrapping and sealing of sheet material around awkward three dimensional junctions is required². Three general issues were identified:

- Continuity of air/vapour control layers;
- Fitting of plasterboard linings in masonry construction;
- Sealing at services penetrations.

Continuity of air/vapour control layers

96. Areas where continuity of the air/vapour control layer is particularly vulnerable are behind baths, shower trays and kitchen units and in services voids. Figure 3.81 illustrates the construction of a services duct in a bathroom (timber frame dwelling) showing damage to the air/vapour control layer and internal lining to the services duct.

¹ This seemed to vary depending on the interests and priorities of the site manager

² It is tempting to suggest that all construction courses should include training in origami or parcel wrapping.



Figure 3.81 Damage to and displacement of the air/vapour control layer.

97. The sealing of the junction between wall and floor behind shower trays, baths and kitchen units is rarely done with the same degree of care as in other locations. This can be seen in Figures 3.82 and 3.83 where the internal plasterboard finish is stopped short of the floor (figure 3.82) or cut away to accommodate the fitting (figure 3.83). An air/vapour path is created which can be directly connected to the structural space. In timber frame constructions a polythene membrane is used which is lapped and stapled to the frame but where there is no plasterboard to hold the polythene air barrier tight back to the timber frame, an adequate seal is not achieved at floor level. The fact that these problems occur mainly out of sight behind the fittings in kitchens and bathrooms is of particular concern since these are areas of intermittently high vapour pressure. In warm steel frame construction, it could be argued that air movement, moist or otherwise, in the frame space is of little consequence since the condensation risk is small and a high level of airtightness is maintained as long as the external insulation layer is well fitted and all joints securely taped. This is, of course, a very reasonable position but it places considerable reliance on the integrity of the external layer. Although, on the two steel frame sites, considerable attention was given to insulation and sealing, as indicated in the ground and intermediate floor sections above, this can be compromised at junctions.



Figure 3.82 Plasterboard finish stopped short of the floor under kitchen fittings.



Figure 3.83 Plasterboard finish cut away to enable the shower tray to be inset, giving access to the structural space.

98. The maintenance of air/vapour control layers across intermediate floor spaces is given very little attention. The focus of Robust Details, in timber frame construction, is on sealing above and below the interstitial space. If one could rely on the integrity of the perimeter construction of the floor this would be a reasonable approach but there are difficulties in ensuring that the floor edge is sealed, particularly as it is often penetrated by services and, in the case of double joist arrangements of the type shown in figures 3.85 and 3.86 below, air would be allowed to circulate within the floor edge to escape at any weak point. On none of the timber frame sites studied was any attempt made to extend the air/vapour control layer into the floor space. Figure 3.87 shows the floor perimeter with insulation and air/vapour barrier in place below the floor space together with services penetrations into the external cavity. Evidence from the site visits suggests that very few of the services holes are likely to be sealed. Similar problems arise in all forms of construction (as observed in the intermediate floor section above) where there is a structural or services void that is likely to have air paths to outside air and are unlikely to be solved by seeking to seal around internal linings. If one applied the “pen on section” test¹ to many designs they would fail.



Figures 3.85 and 3.86 Holes in floor perimeter for electrical services.

99. In order to ensure continuity of air/vapour control layers in timber frame and hybrid steel frame constructions, section 8 of the Robust Details document recommends that sheet barriers be well lapped, returned into reveals at openings and sealed with the DPC at ground floor level. In general the lapping of sheets was done with care but no lapping with the DPC was observed on any site (figure 3.87 is typical) and sealing into reveals was not dealt with consistently. The arrangement at window and door openings was generally more consistent as in most cases membranes were wrapped into reveals, sills and heads and either stapled or taped (Figure 3.88).

¹ The “pen on section” test involves tracing the air barrier on any general section and being able to do a complete traverse of the section without lifting the pen from the paper. If the pen has to be raised there is a discontinuity in the barrier.



Figure 3.87 Air/vapour control layers not lapped to DPC¹.



Figure 3.88 Vapour control layer returned in to reveals and window/door heads.

100. Despite that fact that care was taken to ensure that air/vapour control layers in timber frame construction were well sealed there was some apparent uncertainty about parts of the structure that consists of isolated collections of studs or substantial timber lintels. Figure 3.89 presents a typical example, showing 5 studs forming the section between openings and the plaster-boarded window head with no evidence of any air/vapour control. It seems that since there is no adjacent insulation, air and vapour control is thought not to be required.

¹ Although good example of care taken at sealing of service penetration.



Figure 3.89 Air/vapour control layer not applied to studs – no evidence of layer across lintels and wrapping into head of opening.

101. An example of good practice in the use of the external insulation layer in partial fill masonry as an airtight layer is provided from observations made on one site where insulation was tightly fitted, clipped in place and all joints sealed with tape (figure 3.90), a practice that is likely to produce a reasonable level of airtight construction by using the insulation layer as an air control layer. However, as with steel frame construction this must be maintained at junctions if it is to be fully effective.



Figure 3.90 Fixing and sealing of partial cavity wall insulation in masonry construction.

Fitting of plasterboard linings in masonry construction

102. Although masonry construction is relatively robust from the point of view of interstitial condensation, as any moisture vapour is able to diffuse through the structure with little adverse effect, the practice of using plasterboard finishes results in relatively poor airtightness, with a consequent impact on thermal performance. It is possible also that moisture laden air within the construction may increase the risk of condensation problems around such things as steel lintels, particularly if insulation is poorly placed. The standard solution to minimising airtightness problems when using plasterboard linings has been to require that the air void behind the lining is isolated with a continuous ribbon of plaster adhesive around each exposed edge. This is the method recommended in section 8 of the RSD document¹. The evidence that such an approach is not generally applied has been mounting for some time and many believe that, in practice, it is almost impossible to achieve a reliable seal. Of the 10 masonry sites visited only one site had examples that appeared to have achieved a continuous ribbon. Figure 3.91 shows a typical arrangement at an opening, with the adhesive applied as dabs rather than a continuous ribbon and leaving an air void that can be as much as 20mm thick. The one case site that proved to be the exception is illustrated in figure 3.92.



Figure 3.91 Lack of continuity of plaster adhesive to plasterboard lining.

¹ The point is emphasised in section 8 of the Robust Details document when it states that “this is a key area of air infiltration and can seriously affect the overall ventilation rate.” (DEFRA, 2001, p 8.01).



Figure 3.92 Continuity of plaster adhesive - an unusual case.

Sealing at services and other penetrations

103. Although not likely to have significant condensation implications in all cases the care taken to ensure that service and other penetrations of the air/vapour control layer will have a major impact on the overall airtightness of the dwelling. The holes cut for services are often large and, as pressure tests demonstrate (see for example Johnston et al 2004) are not well sealed. The services penetrations shown in figures 3.93 and 3.94 are typical. Other penetrations such as those made by steel structural elements also need to be adequately sealed. The steel beam in figure 3.95 not only poses an airtightness problem but if not well insulated may pose an additional condensation risk.



Figure 3.93 Service penetrations through the insulation and air/vapour layers in roofs and walls.



Figure 3.94 Penetration through the insulation/vapour layers in light steel frame construction.



Figure 3.95 Penetration of timber frame wall by steelwork.

104. It is tempting in a project of this nature to emphasise the negative aspects of detailed construction, however a number of examples of attempts at a more careful approach have also been observed. Figure 3.96 shows a reasonable attempt to seal the services passing through the air/vapour barrier within timber framed construction. In this case a polythene backing membrane has been inserted behind the cable boxes, the polythene air barrier carefully cut for electrical boxes and pipes and the services generously taped to the main polythene air/vapour control layer. Although it would be more robust to have included a services void (as discussed below) this is, probably, the most practical solution in the circumstances although not very robust in the long term. The only air paths that have not been fully sealed is the cable entry into back-boxes and some leakage around the boxes themselves, the backing membrane not withstanding. This is an interesting example of how the principles in Robust Details, such as those expressed in section 8 of the Robust Details document, are being interpreted.



Figure 3.96 Sealing and taping of services entries in timber frame construction.

105. The detailing of sealing around service penetrations is covered in section 8 of the Robust Details document, but there is very little detailed guidance. Only one detail graphic is provided (RD 8.08) and this is little more than a general representation of the areas to be treated. In all cases of framed construction internal services were run within the structural space. This increases the vulnerability of the air/vapour control layer to damage and inadequate sealing. As we have observed, even where reasonable attempts at sealing are made it is rare to find a complete seal, particularly around electrical boxes. A more appropriate solution would be to include a dedicated services space on the inside of the air/vapour control layer. Such an approach would minimise penetrations reduce the possibility of insulation being disturbed (as discussed above) and facilitate the renewal or extension of services during the life of the dwelling without causing further damage and increased risk of condensation problems in 15 or 20 years time. Future editions of Robust Details should adopt a much more comprehensive and detailed approach to this problem.
106. Throughout the site observations various attempts at improving airtightness at services entries were noted but there appeared to be some uncertainty as to which services penetrations to seal. It was reasonably common to see sealing around entries into floor spaces such as illustrated by the soil pipe in figure 3.97 but observations of seals at the penetration of air/vapour barriers themselves were much rarer. It is suspected that the problem lies in the order of works. Since sealing work is left until close to completion, some of the important penetrations are inaccessible, such as those shown at intermediate floors (see figures 3.85 and 3.86) and therefore remain unlikely to be sealed; it is much easier to seal the entry into the floor but, possibly, a waste of time and effort. A much more certain approach is to ensure that holes are sealed as work proceeds and made to be part of the work of the services trade rather than a snagging item. The Robust Details document gives no guidance on process issues such as this nor does it distinguish clearly enough between penetrations of air/vapour barriers themselves and entries to secondary spaces such as floor and duct voids. In fact the detail provided (RD 8.08) tends to cloud the issue since it deals with sealing into lofts and services ducts only and as we have already noted (see comments on eaves detail above) other details do not always produce a full sealing option. Other statements provide a general exhortation to prevent air leakage at every penetration of air/vapour barriers.



Figure 3.97 Sealing around soil pipe – water pipe yet to be sealed?

CHAPTER 4 - Discussion, conclusions & selection of details for the modelling phase

107. In a project such as the one reported here there is a tendency to accentuate the negative aspects of construction. Indeed this is inevitable since it is through an analysis of problems and difficulties that we are able to define the extent of any improvements required to regulation and its associated guidance. In seeking to understand and place in perspective the results of the fieldwork it is important also to look beyond the specific observations and to avoid classifying them simply as “errors, defects or mistakes”. As far as possible we have sought to look at the data as symptoms of the more general issues and problems that the house building industry, its support network and its regulators need to understand and address. It is no use complaining that missing insulation is the fault of the insulation operative if no one else seems to care if it is missing and if the operative does not realise the significance of his or her actions. Like all general problems of quality management they are ones of system not of individual or developer culpability.
108. We have observed examples of good practice as well as the problem areas and where strong examples exist we have attempted to draw attention to them. It would be a misinterpretation of the results, therefore, to suggest that the requirements of Robust Details have not been applied. It is clear that some designers and some constructors are beginning to absorb the requirements and make them work effectively. Our main contention is that the problems observed have their basis not in the mistakes of any particular developer or individuals but in the fact that the industry as a whole is having to deal with issues and questions that have not been of particular importance hitherto. Developing the required level of understanding, knowledge and expertise is not likely to be achieved in the timescale since the introduction of the 2002 Part L details. During the course of the fieldwork it became increasingly obvious that the application of robust details has barely begun and that all parties still have a long way to go before house builders, designers and regulators are able to apply the requirements with the same level of expertise that are applied to other matters of construction such as structural integrity and fire prevention.

Prevalence of problems

109. The fieldwork has provided a large body of qualitative data on a range of design and construction issues following the implementation of Part L 2002 and its associated Robust Details. In order to place these data into context (at least for the 16 developments studied) a numerical analysis was undertaken of the prevalence of the key problem areas discussed in chapter 3. Table 4.1 lists, for each aspect, the number of sites where a problem was observed, set against the potential number for that type of problem, taking into account the stage of construction at the time of site visits as well as construction type. For example, if the problem were one relating to the first floor junction in timber frame construction, the potential was taken to be equal to the total number of timber frame sites that had reached first floor stage at the time of the site visits.
110. Although it must be acknowledged that the numerical analysis is relatively crude, the prevalence of many of the problems observed was high. For 16 of the 20 problem areas listed, the number of sites with defects, represented over half the potential. Table 4.1 shows that some problems were observed on only one site. Where this occurred they were included in the analysis only if it was clear that the observation was indicative of a general problem. The observations made of the flatness of a floor slab resulting in gaps under the sole plate of timber frame panels on one site, and the positioning of the steel frame on another was of this nature since, in both cases, general questions were raised about tolerance and fit between site built and factory manufactured elements. In contrast, where it was clear that a defect was the result of a one-off mistake leading to appropriate corrective action, they have not been included.

Limitations of the field study

111. This project was not set up as a comprehensive survey of UK house building production post the 2002 edition of Part L. To do this would have required a well controlled random sample involving many more sites than could be covered with the resources available. Rather, it sought to look qualitatively and in some detail at emerging design and construction practice on a small number of sites and at as wide a range of construction as possible. This meant that in the case of steel frame only 2 sites were involved. As a result it is not possible to claim that the findings are comprehensive or representative. However they provide considerable insights into some of the issues that need to be addressed by all those involved in the house building industry including regulators, developers, designers and constructors as well as those providing design and construction guidance. In addition to recognising the limitations of the study with respect to its comprehensiveness, it is important to be aware that the study was undertaken at a time when many designers, building control staff and constructors were dealing for the first time with the challenges presented by the revised Part L and the use of Robust Details¹. It is inevitable that problems and issues will emerge at this stage that may not occur when more experience is gained.
112. Important limitations concerning data collection must be recognised also. The process of gathering and recording data on the design and construction of any building will always involve judgement and interpretation. The research team were reliant on design material supplied by developers and although effort was put into checking that the material held in the design archive was the same as that used on site, detailed design changes were frequent and often done by site staff who are obliged to solve problems quickly based on, what may be described as, site design skills². As a result, some judgement was necessary in the interpretation of design material and site observations. The identification of design intent was made more difficult by the considerable variation in the level of detail available (as is clear from table 2.1 in chapter 2). In some cases it was necessary to determine design intent based on site observations alone.
113. At the level of detail necessary for this study, determining, with reasonable precision, the actual construction of completed details requires a mixture of detailed observation, analysis of design material and some interpretation of the likely final physical form (whatever the design drawings may show). In order to see inside the construction, the option of dismantling completed details was not available and judgement was required in the interpretation of photographic and other data taken from part completed details. Where significant uncertainties exist we have sought to point this out in the qualitative analysis, focusing the discussion on the potential for a defect to occur rather than seeking to predict the completed form in any particular case.

¹ It is also important to point out that the Robust Details document itself is in its first edition and has not been subject to any testing of its coverage or effectiveness as a guidance document.

² The ability to design “on the hoof” is a particularly high level skill and one that is not always appreciated.

Aspect of Construction	Issue/problem area	No. of sites where problem observed	Potential no. of Sites
Ground floor/wall junctions	Perimeter edge insulation missing in full or part, including at level thresholds	7	11
	Cavity insulation commences at/above upper surface of ground floor level or at dpc level	5	7
	Steel frame/slab positioning tolerances	2	2
	Timber frame/slab positioning tolerances	1	5
Intermediate floor/wall junctions	Perimeter floor insulation missing T/F	4	4
	Discontinuity of wall insulation S/F	2	2
	Built-in joists in masonry	5	10
Window and door openings	Inadequately insulated cavity at jambs, sills and heads	5	12
	Location of frames in relation to cavity insulation	4	10
Room in roof details	Adequacy of insulation fitting	5	7
	Detailing around rooflights	4	4
	Dormer windows and gables	3	4
Cavity trays	Over gas barriers insulation missing	5	8
	At projections (bay windows etc) thermal bridging	3	5
Balconies and extensions	Insulation at steelwork	4	6
	Wall thermal bridging	4	4
Timber panel construction	Timber ratio including at window heads	4	4
	Insulation missing in parts	2	4
Airtightness and vapour control	Fitting of plasterboard in masonry	3	4
	Sealing at service penetrations T/F & S/F	5	5

Table 4.1 Prevalence of problem areas

Summary of key findings

114. In presenting the summary of findings we have sought to tease out the important general issues that can be identified from the detailed analysis in chapter 3. Where appropriate, we have attempted to relate them to comments and observations made at the initial workshop.

Level of knowledge and understanding

115. The general level of knowledge and understanding relating to Robust Details and the principles of thermal bridging and airtightness they seek to embody, does not appear to be very high. This is evident not only from the design material available and the observations of construction but also from comments made by site personnel during site visits. Very few site staff claimed knowledge of the existence of Part L Robust Details and those who did recognise the term, linked it to those produced in support of Part E (sound). Where large scale details were produced there was a reasonable level of agreement with the Robust Details document but in other cases there was a strong tendency for drawings to show no detail at all and to use the term “robust details” as a statement of intent rather than design. It is tempting to suggest that such statements are merely a device for gaining regulatory approval rather than any real attempt to adopt the

- details themselves. In any event, such an approach does not inspire confidence in the general level of understanding among housing detail designers.
116. This general state of knowledge echoes comments made at the initial workshop where a strong need for education and training based around the requirements of Robust Details was recognised. This was felt to be a particular problem for site personnel. Participants generally agreed that very often the operative placing the insulation is in a position to have the greatest input on its effectiveness and almost always the least likely to be aware of the problems that may occur if it is not done correctly. Although the site observations supported this view very strongly, it was clear also that there was an equally strong need for the knowledge and understanding of designers and compliance regulators to be improved.

Design Communication

117. The way in which the requirements of Part L and Robust Details are communicated from designer to site operative would appear to be problematic on some of the developments studied. To some extent this may be a symptom of the general problem of knowledge and understanding and may reflect also the fact that the introduction of Robust Details is relatively recent. However, in a number of cases there seems to be a belief that details can be worked out on site or that highly detailed design material is not necessary. This approach may be reasonably efficient and one that is able to produce satisfactory results in a period when change is gradual, enabling craft knowledge to develop at the same pace but is unlikely to be satisfactory in periods of rapid change. The observations on this project suggest that much more needs to be done to improve communication to operatives, starting with the habitual use of large scale detailed design drawings.
118. More attention to design communication is required, not only from designer to constructor, but also between specialist and generalist designers, particularly of off-site manufactured components. This works both ways since the tolerance problems noted with respect to timber frame and steel frame would require frame designers to understand the limits of site construction tolerances as much as the frame installers, and constructors to improve the precision achieved on site. The reference made to Carlsson et al (1980) is an example of the type of solution that would need to be explored. Workshop participants also drew attention to the need to understand communication in the use of and, perhaps more to the point, the substitution of, pre-manufactured components and the tolerance problems that can arise.

Technical problems of design and construction

119. Chapter 3 sets out in some detail a wide range of specific problem areas that were observed and many of the key details are set out in table 4.1. In this summary we have attempted to step back from the specifics, and identify the general issues that they illustrate. At its most general, many of the problems observed result from a lack of attention to detail; from an apparent view that some of the detail does not matter all that much. For example, our observations of insulation placement would suggest a belief that if the right thickness of insulation is placed in the wall, it does not matter very much how it is placed or whether gaps are left. However, the revisions to Part L and the introduction of Robust Details (Part E as well as Part L) place much more emphasis than hither to on changing that view. The conclusions from the work done in this project would suggest that the following issues of detailed design and construction need to be addressed:
- The placement of insulation in all areas is often not fitted so as to avoid air circulation and short circuiting. The problems range from ill-fitting rigid boards and sagging quilt insulation to the disturbance of previously well-fitted insulation by services installations.
 - Gaps in the insulation layer, particularly around difficult details are common. This is particularly noticeable at floor junctions and around windows. However, even in the main areas of primary elements such as walls and roofs, insulation is omitted. In

general, where small gaps between structural elements exist (as in the case of timber frame studs) or around components such as roof windows, insulation is likely to be overlooked.

- The detailing of air and vapour control layers did not, in many cases, provide a continuous barrier. In timber frame developments air/vapour control layers were reasonably well placed in main wall sections but in certain areas (mainly at large lintels and isolated timber sections) the layer was omitted completely. The continuation of a barrier or adequate air/vapour sealing across intermediate floor voids was not evident in most forms of construction. Very few instances of air/vapour control layers in room-in-the-roof construction were observed and even when they were in place they were often discontinuous at the eaves.
 - The problems with the Robust Detail guidance on airtightness design were recognised at the initial workshop and largely borne out by the design and site observations. Guidance on the installation of masonry dry lining remains particularly problematic with both workshop participants and the fieldwork confirming the virtual impossibility of reliably providing a full ribbon of adhesive around boards.
 - Damage to or ill-fitting of air and vapour control layers was common with hidden areas behind bathroom and kitchen fittings and in services ducts giving rise to particular concerns given the relatively high vapour pressures in these areas. Damage was often the result of the installation of services, mainly as a result of a service passing through the primary element or because of services being run within a structural space, despite valiant efforts at sealing in some cases. Much more design thought is required in this area and the current approach, which could be described as “puncture and seal”, does not appear to be a particularly successful one.
 - Detailing around major structural elements such as large sections of timber and steel showed little understanding of the thermal bridging implications. Although not measured systematically, general timber fractions in timber frame panels were high and on most timber frame developments the structural design included some areas where multiple studs (often as many as 8 or 9) form a large timber column with no provision for the thermal bridging involved. The detailing implications of the very high conductivity of steel do not seem to be clearly understood particularly in roof construction and at one or two storey projections.
 - The alignment of different components, particularly windows and roof lights within the primary structural element can lead to significant thermal bridging in all forms of construction but this does not appear to be widely understood. Misalignment of window (particularly bay window) and door frames with respect to the insulation layer was common on many sites.
120. The significance of the general problems identified above lies with their impact, to a greater or lesser degree, on condensation risk. Many of the problems increase the extent of thermal bridging which in turn will lead to local areas of reduced temperature and increased risk of surface or interstitial condensation. The lack of continuity of or damage to air/vapour control layers will increase the amount of water vapour passing through the construction either by diffusion or via bulk air movement. Similarly, areas of high air leakage in the envelope, under certain external conditions (principally cold and windy) could cause local cooling of vulnerable surfaces. Air leakages into unventilated cold loft and other cold roof voids may also increase condensation risk in these spaces.

Developer Feedback

121. Copies of the draft report were submitted to 17 key personal involved in the project representing all 9 participating developers, both electronically and posted hard copy. However, only one response was received, despite a number of reminders and follow-up requests giving ample opportunity for comments to be made. Given the very low response it is not possible to provide a general developer view, however the following paragraphs give a flavour of the one set of comments received.
122. In general, the comments acknowledged that the report's observations identified recurring problem areas and pointed out the importance of education and training.
- "You have successfully exposed the recurring problem areas faced by the industry and recognised the basic need for education and training on site. Without greater knowledge at ground level a ratcheting up of robustness in design detailing will never achieve its aims."* (developer comment)
123. In response to our findings, in Chapter 3, on the general availability of design details for a number of developments, the developer comments focused on the need for a more robust system to increase the availability of large-scale details for a project. Various suggestions were made for the use of internet data bases and the operation of a national type approval approach so that each trade could have access to good quality details. In order to improve site quality the respondent suggested the extension of the use of checklists, which are part of the Part E robust detail approach. This would ensure that the needs of parts E,C and L were integrated within one system and could form the basis of a compliance certification system. However, to include this into the remit of Building Control could require considerable development and training of BCOs.
124. Throughout the feedback there was considerable stress on the need for formal confirmation or accreditation of the detailing knowledge and that, as illustrated in the quotation above, the successful transfer of that knowledge to the site operative is imperative, warning that if this is not done effectively, there would be little point in improving the range and sophistication of a robust detail system.
125. It was encouraging to see that the respondent attempted to engage directly with the problems raised by this research, making some 15 detailed suggestions for improved design and construction practice. For example:
- *"Use of quick drying "parging" coat to all external blockwork walls (prior to first fix) to limit air leakage / infiltration.*
 - *System fabricator to check on site line / level tolerances of foundation bases are satisfactory prior to delivery of timber frame. Tender documentation for the groundworker should reflect these requirements.*
 - *Services to be contained within batten void between panel and plasterboard. The Space 4 system (timber frame) and Fusion system (steel frame) do not require a vcl [vapour control layer]."* (developer comment)

Implications for Robust Detail guidance

126. At the initial workshop and throughout the fieldwork the form and content of the Robust Detail document has been commented on. Our broad conclusions on design and construction indicate that there is a great deal of development work that needs to be done to extend the guidance and improve its application. As a first step the following general areas need to be addressed:
- At present the very existence of the document is not widely known, particularly among site based personnel. Even where its existence is acknowledged, its content is not widely understood at all points in the process and a much greater effort is required to disseminate the guidance. The problem is not only one for designers and constructors but also for regulatory staff. Given the pivotal role of building control

they could have a very important part to play in increasing the application of robust details¹.

- In their present form robust details do not deal with principles nor do they provide comprehensive performance parameters for the details that are provided. This lack of guidance on principles and expected performance does not make it easy for designers to modify or adapt the examples provided to their own detailed design problem.
- Many of the practical problems observed, such as gaps in insulation, are the result of the order in which material and components are assembled. For example the placement of insulation below a cavity tray in a fully filled cavity is much less prone to error if done as the wall is built rather than relying on cavity fill injection after construction. The robust details document contains no guidance on the process issues involved.

127. In addition to the general implications identified above we have noted a number of detail design areas that are not dealt with at all in the current document or where there are uncertainties with the details themselves. The list of issues in appendix 1 seeks to collate all those areas identified during the field work that need to be addressed in a revised edition.

Selection of details for condensation modelling

128. Chapter 3 identified some 21 different aspects of detailing grouped into 8 categories, embracing many more specific details. In order to assess the extent to which the findings of the field work are likely to lead to significant risks for condensation, the project programme included a detailed condensation modelling phase. Given that the resources available preclude the investigation of every specific problem, a selection was necessary based on the material contained in chapter 3. To this end some 7 areas of detailing were selected using a balanced set of the following criteria:

- The prevalence of problems with the range of details studied,
- The extent to which problems observed related to more than one construction type,
- The inclusion of all the major junctions where design and construction problems were observed,
- The inclusion of all forms of construction investigated as part of the study.

129. The following areas have been selected for detailed modelling:

- Two configurations of ground floor to wall junction. This is a particularly difficult junction to design and the most prone to problems.
- Two configurations of intermediate floor to wall junction. This will be assessed mainly in the context of framed structures but it is anticipated that some investigation of the likely impacts in relation to masonry construction may also be investigated, as will a limited assessment of issues relating to balconies.
- Window and door opening details. This will investigate issues of cavity closure and location of door/window frame, principally in masonry cavity construction.
- Timber frame panels and the issues surrounding additional timber particularly at corners and wall/wall junctions.

¹ Although we were not in a position to provide any data on the extent of awareness of RDs among building control staff, general comments at the workshop made by some building control officers suggested that the level of awareness was low.

- Room-in-the roof details, particularly the problems relating to insulation gaps and air movement in the vicinity of rooflights.

In all cases the impact of airtightness will be investigated as appropriate to the particular detail area investigated. However it should be recognised that condensation modelling will be based on diffusion models and will not include the impact of vapour transport via bulk air movement. The presence of cavities and their impact on temperatures will of course be part of the modelled construction. A more detailed description of each modelled area, together with a list of related Robust Details is contained in appendix 2.

References

- ANDERSON, B. (2004) SAP 2005 draft review. Building Research Establishment, Garston, Watford, UK. <http://projects.bre.co.uk/sap2005/>
- BELL, M. and OVEREND, P. (2001) *Building regulation and energy efficiency in timber frame housing. In Proceedings of the Construction and Building Research Conference*, Edited by John Kelly and Kirsty Hunter, Glasgow Caledonian University, 3-5 September 2001, London, Royal Institution of Chartered Surveyors
- BELL, M., SMITH, M. and MILES-SHENTON, D. (2004) *Condensation risk – impact of improvements to Part L and Robust Details on Part C. Interim Report Number 5 – Site survey descriptions and preliminary findings; A Report to the ODPM Building Regulations Division under the Building Operational Performance Framework. Project Reference Number CI 71/6/1 (BD2414)*, Leeds Metropolitan University, Leeds, UK.
- BORLAND, S., PRESCOTT, N. and LLOYD, S. (2004) *Airtightness of Buildings – Towards Higher Performance. Non Domestic Sector – Task N3: Investigation of means of achieving higher Airtightness standards: Interim Site Inspection Report*. June 2004, Project Reference Number CI 61/6/16 (BD2429), Building Sciences Ltd.
- BSI (1997) BS EN ISO 6946:1997, *Building components and building elements – Thermal resistance and thermal transmittance – Calculation method (AMD 14547)* BSI, London, UK.
- BSI (1998) BS 5606:1990, *Guide to accuracy in building (AMD 9975)*, BSI, London, UK.
- CARLSSON, B., ELMROTH, A. and ENGVALL, P.A. (1980) *Airtightness and Thermal Insulation: Building Design Solutions*, Stockholm, Statens Råd för Byggnadsforskning.
- DAVIES, M., RIDLEY, I., SMITH, M. and BELL, M. (2004) *Condensation risk – impact of improvements to Part L and Robust Details on Part C. Interim Report Number 2 – Site descriptions & review of initial modelling; A Report to the ODPM Building Regulations Division under the Building Operational Performance Framework. Project Reference Number CI 71/6/1 (BD2414)*, University College London and Leeds Metropolitan University.
- DEFRA (2001) *Limiting Thermal Bridging and Air Leakage. Robust Details for Dwellings and Similar Buildings*. Department for the Environment, Food and Rural Affairs. London, TSO.
- DTLR, (2001), *Building Regulations Approved Document Part L1: Conservation of fuel and power in dwellings*. London: TSO.
- JOHNSTON, D., MILES-SHENTON, D. and BELL, M (2004) *Airtightness of Buildings – Towards Higher Performance. Interim Report Number 3 – Assessments of design and pilot site data; A Report to the ODPM Building Regulations Division under the Building Operational Performance Framework. Project Reference Number CI 61/6/16 (BD2429)*, Leeds Metropolitan University, Leeds, UK.
- LOWE, R.J and BELL, M. (2002) *Evaluating the Impact of an Enhanced Energy Performance Standard on Load-bearing Masonry Domestic Construction*, Partners in Innovation project CI 39/3/663. Project Implementation plan, Centre for the Built Environment, Leeds Metropolitan University, Leeds, UK.
- ORESzcZYN, T. and BELL, M. (2003) *Condensation Risk – Impact Of Improvements To Part L And Robust Details On Part C*. Project Proposal to ODPM Building Regulations Division,

Under the Building Operational Performance Framework, September 2003, Project number CI 71/6/1 BD2414, ODPM.

ROBERTS, D. (2004) *Effect of window frame position in reveal. Stamford Brook Deliverable No.4 – Construction Process*. Centre for the Built Environment, Leeds Metropolitan University, Leeds, UK. <http://www.leedsmet.ac.uk/as/cebe/build.htm>

SHAKESPEARE, W. (1596) *Romeo and Juliet*. Full text of the play available at http://www.it.usyd.edu.au/~matty/Shakespeare/texts/tragedies/romeoandjuliet_0.html

SMITH, M. and BELL, M (2004) *Condensation risk – impact of improvements to Part L and Robust Details on Part C. Interim Report Number 1 – Initial workshop & site selection criteria; A Report to the ODPM Building Regulations Division under the Building Operational Performance Framework*. Project Reference Number CI 71/6/1 (BD2414), Leeds Metropolitan University, Leeds, UK.

SMITH, M., BELL, M. and MILES-SHENTON, D. (2004) *Condensation risk – impact of improvements to Part L and Robust Details on Part C. Interim Report Number 4 – Review of construction details; A Report to the ODPM Building Regulations Division under the Building Operational Performance Framework*. Project Reference Number CI 71/6/1 (BD2414), Leeds Metropolitan University, Leeds, UK.

WARD, I.T. (1994) *Assessing condensation risk and heat loss at thermal bridges around openings*. BRE Information Paper IP 12/94, Building Research Establishment, Scottish Laboratories, Glasgow, UK.

WEBB, B. and BARTON, R. (2001) *Estimation of actual airtightness based on design and workmanship assessment – Methodology of assessing design drawings*. Project Report Number 202559, Undertaken for AEA Technology by the Building Research Establishment, Garston, Watford, UK.

WEBB, B. BARTON, R. and SCIVYER, C. (2001) *Estimation of actual airtightness based on design and workmanship assessment – Development of site checklist on workmanship*. Project Report Number 202561, Undertaken for AEA Technology by the Building Research Establishment, Garston, Watford, UK.

Appendix 1

Issues relating to the development of Robust Details.

Situation	Issue raised by fieldwork	Comment
Contaminated/ brownfield site	Brownfield site or contaminated site/ site with naturally produced contaminants (e.g. marshland)	No RD. No mention in RD publication. Design considerations should be highlighted
Cavity tray at dpc level	Insulation not seen placed adequately at cavity tray upstand	No RD. No mention in RD publication. Design considerations should be highlighted
T/F, S/F suspended slab with insulation below slab	No RD. Designers have to relate this to other construction types	No RD. No mention in RD publication. Design considerations should be highlighted
Ground floor slabs	Floor slabs of inaccurate shape, size, &/or level results in problems for S/F and T/F construction with effects of thermal bridging and airtightness issues.	No mention in RD publication. Design considerations should be highlighted
Cavities incorporating masonry	Cavities not clean resulting in mortar dropping bridging cavity, mortar droppings reducing insulation thickness, or creating gaps between boards of insulation	Historic problem. No mention in RD publication. Design considerations should be highlighted. Site operatives to be trained to understand effects.
Bay windows, adjuncts, extensions	Roof/wall junction. Insulation not placed adequately to avoid thermal bridge.	No RD. No mention in RD publication. Design considerations should be highlighted
	Cavity tray over roof/wall junction. Insulation not placed adequately at/behind cavity tray upstand to avoid thermal bridge.	No RD. No mention in RD publication. Design considerations should be highlighted
	Roof/wall junction. Air barriers not placed adequately to avoid break in air-tightness	No RD. No mention in RD publication. Design considerations should be highlighted

RSJs	RSJs taken through inner leaf insulation (in T/F, S/F, IWI), and in roof voids above partial fill (in P/F), through to cavity forming a thermal bridge	No RD. No mention in RD publication. Design considerations should be highlighted
	RSJs to semi-exposed positions carried through to heated areas	No RD. No mention in RD publication. Design considerations should be highlighted
Balconies	Supports taken through external wall and bridge insulation	Balconies mentioned briefly in text of intermediate floor RDs. No illustration. Insufficient practical guidance given.
	Balcony/wall junction. Insulation not placed adequately to avoid thermal bridge.	Balconies mentioned briefly in text of intermediate floor RDs. No illustration. Insufficient practical guidance given.
	Balcony/wall junction. Air barriers not placed adequately to avoid break in air-tightness	Balconies mentioned briefly in text of intermediate floor RDs. No illustration. Insufficient practical guidance given.
Separating wall between heated and unheated space	No insulation placed in party wall.	No RD. No mention in RD publication. Design considerations should be highlighted
Dormer windows	Dormer windows. Air barriers not placed adequately to avoid break in air-tightness	No RD. No mention in RD publication. Design considerations should be highlighted
	Dormer windows. Insulation not placed adequately to avoid thermal bridge.	No RD. No mention in RD publication. Design considerations should be highlighted
	Dormer window. Continual insulation and air barriers at support not provided.	No RD. No mention in RD publication. Design considerations should be highlighted
Services through roof	Continual insulation and air barriers at support not provided at protrusion. Sealing not provided.	No RD. No mention in RD publication. Design considerations should be highlighted

Appendix 2

Descriptions of construction areas to be investigated in the condensation modelling phase.

Robust Detail ref no.	Junction/ element	Construction specific to RD	RDs with equivalence to RD chosen due to transferable issues	Generalised issues	Specific issues relating to RD ¹
3.12	Windows & Doors: jambs and sills	Masonry full-fill	2.10, 4.12, 5.11, 6.10, 7.06	Less than adequate thermal resistance at wall/opening junction	Cavity closers missing or missing in part or inadequate insulated Insufficient for thermal resistance of 0.45m2 K/W at jambs and sills Gaps in insulation at jambs and sills Minimum frame/closer overlap of 30mm not achieved Internal/external sealing not carried out adequately
4.14	Ground floor/wall junction	Masonry partial-fill	2.15, 3.17, 4.17: In situ suspended floor slab insulation below slab F/F, P/F (No similar RD for S/F or T/F) 2.12, 3.14, 6.12, 7.08: Ground bearing floor. Insulation below slab F/F, T/F, S/F 2.13, 3.13, 3.14, 4.16, 7.08, 7.09, 7.10, 7.11: Solid floors with insulation above or below slab F/F, P/F, S/F 8.01 Air leakage for masonry walls 8.05, 8.06: Level thresholds EWI, F/F, P/F, IWI, T/F, S/F	Less than adequate thermal resistance below dpc in walls	Cavity tray dpc. No insulation at/behind upstand Cavity insulation commences at/above upper surface of ground floor level or at dpc level Suspended slab with insulation below slab but slab extends across to cavity.(NB not illustrated by RD) Ribbons of adhesive to perimeter of internal dry-lining omitted or not continuous
6.12	Ground floor/wall junction	Timber frame. Insulation below slab	3.17, 4.17: Insitu suspended floor slab insulation below slab F/F, P/F (No similar RD for S/F or T/F)	Less than adequate perimeter edge insulation to slabs	Perimeter edge insulation missing when required. Note extreme case of this is at level thresholds

¹ Modelling will address as many of the issues as possible within the resources available.

			<p>3.14, 4.14, 5.13, 6.12, 7.08: Ground bearing floor. Insulation below slab EWI, F/F, IWI, T/F, S/F</p> <p>3.15, 4.15, 5.14, 6.13 (alternative with screed), 7.09: Raft foundation EWI, F/F, P/F, IWI, T/F, S/F</p> <p>8.05, 8.06: Level threshold. Insulation above or below slab. EWI, F/F, P/F, IWI, T/F, S/F</p>	<p>Air flow and air permeability permitted at external walls</p>	<p>Polystyrene placed as formwork for slab and then removed. If left in place could have doubled as perimeter insulation</p> <p>Tolerance of floor slab levelling. Extreme case: packers used under soleplate raising plate and creating unfilled gap</p> <p>Suspended concrete ground floor with insulation over and screed on top, and no perimeter edge insulation (NB not illustrated by RD)</p>
6.18	Intermediate floor	Timber frame.	6.00, 6.19, 8.01 sealing of vapour barriers.	<p>Less than adequate insulation at wall/floor junction</p> <p>Balcony not illustrated for RD</p>	<p>No insulation at floor perimeter adjacent to external walls</p> <p>Services taken through timber (I beams etc) to external wall cavity and not sealed, with no air barrier to floor.</p> <p>External wall/intermediate floor sealing not provided</p> <p>Balcony supports (steel) taken through timber frame bridging thermal insulation</p> <p>RSJs at extensions etc., not insulated appropriately resulting in thermal bridging.</p>
6.19	Wall/wall junction	Timber frame		Less than adequate insulation to walls	<p>Excessive timber ratio issues wall/wall junctions, wall panel/wall panel junctions and at wall panel/opening panel junctions</p> <p>Wall junctions Insulation missing between close standing uprights (typically 12mm to 50mm wide gap)</p>
7.13	Intermediate floor	Steel frame	<p>6.18 wall for T/F punctured by services</p> <p>8.01 air leakage</p>	<p>Air flow and air permeability permitted at external walls</p> <p>Less than adequate insulation to walls</p>	<p>Punctured or missing vapour barrier. Eg at services, at cavity trays, at intermediate floor junctions.</p> <p>Gaps in insulation at cavity trays</p> <p>S/F fixings through insulation & onto foil face of board insulation</p>

8.03	Rooflights	Warm roof: ventilated batten void	<p>2.03, 2.04, 2.05, 2.06, 3.03, 3.04, 3.05, 3.06, 4.03, 4.04, 4.05, 4.06, 5.03, 5.04, 5.05, 5.06, 6.03,</p> <p>6.04, 6.05, 6.06, 7.03, 7.04: Roofs EWI, F/F, P/F, IWI, T/F, S/F</p> <p>8.01 Services penetrating insulated ceilings and warm roofs without sealing EWI, F/F, P/F, IWI, T/F, S/F</p>	<p>Air permeability and air flow permitted at roof/rooflight junction</p> <p>Less than adequate thermal insulation at roofs</p> <p>Air permeability and air flow permitted at roof/services junction</p>	<p>Insulation inadequately placed and gaps or holes left,</p> <p>Insulation not tightly held back and air passages thus created,</p> <p>Air barriers interrupted by eg foil facing to board insulation not continuous or taped</p> <p>Services penetrate without sealing interrupting insulation and air barrier</p>
------	------------	-----------------------------------	--	--	--