



TEKNISKA HÖGSKOLAN
HÖGSKOLAN I JÖNKÖPING

industriDESIGN

Design of a composter with MiljöCenter

Sofia Garín Martínez



BACHERLOR THESIS 2014

Bachelor thesis of Industrial Design and Product Development. Exchange student (Erasmus).

Postadress:
Box 1026
551 11 Jönköping

Besöksadress:
Gjuterigatan 5

Telefon:
036-10 10 00 (vx)



TEKNISKA HÖGSKOLAN
HÖGSKOLAN I JÖNKÖPING



TEKNISKA HÖGSKOLAN
HÖGSKOLAN I JÖNKÖPING

DESIGN OF A COMPOSTER FOR THE COMPANY MILJÖ CENTER

SOFIA GARIN MARTINEZ

This degree project is performed at the School of Engineering in Jönköping in the subject field Industrial Design. The project has been made in the school of Engineering from Jönköping during my exchange program, and is validated also by the final work of the degree in Industrial Design and Product Development from the Spanish university of Zaragoza. The writer are responsible of the result, conclusions and reflections.

Tutor: **Thomas Arnell**

Extent: **15 points**

Date: 27/05/2014

Filing number:

Abstract

This report summarizes the design process and the consequent results of the project work realized during sixteen weeks in collaboration with the company MiljöCenter.

During the whole project, all the main steps that helped to get the new ideas have been written down in this report.

The report contents the industrial design methodology from a theoretical point of view and its implementation in the design of the composter.

The final result presented at the end of this report, is a new composter designed with the philosophy and thinking of the company MiljöCenter and the skills acquired during the whole bachelor in Zaragoza University (Spain) and the exchange program in Jönköping University. The project includes the implementation of the most technical part as an engineer, referring to materials, structures, mechanism and logistic part. And it also includes the enforcement of the most artistic skills from the design point of view like creativity, sketching or rendering.

The container has to be considered like a proposal to the company to improve the composters due to several factors like saving money because the product occupies less space in the transport, getting more range of users since the sizes have been decided with ergonomics aspects, and in general improving the image of the composters.

Summary

The report describes the process of product development and industrial design done to get a composter as a final result.

The new design of the container for compost was ordered by the company MiljöCenter in order to improve the ones that the company already has.

The main goal of this project was to develop a new product that improves the design, the assembly, the logistics and the economy of the composter comparing with the ones of the company and also the ones of the competitors.

In order to get this goal, the design process has been based in different methodology and methods divided in several steps like research, ideation, functional analysis, visualization...etc.

All the process is detailed in this paper, and also the result that consists in a complete design of a composter made for outdoor. Resistant to all kind of weather and with a simple form that helps to make an easy assembly, disassembly and transport.

RESUMEN

Este documento describe el proceso de desarrollo y diseño de un nuevo contenedor para compost.

El nuevo diseño fue encargado por la compañía Mijo Center con la finalidad de mejorar los contenedores que la propia empresa ya tenía.

El objetivo principal del proyecto era desarrollar un producto capaz de mejorar el diseño, el ensamblaje, la logística y los gastos económicos del contenedor, comparándolo con los de la compañía así como como los de los competidores.

Para obtener este objetivo, el proceso de diseño se ha basado en diversas metodologías y métodos divididos en varios pasos como el estudio de mercado, la ideación, el análisis funcional o la visualización.

Todo el proceso de diseño queda detallado en este papel así como el resultado, el cual se trata del diseño de un nuevo contenedor de compost para exteriores. Este es resistente a todo tipo de clima con una forma simple que ayuda a un fácil ensamblado así como un fácil transporte.

Acknowledgements

I want to appreciate to Thomas Arnell the help and guidance in this project, helping me to increase my knowledge in creativity and design methods and to improve my design skills during this year.

I also want to thank Björn Lindberg, logistic manager of the company MiljöCenter, for giving me the opportunity of collaborate with the company learning from real situations. But especially for helping during the design process and the decisions, attending carefully all my project.

To finish, I want to thank all the designers of the studio and my closer friends for collaborating during the process giving feedback, opinions and also giving support in the hardest moments.

Table of Contents

Abstract	ii
Summary	iii
Acknowledgements	iv
Table of Contents.....	v
1 Introduction.....	6
1.1 Background.....	6
1.2 Objectives	7
1.3 Delimitations	7
1.4 Disposition.....	7
2 Theoretical Background.....	9
2.1 Design	9
2.1.1 Design process	9
2.1.2 Creativity	11
2.1.3 Solution of problems.....	12
2.2 Product development.....	12
2.2.1 Product lifecycle management (PLM)	13
2.2.2 Life cycle assessment (LCA).....	14
2.2.3 Sustainability and green products.....	15
2.3 Compost	15
3 Method.....	16
3.1 The Brief.....	16
3.2 The Planning	17
3.3 Research and analyze.....	17
3.4 Analysis.....	18
3.4.1 Market analysis	18
3.4.1 Form analysis	18
3.4.2 Structural analysis	19
3.4.3 Functional analysis	19
3.4.4 User analysis	19
3.4.5 Ergonomic analysis.....	20

3.5	The Design Process	20
3.5.1	Brainstorming	20
3.5.2	Ideation and conceptualization	21
3.5.3	Visualization	21
4	Approach and Implementation	23
5	Result	46
6	Conclusion and discussion.....	72
7	References.....	73
8	Attachments.....	75

1 Introduction

The project aim is to develop a new container to make compost intended to outdoor environment.

Following appears all the information necessary to understand the last results of the project.

1.1 Background

The background to the project is defined by the company MilöCenter.

The company defined itself like a company of manufacturing and trading of products for house and gardens. They focus the products in three main characteristics: safety, quality and environmental care.

The company was born around nineteen years ago, and the problem is that even though they are leaders in the market with their composters, the design needs to be improved and renovated. The containers have been designed with the same mold and shape for too many years and now, they wanted an update and an improvement in the whole product range.

The intention of MiljöCenter is to have a product with the same functions but with a better appearance and more environmental friendly, following with the philosophy of the company.

The main problem of the company, to be solved, is the image. They have several products to make compost that haven't any kind of relationship between themselves. They also have been working with the same molds, shape and materials for a long time and this fact could make them be decrease in the market.

PURPOSE

The purpose is to change the design of the composters that they already have, making a nicer shape that also invite to realize the process with an easy realization of all the functions. All of this should be done improving also the logistics part to take care of economy and sustainability.

All the improvements should be solved taking into account the philosophy of the company. That means that the product must be environmental friendly and must have a good relationship user – product to make easier the life to the customer.

Like every project, a brief is needed to start and be sure of get all the necessary points during the design process. This brief has been made in collaboration with the company. The philosophy, preferences, and work style marked the fundamental design requirements.

I.2 Objectives

The objective of the project is to design a container that makes possible the process of compost in an outside environment.

The main objective is to cover the needs and improve the whole product, understanding this like the shape, the materials, the development, the mechanism, the costs and the logistics.

The new design is the result of the whole design process. This process includes the principal steps required for every set out point that must be achieved. All those points must appear in the first method, called Brief. After it, the research helps to draw the way to design following the brand image of MiljöCenter and taking into account all the market. At the end, all the design process based in the knowledge acquired during the whole degree, will help to get the final product.

I.3 Delimitations

During the project, economics, logistics and design aspects have been developed till the point of have an idea about how the product could look like and if it could be profitable for the company.

Since the project has been done in four months (sixteen weeks), the details are not strong enough to know one hundred per cent how successful could be the production of the new composter. This approval could be investigated and checked by the company after the end of the project.

Finally, the project could be considered like a suggestion of how can MiljöCenter improve their products and what can they do in the future new productions.

I.4 Disposition

1. INTRODUCTION

Introductory part with the description of the problems and the proposal of MiljöCenter (Background); objectives; delimitations; and the structure of the report.

It could also be called “guide” since appear the main goals that have to be achieved at the end of the project.

2. **THEORY**

Description of some concepts that will help the reader to understand the rest of the report.

The concepts are theoretic definitions of important facts that appear during the project. There also appear more specific words referring to the theme of this project, the compost.

3. **METHOD**

Theoretical explanation of different design methods applied during the project.

In this part the methods are just explained from an academic point of view. In the next chapter, they appear in the way that have been applied, with the techniques and the different process. The theoretical part turn in practical in the next step.

4. **APPROACH AND IMPLEMENTATION**

This part includes all the steps done during the design process to get the final result.

The design process is based in the theoretical background and follows the methods explained in the previous chapters.

In this part appear all the explanation of every step supported also with pictures and images that shows the process of the project.

5. **RESULT**

Visualization of the final result with rendering, sketching and model.

All the previous steps and the chain of work like analysis, methods study and implementation of them, have created a result that tried to get all the specifications marked at the beginning and to solve all the problems arising during the different analysis.

6. **CONCLUSION AND DISCUSSION**

At the end, the results also has to been analyzed. In this part is include the feedback of the company and the personal and professional satisfaction gained through the project.

2 Theoretical Background

In this part appear all the concepts and theoretical aspects used during the project. It can be helpful to help people to understand some design and product concepts necessary to understand the whole process of the project.

2.1 Design

To start is good to have an overview about what design is.

There are so many definition about industrial design, some of them depending of the contest and also the kind of products. In this case it is possible to say that “design refers to those activities that actually generate and develop a product from a need, product idea or technology to the full documentation needed to realize the product and to fulfil the perceived needs of the user and other stakeholders” (Chakrabarti & Amaresh, 2009)

Design is a very useful tool to solve problems and to make visual representation of ideas. The next step is the development of every detail to make the idea possible.

2.1.1 Design process

The design process is a methodology where different operations are made in a logical order to get conclusions and the final result.

Following some theories, like the one of J.S. Gero the design process includes an integration way of work between the creative process and the engineering design.

Every new design begins with the detection of the problem, the analysis part. Then, once that the problem is defined, starts the design part with ideation and conceptualization that is detailed and developed afterward.

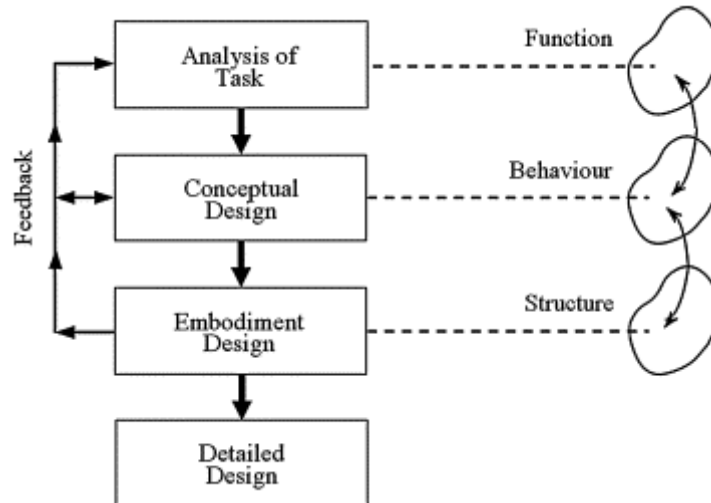

Figure 1 Design process by J.S. Gero (Gero, 2004)

On the other hand, it is possible to say that in a general way, the design is a method of language expression, so it is possible to apply the three aspects of the language expression, to design. The three aspects are in the image below (Figure 2). The three aspects must be in concordance and have a relation to understand the needs, the technical aspects and the language formal of the product.

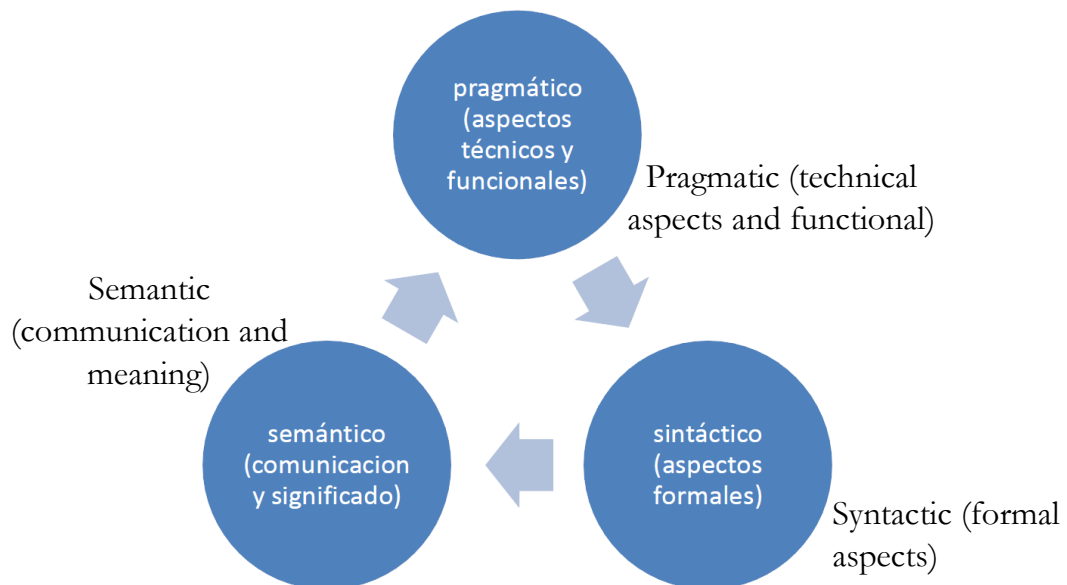

Figure 2 Aspects of the language expression (Manchado, 2010)

2.1.2 Creativity

“Creativity is a faculty of intelligence that reorganizes elements of perception in an original way that gives place to operations of any phenomenological” Abraham Moles and Roland Caude (Moles, 1970)

Creativity is also a tool and a way of work that every designer use in the design process. It gives place to the ideation and conceptualization.

The creative process also follows a list of steps with several task in everyone. All of them are related to the previous one and required a look back and review of the actions previously done.

Following the steps of Shneiderman, the creative process has a research part for collect the necessary information and then the part of implementation of the creativity that always has to be revised.

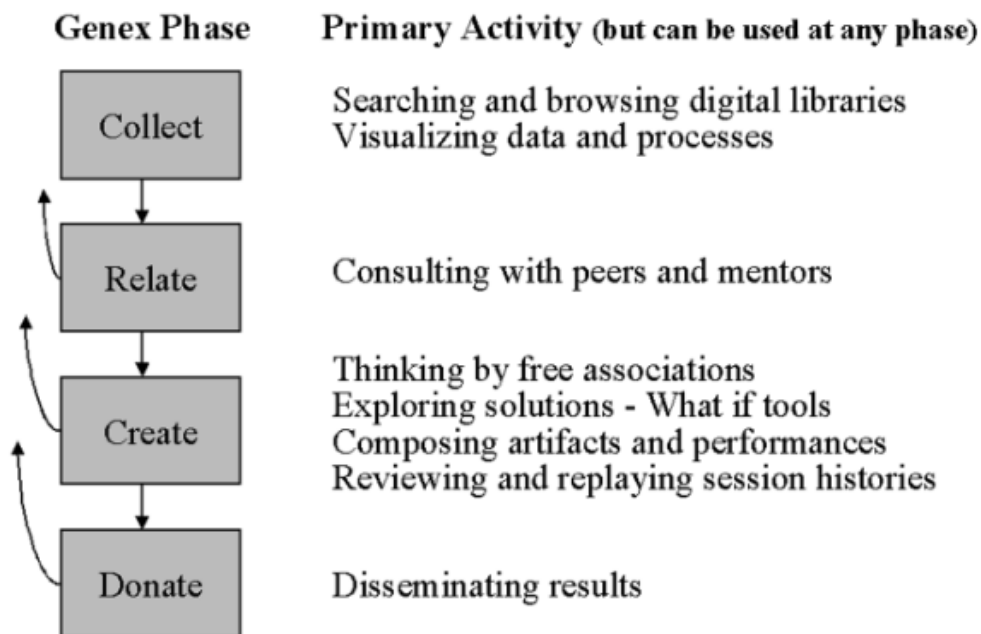

Figure 3 Creative process by Shneiderman (Shneiderman, 2000)

Other similar schema of the process is the implementation of the design process and methods in a creativity way.

In contradistinction to the previous one, in this case the last step is the only one that has a back correspondence with the rest ones.

The first step involve the knowledge of the situation so it is quite similar to the first step of the previous schema where the information has to be collected. The same happened with the “create” stage and the generation of ideas, and the last step of evaluation.

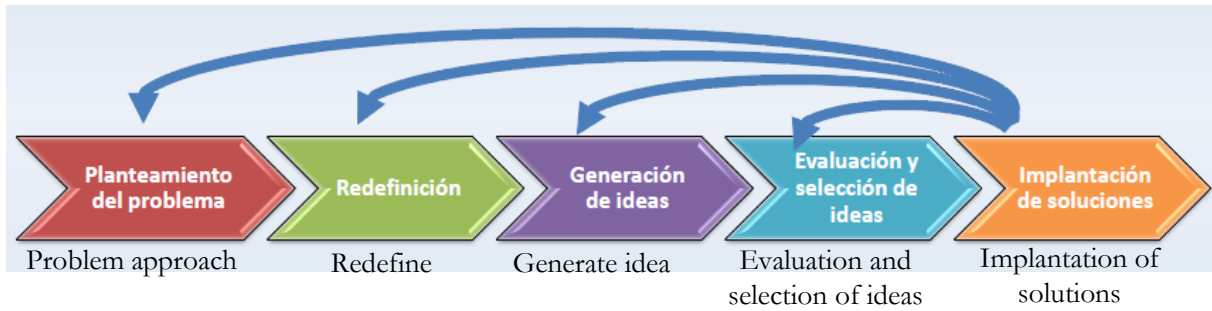

Figure 4 Creativity (Fornies, 2012)

2.1.3 Solution of problems

The main goal of designing is to get the solution a problem. The problems could be identified in different ways.

The problems come up because of needs detected by the users.

To solve them there are different techniques. Since the design is a creative process to solve problems, the solution is not going to be “the solution” it will be just one of the possible ones. (Fornies, 2012)

To solve the problems it is need to define the concepts in a clear way, know the limitations and try to overcome them using a systematic methodology. This process will originate ideas. These ideas are not the solution, they are the possible solutions. (Romero, 2005)

To transform the idea in a solution it is necessary to process all the ideas through analyzing, testing and selecting.

2.2 Product development

“Product development is a task that is to introduce or add value to the satisfiers in order to change or enhance their features to cover or increase the level of satisfaction of the needs and desires of the consumers.” (Kirchner & Lerma, 2010)

Talking about the value of a product, it is necessary to evaluate it in its whole life. That is referred in the life cycle. It is a fundamental part of the strategy of the company in the development and the strategy for new products.

2.2.1 Product lifecycle management (PLM)

Is really important to know about the definition of the product lifecycle and don't misunderstand it with the Analysis of lifecycle that is also called lifecycle assessment.

The product lifecycle refers to the product life from the business point of view.

“Product lifecycle management is the business activity of managing, in the most effective way, a company's products all the way across their lifecycles; from the very first idea for a product all the way through until it is retired and disposed of. “ (Stark, 2011)

As the graphic shows, the life cycle of a product has four stages. The introduction that is where the product is born and is new in the market; the growth that is the next step, when the product started to get position in the market; the maturity, where the product start to have a good position in the market and could have more competitors in the same level; and in the end, decline, when the product start to get “old” and less attractive for the consumers.

The duration of each period is different of every product. There are so many factors that affect to this graphic, but the main ones are how the company manage the product with publicity, prices, etc; and the competitors of the market.

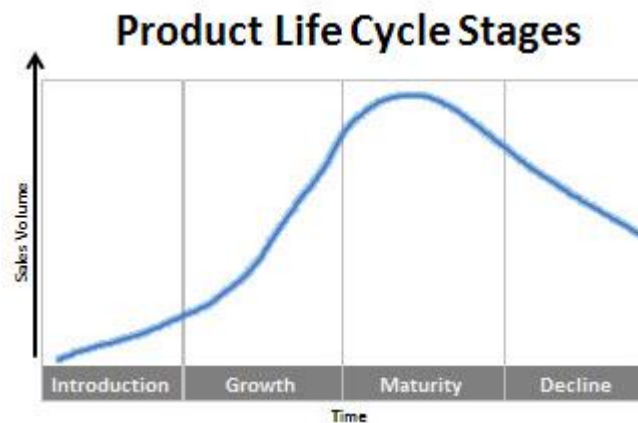

Figure 5 Product life cycle stages (Anon., 2014)

2.2.2 Life cycle assessment (LCA)

“The term “life cycle” refers to the major activities in the course of the product’s life-span from its manufacture, use and maintenance, to its final disposal, including the raw material acquisition required to manufacture the product.” (Drive, 2006)

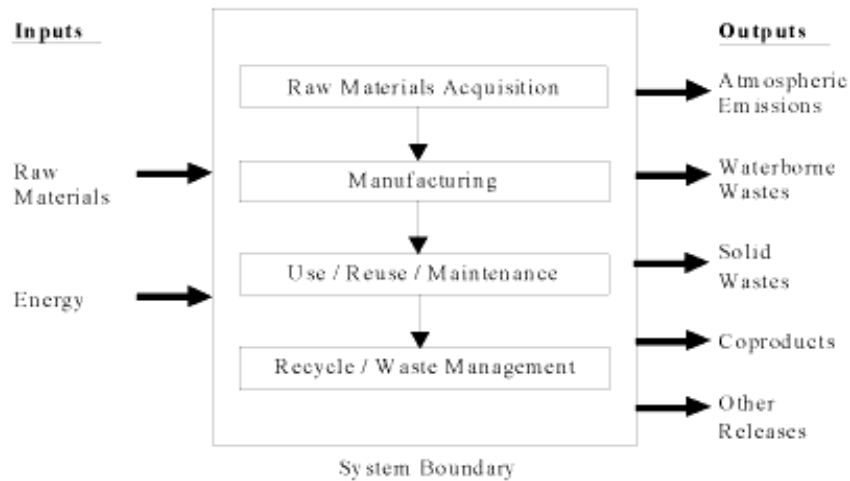

Figure 6 Life Cycle Assessment (Drive, 2006)

The life cycle assessment is a tool that is used from an environmental point of view to know the relationship between the product and the impact in the environment.

This, of course, has a relationship with the sustainable design and the green products that take care of the environment in the production and also in the possible second life of them.

According to the graphic, and how the definition says, the analysis of the life cycle includes the raw material extraction, the processing of them, the manufacturing, assembly, the use of the product and the end of its life.



Figure 7 Aspects of the life cycle (Solid works, 2014)

2.2.3 Sustainability and green products

The sustainability refers to the relationship between the product and the resource necessary to produce and develop the product.

The first definition of the sustainability development was written in the Brundtland report in 1987 and says: “sustainable development is development that aims to respond to the needs of the present without compromising the ability to satisfy those of future generations.”

As the graphic of the previous chapter shows (Figure 7), all the factors included have to be in balance, using resources without negative interference. This balance gives place to the green products as a result of a good balance between the three dimensions. These three dimensions are: ecological, economic and social dimension. The perfect way to have a sustainable product is to get the equilibrium with a responsible use and proper management of natural resources, covering the basic needs and solving the problems from a possible economic viability and management of human resources. (Aguayo, et al., 2011)

Nowadays the ecodesign is growing up at the same time that people started to be more wondering about the environment. The most common arrangement for those products born from the ecodesign are: increase the life of the products, reduce the amount of materials, reduce the packaging, avoid the mix of materials, promote the collective use of products and add services to the products to increase their value. (CADI (Centro Aragonés de Diseño Industrial), 2009)

2.3 Ergonomics aspects

The ergonomics are one of the main aspects in mostly all the products. The ergonomics is the study of people’s efficiency in their working environment. (Oxford dictionaries, 2014).

The ergonomics study in a product affects to workers and all stakeholders in the process of innovating their workplace, or in case of the user, their positions in the sequence of use. (Karwowski, 2006)Page2208.

Since, it is impossible to design for the whole and 100% of the population, the most extreme cases are excluded and the studies take the 90% of the population. The dwellers used to be divided in groups depending of the measure, each of these groups is called percentile. (Panero & Zelnik, 1996)

The most common uses of the percentiles includes the 95th of man and the 5th of woman. Then the user with the largest body size and the one with the smallest one could use the design adequately. (Panero & Zelnik, 1996)

3 Methods

In this part the methods used during the project are described. These are only the theoretical explanation; in the next chapter appear how the methods have been used in the project.

As it was explained in the theoretical part, design includes the techniques necessary to get the solution for a detected problem.

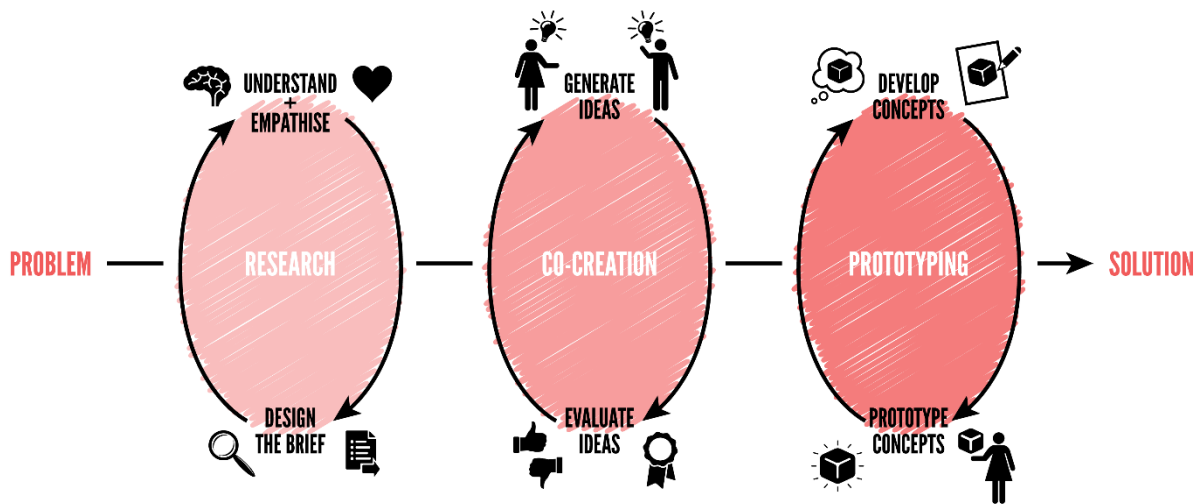

Figure 8 Design process (Parker, 2014)

3.1 The Brief

Once that the problem is identified, it is necessary to define and summarize the requirements of the company and the user to define the properties that the future product is going to have, therefore the goals to achieve during the project. This set of defined points is called brief.

It lists the aims that are required from the point of normative, thinking of the company, and also thoughts of the designer.

3.2 The Planning

Before to start a project is common to know approximately deadlines when you have to be done with some parts of the projects. All these days, plus an own schedule to work and get the results in the correct day, appear in the planning.

Realistically, the schedule is not always follow in a strict way but is a good guide to know how far you have to get every week and to not forget any step of point necessary for the project.

3.3 Research

The research is considerate an important part of the project because is really helpful to find new opportunities and “holes” in the market that can be covered with a new design. In this part, the main task is get different information, analyzing and interpreting it to get the best

The image shows the highlights aspects that have to been taking into account in the research for a product design.

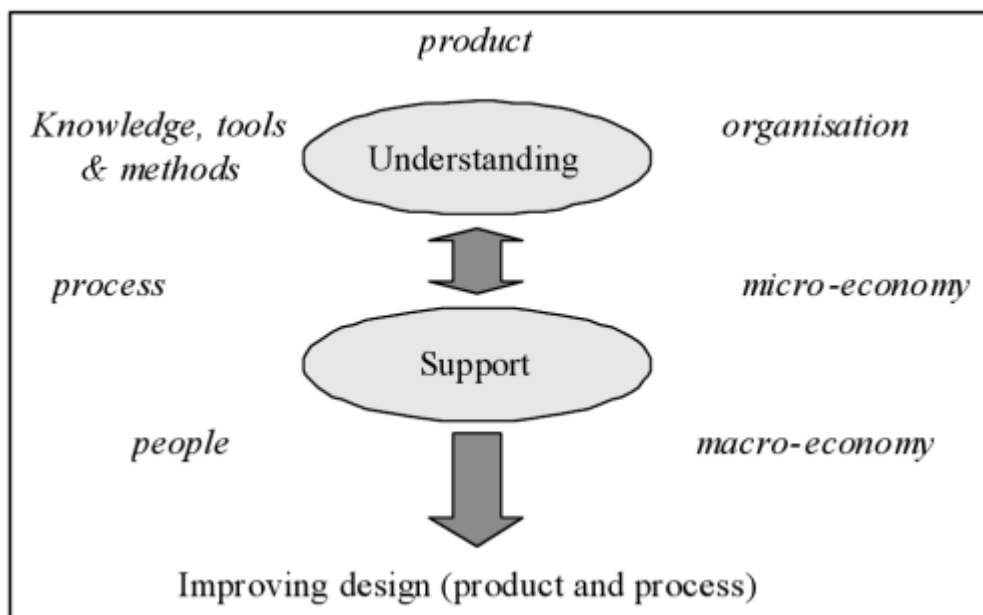

Figure 9 design process

Following the theory of Horváth, design research is “generating knowledge about design and for design” (Chakrabarti & Amaresh, 2009)

Referring to these main points, it is possible to divide the research in several parts that includes aspects like economy and competitors.

In this case that the project is made with a company, the research must have two main kind of data. The data from the company MiljöCenter and the one from the rest of the market.

To conclude, it's possible to say that the research part is really important to define the brief of the project and to get that the new design will satisfy all the needs in a better way that the already existed in the market.

3.4 Analysis

All the information collected has to be analyzed with the aim to get conclusions about the product. The information come from the research, especially of the market and the product but also of all the main factors that coexist with the product and therefore affect the future design.

3.4.1 Market analysis

The research of the market is it called market analysis. In this method it is necessary to collect all the information of different family or products of the market. This information will be processed and analyzed in tables where the differences and the similitudes are visible.

This table used to include aspects like, sides, prizes, brand, color ...

(Fornies, 2012)

3.4.2 Form analysis

The form analysis includes a lot of factors. Some of them are part of the "personal" likes of every person like the color, the aspect (modern, classical...), the details... etc.

On the other hand, it is the general shape that helps us to recognize the product. In other words, the shape conformities the function. This is also called form language. The form language is the way that the product communicates something with the shape.

The physical form contributes to the product functionality and enhances the performance of the functions. (CADI (Centro Aragonés de Diseño Industrial), 2009)

Apart of the basic role of the form, it also can add value to the product to make it different to others that have the same functions.

3.4.3 Structural analysis

It complements to the market analysis. With the same products it is possible to detect the different that form what the whole product. Trying to get a general structure of the product with the main components that make possible its operation and performance.

3.4.4 Functional analysis

This analysis has a strong relationship with the previous one, since if a product has different parts is because every part has a different function.

The aim of this analysis is to establish the functions required, but it also helps to understand better the product, the assembly and the production of itself.

One of the main ways to do this analysis is follow the next steps: (Cross, 2008)

1. Express the overall function in terms of the conversion of inputs into outputs.
2. Break down the overall function into a set of essential sub-functions.
3. Draw a diagram with the interaction between the sub-functions.
4. Search for appropriate components for performing the sub-functions and their interactions.

3.4.5 User analysis

This is a really important analysis since the user is the one who is in contact with the product and the one who can experiment problems and advantages of the product. In other words, is the one who gives meaning to the existence of the product. The designer must understand how people is going to use the product and know about the preferences of the user and then, get the optimal product depending of the “teaser”.

But the user is not only the teaser or the person who is going to use the product, the word “user” includes any person who is going to be in contact or who has a relation with it. The user are all those people who are present in one moment during the life of the product. The most important user is the one that is going to use the product at the end. (CADI (Centro Aragonés de Diseño Industrial), 2009)

The user joined to the environment where the product is going to be used, form the situation in which the product is going to be used. The environment is also in relation with the function because the user is going to get a benefit of the action in a determinate environment where he uses it.

STAKEHOLDER: The stakeholder is “any group or individual who can affect or is affected by the achievement of the firm’s objectives.” According with the process of design followed during the degree, it is possible to say that the stakeholder works like a framework. This analysis helps to understand the relationship of groups that affect to the product. (Cambridge University, 2010).

3.4.6 Ergonomic analysis

As it was explained in the theoretical background the ergonomic is “The study of people’s efficiency in their working environment.” (Oxford Dictionaries, 2014)

According with Chapanis (Chapanis, 1994) the analysis establishes a background for making improvements. This analysis includes three main activities that are: analysis of similar systems, activity analysis and critical incident study.

Lately, when this will be applied to the product, it will be rationed with the functional and the user analysis to study the user sequence and detected the postures that have to been taking into account.

3.5 The Design Process

Once that all the information has been collected and analyzed, and all the data necessary is known, it is time of the ideation and the conceptualization. To get these ideas, it is common to use different techniques depending of the kind of team work. In this paper just appear the techniques used for this project.

3.5.1 Brainstorming

It is a creative problem solving method.

“The brainstorming is a spontaneous group discussion to produce ideas and ways of solving problems” (Oxford dictionary , 2014)

Mainly, it consists in get different words from an initial one called “key word” that used to be the product or the main function of it. From this word, the rest start to flow, every single word that appears in your mind is valid for the brainstorming.

Following the rules of Alex Faickney Osborn, the criticism is now allow, all unusual ideas are welcome and is also good to combine and improve those ideas, the members have to be focus on quantity and the participants need communication to consider the opinion of the others. (Jain, 2010) The brainstorming is a free activity where all the ideas are welcome and written down and after will be analyzed. (Knight, 2013)

This method helps to get the next step, the ideas for solving the problem and think in a new product.

3.5.2 Mood board

A mood board is a creative tool that help to make a frame of the style of the project. Typically it is a combination of images, fonts, colors, and textures that define the style of the future product. (Creatively driven, 2014)

It is a visual way to know easily how the designer has to approach the project.

Usually, the mood board is going to content information about the environment, the users, and the products that could be placed close to it, the family products. If the product is going to be for a company, the mood board will content also information about the style or the brand image of the company.

3.5.3 Ideation and conceptualization

Ideation is the formation of ideas or concepts; understanding concept as an abstract idea or an intention. (Oxford Dictionaries, 2014)

This is one of the most important parts of the project. It represents a point where it wouldn't be possible to arrive without the previous steps.

The ideas could be just concepts that provide potential futuristic products that are not possible to carry out because of lack of technology, or possible ideas for the present.

The concepts born after the brainstorming and after the association of ideas, are modified until their maturity where it is possible to analyze them and determinate which one is the best one. Once that the concept is selected, it has to be developed with all the details required or defined in the brief. The developing will follow in the next step.

3.5.4 Visualization

The last step of a project is make the best visualization possible of the concept. That means show the idea and all the details required for the operation, the user and the company.

The visualization can appear as sketching, rendering or models.

3.5.4.1 Sketching

“A rough or unfinished drawing or painting, often made to assist in making a more finished picture”. (Oxford Dictionaries, 2014). This technique can be found in different styles depending of the tools that are used to make them. Paper, digital, markers, color pencils....

3.5.4.2 CAD

The next step is to visualize the sketch in a more detailed way. This way is to model them in a 3D computer program. This technique allows to the designer to introduce every detail, to get planes and renders that help to be closer to the real image of the product.

3.5.4.3 Modeling

“A three-dimensional representation of a person or thing or of a proposed structure, typically on a smaller scale than the original” (Oxford Dictionaries, 2014)

There are four different types of models or mock-ups: (Chitale & Gupta, 2005)

- Clay studies: are used to evaluate the relation between the different parts of the product. Can be made in full size or to a smaller scale.
- Mock-ups: it is made to simulate the final product so it used to be made with different materials to the real one. It creates a similar aspect of the future product.
- Scale models: they are used to see the finish in the material and in the surface.
- Prototypes: full size models of the real product. It has all the details, inside and outside.

4 Approach and Implementation

The method following during the project has had the influence of the two process explained in the theoretical part: the design process of J.S. Gero, the steps of Shneiderman and the creative method (Fornies, 2012) and also for the general design process followed during my degree in the rest of projects.

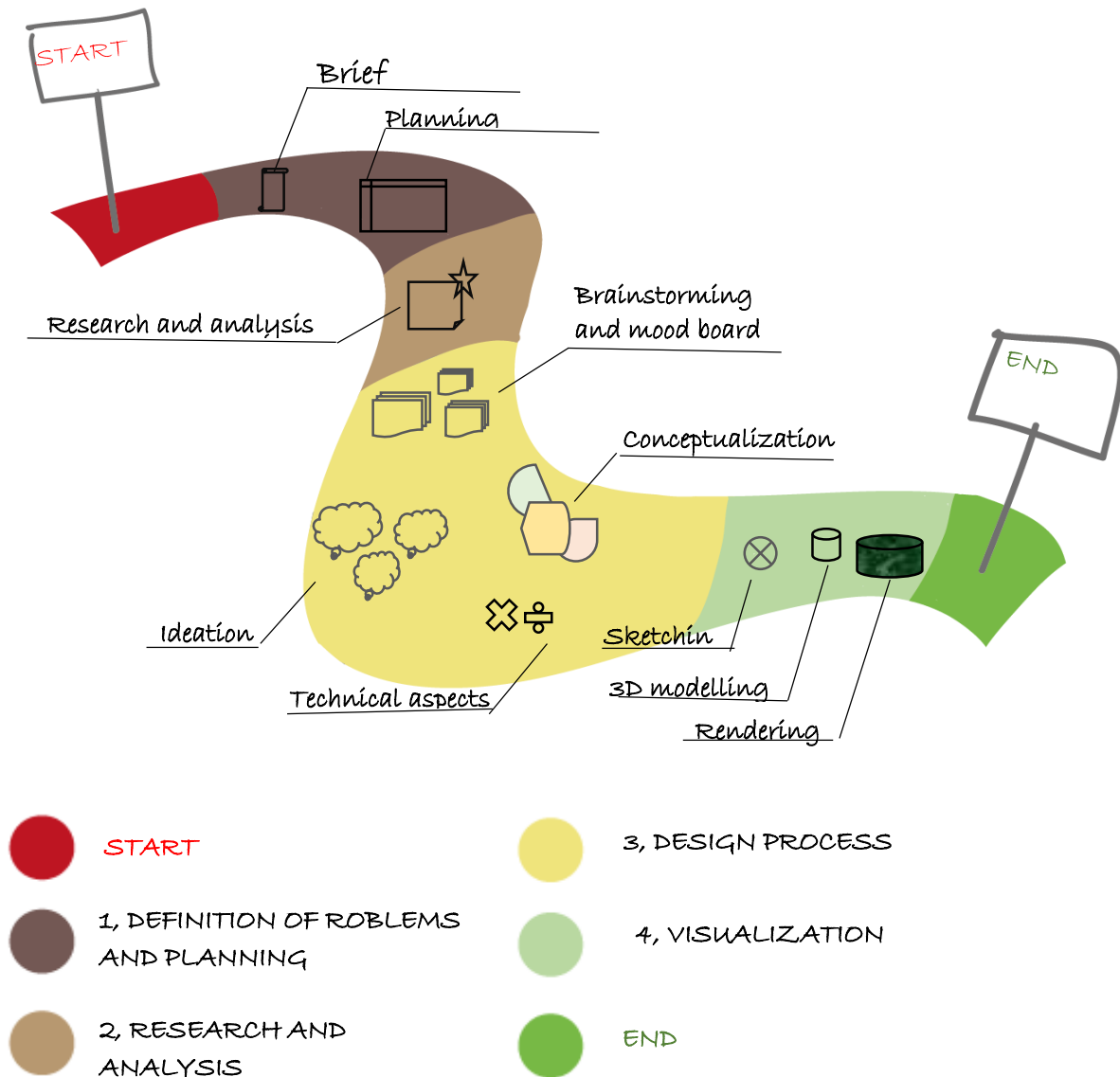

Figure 10 Method following in the project

As the graphic shows, there are four main steps during the project. In this chapter appear the detailed explanation about every part.

4.1 Definition of problems and planning

This step involves the explanation of the very first part of the project. This means, the detection and definition of the problem, the definition of the requirements and the framework in the brief and the planning.

MEETING 1.

In the first meeting, the problem was defined and also the philosophy of the company.

The company provided some information useful to define the brief and therefore the goals that will have to be achieved at the end of the project.

All that information comes in the next paragraphs.

4.1.1 The brief

The brief was written taking into account all the information that MilöCenter gave during the first meeting and with the own criteria to afford the project.

In the next picture you can see the main factors that have been guiding the project. The rest of the brief and its complete redaction appear in the attachment 2.



Company requirements

- *Economic:*
production, materiales
- *Easy to build*
- *Easy to transport*
- *New design*
- *Green product*
- *Family of products*
- *Resistent*
weather, insulation, sun...

Own Criteria

- *Complete process/ family*
- *Environment friendly*
- *Environment awareness*
- *Simple shapes,*
form communication
according with the
environment

4.1.2 The planning

The first step in the design process is to stabilize the plan of the project. The following picture shows a general plan just with the different big groups of work and the number of weeks that each group requires.

After the general planning is necessary to make a detailed one. With days that specified meeting with the company, deadlines and goals. Then, the planning will help to follow a line of work and to achieve the goals suggested for every week.

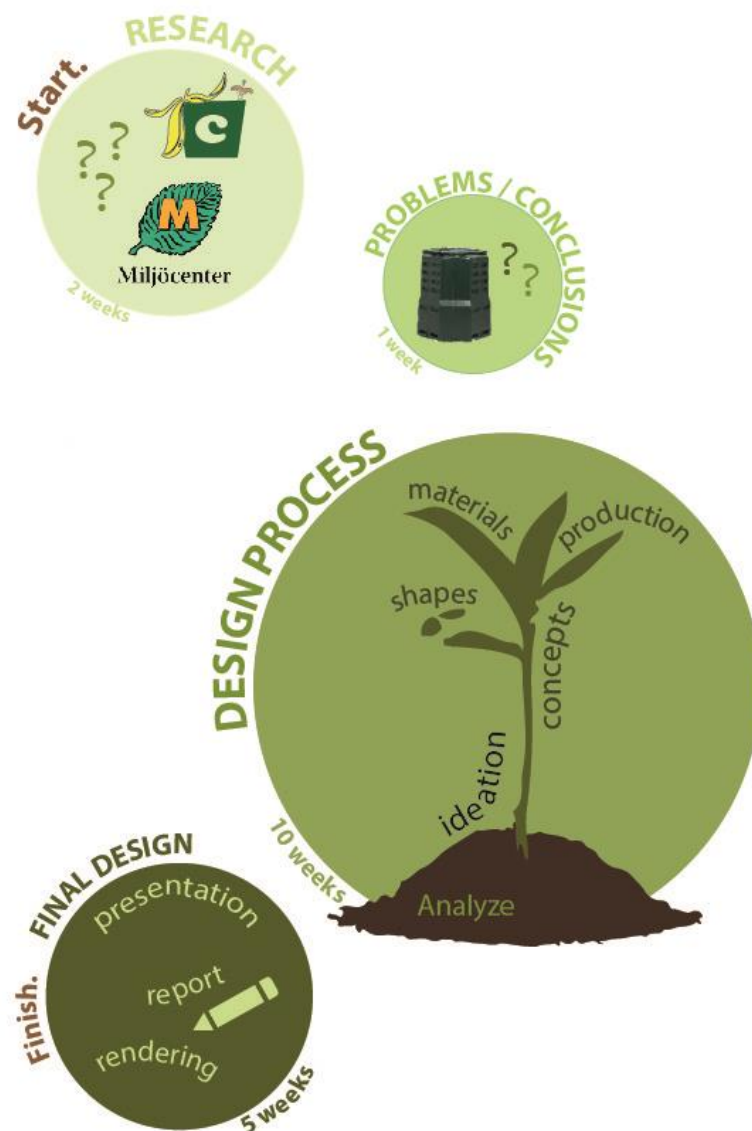

Figure 11 general planning

4.2 Research and analysis

4.2.1 Research

Since the new design has to solve the problems and improve the characteristics of the MiljöCenter containers, the research is mainly based in two parts.

The first part is to know about compost. What it is and how does it work.

The compost is a process to recycle the organic rests. It helps to follow the life cycle since use the “rubbish” to help the plants to grow up.

Oxygen, nitrogen, carbon and a correct temperature are the forth main factors in the process. Oxygen is a natural component, but nitrogen and carbon used to be in chemical products that you have to add to your container. Also keeping the heat is your work since it is necessary to have the compost above of 10 degrees. (Eliasson & Ramsbottom, 2003)

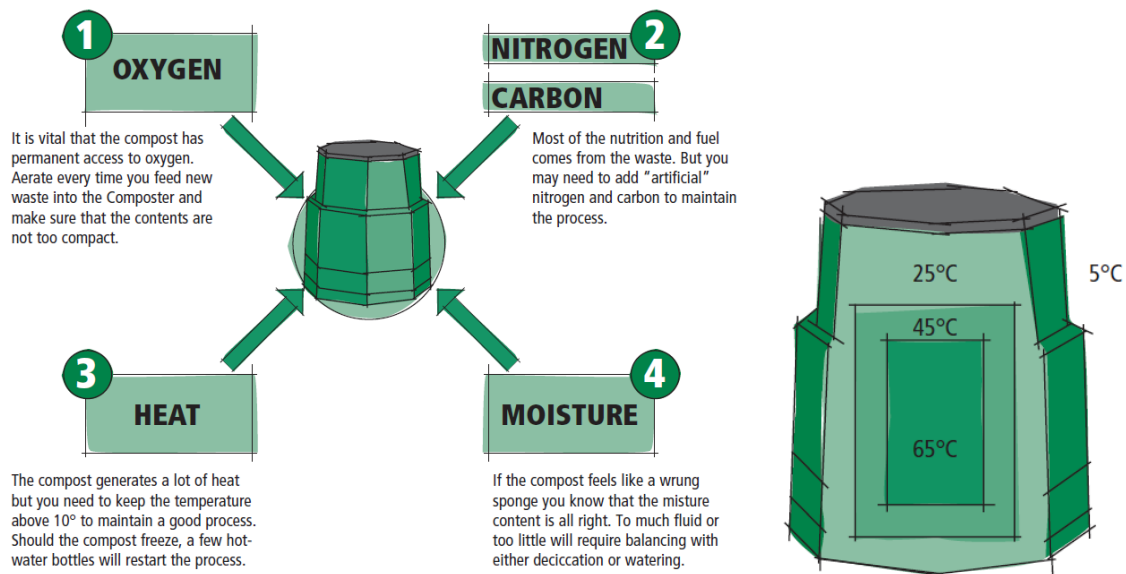

Figure 12 components of the compost

The process is showed in the follow image (Figure 13). The fungi, bacteria and microbe attack the rests and help to start the degrading process. Usually the process takes around six months to have a mature compost ready to use in your crops.

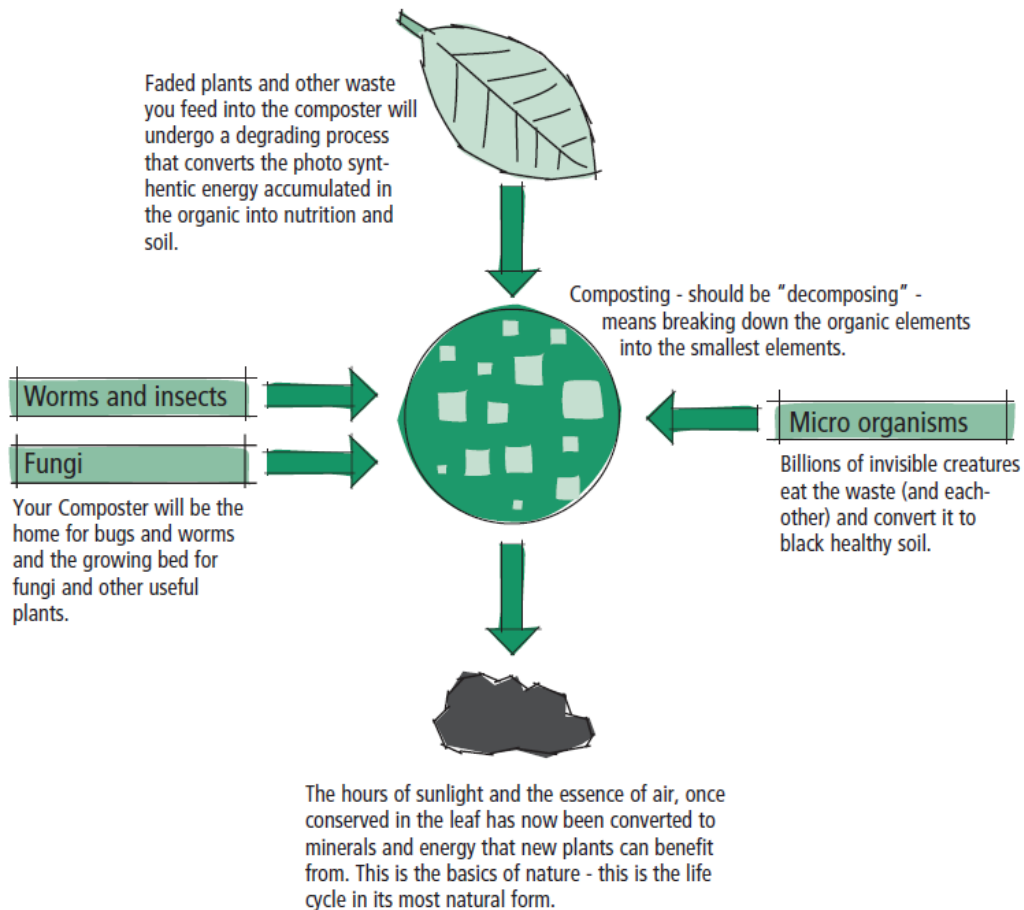

Figure 13 Compost process (Eliasson & Ramsbottom, 2003)

The compost as the result of the process, can be used in different places that are: agriculture, horticulture, vivarium and gardening.

One important factor is to know what products you can put inside the composter. They have to be organics, able to produce the compost and which ones don't produce odor.

The organic rest could come from the garden or from the household. The ones from the garden could be: leaves, grass, vegetables, straw used as mulch, pruned branches, sawdust, etc.. The ones from the house could be: ashes, coffee grounds or tea, infusions role included, eggshell, fruits and vegetables, no newspapers printed in color, expired yogurt, corks, paper towels, oil dressing, hair, etc..

Following the company's guide of how to make compost, the main factors to have into account apart the ones already mentioned, is the action of stir the compost every time that the user put organic products inside.

To finish, it is also common to use chemical products that accelerate the composting process, preventing odors and ensures a good result.

The second part of the research, is the data proportionate by the company about their own containers.

The third part of the project is to make a research about the composters in the market, especially the ones that cover the same needs and have the same users than the ones made by the company. This is equal to the Market analysis mentioned in the methods part.

The results of the research of the company help to draw the way of design following the brand image; they are going to help also to find the aspects that must be improved and the ones that are necessary and standard for the composters. These last ones are going to be defined also by the results of the research of the market or the market analysis.

On the other hand, the competitors and the most new technology applied to some new containers will help to the creative part of the project.

In summary it is possible to say that in general it is possible to divide the market of the composters in two types, the compost bin and the compost tumblers, as the Figure 14 shows.

All the information collected in the research method appears in the attachment 1.



Figure 8 Types of composters

4.2.2 Analysis

The information collected in the research is essential to make the analysis. The research is equal to the market analysis, and with it the form and structural analysis are consecutive in a directly way.

A correct and exhaustive analysis is very important to get main factors that the new container will have. It also will help in the creative process to come up with new ideas, characteristics and ways to improve the problems.

The analysis is not only to detected problems, it is also useful to know about the common factors of the composters, and also to know the essential features required for this kind of products.

4.2.2.1 Form analysis

After look at some of the composters that it is possible to buy nowadays, it is possible to get some conclusions about the formal shapes that they used to have. The Figure 15 shows a summary of those characteristics of the shape with some containers as representation. The kind of endings and the colors are part of this analysis.

The compost bin used to be asymmetrical in one of the axes, the horizontal one.

Because of the aperture on the bottom of the sides, or because of the general shape.

On the other hand, the compost tumbler used to be symmetric from all the axes. This is because the aperture or hole to extract the compost is not in the bottom, used to be in the lateral or main structure how it is named in the next analysis, in the Figure 16 (the structural analysis). And also, the lid is just another part like the bottom, is not the aperture to full the container.



Figure 9 formal analysis

4.2.2.2 Structural analysis

The structural analysis helps to distinguish the different parts of the container. This is also relevant to the shape as we can see in the Figure 16.

As it was mentioned in the previous analysis, in the compost bin the lid offers the possibility to be removed and then it has the function of full the container. On the other hand the compost tumbler used to have the lid like a part of the structure and it is just used to close the cylindrical main structure but it cannot be removed or opened to full the composter.

Apart of the lid, the container used to have the main structure with some holes that makes possible the aeration of the compost that is inside; and to finish the bottom.

In the bottom there are also differences depending of the type of composter. In the compost bin, the bottom is the base of the structure, therefore it has to be stronger and with enough ventilation for the compost. Nevertheless the bottom of the compost tumblers works like the lid, just to close the cylinder that works like the main structure. That also means that the cylinder has to have an aperture to full and empty the container.

To finish, it is possible to see that the compost tumblers has an additional piece. It is a support structure that holds the rest of the container and at the same time helps to turn the container and hence stir and mix the compost that the container contents.

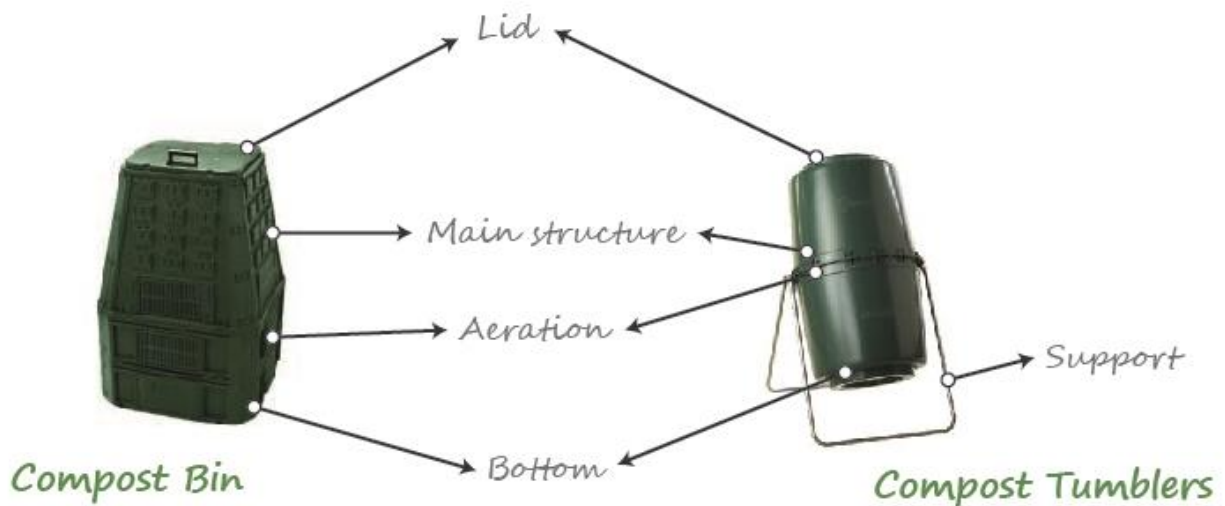

Figure 10 structural analysis

4.2.2.3 **Functional analysis**

As it was explained in the theoretical part, it is necessary to detect and clarify the functions of the product and which level are they. (CADI (Centro Aragonés de Diseño Industrial), 2009).

Below appear the division of functions of the composter.

MAIN FUNCTION: make compost → Implicit function: contain organic rest.

SECOND FUNCIONS: To know them, it is necessary to analyze the principal function. What is necessary to make compost? The correct temperature, oxygen, nitrogen, carbon. Then, the second functions of the composters are:

- Insulate.
- Aeration of compost.
- Safeguard the compost of animals.

OPTIONAL FUNCTIONS: this are the functions that appear only in some composters.

- Mix the compost
- Entertainment

In the design process those conclusions will be taken into account when the decision making will be carry out.

4.2.2.4 User analysis

As it is explained in the methods, the user is an essential factor in the design.

This product has an important part in the manufacturing and the transport, that's why it is necessary to study all the users and stakeholders. In the next image (Figure 17) appear every user that is in contact with the product during its life, in other words, the stakeholders of the product. All the groups starting with the manufacturing of the product and ending with the use of it by the consumer in the environment that has been design for.

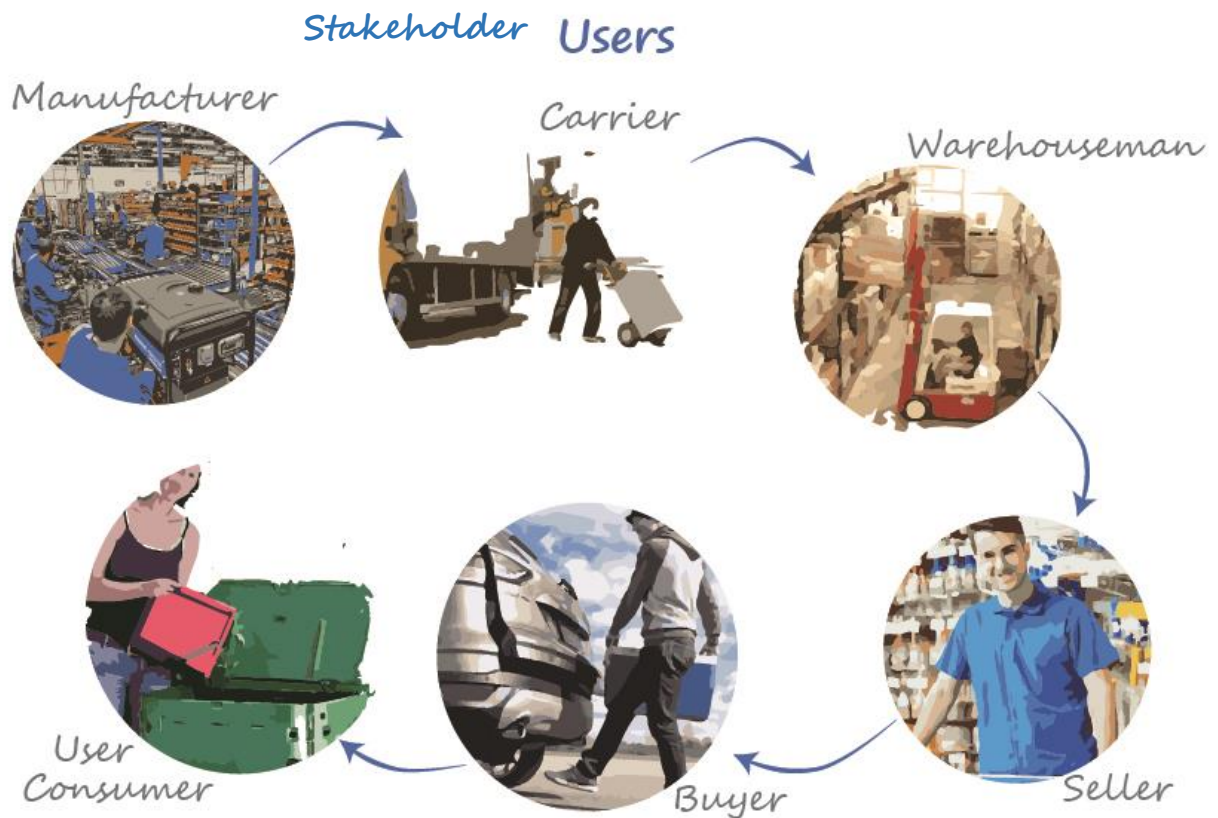

Figure 11 Stakeholders

Every group of users has a different task. After analyze those tasks, some problems have been detected. This will be useful to improve the characteristics of the container and solve the “bad conditions” that the existence ones produce to the users.

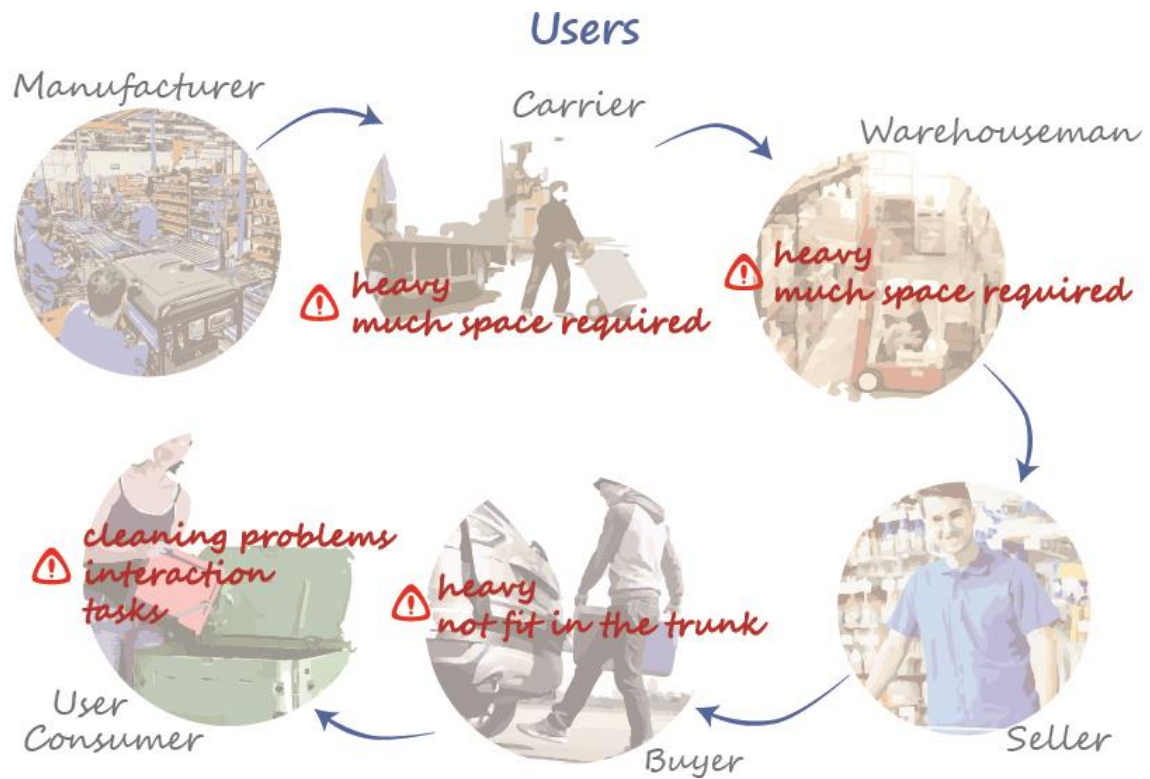

Figure 12 Problems detected

The stakeholder that is going to spend more time with the final product and is going to have more experience and therefore more potential problems or benefits, is the consumer.

Then, two main factors are going to be decisive for the design process. In first place, define the “teaser”, in other words, how is the user. And in second place, know the user sequence to know the tasks that the user is going to carry out.

In the Figure 19 is it possible to see the kind of buyers and users of the product. Following the line of the company, they produce for Sweden, families and people who has their own farm or orchard. Remembering the brief and the objectives stabilized at the beginning, one of them was to make the design more attractive also for kids. Then, the public could grow up and the users can be from kids to elderly persons. For example schools could have it to teach children how to grow their own food, families with garden, or people who just want to take care of environment and recycle the organic rests.

TEASER

who take care
of environment



who likes to
eat healthy



who has
garden



who grows his
own food



Figure 13 Teaser

The second step is to study and analyze the user sequence with the interactive process user - compostor will help to detected possible mistakes in the design and future improvements in the new product.

The problems of this part come to think in the existence containers of the company.

Is it possible to say that this way of analyze is the same of the research has been done. On one hand general products exists in the market and on the other hand the products of the company. In the Figure 21 appear the problems divided in general ones (with the general symbol of advertence) and the specific problems detected in the products of MiljöCenter (indicated with the logo of the company).

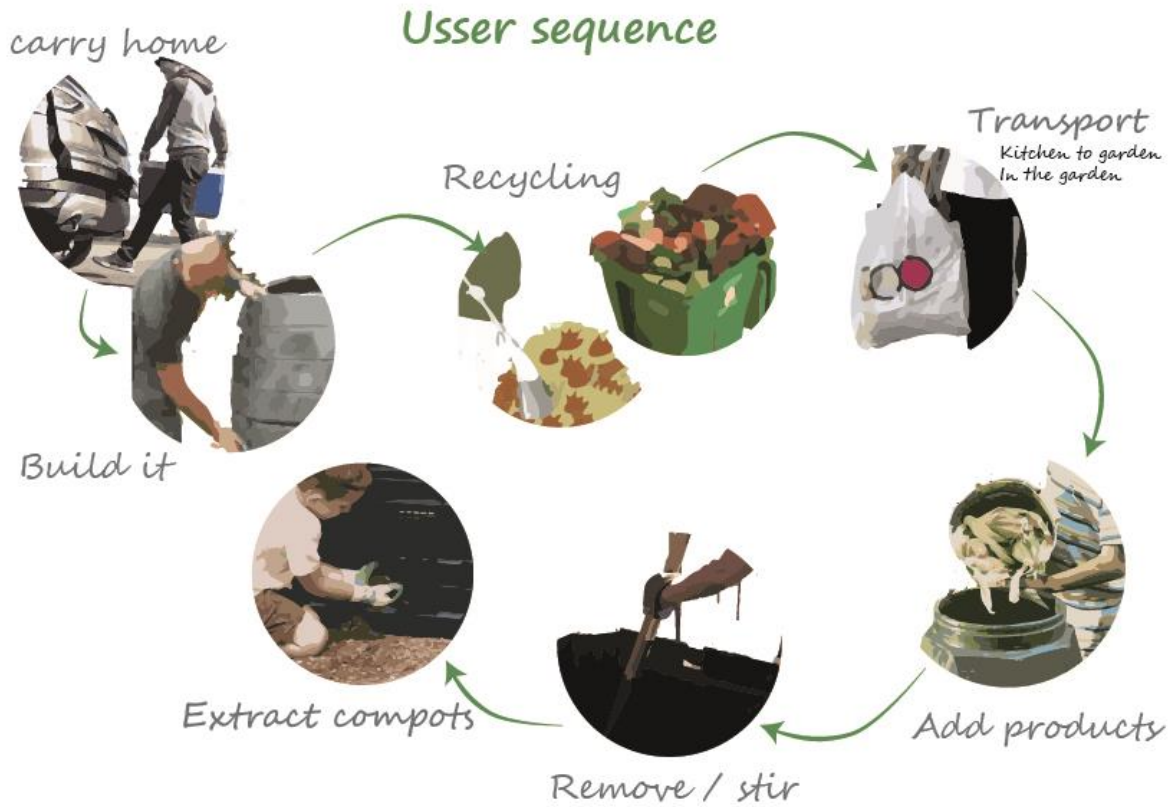

Figure 20 User sequence composter

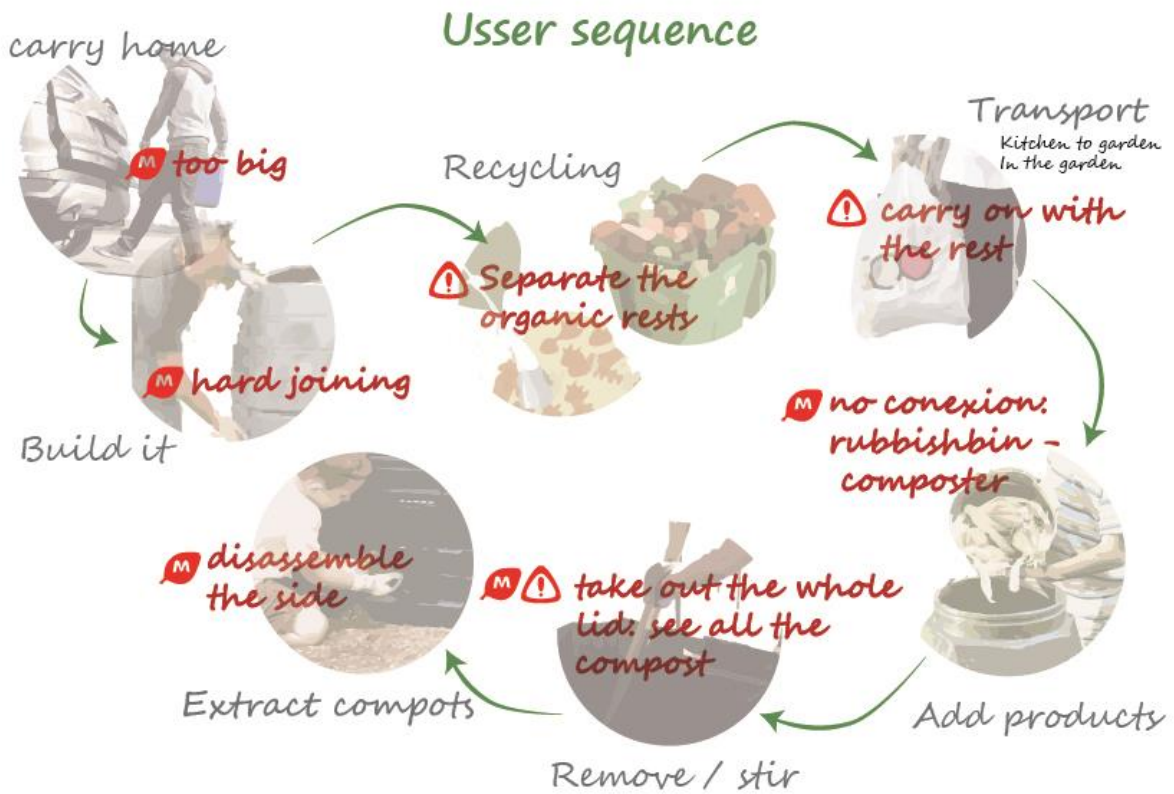

Figure 21 problems in the user sequence

4.2.2.5 Ergonomic analysis

The ergonomic analysis is the last analysis that has to be done.

In this part the relation between the product and the human dimensions is studied.

The dimensions of the product are fundamentals for this study, that's why it is necessary to take a look again to the research and bear in mind the sizes of the actual composters.

In addition, since one of the specifications marked at the beginning is to design a compost optimal for kids, adults and old people, it is essential to check efforts and human dimensions.

Thanks to the user analysis and the functional analysis it is possible to establish the main functions that entails the most critical postures showed in the Figure 22.



Figure 22 critical postures

Taking some ergonomic books as a reference, it is also possible check with measures could be optimum for the composter.

In this case, the reference could be the dimensions of some parts of the body that are going to have relation with the usual postures of the users as it was shown in the Figure 23. For example the high of the elbow and the hips are interesting for this project.

As it was explained in the theoretical background, the 90% of the population is considered when the measures has to be dimensioned.

This table will be checked again in the conceptualization process, when the product will be dimensioned.

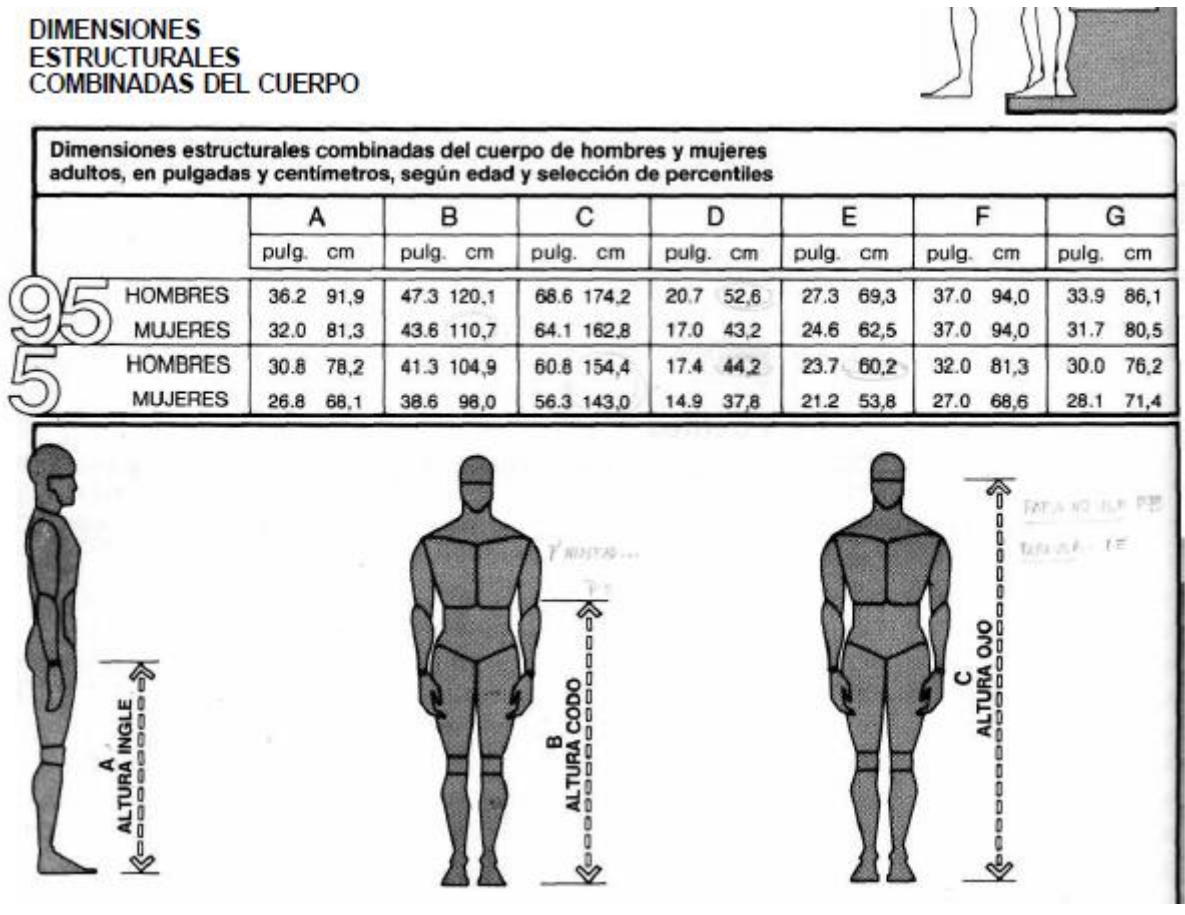

Figure 23 ergonomic measurements

4.3 The design process

The design process is a complete process made with different methods that have the final project like a result. The information recollected, and all the analysis made of that information helped to start the creative process.

The ideas come up from because of association of ideas and concepts learned in the first part of the project, and also because of the implementation of creative methods like brainstorming or mood board, that includes also association of ideas, experience and conceptualization.

Before to start with the different methods of the design process, is important to have a clear idea of the problems and main factors that is necessary have into account.

The next image shows in a visual and graphic way that conclusions obtained because of the previous phases.

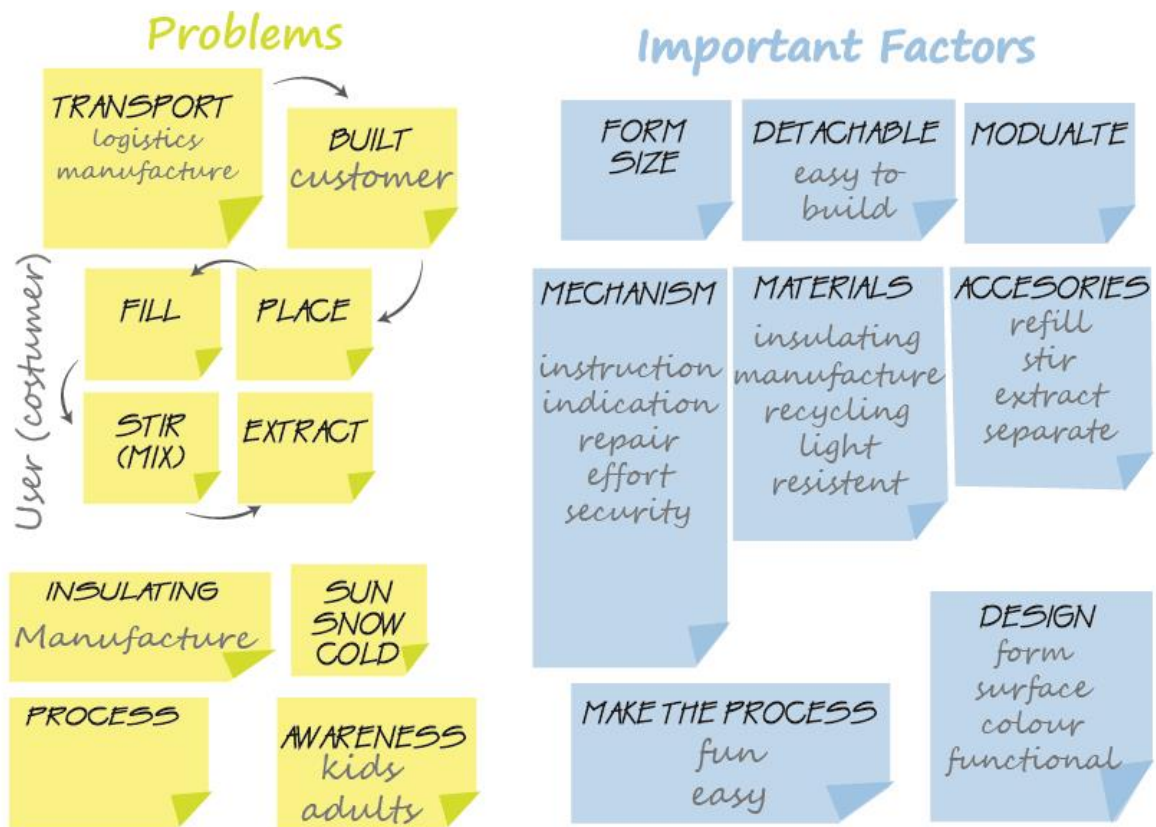

Figure 24 Conclusions

4.3.1 Brainstorming

As it is said before, the brainstorming is a good technique to get ideas and to associate them and get some solutions to the problems. (Kirchner & Lerma, 2010)

In the picture below appears the process of the brainstorming. The picture shows the brainstorming like was explained in the methods part. With the main word and all the associations word that appeared in mind from the first moment.

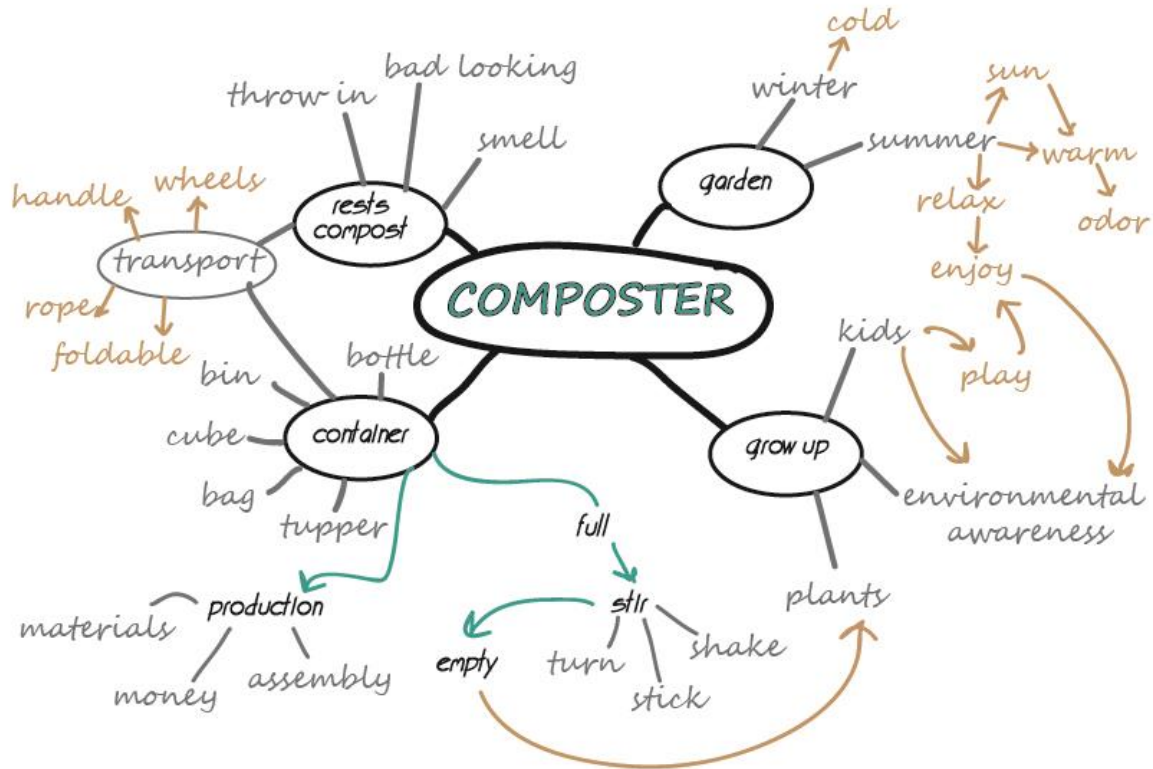

Figure 25 Brainstorming

4.3.2 Mood board

The following image shows the mood board made with some pictures that express the different facts that make some impact in the compost. The main goal of the mood panel is to show in a simple sight, how the product could look like. The style is defined by all the factors that appear there.

The mood board is just a tool to know what to take into account when the shapes and the form ideas will be born.



Figure 26 mood board

Following the same idea, and considering the research part of the different composters that exist in the market, another mood board works like an “inspiration help” to get the exterior shape of the new product.

Some composters that are possible to find in the market and some natural shapes that used to be close to the product, appear in the mood panel.



Figure 27 inspiration mood board

4.3.3 Ideation and conceptualization

After all the techniques applied before and explained in the previous points, it is time of the ideation and conceptualization. The concepts are clear and the ideas started to be in mind thanks to the different methods applied before, so in this chapter this ideas start to grow up shaped like sketches and concepts.

The ways to solve the problems entails ideas applied directly to possible future objects.

Mainly, the way to afford this part starts asking questions with the problems, and suggesting solutions in a graphic and visual way, including applications, shapes, and simple mechanism for the new composter.

In the next images is it possible to see this process, and after it, the evolution of this ideas taking into account the feedback from MiljöCenter.

The image below shows the possible mechanism that could be easier the task of mixture. One of the main problems during the use sequence is stir the compost. It is a necessary action required every time that the user put something in the container. A good mix is one of the factors that guarantee a good compost.

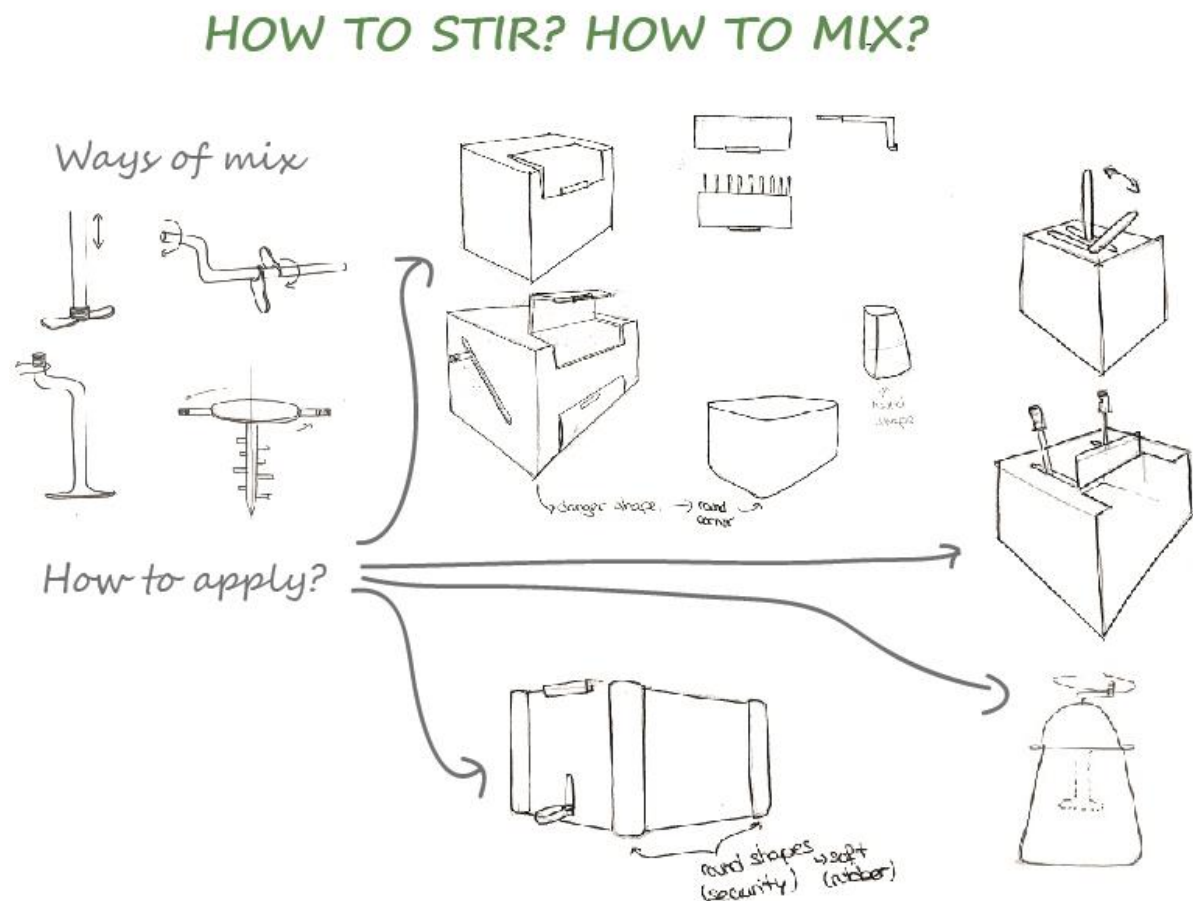

Figure 28 mechanism to stir

Other aspect to consider in the decision of the shape, is the possibility of modularity. For that, the next image shows simple shapes that can make the container modulate.

MODULATE SHAPES

*How to contain
the same volume
in an optional
way*

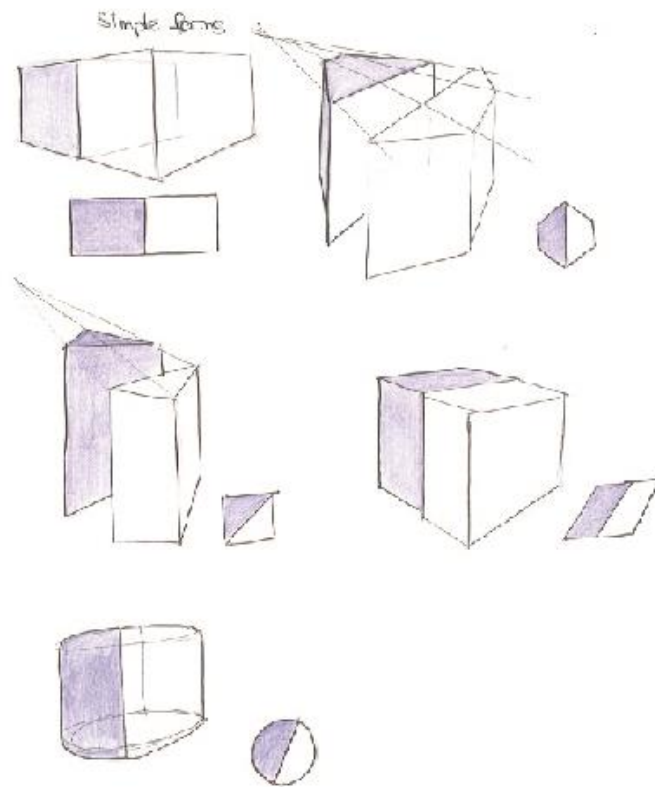

Figure 29 simple modules

*Module: “Each of a set of standardized parts or independent units that can be used to construct a more complex structure, such as an item of furniture or a building” (Oxford Dictionaries, 2014)

Other of the questions of the company, and one of the main actual problems, was the absence of relation between the different products involved in the process of compost.

The next image shows how could be possible to integrate the two main products of the process of compost. The garbage bin usually place in the kitchen, and the main container that has the compost inside.

HOW TO RELATIONATE THE PRODUCTS?

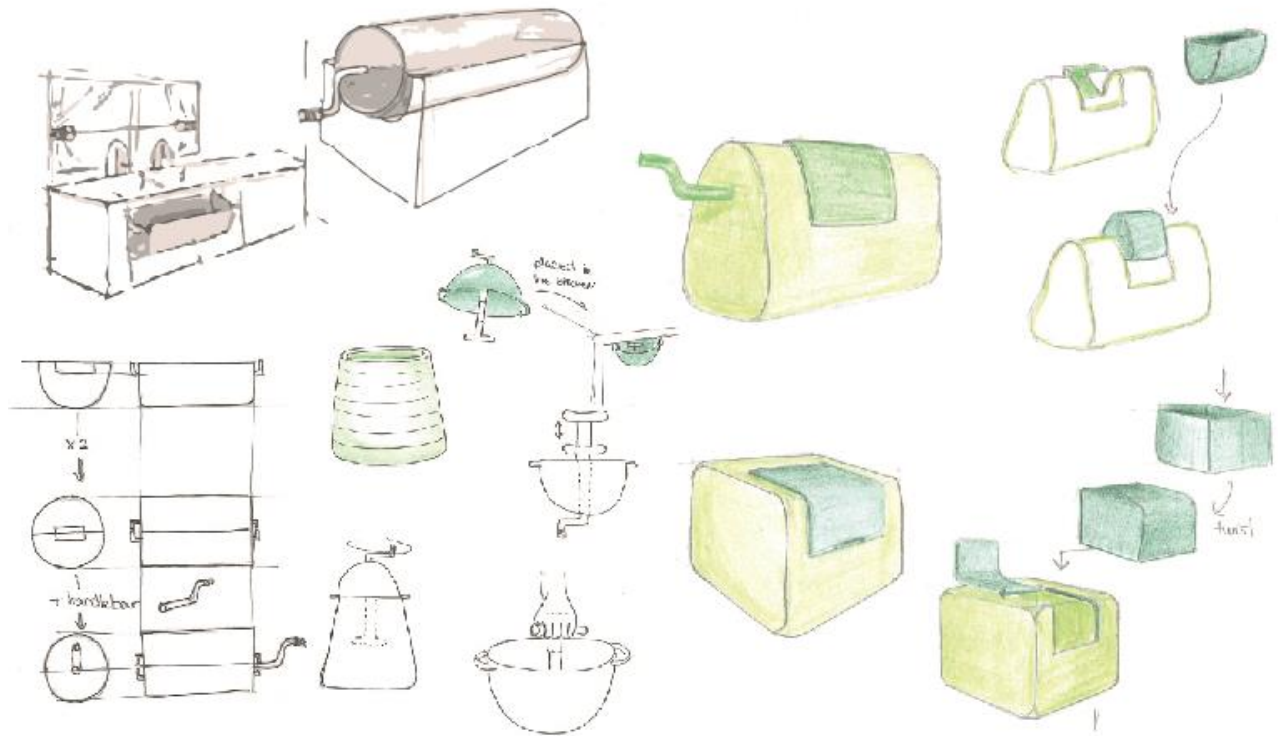

Figure 30 possible family of products

Another essential factor for improving the new design is how the composter looks like when is ready to transport. Below, the image shows the first ideas to reduce space.

HOW TO REDUCE SPACE IN THE TRANSPORT?

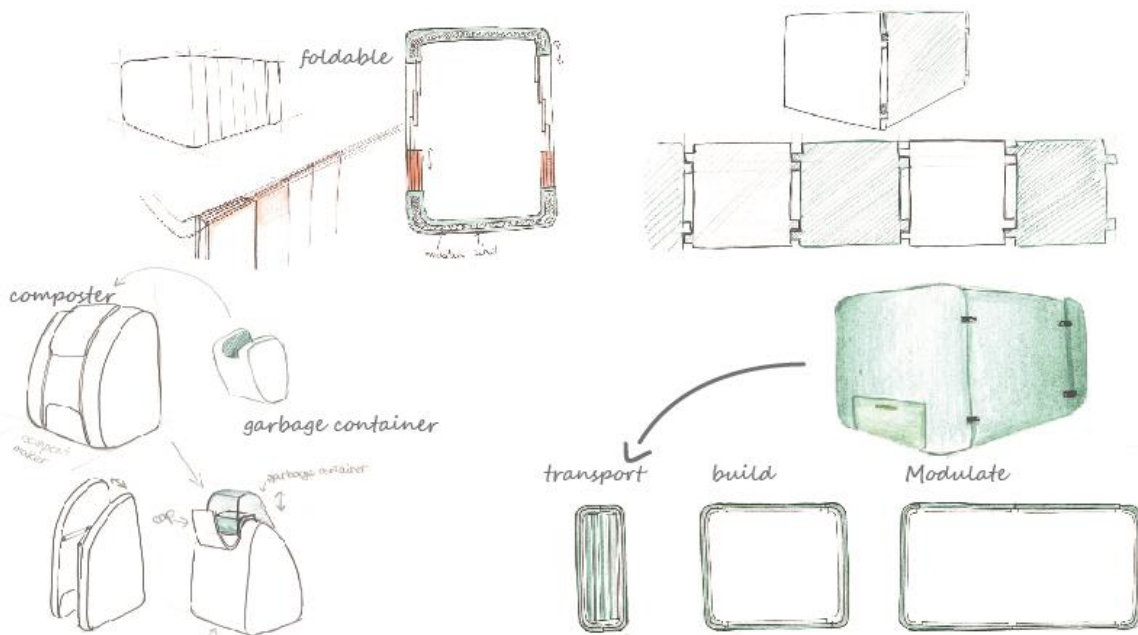

Figure 31 first ideas to reduce space

MEETING 2.

The second meeting took place in Malmö. Before of that some feedback was given by the company about the first ideas.

The goal of the meeting was have a closer idea about how the company works, and what the composters look like, the problems that could appear, know more about the costumers though the data base....

The conclusions of this meeting appear in the next image. How is it possible to see, the meeting clarified the compulsory requirements of composters in general and the aspects of the composters of the company.

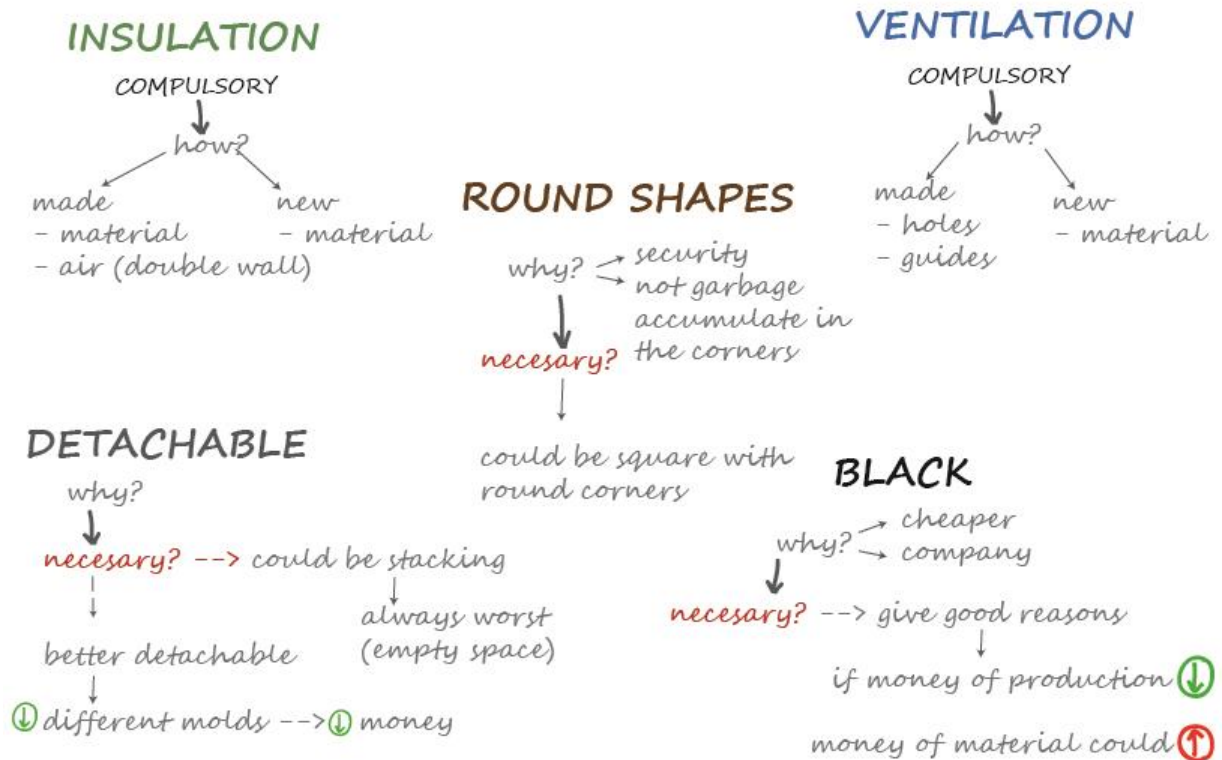

Figure 32 conclusions second meeting

The next ideas come up with the results of the meeting, taking the most important points like a “start” and an “inspiration” for the ideation and also the previous ideas of the first part.

So, those first ideas suffered some modification to get the concepts that have been developed from this point forward.

The two concepts appear in the next image like a summary of the design process represented in the attachment 3. There appear the process from the beginning of the idea and the problems till the two concepts going through the design process.

CONCEPT 1

LATERAL, SIDES: 2 PIECES

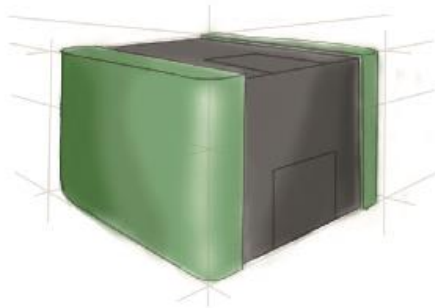

2 DIFFERENT
MOLDS FOR SIDES/PARTS

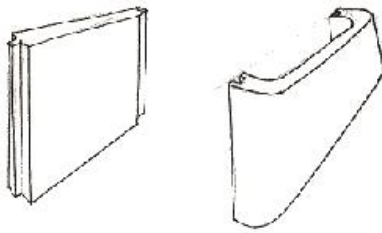

CONCEPT 2

LATERAL, SIDES: 1 PIECES

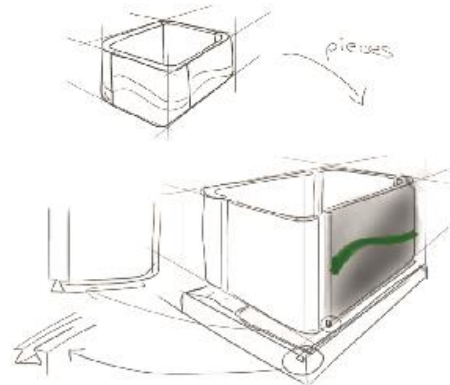

Figure 33 concepts

Both concepts try to improve the logistics and also the form aspect of the MiljöCenter containers.

The concepts are the result of a studio of the main factors that the company consider more important. The two concepts try to occupy the less space as possible to have the maximum number of containers in the same pallet and also to make easier to transport to the different users that have to carry on with it like the carrier, the warehouseman and the buyer.

On the other hand, both concepts have a simple mechanism of fixing and attaching the different pieces in order to make easier the task of assembly to the user.

In addition it is also important notice about how the molds for the manufacturing of the pieces will look like. Since there are only two or even one unique piece in the part of the sides, plus the bottom and the lid the costs of production are going to decrease because of the reduction of number of molds.

Once that the proportion and the main shape was designed for the two concepts, the next step is to dimension the pieces taking into account the capacity of the composters of MiljöCenter.

Since the sales leader composter is the one of 375 L, the study of the sizes has been developed to get a quite similar volume in the new product.

The sizes have been studied also taking into account the dimensions of a pallet how it is shown in the next images.

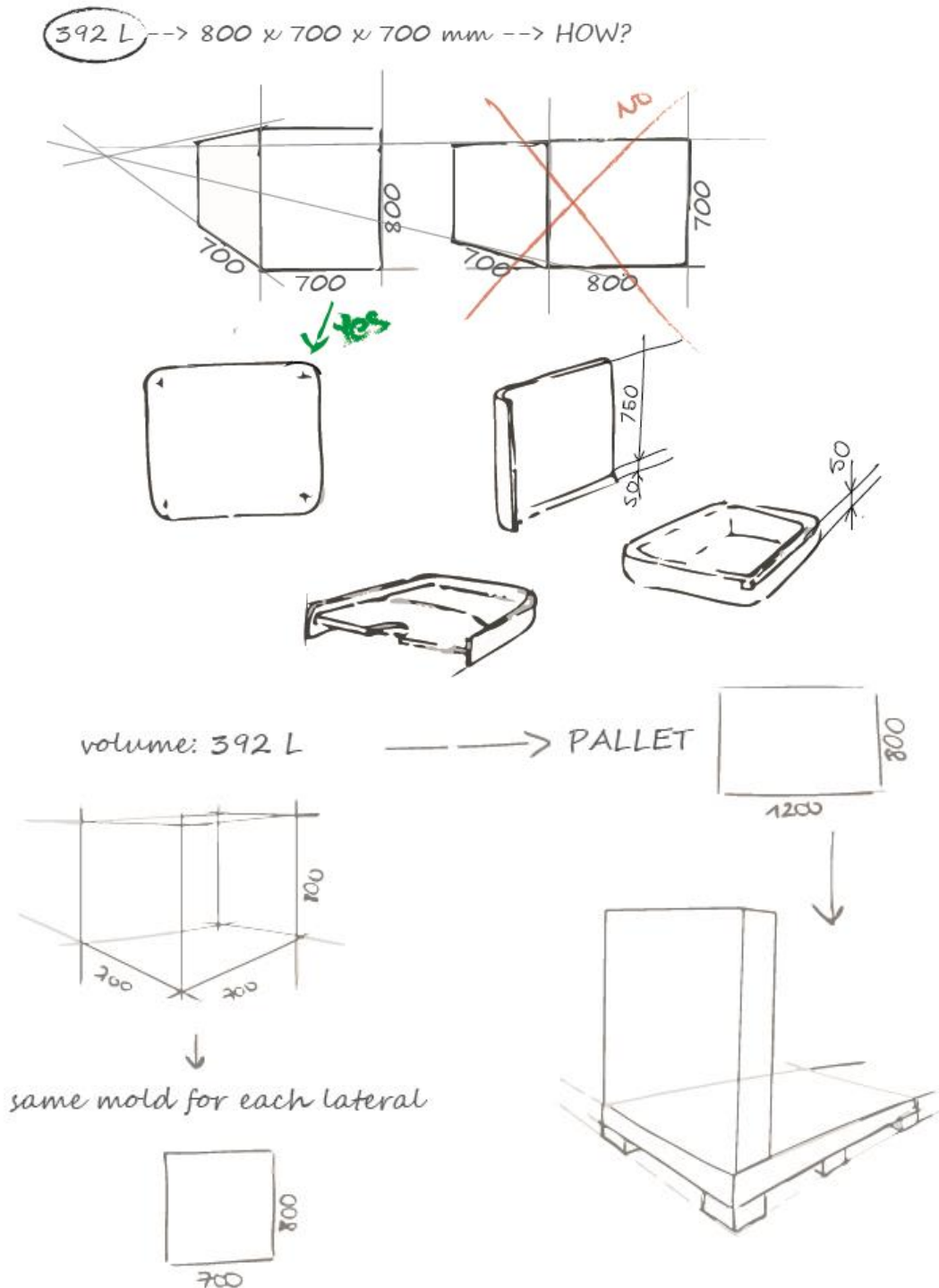

Figure 34 dimensions

Once that the measures has been dimensioned following the logistics and the pallet, it is necessary to checked if they are optimal for the average body sizes.

Following the book Human dimensions and interior spaces, and knowing because of the use analysis that the main relation of the customer with the product is standing up, we will need the high of the elbow to know if the user is able to open the lid, full the container and stir the compost. In the Figure 35 it is possible to see that the biggest size (95% man) is 120,1 cm and the smallest one (5% woman) is 96 cm.

Since some estimation of measures was already done (Figure 34), it could be just checked with the following tables (Figure 35). The height and the weigh are the most important sizes in this product and the ones that are going to allow the user to make the tasks required for the container. Then, following the red circles placed in the tables, it is possible to say that 800 cm is correct since is below the smallest size (percentile 5% woman). That also means that the kids are going to be able to use it, and this was one of the requirements stabilized at the beginning of the project.

Referring to the weight, the lid would be perfect if is between 38,5 and 52,9 cm of weight, then the users will have a comfortable handling of the tools in the container with both hands at the same time

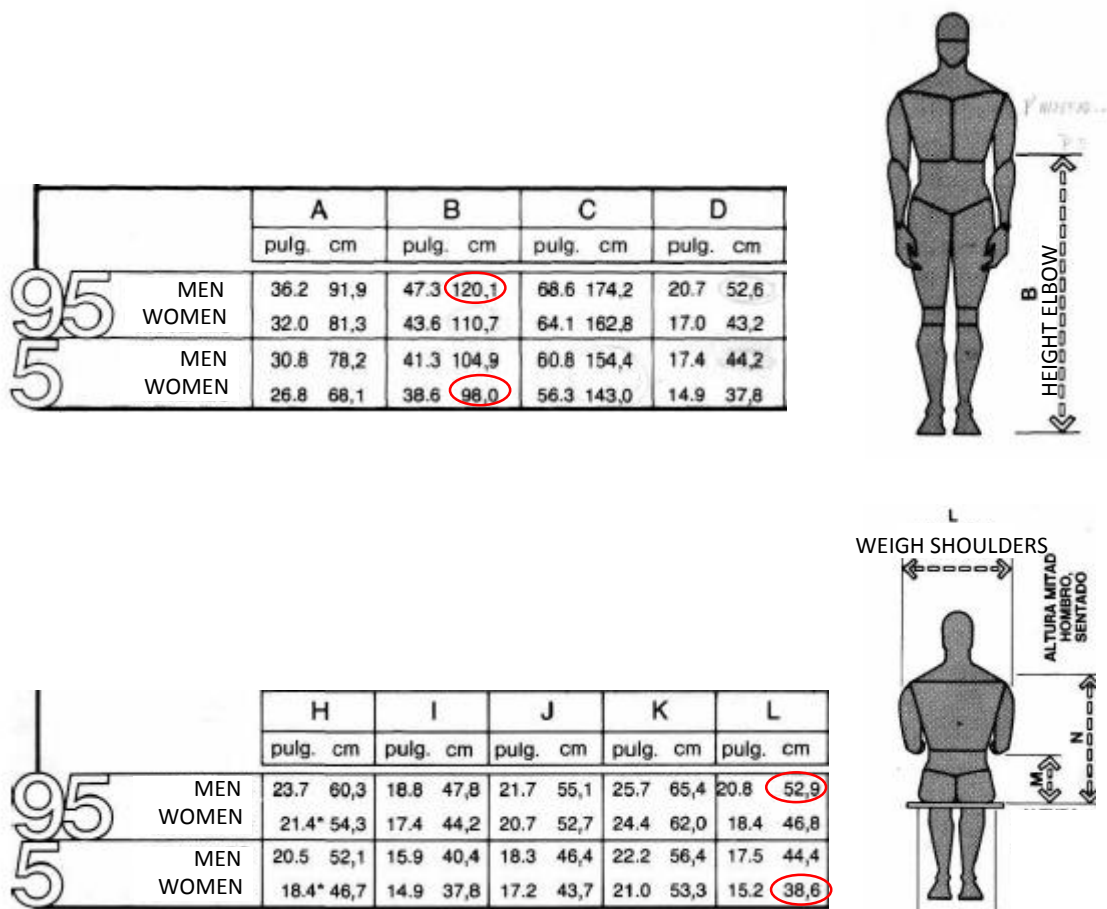

Figure 35 elbow dimensions

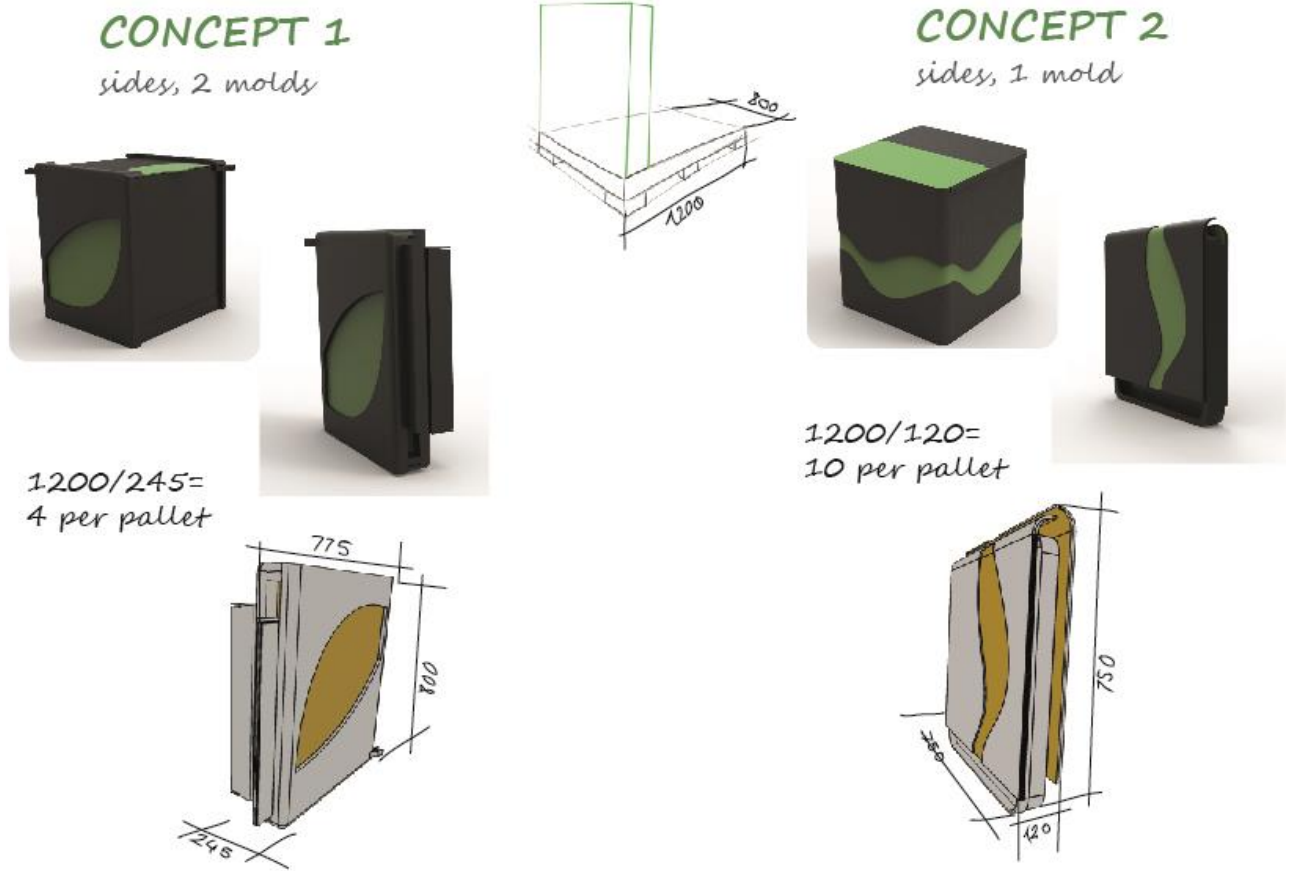

Figure 36 dimensions of the concept 1 & 2

The both concepts were developed in more details to have more information and be able to decide which one could be the best one.

There are two main differences between the two concepts.

The concept 1, has two different pieces that form the lateral of the compost. This fact makes the container modulate, how you can see in the Figure 38. That means that if you need more volume to keep the compost you can place another bottom (or base) attached to the first one and have the double of volume.



Figure 37 concept 1

CONCEPT 1

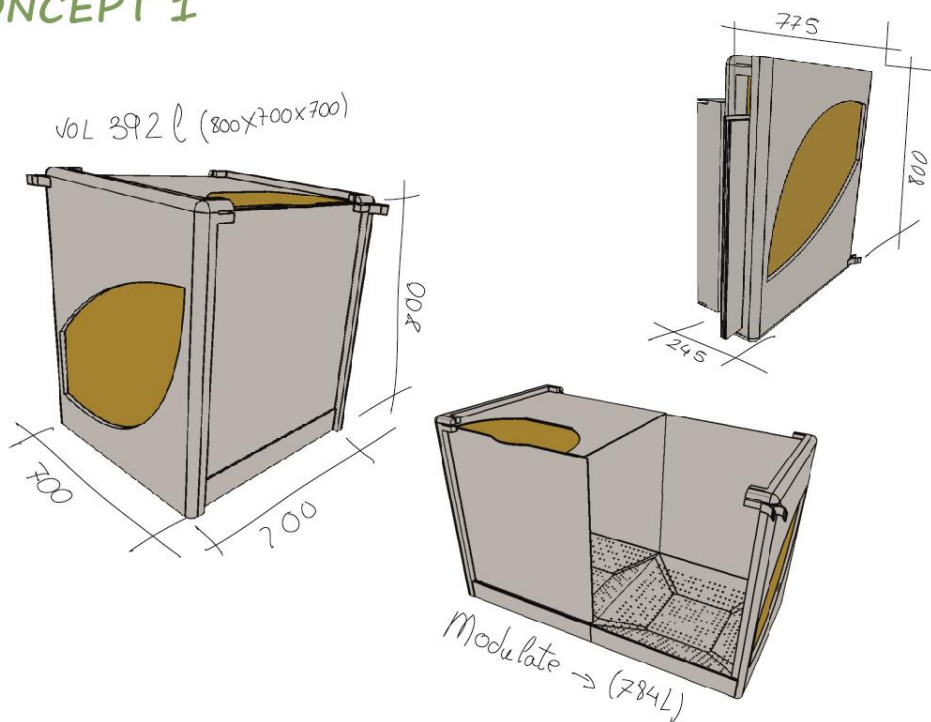

Figure 38 visualization concept 1

The second concept has only one type of piece in the structure of the lateral. That means that the production is cheaper because only one mold is necessary to make the pieces. It is not modulate but because of the shape you can also place two composter together.

CONCEPT 2

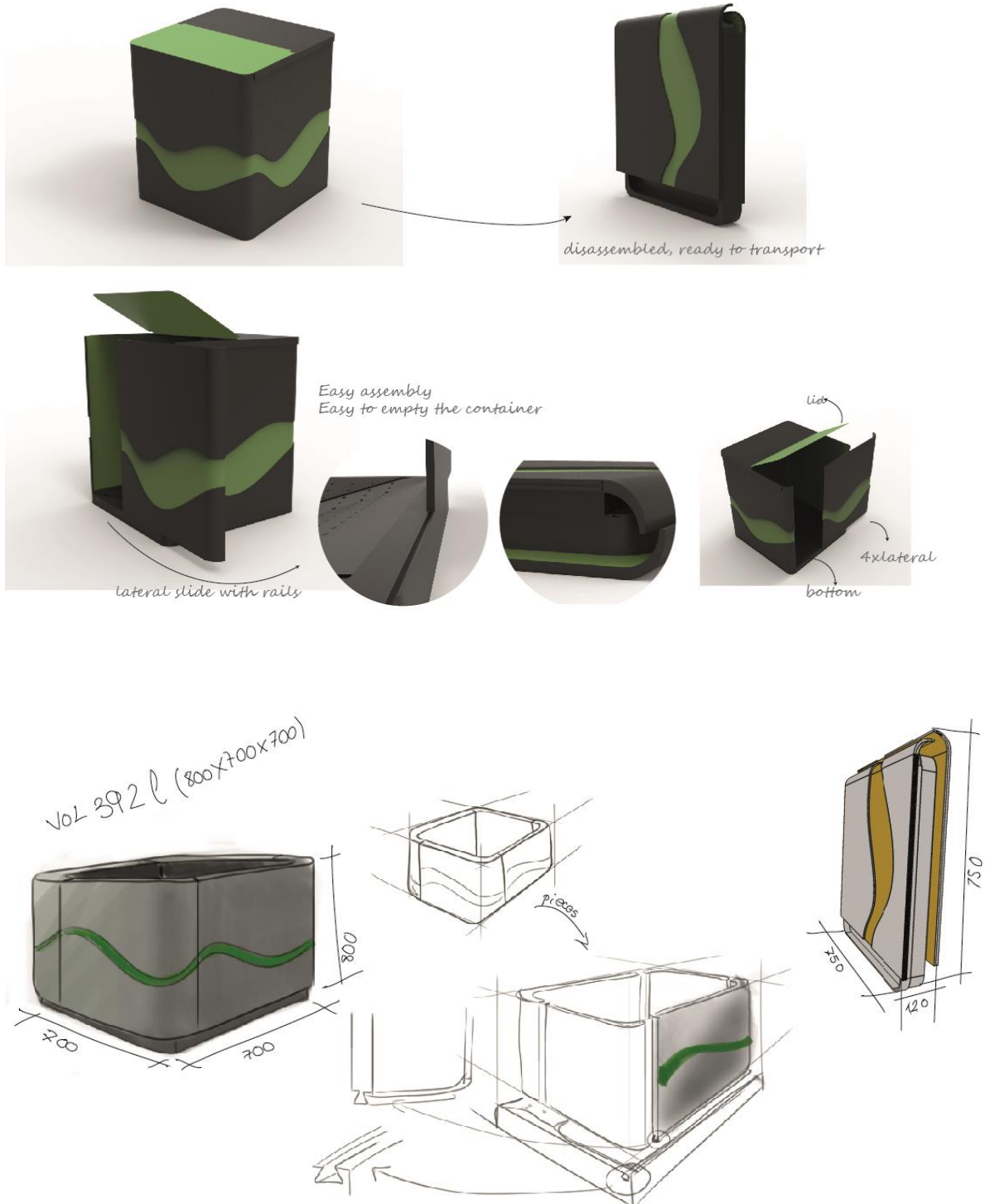
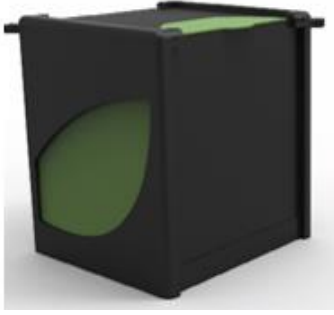
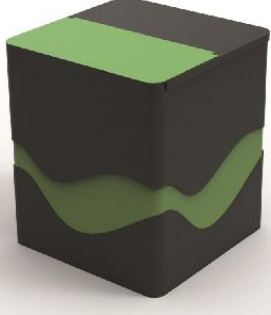

Figure 39 visualization concept 2

One of the concepts has to be selected to finalice of develop the idea and get the final result. To make the decision, is a good idea to use comparison tables like the next one:

	CONCEPT 1		CONCEPT 2
			
Manufacturing	2 molds	●	1 mold
Assembly (secure)	Possibility of deformation	●	Round corners, more resistant
Attachment (easy)	Easy to attach	●	Easy to attach
Transport	4 in the base of the pallet	●	10 in the base of the pallet
Exterior design	Similar design	●	Similar design
Modulate	Can be modulate ●		No modulate

The concept that has the green point is the one who fit better with the proprieties written in the first column. The yellow point indicates the proprieties that both concepts have in the same level. Following this criteria, the concept 2 is the best one.

Referring to the last propriety, the modularity, it is possible to argue that the concept 2 is better even though it is not modulate. The explanation is simple. If the user place two composter like the concept 1 (Figure 40) together, he will spare only one side. The reason is the follow: the user who want 600 L is because he wants to have one part to make the new compost, and other one to keep the one that is in maturation process. This means that he will need a side between the both bases to separate the two different composts. Then, instead of spare two sides, he is only going to spare one.

For that reason, the amount of money and material saving in the production is not so high, and makes the concept two a better option.

To finish, if the shape when both concepts are joined with other one, is analyzed, the result is quite similar (Figures 40 and 41), so the benefit of the concept 1 is almost null.

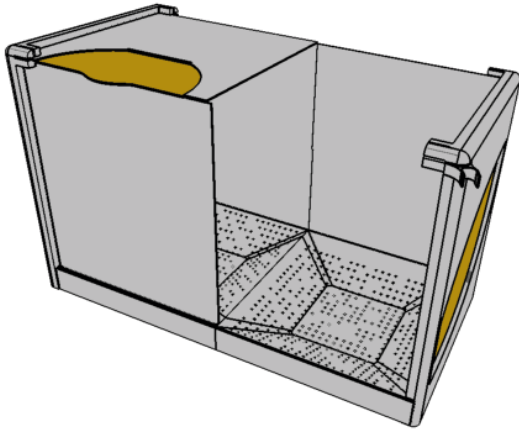

Figure 40 concept 1 modulate

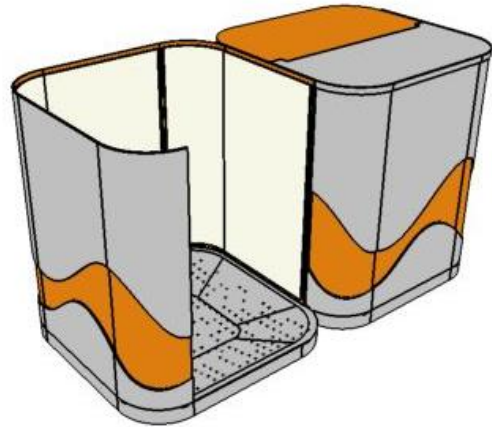

Figure 41 concept 2 modulate

The next step is to develop details of the concept that have been selected. In the visualization part, the concept 2 appear more defined applying tools of representation of products like sketching and rendering to show details in a proper visual way.

4.3.4 Technical aspects

4.3.4.1 Election of materials

This part is an important section where several main facts and requirements of the product have to be bear out.

Five different group of proprieties has to be cover by the material.

- Physical proprieties: resistance to the weather, stiffness, hardness,
- Economy aspects: developing and manufacturing
- Environmental aspects: environmental friendly, recyclable.
- Security: kids, animals, stability, use
- Perdurability: use, weather.

On the other hand, the information recollected through the market analysis says that the materials used in the manufacturing of composters are wood, metal and plastic, especially PP (polypropylene). And according with the information of the company, the material used by MiljöCenter is the PP.

Looking at the both parts, the information and the proprieties required the material selected is the PP (polypropylene). (Hindle, 2014)

The metal could also cover the specifications required referring to the physical aspects, but it is less environmental friendly and more expensive taking into account the process of production (modelling) and also the systems that the company already have, like the machines to produce the plastic pieces.

Following the theory of a green product, it is possible to see how the aspects of the life cycle have been taken into account. The material processing and manufacturing of the plastic is better for the environment than the metal, and also it is recyclable, so at the end of the life of the product, the material is going to be reused.



Figure 42 Aspects of the life cycle (Solid works, 2014)

4.3.4.2 Dimensions

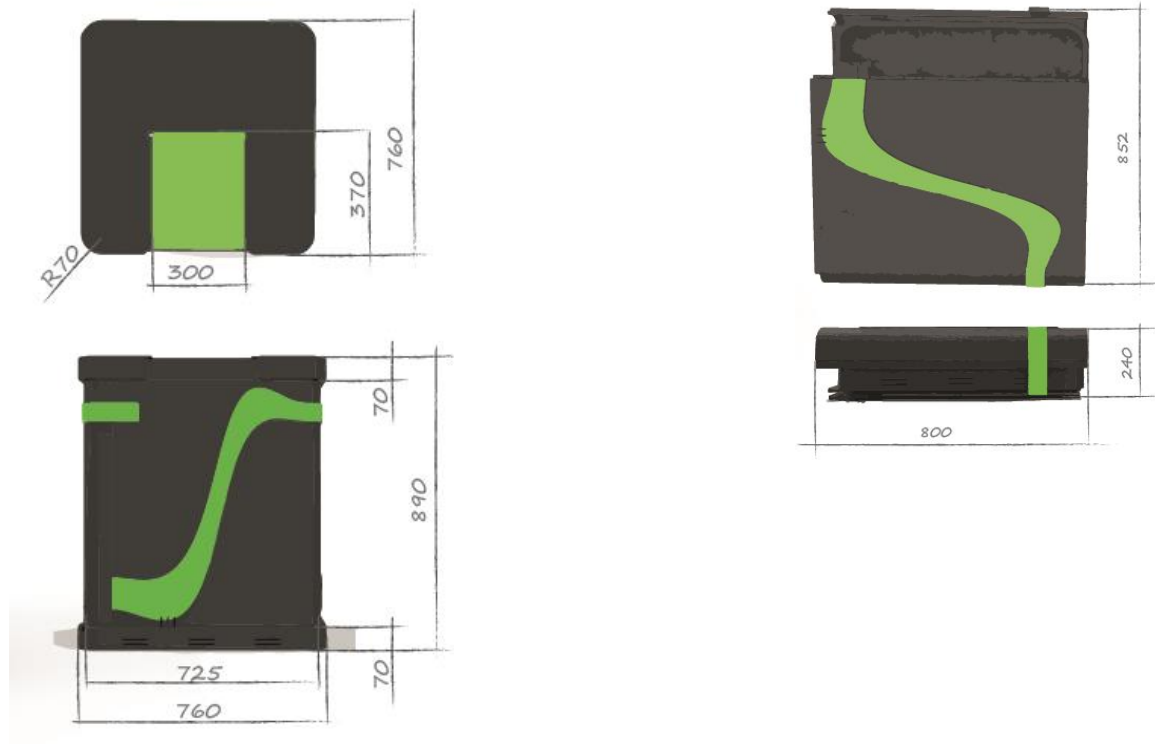

4.4 Visualization

The process of development of the idea required of the sketching and modelling skills. The sketches and the 3D computer models have been done applying manual tools and also some programs like Sketchbook for the sketches and Autodesk Inventor, Solidworks and Keyshot for the renders.

To start, all the pieces are going to be showed. The composter has 4 different molds of PP. The lateral or side, the bottom, the coverlid and the lid. (Left to right in the Figure 43)



Figure 43 pieces of the composter

The four pieces proportionate a consistent structure able to be placed outside and bear strong weather, possible thrust and bending stresses when the container will be full.

The picture below shows the different parts that have to be strong enough to all that factors named before, and why they will be optimal.

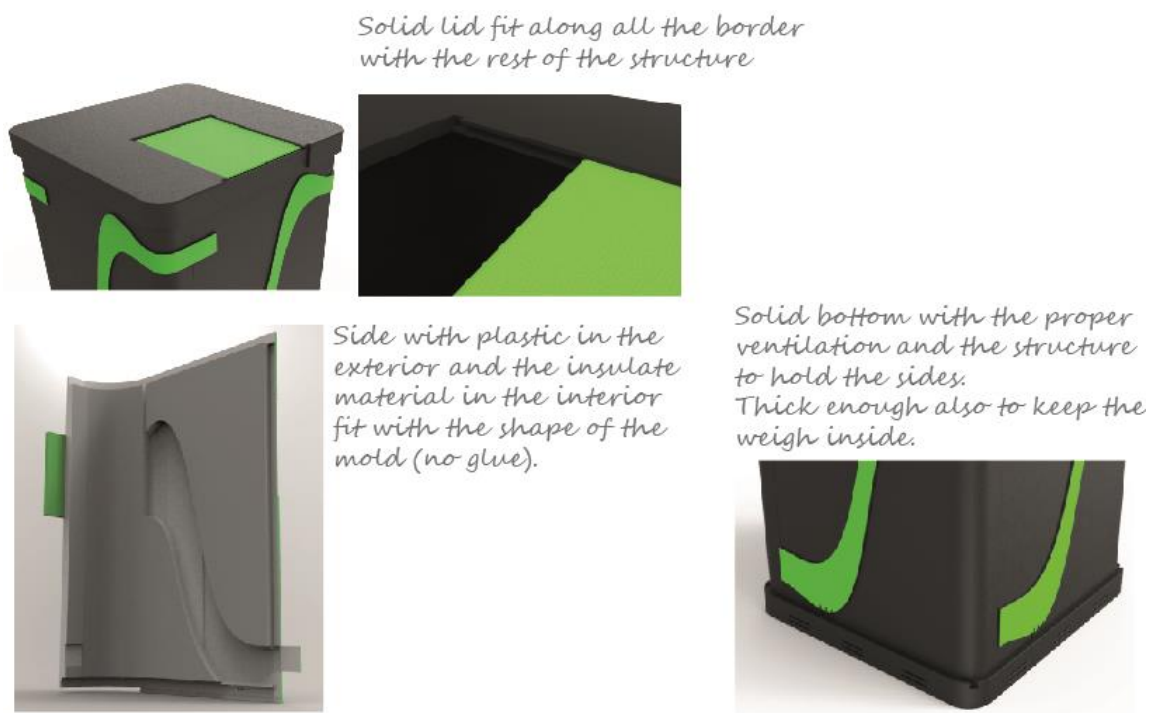

Figure 44 resistance aspects

Two of the four pieces, the bottom and the side are designed to get an optimal aeration to the compost saved inside the whole structure. In the next images the ventilation system appear defined after some process of sketching and investigation. This whole process appears in the Attachment 4.

In conclusion and as it is possible to see in the Figures 44 and 45, the plastic exterior side has an outgoing– incoming that makes possible the aeration and the bottom part (Figure 46) has also a holes in the sides that make easier the ventilation though the holes in the bottom.

The interior insulation sheet is divided in two parts to keep the hole and allow the air goes through the guide. Since the temperature inside is quite high (25 degrees) (Eliasson & Ramsbottom, 2003) the air will be warm. Moreover, owing to warm air rises, the circulation of the air is going to be like the blue arrow shows in the Figure 45. The holes from the bottom allows the air to go inside, it cross diagonally the piece through the outgoing made with the mold, and finally the air comes out across the holes of the upper part.

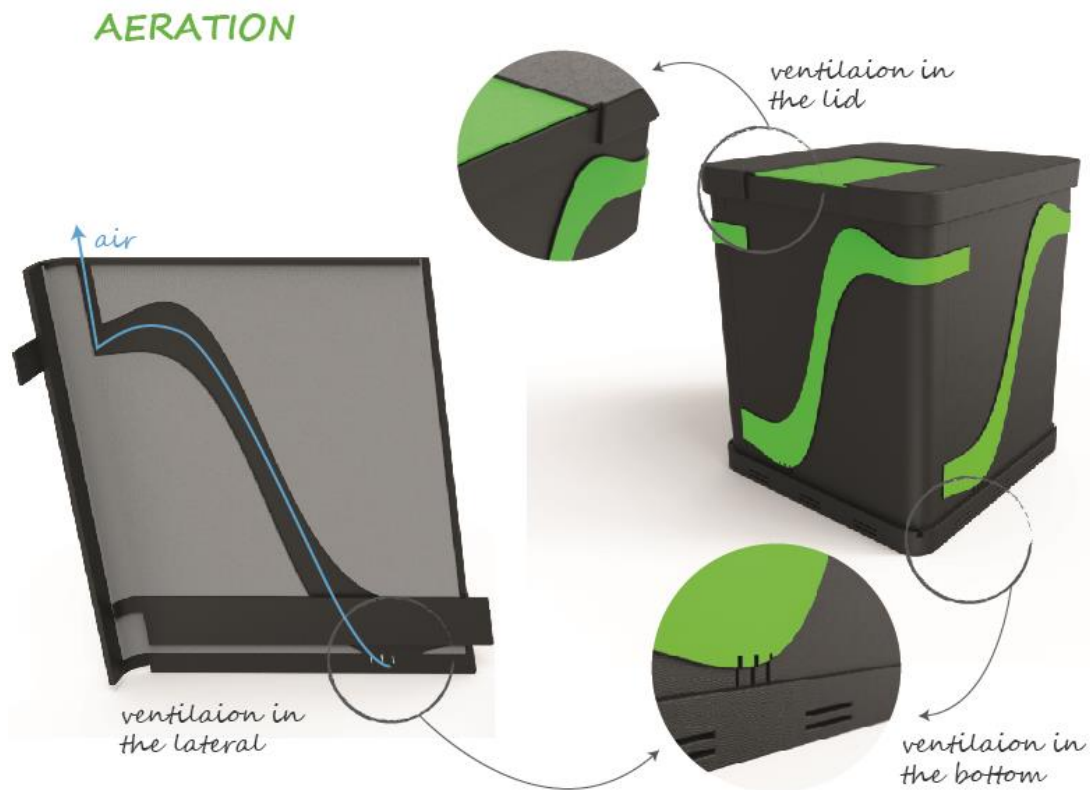

Figure 45 Ventilation

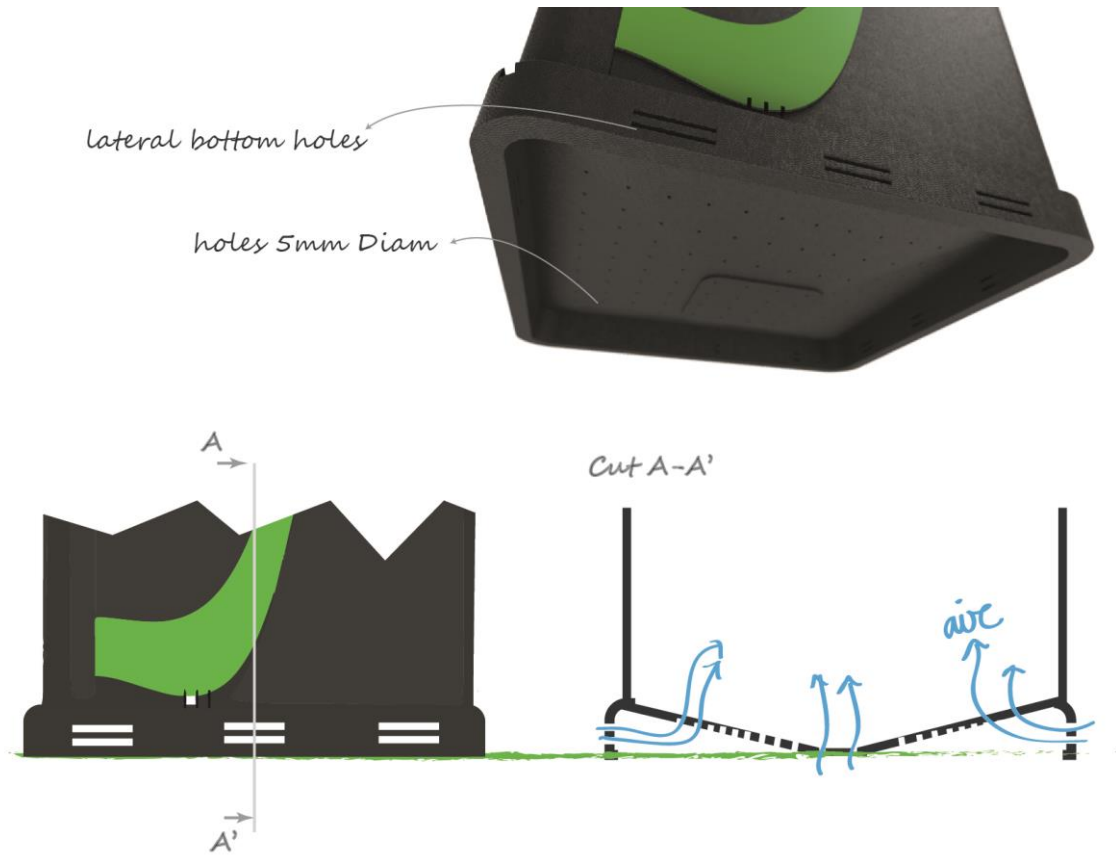

Figure 46 Aeration in the bottom

To finish, the overall aspect of the new composter is showed in the images below. All the improvements and the presentation of the product are show in the next chapter.

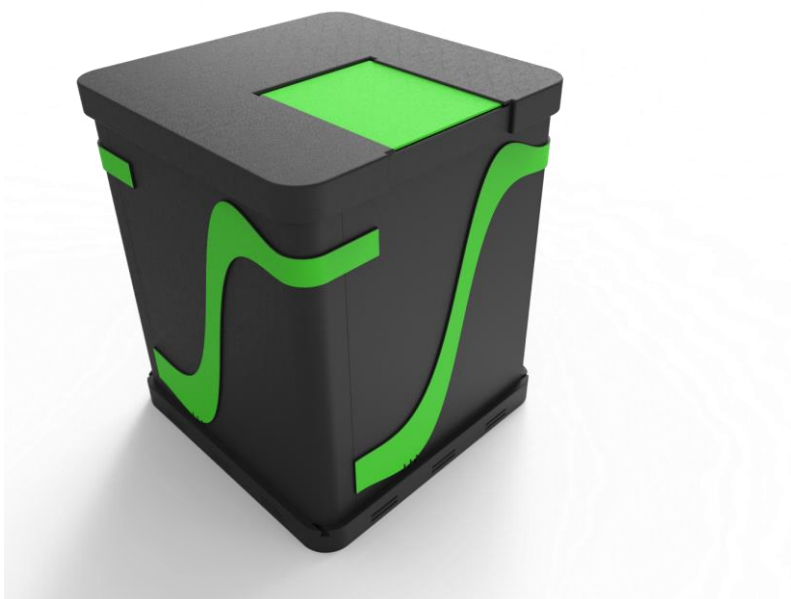



Figure 47 final visualization

Remembering one of the first requirements of the company, the following idea has been developed. The company want to have a relationship between the products and get a connection to make more attractive the whole process of composting. The next image shows one idea about how the company could produce a family of products.

This family or products could involve the whole process, from the kitchen where you can throw the organic rests to the garden where you have to keep all the necessaries accessories for the container.

FAMILY OF PRODUCTS

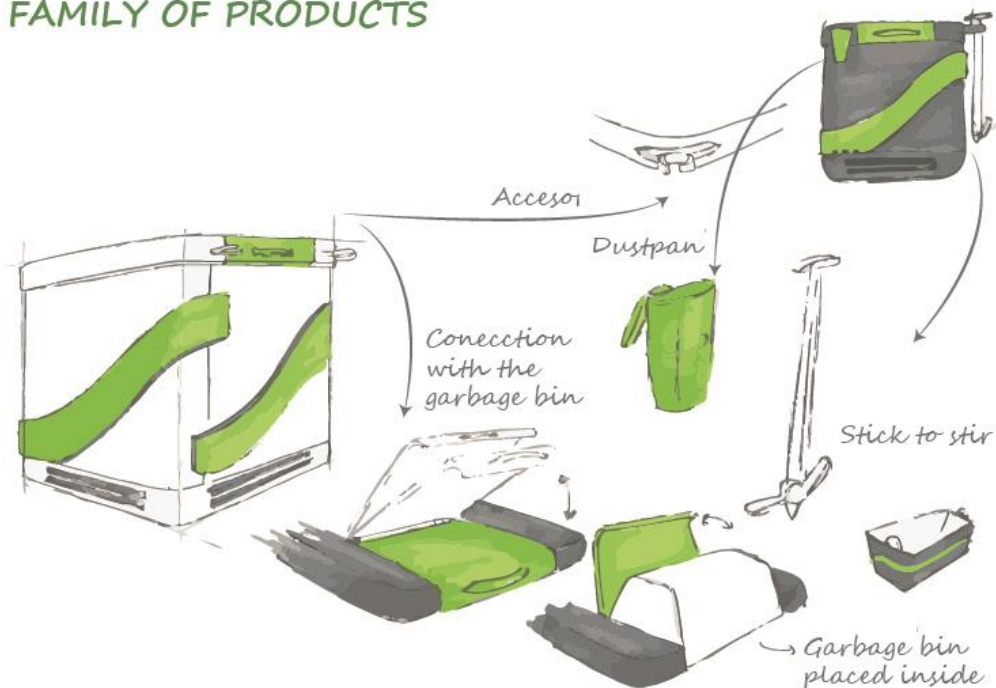

Figure 48 family of products

To get this compost station and the connection between the rest of products. It is necessary know what it is necessary for the whole process of compost. Helped by the analysis of user and the sequence of used analyzed in the previous part, it is known that the products necessary are: a rubbish can for the kitchen, to save the organic rests, a tick to stir the compost, a bucket to put the chemical products inside and the composter.

As the next image shows (Figure 49) the lid of the composter has two “rings” where it is possible to hold the stick and the bucket. In addition the shape of the rubbish can fits with the small lid of the big composter. Then, all the products are connected achieving the goal of get a whole compost station.

FAMILY OF PRODUCTS compost station

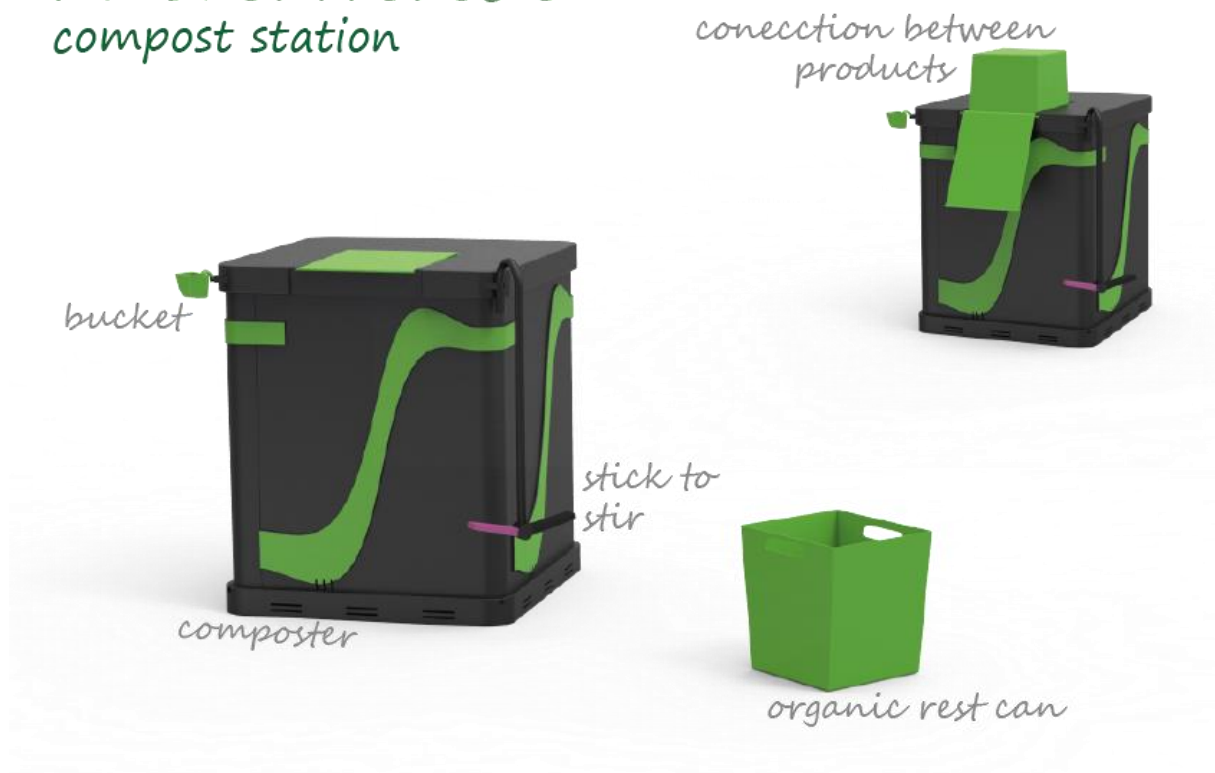

Figure 49 family of products 2

5 Result

The final result is a composter that satisfies the needs of the users who want to make their own compost following the philosophy of MiljöCenter. The new composter improve several factors of the containers that the company already have.

5.1 Form

At the first sight it is possible to see how the aspect has change and recover. With the same volume of capacity, the same idea of “simple shapes” but a different approach of design, it has been achieved an attractive composter. The container could be place in the garden and go unnoticed or be part of the garden furniture (Figure 50). The shape also allows to place to containers together and then have the double of capacity (390L x 2). Figure 51.



Figure 50 container with furniture

390 l. Medium size

390 l X 2 = 780l Large size



Figure 51 two containers

As it was shown before, the container has a relationship with the rest of objects necessary to make compost (stick to stir, bucket and can for the organic rests). Figure 52. MiljöCenter already has all these products in the market, so this is a suggestion of how they can create a compost station and then, make the process of produce compost easier and more attractive to the user.



Figure 52 compost station

5.2 Structure

The new design provides the advantage in the manufacturing and in the transportation. The whole structure is made by five different pieces. The bottom, the side formed by the plastic shell and the insulation sheet, and the lid, formed by the main cover and the small green lid. To build the container, it is necessary to have 4 sides placed in the bottom with the “fish tail” guides, and one lid that close the structure. (Figure 53)

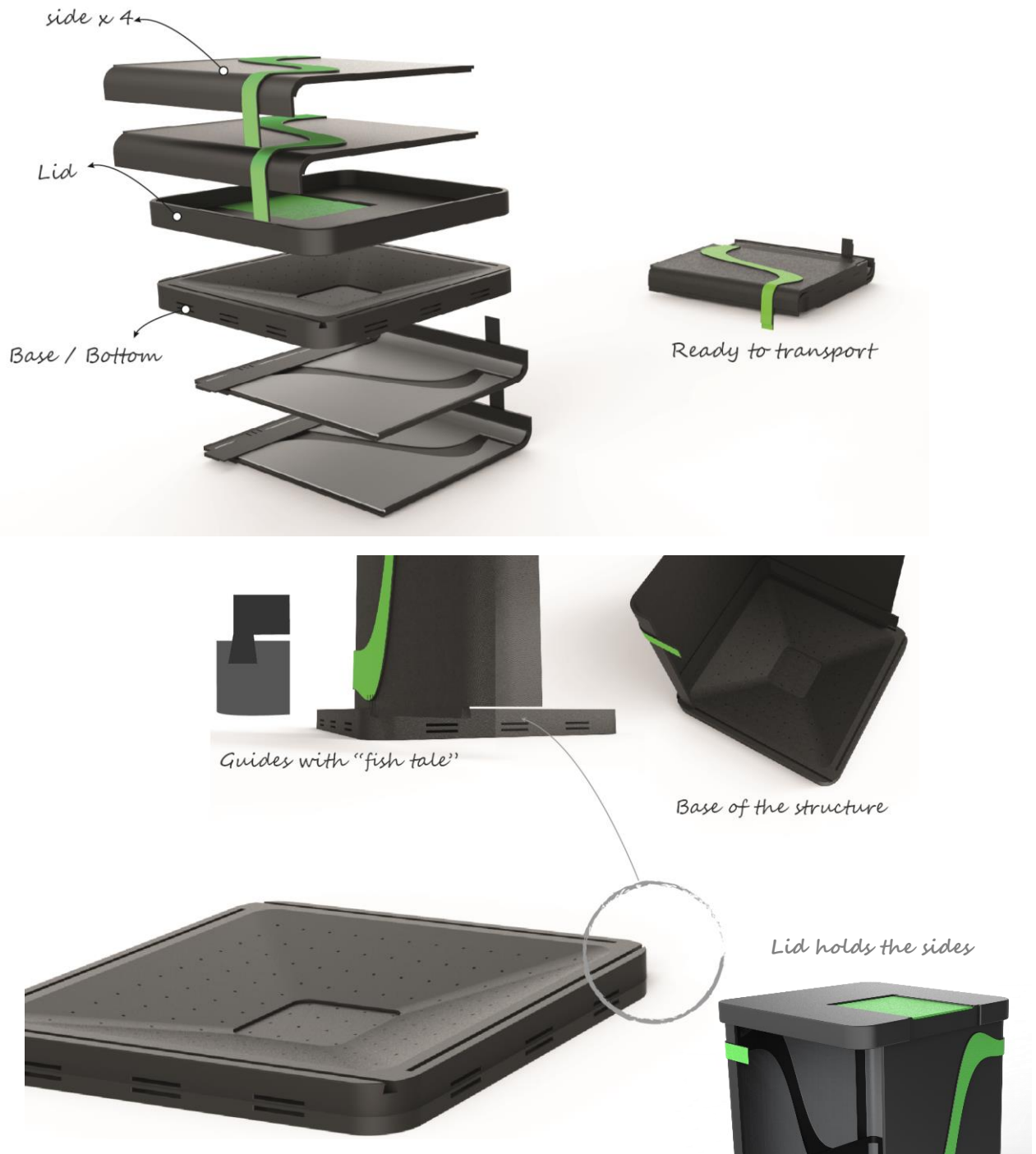

Figure 53 structure

This pieces have been designed with the intention of been placed together and fill the less space as possible. This is a benefit for the company, but it is also to the user.

In case of the company, they can reduce the costs of logistics in transport and also in packaging, since it is not necessary to have a complete box to keep the pieces together. The Figure 54 shows a suggestion of a packaging. It even could include the information of use that nowadays is in the brochure.

In case of the user he will can place it in the car, and in case of the company, it will save money.



Figure 54 packaging

This design, joined with the measures make the product fit better in the pallets (Figure 55). This implies more units per pallet, more units distributed at the same time and therefore, less outlay of the company. There could be 5 in only one level of the panel.

READY TO TRANSPORT

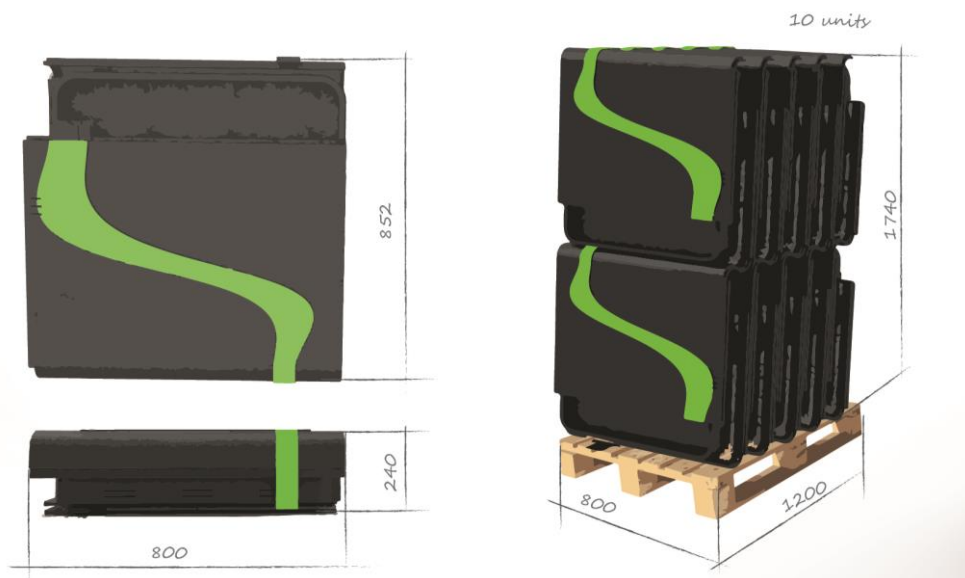

Figure 55 container in the pallet

5.3 Functions and User

The overall design has been improved to have a better surface and external design. The structure allow to make compost in a similar way that the composters of Milöcenter work now.



The design also affects to the users, from the carrier to the consumer.

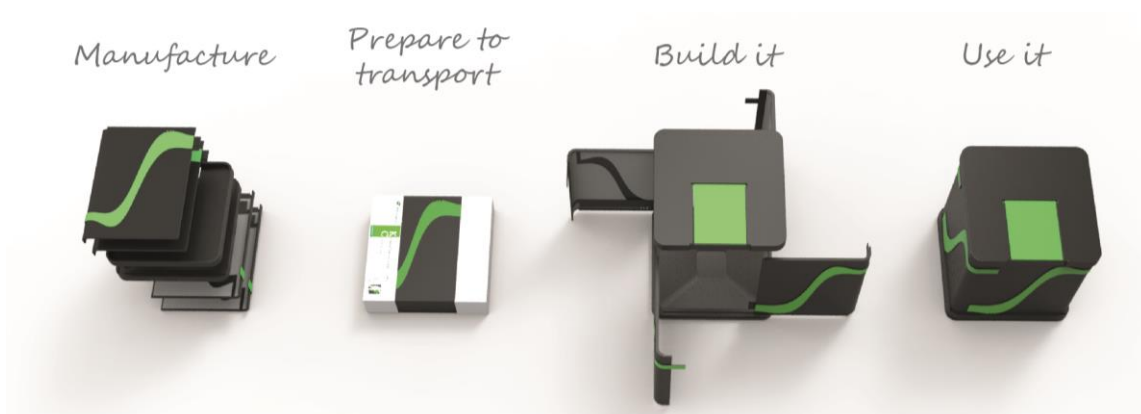

Figure 56 steps of the stakeholders

Talking about the functions, the container is able to make compost in an open environment because of the insulation sheet placed in the interior of the composter.

The whole structure is strong enough to live during several years without problems thanks to the outgoing shapes in the laterals that provide a support for the structure since the pieces has a backing between themselves.

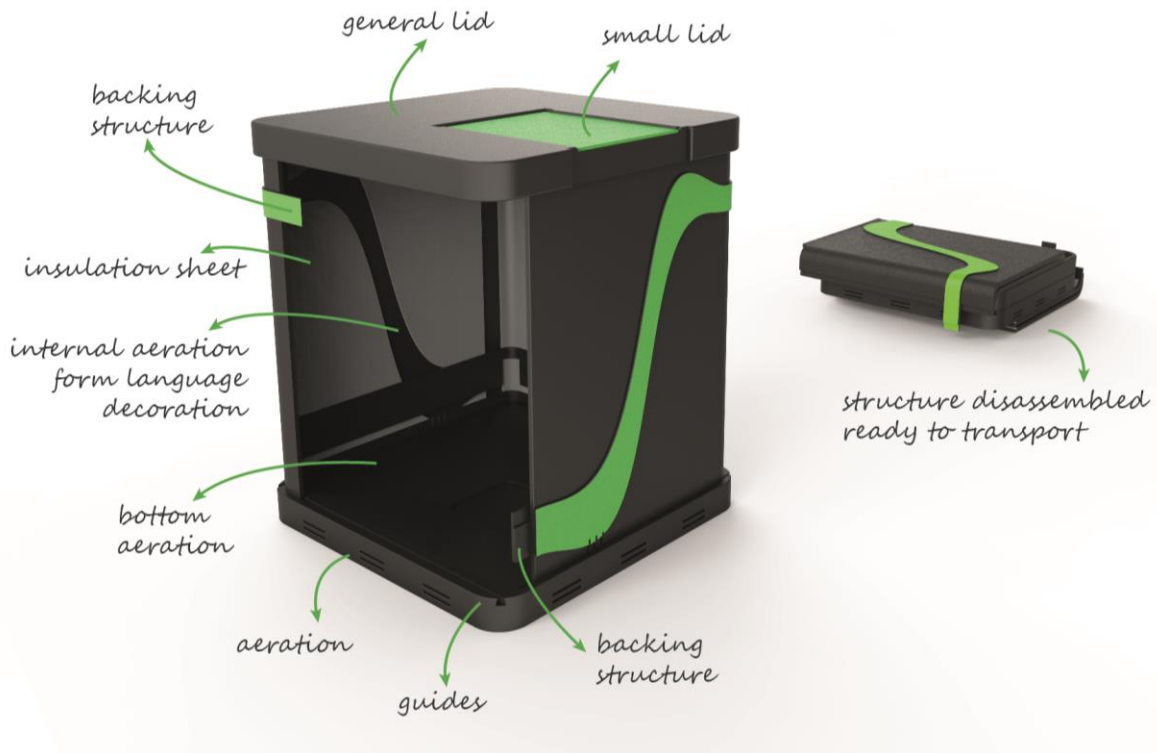

Figure 57 parts

Referring to the consumer, the interaction user – product has been improved in several factors. Following the user sequence, the first part to mention is the assembly.

The design of the joining and unions between the different pieces make easier the task of build the container and also disassembly it. (Figure 58)

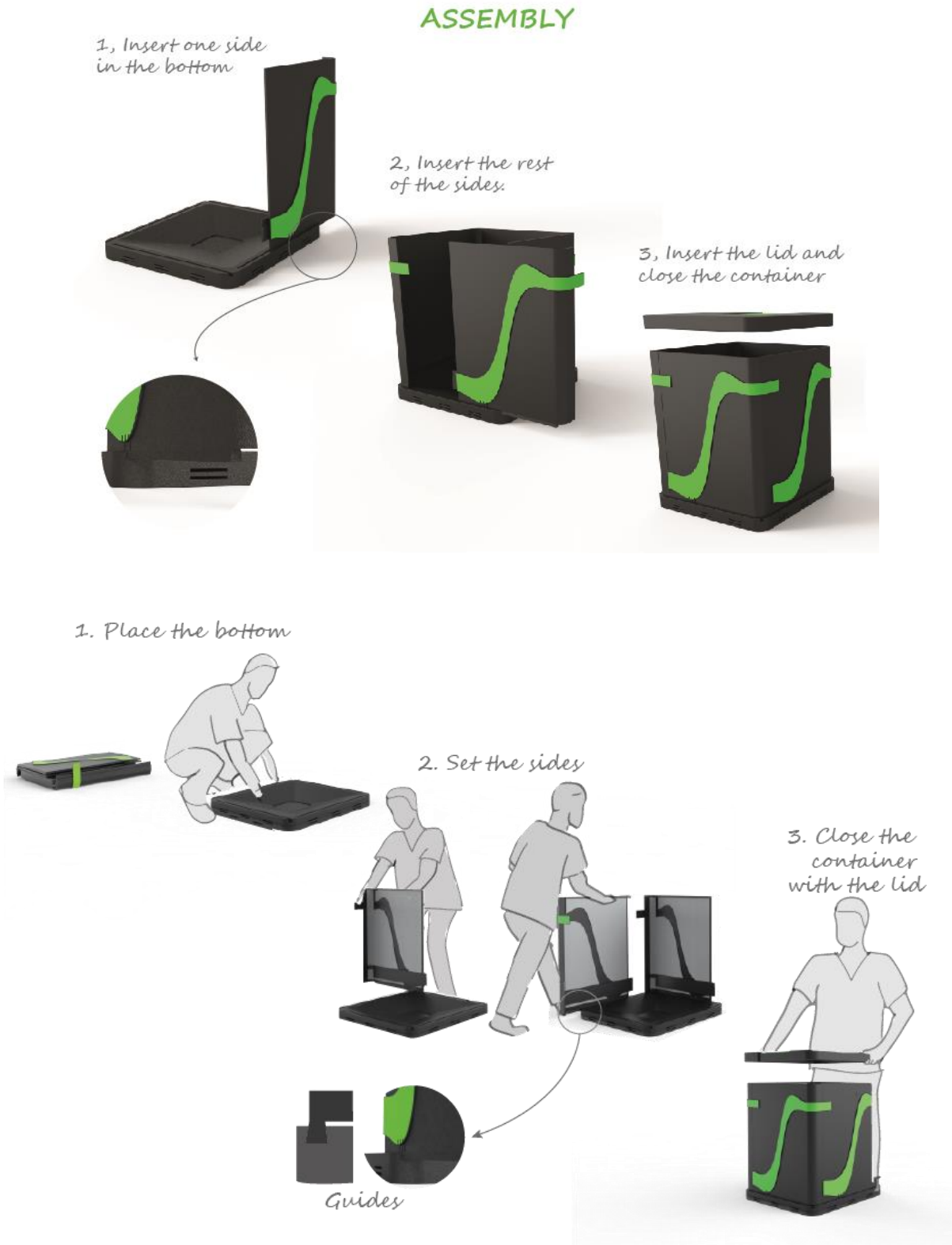

Figure 58 assembly

Following with the sentence of use, the next step is use the composter to make compost. In order to make more attractive this task, the lid has been improving to avoid the worst aspect of the compost: the odor. How the Figure 59 shows, the lid is formed for two pieces. The main lid that cover and hold the four sides, and the small one that could be open. This last one is the one that the user is going to open when he want to fill the container and stir the compost. The user will experience the advantage of feel less smell. The whole process of fill, stir and empty (Figure 60) is easier to the user thanks to the structure explained before.



Figure 59 lid



1. Fill

2 Stir

3. Get compost



Figure 60 Sequence of use

Finally, another benefit for the user, and also for the company, is that the measures help to achieve more kind of user like children or old people. The height is optimal for several range of ages, therefore the product can be used by more people.

DIMENSIONS

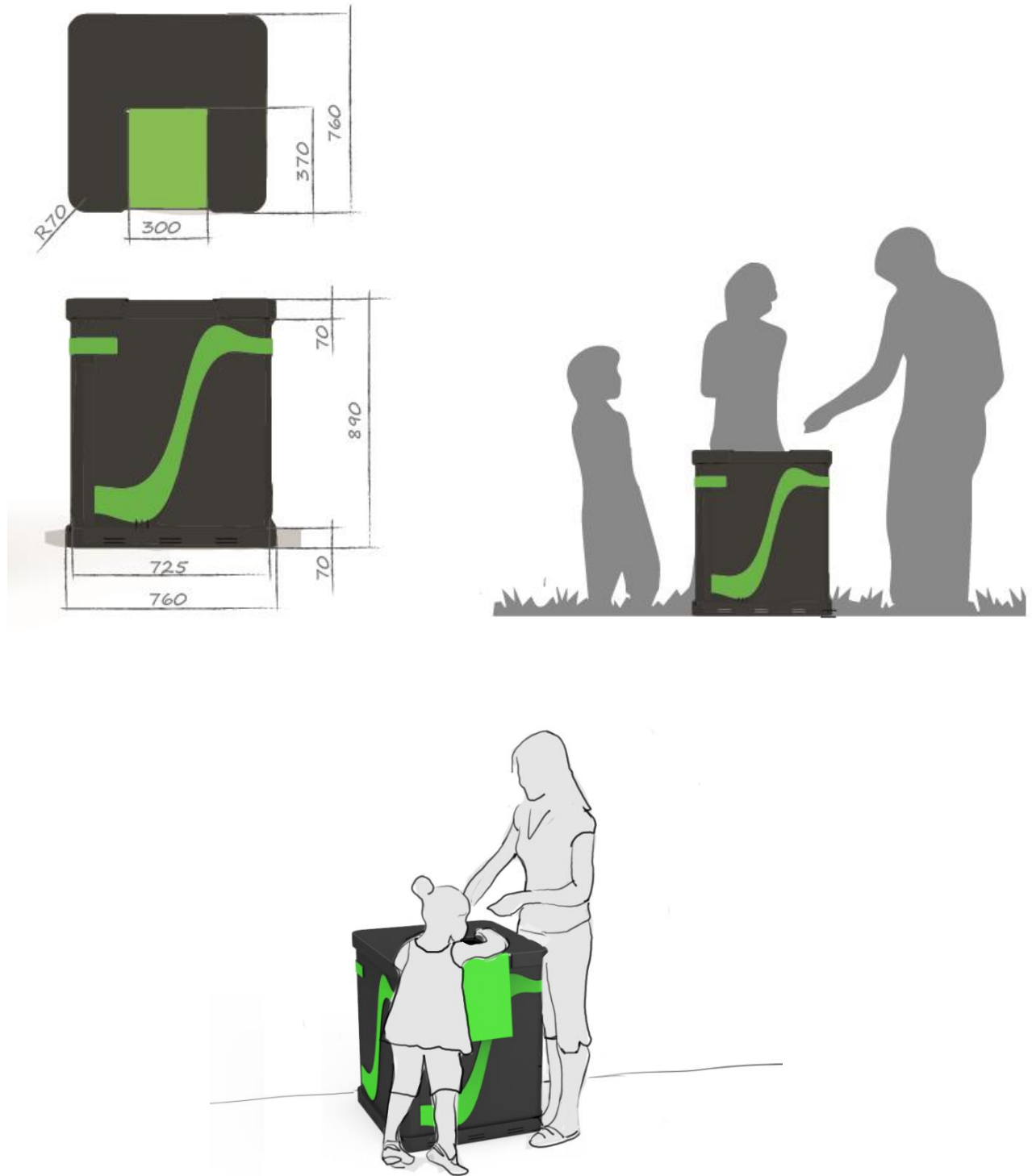

Figure 61 proportions

5.4 Model

Once that the product is totally defined, the model was built.

The model have been done in half scale (1:2), and it is really helpful to see how the product could look like at the end and also it is useful to check the structure and the assembly systems.

The pieces of the model have been done with two materials. Plastic sheets and foam.



Figure 62 materials of the model

The process of modeling has been follow the general steps. Make the shapes, fix them, and apply the final appearance.

The plastic sheets have been modelling with heating and following a model that was made previously with foam. The bottom and the lid was made with foam, making the general shape with the milling machine and making the details with small saws and sand paper.



Figure 63 process modelling

The final result of the model is shown in the following pictures:



Figure 64 final result

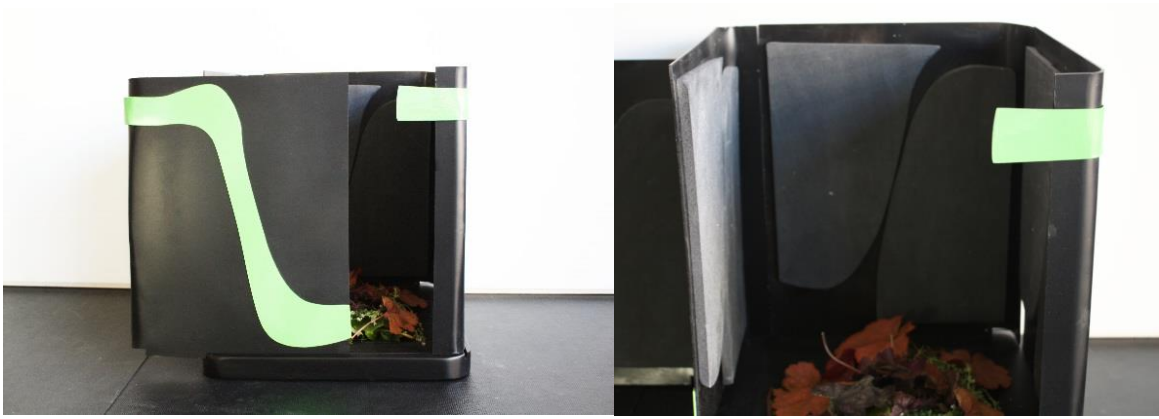

Figure 65 model open



Figure 66 some details



Figure 67 exhibition



Figure 68 posters presentation

6 Conclusion and discussion

6.1 Discussion of methods

Despite the fact that exists several design methods, all of them have the same base. Detect a problem and solve it going through different techniques.

From my point of view, every designer should have their own methodology formed by different ones and of course, modify it along their career.

This project has been based in the process of the design plan of Shneiderman and also in the creativity process studied learned in my home University, specially learned because of Fornies.

Every step carried out during the design process has a support and an explanation of why it has been done. Every process has a result that helped to get the final result. In every project I used to follow the same structure of work, but there always some changeable parts depending of the kind of product or the kind of problem that have to be solved, but, in conclusion I can say that the methodology carried out during this project is a clear scheme common in my anterior projects and will appear in my future ones.

6.2 Further work

The report shows how the project have been defined as the design of the main composter, but it also has suggestion about packaging and the family of products to make a composter station. This two suggestions could be more developed and defined in the future to make it complete defined and get additional benefits of the design.

In addition, other factor to be developed is a prototype. In this project just a model has been done to check proportions, shapes and structure, but a real prototype in real scale will be so useful to guaranteeing the success of the product in the market.

6.3 Personal reflection

Referring to my experience and how much I learnt with this project, I really want to highlight the fact of have been collaborating with a real company.

My previous experience was just personal projects when the result used to be more conceptual. This time, the result had to be real and attain all the objectives established by the company plus all the personal goals set by me.

During those last months of working I improve my own planning and the most important, a lot of design skills that I will used in the future. Not only referring to sketching or modelling, also referring to take decisions, be critical and improve the methods of work.

7 References

- Aguayo, F., Peralta, M. E., Soltero, J. R. L. & M., V., 2011. *Ecodiseño. Ingeniería sostenible de la cuna a la cuna (C2C)*. 1 red. Madrid: RC libros.
- Anon., 2014. *Product life cycle stages*. [Online]
Available at: <http://productlifecyclestages.com/>
[Använd 01 may 2014].
- CADI (Centro Aragonés de Diseño Industrial), 2009. *Diseño industrial para jóvenes estudiantes*. 1 red. Zaragoza: Gobierno de Aragón. Industrial, comercio y turismo.
- Cambridge University, 2010. *Strategic Management. A stakeholder approach*. 1 red. New Yourk: Cambridge University Press.
- Chakrabarti, L. T. & Amaresh, 2009. *DRM, a Design Research Methodology*. Limited red. Luxembourg and India: Springer-Verlag London.
- Chapanis, A., 1994. *Ergonomics Association meeting*. Toronto: Ergonomics Association.
- Chitale, A. & Gupta, R., 2005. *Product design and manufacturing*. 3 red. u.o.:PHI learning.
- Creatively driven, 2014. *creatively driven*. [Online]
Available at: <http://www.creatively-driven.com/the-art-of-the-mood-board/>
[Använd 08 May 2014].
- Cross, N., 2008. *Engineering design methods*. 4 red. u.o.:John Wiley & songs.
- Drive, R. B., 2006. *Life cycle assessment: principles and practice*, Cincinnati, Ohio: National risk management reseach laboratory..
- Eliasson, R. & Ramsbottom, B., 2003. *Composting. Pure profitable joy*. Malmö: PWS GreenLine UK.
- Fornies, I., 2012. *Análisis de mercado y producto*. Zaragoza: EINA Universidad de Zaragoza.
- Fornies, I. L., 2012. *Creatividad. Definición*. Zaragoza: Departamento de Ingeniería de Diseño y Fabricación. EINA.
- Gero, J., 2004. The situated function-behaviour-structure framework. *Design studies*, 25(Article), pp. 373-391.
- Hindle, C., 2014. *plastipedia*. [Online]
Available at: <http://www.bpf.co.uk/plastipedia/polymers/pp.aspx>
[Använd 10 may 2014].
- Jain, M., 2010. *Examamrace psychologist success serie*. 1 red. u.o.:B.A. M.A. (J.N.U.) .
- Karwowski, W., 2006. *International encyclopedia of ergonomics and human factors. Volume 1*. 2 red. United States of America: Taylor & Francis.

Kirchner & Lerma, A. E., 2010. *Desarrollo de nuevos productos. Una vision general*. 4 red. Santa Fe: Cengage learning editores.

Knight, J., 2013. *High - impact instruction*. 1 red. California : Corwin. .

Manchado, E., 2010. *Apuntes de taller de diseño I (Notes of the course Taller I)*. Zaragoza: Eduardo Manchado, Zaragoza university.

MijöCenter , 2013. *Information from the company*. Malmö: u.n.

Moles, A. A., 1970. *Créativité et méthodes d'innovation dans l'entreprise*. 1 red. Paris: Fayard-mame.

Oxford dictionaries, 2014. *Oxford Dictionaries*. [Online]
Available at: <http://www.oxforddictionaries.com/definition/english/ergonomics>
[Använd 07 may 2014].

Oxford Dictionaries, 2014. *Oxford Dictionaries*. [Online]
Available at:
http://www.oxforddictionaries.com/definition/english/sketch#m_en_gb0777830
[Använd 05 may 2014].

Oxford Dictionaries, 2014. *Oxford Dictionaries*. [Online]
Available at:
<http://www.oxforddictionaries.com/definition/english/modulate?q=modulate>
[Använd 03 may 2014].

Oxford dictionary , 2014. *Oxford dictionary*. [Online]
Available at:
http://www.oxforddictionaries.com/definition/english/brainstorm?q=brainstorming#brainstorm_9
[Använd 03 may 2014].

Panero, J. & Zelnik, M., 1996. *Human dimension & interior space*. 7 red. New York: Watson .- Guptill Publications .

Parker, J., 2014. *jenniparker*. [Online]
Available at: www.jenniparker.com/what-i-do/

Romero, A. F., 2005. *Creatividad e innovación en empresas y organizaciones*. 1 red. Madrid: Dias de Santos.

Shneiderman, B., 2000. Creating creativity: user interfaces for supporting innovation. *ACM transaction on compute - human interaction*, Volym 7, p. 123.

Solid works, 2014. *Solid works sustainability*. [Online]
Available at: <http://www.solidworks.com/sustainability/design/life-cycle-assessment.htm>
[Använd 01 may 2014].

Stark, J., 2011. *Product lifecycle management*. 2 red. London: Springer - Verlag London.

8 Attachments

Attachment 1	Research
Attachment 2	Brief
Attachment 3	Conceptualization
Attachment 4	Ventilation system

8.1 Attachment I. Research

Since the project is made in collaboration with the company MijöCenter, the research has to have two different parts. The first one refers to the general market what is also called market analysis and the second one to the products of the company.

MARKET ANALYSIS

The composter market is divided in two kinds of containers as the next image shows.

Compost Bin

- Loads from the top
- Made with thinner plastic
- Minimal aeration
- Large volume per footprint
- Empties from lower parts



Compost Tumblers

- Loads from the top
- Heavy duty construction
- Aerates and mixes when spun
- Smaller volume per footprint
- Empties from top
- Is fully sealed



COMPOSTER	DIMENSIONS	MATERIAL	PRICE	REFERENCE
	82,82 L x 99W x 92H (cm) 198 L	Recycled plastic Blow molded	\$192.41	http://www.ambientweather.com/pscmp05b.html
	99L x 79W x 90H (cm) 190L	PP Blow molded	\$253	http://www.greenfingers.com/product.asp?dept_id=500699&pf_id=LS6698D
	65L x 85W x 117H (cm) 220 L	PP Blow molded	\$211	http://www.greenfingers.com/product.asp?dept_id=500699&pf_id=LS0045D
	111H x 77W x 74L (cm) 189 L	PP Blow molded	\$145	http://www.compostmania.com/Insulated-Air-Core-Compost-Tumbler
	172H x 127 diam 622 L	metal	\$329	http://www.garden-composter.com/compost-tumbler/compostumbler-02001-compact-12-cubic-foot-galvanized-metal-compost-bin

COMPOSTER	DIMENSION S	MATERIA L	PRIC E	REFERENCE
	<p>60L x 60W x 115H (cm) 350 L</p>	<p>PP</p>	<p>\$302</p>	<p>http://www.composter.es/es/supercompr-compostador-de-plastico-pp.html?__store=es</p>
	<p>52 H x 54 diam (cm) 40L</p>	<p>Galvanized meta</p>	<p>\$67</p>	<p>https://www.originalorganics.co.uk/category.htm/composting-and-waste/plastic-bins</p>
	<p>100 H x 80 Diam. (cm) 330 L</p>	<p>PP Blow molded</p>	<p>\$84</p>	<p>http://www.greenfingers.com/product.asp?dept_id=500699&pf_id=LS7857D</p>
	<p>58L x 56W x 76H (cm) 156 L</p>	<p>wood</p>	<p>\$92</p>	<p>http://www.greenfingers.com/product.asp?dept_id=500698&pf_id=DD7641D</p>

Like conclusions of the market analysis, is it possible to say that the main used material is the PP, but it is also probable to find some products mad in wood and metal.

The wood and the PP make with blow molded is the cheapest way to produce the containers.

The shapes are simples and then, they are not organic shapes. Usually round corners to guarantee the security.

Finally, referring to the volume and looking at the average, it could be possible to divide the sizes in three groups, small, medium and large. The smalls are around 150L, the medium 300 L and the large around the 600 L. The biggest ones are the less common.

MILJOCENTER ANALYSIS

COMPOSTER	DIMENSIONS	MATERIAL	PRICE
	82L x 82W x 108H (cm) 600 L	PP No insulation	\$995
	61L x 61W x 83H (cm) 300 L	PP No insulation	\$72

	<p>64L x 64W x 79H (cm) 250 L</p>	<p>PP Insulation</p>	<p>\$152</p>
	<p>90H x 85 diam (cm) 360 L</p>	<p>PP Insulation</p>	<p>\$152</p>
	<p>89L x 98W x 89H (cm) 375 L</p>	<p>PP Insulation</p>	<p>\$250</p>

The company MiljöCenter have the containers in color green or black. Nowadays they are just producing them in black but there are still some green in the market. The reason is because of the manufacturing is easy and the price is less.

Referring to the volume and according to the previous analysis, is it possible to see that they have medium and large composters. The average is around 300L and the best seller is the one of 375 L even though is the most expensive one.

Since the market is focus in Sweden, almost all the models are insulated.

8.2 Attachment 2. BRIEF

Presentation of the project: 3th week of May.

Number of weeks of the project: 16 weeks

Number of credits: 15 ECTS

Material to handle: report with all the information necessary to understand the project and know all the previous process to get the final result. Model and renders that show the final result and final presentation.

Definition of the project: this project is called “final bachelor thesis”. It is the final project work of the degree. The final work and opportunity to show and apply all the skill acquired during the degree and all the knowledge that the student have now after all the courses. Is important to add that in this case, the project is validated in Spain along with two more courses (intercultural and international communication and design communication) to get the 30ECTS required by the “EINA, Universidad de Zaragoza”.

Objectives: the main goal of this project is solve the problem of the company MiljöCenter with their containers of compost. The composters has been produced with the same design for long time and they need to renovate the design of the product to improve the image.

The main factors that have to take into account are the manufacturing, the logistics and the sequence of use. At the end, the final project has to be a green product (following the philosophy thinking of the company) able to contain and make possible the process of compost in its inside with a nice exterior shape and with a cheap and easy production.

The design must make the task of make compost easy to the costumer and to the rest of users, thinking in transportation and manufacturing.

Evaluation: the final evaluation will be carry out by the supervisor and the coordinators. The company also will give their opinion and feedback that could be take into account by the supervisor. There will be also an opposition carry out by another student of the same level. The main points that will be checked about the report and the project in general will be the clarity of the question of the project and how the problem has been solved, the information given by the student ant its relevance and also the questions about the final result, how it looks like and which methods has been applied to get it.

Referring to the formalities, the grammar of the report, the structure and also the information and the references.

8.3 Attachment 3. Conceptualization

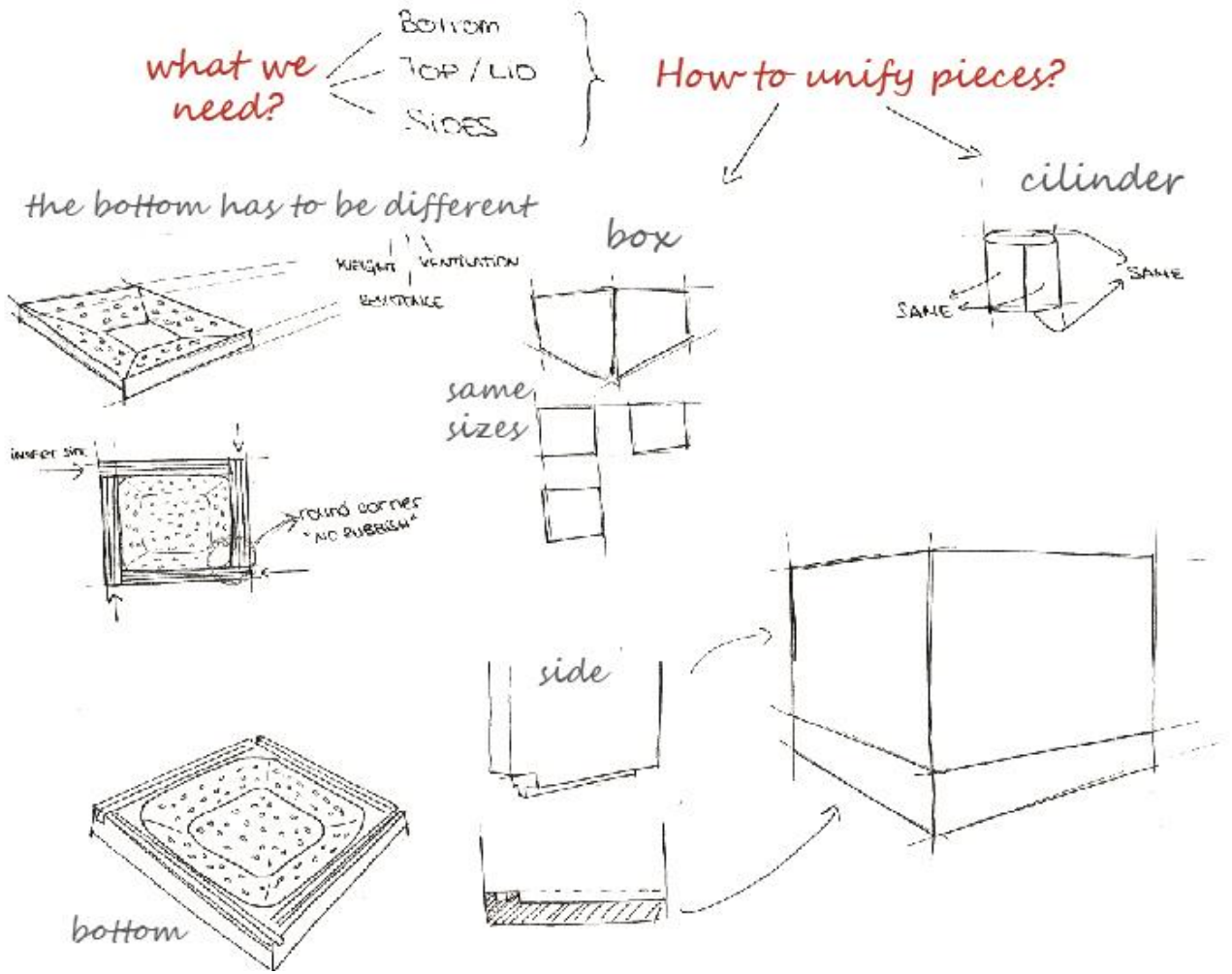

NEW

cylinder

like actual shapes



✓
tubish
in the corners

how to improve?

divided in 4

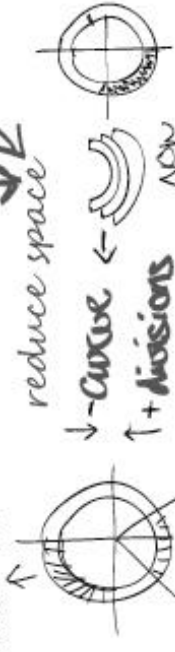

reduce space

↓ -Curve
↑ +Divisions

see concepts 1&2
simple square shapes

what do we get? → reduce space
→ easy production



LOGISTICS

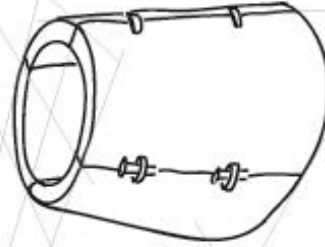

CONCEPT 1

LATERAL, SIDES: 2 PIECES

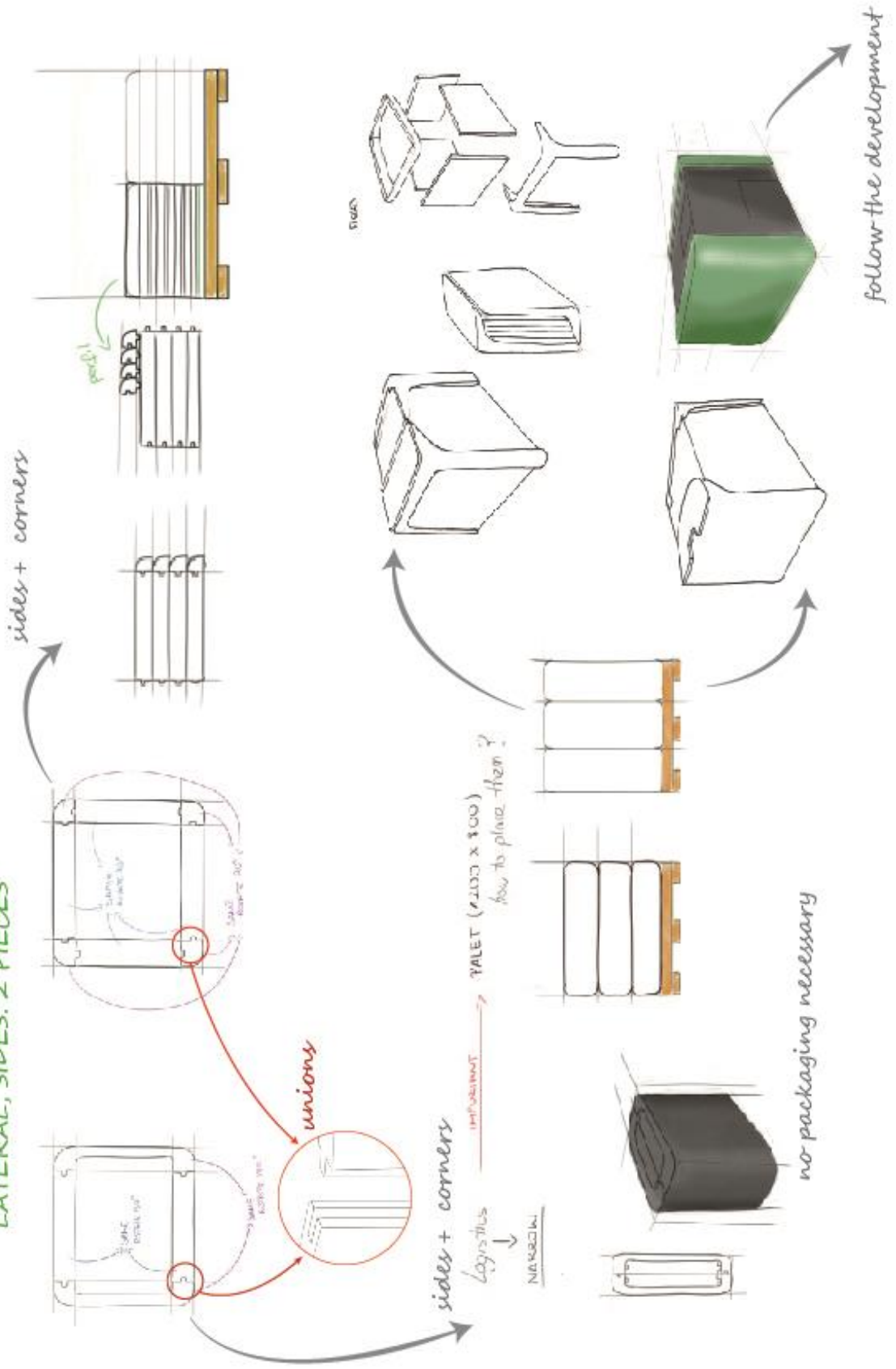

CONCEPT 1

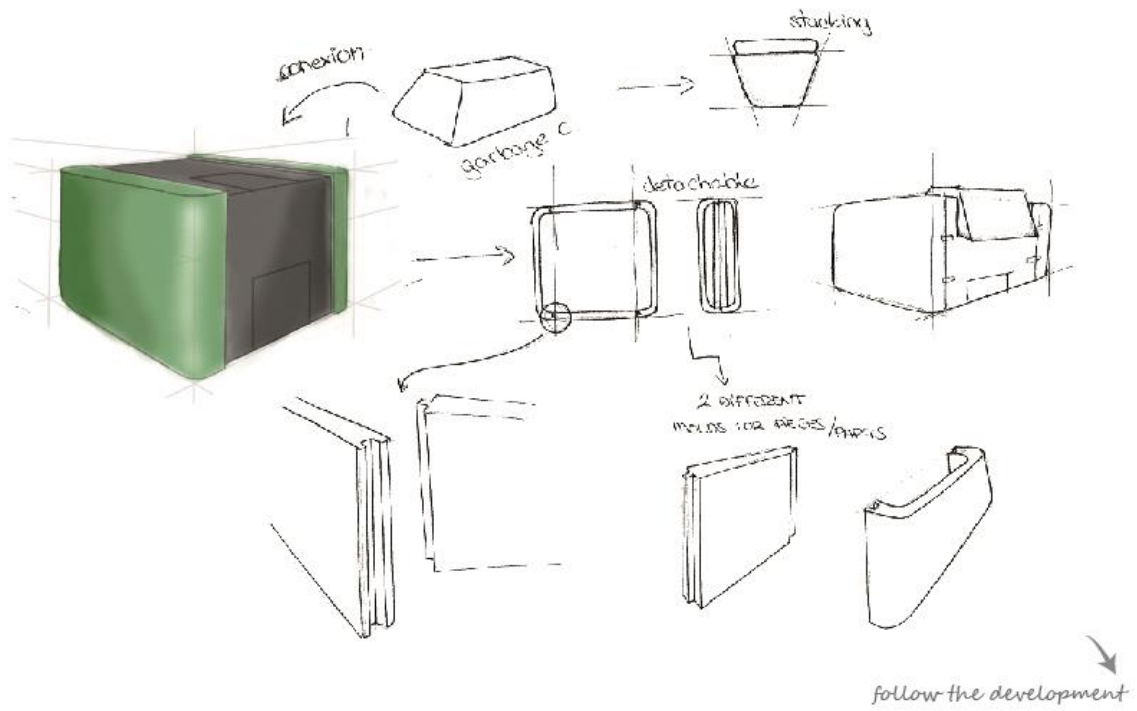

union, fixers

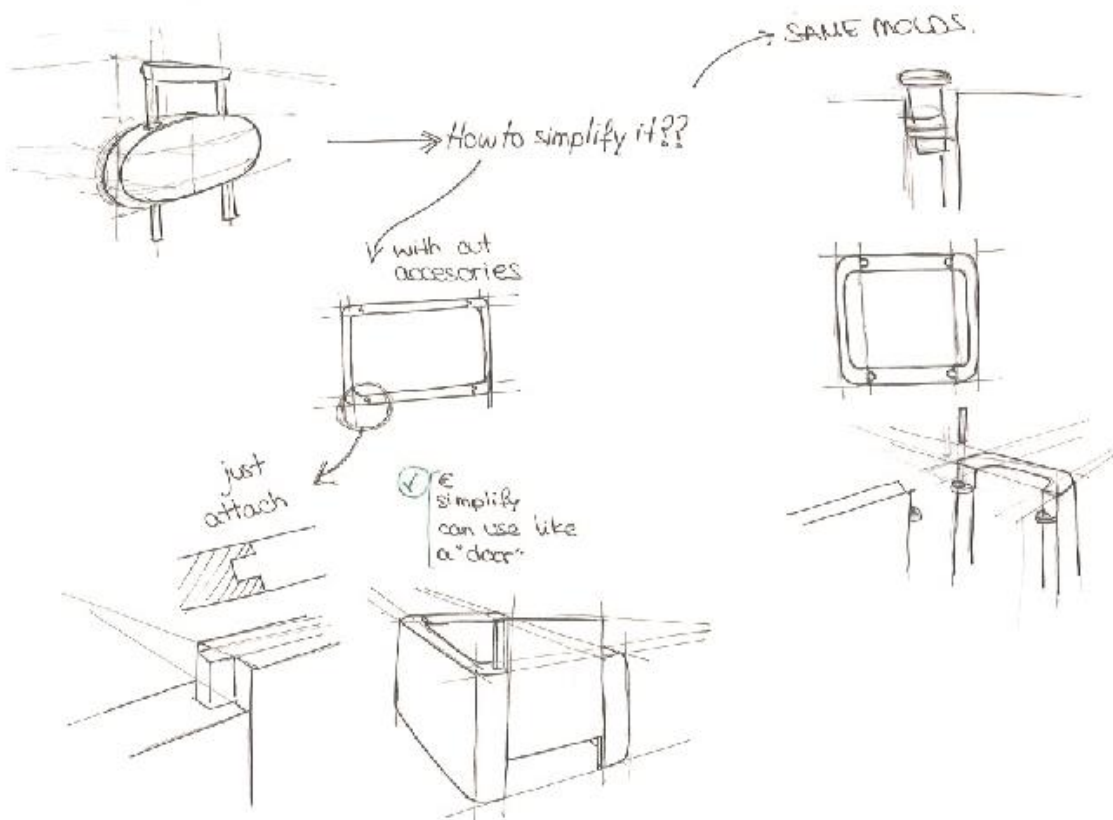

CONCEPT 2

LATERAL, SIDES: 1 PIECE

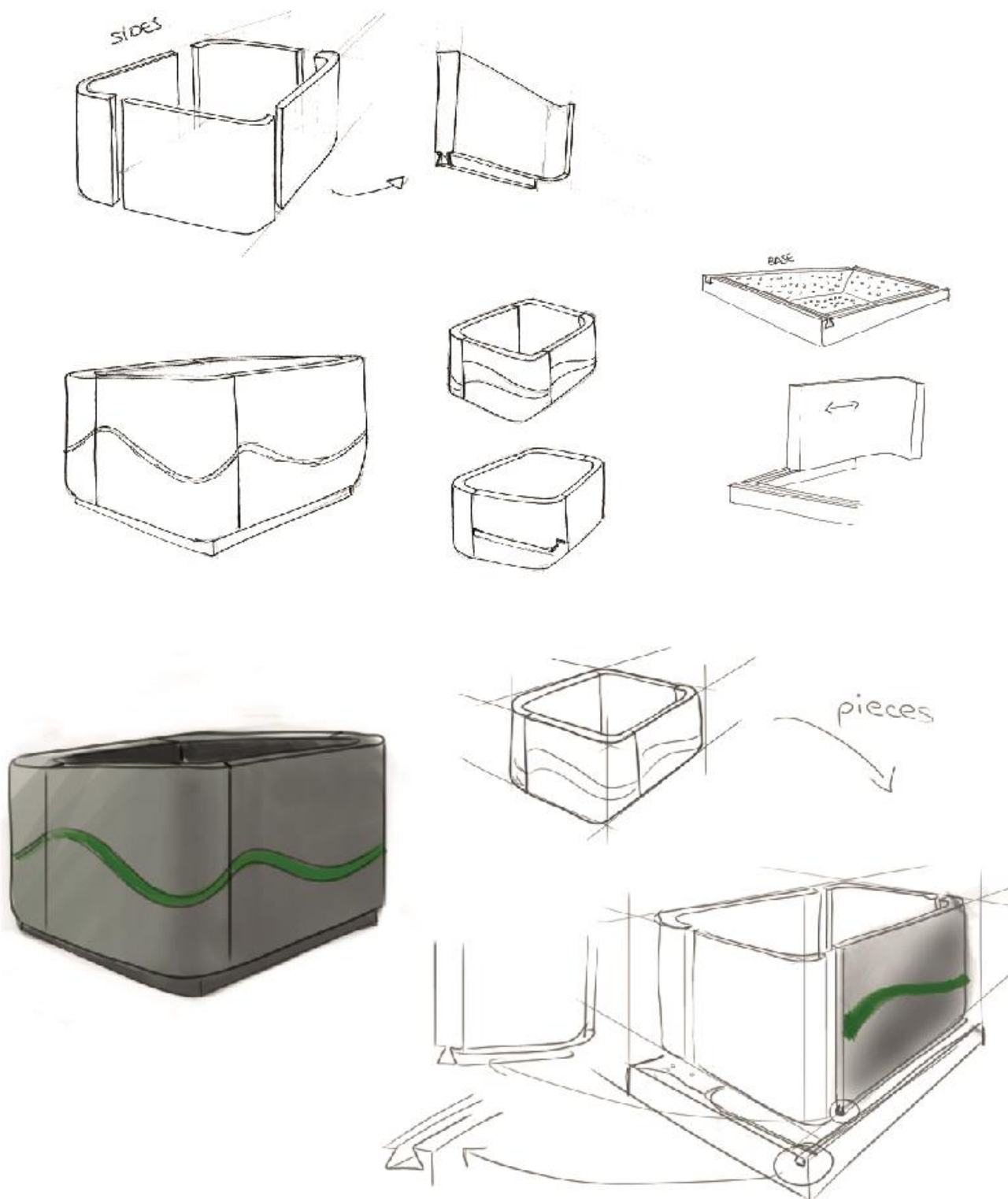

8.4 Attachment 4. Ventilation.

In this attachment appear the design process of the ventilation system. The research of the existents ones of the company MiljöCenter, and the final ventilation (aeration) system of the final new product.

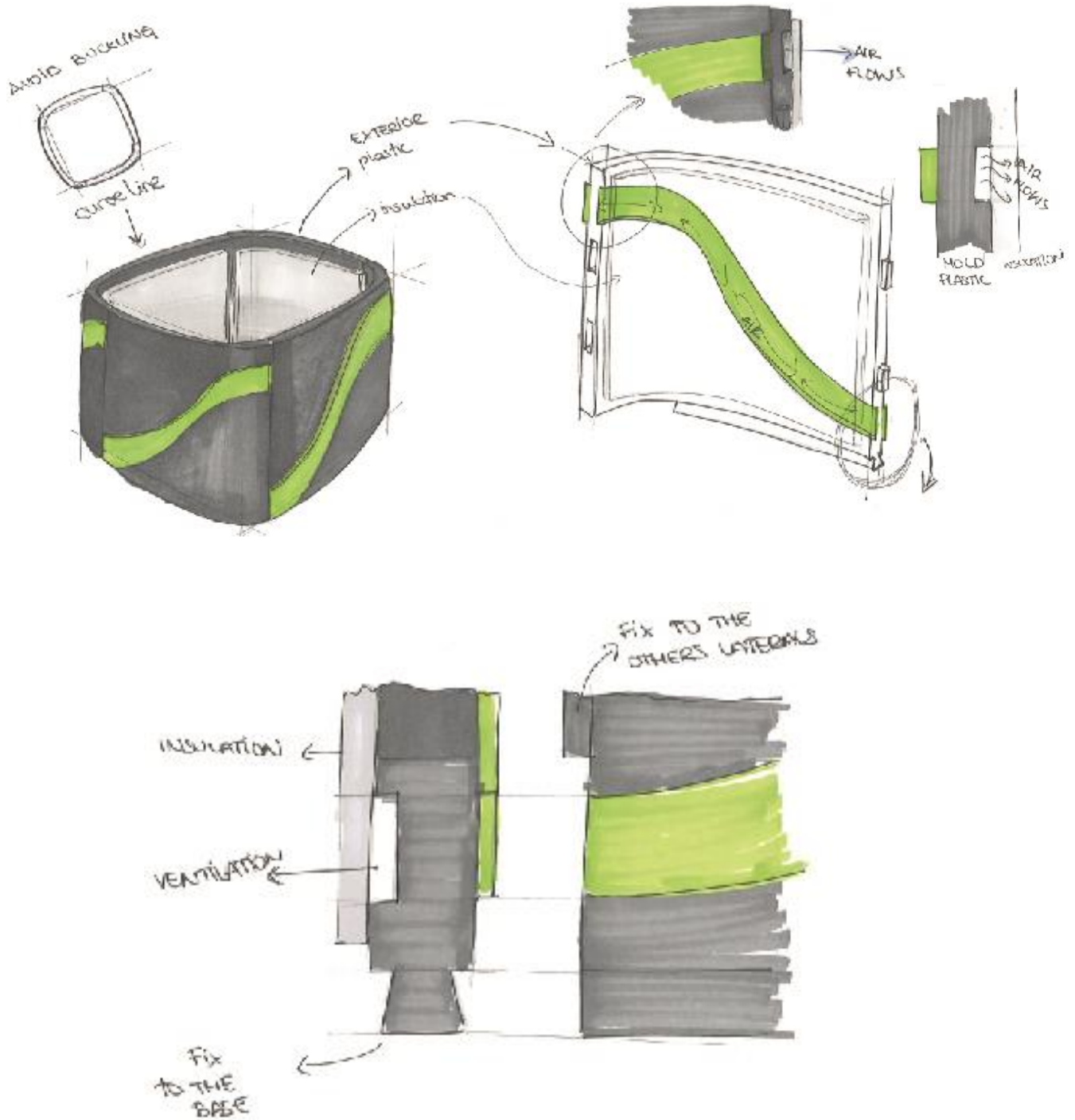

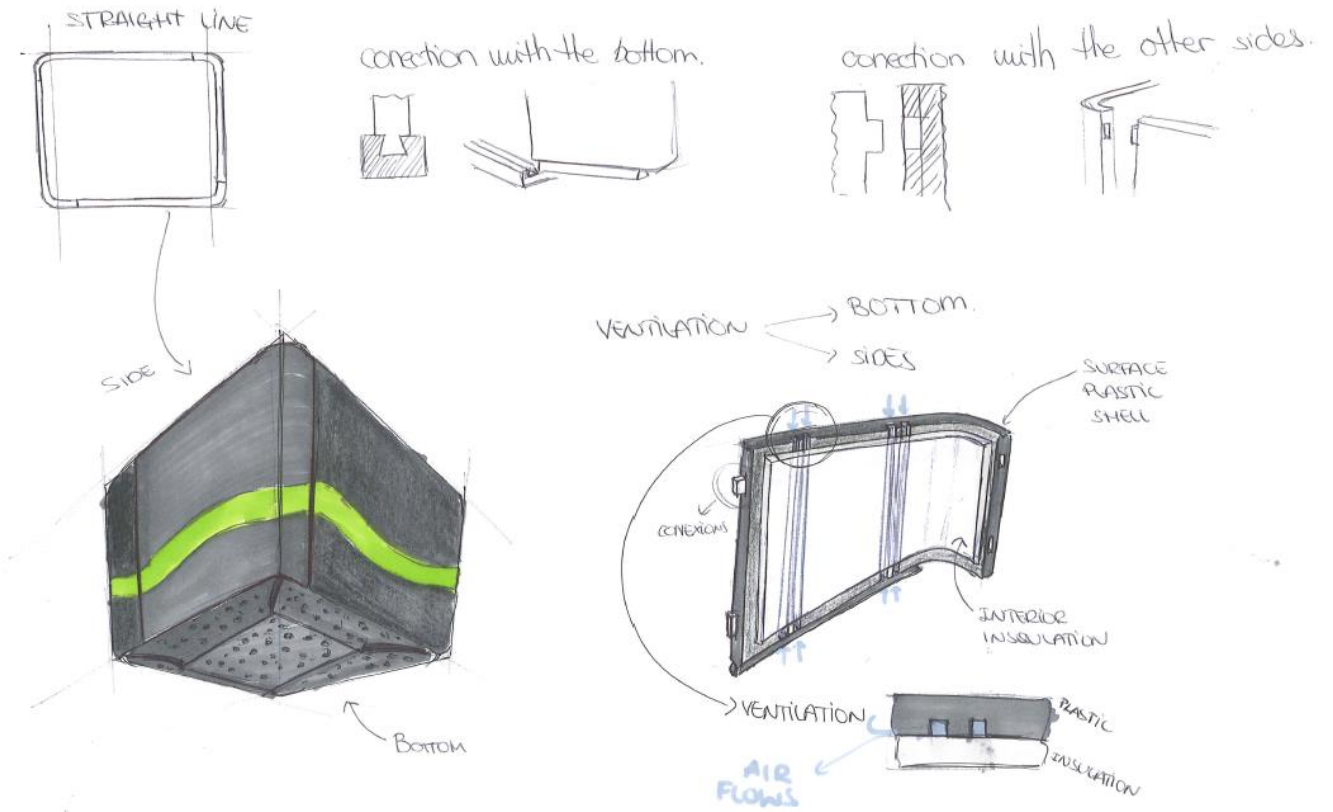

ventilation system of MiljoCenter composters

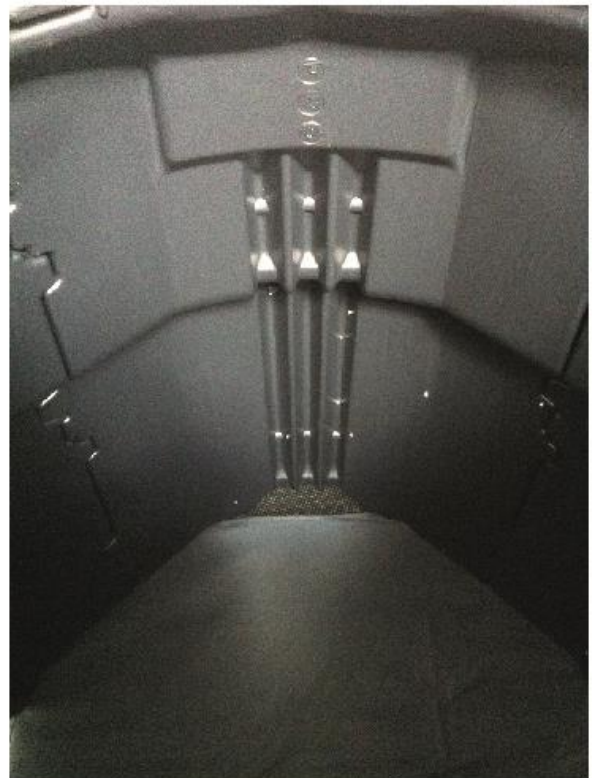
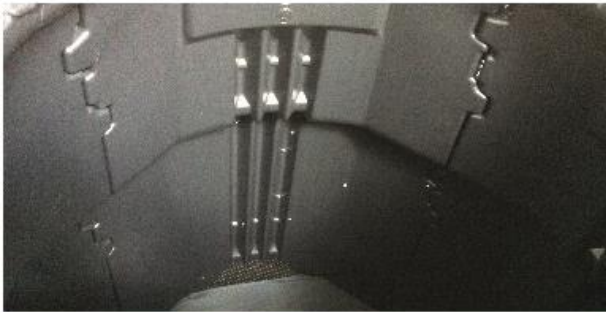

VENTILATION

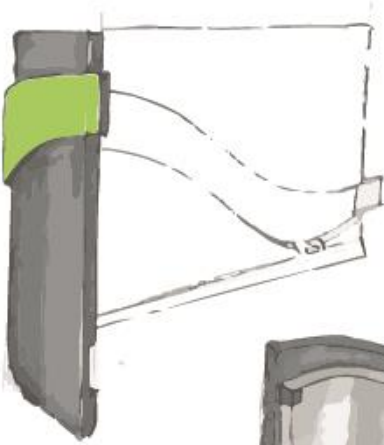

Outgoings and incomings make fit the sides between themselves and make the structure stronger.

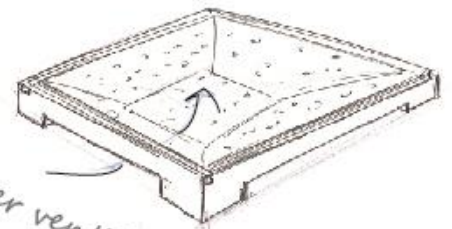
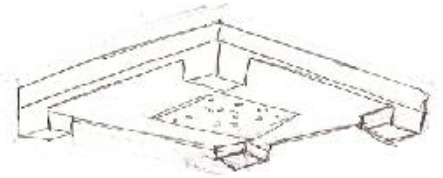

Better ventilation

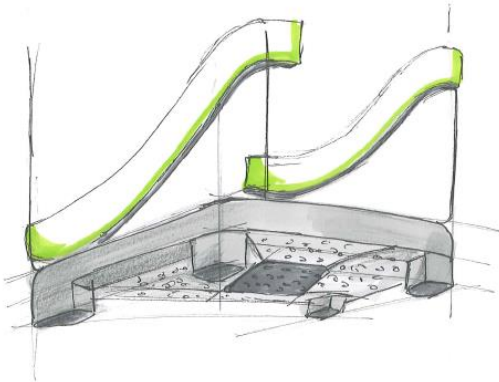

Same but better design
Less risk of animals

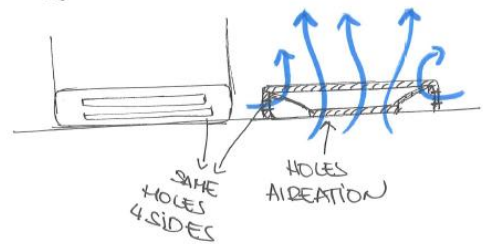
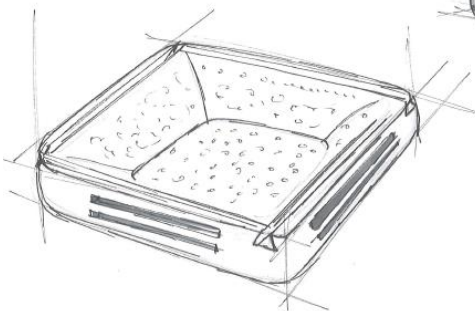

The shape that comes out in the exterior part is also a hole in the interior part, then the mold is easy and the material is not wasted. The hole is also made for the ventilation. The insulation sheet will be divided in two pieces, then the air comes from the bottom and flows to the top because of the warm.

The air goes inside trough the base of the structure and also through the holes placed in the bottom part on the side, then the air flows across the curve shape and comes out over the lid.

