

Manuel García Rodríguez

Estudio y simulación del proceso
de producción de biodiésel :
aplicación a la predicción de las
propiedades físicas

Departamento
Ingeniería Química y Tecnologías del Medio
Ambiente

Director/es
Sánchez Cebrián, José Luis
Gonzalo Callejo, Alberto

<http://zaguan.unizar.es/collection/Tesis>

Tesis Doctoral

ESTUDIO Y SIMULACIÓN DEL PROCESO DE
PRODUCCIÓN DE BIODIÉSEL : APLICACIÓN A LA
PREDICCIÓN DE LAS PROPIEDADES FÍSICAS

Autor

Manuel García Rodríguez

Director/es

Sánchez Cebrián, José Luis
Gonzalo Callejo, Alberto

UNIVERSIDAD DE ZARAGOZA

Ingeniería Química y Tecnologías del Medio Ambiente

2012

TESIS DOCTORAL

Universidad de Zaragoza



Universidad
Zaragoza

Departamento de Ingeniería Química y Tecnologías del Medio Ambiente

Estudio y simulación del proceso de
producción de biodiésel. Aplicación a
la predicción de las propiedades
físicas.

Noviembre, 2012

Manuel García Rodríguez

TESIS DOCTORAL
Universidad de Zaragoza



Departamento de Ingeniería Química y Tecnologías del Medio Ambiente

Estudio y simulación del proceso de
producción de biodiésel. Aplicación a
la predicción de las propiedades
físicas.

Memoria que presenta para optar al Grado de Doctor en Ingeniería Química

Manuel García Rodríguez

Zaragoza, Noviembre 2012

Resumen general e informe de contribuciones

El Grupo de Procesos Termoquímicos (GPT), perteneciente al Instituto Universitario de Investigación en Ingeniería de Aragón (I3A) de la Universidad de Zaragoza, viene investigando, desde hace casi tres décadas, fundamentalmente en los procesos de pirólisis y gasificación de biomasa, así como en la eliminación de contaminantes en gases de combustión, y la producción de hidrógeno mediante craqueo catalítico y el reformado en fase acuosa de corrientes residuales. La presente tesis doctoral marca el comienzo de una nueva línea de investigación del GPT centrada en la producción de biodiésel.

El gran número de artículos de investigación, de revisión y patentes que se pueden encontrar demuestra el gran interés que existe en el biodiésel. Éste es un combustible renovable, que puede mezclarse con el diésel fósil o usarse directamente en motores diésel si cumple unas determinadas condiciones de propiedades y composición, que vienen establecidas en normas como las europeas (EN) o las ASTM en Estados Unidos. Al arrancar esta línea de investigación se han encontrado interesantes áreas de trabajo, como por ejemplo aquellas correspondientes a la simulación de la producción de biodiésel, el modelado de propiedades de mezclas de diferentes tipos de biodiésel a partir de la composición química y la mejora de propiedades mediante el uso de aditivos. Así mismo, otras áreas han despertado el interés del grupo, como la utilización de glicerina en la producción de triacetinas u otros sub-productos de alto valor añadido, habiéndose realizado diferentes trabajos en este sentido.

Probablemente, el punto de mayor interés se encuentre en la combinación del modelado de propiedades y la utilización de aditivos para la mejora de las mismas. En este sentido se continúan realizando trabajos en el grupo mediante otra tesis doctoral que pretende continuar ahondando en el conocimiento que se ha generado.

Esta tesis se presenta como un compendio de las publicaciones que a continuación se listan, y para las cuales se ha llevado a cabo gran cantidad de trabajo experimental en laboratorio, tal y como se recoge de forma resumida en el apartado 2.2 de esta memoria, así como de trabajo de simulación y modelado de propiedades.

Los artículos publicados siguen una clara línea de continuidad desde un análisis inicial del estado del arte en cuanto a la simulación y modelado de propiedades, y de equilibrios de fases en el procesado de biodiésel, hasta el modelado concreto de propiedades físicas del biodiésel a partir de la composición de las materias primas:

- I.** M. García, A. Gonzalo, J.L. Sánchez, J. Arauzo, J.A. Peña, *Prediction of normalized biodiesel properties by simulation of multiple feedstock blends*, Bioresour. Technol., 101 (2010) 4431-4439.
- II.** A. Gonzalo, M. García, J.L. Sánchez, J. Arauzo, J.A. Peña, *Water Cleaning of Biodiesel. Effect of Catalyst Concentration, Water Amount, and Washing Temperature on Biodiesel Obtained from Rapeseed Oil and Used Oil*, Ind. Eng. Chem. Res, 49 (2010) 4436-4443.
- III.** M. García, A. Gonzalo, J.L. Sánchez, J. Arauzo, C. Simoes, *Methanolysis and ethanolysis of animal fats: A comparative study of the influence of alcohols*, Chem. Ind. Chem. Eng. Q, 17 (2011) 91-97.
- IV.** M. García, J.J. Alba, A. Gonzalo, J.L. Sánchez, J. Arauzo, *Comparison of Methods for Estimating Critical Properties of Alkyl Esters and Its Mixtures*, J. Chem. Eng. Data, 57 (2011) 208-218.
- V.** M. García, J.J. Alba, A. Gonzalo, J.L. Sánchez, J. Arauzo, *Density of alkyl esters and its mixtures. A comparison and improvement of predictive models*, Fuel, (10.1016/j.fuel.2012.07.049) (2012)
- VI.** M. García, J.J. Alba, A. Gonzalo, J.L. Sánchez, J. Arauzo, *Empirical modelling of the kinematic viscosity of biodiesel produced with methanol and ethanol*. En revisión. Revista Fuel.

Informe de contribución:

Mi contribución como autor en cada uno de los artículos de esta memoria ha sido:

Artículo I: Responsable del proceso de simulación, obtención de datos, análisis de resultados y redacción.

Artículo II: Supervisión del trabajo experimental, responsable del análisis de resultados, de la simulación de los mismos mediante paquetes termodinámicos y redacción.

Artículo III: Responsable de la parte experimental, análisis de resultados y redacción.

Artículo IV: Responsable de la parte experimental, análisis de resultados y redacción.

Artículo V: Responsable de la parte experimental, análisis de resultados y redacción.

Artículo VI: Responsable de la parte experimental, análisis de resultados y redacción.

Estos artículos se pueden encontrar en el apartado final de esta memoria Anexos.

Además, fruto del trabajo realizado en esta tesis doctoral, se ha participado en los siguientes congresos:

- II Bioenergy Fuels and Chemicals From Renewable Resources European Biomass Conference, Rio de Janeiro, Brazil, Marzo 8-13, 2008

M. García, A. Gonzalo, J.A. Peña, *Comparison of predictive models for the esterification and transesterification reactions in biodiesel production. Application in a production plant simulation.* Póster

- 11th Mediterranean Congress of Chemical Engineering, Barcelona, España. 21-24 Octubre 2008

M. García, A. Gonzalo, J.A. Peña, *Comparison of predictive models of biodiesel properties. Application in a production plant simulation.* Póster.

D. Alberto Gonzalo Callejo, Profesor Titular de Universidad, y

D. José Luis Sánchez Cebrián, Profesor Titular de Universidad,

ambos pertenecientes al Departamento de Ingeniería Química y Tecnologías del Medio Ambiente, y al Grupo de Procesos Termoquímicos del Instituto Universitario de Investigación en Ingeniería de Aragón (I3A) de la Universidad de Zaragoza

CERTIFICAN

Que la presente memoria titulada

Estudio y simulación del proceso de producción de biodiésel. Aplicación a la predicción de las propiedades físicas

ha sido realizada bajo nuestra dirección en el Departamento de Ingeniería Química y Tecnologías del Medio Ambiente por D. Manuel García Rodríguez, autorizando su presentación como compendio de publicaciones.

Y para que así conste, firmamos este certificado en Zaragoza, a 3 de septiembre de 2012.

Fdo. Prof. Dr. Alberto Gonzalo Callejo

Fdo. Prof. Dr. José Luis Sánchez Cebrián

A mi madre
A mis hermanos Jesús y Cristina
A mi padre que descansa *baj'una encina del camino nuevo*

für Meike

Índice

1. Introducción	1
1.1. Antecedentes y contexto mundial del biodiésel	2
1.1.1. Marco internacional	2
1.1.2. Marco europeo	3
1.1.3. Estrategia energética: Biodiésel	6
1.2. Definición, materias primas y propiedades del biodiésel	9
1.2.1. Definición y producción	9
1.2.2. Estándares y propiedades	10
1.2.3. Materias primas	14
1.3. Simulación y modelado de propiedades	18
1.3.1. Simulación del proceso de producción	18
1.3.2. Modelado de propiedades	20
1.4. Tareas realizadas y contribuciones	25
2. Resumen	31
2.1. Objetivos y plan de trabajo	31
2.2. Método experimental	33
2.2.1. Producción de biodiésel	33
2.2.2. Caracterización del biodiésel	37

2.3. Resultados y discusión	39
2.3.1. Simulación del proceso de producción de biodiésel	41
2.3.2. Etapa de limpieza del biodiésel mediante lavado con agua. Estudio experimental y simulación de la misma	46
2.3.3. Producción de biodiésel con metanol y etanol a partir de materias primas alternativas	50
2.3.4. Inicio del modelado de las propiedades del biodiésel: propiedades críticas	55
2.3.5. Modelado de la densidad del biodiésel	61
2.3.6. Modelado de la viscosidad cinemática del biodiésel	68
2.3.7. Líneas de investigación iniciadas y trabajos futuros	79
3. Conclusiones	83
4. Bibliografía	89
5. Anexos	99

Capítulo 1: Introducción

“No man should escape our universities without knowing how little he knows”

Julius Robert Oppenheimer (1904-1967)

1. Introducción

Las emisiones de CO₂, la disminución de las fuentes de energía fósiles, el crecimiento de los precios del petróleo, y una tendencia de consumo que se prevé en aumento, tal y como se puede observar en la Figura 1.1, son, entre otros, los factores que afectan las políticas energéticas de muchos países que tienen que afrontar el gran problema de la actualidad, la energía [1]. El uso de combustibles procedentes de la biomasa como el bioetanol, el biodiésel y el bio-oil puede ayudar a mitigar estos problemas debido a su procedencia renovable.



Figura 1.1. Consumo energético mundial y previsiones. Adaptada de [1]

En concreto, el biodiésel ofrece algunos beneficios como combustible alternativo; su biodegradabilidad y baja toxicidad en comparación con el diesel de origen fósil, un perfil de emisiones más favorable [2], la posibilidad de mezclarlo con diésel de petróleo y usarlo de forma directa, y el gran número de materias primas que pueden ser usadas en su producción (como aceites comestibles frescos o usados, aceites no comestibles, algas y grasas de origen animal) hacen de él una interesante alternativa.

En las siguientes líneas se mostrará un resumen de la situación actual del biodiésel en el mercado, en base a esta perspectiva global es fácil observar que el biodiésel puede convertirse en una parte de la solución al problema si éste es producido a partir de fuentes renovables, y no competitivas con otros mercados, como los aceites usados o no

comestibles. Los problemas técnicos y de operación derivados del uso de estas materias primas de baja calidad deben ser afrontados mediante una mejora en el conocimiento de todo el proceso de producción, y del comportamiento (propiedades químicas y físicas) del biodiésel producido a partir de estas materias primas.

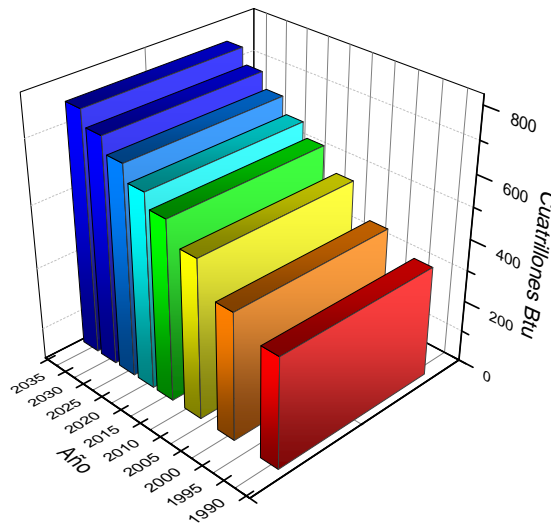
El modelado y la simulación del proceso de producción del biodiésel puede ser una vía para entender mejor como producir biodiésel en contexto menos agresivo con el medioambiente, en un mundo que necesita urgentemente nuevas fuentes de energía.

1.1. Antecedentes y contexto mundial del biodiésel

1.1.1. Marco internacional

La idea de usar aceites vegetales como combustible para los motores data de 1895, cuando Rudolf Diesel desarrolló su primer modelo de motor. En 1912 afirmaría que “el uso de los aceites vegetales como combustibles para los motores puede parecer insignificante hoy en día, pero con el transcurso del tiempo puede ser tan importante como los derivados del petróleo y el carbón en la actualidad” [3]. En 1937 se concede la primera patente a un combustible obtenido a partir de aceites vegetales (aceite de palma), a G. Chavanne, en Bélgica. El bajo precio que por entonces tenía el petróleo hizo que el biodiésel no tuviera un gran desarrollo en el mercado.

Actualmente se consumen diariamente 83,7 millones de barriles de petróleo, y las estimaciones indican que esta cifra alcanzará los 112 millones diarios en 2020 [4]. Cada año se utiliza una cantidad de petróleo cuatro veces superior a la que se descubre [5], por lo que desarrollar soluciones alternativas no es sólo una cuestión ambiental, sino también una necesidad estratégica para el futuro.

La producción de biocombustibles a nivel mundial ha crecido exponencialmente en los últimos años. Su desarrollo ha estado ligado a la subida del precio del petróleo, a las políticas de promoción adoptadas por los distintos países, y a la creciente concienciación social desarrollada en torno al cuidado medioambiental [6].

El mundo apuesta actualmente por el biodiésel y por el bioetanol como alternativa parcial a los combustibles de origen fósil dado que ambos proceden de fuentes renovables y permiten reducir, de modo significativo, las emisiones de dióxido de carbono a la atmósfera.

Según los expertos, en los próximos años el sector de los biocombustibles seguirá expandiéndose pero a un ritmo diferente al que lo ha hecho hasta ahora. Las previsiones indican que el mercado mundial de bioetanol se duplicará, debido principalmente a la rápida expansión de los biocombustibles en Estados Unidos, y el de biodiésel crecerá considerablemente.

Las previsiones indican que la tasa acumulativa de crecimiento anual hasta el 2020 será del 10,1 % (con un volumen de producción estimado de 45.291 millones de litros de biocombustible en 2020) [4].

1.1.2. Marco europeo

En Europa el mercado de los biocombustibles se decanta de forma claramente favorable para el biodiésel. Aunque el bioetanol ha experimentado un mayor incremento de demanda (26,1 %) en comparación con el biodiésel (11,1 %), éste último sigue dominando el mercado europeo con más de dos tercios del mercado de los biocombustibles (77,3 %), ver Figura 1.2.



Figura 1.2. Consumo de biocombustibles en Europa en 2010. Adaptada de [7]

La Figura 1.3 muestra la evolución del consumo de biocombustibles en la UE durante la última década. A lo largo de 2010, el consumo de biocombustibles en Europa se incrementó en 1,7 Mtep (millones de toneladas equivalentes de petróleo) frente a 2,7 Mtep en 2009 [7]. El consumo total en Europa de biocombustibles en 2010 fue de 13,9 Mtep. Esta desaceleración puede ser debida al hecho de que la última Directiva 2009/28/CE es menos ambiciosa de lo esperado (fijando un 10 % de biocombustibles en el sector del transporte) y con los objetivos marcados a largo plazo (2020). La actual crisis económica que atraviesa la eurozona ha podido tener también una parte de influencia en esta contracción en el consumo.

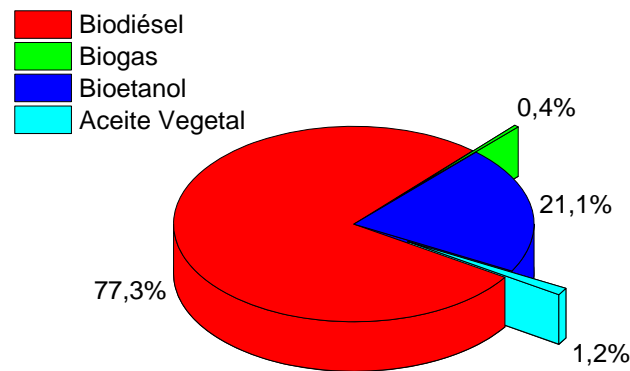

Figura 1.3. Consumo de biocombustibles en Europa durante la última década.

En 2010, Alemania volvió a ser el mayor consumidor de biocombustibles. En ese año su consumo aumentó un 6,5 % en comparación con el año anterior, rompiendo así la tendencia seguida durante 2008 y 2009, en los que su consumo descendió con respecto a los años anteriores, debido a la reducción del porcentaje de incorporación en reacción por la controversia surgida en torno a la producción de biocombustibles. Ésta fue reducida de 6,25 % a 5,25 % para el 1 de enero de 2009 y posteriormente fue restituida de nuevo a 6,25 % a partir del 1 de enero de 2010 y hasta 2014.

En Francia se han llegado a cuotas de implementación de biocombustibles (6,3 %) menores a las propuestas en un principio (7 %), sin embargo este país cuenta con políticas muy potentes para impulsar el consumo de biocombustibles (y por ende su producción) que penalizan la falta o el progreso de las cuotas de implementación de los mismos. Italia va, poco a poco, aumentando el uso de biocombustibles. De acuerdo con el Departamento de Energía del Ministerio de Desarrollo Industrial, Italia ha alcanzado un porcentaje de incorporación del 4,5 % (en contenido energético) comparado con el 3,83 % de 2009.

En España la situación no es muy favorable a fecha actual. Las importaciones de biodiésel, principalmente de países como Argentina e Indonesia, favorecen el consumo pero no la producción de biocombustible de origen nacional, como puede observarse en la Figura 1.4 [8]:

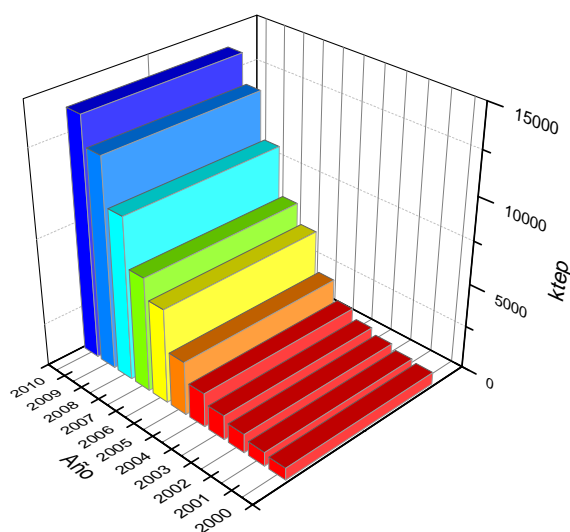

Figura 1.4. Relación entre los consumos de biodiésel nacional e importado en España

En cualquier caso, la política energética europea se ha marcado el reto de que en el año 2020 se haya alcanzado el gran objetivo global “20-20-20”: reducir en un 20 % el consumo de energía primaria, reducir en un 20 % las emisiones de gases de efecto invernadero y elevar al 20 % la contribución de las energías renovables al consumo de energía. Esto implica que en los próximos años, el consumo y la producción de fuentes de energía en general, y biocombustibles en particular, va potenciarse, por lo que la investigación en estos campos es totalmente pertinente.

1.1.3. Estrategia energética: Biodiésel

Con toda la información anterior presente puede deducirse que los biocombustibles, y en concreto el biodiésel, están en una buena posición para ser una parte de la solución al problema del consumo y aprovisionamiento energético.

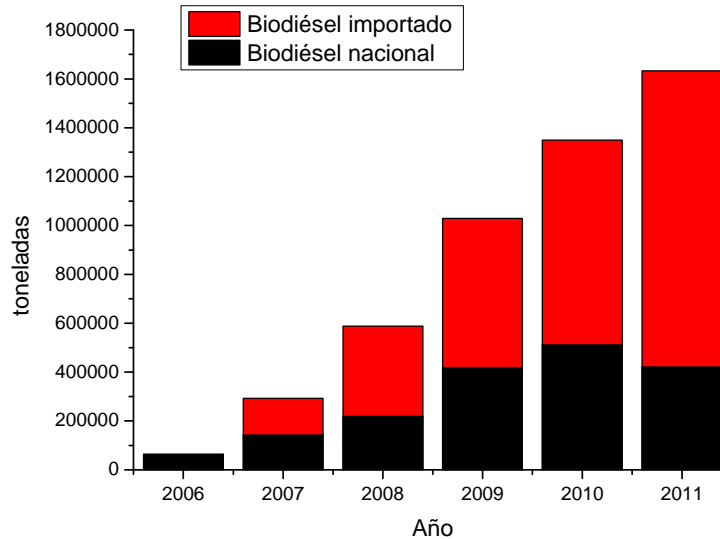
La Figura 1.5 presenta las previsiones (años 2008-2035) del uso de combustibles líquidos (en millones de barriles por día) dividido en sectores. Como puede observarse el consumo en el sector del transporte es clave, y es justo en este sector donde el impacto del biodiésel podría ser más beneficioso desde un punto de vista ecológico, económico y estratégico.



Figura 1.5. Consumo energético mundial por sectores. Adaptada de [1]

Uno de los mayores inconvenientes para la producción de biodiésel es su alto coste comparado con el diesel de petróleo [9]. Este hecho se debe en parte al alto coste de las materias primas, ya que típicamente han sido usados aceites frescos [10], que suponen hasta el 75 % de los costes totales de producción [11]. Una posible solución a estos inconvenientes podría ser el uso de materias primas alternativas. Una excelente compilación de materias primas, tradicionales y alternativas pueden encontrarse en los artículos de Singh [12] y Karmakar y cols. [13].

Si el biodiésel se produce realmente a partir de fuentes renovables no alimentarias como aceites usados o residuales, entonces puede considerarse que llegará a contribuir de forma real a la independencia energética de la UE, y a los problemas medioambientales derivados del uso intensivo de combustibles de origen fósil en el sector del transporte, sin causar tensiones en los mercados alimentarios. El dilema actual *comida frente a combustibles* ha sido puesto recientemente bajo discusión [14, 15], y aunque hay

diferencias de opinión respecto a la influencia real de los biocombustibles en el mercado alimentario, el uso de materias primas alternativas [16] puede ser considerado como un futuro necesario para los biocombustibles.

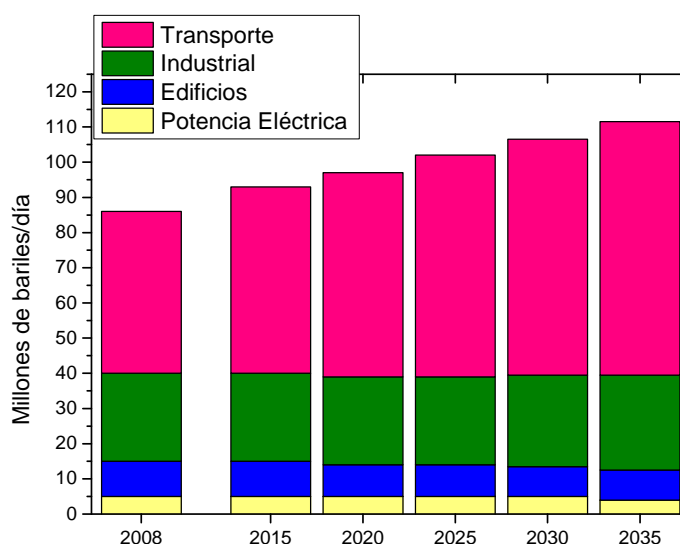
Por otra parte, la producción de biodiésel a partir de estos productos no está libre de problemas técnicos que deben ser resueltos. El uso de aceites usados, por ejemplo, que típicamente contienen un alto nivel de impurezas, como ácidos grasos libres (AGL), sales, agua y otros compuestos químicos producidos debido a la descomposición térmica de los triglicéridos, pueden hacer el proceso de producción mucho más complicado [17].

No solo las condiciones de operación se ven afectadas por el uso de materias primas de baja calidad, también las propiedades finales del biodiésel sufren los efectos. Por ejemplo, debido a su composición de partida, el biodiésel procedente de grasas animales o aceites vegetales de alto contenido en ácidos saturados (palma, coco, etc.) no cumplen con los parámetros de calidad marcados por los estándares del biodiésel. Debido a este motivo, el uso directo de este biodiésel no es posible y debe ser previamente mezclado en las proporciones adecuadas con diferentes tipos de biodiésel de otras procedencias y/o mezclado con aditivos que mejoren las propiedades finales.

Para poder usar estas materias primas es especialmente interesante conocer las relaciones que existen entre estas propiedades y las composiciones de los aceites o grasas de partida. El desarrollo de modelos predictivos de propiedades de biodiésel puede ser la herramienta que permita el uso de estas materias primas, de modo que podrían ser usados para gestionar la producción de biodiésel minimizando los costes de producción.

En el siguiente apartado se lleva a cabo una revisión de las propiedades del biodiésel así como de las materias primas alternativas y las relaciones básicas entre estos dos conceptos.

1.2. Definición, materias primas y propiedades del biodiésel

1.2.1. Definición y producción

El biodiésel es una mezcla de ésteres monoalquílicos de cadena larga, derivados de fuentes renovables, y producidos a partir de lípidos que son forzados a reaccionar con un alcohol de cadena corta. Los alcoholes más usados son el metanol y el etanol. Los productos obtenidos, dependiendo del alcohol usado, son ésteres metílicos y etílicos, también conocidos por sus siglas en inglés *fatty acid methyl esters (FAME)* or *fatty acid ethyl esters (FAEE)* respectivamente. Como sub-producto de la producción de biodiésel se obtiene también glicerina. El biodiésel obtenido usando etanol como alcohol puede ser considerado como procedente totalmente de materiales renovables, pero debido a su menor precio, el metanol es el alcohol más usado a nivel industrial [9].

La reacción de producción de biodiésel es la reacción de transesterificación, esta reacción ha sido típicamente catalizada por bases (concretamente NaOH ó KOH) [18-20] siendo una reacción pseudo-homogénea. Este es el proceso más usado a nivel industrial. Otros métodos alternativos están actualmente en proceso de investigación y/o desarrollo como la catálisis ácida [21, 22], enzimática [23, 24], heterogénea [25-28], o bajo condiciones supercríticas [29, 30].

Tras la reacción de transesterificación se lleva a cabo la separación de los productos, una fase polar compuesta fundamentalmente por glicerina y una fase apolar compuesta en su mayoría por biodiésel. El biodiésel debe ser posteriormente tratado para llegar a cumplir con las normas y estándares de calidad relevantes, estos son; la norma europea EN 14214:2008+A1:2009 (EU) [31] y la norma americana ASTM 6751-07 (USA) [32].

La Figura 1.6 muestra, a modo de ejemplo, las etapas de separación de glicerina (izquierda) y de lavado (derecha), en este caso con agua, del proceso de producción de biodiésel.



Figura 1.6. Etapas de separación y lavado del biodiésel

Aunque es posible encontrar en la bibliografía diferentes métodos de limpieza de biodiésel que se encuentran en desarrollo, (como el uso de geles de sílice [33, 34], membranas [35, 36], ...), industrialmente, el método más común es el lavado con agua, normalmente acidificada, y en varias etapas. La presencia de triglicéridos no reaccionados o parcialmente reaccionados (diglicéridos y monoglicéridos), agua, glicerol y otras sustancias como restos de catalizadores, esteroides [37] y antioxidantes naturales [38] pueden causar incluso daños en los motores, por esto la etapa de limpieza de biodiésel es una de las más importantes a la par que una de las más complicadas, especialmente cuando se usan materias primas de baja calidad.

1.2.2. Estándares y propiedades

Como se ha comentado en la sección anterior, el biodiésel debe cumplir con las normas de calidad correspondientes para su comercialización en distintos países. Así, por ejemplo, en la UE se trata de la norma EN 14214:2008+A1:2009 [31] y en EEUU la ASTM 6751-07 [32]. Los parámetros que estas normas incluyen se presentan en la Tabla 1.1.

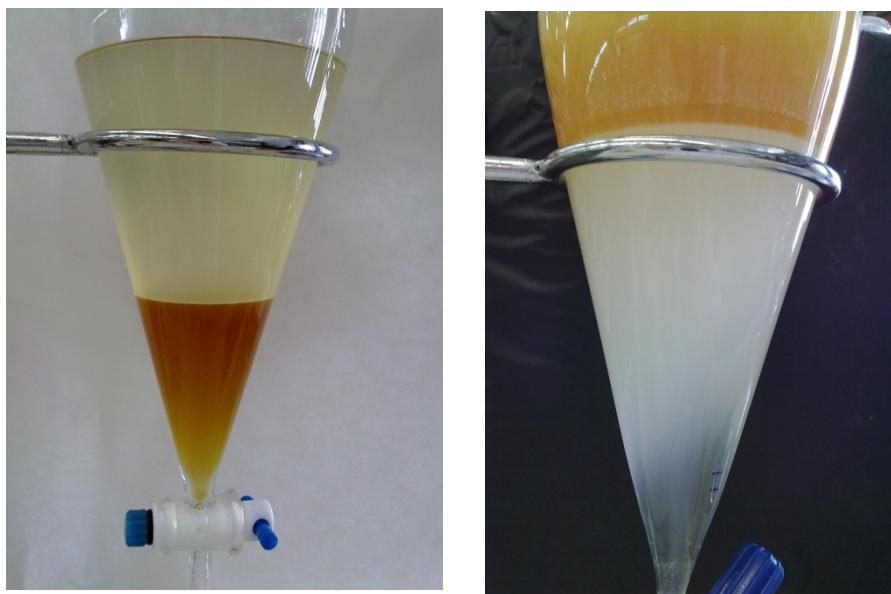
Los parámetros de calidad incluidos en estas normas pueden ser divididos en dos categorías; aquellos dependientes del proceso (conversión en la reacción y limpieza) y

aquellos dependientes de la composición del biodiésel, o en otras palabras, de la composición de las materias primas.

Los parámetros dependientes de la topología del proceso son aquellos para los que las condiciones de operación (temperatura de lavado, cantidades de agua de lavado, etc...) tienen una gran influencia. Por otra parte, cuando el biodiésel ha sido purificado adecuadamente, algunos parámetros como la densidad, viscosidad, índice de cetano, y punto de obstrucción de filtro en frío (POFF) dependen sólo de la composición del biodiésel.

Algunas de las propiedades más importantes de las descritas en la Tabla 1.1 son las siguientes:

- Densidad a 15°C

La densidad del biodiésel es una variable importante que tiene influencia en el proceso de combustión y el sistema de inyección del motor. Además, los valores de la densidad son habitualmente necesarios para el diseño del proceso de producción.

La densidad de los ésteres metílicos depende principalmente de la materia prima que se utilice en la transesterificación para su obtención. Suele tomar valores entre 0,86-0,88 g/cm³, que son bastante próximos a los del gasóleo.

- Viscosidad a 40°C

El proceso de atomización del combustible es la etapa inicial de la combustión en un motor diésel. Este proceso se ve extremadamente afectado por la viscosidad del combustible. De hecho, el principal objetivo de transesterificar los aceites y grasas es disminuir la viscosidad cinemática en casi un orden de magnitud.

Tabla 1.1 Propiedades del biodiésel según normas

Propiedad	Unidades	Especificaciones	
		UNE-EN 14214:2009+A1:2010	ASTM D 6751-02
Contenido de ésteres	% (m/m)	Mín. 96,5	
Densidad a 15°C	g/cm ³	0,86-0,90	
Viscosidad cinemática a 40°C	mm ² /s	3,5-5	1,9-6
Punto de destello	°C	Mín. 101	Mín. 130
Punto de obstrucción de filtro en frío (POFF)	°C	Máx. 5 – Mín. -20	
Contenido de azufre	mg/kg	Máx. 10,0	Máx. 5,0
Res. Carbonoso Conradson 100%	% (m/m)	Máx. 0,3	Máx. 0,05
Número de cetano	-	Mín. 51	Mín. 47
Contenido en cenizas sulfatadas	% (m/m)	Máx. 0,02	Máx. 0,02
Contenido en agua	mg/kg	Máx. 500	
Contaminación total	mg/kg	Máx. 24	
Corrosión al cobre (3h/50°C)	Clasificación	Clase 1	Máx. N° 3
Estabilidad a la oxidación 110 °C	horas	Mín. 6	
Índice de acidez	mg KOH/g	Máx. 0,50	Máx. 0,80
Ester metílico de ácido linoléico	% (m/m)	Máx. 12	
Esteres metílicos poli-insaturados (≥ 4 dobles enlaces)	% (m/m)	Máx. 1,00	
Contenido en metanol	% (m/m)	Máx. 0,20	
Contenido en monoglicéridos	% (m/m)	Máx. 0,80	
Contenido en diglicéridos	% (m/m)	Máx. 0,20	
Contenido en triglicéridos	% (m/m)	Máx. 0,20	
Glicerol libre	% (m/m)	Máx. 0,02	Máx. 0,02
Glicerol total	% (m/m)	Máx. 0,25	Máx. 0,24
Índice de yodo	g yodo/100 g	Máx. 120	
Fósforo	mg/kg	Máx. 4	Máx. 10
Sales metálicas grupo I (Na + K)	mg/kg	Máx. 5	
Metales del grupo II (Ca + Mg)	mg/kg	Máx. 5	
Punto de nube	°C	No incluido	Sin límites

- Punto de destello o Flash Point

El punto de destello de un líquido volátil es la menor temperatura a la que se puede evaporar para formar una mezcla combustible al ser mezclado con aire. Temperaturas de inflamación y combustión altas son propias de hidrocarburos poco volátiles. Esto es un aspecto positivo desde el punto de vista de la seguridad en el transporte, el almacenamiento y el uso de biodiésel. Por otra parte, se pueden presentar problemas en el arranque en frío, lo que empeora las prestaciones del biodiésel comparado con el diésel procedente del petróleo.

- Índice de cetano

Un combustible con un elevado índice de cetano, *cetane number* (CN), tiene un periodo de ignición corto, y comienza a quemarse inmediatamente después de ser inyectado en el cilindro. El índice de cetano se determina mediante el uso de un motor normalizado y depende, en principio, de la composición química del biodiésel.

- Índice de yodo

Este parámetro mide el grado de insaturación del biodiésel, por lo que dependerá de la materia prima. Su valor, está relacionado con la tendencia del biodiésel a oxidarse y su comportamiento a bajas temperaturas.

- Propiedades frías

La tendencia de los combustibles diésel a formar cristales y perder su capacidad de flujo se suele cuantificar mediante una serie de parámetros experimentales, los cuales se conocen comúnmente con el nombre de propiedades frías. Estos parámetros son: el punto de nube, *cloud point* (CP), el punto de fluidez, *pour point* (PP), el punto de obstrucción de filtro en frío (POFF), *cold filter plugging point*, (CFPP) y la prueba de flujo a baja temperatura, *low temperature flow test*. Desde los inicios de la industria del biodiésel en los años ochenta, la industria ha

manifestado su preocupación por los valores deficientes que muestran estos parámetros. Aún los tipos de biodiésel más insaturados presentan un desempeño a bajas temperaturas muy inferior al del combustible diésel convencional. De todos estos parámetros solo el punto de obstrucción de filtro en frío está recogido en la norma europea y el punto de nube en la norma americana.

- Estabilidad a la oxidación

La estabilidad a la oxidación es una de las propiedades más problemáticas del biodiésel. Está altamente relacionada con la composición (cantidad de dobles enlaces) y la presencia de impurezas o antioxidantes naturales que pueden alterar considerablemente la medida de esta propiedad. Una estabilidad a la oxidación de 6 horas, medida mediante el método Rancimat (EN 14112), es necesaria para que el biodiésel cumpla las especificaciones de la norma europea. En el caso de la norma americana (ASTM 6751-07), tan sólo 3 horas son suficientes.

- Contenido en agua

El biodiésel tiene comportamiento higroscópico, por lo que absorbe pequeñas cantidades de agua. Un excesivo contenido en agua puede provocar problemas en el motor y disminuir la estabilidad a la oxidación. El límite marcado por la norma europea es de 500 ppm, mientras que la norma americana no incluye este parámetro.

1.2.3. Materias primas

Existe una gran variedad de materias primas que pueden ser usadas para la producción de biodiésel, la Tabla 1.2 muestra la composición de ácidos grasos de algunas materias primas típicas y otras alternativas.

Los aceites más empleados para la producción de biodiésel a nivel industrial son la colza, soja y girasol [39]. Por su parte, el aceite de palma es considerado una buena materia prima en países como Tailandia, Malasia y Colombia [39, 40]. El biodiésel producido a partir de estas materias primas (especialmente cuando se usa colza, soja o

girasol) suele tener unas propiedades que se acercan e incluso cumplen las normas estándar internacionales. Adicionalmente, las etapas de limpieza no suelen verse complicadas por la aparición de espumas o jabones debido al bajo contenido en AGL de la materia prima. Como contrapartida, el precio de estas materias primas es muy superior al de otras de peor calidad.

Como se ha comentado en secciones anteriores, debido a la controversia generada por la discusión biocombustibles vs. alimento, la búsqueda de materias primas alternativas para la producción de biodiésel ha sido intensa en los últimos años [11-13]. Algunas de las plantas más estudiadas para su uso como fuentes de triglicéridos son la planta *jatropha* [41-44] y el ricino [45-48]. En algunos casos estas materias primas dan lugar a propiedades físicas fuera de los rangos aceptables, un buen número de artículos abordando este aspecto pueden ser encontrados en la bibliografía [49-54].

Grasas de vaca [55], residuos de la industria cárnica y otras grasas animales [56] también han sido objeto de atención para la producción de biodiésel [57-59] pero, debido a su composición, los combustibles producidos a partir de estas materias primas no suelen cumplir con los parámetros de calidad y deben ser mezclados con otros tipos de biodiésel. Además, en la mayoría de los casos, es necesario el uso de aditivos para la mejora de las propiedades más críticas como estabilidad a la oxidación y propiedades frías.

Cuando el contenido en ácidos grasos libres es demasiado elevado, es preciso utilizar procesos adicionales a la transesterificación directa. Los aceites usados, por ejemplo, contienen entre un 2 y un 7 % p/p de AGL mientras que en las grasas el contenido varía entre el 5 y el 30 % p/p. Cuando en estas condiciones se utiliza una base como catalizador, los ácidos grasos reaccionan con él para formar jabones y agua. Según algunos autores, por encima de un 1 % p/p de AGL la reacción de transesterificación comienza a tener problemas derivados de las reacciones secundarias [60]. Cuando el contenido en AGL es suficientemente alto se llega a inhibir la separación entre la fase rica en glicerina y la fase del biodiésel, tal y como se muestra en la Figura 1.7;



Figura 1.7. Emulsión formada durante la transesterificación de una grasa de alto contenido en ácidos

Para solucionar el problema de los AGL es preciso llevar a cabo una reacción de esterificación catalizada por ácido, esta reacción puede llevarse a cabo tanto en fase homogénea como heterogénea [27, 28].

Tabla 1.2 Composición química de las materias primas más comunes y algunas alternativas en la producción de biodiésel

Ester	C8:0	C10:0	C12:0	C14:0	C15:0	C16:0	C17:0	C18:0	C20:0	C22:0	C24:0	C16:1	C17:1	C18:1	C20:1	C22:1	C24:1	C18:2	C18:3	C18:1(OH)	Total
Algas				0,6		6,9		3,0	0,4	0,1		0,2		75,2				12,4	1,2		100
Babasú	0,5	3,8	48,8	17,2		9,7		4,0						14,2				1,8			100
Grasa de vacuno			0,2	2,9	0,6	24,3	1,2	22,8	0,2			2,1	0,4	40,2	0,6			3,3	0,7		99,5
Aceite de borraja						9,3		3,8		0,2				17,1		2,5	1,5	38,7	26,1		99,2
Aceite de camelina						5,0		2,2	1,4	0,4	0,3			17,7	9,8	4,5	0,2	18,0	37,9		97,4
Aceite de colza						3,8		1,9	0,6	0,4	0,2	0,3		63,9			0,2	19,0	9,7		100
Aceite de ricino						0,9		1,1						3,1				4	0,6	90,3	100
Grasa de cerdo				1,3		21,6	0,2	9,0	0,2			2,8	0,3	50,4	0,5	0,3		12,2	1,0		99,8
Aceite de coco 1	6,3	6,0	49,2	18,5		9,1		2,7						6,5				1,7			100
Aceite de coco 2	3,7	3,5	35,7	20,1		14,3		3,9						14,1				4,7			100
Aceite de coco 3	4,1	3,6	35,3	19,8		13,8		3,9						14,3				4,7			99,7
Aceite de café						11,0		3,4	0,6	0,2	0,1	0,5		70,0	0,1			12,7	0,8		99,4
Aceite de maiz						12,1		1,8	0,4	0,2		0,1	0,1	27,2				56,2	1,3		99,4
Aceite de onagra						6,0		1,8						6,6				76,3	9,0		99,7
Aceite de cáñamo						5,2		2,4	0,7	0,5	0,3			13,1				57,1	20,0		99,3
Aceite de hígado I			0,2	1		20,7	0,3	8,9	0,2	0,2		2,7	0,3	46,7	0,8	0,4	0,1	15,6	0,5		98,6
Aceite de hígado II		0,1	0,1	1,5		28,0	0,3	20,2	0,2			1,9	0,2	36,1	0,7	0,3		9,7	0,3		99,6
Aceite de jatropha						12,7		5,5	0,2			0,7		39,1				41,6	0,2		100
Aceite de lino						4,4		3,8	0,2	0,3	0,1			20,7				15,9	54,6		100
Moringa Oleifera						5,5		5,8	3,1	4,2	0,4	1,2		76,3	2,0			0,7			99,2
Aceite de nim						14,9		20,6	1,6	0,3	0,3	0,1		43,9				17,9	0,4		100
Aceite de palma			0,2	0,5		43,4		4,6	0,3	0,1		0,1		41,9				8,6	0,3		100
Grasa de ave			0,1	1,0		19,6	0,3	7,5	0,1	0,3		3,2	0,2	36,8		0,4		28,4	2,0		99,9
Salvado de arroz				0,3		12,5		2,1	0,6	0,3	0,2			47,5				35,4	1,1		100
Aceite de soja						9,4		4,1		0,3				22,0				55,3	8,9		100
Aceite de girasol						4,2		3,3		0,7	0,4			63,6				27,6	0,2		100
Aceite usado de cocina			0,1	0,1		11,8	0,1	4,4	0,3	0,4	0,1	0,4	0,1	25,3		0,3		49,5	7,1		100
Grasas de baja calidad			0,1	0,5		14,3	0,3	8	0,3	0,3		1,1	0,2	35,6		0,2	0,1	35,0	4,0		100

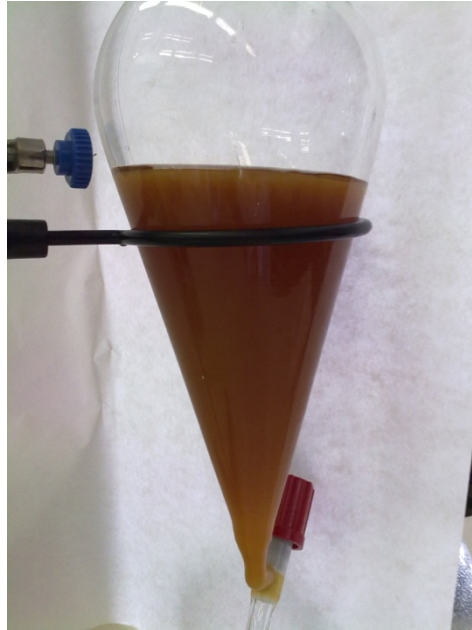
1.3. Simulación y modelado de propiedades

Para lograr el objetivo de producir biodiésel a partir de materias primas de baja calidad (y menor precio) y, al mismo tiempo, cumplir con las especificaciones de calidad necesarias para su comercialización, el uso de estrategias de simulación de procesos puede aportar una ventaja competitiva.

Como se ha mostrado en las secciones anteriores, dependiendo de la composición de las materias primas, el biodiésel puede mostrar un bajo rendimiento en algunos aspectos. Por ejemplo, altas concentraciones de ésteres insaturados disminuyen la estabilidad a la oxidación (debido a la reactividad de los dobles enlaces) [61], esto hace necesario el empleo de aditivos. Las propiedades frías, por su parte, se ven igualmente afectadas por la concentración de ésteres saturados [62] causando en algunos casos problemas en los sistemas de inyección de los motores [63, 64].

La generación de modelos que permitan la predicción de estas propiedades es precisamente uno de los objetivos principales del presente trabajo, y, para ello, se ha realizado un intenso estudio para comprender la relación que la compleja composición del biodiésel tiene con las propiedades físicas que sirven de parámetros de calidad para el mismo.

En esta sección se resume brevemente la profunda revisión bibliográfica que se ha llevado a cabo durante prácticamente todo el recorrido de la tesis. Desde la simulación de procesos aplicada a la simulación de toda una planta de producción de biodiésel hasta el modelado de las propiedades más importantes y problemáticas del mismo.

1.3.1. Simulación del proceso de producción

La simulación del proceso de producción del biodiésel ha atraído la atención de algunos investigadores recientemente, como puede comprobarse en la bibliografía publicada. En estos artículos son analizadas diferentes configuraciones o topologías del proceso; catálisis homogénea tanto ácida como básica [65, 66], catálisis heterogénea [67, 68] y métodos de producción basados en tecnología supercrítica [69, 70]. Uno de los

objetivos principales de estos artículos es la evaluación económica [71] de las diferentes topologías posibles con el fin de encontrar aquella que ofrezca el mejor rendimiento económico.

Zhang y cols. [65] desarrollaron una de las primeras simulaciones en el campo del biodiésel (usando el software Aspen Hysys[®]) en la que se analizaban diferentes alternativas de proceso. Los autores seleccionaron el componente trioleína (uno de los triglicéridos presentes en los aceites comunes) como representante del aceite de colza y, para representar los equilibrios líquido-líquido presentes en los procesos, compararon los resultados usando dos modelos termodinámicos diferentes, el *Non-Random Two Liquids* (NRTL) y el modelo *UNIversal QUasi-Chemical* (UNIQUAC), ambos modelos basados en coeficientes de actividad.

Tras la aparición de este artículo, otros autores realizaron publicaciones tratando de mejorar el conocimiento en este campo; Haas y cols. [71] y West y cols. [69] realizaron sendas simulaciones tratando de encontrar los puntos de mayor rendimiento económico en diferentes topologías de producción. Por su parte, Glisic y Skala [72] usaron el simulador Aspen Plus para realizar una simulación del proceso bajo condiciones supercríticas.

Como se ha comentado antes, la mayoría de estos artículos buscan la realización de una evaluación económica y por ello, durante el proceso de simulación, se realizan algunas simplificaciones. Como consecuencia de estas simplificaciones, algunas propiedades del biodiésel no pueden ser simuladas con la exactitud requerida.

Para ser capaces de simular el proceso de producción adecuadamente y al mismo tiempo ser capaces de determinar las propiedades finales del biodiésel, deben ser tenidas en cuenta las siguientes consideraciones:

- En primer lugar, resulta preciso simular un número adecuado de componentes de los aceites de partida. Considerando que los componentes principales (suponen casi el 90 % p/p) en casi todos los aceites son la trioleína, trilinoleína, tripalmitina y triestearina, estos deberían ser, como mínimo, modelados. La mayoría de estos componentes no se encuentran en las bibliotecas de

componentes de los simuladores comerciales, y por lo tanto han de ser implementados mediante el uso de modelos de estimación de propiedades físicas.

- En segundo lugar es necesaria la selección de un paquete de propiedades termodinámicas apropiado que permita la simulación de equilibrios de fases complejos. Esta tarea no es sencilla, y en muchas ocasiones los parámetros de los modelos deben ser ajustados o estimados mediante otros métodos.
- Las ecuaciones y parámetros cinéticos de las reacciones involucradas deben ser conocidos, ya sea mediante datos empíricos o a partir de datos encontrados en la bibliografía [73, 74]. Es importante tener suficientes parámetros para los diferentes componentes de las materias primas para que de esta forma los procesos en los que las reacciones intervienen puedan ser simulados con fidelidad y los compuestos intermedios no reaccionados puedan ser determinados.
- Por último, las relaciones entre las propiedades del biodiésel y la composición del mismo deben ser encontradas y modeladas. En muchos casos estas ecuaciones no se encuentran implementadas en los simuladores comerciales por lo que deben ser adaptadas para ello.

Evidentemente la simulación de procesos es una herramienta con una potencia destacable, pero para utilizar la herramienta de una manera productiva es necesario conocer la manera en la que las propiedades de los componentes del biodiésel pueden ser modeladas.

1.3.2. Modelado de propiedades

De todas las propiedades que se encuentran en las normas (ver Tabla 1.1, sección 1.2.2), un buen número de ellas pueden ser modeladas en función a la composición química del biodiésel, es decir a sus componentes químicos y a la mezcla de ellos.

Es posible encontrar en la bibliografía un buen número de artículos que tratan del modelado de propiedades de biodiésel, especialmente en los últimos 3 años. Modelos basados en la composición del biodiésel, tanto teóricos como empíricos, han sido publicados para la densidad y viscosidad [75-78]. El índice de cetano [79] y el índice de

iodo [80] también han sido modelados mediante ecuaciones empíricas. Igualmente ocurre con el POFF o el punto de nube (CP) [62, 81]. Recientemente Su y cols. [82] han presentado un estudio sobre estos métodos de predicción de propiedades en el que se puede encontrar un resumen de la situación actual.

A pesar del número de artículos publicados, la mayoría de los modelos existentes adolecen de una falta de exactitud fundamentalmente debida al escaso número de componentes que se consideran para representar el biodiésel, y al escaso número de materias primas (y por tanto estrecho rango de composiciones) que se utilizan en la elaboración y validación de los modelos. Además, en el caso de biodiésel producido usando etanol como alcohol, y a pesar del gran interés que éste despierta, es difícil encontrar modelos para la predicción de propiedades de este tipo de biodiésel.

En este apartado se realiza un resumen del estado del arte en cuanto al modelado de algunas de las propiedades más importantes a la par que se concreta el marco de trabajo de la presente tesis doctoral.

- **Propiedades críticas**

Cuando se desean usar modelos teóricos para la estimación de propiedades como la densidad es preciso conocer con antelación algunas otras propiedades como son las propiedades críticas (presión, P_c ; temperatura, T_c ; volumen específico, V_c), el factor acéntrico (ω) y la temperatura de ebullición (T_{nb}). La determinación experimental de estos parámetros no es una tarea trivial para los ésteres alquílicos puros y tampoco para sus mezclas, por tanto, cuando no hay datos disponibles es preciso usar modelos que permitan su estimación. Algunos de estos modelos están descritos en Poling y cols. [83] y Reid y cols. [84].

De nuevo, en el caso de las propiedades críticas (input necesario por ejemplo para definir componentes en un simulador comercial, Aspen Hysys[®]), la selección del modelo apropiado para su estimación es una tarea complicada debido a la falta de datos experimentales. A este respecto y recientemente, Anand y cols. [85] realizaron una comparación de diferentes métodos de estimación de propiedades críticas y puntos de ebullición de ésteres metílicos puros. Los valores obtenidos se usaron como input en

modelos de cálculo de otras propiedades como presión de vapor, capacidad calorífica y conductividad térmica.

En la presente tesis doctoral se ha llevado a cabo una intensa revisión, comparación y selección de estos métodos tratando de buscar los más apropiados para el cálculo de estas propiedades y su posterior uso en la estimación de otras propiedades del biodiésel así como servir de información de entrada a los programas de simulación comerciales utilizados.

- **Densidad**

El modelado de la densidad, para el biodiésel o para cualquier otra sustancia química, puede dividirse claramente en dos tipos; basado en consideraciones teóricas y basado en datos empíricos.

Uno de los métodos teóricos más empleados en la estimación de la densidad de líquidos saturados es la ecuación de Rackett y sus modificaciones [86]. Un buen número de autores han reportado su uso en la estimación de la densidad de biodiésel de soja [87, 88], palma [89], jatropha [53] y otros tipos de aceites [90].

Las estimaciones basadas en el modelo de Rackett tienen el inconveniente de que el modelo ha sido elaborado para cualquier líquido saturado con independencia de su composición o tipo. Una perspectiva diferente es el uso de modelos empíricos o correlaciones específicamente desarrolladas para el biodiésel. Al igual que los modelos teóricos, los empíricos pueden usar la composición del biodiésel como variable y otras propiedades físicas medibles, así como coeficientes estructurales que mejoren la precisión de los modelos.

Clements [91] reporta el uso de una correlación para estimar la densidad del biodiésel en función de la temperatura, el modelo empírico propuesto usa la composición (considerando cuatro ésteres metílicos como componentes del biodiésel) como input. La densidad del biodiésel es típicamente correlacionada con la temperatura, un resumen de estas ecuaciones se puede encontrar en Lapuerta y cols. [77]. Además, estos mismos autores proponen una ecuación en términos del número de átomos de carbono en el

alcohol original, el número de átomos de carbono en la molécula de ácido graso original y el número de dobles enlaces para calcular la densidad del biodiésel. Estas variables son correlacionadas usando los datos experimentales reportados por Sanford y cols. [92]. En la bibliografía también pueden encontrarse otros modelos para predecir la densidad en mezclas de diésel fósil y biodiésel [75, 93-96].

Los modelos existentes, tanto los teóricos como los empíricos, adolecen de una falta de validación mediante la experimentación, y el uso de materias primas de diferente procedencia. Igualmente, los modelos existentes incluyen en pocos casos el biodiésel producido usando etanol como alcohol. En la presente tesis doctoral se ha llevado a cabo una intensa experimentación que ha sido usada posteriormente como base de cálculo para un modelado y validación de la densidad del biodiésel. Como resultado de este trabajo se ha publicado un artículo en la revista Fuel.

- **Viscosidad cinemática**

Al igual que la densidad, la viscosidad es un parámetro fundamental no solo en las propiedades finales del biodiésel sino también en la simulación de procesos químicos. En este sentido es posible encontrar algunos artículos que tratan de obtener una herramienta capaz de responder a la compleja composición del biodiésel. Debido a las dificultades para simular teóricamente la viscosidad cinemática, la mayoría de los esfuerzos se han invertido en correlacionar los datos experimentales con diferentes ecuaciones. El procedimiento estándar incluye la estimación de las viscosidades individuales de los componentes del biodiésel, y posteriormente el uso de una regla de mezcla simple como las ecuaciones de Kay o de Grundberg-Nissan (GN).

Krisnangkura y cols. [97] propusieron una serie de ecuaciones para el cálculo de la viscosidad de ésteres metílicos individuales dividiéndolos en grupos diferentes, sus resultados son un interesante primer paso. Otros autores han reportado también correlaciones de para estimar la viscosidad [98-101] pero al igual que en el caso de la densidad, la generación y la validación de modelos que permitan incluir un mayor número de componentes en el modelo puede ayudar a mejorar los resultados de las predicciones.

En esta tesis doctoral se ha llevado a cabo una revisión de los modelos existentes, la generación de nuevos modelos en base a datos experimentales propios y encontrados en la bibliografía, generando bases de datos extensas que permiten la validación de los modelos generados.

- **Estabilidad a la oxidación**

La estabilidad a la oxidación del biodiésel es una de las propiedades cruciales que determinan su calidad. En este caso, el modelado de esta propiedad es más complejo y no se puede asegurar que dependa únicamente de la composición del biodiésel o de las materias primas iniciales.

El mecanismo de oxidación del biodiésel es bien conocido [102, 103] y depende fundamentalmente de la composición química del aceite y de la presencia de compuestos antioxidantes. En la bibliografía se pueden encontrar algunos artículos acerca de antioxidantes naturales [104] y sintéticos [105] en los que se muestra que la búsqueda de nuevos aditivos para la mejora de la estabilidad a la oxidación es un tema actual. El método actualmente usado para medir la estabilidad a la oxidación en las normas es el método Rancimat [102, 105, 106]. En este contexto, se ha descrito el uso de nuevas técnicas de análisis [49, 104, 107, 108]. Especialmente interesante es el nuevo método llamado PetroOXY que ha sido recientemente publicado por Neumann y cols. [109]. Este método tiene la gran ventaja de ser mucho más rápido que el método Rancimat permitiendo así realizar búsquedas de aditivos a una mayor velocidad y menor coste.

- **Punto de destello y propiedades frías**

El punto de destello o *flash point* es una propiedad importante para el biodiésel desde un punto de vista de la seguridad en el transporte, y la capacidad de uso en climas y condiciones desfavorables para la ignición o combustión. Su modelado no es sencillo ya en el caso de sustancias puras, y aún menos en el caso de mezclas complejas como el biodiésel.

No obstante, se pueden encontrar algunas correlaciones para la estimación del punto de destello de componentes puros y mezclas. Gharagheizi y cols. [110] clasifican estas correlaciones en tres grupos; (i) las correlaciones que incluyen otras propiedades físicas como el punto de ebullición, densidad o viscosidad, (ii) las correlaciones que incluyen parámetros estructurales, o relaciones de estos con las propiedades, también llamados *quantitative structure-property relationships* (QSPR) y (iii) las correlaciones basadas en los métodos de contribución de grupos. A pesar de que el punto de destello es un parámetro muy importante relacionado con la seguridad, solo se han encontrado unos pocos modelos en la bibliografía [82, 111] para el cálculo de esta propiedad en el caso del biodiésel.

Al igual que el punto de destello, las propiedades frías entre las que se encuentran el CP, PP y POFF, son difíciles de modelar, y muy importantes para la calidad del biodiésel.

El punto de nube y el punto de fluidez corresponden a procesos termodinámicos relacionados con la formación y crecimiento de cristales en el seno del líquido a medida que baja la temperatura, por este motivo pueden ser modelados mediante, eso sí, complejos modelos termodinámicos. Sin embargo, el punto de obstrucción de filtro en frío es una propiedad que resulta más complicada de modelar ya que existe una gran cantidad de factores que le afectan. Algunos autores han desarrollado correlaciones empíricas que intentan predecir el POFF en base a la composición del biodiésel [80, 112] y para el caso de mezclas con diésel de origen fósil [81].

En esta tesis doctoral se ha realizado una aproximación al modelado de estas propiedades en base a una extensa experimentación en el laboratorio. Como resultado de esta experimentación el conocimiento generado ha contribuido a la gestación de nuevas líneas de investigación que continuarán con este trabajo.

1.4. Tareas realizadas y contribuciones

Tal y como se comenta en los apartados anteriores, en esta línea de investigación se han encontrado áreas de gran interés, como por ejemplo aquellas correspondientes a la

simulación de la producción de biodiésel, y el modelado de propiedades de mezclas de diferentes tipos de biodiésel a partir de su composición química. No obstante, otras áreas han despertado el interés del grupo, como la producción de triacetinas o la utilización de glicerina en la producción de sub-productos de alto valor añadido, habiéndose realizado diferentes trabajos (habitualmente en formato de proyectos de fin de carrera) en este sentido.

Probablemente el punto de mayor interés se encuentre en la combinación del modelado de propiedades y la utilización de aditivos para la mejora de las mismas. En este sentido se continúan realizando trabajos en el grupo mediante otra tesis doctoral, que pretende continuar ahondando en el conocimiento que se ha obtenido.

Los siguientes artículos que componen la base de esta memoria son el resultado de los diferentes estudios realizados con el fin de profundizar en el conocimiento que el Grupo de procesos Termoquímicos de la Universidad de Zaragoza tiene sobre el biodiésel. Los artículos publicados siguen una clara línea de continuidad, desde un análisis inicial del estado del arte en cuanto a la simulación y modelado de propiedades, y de equilibrios de fases en el procesado de biodiésel, hasta el modelado concreto de propiedades físicas del biodiésel a partir de la composición de las materias primas.

- I.** M. García, A. Gonzalo, J.L. Sánchez, J. Arauzo, J.Á. Peña, *Prediction of normalized biodiesel properties by simulation of multiple feedstock blends*, Bioresour. Technol., 101 (2010) 4431-4439. [113]
- II.** A. Gonzalo, M. García, J.L. Sánchez, J. Arauzo, J.A. Peña, *Water Cleaning of Biodiesel. Effect of Catalyst Concentration, Water Amount, and Washing Temperature on Biodiesel Obtained from Rapeseed Oil and Used Oil*, Ind. Eng. Chem. Res, 49 (2010) 4436-4443. [114]
- III.** M. García, A. Gonzalo, J.L. Sánchez, J. Arauzo, C. Simoes, *Methanolysis and ethanolysis of animal fats: A comparative study of the influence of alcohols*, Chem. Ind. Chem. Eng. Q, 17 (2011) 91-97. [115]

- IV.** M. García, J.J. Alba, A. Gonzalo, J.L. Sánchez, J. Arauzo, *Comparison of Methods for Estimating Critical Properties of Alkyl Esters and Its Mixtures*, J. Chem. Eng. Data, 57 (2011) 208-218. [116]
- V.** M. García, J.J. Alba, A. Gonzalo, J.L. Sánchez, J. Arauzo, *Density of alkyl esters and its mixtures. A comparison and improvement of predictive models*, Fuel, (10.1016/j.fuel.2012.07.049), (2012)
- VI.** M. García, J.J. Alba, A. Gonzalo, J.L. Sánchez, J. Arauzo, *Empirical modelling of the kinematic viscosity of biodiesel produced with methanol and ethanol*. En revisión, revista Fuel.

Informe de contribución:

Mi contribución como autor en cada uno de los artículos de esta memoria ha sido:

Artículo I: Responsable del proceso de simulación, obtención de datos, análisis de resultados y redacción.

Artículo II: Supervisión del trabajo experimental, responsable del análisis de resultados, de la simulación de los mismos mediante paquetes termodinámicos y redacción.

Artículo III: Responsable de la parte experimental, análisis de resultados y redacción.

Artículo IV: Responsable de la parte experimental, análisis de resultados y redacción.

Artículo V: Responsable de la parte experimental, análisis de resultados y redacción.

Artículo VI: Responsable de la parte experimental, análisis de resultados y redacción.

Además, fruto del trabajo realizado en esta tesis doctoral, se ha participado en los siguientes congresos:

- II Bioenergy Fuels and Chemicals From Renewable Resources European Biomass Conference, Rio de Janeiro, Brazil, March 8-13, 2008

M. García, A. Gonzalo, J.A. Peña, *Comparison of predictive models for the esterification and transesterification reactions in biodiesel production. Application in a production plant simulation*. Póster

- 11th Mediterranean Congress of Chemical Engineering, Barcelona, España. 21-24 Octubre 2008

M. García, A. Gonzalo, J.A. Peña, *Comparison of predictive models of biodiesel properties. Application in a production plant simulation.* Póster

Capítulo 2: Resumen

“The fascination of a growing science lies in the work of the pioneers at the very borderland of the unknown, but to reach this frontier one must pass over well-travelled roads; of these one of the safest and surest is the broad highway of thermodynamics.”

Gilbert Lewis and Merle Randall, Thermodynamics and the Free Energy of Chemical Substances (1923)

2. Resumen

Una vez presentados en el capítulo anterior los antecedentes y una revisión bibliográfica del tema a tratar, es el papel de este capítulo presentar un resumen de los resultados del trabajo desarrollado, así como los objetivos y el plan de trabajo que se ha llevado a cabo.

Este capítulo se divide de esta forma en tres secciones; los objetivos y el plan de trabajo, los métodos experimentales usados, explicados aquí de forma resumida, y los resultados obtenidos y que han sido, en su mayoría, publicados.

Tal y como se ha presentado en la sección anterior (sección 1.4), como resultado del trabajo desarrollado durante esta tesis doctoral un total de 5 artículos han sido publicados, y uno más está en proceso de revisión. Además de estos resultados ha de señalarse se ha participado mediante póster en dos conferencias sobre biocombustibles y se han dirigido en el contexto de esta tesis un total de nueve proyectos de fin de carrera.

2.1. Objetivos y plan de trabajo

Dada la necesidad actual de buscar fuentes de energía renovables, la investigación en el proceso de producción de biodiésel resulta ser de un gran interés. Cuando desde el GPT se comenzó con esta línea de investigación, un importante trabajo se estaba desarrollando, a nivel mundial, sobre distintos aspectos, entre los que destacan, por el número de artículos publicados, la búsqueda de nuevas fuentes de triglicéridos y el uso de catalizadores alternativos.

Ante esta situación, el grupo de investigación se decantó por investigar sobre el proceso que actualmente se está llevando a cabo nivel industrial de forma mayoritaria, con algunas variaciones en función del proceso que se usa, en el ue se lleva a cabo la producción del combustible mediante catálisis básica homogénea, realizándose la limpieza del biodiésel producido con agua normalmente acidulada. La simulación de dicho proceso puso de relieve las lagunas que actualmente existen en este campo, así

como la necesidad de disminuir el coste de las materias primas, sin dejar de cumplir las propiedades que las normas exigen para su comercialización.

Por tanto, se planteó como objetivo principal de esta Tesis Doctoral profundizar en el conocimiento del proceso de producción de biodiésel con el fin de optimizarlo, permitiendo el uso de materias primas de menor coste, usando para ello la simulación de procesos y el modelado de propiedades físicas. Con el fin de alcanzar este objetivo global, se plantearon los siguientes objetivos parciales:

- Llevar a cabo una simulación del proceso industrial más extendido de producción de biodiésel para detectar los principales problemas y desarrollar estrategias de mejora.
- Establecer los modelos termodinámicos más adecuados para el cálculo de los distintos equilibrios del proceso.
- Obtener, mediante experimentación en el laboratorio, una base de datos de propiedades físicas y composiciones químicas de diferentes materias primas que permitan el estudio y modelado de las propiedades del biodiésel en base a su composición.
- Modelar algunas de las propiedades más importantes del biodiésel (tales como la densidad a 15°C, la viscosidad cinemática y la estabilidad a la oxidación) que dependen de la composición del biodiésel, en un amplio rango de contenido de distintos ésteres, tanto metílicos como etílicos

La consecución de estos objetivos permitirá implementar todo este conocimiento en una herramienta de simulación, que puede ser de gran utilidad, tanto para el diseño como para la producción de biodiésel ya que puede permitir la optimización del proceso “en línea”, al tener la capacidad de considerar las diferentes materias primas que entran al proceso, sus calidades y sus composiciones.

2.2. Método experimental

En esta sección se describen de forma resumida los métodos experimentales usados durante la realización de la tesis doctoral. Los detalles concretos de cada método se encuentran en los correspondientes artículos, en las secciones de método experimental.

Especial mención merece en este apartado la colaboración mantenida con la empresa de producción de biodiésel BIOARAG S.L. ubicada en Altorricón, provincia de Huesca. Una buena parte de la sección experimental de esta tesis doctoral ha sido realizada en las instalaciones de esta empresa, especialmente la medición de algunas propiedades del biodiésel, como la densidad y la estabilidad a la oxidación mediante el método Rancimat.

2.2.1. Producción de biodiésel

Las instalaciones experimentales con las que se ha trabajado están situadas en el laboratorio del Grupo de Procesos Termoquímicos (GPT), perteneciente al Departamento de Ingeniería Química y Tecnologías de Medio Ambiente de la Universidad de Zaragoza (UZ) y al Instituto Universitario de Investigación en Ingeniería de Aragón (I3A), también de la misma universidad.

- **Materias primas**

Para la producción de biodiésel en el laboratorio se han utilizado una gran cantidad de materias primas de diverso origen, desde aceites usados hasta grasas de origen animal procesadas expresamente para su uso como materias primas en la producción de biodiésel. En algunos casos el biodiésel se ha producido a partir de aceites o grasas puros y, posteriormente, se han realizado mezclas entre ellos. En otros casos se han mezclado los aceites o grasas antes de llevar a cabo la reacción. La Tabla 2.1 muestra un resumen de estas materias primas:

Tabla 2.1 Materias primas usadas en el trabajo experimental realizado

Aceites vegetales		Grasas animales
Girasol	Coco	Vaca
Oliva	Palma	Grasa cerdo casera
Colza	Semillas	Grasa de cerdo industrial
Soja	Cártamo	
Ricino	Cacahuete	

- **Reactivos**

Los reactivos fundamentales que se han utilizado son los siguientes:

- Metanol de pureza 99%, suministrado por PANREAC.
- Etanol de pureza 99%, suministrado por PANREAC
- Hidróxido de potasio en lentejas de pureza 98%, suministrado por PANREAC.
- Hidróxido de sodio en lentejas de pureza 98%, suministrado por PANREAC.
- Metóxido y etóxido de sodio 21%, suministrado por PANREAC.
- Ácido clorhídrico 1M, suministrado por PANREAC.
- Sulfato de magnesio de pureza 98%, suministrado por PANREAC.
- Glicerol puro, suministrado por PANREAC.

- **Instalación experimental**

En la Figura 2.1 se muestran los dos reactores donde tiene lugar la reacción de transesterificación del aceite para la obtención de biodiésel, así como la esterificación cuando ha sido necesaria.



Figura 2.1. Instalación para la producción de biodiésel

La instalación experimental está constituida por los siguientes elementos:

- Ultra-termostato de circulación P-Selecta Frigiterm-10.
 - Manta calefactora para matraz con regulación electrónica P-Selecta Fibroman-N.
 - Reactor de vidrio de 1000 mL de capacidad.
 - Termómetro de contacto electrónico P-Selecta Sensoterm-II.
 - Agitador Heidolph RZR 1.
 - Condensador de vidrio.
 - Cierre de agitación para vacío ANORSA A130-1.
- **Descripción del procedimiento experimental para la producción de biodiésel**

La reacción de transesterificación del aceite vegetal tiene lugar en la instalación experimental que se ha mostrado en la Figura 2.1 expuesta anteriormente. El procedimiento general de trabajo se describe brevemente a continuación. Este procedimiento ha sido optimizado durante la etapa inicial de la tesis, y se puede generalizar con algunas modificaciones para los dos alcoholes usados, metanol y etanol.

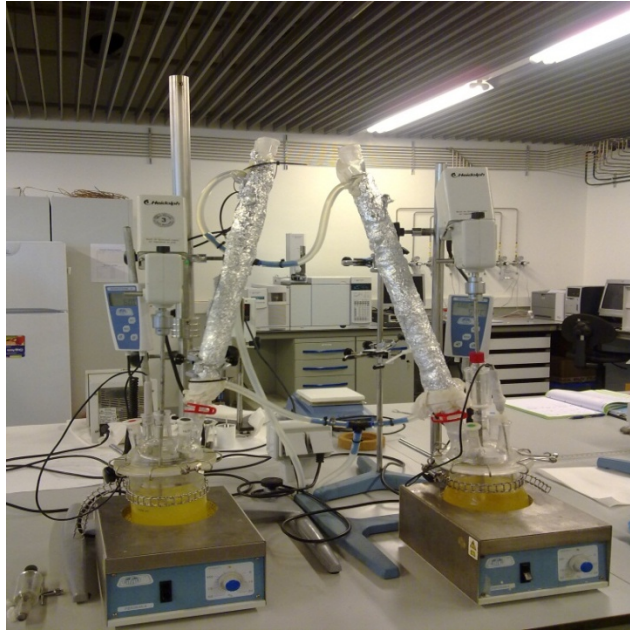
En algunos casos las peculiaridades de las materias primas han obligado a llevar a cabo operaciones adicionales, tales como etapas extra de reacción o acondicionamientos previos. Los detalles de estas operaciones pueden encontrarse en los artículos publicados y que sirven de base para esta tesis.

Se pesan 500 gramos de aceite/grasa en el mismo reactor de transesterificación. Después se coloca el reactor en la instalación experimental, y se conecta el termopar y el controlador, para que el aceite alcance el valor de consigna de temperatura, 60/78 °C (en función del alcohol usado en la reacción). Mientras se alcanza dicha temperatura, se pesan la cantidad apropiada (relación molar 6:1 alcohol:aceite) de alcohol en un vaso de precipitados de 250 mL y 5 gramos de KOH/NaOH en un vidrio de reloj, se añade éste último al vaso de precipitados con el alcohol y se agita hasta su total dilución.

Cuando el aceite ha alcanzado la temperatura de consigna se añade el alcohol con el catalizador disuelto al reactor que contiene dicho aceite/grasa. Esta reacción transcurre durante 90-180 minutos dependiendo del caso. Los productos obtenidos se trasvasan a un embudo de decantación donde, tras unos minutos, se observan dos fases, la correspondiente a la glicerina en la parte inferior y la correspondiente a los ésteres de ácidos grasos en la parte superior.

Una vez se ha eliminado el alcohol del biodiésel en el rotavapor, se procede a lavar el biodiésel en un embudo de decantación con agua acidulada (con relación en peso de biodiésel/agua, 1:1). La cantidad de ácido clorhídrico que se añade al agua es, aproximadamente, de 1,5 g; consiguiendo, de este modo, un pH próximo a 2. Se realizan tres lavados, hasta que la fase del agua de lavado se obtiene transparente.

Por último, se seca el biodiésel para eliminar la máxima cantidad de agua posible; primero en el rotavapor a 60 °C de temperatura y 0,8 bares de vacío y, posteriormente, añadiendo un desecante como es el sulfato de magnesio para eliminar las trazas de agua que hayan podido quedar en el biodiésel.

2.2.2. Caracterización del biodiésel

Los métodos de caracterización de biodiésel están en su mayoría normalizados. En la presente tesis doctoral se han utilizado, siempre que ha sido posible, métodos de medición de propiedades y/o caracterización normalizados según se detalla en la norma Europea de calidad EN 14214:2008+A1:2009.

- **Cromatografía de gases**

La composición en ácidos grasos se determinó mediante cromatografía de gases, de acuerdo a las normas EN 14103 (2003) e ISO 5508 (1990). Los ésteres metílicos y etílicos en un cromatógrafo de gases (GC) marca Agilent Serie 6890, con una columna DB-225 MS, marca Agilent también, de dimensiones (30 m x 0.25 mm x 0.25 μ m). Las condiciones fijadas para el análisis fueron: temperatura del inyector de 250 °C, temperatura del detector 250 °C, usando helio como gas portador con un flujo de 1 mL/min. La inyección de la muestra (1 μ L) se realizó de modo manual, en modo “split”, usando una relación de split de 35:1. El programa de temperaturas seguido en el horno fue: temperatura inicial de 170 °C, calentamiento a 3 °C/min hasta 203 °C, tras alcanzar esta temperatura calentamiento a 1,5 °C/min hasta alcanzar 214 °C, y una última rampa a 5 °C/min hasta los 230 °C, esta temperatura se mantiene durante 16 min antes de dar por acabado el análisis.

En algunos casos, y para asegurar la identificación de los diferentes componentes de las mezclas, se han llevado a cabo análisis cromatográfico usando otro equipo disponible en el departamento consistente en un cromatógrafo de gases de la marca Agilent, modelo 7890A, que dispone de dos detectores, un espectrómetro de masas y un detector de ionización de llama, los cuales están conectados en paralelo con una sola columna cromatográfica.

A continuación, se detallan los principales parámetros del método:

- Columna capilar HP-5 (5 % fenil metilsiloxano) con una longitud de 30 m, un diámetro interno de 0,32 mm y 0,25 μ m de espesor.
- Helio de 99,999% de pureza como gas portador.

- Temperatura del inyector de 280 °C.
- La rampa de temperatura utilizada parte de 50 °C, temperatura que es mantenida durante 5 minutos; posteriormente, se sube la temperatura hasta 63 °C con una rampa de 1,8 °C·min⁻¹, a continuación, se aumenta desde 63 °C hasta 160 °C con una rampa de 5 °C·min⁻¹ y, por último, elevando la temperatura con una velocidad de 3 °C·min⁻¹ se alcanza la temperatura final de 295 °C, la cual es mantenida durante 30 minutos.
- El detector masas trabajó en modo de escaneo completo entre las relaciones masa/carga (m/z) de 45 y 425.
- La identificación de los compuestos se ha realizado utilizando la biblioteca de espectros de masas Wiley 275 y NIST 05.

- **Medida de propiedades.**

Igual que en el caso del análisis cromatográfico, la medida de propiedades físicas del biodiésel se ha llevado a cabo en todos los casos en base a la norma europea EN 14214:2008+A1:2009. En este apartado se reseñan los métodos usados, y se describen brevemente los más significativos:

- (i) Densidad a 15 °C según la norma EN 12185. La medición de esta propiedad se llevó a cabo en los laboratorios de BIOARAG S.L.
- (ii) La viscosidad cinemática se determinó con un viscosímetro Cannon-Fenske (Cannon Instrument Co.) a 40 °C siguiendo la norma EN ISO 3104. En este método se registra el tiempo que le cuesta pasar a un volumen fijo de muestra a través del viscosímetro, que se encuentra calibrado por el fabricante.
- (iii) Índice de yodo según la norma EN 14214 (2003), anexo. B.
- (iv) Estabilidad a la oxidación de acuerdo con la norma EN 14112 (2003), según el método Rancimat. Esta propiedad se midió también usando el equipo PetroOXY (Petrotest) según el método descrito en la propuesta de norma prEN 16091:2010. Este método, en principio, es más preciso y rápido que el tradicional (Rancimat). En este aparato se colocan 5 mL de muestra en la cámara de reacción, se presurizan hasta 700 kPa con oxígeno puro y se calientan hasta 140 °C. Esto produce un aumento de presión, que al cabo de

cierto tiempo comienza a descender, debido al consumo del oxígeno por las reacciones de oxidación que sufre el biodiésel. El tiempo transcurrido hasta que la presión que registra el equipo cae un 10 % sobre la máxima presión medida es el tiempo de inducción a la oxidación a 140 °C.

- (v) Contenido en alquil ester del ácido linolénico, mediante GC según la norma EN 14103 (2003).
- (vi) Contenido en agua mediante valoración Karl Fischer según norma EN ISO 12937 (2003).
- (vii) Valor ácido, por valoración volumétrica siguiendo la norma EN 14104 (2003).
- (viii) El punto de obstrucción de filtro en frío (POFF) se midió en un equipo modelo FPP 5G (ISL) según indica la norma EN 116. En este equipo se enfría un volumen de muestra y se fuerza a pasar, a una temperatura más baja cada vez, a través de un filtro de 45 µm de luz, con una pequeña bomba que succiona. Al disminuir la temperatura del biodiésel, el crecimiento de cristales de parafina, se provoca la obstrucción del filtro. Cuando el tiempo que le cuesta fluir al biodiésel es mayor que 20 s, se considera que la temperatura ha alcanzado el POFF.
- (ix) El flash point se determinó en un equipo según el método de Pensky-Martens en copa cerrada, marca Petrotest modelo PMA4 según la norma ASTM D 93. En este equipo la temperatura de la muestra se eleva, a la par que una pequeña llama, o fuente de ignición, se acerca periódicamente a la superficie del líquido. Cuando se produce la ignición del vapor, el equipo registra la temperatura como el flash point

2.3. Resultados y discusión

En esta sección de resultados se presenta un resumen del trabajo realizado y que ha conducido a la publicación de cinco artículos, más otro que ha sido enviado y está en proceso de revisión. Estos artículos muestran el progreso en el conocimiento que el Grupo de Procesos Termoquímicos ha ido adquiriendo a medida que se avanzaba en el trabajo realizado. Como se desea remarcar, una primera toma de contacto con la simulación del proceso de biodiésel desembocó en una amplia revisión bibliográfica, y

sirvió no sólo para la publicación del primer artículo, sino también para perfilar las líneas de investigación principales que se desarrollarían posteriormente.

Siguiendo el camino marcado por los resultados obtenidos se llevaron a cabo simulaciones para entender los equilibrios de fases en las etapas de lavado del biodiésel (dando lugar a la segunda publicación de esta tesis) y paralelamente se llevó a cabo una intensa experimentación en el laboratorio para la producción de biodiésel (usando tanto metanol como etanol como alcoholes) a partir de diferentes materias primas, con el fin de analizar las composiciones y medir las propiedades físicas de estos tipos de biodiésel. Como parte de este trabajo se publicó un artículo sobre la producción de biodiésel (basado en EtOH y MeOH) a partir de grasas animales (dos tipos de grasas de cerdo y una grasa de vaca) reportándose rendimientos superiores a 86 % para la metanolisis y superiores a 78 % para la etanolisis.

El conocimiento adquirido durante este trabajo fue posteriormente utilizado en la fabricación de nuevos conjuntos de biodiésel, mezclas de una gran variedad de materias primas, cuyas composiciones fueron analizadas y sus propiedades físicas medidas con el objetivo de desarrollar modelos, tanto teóricos como empíricos, que permitieran su predicción en base a la composición de las materias primas. Por una parte, este trabajo ha dado como resultado la publicación de dos artículos; un artículo en el que se evalúan modelos de predicción de densidad de biodiésel, a la par que se proponen mejoras a los mismos, y otro artículo dedicado a la viscosidad cinemática del biodiésel en los mismos términos, evaluación y comparación de modelos además de proponer nuevas correlaciones para biodiésel tanto de metanol como etanol.

Adicionalmente, toda la experimentación realizada ha servido de germen de nuevas ideas que llevan a la continuación de la línea de investigación mediante una tesis doctoral que da continuación a la presente.

En esta sección de resultados se resumirán las principales conclusiones y aspectos de los artículos que constituyen la base de esta tesis, sin olvidar en ningún momento que la información principal se encuentra recogida en los propios artículos.

2.3.1. Simulación del proceso de producción de biodiésel

Como se ha comentado, la línea de investigación comenzó con la simulación del proceso completo de producción de biodiésel. En el estudio que se llevó a cabo se usó, al igual que en la mayoría de los trabajos previos encontrados en bibliografía, el software Aspen Hysys[®].

Para llevar a cabo la simulación de cualquier proceso, es necesario seleccionar los compuestos químicos que intervienen, un paquete de propiedades termodinámicas para calcular la interacción entre los mismos y la distribución en distintas fases, así como las ecuaciones cinéticas de las reacciones químicas que ocurren en los distintos equipos. A partir de esta información, se puede determinar cuál es la disposición de la planta que se va a simular y variar las condiciones de operación. En las siguientes líneas se presenta un breve resumen del procedimiento llevado a cabo y de los resultados que, como se ha comentado anteriormente, sirven de inicio a la línea de investigación.

- **Definición de componentes**

En los trabajos publicados previamente sobre este tema se encontró que todos ellos simplificaban el proceso, usando únicamente un triglicérido para simular el aceite de partida, lo que impide estudiar la variación de la materia prima sobre las propiedades finales del biodiésel. Por ello se decidió usar, de partida, una composición que reflejara con mayor realismo los aceites más comúnmente usados. Para ello se emplearon cuatro triglicéridos (trioleína, tripalmitina, triestearina y trilinoleína) que, en diferentes proporciones, suman alrededor del 90 % en peso de los aceites vegetales más comúnmente usados (como girasol, soja y colza).

Aunque la mayor parte de los compuestos que intervienen en el proceso de producción de biodiésel aparece en la base de datos de Aspen Hysys[®] (metanol, glicerina, ácido sulfúrico, NaOH, agua, metil oleato, metil palmitato, metil linoleato, metil estearato, ácido oleico, ácido palmítico, ácido linoleico, ácido esteárico y trioleína), para los compuestos no disponibles, básicamente tres triglicéridos (tripalmitina, tristearina y trilinoleína) es necesario definir lo que se denomina “compuestos hipotéticos” o

“hipocomponentes”, para lo cual se necesita la estructura UNIFAC, el punto de ebullición normal, las propiedades críticas y el factor acéntrico.

- **Modelos termodinámicos y cinéticos**

La selección del modelo termodinámico tiene influencia fundamental en los cálculos que implican equilibrios. Debido a la presencia de compuestos polares, se usaron los modelos NRTL y UNIQUAC, usando el método UNIFAC para estimar los coeficientes binarios no disponibles.

Por lo que respecta a las ecuaciones cinéticas, de las disponibles en bibliografía se usaron, para la etapa de esterificación, la propuesta por Berrios y cols. [73], y para la transesterificación la cinética de Lee y cols. [74]. La selección de estas ecuaciones se realizó tras una comparativa de las ecuaciones propuestas por diferentes autores con datos experimentales hallados en la bibliografía. La comparación mostró que las ecuaciones y parámetros seleccionados eran los que menor error reportaban.

- **Diagrama de flujo del proceso**

En la simulación se incluyó el acondicionamiento de las materias primas, una etapa de esterificación previa a la transesterificación y las etapas posteriores de purificación y separación del biodiésel producido. En la Figura 2.2 se muestra un diagrama simplificado del proceso. Una descripción en profundidad sobre la topología del proceso puede ser encontrada en el artículo publicado [113]. De modo resumido, el proceso simulado cuenta con:

- Pre-tratamiento, que consta de una etapa de secado, simulada por un intercambiador de calor y un separador flash, una etapa de esterificación, catalizada con ácido sulfúrico, que se lleva a cabo en un reactor de mezcla perfecta, seguida por una separación de las fases formadas (fase acuosa y fase de triglicéridos).
- Etapa de transesterificación, que consiste en otro reactor de mezcla perfecta y una separación, en este caso la glicerina se separa de la fase rica en metil ésteres.

- Etapa de acondicionamiento del biodiésel formado, donde se trata la fase biodiésel obtenida mediante lavado con agua y posterior secado flash para obtener el producto final.



Figura 2.2. Diagrama simplificado del proceso de producción de biodiésel simulado

- **Modelos de propiedades finales del biodiésel**

Aspen Hysys[®] proporciona algunas propiedades como densidad, viscosidad, capacidad calorífica, etc. Otras propiedades, necesarias para su comercialización tal y como establece la norma EN 14214, como número de cetano, propiedades frías, flash point, etc., no son calculadas directamente, por lo que es necesario implementarlas en el simulador de procesos, lo que se realiza gracias a la programación en *Visual Basic for Applications* (VBA), implementada en Aspen Hysys[®]. En la Tabla 2.2 se muestran los modelos usados en esta simulación.

- **Resultados**

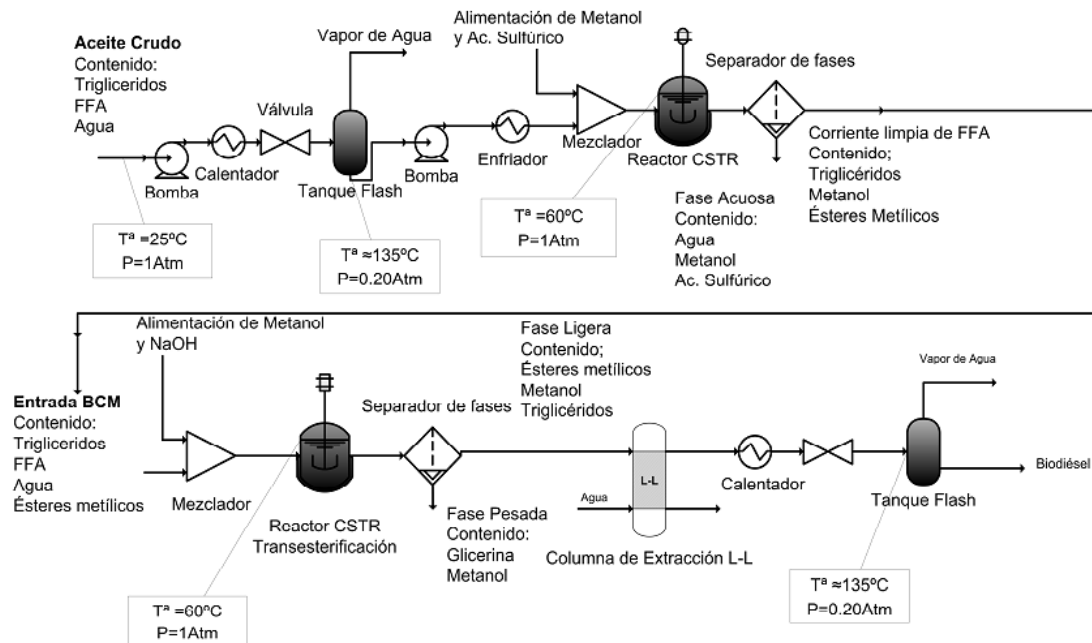
De la simulación realizada parece desprenderse que el modelo termodinámico NRTL es ligeramente más adecuado para la simulación del proceso de producción de biodiésel. NRTL muestra un comportamiento que está en buena consonancia con algunos datos

experimentales sobre equilibrios reportados en la bibliografía [117, 118], pudiendo concluirse que puede ser usado en primera aproximación para la simulación de los equilibrios de fases en el proceso. Sin embargo las diferencias con el modelo UNIQUAC no son muy grandes, por lo que se necesita más información acerca de los distintos equilibrios que aparecen en el proceso.

Por lo que respecta las propiedades finales del biodiésel, aquellas que marca la norma EN 14214:2008+A1:2009 [31] y que son de obligado cumplimiento para su comercialización en Europa (o ASTM 6751-07 [32] en EEUU), aunque existen modelos para su predicción para una buena parte de ellas, muchos tienen asociada una incertidumbre elevada, mientras que para otros, como por ejemplo para el punto de destello o punto de nube, ni siquiera existe en la bibliografía una correlación adecuada, por lo que es necesario un esfuerzo en este sentido para poder diseñar un biodiésel cuyo coste en materias primas sea lo más bajo posible, a la vez que cumple todas las propiedades requeridas.

Tabla 2.2 Variables y modelos empleados para la determinación de propiedades no disponibles en Aspen Hysys®.

Propiedad	Método de Cálculo		Referencia
Viscosidad cinemática	Correlaciones y regla de mezcla $Ln\mu_{Sat-C12:0-C18:0} = -2.177 - 0.202z + \frac{403.66}{T} + \frac{109.77z}{T}$ $Ln\mu_{C18:1} = -5.03 + \frac{2051.5}{T}$ $Ln\mu_{C18:2} = -4.51 + \frac{1822.5}{T}$ $Ln\mu = \sum_i^n y_i \mu_i$	Ecs. 1-4	[97]
Cloud Point	Correlación polinómica basada en datos de [119]		[119]
POFF ^a	Correlación $POFF = 3.1417LCSF - 16.477$ $LCSF = 0.1y_{C16:0} + 0.5y_{C18:0}$	Ecs. 6-5	[80]
Índice de cetano	Regla de mezcla $CN = \sum_i^n y_i CN_i$	Ec. 7	[80]
Índice de yodo	Regla de mezcla $IV = \sum_i^n y_i IV_i$	Ec. 8	[31]
PCS ^b	Regla de mezcla $HHV = \sum_i^n y_i HHV_i$	Ec. 9	[91]
Flash Point	Correlación $FP(K) = 0.3544 \cdot T_{nb}^{1.14711} \cdot z^{-0.07677}$	Ec. 10	[120]

^a Punto de obstrucción de filtro en frío, ^b Poder calorífico superior.

donde y_i es la fracción másica (en %) de cada metil ester, n es el número de metil ésteres, $LCSF$ (“*Long Chain Saturated Factor*”) es un factor adaptado de la referencia [80], z es el número de átomos de carbono, y T_{nb} es la temperatura de ebullición normal de la sustancia.

2.3.2. Etapa de limpieza del biodiésel mediante lavado con agua. Estudio experimental y simulación de la misma

Tal y como se puede observar tras la revisión bibliográfica realizada, un aspecto de la producción de biodiésel que ha sido objeto de menor atención es el que concierne a los equilibrios que se encuentran en la etapa de purificación del biodiésel obtenido tras la transesterificación. Por ello se planteó un estudio básico, para establecer experimentalmente la influencia de tres factores (% de catalizador usado en la transesterificación, cantidad de agua usada en el lavado y temperatura de la misma) sobre tres propiedades del biodiésel (densidad, viscosidad y acidez), y cinco contaminantes (agua, sodio, metanol, glicéridos y glicerina), usando dos aceites como materia prima, aceite de colza y aceite usado.

Para ello se fijaron las condiciones experimentales dentro de los rangos más habituales que se pueden encontrar en bibliografía [34, 36, 121-124], y que responden también a las condiciones utilizadas a nivel industrial. Para realizar la experimentación se usó un diseño de experimentos (DOE) factorial completo con dos niveles, más réplicas en el punto central, y los resultados se analizaron estadísticamente mediante análisis de varianza (ANOVA). Mediante el simulador de procesos Aspen Hysys[®] se comprobó la idoneidad de los paquetes termodinámicos NRTL y UNIQUAC para la predicción, comparando con los resultados experimentales.

A continuación se describe con mayor detalle el proceso seguido en este estudio.

- **Parte experimental**

Tal y como se ha comentado, se produjo biodiésel a partir de aceite de colza comercial y aceite usado de fritura doméstica, usando metanol como alcohol de cadena corta y NaOH como catalizador homogéneo, en las condiciones de temperatura (60 °C) y relación molar metanol/triglicéridos (6 a 1) usadas normalmente en bibliografía. El aceite usado se sometió previamente a un calentamiento a 120 °C, para eliminar agua, y filtrado. Ambos aceites se sometieron, previamente a la transesterificación, a una etapa

de esterificación, catalizada con ácido sulfúrico y una relación molar alcohol/ácido de 33 a 1, tras la cual se lavaron con glicerina pura.

Para la transesterificación se varió la cantidad de NaOH entre el 0,7 y 0,9 %, en base másica sobre el aceite utilizado, y la reacción se llevó a cabo durante 90 minutos. Tras la separación de la fase de glicerina formada, a temperatura ambiente durante 12 horas, se llevó a cabo la etapa de lavado con agua, variando la cantidad de agua de lavado del 30 al 90 % del peso de biodiésel, y la temperatura a la que se llevó el lavado, de 40 a 60 °C. Los sistemas usados se hallan descritos en el apartado 2.2 *Método experimental* del presente resumen, así como en el artículo publicado [114].

- **Diseño de experimentos y análisis de varianza**

Con el fin de establecer el efecto de las condiciones de operación sobre las variables respuesta medidas, se usó un diseño de experimentos factorial completo 2^3 , realizando tres réplicas del punto central con el fin de establecer la varianza debida al error experimental.

Este diseño implica el uso de 8 condiciones experimentales distintas asociadas a la combinación de los dos niveles de cada factor (% NaOH, % agua y T^a del agua) más una debida al punto central. Normalmente, el análisis de los resultados se efectúa con las variables codificadas, siendo -1 el nivel más bajo (0,7 % NaOH en el caso del catalizador) y +1 el nivel más alto (0,9 % NaOH). El punto central se codifica como 0, que corresponde a 0,8 % en el caso de la cantidad de catalizador usada. En la Tabla 2.3 se muestran los valores usados correspondientes a los distintos niveles.

El biodiésel obtenido se analizó antes y después de la etapa de lavado, con el fin de comprobar el efecto de ésta, además de las condiciones de la misma.

Los resultados obtenidos, once experimentos para cada tipo de aceite usado, se analizaron mediante ANOVA, usando el software Design Expert[®] v7.0.

Tabla 2.3 Factores usados

Factor	Rango real	Rango codificado
NaOH	0,7 %	-1
	0,8 %	0
	0,9 %	+1
Agua	30 %	-1
	60 %	0
	90 %	+1
Temperatura de lavado	40 °C	-1
	50 °C	0
	60 °C	+1

El análisis de varianza consiste en separar la varianza total, observada en los datos, en varianza causada por el cambio de cada uno de los factores experimentales, así como en las interacciones de los mismos, y comparar cada una de estas varianzas con la medida para el error experimental (que se obtiene de las réplicas, en este caso del punto central). Esta comparación se hace con el test F de Fischer, para la cual se fijó el nivel de significación (α) en 0,05 (5 %). Esto permite discriminar de forma objetiva si la varianza causada por el factor difiere significativamente del error y por tanto el factor tiene efecto en la respuesta, o no.

- **Simulación de la etapa de lavado con Aspen Hysys®**

El biodiésel se simuló como una mezcla de 5 ésteres metílicos, la presencia de triglicéridos mediante la trioleína y la acidez con ácido oleico. La etapa de lavado se simuló con una columna de extracción líquido-líquido operando en continuo, donde se desprecia la posible pérdida de carga. Tal y como se ha comentado, se usaron dos paquetes termodinámicos, UNIQUAC y NRTL [65, 66, 69, 125-127].

- **Efecto de la etapa de lavado y las condiciones**

Las propiedades y contaminantes medidos antes de la etapa de lavado son muy similares para los dos tipos de biodiésel producidos, observándose también que el % de NaOH usado para la transesterificación tampoco ejerce un efecto aparente sobre los mismos.

Acidez y viscosidad aumentan sensiblemente tras el lavado, indicando por un lado que el NaOH que queda en la fase biodiésel está neutralizando los ácidos que permanecen, y por otro la presencia de compuestos con menor viscosidad, como puede ser el metanol. La densidad también aumenta, pero muy poco, en torno a 2 kg/m^3 tras el lavado. El contenido en agua de las muestras de biodiésel aumenta en algunas ocasiones tras el lavado y en otras disminuye, mientras que otros contaminantes como NaOH y glicerina prácticamente no son detectables tras el lavado, debido posiblemente a su carácter polar. Los glicéridos por su parte no varían con la etapa de lavado, en este caso debido a su carácter apolar.

Por lo que respecta a las condiciones, lo más llamativo es que la cantidad de agua que permanece en el biodiésel, disminuye al aumentar la cantidad de agua que se usa en el lavado, indicando algún tipo de interacción con otros compuestos presentes, y aumenta con la temperatura de lavado. De las propiedades del biodiésel, únicamente la acidez y la viscosidad se ven afectadas por el proceso, siendo la temperatura de lavado el factor que mayor influencia ejerce. Las tendencias observadas para ambos aceites son similares, aunque en el caso del aceite usado, algunos factores no ejercen efectos significativos, mientras que en el de colza sí.

- **Resultado de la simulación**

De los dos modelos termodinámicos usados, UNIQUAC ofrece unos resultados muy alejados de los datos experimentales, por lo que se considera más adecuado el NRTL. En todo caso hay que tener en cuenta que la presencia de electrolitos, como el NaOH, no está soportada en este paquete. Sin embargo, como se resume a continuación, los resultados siguen una tendencia que se corresponde con la de los datos experimentales.

Así, por ejemplo, el contenido en agua tras el lavado aumenta, en la simulación, al disminuir el agua de lavado y aumentar la temperatura, tal y como se observa experimentalmente. Por lo que respecta a la presencia de metanol tras el lavado, la simulación indica que sería necesaria otra etapa de limpieza, pues se obtienen valores superiores a lo que indica la norma EN 14214, por lo que el modelo NRTL debería mejorarse en este aspecto.

La acidez del biodiésel tampoco se predice bien, lo que puede deberse a la simplificación en la composición del biodiésel y a la ausencia de coeficientes de interacción entre el NaOH y los compuestos orgánicos presentes en el equilibrio.

La simulación de procesos químicos es, como se ha indicado, una potente herramienta que puede ayudar a optimizar el proceso de producción de biodiésel pero que también tiene limitaciones, y estas limitaciones se ven especialmente reflejadas en el modelado de equilibrios de fases complejos como el que se ha estudiado en este artículo. Para mejorar las simulaciones en este sentido es preciso desarrollar nuevos paquetes de propiedades termodinámicas que puedan trabajar con electrolitos o mejorar el ya existente, Elect-NRTL [72] en Aspen Hysys[®], lo que implica la determinación experimental o estimación de nuevos coeficientes de interacción entre componentes. Este es, como puede suponerse, todo un campo de investigación que está actualmente siendo estudiado por muchos autores, no sin grandes esfuerzos.

2.3.3. Producción de biodiésel con metanol y etanol a partir de materias primas alternativas

Las propiedades físicas del biodiésel que dependen fundamentalmente de la composición de las materias primas (densidad, viscosidad cinemática, temperatura de ebullición, punto de destello, POFF, CP, PP, índice de cetano, etc.) son el principal problema para el uso de materias primas alternativas ya que habitualmente sus valores no entran dentro de los rangos que marcan los estándares oficiales EN 14214:2008+A1:2009 (EU) [31] o ASTM 6751-07 (USA) [32].

Algunas de las materias primas más interesantes, por su carácter de residuos, son las grasas animales que en combinación con el etanol como alcohol en la reacción de

transesterificación podrían hacer del biodiésel un biocombustible completamente obtenido a partir de fuentes renovables. En este trabajo se estudió la influencia de la materia prima y del alcohol usado en algunas propiedades del biodiésel final obtenido.

- **Parte experimental**

La producción de biodiésel en laboratorio se llevó a cabo en el sistema experimental mostrado en el apartado 2.2.1, usando tres materias primas distintas, grasa de cerdo comercial (PF), grasa de cerdo industrial (CPF) y grasa de vaca (NBT), producida de forma artesanal para este trabajo. Para la reacción de transesterificación se usó una reacción molar alcohol/triglicérido de 6 a 1 y un 1 % (p/p) de metóxido o etóxido sódico, según el alcohol usado, metanol o etanol. La temperatura usada también varió en función del alcohol usado, 60 °C y 78 °C para metanol y etanol respectivamente.

Además de determinar gravimétricamente el rendimiento de la reacción, se midieron algunas propiedades de interés, como son densidad, viscosidad cinemática, punto de obstrucción de filtro en frío y estabilidad a la oxidación, de acuerdo a los métodos establecidos en la norma EN 14214.

- **Resultados obtenidos**

Las tres grasas animales pueden ser usadas para la producción de biodiésel con un rendimiento adecuado, en torno al 86 % en el caso de usar metanol, mientras que al usar etanol el rendimiento es algo menor, oscilando entre el 78 y el 83 %, como puede verse en la Tabla 2.4. Esto puede estar relacionado con la mejor separación entre la fase biodiésel obtenida y la glicerina cuando se usa metanol para la transesterificación [128].

Una característica típica de las grasas animales es la alta cantidad de ésteres saturados, principalmente palmítico (hasta el 26 % p/p) y esteárico (16 % p/p). En la Tabla 2.4 se muestra el contenido en metil ésteres de los diferentes tipos de biodiésel producidos, medido según el método definido en la norma EN 14214. En esta tabla BM hace referencia al biodiésel producido con metanol y BE al producido con etanol. Ya que el método contempla el uso de metil heptadecanoato como patrón interno, y éste se encuentra presente en los triglicéridos de las grasas, si se aplica la corrección propuesta

por Schober y cols. [129], se obtiene una mayor pureza medida del biodiésel, lo que coincide con otros trabajos publicados [56], y confirma que la norma EN 14103 (2003) no es apropiada para la determinación del contenido en ésteres del biodiésel obtenido a partir de grasas.

En la Tabla 2.4 se muestra también la densidad a 15 °C para los BM y BE producidos. Todas las muestras de biodiesel cumplen la norma europea EN 14214 (860 kg/m³ mínimo y 900 kg/m³ máximo). La densidad de los BM es ligeramente superior a la de los BE. Los datos obtenidos coinciden con otros datos publicados tanto para BM [55, 130, 131] como para FAEE [132]. Se observa que el biodiésel obtenido a partir de grasas presenta una densidad menor, lo que se puede atribuir a la presencia de concentraciones mayores de ésteres de baja densidad, como palmítico y esteárico. Estos resultados también son coincidentes con los mostrados por Teixeira y cols. [133] y Dias y cols.[134].

Tabla 2.4 Rendimiento de la reacción y propiedades del biodiésel obtenido.

	BM			BE		
	PF	CPF	NBT	PF	CPF	NBT
Rendimiento (%)	87,7	86,7	86,3	78,4	82,6	82,7
Contenido en metil ester (% p/p)	96,31 ^a ;98,62 ^b	97,93 ^a ;99,77 ^b	96,95 ^a ;99,43 ^b	>96,5	>96,5	>96,5
Densidad a 15°C (kg/m ³)	876,3	873,80	873,31	872,7	871,2	870,3
Viscosidad cinemática a 40 °C (mm ² s ⁻¹)	4,51	4,57	4,77	5,01	4,98	5,16
Índice de yodo (gI ₂ /100g)	60,0	56,8	37,6	57,9	55,1	36,8
Estabilidad a la oxidación (h)	2,84	6,27	2,56	4,70	8,70	3,60

a; con corrección. b; sin corrección.

Atendiendo a los valores de viscosidad, los ésteres etílicos tienen mayor viscosidad cinemática, comparados con los valores de los BM. El aumento en la viscosidad debido a la sustitución de metanol por alcoholes más pesados se halla descrita en la bibliografía [135]. Joshi y cols. [136], estudiaron el efecto de la mezcla BM/BE en la viscosidad, y encontraron una relación curvilínea en la viscosidad cinemática.

En el estudio realizado, dos tipos de biodiésel producidos a partir de grasa (PF y NBT) muestran un valor superior a 5 mm²/s, que es el límite superior establecido por la norma EN 14214. Los valores de viscosidad cinemática del biodiésel producido a partir de grasa son, en general, mayores que los obtenidos cuando se usan aceites vegetales. Esto coincide con lo mostrado por Dias y cols. [134] y Teixeira y cols. [133] quienes encontraron una relación lineal entre viscosidad y % de grasa de vaca, en el biodiésel obtenido mezclando este material con aceite de soja.

El índice de yodo, que se muestra también en la Tabla 2.4, es apreciablemente más bajo que para el biodiésel obtenido a partir de aceites de soja y girasol [80]. De las tres materias primas probadas, el NBT tiene en menor índice de yodo, lo que está directamente relacionado con la menor presencia de compuestos insaturados. Estos

resultados están en concordancia con los mayores niveles de insaturación que se encuentran en materias primas vegetales [55, 56]. Joshi y cols. [136] encontraron mayores valores de índice de yodo en BM que en BE, por lo que propusieron la mezcla de ambos para reducir este valor en el biodiésel. Un resultado similar se puede encontrar en Dias y cols. [134].

Por lo que respecta a la estabilidad a la oxidación, únicamente dos de las muestras de biodiesel producidas alcanzan el valor mínimo de 6 horas que requiere la norma EN 14214, ambos producidos a partir de CPF con metanol y etanol. La baja estabilidad a la oxidación que se muestra en la Tabla 2.4 se puede atribuir a la ausencia de antioxidantes naturales en las grasas animales [137], aunque los valores encontrados son, en general, mayores que los mostrados por Ramos y cols. [80], obtenidos a partir de biodiésel producido con aceite. Estos autores atribuyen los valores de estabilidad a la presencia de linoleico y linolénico, cuya posición de dobles enlaces es fácilmente oxidable. Ya que estos compuestos están presentes en baja proporción en las grasas animales, los valores de estabilidad a la oxidación serían mayores que para esos aceites vegetales, a pesar de la ausencia de antioxidantes. Como se observa en la Tabla 2.4, los BE muestran mayor resistencia a la oxidación que los BM. Joshi y cols. [136] muestran resultados similares, explicando la diferencia por el aumento en peso molecular debido al uso del etanol frente al metanol.

En base a la experimentación realizada y los resultados obtenidos [115] puede concluirse que la producción de biodiésel a partir de grasas animales de media/baja acidez es factible usando tanto metanol como etanol como alcoholes en la reacción. Las propiedades físicas finales de estos tipos de biodiésel varían dependiendo del alcohol y la materia prima usada pero en todo caso se encuentran en rangos cercanos a los marcados por los estándares oficiales, esto permitiría su uso mediante el mezclado con biodiésel de distinto origen. Precisamente en este punto es donde resultarían de utilidad modelos de predicción de propiedades físicas en función a la composición. Los trabajos que se han realizado a continuación de éste caminan en esta dirección.

2.3.4. Inicio del modelado de las propiedades del biodiésel: propiedades críticas

Para estimar algunas propiedades macroscópicas del biodiésel, como densidad, viscosidad cinemática y flash point, se necesita también la estimación de propiedades termofísicas relacionadas con factores microscópicos. Estas propiedades son la temperatura crítica, presión crítica, volumen crítico, factor acéntrico y temperatura normal de ebullición de los compuestos individuales así como los de la mezcla resultante. Todas estas propiedades deben estimarse con tanta exactitud como sea posible, con el fin de generar el mínimo error en el subsecuente modelado de la propiedad macroscópica.

Con este fin, se han aplicado métodos teóricos con un enfoque microscópico, como los de Contribución e Interacción de Grupos, para calcular las propiedades críticas de FAME y FAEE puros. Los métodos elegidos son Constantinou & Gani (CG) y Wilson & Jasperson (WJ) como métodos de contribución de grupos, mientras que como métodos de interacción de grupos se usaron los métodos de Marrero & Pardillo (MP), Ambrose (A) y Joback (J). Para calcular el factor acéntrico se usaron las ecuaciones Lee-Kesler (L-K). Estos métodos se encuentran descritos en detalle en los libros de Poling y cols. [83] y Reid cols. [84].

A partir de estos métodos, se crearon tres paquetes para la estimación de las propiedades críticas, que se han comparado mediante el modelado de una propiedad macroscópica, como es la densidad. En la Tabla 2.5 se concretan los métodos usados en cada paquete:

Tabla 2.5 *Métodos de estimación usados para cada propiedad en los paquetes*

Propiedad	Paquete 1	Paquete 2	Paquete 3
T_{nb}	CG	MP	Y*/CG
T_c	CG	MP	A
P_c	WJ	WJ	A
V_c	CG	MP	J
ω	L-K	L-K	L-K

*Se ha usado la correlación de Yuan(Y) [138], correlación empírica específica para FAME, para el cálculo de T_{nb} , en el Paquete 3.

Un objetivo que se planteó en este trabajo fue evaluar la bondad de dos metodologías distintas, la contribución de grupos y la interacción de grupos, para el cálculo de las propiedades críticas del biodiésel, por lo cual se crearon los Paquetes 1 y 2. En el caso del Paquete 3, los métodos seleccionados para el cálculo de las propiedades críticas se basan en la teoría de contribución de grupos, pero, a diferencia del método GC, en el Paquete 1, que tiene en cuenta contribuciones de los grupos que forman la molécula de segundo orden, los métodos de Ambrose y Joback únicamente consideran contribuciones de primer orden. Adicionalmente, la correlación empírica de Yuan (Y) [138], obtenida para FAME, se usó para el cálculo de T_{nb} en el Paquete 3.

En la Figura 2.3 se muestra el procedimiento de cálculo seguido: se calculan las propiedades críticas, factor acéntrico y punto normal de ebullición usando cada paquete para cada compuesto puro. Una vez calculadas las propiedades críticas, se han seguido dos vías distintas para comparar la bondad de los paquetes propuestos:

- (i) se ha calculado la densidad de los ésteres metílicos y etílicos puros a 15 °C (288,15 K) usando la ecuación de Rackett modificada por Spencer y Danner [86] (Ec. 11) en combinación con la ecuación de Soave [139] (Ec. 12) y los valores se han comparado con valores de densidad de los compuestos puros, y
- (ii) se ha calculado el valor de la densidad de las mezclas de los ésteres alquílicos (biodiésel) usando el concepto de “pseudo componente”, y se ha comparado con valores experimentales de densidad de biodiésel.



Figura 2.3. Vías seguidas para la comparación de los métodos de cálculo de las propiedades críticas

$$\rho = \frac{MW_m}{\frac{RT_{cm}}{P_{cm}} Z_{Ra}^{[1+(1-T_r)^{2/7}]}} \quad (\text{Ec. 11})$$

$$Z_{Ra} = 0.02908 - 0.099\omega + 0.04\omega^2 \quad (\text{Ec. 12})$$

Como se ha indicado, el factor acéntrico se ha calculado usando las siguientes ecuaciones (Ecs. 13-16) (L-K);

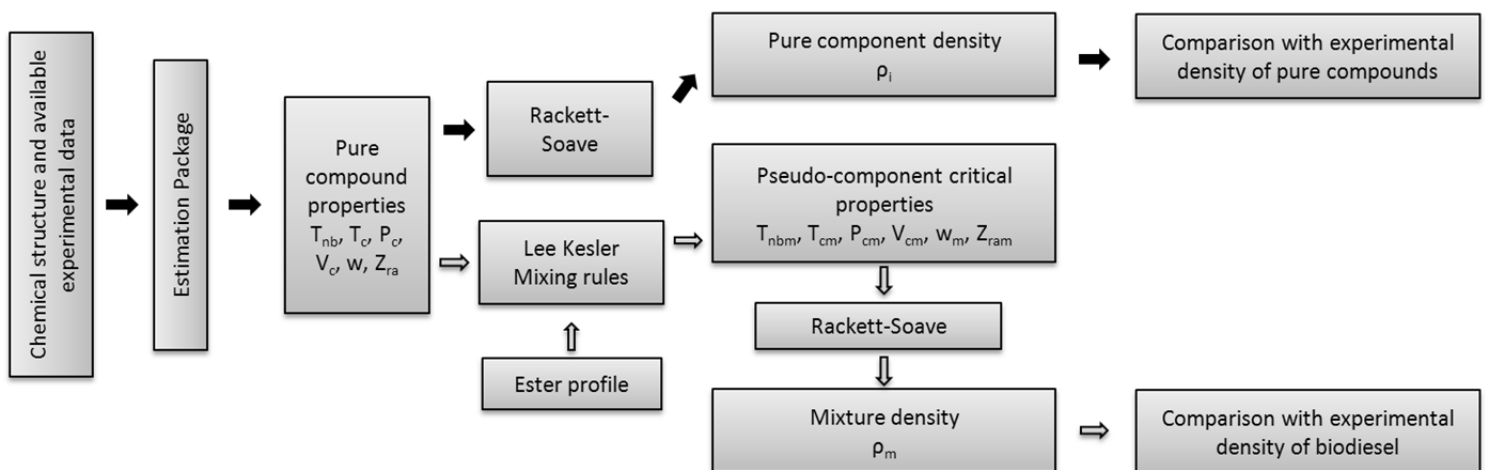
$$\omega_i = \alpha/\beta \quad (\text{Ec. 13})$$

$$\alpha = -\ln P_{ci} - 5.92714 + 6.09648\theta^{-1} + 1.28862 \ln \theta - 0.169347\theta^6 \quad (\text{Ec. 14})$$

$$\beta = 15.2518 - 15.6875\theta^{-1} - 13.4721 \ln \theta + 0.43577\theta^6 \quad (\text{Ec. 15})$$

$$\theta = T_{nbi}/T_{ci} \quad (\text{Ec. 16})$$

Los valores experimentales para la comparación con los valores calculados a partir de los tres paquetes se han obtenido de Sanford y cols. [92] en el caso de los BM, y otras dos referencias [90, 140] para los BE.

- **Resultados**

Ya que no se dispone de valores experimentales para las propiedades críticas, se optó por comparar con valores experimentales de otras propiedades, calculadas a partir de las críticas, como son densidad y punto de ebullición, que se pueden medir más fácilmente y de las que se pueden encontrar valores en bibliografía.

El trabajo realizado puede resumirse en los siguientes puntos;

- Comparación con valores de temperatura de ebullición normal de ésteres alquílicos puros

Aunque únicamente unos pocos valores experimentales de puntos de ebullición normal de FAME [77] y FAEE [141] se encuentran publicados, estos valores se pueden usar para comprobar la bondad de los paquetes generados en el caso de ésteres alquílicos puros.

En la Figura 2.4 se muestran datos experimentales de T_{nb} de algunos ésteres metílicos y etílicos junto con los valores calculados con los dos métodos citados (CG and MP). La desviación relativa media (ARD %), calculada mediante la ecuación 17, para cada caso es: CG MeOH ARD=3,25 %, MP MeOH ARD=3,47 %, CG EtOH ARD=2,52 %, MP EtOH ARD=8,75 %.

$$ARD (\%) = \frac{\sum_i^N \frac{|x_{exp,i} - x_{est,i}|}{x_{exp,i}}}{N} \cdot 100 \quad (\text{Ec. 17})$$



Figura 2.4. Valor experimental [77, 141] y calculado de T_{nb}/K de ésteres metílicos y etílicos puros usando los métodos CG y MP. □, Exp. MeOH; ○, CG; △, MP; ■, Exp. EtOH; ●, CG; ▲, MP.

En el caso de los ésteres metílicos puede encontrarse una pequeña diferencia entre ambos errores, encontrándose ambos dentro de rangos aceptables. En la Figura 2.4 puede observarse como los métodos CG y MP sobreestiman la temperatura de ebullición en el caso de los ésteres etílicos siendo el menor error el correspondiente al método CG con un ARD de 2,52 %.

- Densidad de los ésteres alquílicos

En la Figura 2.5 se muestra una comparación entre valores de densidad de ésteres metílicos puros [77] y los valores calculados con los paquetes propuestos.

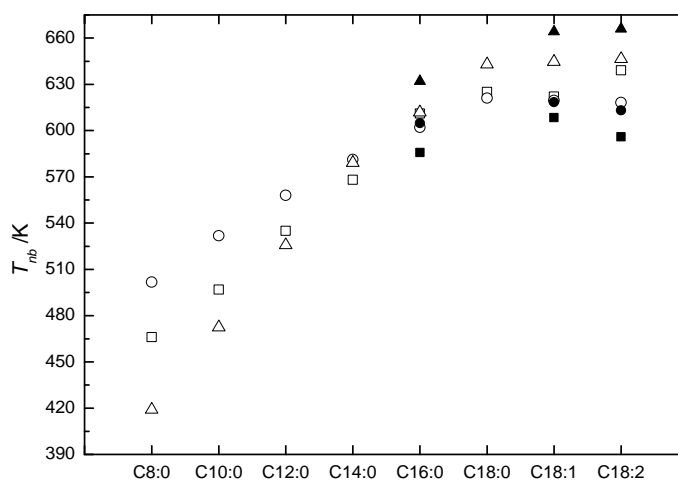
Es posible observar que el Paquete 3 subestima las densidades mostrando un ARD de 6,61 %, mientras que el Paquete 2 muestra un mejor comportamiento con un ARD de 5,42 % pero subestima las densidades de los ésteres de mayor peso molecular como los C20:0 y C21:1. El Paquete 1, por su parte, muestra la peor ARD de 8,72 %.



Figura 2.5 Densidades de ésteres metílicos puros calculadas con los Paquetes 1 a 3 y datos experimentales de Lapuerta y cols. [77]. \square , Paquete 1; \circ , Paquete 2; \triangle , Paquete 3; ∇ , Experimental.

Encontrar datos referentes a densidades de ésteres etílicos puros no es una tarea fácil. Algunos valores han sido encontrados en Lapuerta y cols. y se han usado en esta comparación [77]. En la Figura 2.6 se muestran los valores experimentales y calculados de la densidad a 15 °C con los tres paquetes usados.

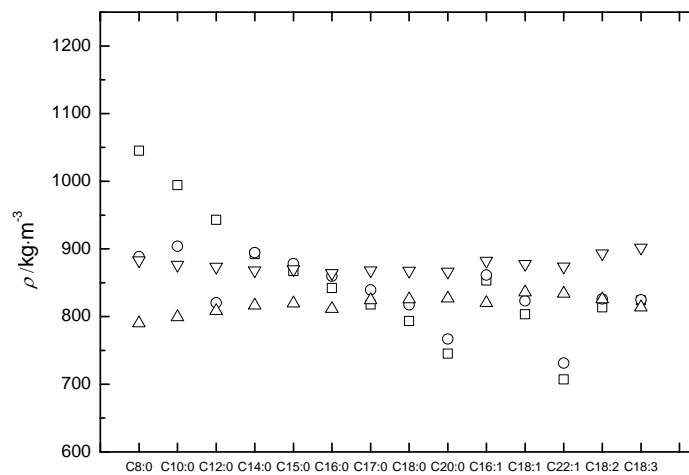

Figura 2.6 Densidades de ésteres etílicos puros calculadas con los Paquetes 1 a 3 y datos experimentales de Lapuerta y cols [77]. □, Paquete 1; ○, Paquete 2; △, Paquete 3; ▽, Experimental

Los valores de ARD (Paquete 1= 10,09 %, Paquete 2= 8,34 %, Paquete 3= 5,81 %) son mayores que en el caso de los ésteres metílicos indicando la necesidad de un mayor número de datos experimentales para comprobar la validez del modelo.

- Densidad de biodiésel de metanol y etanol

Siguiendo el esquema mostrado en la Figura 2.3 se han calculado las densidades de las diferentes muestras de biodiésel producidas a partir de metanol (BM) y etanol (BE). Estos resultados se han comparado con datos experimentales para ambos tipos, siendo los datos para biodiésel de metanol mucho más abundantes que para etanol.

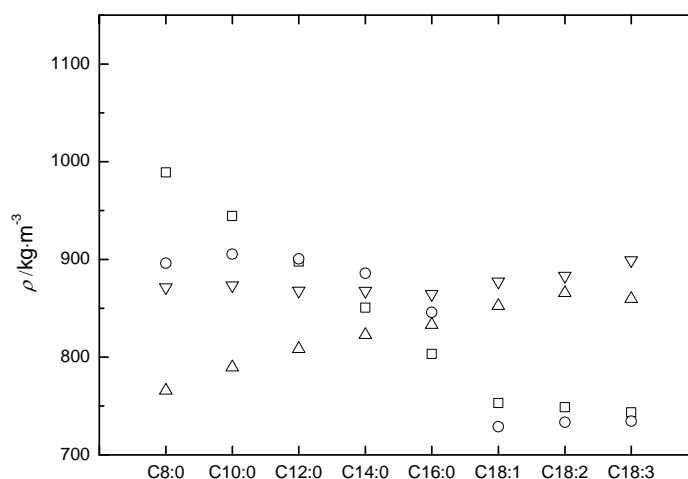
En el caso del biodiésel de metanol, el Paquete 2 muestra la menor ARD mientras que los Paquetes 1 y 3 sobreestiman y subestiman respectivamente los valores de densidad. Como resultado, estos paquetes consideran fuera del rango de la norma (EN 14214) algunos tipos de biodiésel que sí la cumplen. Para el Paquete 2 tan sólo algunas de las muestras tienen errores superiores al 1 %; como el de camelina, borraja, cáñamo, hígado, ricino, coco 1 y aceite de cocina usado.

Aunque en la bibliografía pueden encontrarse un buen número de artículos relacionados con la producción de biodiésel a partir de etanol, tan sólo algunos de ellos reportan un perfil de composición detallado y valores experimentales de densidad [90, 140].

Los datos encontrados fueron usados en la evaluación de los paquetes de cálculo. Los Paquetes 1 y 2 cometen menos error que el Paquete 3 excepto para el biodiésel producido a partir de aceite de coco, donde el Paquete 1 muestra un error mayor que los demás. En base a la comparación realizada, es posible decir que cualquiera de los Paquetes 1 y 2 pueden ser usados para el cálculo de la densidad del biodiésel producido con etanol, no obstante, es preciso un mayor número de datos experimentales que permitan asegurar la capacidad predictiva de estos modelos.

2.3.5. Modelado de la densidad del biodiésel

El trabajo desarrollado con los modelos de propiedades críticas encuentra continuación en esta sección en la que se resume el estudio llevado a cabo para el modelado de la densidad del biodiésel, obtenido tanto a partir de metanol como de etanol. En este trabajo, que ha dado lugar a una publicación, concurren a partes iguales la intensa experimentación realizada y el modelado de propiedades críticas. El resultado es un estudio en profundidad del estado del arte y una comparación de modelos de densidad. A continuación se presentan los puntos principales y los resultados que sintetizan el trabajo realizado:

- Banco de datos de densidad

A pesar de que pueden encontrarse un buen número de artículos en los que se aborda a densidad del biodiésel, hay pocos en los que se haya determinado la composición en ésteres de modo detallado. Para este estudio se han seleccionado los trabajos en los que la composición del biodiésel incluía al menos siete ésteres alquílicos.

Además, el laboratorio se prepararon veintiuna muestras, de BM y BE respectivamente, de distinta composición, que puede encontrarse en las Tablas 2.6 y 2.7, así como en forma electrónica en la página web www.pangaea.de (doi:10.1594/PANGAEA.783283). Estas muestras fueron generadas con el objetivo de

cubrir el mayor rango posible de composiciones diferentes. Las materias primas usadas y el método experimental fueron descritos en la sección *2.2.1 Producción de biodiésel*.

Tabla 2.6 Perfil de ésteres metílicos (% peso) de biodiésel producido a partir de metanol (BM1-BM21).

Biodiésel	C14:0	C15:0	C16:0	C17:0	C18:0	C20:0	C22:0	C16:1	C18:1	C20:1	C18:2	C18:3	Total
BM1			6,135		3,681	0,241	0,664	0,079	26,642	0,144	61,896	0,220	99,77
BM2			10,579		3,181	0,388	0,106	0,772	77,419	0,238	6,191	0,685	99,58
BM3			8,410		3,439	0,314	0,387	0,444	51,724	0,189	34,313	0,404	99,67
BM4			4,516		1,611	0,580	0,300	0,239	63,361	1,105	19,297	8,734	99,79
BM5			4,718		1,848	0,518	0,311	0,180	69,986	0,693	16,915	4,505	99,73
BM6			5,297		2,657	0,410	0,489	0,166	44,718	0,623	40,966	4,459	99,84
BM7			5,076		2,028	0,460	0,322	0,140	76,589	0,291	14,420	0,202	99,60
BM8			8,410		3,439	0,314	0,387	0,444	51,724	0,189	34,313	0,404	99,67
BM9			10,044		2,963	0,311	0,218	0,080	24,598	0,000	55,184	6,129	99,59
BM10			4,464		1,544	0,566	0,288	0,220	62,088	1,272	19,319	9,739	99,55
BM11			11,013		1,771	0,403	0,133	0,157	30,266	0,231	55,088	0,772	99,87
BM12	0,664	0,023	18,720	0,216	11,141	0,276	0,045	1,350	56,446	0,417	9,541	0,724	99,56
BM13	0,764	0,029	19,024	0,224	11,553	0,253	0,179	1,368	44,104	0,425	20,975	0,608	99,51
BM14	1,360	0,050	26,410	0,404	18,756	0,181		1,900	35,557	0,618	12,843	1,040	99,12
BM15	0,672	0,029	23,948	0,101	10,994	0,069		3,224	50,969	0,391	8,945	0,380	99,72
BM16	1,179	0,042	25,783	0,322	16,724	0,143		2,251	39,736	0,571	11,689	0,839	99,28
BM17	1,563	0,255	19,101	0,778	15,191	0,229	0,186	1,378	43,918	0,208	16,402	0,286	99,50
BM18	2,168	0,265	26,833	0,950	22,344	0,146		2,042	35,717	0,421	7,623	0,569	99,08
BM19	1,414	0,036	26,885	0,294	18,191	0,183		2,335	38,843	0,634	9,685	0,658	99,16
BM20	1,468	0,226	19,073	0,796	14,852	0,252	0,045	1,463	56,604	0,199	4,194	0,334	99,51
BM21	4,417	0,618	28,080	1,456	25,088	0,138		1,936	34,104	0,139	2,467	0,141	98,58

Tabla 2.7. Perfil de ésteres etílicos (% peso) del biodiésel producido a partir de etanol (BE1-BE21).

Biodiésel	C10:0	C12:0	C14:0	C15:0	C16:0	C17:0	C18:0	C20:0	C22:0	C24:0	C16:1	C17:1	C18:1	C20:1	C22:1	C24:1	C18:2	C18:3	Total
BE1	0,038	0,042	0,744	0,028	18,959	0,224	11,473	0,228	0,145		1,312	0,133	44,085	0,403			21,378	0,623	99,81
BE2	0,082	0,083	1,412	0,032	26,798	0,284	17,928	0,173			2,379	0,196	39,257	0,616			9,677	0,640	99,56
BE3	0,040	0,039	0,695	0,013	19,044	0,160	10,742	0,262	0,041		1,579	0,135	58,260	0,424			7,809	0,566	99,81
BE4	0,070	0,077	1,346	0,046	26,445	0,390	18,558	0,165			1,959	0,191	36,038	0,597			12,617	1,011	99,51
BE5	0,171	0,339	4,417	0,601	27,996	1,418	24,837	0,129			1,937	0,309	34,389	0,132			2,644	0,143	99,46
BE6	0,058	0,072	2,220	0,262	27,005	0,928	22,267	0,146			2,053	0,292	35,784	0,393			7,473	0,540	99,49
BE7	0,024	0,033	1,583	0,243	19,140	0,762	15,226	0,211	0,155		1,391	0,227	44,006	0,199			16,358	0,230	99,79
BE8	0,020	0,029	1,482	0,226	19,111	0,785	14,685	0,239	0,051		1,469	0,219	56,943	0,200			4,037	0,308	99,80
BE9			0,065		6,120		3,765	0,246	0,695	0,197	0,080		26,467	0,141			62,157	0,068	100,00
BE10					10,757		3,061	0,381	0,106	0,245	0,760		77,570	0,234			6,300	0,585	100,00
BE11			0,051		4,548		1,637	0,581	0,300	0,097	0,247		63,140	1,090		0,113	19,449	8,747	100,00
BE12			0,075		5,100		2,119	0,459	0,321	0,150	0,141		76,747	0,286	0,076	0,169	14,226	0,130	100,00
BE13			0,075		10,575		2,956	0,327	0,407	0,123	0,091		25,198	0,217			54,051	5,980	100,00
BE14			0,032		11,013		1,771	0,403	0,133	0,133	0,157		30,266	0,231			55,088	0,772	100,00
BE15			0,048		4,464		1,544	0,566	0,288	0,082	0,220		62,088	1,272	0,255	0,115	19,319	9,739	100,00
BE16			0,026		7,918		1,841	0,915	2,704	1,671	0,096		56,153	2,024	0,228		26,199	0,224	100,00
BE17			0,042		8,483		3,495	0,313	0,388	0,195	0,462		51,979	0,190		0,138	33,983	0,332	100,00
BE18			0,031		8,791	0,037	3,565	0,344	0,358	0,127	0,425	0,047	59,213	0,192		0,093	26,474	0,303	100,00
BE19			0,049		8,131	0,068	2,545	0,464	0,374		0,197	0,039	46,202	0,729		0,097	34,294	6,811	100,00
BE20			0,026		6,540	0,063	1,774	0,783	1,682		0,162	0,042	60,147	1,836	0,233	0,857	21,268	4,587	100,00
BE21			0,028		9,823	0,039	3,336	0,340	0,332	0,098	0,352	0,040	48,049	0,218		0,102	36,822	0,420	100,00

En el caso de los BM, para comprobar los modelos, se usaron once datos de las referencias [43, 52, 142-145], 25 datos del trabajo de Sanford y cols. [92] y 10 de Pratas y cols. [146], aunque no se muestran en las figuras siguientes por brevedad. Los datos para biodiésel producido a partir de etanol son más escasos, y únicamente se encontraron 6 datos de densidad con un perfil completo de ésteres [90, 147], que sí se muestran en las figuras correspondientes.

- Cálculo de la densidad del biodiésel producido a partir de metanol

Se eligieron dos modelos de cálculo diferente, el de Rackett-Soave (usando los paquetes 1 a 3 mostrados en la sección anterior), que es completamente teórico, y el modelo empírico propuesto por Lapuerta y cols. [77].

En la Figura 2.7 se muestran los valores experimentales de densidad de los distintos tipos de biodiésel producidos en nuestro laboratorio (codificados del 1 al 21) así como algunos datos obtenidos de la bibliografía (código 22: [142], 23: [143], 24 y 25: [52], 26-29: [144], 30: [145], 31 y 32: [43]).

Los modelos que muestran un menor ARD son el Paquete 2 y la correlación de Lapuerta y cols., que pueden usarse para estimar la densidad del biodiésel con un buen grado de exactitud.

Aunque no se muestran en la Figura 2.7, los datos de Sanford y cols. [92] y Pratas y cols. [146] junto con los que sí aparecen, se usaron para comparar los métodos de cálculo usados, lo que representa un total de 67 tipos de biodiésel de distintas procedencias. Los ARD obtenidos para el conjunto completo de datos son: Paquete 1= 2,08 %, Paquete 2= 0,76 %, Paquete 3= 1,78 %, y modelo LP= 0,66 %. Se observa que el modelo propuesto por Lapuerta y cols. [77] ofrece muy buenos resultados para todos los tipos de biodiésel, salvo para el obtenido a partir de aceite de ricino.



Figura 2.7 Valores experimentales y calculados de densidad de biodiésel producido con metanol. ■ experimental, ○ Paquete 1, △ Paquete 2, ◇ Paquete 3, ☆ LP.

Con el fin de mejorar la exactitud de los mejores modelos (Paquete 2 y LP), a partir de los datos experimentales obtenidos en este trabajo y de los datos bibliográficos, se han realizado algunas modificaciones que se comentan a continuación.

En base a la ecuación propuesta por Lapuerta y cols. [77], se ajustó la ecuación (Ec. 18) para la densidad de los BM usando los 21 datos obtenidos y 32 datos de Sanford y cols. [92]. Las constantes A a D son parámetros ajustables, y los parámetros UD y LC son el grado de insaturación y la longitud de cadena del biodiésel respectivamente. Como variable objetivo se usó el ARD, minimizándolo con mediante la herramienta Solver de Excel v2010.

$$\rho = A + \frac{B \cdot UD + C}{D + LC} \tag{Ec. 18}$$

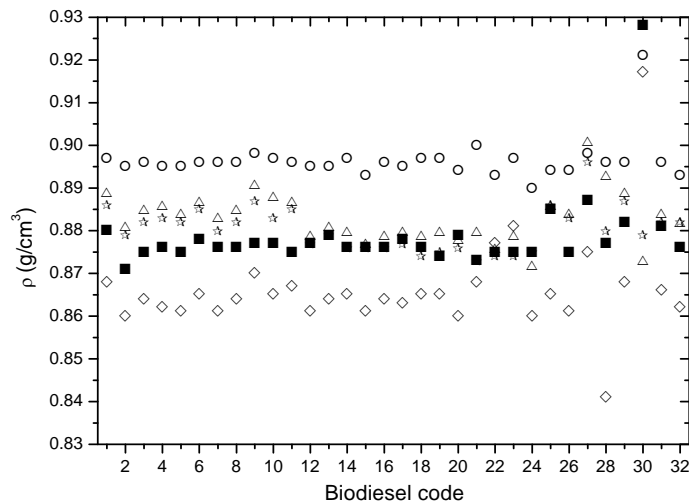
Los valores obtenidos tras la minimización son: $A = 0,84913$, $B = 0,21483$, $C = 0,35162$, $D = 1,07833$. El ARD obtenido es de 0,40 %. Esta mejora mínima, obtenida al incluir más datos en el proceso de ajuste, indica la bondad del modelo LP. En cualquier caso la densidad del biodiésel de ricino no se estima bien, lo que indica que existe otro

parámetro que influye en esta propiedad y que no está recogida en el modelo, debido probablemente al grupo OH presente.

Modificar el Paquete 2 implica una estrategia diferente debido a su naturaleza teórica. El procedimiento de modificación, que incluye la optimización de los parámetros de cálculo del factor acéntrico mediante regresión por cuadrados parciales mínimos, se encuentra descrito en el artículo V y se omite en este resumen por claridad. El resultado de la optimización es la Ecuación 19 para el cálculo del factor acéntrico que se usó posteriormente para el cálculo del factor Z_{Ra} y, finalmente, la densidad de los diferentes tipos de biodiésel.

$$\omega_m = 3.66098 + 0.00415 \cdot T_{cm} - 0.19871 \cdot P_{cm} - 0.01203 \cdot MW_m \quad (\text{Ec. 19})$$

El ARD (%) obtenido con este método modificado fue de 0,33, mostrando una mejora significativa sobre el método sin modificar.

- Cálculo de la densidad del biodiésel producido a partir de etanol

Al igual que para el caso del metanol, el Paquete 2 y el método de Lapuerta y cols. muestran el ARD más bajo, 1,19 % and 0,60 % respectivamente. Los Paquetes 1 y 3 siguen la misma tendencia que en el caso del biodiésel de metanol, sobre y subestimando respectivamente la densidad del biodiésel. En la Figura 6 se muestra el RD (%) para cada uno de los tipos de biodiésel. Con la excepción del biodiésel de semilla de palma, el RD para el Paquete 2 está por debajo del 2,4 %, mostrando una buena precisión. El método LP muestra los mejores resultados, tanto para los datos de bibliografía como para los producidos en nuestro laboratorio.

Siguiendo el mismo procedimiento que en el caso del biodiésel de metanol, se calculó una correlación para el factor acéntrico (Ecuación 20), usando los datos disponibles, obteniendo un coeficiente de regresión R^2 de 0,933.

$$\omega_m = 5.47113 + 0.00972 \cdot T_{cm} - 0.3485 \cdot P_{cm} - 0.02675 \cdot MW_m \quad (\text{Ec. 20})$$

Usando los métodos elegidos para el Paquete 2 y la nueva correlación para el factor acéntrico se obtiene un ARD de 0,26 %, lo que mejora el procedimiento no modificado. En cualquier caso, se necesitan más datos experimentales de BE con el fin de seguir mejorando los modelos para futuras investigaciones.

2.3.6. Modelado de la viscosidad cinemática del biodiésel

Relacionada con el flujo del biocombustible y su atomización dentro del motor, la viscosidad cinemática es una propiedad difícilmente modelable desde un punto de vista teórico, debido a su propia naturaleza. Así, Reid y cols. [84] recomiendan el uso de modelos empíricos para la determinación de la viscosidad de cualquier líquido saturado. Aunque es posible encontrar en la literatura aproximaciones teóricas al modelado de la viscosidad [87, 148, 149], los últimos modelos tratan de afrontar el problema desde una perspectiva empírica.

Además, aunque la propiedad que está normalizada es la viscosidad cinemática, la mayoría de modelos encontrados en la bibliografía consultada son modelos para la viscosidad dinámica y para biodiésel producido usando metanol como alcohol. Debido a esto, en esta tesis se ha planteado una revisión de los modelos existentes y una comparación de los mismos, mejorando o generando nuevos modelos en su caso.

En concreto, en este trabajo se lleva a cabo una evaluación de dos modelos de cálculo de la viscosidad cinemática de ésteres metílicos puros (Ramírez-Verduzco y cols. [150] y Krisnangkura y cols. [97]) usando datos bibliográficos [151]. Además, se ha propuesto un nuevo modelo basado en datos bibliográficos [152] para el caso de los ésteres etílicos.

En lo referente a biodiésel producido a partir de metanol, se ha propuesto un nuevo modelo que ha sido, además, comparado con el modelo de Ramírez-Verduzco y cols. y validado. Basando en datos experimentales propios, se ha generado un modelo para la

predicción de la viscosidad cinemática de biodiésels producidos usando etanol como alcohol.

A continuación se presentan los puntos principales y los resultados que sintetizan el trabajo realizado.

- Generación de una base de datos de viscosidad cinemática

Tal y como se ha expuesto en el anterior apartado, poder disponer de un conjunto de datos adecuado en cuanto a descripción de la composición es de vital importancia a la hora de afrontar el modelado de cualquier propiedad. En este trabajo se han compilado dos conjuntos de datos, experimentales de producción propia y de origen bibliográfico. En caso de la viscosidad, al igual que ocurrió con la densidad, el criterio para la selección de datos bibliográficos fue que las composiciones estuvieran descritas con detalle y los datos fueran de viscosidad cinemática a 40 °C, tal y como se establece en la norma EN 14214. En el caso de biodiésels basados en metanol esta tarea fue claramente más sencilla que en el caso de los basados en etanol debido al escaso número de datos publicados.

En el caso de biodiésels basados en metanol, se han usado un total de 49 puntos experimentales obtenidos de la bibliografía [80, 92, 150, 153-155] (combinación de valores de viscosidad cinemática y perfiles de composición detallados). Para los biodiésels basados en etanol, únicamente se encontraron 4 puntos [48, 135, 136, 156]. Los perfiles de composición de este conjunto de datos bibliográficos no se muestran aquí por brevedad.

Combinando la mayor cantidad de materias primas posibles, se realizaron mezclas capaces de cubrir un gran rango de diferentes composiciones y se generaron 21 muestras de cada tipo de biodiésel (basado en metanol y etanol). Las composiciones de estos biodiésels se mostraron en la anterior sección, Tablas 2.6 y 2.7.

- Viscosidad cinemática de ésteres alquílicos puros

La viscosidad cinemática de los ésteres metílicos se calcula en este trabajo usando las ecuaciones de Ramírez-Verduzco y cols. [150] (Ec. 21) y Krisnangkura y cols. [97] (Ecs. 22- 27). Los datos experimentales reportados por Knothe y Steidley [151] (ver Tabla 2.8) se usaron para comparar la precisión de los modelos.

$$\ln(v_i) = -12.503 + 2.496 \cdot \ln(MW_i) - 0.178 \cdot N_i \quad (\text{Ec. 21})$$

$$\ln(v_i)_{C6:0-C12:0} = -2.915 - 0.158 \cdot z + \frac{492.12}{T} + \frac{108.35 \cdot z}{T} \quad (\text{Ec. 22})$$

$$\ln(v_i)_{C12:0-C18:0} = -2.177 - 0.202 \cdot z + \frac{403.66}{T} + \frac{109.77 \cdot z}{T} \quad (\text{Ec. 23})$$

$$\ln(v_i)_{C18:1} = -5.03 + \frac{2051.5}{T} \quad (\text{Ec. 24})$$

$$\ln(v_i)_{C18:2} = -4.51 + \frac{1822.5}{T} \quad (\text{Ec. 25})$$

$$\ln(v_i)_{C18:3} = -4.18 + \frac{1685.5}{T} \quad (\text{Ec. 26})$$

$$\ln(v_i)_{C22:1} = -5.42 + \frac{2326.2}{T} \quad (\text{Ec. 27})$$

donde v_i es la viscosidad cinemática del componente i (mm^2/s), MW_i es el peso molecular de i (g/mol), N_i es el número de dobles enlaces en la molécula, T es la temperatura (K) y z es el número de átomos de carbono.

Como puede observarse, el modelo de Ramírez-Verduzco y cols. para los ésteres metílicos individuales ajusta los datos de forma satisfactoria y permite el cálculo de todas las viscosidades cinemáticas a excepción de la viscosidad cinemática del metil ricinoleato. Este compuesto, mayoritario en el biodiésel procedente del aceite de ricino, tiene la peculiaridad estructural en la molécula de un grupo OH que la confiere la posibilidad de formar un mayor número de puentes de hidrógeno aumentando así su viscosidad cinemática. La ecuación de Ramírez-Verduzco y cols. (Ec. 21) no logra representar satisfactoriamente este efecto.

Tabla 2.8 Viscosidad cinemática de ésteres metílicos puros calculada con las ecuaciones de Ramírez-Verduzco y cols. y Krisnangkura y cols. y datos experimentales de Knothe y Steidley

FAMES	MW/g · mol ⁻¹	Ramírez-Verduzco y cols.	Krisnangkura y cols.	Knothe & Steidley [151]
		v/mm ² ·s ⁻¹	v/mm ² ·s ⁻¹	v/mm ² ·s ⁻¹
C8:0	158,24	1,15	1,17	1,19
C10:0	186,29	1,72	1,71	1,72
C12:0	214,34	2,45	2,49	2,43
C14:0	242,40	3,33	3,29	3,30
C15:0	256,42	3,83	3,82	3,84
C16:0	270,45	4,37	4,43	4,38
C17:0	284,48	4,96	5,14	5,03
C18:0	298,50	5,59	5,96	5,85
C20:0	326,56	7,00	8,03	7,40
C22:0	354,61	8,59	10,80	9,31
C24:0	382,66	10,39	14,54	11,53
C16:1	268,43	3,59	n.c.	3,67
C17:1	282,46	4,08	n.c.	4,09
C18:1	296,49	4,60	4,58	4,51
C18:1 OH	312,49	5,25	n.c.	15,44
C20:1	324,54	5,77	n.c.	5,77
C22:1	352,59	7,09	7,45	7,33
C24:1	380,65	8,58	n.c.	8,87
C18:2	294,47	3,79	3,71	3,65
C18:3	292,45	3,11	3,33	3,14

n.c.: no calculado por la falta de una ecuación adecuada.

Debido a la falta de una ecuación para la estimación de la viscosidad cinemática de ésteres etílicos puros en la bibliografía, se ha llevado a cabo el ajuste de un nuevo modelo en base a los datos experimentales reportados por Knothe y Steidley [152]. La ecuación, basada en la ecuación de Ramírez-Verduzco y cols. [150] (Ec. 21), es la Ecuación 28;

$$\ln(v_i) = -12.998 + 2.57 \cdot \ln(MW_i) - 0.159 \cdot N_i \quad (\text{Ec. 28})$$

Las constantes de esta ecuación fueron ajustadas mediante regresión no lineal (R²= 0,995) y los resultados se muestran en la Tabla 2.9

Comparando los datos de las Tablas 2.8 y 2.9 puede observarse que la viscosidad cinemática de los ésteres etílicos es ligeramente superior a la de los ésteres metílicos,

siguiendo una tendencia similar bien representada por las Ecuaciones 21 y 28 lo que demuestra que la viscosidad cinemática puede ser apropiadamente correlacionada con el peso molecular y el número de insaturaciones de las moléculas.

Tabla 2.9 Viscosidades cinemáticas de ésteres etílicos puros calculadas con la ecuación 28 y los datos experimentales de Knothe y Steidley

FAEEs	Ecuación 28	Knothe and Steidley [152]
MW/g · mol ⁻¹	v/mm ² ·s ⁻¹	v/mm ² ·s ⁻¹
C8:0	172,26	1,27
C10:0	200,32	1,87
C12:0	228,37	2,62
C14:0	256,42	3,52
C15:0	270,45	4,04
C16:0	284,48	4,60
C17:0	298,50	5,21
C18:0	312,53	5,86
C20:0	340,58	7,31
C22:0	368,63	8,96
C24:0	396,69	10,82
C16:1	282,46	3,85
C17:1	296,49	4,37
C18:1	310,51	4,92
C18:1 OH	340,54	nc
C20:1	338,57	6,14
C22:1	366,62	7,53
C24:1	394,67	9,11
C18:2	308,50	4,12
C18:3	306,48	3,46

nd: no disponible; n.c.: no calculado por falta de una ecuación adecuada

- Viscosidad cinemática de biodiésel basado en metanol

Algunos autores [152, 157] han reportado una relación de la viscosidad cinemática con la longitud de la cadena de carbonos, el número de dobles enlaces y la composición de la mezcla. De esta forma, la consideración de estas variables en los modelos puede ayudar a representar de forma precisa la relación entre la viscosidad y la composición.

Partiendo de la base de que la composición del biodiésel determina su viscosidad, se calcularon diversos parámetros medios a partir de la composición de la base de datos de

que se disponía, con el fin de encontrar cuáles de ellos están mejor correlacionados con la viscosidad.

Los parámetros que se calcularon a partir de la composición del biodiésel fueron:

- MW : peso molecular medio del biodiésel, calculado como $\sum y_i \cdot MW_i$, correspondiendo el subíndice i a los distintos ésteres del biodiésel e y la fracción másica de cada uno de ellos.
- $Ln(MW)$: logaritmo neperiano del peso molecular medio, calculado como se indica en el punto anterior.
- LC : número medio de carbonos en el biodiésel, calculado como $\sum y_i \cdot LC_i$, donde LC_i es el número de carbonos en cada uno de los i ésteres del biodiésel.
- $Ln(LC)$: logaritmo neperiano del número medio de carbonos del biodiésel.
- UD : número medio de dobles enlaces, calculado como $\sum y_i \cdot UD_i$, donde UD_i es el número de dobles enlaces de cada éster.
- *Mono*: es la fracción en peso de ésteres con un doble enlace en el biodiésel.
- *Poly*: es la fracción en peso de ésteres poli-insaturados.
- *Sat*: es la fracción en peso de ésteres saturados.
- *Lig*: es la fracción en peso de ésteres ligeros (C8:0 a C14:0).

La forma más sencilla que existe de correlación es la lineal. Sin embargo, tal y como se comprobó a partir de los datos disponibles, se obtiene un coeficiente de correlación mayor a partir del logaritmo de la viscosidad. En los modelos previamente publicados también se correlaciona el logaritmo de la viscosidad, como puede verse en las ecuaciones anteriores.

Con el fin de encontrar los conjuntos de parámetros con lo que se obtiene la mejor correlación, se realizó un ANOVA, con el software Design Expert[®], con el fin de obtener los parámetros cuya influencia era estadísticamente significativa en la viscosidad. Una vez encontrado el conjunto de parámetros con los que se obtuvo una

mayor regresión, se ajustaron los parámetros con la ecuación no linealizada, mediante la función Solver de Excel®.

Con el fin de comparar el modelo obtenido con el ajuste propuesto por Ramírez-Verduzco y cols. [150] (Ec. 29) se ajustó del mismo modo el conjunto de datos del que se disponía a la ecuación propuesta por estos autores.

$$\ln(v) = A + B \cdot \ln(MW) + C \cdot UD \quad (\text{Ec. 29})$$

Cuando dos modelos tienen el mismo número de parámetros, es evidente que es más adecuado aquel con el que se obtenga el mayor coeficiente de regresión. Sin embargo, cuando un modelo tiene más parámetros, el hecho de que ajuste mejor no quiere decir que sea más adecuado. Para ello es necesario realizar un test F, comparando la varianza residual de cada uno de los dos modelos. El modelo que mostró el coeficiente de regresión más elevado fue el siguiente:

$$v(\text{mm}^2 \cdot \text{s}^{-1}) = e^{A+B \cdot MW + C \cdot \ln(LC) + D \cdot UD} \quad (\text{Ec. 30})$$

Una vez realizado el ajuste de la ecuación, no linealizada, mediante Solver®, se encontraron los valores de los parámetros que se muestran en la Tabla 2.10. Tal y como se ha comentado, se realizó el ajuste de los 70 datos disponibles al modelo propuesto por Ramírez-Verduzco y cols. [150], mostrándose los parámetros también en la Tabla 2.7. Se puede observar como los valores de las constantes obtenidas por Ramírez-Verduzco y cols. están dentro del intervalo de confianza (95 %) obtenidos a partir de los 70 datos experimentales.

Tabla 2.10. Parámetros obtenidos en los modelos de Ramírez-Verduzco y propio

	-	MW	Ln(MW)	Ln(LC)	UD	R ² /R ² _{adj}
Ramírez-Verduzco	-11,81 ±		2,37 ±		-0,15 ±	0,75/0,74
	2,21		0,39		0,03	
Este trabajo	-14,51 ±	-0,03 ±		8,88	-0,21 ±	0.81/0.80
	5,49	0,02		±3,52	0,03	

En la Tabla 2.10 se muestra también el coeficiente de regresión R^2 , calculado a partir de la Ecuación 31, y R^2_{adj} , coeficiente de regresión ajustado a los grados de libertad del modelo, que se calcula con la Ecuación 32.

$$R^2 = 1 - \frac{SSR}{SST}; SSR = \sum_{i=1}^n (v_i^{experimental} - v_i^{calculada})^2; SST = \sum_{i=1}^n (v_i^{experimental} - \bar{v}_i)^2 \quad (\text{Ec. 31})$$

$$R^2_{adj} = 1 - \left(\frac{n-1}{n-p} \right) \frac{SSR}{SST} \quad (\text{Ec. 32})$$

siendo n el número de datos experimentales, 70 en este estudio, y p el número de parámetros de cada modelo.

Aunque el coeficiente de regresión que se obtiene en el nuevo modelo propuesto es mayor que el que se obtiene usando el modelo de Ramírez-Verduzco y cols., la evidencia de que un modelo es superior a otro se obtiene mediante un test basado en la distribución F de Fischer, que sirve para comparar varianzas. La ecuación usada se muestra en la Ecuación 33.

$$F_{calculada} = \frac{\frac{SSR_A - SSR_B}{p_B - p_A}}{\frac{SSR_A}{n - p_A}} = \frac{SSR_A - SSR_B}{p_B - p_A} \bigg/ \frac{SSR_A}{n - p_A} \quad (\text{Ec. 33})$$

Siendo el subíndice A el referido al modelo con menor número de parámetros de ajuste (p_A) y el subíndice B al modelo con mayor número de parámetros.

El valor de $F_{calculada}$ se compara con el valor tabulado de la función F para un determinado nivel de significación, con $p_B - p_A$ grados de libertad en el numerador y $n - p_A$ grados de libertad en el denominador, $F(\alpha, p_B - p_A, n - p_A)$. En el ajuste realizado se obtiene un valor de $F_{calculada}$ de 16,00, y $F_{tabulada} = 3,98$ para un nivel de significación $\alpha = 0,05$ (5%), por lo tanto como $F_{calculada} > F_{tabulada}$, se puede establecer, con una confianza del 95% que el modelo propuesto en este trabajo ajusta mejor a los datos experimentales que el obtenido al usar la ecuación de Ramírez-Verduzco y cols.

Hay que destacar que este modelo está bien ajustado, y responde bien a los datos experimentales obtenidos, prueba de ello es que los valores de los parámetros de ajuste obtenidos son equivalentes a los obtenidos en el trabajo de Ramírez-Verduzco y cols. a partir de distintos datos experimentales.

Alternativamente, se puede calcular, a partir de $F_{\text{calculada}}$ y la distribución de la función F , el denominado p -value, es de $5,34 \cdot 10^{-8}$, mucho menor al nivel de significación del 5 %, lo que también da idea de la mejora conseguida. En la Figura 2.8 se muestra el ajuste de ambos modelos probados en este trabajo.



Figura 2.8. Viscosidad de BM experimental vs calculada. ■ Ramírez-Verduzco, ● Ecuación 30

- Viscosidad cinemática de biodiésel basado en etanol

En el caso del biodiésel producido a partir de etanol el procedimiento de estudio ha sido idéntico al del metanol. En este caso se parte de un menor número de datos, pues además de los 21 datos de composición y viscosidad producidos en este trabajo, únicamente se han encontrado cinco datos más en bibliografía donde se disponga, además de la viscosidad dinámica a 40 °C, del perfil de ésteres detallado [48, 135, 136, 156].

En primer lugar se comprobó la viscosidad del biodiésel producido con etanol, no se correlacionaba con los mismos parámetros que el biodiésel de metanol. Aunque esto puede deberse a que el número de datos que se tiene para es menor, los 26 datos iniciales están correlacionados con un elevado número de parámetros y sus interacciones, ecuación 34:

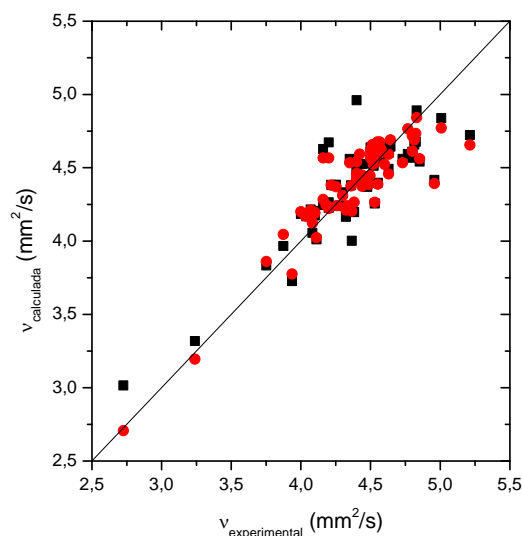
$$\begin{aligned} \ln(\nu) = & 368.870 - 84.916 \cdot \ln(MW) + 21.761 \cdot LC - 60.061 \cdot UD \\ & + 116.898 \cdot sat - 61.086 \cdot mono - 29.546 \cdot lig + 4.966 \cdot \ln(MW) \cdot LC \\ & + 3.376 \cdot LC \cdot UD + 6.562 \cdot LC \cdot sat \\ & + 3.423 \cdot LC \cdot mono + 1.850 \cdot LC \cdot lig \end{aligned} \quad (\text{Ec. 34})$$

Además de ser un número muy elevado de parámetros, se comprobó, mediante el método propuesto por Cook [158], que algunos de los valores experimentales obtenidos en la bibliografía resultan anómalos, por lo que se decidió no tener en cuenta ninguno de esos valores y hacer el modelado únicamente con los datos obtenidos en este trabajo.

Por ello se volvió a hacer el análisis de regresión únicamente con los 21 datos producidos para este trabajo, encontrándose tendencias distintas en la regresión. A continuación se muestran las ecuaciones obtenidas con la mayor regresión, una vez hecho el ANOVA y, en su caso, el ajuste de la ecuación no lineal mediante la herramienta de Solver de Excel, así como los coeficientes de regresión obtenidos en la Tabla 2.11.

$$\nu = -6.273 + 0.039 \cdot MW - 0.942 \cdot UD \quad (\text{Ec. 35})$$

$$\nu = +5.122 - 1.085 \cdot poly \quad (\text{Ec. 36})$$

$$\ln(\nu) = -12.953 - 0.198 \cdot UD + 2.574 \cdot \ln(MW) \quad (\text{Ec. 37})$$

$$\ln(\nu) = -0.794 + 8.42 \cdot 10^{-3} \cdot MW - 0.198 \cdot UD \quad (\text{Ec. 38})$$

$$\ln(\nu) = 1.635 - 0.227 \cdot poly \quad (\text{Ec. 39})$$

Tabla 2.11. Parámetros de regresión para las ecuaciones 37-41

Ecuación	R ²	R ² _{adj}
Ec. 35	0,896	0,885
Ec. 36	0,780	0,769
Ec. 37	0,896	0,885
Ec. 38	0,896	0,885
Ec. 39	0,781	0,770

A partir de los datos producidos se encuentra que se puede calcular la viscosidad de los BE producidos teniendo en cuenta el peso molecular medio y el número medio de dobles enlaces o únicamente la fracción másica de ésteres poli-insaturados, con unos coeficientes de regresión superiores a 0,75 en todos los casos.

En este caso, se trata de comparar modelos con 2 y 3 parámetros ajustables. De los dos modelos con dos parámetros ajustables, lineal y no lineal, ofrece una regresión ligeramente mayor el no lineal, que se toma como base para la comparación con el test F. En la Tabla 2.12, se muestra el resultado obtenido.

Tabla 2.12. Resultados de la comparación de modelos

Modelo	SSR	p	R ² _{adj}	F calculada	p-value
$\nu = A+B \cdot MW+C \cdot UD$ (Ec. 35)	0,103681	3	0,885921	10,562684	0,00401
$\ln(\nu) = A+B \cdot \ln(MW)+C \cdot UD$ (Ec. 37)	0,104354	3	0,885181	10,501458	0,00409
$\ln(\nu) = A+B \cdot MW+C \cdot UD$ (Ec. 38)	0,104247	3	0,885299	10,511196	0,00408
$\ln(\nu) = A+B \cdot \text{poli}$ (Ec. 39)	0,219726	2	0,770328		

El valor de F tabulado para un nivel de significación del 5%, 1 grado de libertad en el numerador (3 parámetros los modelos a comparar y dos el modelo que sirve de base para la comparación) y 21-3 grados de libertad en el denominador, es de 4, menor que la F calculada para cualquiera de los tres modelos que se comparan. El p-value es, para los tres muy similar también, del 0,4%. Los tres modelos presentan un ajuste muy similar, por lo que serían adecuados para predecir la viscosidad del biodiésel producido a partir de etanol, siendo el que menor SSR (y mayor R²) presenta el modelo lineal. En

cualquier caso queda patente que hace falta más información con el fin de discriminar entre los distintos modelos.

2.3.7. Líneas de investigación iniciadas y trabajos futuros

Durante el desarrollo de esta Tesis Doctoral se ha llevado a cabo una intensa experimentación que ha desvelado posibles líneas de investigación paralelas que han despertado el interés del grupo.

Así, se han realizado algunas pruebas encaminadas al tratamiento químico de la glicerina, sub-producto de la producción de biodiésel, para la producción de triacetinas y derivados de la misma que pueden ser considerados como productos de mayor valor añadido debido a sus múltiples posibilidades de uso. Una parte de esta investigación encuentra continuidad en la tesis doctoral que se ha iniciado en el grupo y que pretende ahondar en los conocimientos generados en la presente.

Otro interesante objeto de investigación es el uso de aditivos para la mejora de las propiedades físicas del biodiésel. El GPT se encuentra actualmente en proceso de investigación de varios aditivos de origen renovable que podrían ser usados por los productores de biodiésel para mejorar, entre otras, las propiedades de estabilidad a la oxidación y punto de obstrucción de filtro en frío.

Estas interesantes líneas de investigación confluyen con los trabajos futuros que se realizarán dentro del grupo, principalmente encaminados a continuar modelando otras propiedades del biodiésel como la estabilidad a la oxidación y las propiedades frías, y que tienen como objetivo seguir aumentando el conocimiento generado en esta primera Tesis Doctoral.

Capítulo 3:

Conclusiones

3. Conclusiones

Era la intención de esta memoria resumir en el formato seleccionado el trabajo realizado durante más de tres años, trabajo de revisión bibliográfica, de experimentación en el laboratorio y de intenso tratamiento de datos. La presente Tesis Doctoral marca el comienzo de una línea de investigación en el Grupo de Procesos Termoquímicos y, como todo inicio, se caracteriza por una impetuosa e intensa investigación que pretende abarcar y generar la mayor cantidad de conocimientos.

La gran mayoría de los resultados obtenidos durante este periodo ha sido publicada, de estas publicaciones se destacan a continuación las conclusiones principales que se han obtenido:

- La simulación de procesos es una herramienta que puede permitir la predicción de las propiedades finales del biodiésel, pero para ello es necesario implementar un número más alto de compuestos de lo que normalmente se encuentra en bibliografía.
- La predicción de distintas propiedades de interés del biodiésel, como las recogidas por las normas que debe cumplir para su comercialización, necesita de correlaciones que presenten mayor exactitud que las que hay publicadas, especialmente para algunas propiedades como son las propiedades frías, estabilidad a la oxidación y flash point.
- A la hora de simular las etapas de separación y limpieza del biodiésel, el modelo NRTL da resultados más próximos a la realidad que el UNIQUAC, sin embargo no se dispone de suficiente información experimental en estos momentos, como para validar este modelo en todas las condiciones.
- La etapa de lavado del biodiésel está fuertemente influenciada por la cantidad de agua de lavado así como por la temperatura de lavado, siendo además importante la interacción que se encuentra entre estos factores y el porcentaje de NaOH que se usa en la reacción de transesterificación.

- La comparación de los resultados experimentales de la etapa de lavado con los que se obtienen con el modelo NRTL muestra que algunas propiedades, como la acidez y el contenido en Na y metanol no son calculados correctamente por el modelo, siendo necesario mejorar los coeficientes de actividad que se usan.
- Es posible obtener biodiésel a partir de grasas animales mediante transesterificación directa usando metanol y etanol como alcoholes de cadena corta. El rendimiento obtenido usando etanol es menor que el que se obtiene con metanol, entre un 5 y un 10 % menor, lo que puede achacarse a una separación de la fase glicerina tras la transesterificación más difícil.
- El uso de etanol en la transesterificación influye en algunas de las propiedades finales del biodiésel, como es una mayor viscosidad y estabilidad a la oxidación. Dada la ya de por sí mayor viscosidad que presenta el biodiésel producido con grasa sobre el producido con aceite vegetal, al usar etanol, la viscosidad de alguna de las muestras producidas está por encima del límite aceptado por la norma EN 14214.
- Para el cálculo de algunas propiedades de cualquier compuesto, en este caso del biodiésel y sus distintos componentes, es necesario el cálculo de sus propiedades críticas. La aplicación de los métodos de contribución de grupos y de interacción de grupos respectivamente, y su comparación mediante la predicción de la densidad, una propiedad macroscópica fácilmente medible y para la que se encuentra un buen número de datos experimentales, indica que los métodos de interacción de grupos ofrecen un resultado más fiable.
- La densidad del biodiésel puede calcularse a partir de su composición por métodos teóricos y empíricos. De los modelos teóricos, el método de Rackett-Soave, con las propiedades críticas calculadas mediante métodos de interacción de grupos es el más adecuado. De los distintos modelos empíricos, el que muestra mayor precisión es el propuesto por Lapuerta y cols.

- Se ha modelado empíricamente la viscosidad del biodiésel producido con metanol y etanol, ampliando los intervalos de composición mediante el uso de aceites vegetales y grasas animales. Para el biodiésel producido con metanol se encontró una correlación empírica que incluye como parámetros el logaritmo neperiano del peso molecular medio del biodiésel, el logaritmo neperiano del número medio de carbonos y el grado de insaturación. Este modelo se comparó estadísticamente con el modelo propuesto por Ramírez-Verduzco y cols., siendo significativamente mejor. El biodiésel producido a partir de etanol, para el que se dispone de menos datos experimentales, está mejor correlacionado con la longitud media de la cadena de carbono del biodiésel y el grado de insaturación.

Capítulo 4: Bibliografía

4. Bibliografía

1. U.S. Energy Information Administration, *International Energy Outlook*, 2011. <<http://www.eia.gov/forecasts/ieo/pdf/0484%282011%29.pdf>> [Consulta: 13 de septiembre de 2012].
2. V. Makareviciene y P. Janulis, *Environmental effect of rapeseed oil ethyl ester*. *Renewable Energy*, 2003. **28**(15): p. 2395-2403.
3. W.R. Nitske y C.M. Wilson, *Rudolf Diesel, pioneer of the age of power*, ed. University of Oklahoma Press, 1965.
4. Infinita Renovables, *Biodiesel, impacto socioeconómico y medioambiental*, 2009. <http://www.infinitarenovables.es/download.php?file=Informe%20impacto%20Biodies el AC 22.pdf> [Consulta: 13 de septiembre de 2012].
5. Instituto para la Diversificación y Ahorro de la Energía (IDAE), *Manuales de energías renovables 7. Biocarburantes en el transporte*, 2008. http://www.idae.es/index.php/mod.documentos/mem.descarga?file=/documentos_1_0822_Biocarburantes_en_el_transporte_2008_503da5d6.pdf [Consulta: 13 de septiembre de 2012].
6. Global Data, *Global Biodiesel Market Analysis and Forecasts to 2020*, 2010.
7. EuroObserv'ER, *Baromètre Biocarburant*, 2011. < http://www.euroobserv-er.org/pdf/biofuels_2011.pdf> [Consulta: 13 de septiembre de 2012]
8. APPA Biocarburantes, *Balance Biocarburantes 2011*. 2012.
9. A. Demirbas, *Progress and recent trends in biodiesel fuels*. *Energy Conversion and Management*, 2009. **50**(1): p. 14-34.
10. M. Canakci y J. Van Gerpen, *Biodiesel production from oils and fats with high free fatty acids*. *Transactions of the Asae*, 2001. **44**(6): p. 1429-1436.
11. S. Lim y L.K. Teong, *Recent trends, opportunities and challenges of biodiesel in Malaysia: An overview*. *Renewable and Sustainable Energy Reviews*, 2010. **14**(3): p. 938-954.
12. S.P. Singh y D. Singh, *Biodiesel production through the use of different sources and characterization of oils and their esters as the substitute of diesel: A review*. *Renewable and Sustainable Energy Reviews*, 2010. **14**(1): p. 200-216.
13. A. Karmakar, S. Karmakar, y S. Mukherjee, *Properties of various plants and animals feedstocks for biodiesel production*. *Bioresource Technology*, 2010. **101**(19): p. 7201-7210.
14. A. Ajanovic, *Biofuels versus food production: Does biofuels production increase food prices?* *Energy*, 2011. **36**(4): p. 2070-2076.
15. Z. Zhang, L. Lohr, C. Escalante, y M. Wetzstein, *Food versus fuel: What do prices tell us?* *Energy Policy*, 2010. **38**(1): p. 445-451.
16. M. Balat, *Potential alternatives to edible oils for biodiesel production - A review of current work*. *Energy Conversion and Management*, 2011. **52**(2): p. 1479-1492.
17. C.C. Enweremadu y M.M. Mbarawa, *Technical aspects of production and analysis of biodiesel from used cooking oil--A review*. *Renewable and Sustainable Energy Reviews*, 2009. **13**(9): p. 2205-2224.
18. B. Freedman, R.O. Butterfield, y E.H. Pryde, *Transesterification Kinetics of Soybean Oil*. *Journal of the American Oil Chemists Society*, 1986. **63**(10): p. 1375-1380.
19. H. Nouredini y D. Zhu, *Kinetics of transesterification of soybean oil*. *Journal of the American Oil Chemists Society*, 1997. **74**(11): p. 1457-1463.
20. M. Mittelbach y B. Trathnigg, *Kinetics of Alkaline Catalyzed Methanolysis of Sunflower Oil*. *Fett Wissenschaft Technologie-Fat Science Technology*, 1990. **92**(4): p. 145-148.

21. S. Zheng, M. Kates, M.A. Dubé, y D.D. McLean, *Acid-catalyzed production of biodiesel from waste frying oil*. Biomass and Bioenergy, 2006. **30**(3): p. 267-272.
22. E. Lotero, Y.J. Liu, D.E. Lopez, K. Suwannakarn, D.A. Bruce, y J.G. Goodwin, *Synthesis of biodiesel via acid catalysis*. Industrial & Engineering Chemistry Research, 2005. **44**(14): p. 5353-5363.
23. N.-W. Li, M.-H. Zong, y H. Wu, *Highly efficient transformation of waste oil to biodiesel by immobilized lipase from *Penicillium expansum**. Process Biochemistry, 2009. **44**(6): p. 685-688.
24. N. Dizge, B. Keskinler, y A. Tanriseven, *Biodiesel production from canola oil by using lipase immobilized onto hydrophobic microporous styrene-divinylbenzene copolymer*. Biochemical Engineering Journal, 2009. **44**(2-3): p. 220-225.
25. M. Di Serio, M. Cozzolino, M. Giordano, R. Tesser, P. Patrono, y E. Santacesaria, *From homogeneous to heterogeneous catalysts in biodiesel production*. Industrial & Engineering Chemistry Research, 2007. **46**: p. 6379-6384.
26. M. Di Serio, M. Cozzolino, R. Tesser, P. Patrono, F. Pinzari, B. Bonelli, y E. Santacesaria, *Vanadyl phosphate catalysts in biodiesel production*. Applied Catalysis A: General, 2007. **320**: p. 1-7.
27. C. Lingfeng, X. Guomin, X. Bo, y T. Guangyuan, *Transesterification of Cottonseed Oil to Biodiesel by Using Heterogeneous Solid Basic Catalysts*. 2007. **21**(6): p. 3740-3743.
28. S. Yan, S.O. Salley, y K.Y. Simon Ng, *Simultaneous transesterification and esterification of unrefined or waste oils over ZnO-La₂O₃ catalysts*. Applied Catalysis A: General, 2009. **353**(2): p. 203-212.
29. G. Madras, C. Kolluru, y R. Kumar, *Synthesis of biodiesel in supercritical fluids*. Fuel, 2004. **83**(14-15): p. 2029-2033.
30. A. Demirbas, *Biodiesel production from vegetable oils via catalytic and non-catalytic supercritical methanol transesterification methods*. Progress in Energy and Combustion Science, 2005. **31**(5-6): p. 466-487.
31. AENOR, *Automotive fuels. Fatty acid methyl esters (FAME) for diesel engines. Requirements and test methods.*, AENOR, Editor 2003, AENOR.
32. ASTM, *Standard Specification for Biodiesel Fuel Blendstock (B100) for Middle Distillate Fuels.*, ASTM, Editor 2007, ASTM.
33. J.C. Yori, S.A. D'Ippolito, C.L. Pieck, y C.R. Vera, *Deglycerolization of Biodiesel Streams by Adsorption Over Silica Beds*. 2007. **21**(1): p. 347-353.
34. Z.J. Predojevic, *The production of biodiesel from waste frying oils: A comparison of different purification steps*. Fuel, 2008. **87**(17-18): p. 3522-3528.
35. Y. Wang, X. Wang, Y. Liu, S. Ou, Y. Tan, y S. Tang, *Refining of biodiesel by ceramic membrane separation*. Fuel Processing Technology, 2008. **90**(3): p. 422-427.
36. H. He, X. Guo, y S. Zhu, *Comparison of membrane extraction with traditional extraction methods for biodiesel production*. Journal of the American Oil Chemists Society, 2006. **83**(5): p. 457-460.
37. R.A. Moreau, K.M. Scott, y M.J. Haas, *The identification and quantification of steryl glucosides in precipitates from commercial biodiesel*. Journal of the American Oil Chemists Society, 2008. **85**(8): p. 761-770.
38. H.Y. Tang, R.C. De Guzman, S.O. Salley, y K.Y.S. Ng, *Formation of Insolubles in Palm Oil-, Yellow Grease-, and Soybean Oil-Based Biodiesel Blends After Cold Soaking at 4°C*. Journal of the American Oil Chemists Society, 2008. **85**(12): p. 1173-1182.
39. M. Johnston y T. Holloway, *A global comparison of national biodiesel production potentials*. Environmental Science & Technology, 2007. **41**(23): p. 7967-7973.
40. Y.C. Sharma y B. Singh, *Development of biodiesel: Current scenario*. Renewable and Sustainable Energy Reviews, 2008. **13**(6-7): p. 1646-1651.

41. A. Karmakar, S. Karmakar, y S. Mukherjee, *Biodiesel production from neem towards feedstock diversification: Indian perspective*. Renewable and Sustainable Energy Reviews, 2012. **16**(1): p. 1050-1060.
42. M.Y. Koh y T.I. Mohd. Ghazi, *A review of biodiesel production from Jatropha curcas L. oil*. Renewable and Sustainable Energy Reviews, 2011. **15**(5): p. 2240-2251.
43. H. Lu, Y. Liu, H. Zhou, Y. Yang, M. Chen, y B. Liang, *Production of biodiesel from Jatropha curcas L. oil*. Computers & Chemical Engineering, 2009. **33**(5): p. 1091-1096.
44. H.J. Berchmans y S. Hirata, *Biodiesel production from crude Jatropha curcas L. seed oil with a high content of free fatty acids*. Bioresource Technology, 2008. **99**(6): p. 1716-1721.
45. I. Vieitez, M.J. Pardo, C. da Silva, C. Bertoldi, F. de Castilhos, J.V. Oliveira, M.A. Grompone, y I. Jachmanián, *Continuous synthesis of castor oil ethyl esters under supercritical ethanol*. The Journal of Supercritical Fluids, 2011. **56**(3): p. 271-276.
46. P. Berman, S. Nizri, y Z. Wiesman, *Castor oil biodiesel and its blends as alternative fuel*. Biomass and Bioenergy, 2011. **35**(7): p. 2861-2866.
47. D.d.C. Barbosa, T.M. Serra, S.M.P. Meneghetti, y M.R. Meneghetti, *Biodiesel production by ethanolysis of mixed castor and soybean oils*. Fuel, 2010. **89**(12): p. 3791-3794.
48. N.v. de Lima da Silva, C.s. Benedito Batistella, R. Maciel Filho, y M.R.W. Maciel, *Biodiesel Production from Castor Oil: Optimization of Alkaline Ethanolysis*. Energy & Fuels, 2009. **23**(11): p. 5636-5642.
49. S.V. Araújo, B.S. Rocha, F.M.T. Luna, E.M. Rola Jr, D.C.S. Azevedo, y C.L. Cavalcante Jr, *FTIR assessment of the oxidation process of castor oil FAME submitted to PetroOXY and Rancimat methods*. Fuel Processing Technology, 2011. **92**(5): p. 1152-1155.
50. C. Martín, A. Moure, G. Martín, E. Carrillo, H. Domínguez, y J.C. Parajó, *Fractional characterisation of jatropha, neem, moringa, trisperma, castor and candlenut seeds as potential feedstocks for biodiesel production in Cuba*. Biomass and Bioenergy, 2010. **34**(4): p. 533-538.
51. R.P. Rodríguez, L.G. Perez, M. Alfonso, M. Duarte, R. Caro, J. Galle, R. Sierens, y S. Verhelst, *Characterization of Jatropha curcas oils and their derived fatty acid ethyl esters obtained from two different plantations in Cuba*. Biomass and Bioenergy, 2011. **35**(9): p. 4092-4098.
52. Y.-H. Chen, J.-H. Chen, Y.-M. Luo, N.-C. Shang, C.-H. Chang, C.-Y. Chang, P.-C. Chiang, y J.-L. Shie, *Property modification of jatropha oil biodiesel by blending with other biodiesels or adding antioxidants*. Energy, 2011. **36**(7): p. 4415-4421.
53. H. Veny, S. Baroutian, M.K. Aroua, M. Hasan, A.A. Raman, y N.M.N. Sulaiman, *Density of Jatropha curcas Seed Oil and its Methyl Esters: Measurement and Estimations*. International Journal of Thermophysics, 2009. **30**(2): p. 529-541.
54. J.S. de Oliveira, P.M. Leite, L.B. de Souza, V.M. Mello, E.C. Silva, J.C. Rubim, S.M.P. Meneghetti, y P.A.Z. Suarez, *Characteristics and composition of Jatropha gossypifolia and Jatropha curcas L. oils and application for biodiesel production*. Biomass and Bioenergy, 2009. **33**(3): p. 449-453.
55. M.E. da Cunha, L.C. Krause, M.S.A. Moraes, C.S. Faccini, R.A. Jacques, S.R. Almeida, M.R.A. Rodrigues, y E.B. Caramão, *Beef tallow biodiesel produced in a pilot scale*. Fuel Processing Technology, 2009. **90**(4): p. 570-575.
56. J.M. Dias, M.C.M. Alvim-Ferraz, y M.F. Almeida, *Production of biodiesel from acid waste lard*. Bioresource Technology, 2009. **100**(24): p. 6355-6361.
57. J.M. Encinar, N. Sánchez, G. Martínez, y L. García, *Study of biodiesel production from animal fats with high free fatty acid content*. Bioresource Technology, 2011. **102**(23): p. 10907-10914.
58. O. Andersen y J.-E. Weinbach, *Residual animal fat and fish for biodiesel production. Potentials in Norway*. Biomass and Bioenergy, 2010. **34**(8): p. 1183-1188.

59. M. Gürü, B.D. Artukoğlu, A. Keskin, y A. Koca, *Biodiesel production from waste animal fat and improvement of its characteristics by synthesized nickel and magnesium additive*. Energy Conversion and Management, 2009. **50**(3): p. 498-502.
60. Z. Mark, H. Rafael, y S. Darrell, *A Review of the Engineering Aspects of the Biodiesel Industry*. Tesis doctoral, 2003.
61. G. Karavalakis, D. Hilari, L. Givalou, D. Karonis, y S. Stournas, *Storage stability and ageing effect of biodiesel blends treated with different antioxidants*. Energy, 2011. **36**(1): p. 369-374.
62. S. Bezergianni, K. Kalogeras, y P.A. Pilavachi, *On maximizing biodiesel mixing ratio based on final product specifications*. Computers & Chemical Engineering, 2011. **35**(5): p. 936-942.
63. M.S. Graboski y R.L. McCormick, *Combustion of fat and vegetable oil derived fuels in diesel engines*. Progress in Energy and Combustion Science, 1998. **24**(2): p. 125-164.
64. C.D. Rakopoulos, K.A. Antonopoulos, D.C. Rakopoulos, D.T. Hountalas, y E.G. Giakoumis, *Comparative performance and emissions study of a direct injection Diesel engine using blends of Diesel fuel with vegetable oils or bio-diesels of various origins*. Energy Conversion and Management, 2006. **47**(18-19): p. 3272-3287.
65. Y. Zhang, M.A. Dubé, D.D. McLean, y M. Kates, *Biodiesel production from waste cooking oil: 1. Process design and technological assessment*. Bioresource Technology, 2003. **89**(1): p. 1-16.
66. Y. Zhang, M.A. Dubé, D.D. McLean, y M. Kates, *Biodiesel production from waste cooking oil: 2. Economic assessment and sensitivity analysis*. Bioresource Technology, 2003. **90**(3): p. 229-240.
67. A.H. West, D. Posarac, y N. Ellis, *Simulation, case studies and optimization of a biodiesel process with a solid acid catalyst*. International Journal of Chemical Reactor Engineering, 2007. **5**: p. A 37.
68. T. Sakai, A. Kawashima, y T. Koshikawa, *Economic assessment of batch biodiesel production processes using homogeneous and heterogeneous alkali catalysts*. Bioresource Technology, 2009. **100**(13): p. 3268-3276.
69. A.H. West, D. Posarac, y N. Ellis, *Assessment of four biodiesel production processes using HYSYS.Plant*. Bioresource Technology, 2008. **99**(14): p. 6587-6601.
70. J.M.N. Van Kasteren y A.P. Nisworo, *A process model to estimate the cost of industrial scale biodiesel production from waste cooking oil by supercritical transesterification*. Resources, Conservation and Recycling, 2007. **50**(4): p. 442-458.
71. M.J. Haas, A.J. McAloon, W.C. Yee, y T.A. Foglia, *A process model to estimate biodiesel production costs*. Bioresource Technology, 2006. **97**(4): p. 671-678.
72. S. Glisic y D. Skala, *The problems in design and detailed analyses of energy consumption for biodiesel synthesis at supercritical conditions*. Journal of Supercritical Fluids, 2009. **49**(2): p. 293-301.
73. M. Berrios, J. Siles, M.A. Martin, y A. Martin, *A kinetic study of the esterification of free fatty acids (FFA) in sunflower oil*. Fuel, 2007. **86**: p. 2383-2388.
74. K.W. Lee, J.X. Yu, L. Yan, Y.W. Kim, y K.W. Chung, *A kinetic study on the transesterification of glyceryl monooleate and soybean used frying oil to biodiesel*. Journal of Industrial and Engineering Chemistry, 2007. **13**: p. 799-807.
75. L.F. Ramírez-Verduzco, B.E. García-Flores, J.E. Rodríguez-Rodríguez, y A. del Rayo Jaramillo-Jacob, *Prediction of the density and viscosity in biodiesel blends at various temperatures*. Fuel, 2011. **90**(5): p. 1751-1761.
76. M.J. Pratas, S. Freitas, M.B. Oliveira, S.C. Monteiro, A.S. Lima, y J.A.P. Coutinho, *Densities and Viscosities of Fatty Acid Methyl and Ethyl Esters*. Journal of Chemical and Engineering Data, 2010. **55**(9): p. 3983-3990.

77. M. Lapuerta, J. Rodríguez-Fernández, y O. Armas, *Correlation for the estimation of the density of fatty acid esters fuels and its implications. A proposed Biodiesel Cetane Index*. Chemistry and Physics of Lipids, 2010. **163**(7): p. 720-727.
78. B. Tesfa, R. Mishra, F. Gu, y N. Powles, *Prediction models for density and viscosity of biodiesel and their effects on fuel supply system in CI engines*. Renewable Energy, 2010. **35**(12): p. 2752-2760.
79. M. Lapuerta, J. Rodríguez-Fernández, y E.F. de Mora, *Correlation for the estimation of the cetane number of biodiesel fuels and implications on the iodine number*. Energy Policy, 2009. **37**(11): p. 4337-4344.
80. M.J. Ramos, C.M. Fernández, A. Casas, L. Rodríguez, y Á. Pérez, *Influence of fatty acid composition of raw materials on biodiesel properties*. Bioresource Technology, 2009. **100**(1): p. 261-268.
81. C. Wu, J. Zhang, W. Li, Y. Wang, y H. Cao, *Artificial neural network model to predict cold filter plugging point of blended diesel fuels*. Fuel Processing Technology, 2006. **87**(7): p. 585-590.
82. Y.-C. Su, Y.A. Liu, C.A. Diaz Tovar, y R. Gani, *Selection of Prediction Methods for Thermophysical Properties for Process Modeling and Product Design of Biodiesel Manufacturing*. Industrial & Engineering Chemistry Research, 2011. **50**(11): p. 6809-6836.
83. B.E. Poling, J.M. Prausnitz, y J.P. O'Connell, *The properties of gases and liquids*. 5th ed2001, New York: McGraw-Hill.
84. R.C. Reid, J.M. Prausnitz, y B.E. Poling, *The properties of gases and liquids*. 4th ed1987, New York: McGraw-Hill.
85. K. Anand, R.P. Sharma, y P.S. Mehta, *A comprehensive approach for estimating thermo-physical properties of biodiesel fuels*. Applied Thermal Engineering, 2011. **31**(2-3): p. 235-242.
86. C.F. Spencer y R.P. Danner, *Improved equation for prediction of saturated liquid density*. Journal of Chemical and Engineering Data, 1972. **17**(2): p. 236-241.
87. W. Yuan, A.C. Hansen, y Q. Zhang, *Predicting the physical properties of biodiesel for combustion modeling*. Transactions of the Asae, 2003. **46**(6): p. 1487-1493.
88. E. Blangino, A.F. Riveros, y S.D. Romano, *Numerical expressions for viscosity, surface tension and density of biodiesel: analysis and experimental validation*. Physics and Chemistry of Liquids, 2008. **46**(5): p. 527-547.
89. S. Baroutian, M.K. Aroua, A.A.A. Raman, y N.M.N. Sulaiman, *Density of palm oil-based methyl ester*. Journal of Chemical and Engineering Data, 2008. **53**(3): p. 877-880.
90. S. Baroutian, M.K. Aroua, A.A.A. Raman, y N.M.N. Sulaiman, *Densities of ethyl esters produced from different vegetable oils*. Journal of Chemical and Engineering Data, 2008. **53**(9): p. 2222-2225.
91. L.D. Clements, *Blending rules for formulating biodiesel fuel. Liquid fuel and industrial products from renewable resources.*, in *Proceedings of the 3rd Liquid Fuels Conference organized by ASAE1996*: page 44, Nashville, TN; USA.
92. S.D. Sanford, J.M. White, P.S. Shah, C. Wee, M.A. Valverde, y G.R. Meier, *Feedstock and Biodiesel Characteristics Report*, 2009, Renewable Energy Group, Inc.
93. E. Alptekin y M. Canakci, *Determination of the density and the viscosities of biodiesel-diesel fuel blends*. Renewable Energy, 2008. **33**(12): p. 2623-2630.
94. S.H. Yoon, S.H. Park, y C.S. Lee, *Experimental investigation on the fuel properties of biodiesel and its blends at various temperatures*. Energy & Fuels, 2008. **22**(1): p. 652-656.
95. R.M. Balabin, E.I. Lomakina, y R.Z. Safieva, *Neural network (ANN) approach to biodiesel analysis: Analysis of biodiesel density, kinematic viscosity, methanol and water contents using near infrared (NIR) spectroscopy*. Fuel, 2011. **90**(5): p. 2007-2015.

96. S. Baroutian, M.K. Aroua, A.A. Raman, y N.M. Sulaiman, *Prediction of palm oil-based methyl ester biodiesel density using artificial neural networks*. J. Applied Sci. Data, 2008. **8**: p. 1938-1943.
97. K. Krisnangkura, T. Yimsuwan, y R. Pairintra, *An empirical approach in predicting biodiesel viscosity at various temperatures*. Fuel, 2006. **85**(1): p. 107-113.
98. W. Yuan, A.C. Hansen, y Q. Zhang, *Predicting the temperature dependent viscosity of biodiesel fuels*. Fuel, 2009. **88**(6): p. 1120-1126.
99. C.A.W. Allen, K.C. Watts, R.G. Ackman, y M.J. Pegg, *Predicting the viscosity of biodiesel fuels from their fatty acid ester composition*. Fuel, 1999. **78**(11): p. 1319-1326.
100. K. Anand, A. Ranjan, y P.S. Mehta, *Estimating the Viscosity of Vegetable Oil and Biodiesel Fuels*. Energy & Fuels, 2009. **24**(1): p. 664-672.
101. Q. Shu, B. Yang, J. Yang, y S. Qing, *Predicting the viscosity of biodiesel fuels based on the mixture topological index method*. Fuel, 2007. **86**(12-13): p. 1849-1854.
102. M. Lapuerta, J. Rodríguez-Fernández, Á. Ramos, y B. Álvarez, *Effect of the test temperature and anti-oxidant addition on the oxidation stability of commercial biodiesel fuels*. Fuel, 2012. **93**(0): p. 391-396.
103. J. Xin, H. Imahara, y S. Saka, *Kinetics on the oxidation of biodiesel stabilized with antioxidant*. Fuel, 2009. **88**(2): p. 282-286.
104. N.A. Santos, A.M.T.M. Cordeiro, S.S. Damasceno, R.T. Aguiar, R. Rosenhaim, J.R. Carvalho Filho, I.M.G. Santos, A.S. Maia, y A.G. Souza, *Commercial antioxidants and thermal stability evaluations*. Fuel, 2012(0).
105. W.W. Focke, I.v.d. Westhuizen, A.B.L. Grobler, K.T. Nshoane, J.K. Reddy, y A.S. Luyt, *The effect of synthetic antioxidants on the oxidative stability of biodiesel*. Fuel, 2012. **94**(0): p. 227-233.
106. E.C.R. Maia, D. Borsato, I. Moreira, K.R. Spacino, P.R.P. Rodrigues, y A.L. Gallina, *Study of the biodiesel B100 oxidative stability in mixture with antioxidants*. Fuel Processing Technology, 2011. **92**(9): p. 1750-1755.
107. T.T. Kivevele, M.M. Mbarawa, A. Bereczky, T. Laza, y J. Madarasz, *Impact of antioxidant additives on the oxidation stability of biodiesel produced from Croton Megalocarpus oil*. Fuel Processing Technology, 2011. **92**(6): p. 1244-1248.
108. T. Hoshino, Y. Iwata, y H. Koseki, *Oxidation stability and risk evaluation of biodiesel*. Thermal Science, 2007. **11**(2): p. 87-100.
109. A. Neumann, T. Jebens, y V. Wiembicki, *A method for determining oxidation stability of petrodiesel, biodiesel, and blended fuels*. American Laboratory, 2008. **40**(4): p. 22.
110. F. Gharagheizi, R.F. Alamdari, y M.T. Angaji, *A New Neural Network-Group Contribution Method for Estimation of Flash Point Temperature of Pure Components*. Energy & Fuels, 2008. **22**(3): p. 1628-1635.
111. S. Pinzi, D. Leiva, G. Arzamendi, L.M. Gandia, y M.P. Dorado, *Multiple response optimization of vegetable oils fatty acid composition to improve biodiesel physical properties*. Bioresource Technology, 2011. **102**(15): p. 7280-7288.
112. P.B. Semwal y R.G. Varshney, *Predictions of pour, cloud and cold filter plugging point for future diesel fuels with application to diesel blending models*. Fuel, 1995. **74**(3): p. 437-444.
113. M. García, A. Gonzalo, J.L. Sánchez, J. Arauzo, y J.Á. Peña, *Prediction of normalized biodiesel properties by simulation of multiple feedstock blends*. Bioresource Technology, 2010. **101**(12): p. 4431-4439.
114. A. Gonzalo, M. Garcia, J.L. Sanchez, J. Arauzo, y J.A. Pena, *Water Cleaning of Biodiesel. Effect of Catalyst Concentration, Water Amount, and Washing Temperature on Biodiesel Obtained from Rapeseed Oil and Used Oil*. Industrial & Engineering Chemistry Research, 2010. **49**(9): p. 4436-4443.

115. M. García, A. Gonzalo, J.L. Sánchez, J. Arauzo, y C. Simoes, *Methanolysis and ethanolysis of animal fats: A comparative study of the influence of alcohols*. Chemical Industry and Chemical Engineering Quarterly, 2011. **17**(1): p. 91-97.
116. M. García, J.-J. Alba, A. Gonzalo, J.L. Sánchez, y J. Arauzo, *Comparison of Methods for Estimating Critical Properties of Alkyl Esters and Its Mixtures*. Journal of Chemical and Engineering Data, 2011. **57**(1): p. 208-218.
117. A.E. Andreatta, L.M. Casás, P. Hegel, S.B. Bottini, y E.A. Brignole, *Phase Equilibria in Ternary Mixtures of Methyl Oleate, Glycerol, and Methanol*. Industrial & Engineering Chemistry Research, 2008. **47**(15): p. 5157-5164.
118. D.S. Negi, F. Sobotka, T. Kimmel, G. Wozny, y R. Schomacker, *Liquid-Liquid Phase Equilibrium in Glycerol-Methanol-Methyl Oleate and Glycerol-Monoolein-Methyl Oleate Ternary Systems*. Industrial & Engineering Chemistry Research, 2006. **45**(10): p. 3693-3696.
119. H. Imahara, E. Minami, y S. Saka, *Thermodynamic study on cloud point of biodiesel with its fatty acid composition*. Fuel, 2006. **85**(12-13): p. 1666-1670.
120. L. Catoire, S. Paulmier, y V. Naudet, *Estimation of closed cup flash points of combustible solvent blends*. Journal of Physical and Chemical Reference Data, 2006. **35**(1): p. 9-14.
121. M. Naik, L.C. Meher, S.N. Naik, y L.M. Das, *Production of biodiesel from high free fatty acid Karanja (*Pongamia pinnata*) oil*. Biomass and Bioenergy, 2008. **32**(4): p. 354-357.
122. S.V. Ghadge y H. Raheman, *Biodiesel production from mahua (*Madhuca indica*) oil having high free fatty acids*. Biomass and Bioenergy, 2005. **28**(6): p. 601-605.
123. M. Berrios y R.L. Skelton, *Comparison of purification methods for biodiesel*. Chemical Engineering Journal, 2008. **144**(3): p. 459-465.
124. F. Karaosmanoğlu, K.B. Cığızoğlu, M. Tüter, y S. Ertekin, *Investigation of the Refining Step of Biodiesel Production*. Energy & Fuels, 1996. **10**(4): p. 890-895.
125. L.F. Gutiérrez, Ó.J. Sánchez, y C.A. Cardona, *Process integration possibilities for biodiesel production from palm oil using ethanol obtained from lignocellulosic residues of oil palm industry*. Bioresource Technology, 2009. **100**(3): p. 1227-1237.
126. A.A. Apostolakou, I.K. Kookos, C. Marazioti, y K.C. Angelopoulos, *Techno-economic analysis of a biodiesel production process from vegetable oils*. Fuel Processing Technology, 2009. **90**(7-8): p. 1023-1031.
127. Z. Hou y D. Zheng, *Solar utility and renewability evaluation for biodiesel production process*. Applied Thermal Engineering, 2009. **29**(14-15): p. 3169-3174.
128. O.S. Stamenković, A.V. Veličković, y V.B. Veljković, *The production of biodiesel from vegetable oils by ethanolysis: Current state and perspectives*. Fuel, 2011. **90**(11): p. 3141-3155.
129. S. Schober, I. Seidl, y M. Mittelbach, *Ester content evaluation in biodiesel from animal fats and lauric oils*. European Journal of Lipid Science and Technology, 2006. **108**(4): p. 309-314.
130. H.N. Bhatti, M.A. Hanif, M. Qasim, y R. Ata ur, *Biodiesel production from waste tallow*. Fuel, 2008. **87**(13-14): p. 2961-2966.
131. D.U. Skala, S. Glišić, I. Lukić, y A.M. Orlović, *Biodiesel II: A new concept of biodiesel production - transesterification with supercritical methanol*. Hemijska industrija, 2004. **54**(4): p. 176-185.
132. G.M. Tashtoush, M.I. Al-Widyan, y M.M. Al-Jarrah, *Experimental study on evaluation and optimization of conversion of waste animal fat into biodiesel*. Energy Conversion and Management, 2004. **45**(17): p. 2697-2711.
133. L.S.G. Teixeira, M.B. Couto, G.S. Souza, M. Andrade, J.C.R. Assis, P.R.B. Guimaraes, L.A.M. Pontes, S.Q. Almeida, y J.S.R. Teixeira, *Characterization of beef tallow biodiesel and their mixtures with soybean biodiesel and mineral diesel fuel*. Biomass and Bioenergy, 2010. **34**(4): p. 438-441.

134. J.M. Dias, M.C.M. Alvim-Ferraz, y M.F. Almeida, *Mixtures of Vegetable Oils and Animal Fat for Biodiesel Production: Influence on Product Composition and Quality*. Energy & Fuels, 2008. **22**(6): p. 3889-3893.
135. M.G. Kulkarni, A.K. Dalai, y N.N. Bakhshi, *Transesterification of canola oil in mixed methanol/ethanol system and use of esters as lubricity additive*. Bioresource Technology, 2007. **98**(10): p. 2027-2033.
136. H. Joshi, B.R. Moser, J. Toler, y T. Walker, *Preparation and fuel properties of mixtures of soybean oil methyl and ethyl esters*. Biomass and Bioenergy, 2010. **34**(1): p. 14-20.
137. E. Sendzikiene, V. Makareviciene, y P. Janulis, *Oxidation stability of biodiesel fuel produced from fatty wastes*. Polish Journal of Environmental Studies, 2005. **14**(3): p. 335-339.
138. W. Yuan, A.C. Hansen, y Q. Zhang, *Vapor pressure and normal boiling point predictions for pure methyl esters and biodiesel fuels*. Fuel, 2005. **84**(7-8): p. 943-950.
139. G.S. Soave, *A noncubic equation of state for the treatment of hydrocarbon fluids at reservoir conditions*. Industrial & Engineering Chemistry Research, 1995. **34**(11): p. 3981-3994.
140. D. Kumar, G. Kumar, Poonam, y C.P. Singh, *Fast, easy ethanolysis of coconut oil for biodiesel production assisted by ultrasonication*. Ultrasonics Sonochemistry, 2010. **17**(3): p. 555-559.
141. C.M. García Santander, S.M. Gómez Rueda, N. de Lima da Silva, C.L. de Camargo, T.G. Kieckbusch, y M.R. Wolf Maciel, *Measurements of normal boiling points of fatty acid ethyl esters and triacylglycerols by thermogravimetric analysis*. Fuel, 2011.
142. P. Nakpong y S. Wootthikanokkhan, *High free fatty acid coconut oil as a potential feedstock for biodiesel production in Thailand*. Renewable Energy, 2010. **35**(8): p. 1682-1687.
143. F.X. Feitosa, M.d.L. Rodrigues, C.B. Veloso, C.I.L. Cavalcante, M.n.C.G. Albuquerque, y H.B. de Sant'Ana, *Viscosities and Densities of Binary Mixtures of Coconut + Colza and Coconut + Soybean Biodiesel at Various Temperatures*. Journal of Chemical and Engineering Data, 2010. **55**(9): p. 3909-3914.
144. X. Lang, A.K. Dalai, N.N. Bakhshi, M.J. Reaney, y P.B. Hertz, *Preparation and characterization of bio-diesels from various bio-oils*. Bioresource Technology, 2001. **80**(1): p. 53-62.
145. M.M. Conceição, R.A. Candeia, F.C. Silva, A.F. Bezerra, J.V.J. Fernandes, y A.G. Souza, *Thermoanalytical characterization of castor oil biodiesel*. Renewable and Sustainable Energy Reviews, 2007. **11**(5): p. 964-975.
146. M.J. Pratas, S.V.D. Freitas, M.B. Oliveira, S.C. Monteiro, A.S. Lima, y J.A.P. Coutinho, *Biodiesel Density: Experimental Measurements and Prediction Models*. Energy & Fuels, 2011. **25**(5): p. 2333-2340.
147. O.J. Alamu, M.A. Waheed, y S.O. Jekayinfa, *Effect of ethanol-palm kernel oil ratio on alkali-catalyzed biodiesel yield*. Fuel, 2008. **87**(8-9): p. 1529-1533.
148. R. Ceriani, C.B. Goncalves, J. Rabelo, M. Caruso, A.C.C. Cunha, F.W. Cavaleri, E.A.C. Batista, y A.J.A. Meirelles, *Group contribution model for predicting viscosity of fatty compounds*. Journal of Chemical and Engineering Data, 2007. **52**(3): p. 965-972.
149. H.-C. Hsu, Y.-W. Sheu, y C.-H. Tu, *Viscosity estimation at low temperatures ($T_r < 0.75$) for organic liquids from group contributions*. Chemical Engineering Journal, 2002. **88**(1-3): p. 27-35.
150. L.F. Ramírez-Verduzco, J.E. Rodríguez-Rodríguez, y A.d.R. Jaramillo-Jacob, *Predicting cetane number, kinematic viscosity, density and higher heating value of biodiesel from its fatty acid methyl ester composition*. Fuel, 2012. **91**(1): p. 102-111.
151. G. Knothe y K.R. Steidley, *Kinematic viscosity of fatty acid methyl esters: Prediction, calculated viscosity contribution of esters with unavailable data, and carbon-oxygen equivalents*. Fuel, 2011. **90**(11): p. 3217-3224.

-
152. G. Knothe y K.R. Steidley, *Kinematic viscosity of biodiesel fuel components and related compounds. Influence of compound structure and comparison to petrodiesel fuel components*. Fuel, 2005. **84**(9): p. 1059-1065.
 153. U. Rashid, F. Anwar, B.R. Moser, y G. Knothe, *Moringa oleifera oil: A possible source of biodiesel*. Bioresource Technology, 2008. **99**(17): p. 8175-8179.
 154. R. Sarin, M. Sharma, S. Sinharay, y R.K. Malhotra, *Jatropha–Palm biodiesel blends: An optimum mix for Asia*. Fuel, 2007. **86**(10-11): p. 1365-1371.
 155. J. Krahl, G. Knothe, A. Munack, Y. Ruschel, O. Schröder, E. Hallier, G. Westphal, y J. Bünger, *Comparison of exhaust emissions and their mutagenicity from the combustion of biodiesel, vegetable oil, gas-to-liquid and petrodiesel fuels*. Fuel, 2009. **88**(6): p. 1064-1069.
 156. T. Issariyakul, M.G. Kulkarni, L.C. Meher, A.K. Dalai, y N.N. Bakhshi, *Biodiesel production from mixtures of canola oil and used cooking oil*. Chemical Engineering Journal, 2008. **140**(1-3): p. 77-85.
 157. B.R. Moser y S.F. Vaughn, *Efficacy of fatty acid profile as a tool for screening feedstocks for biodiesel production*. Biomass and Bioenergy, 2012. **37**: p. 31-41.
 158. R.D. Cook, *Detection of influential observation in linear-regression*. Technometrics, 1977. **19**(1): p. 15-18.

Anexos

Artículo I



Prediction of normalized biodiesel properties by simulation of multiple feedstock blends

Manuel García^a, Alberto Gonzalo^a, José Luis Sánchez^a, Jesús Arauzo^a, José Ángel Peña^{b,*}

^aThermochemical Processes Research Group (GPT), Aragón Institute of Engineering Research (I3A), Universidad de Zaragoza, María de Luna, 3, Torres-Quevedo Bld., 50018 Zaragoza, Spain

^bCatalysis, Molecular Separations and Reactor Engineering Group (CREG), Aragón Institute of Engineering Research (I3A), Universidad de Zaragoza, María de Luna, 3, Torres-Quevedo Bld., 50018 Zaragoza, Spain

ARTICLE INFO

Article history:

Received 28 October 2009
Received in revised form 18 January 2010
Accepted 20 January 2010
Available online 18 February 2010

Keywords:

Biodiesel properties
HYSYS
Simulation
Transesterification
EN-14214

ABSTRACT

A continuous process for biodiesel production has been simulated using Aspen HYSYS V7.0 software. As fresh feed, feedstocks with a mild acid content have been used. The process flowsheet follows a traditional alkaline transesterification scheme constituted by esterification, transesterification and purification stages. Kinetic models taking into account the concentration of the different species have been employed in order to simulate the behavior of the CSTR reactors and the product distribution within the process.

The comparison between experimental data found in literature and the predicted normalized properties, has been discussed. Additionally, a comparison between different thermodynamic packages has been performed. NRTL activity model has been selected as the most reliable of them. The combination of these models allows the prediction of 13 out of 25 parameters included in standard EN-14214:2003, and confers simulators a great value as predictive as well as optimization tool.

© 2010 Elsevier Ltd. All rights reserved.

1. Introduction

In recent years, global warming and environmental pollution have become major issues. The use of fuels coming from biomass such as biodiesel and bioethanol can help solve such matters because of the renewable features of these energy sources.

Currently, the major handicap to the large-scale commercialization of biodiesel is its high production cost, 1.5–3 times higher than fossil diesel (Demirbas, 2009). This fact is largely attributed to the cost of fresh vegetable oil feedstocks (Canakci and Van Gerpen, 2001). On the other hand, the production of biodiesel with full compliance with EN-14214:2003 or ASTM 6751-07 is a very challenging task. From this point of view, the search for new and low cost raw materials including mixtures of different sources (fresh or recycled) (Pinzi et al., 2009), as well as the development of simulation tools capable of predicting the properties of the final product, can be the path guiding to the solution of a cheaper biodiesel that fulfils mandatory standards.

Process simulators are commonly used to provide reliable information on process operation owing to their component libraries, comprehensive thermodynamic packages and advanced computational methods. Nevertheless the prediction of the properties of

nal products from a production process departing from its raw materials, is nowadays an important target pursued by industrial companies as a logistic and production optimization tool.

Modelling of biodiesel production has attracted the attention of researchers during last years. Homogeneous alkali- and acid-catalyzed systems (Zhang et al., 2003), heterogeneous catalyzed processes (West et al., 2007) and supercritical methods of production (Glisic and Skala, 2009) have been modelled and simulated. All these articles, with the exception of that of Zhang et al. (2003), included the economic evaluation of the processes, and in all of them, the topology of the process appears as an important variable that determine the conclusions obtained. Although it was not the main purpose of these works, the proposed simplifications prevented in some cases from predicting the final properties of the biodiesel, especially those included in standard EN-14214:2003. This issue appears to be extremely interesting in order to use process simulation as a production tool.

To face the biodiesel process simulation and the prediction of the normalized final properties using a process simulator, it is necessary to take into account several issues which include the quantity and quality of the constituents of the departing oils, the topology of the process, the detailed kinetic models and the thermodynamic packages.

To simulate a greater number of constituents of the departing oils, should be taken into account that triolein, tripalmitin,

* Corresponding author. Tel.: +34 976 762390; fax: +34 976 761879.
E-mail address: jap@unizar.es (J.Á. Peña).

trilinolein and tristearin are the major triglycerides in most commonly used oils for biodiesel production. The fatty acids alkyl esters resulting from its alcoholysis account for more than 90 wt.% of palm, soybean, rapeseed and sunflower oils (Ramos et al., 2009). Since the majority of these compounds are not available in HYSYS component library, property estimation methods become necessary.

Regarding the topology of the process, it should be adequate to convert raw matters to the greater extent and make it in the most economically feasible way. In the context of this work, the topology has been selected as testing method for the prediction of the normalized properties.

Especial attention requires the election of the appropriate kinetic models for the transesterification (and esterification if necessary). They should be implemented from “*ad hoc*” empirical measurements carried out in laboratory, or departing from available data found in literature (Berrios et al., 2007; Lee et al., 2007). The increase in the number of triglycerides allows, in this sense, a more detailed kinetic model than can contribute to a more realistic simulation; moreover, this allows the presence of unreacted glycerides to be calculated. Additionally, some minor modifications should be implemented concerning little discrepancies between some predicted physical properties and corresponding empirical data.

The election of the most idoneous thermodynamic package should be selected, and missing binary interaction parameters should be calculated using an adequate method.

Once all this task should be fulfilled, a complete list of properties included in the above mentioned norm could be simulated introducing proper models.

Keeping all this in mind, several improvements have been implemented in Aspen HYSYS® V7.0 in order to develop a tool which permits the prediction of some of the most important final properties of the biodiesel (included in standard EN-14214:2003), departing from the composition of the raw materials used as feed. A comparison between the results obtained with this method of estimation and empirical data, has been performed in order to test the capabilities of the simulation and possible future ways of enhancement.

2. Methods

As in previous works found in literature (see above), the commercial simulation software Aspen HYSYS® V7.0, has been used to carry out the simulation. The procedure mainly involved choosing chemical components, selecting an appropriate thermodynamic package (*property package*), defining the kinetics of reactions and finally determining the plant topology and capacity, the required equipment and the operating conditions. In order to simplify the calculations, the pressure drop in the different equipments was neglected within this study.

2.1. Defining components

Information about most major components appearing in the biodiesel production process can be found in the simulator component library: methanol, glycerol, sulphuric acid, sodium hydroxide, water, methyl oleate, methyl palmitate, methyl linoleate, methyl stearate, oleic acid, palmitic acid, linoleic acid, stearic acid and triolein.

Not available components in library were specified using the “*Hypo Manager*” tool. Defining a new component requires input of a number of properties, such as UNIFAC structure, normal boiling point, density and critical properties. Required properties have been calculated using the Aspen Properties® V7.0 and suitable esti-

mation methods (Gani and Constantinou, 1996). Tripalmitin, tristearin and trilinolein were all specified in this manner. Additionally, triolein was also specified as a “*Hypo Component*” due to small differences found between Aspen HYSYS® component library data and Aspen Properties® V7.0 estimation results. Triglycerides are crucial components in the vapour–liquid equilibria, so great care was taken in specifying their properties as accurately as possible. To the best of authors’ knowledge, no simulations involving four triglycerides have been published prior to this work. Table 1 shows a summary of the required inputs, and the estimated values for each component.

2.2. Thermodynamic models and kinetic parameters

The simulated process includes roughly the preconditioning of the raw materials, the esterification as well as transesterification sections, and finally the purification and separation stages. A more in-depth explanation about the topology of the process will be described later in this work.

The appropriate selection of thermodynamic models has a strong influence on liquid–liquid equilibria calculations. This reason makes this step especially important. The presence of polar compounds such as methanol and glycerol makes necessary the use of the non-random two liquids (NRTL) model or Universal Quasi-Chemical (UNIQUAC) model, but also a great care must be taken in the estimation of missing binary coefficients. UNIFAC method is usually used in order to estimate them. In the present work, UNIFAC has been used to predict the non-calculated values with the aid of the Aspen Properties®. NRTL and UNIQUAC models were compared for each simulation. In those equipments where vapour–liquid equilibria calculations were needed, a modification consisting of matching an activity model with an equation of state, NRTL-SRK and UNIQUAC-SRK models (UNIFAC-VLE for missing binary coefficients) were used.

To simulate the esterification reaction, the kinetic model proposed by Berrios et al. (2007) has been selected. On the other hand, transesterification kinetics have been largely studied, and several models can be found in bibliography. For this simulation, the model proposed by Lee et al. (2007) has been selected, which considers oil constituted by three triglycerides. The authors reported the kinetic parameters for each component considering an empirical potential model.

Esterification and transesterification reactors were assumed to operate continuously and were modelled as CSTR reactors. Due to the selected kinetic models, the mono- and di-glycerides intermediates were neglected during the reaction.

2.3. Plant capacity and operating conditions

Plant capacity was set at 73,500 metric tonnes of biodiesel per year, similar to the proposed in other published papers on biodiesel production simulation. This capacity, translated to vegetable oil feeds, rounds 8500 kg of oil per hour. The selected operating conditions are shown in Table 2 for esterification and transesterification sections. Temperature, methanol to oil molar ratio and weight percentage of catalyst related to oil are the most used values in the above mentioned simulation papers. Additionally, a multi-stage distillation zone has been added in order to recover unreacted methanol and to purify glycerol. Recovered methanol was not recycled in this simulation since no significant improvements were obtained in the scope of this work.

2.4. Biodiesel final property models

Aspen HYSYS® V7.0 provides values of physical, thermodynamic and fluid dynamic properties such as density, heat capacity and

Table 1
Critical properties and UNIFAC structure of simulated components.

Component	T_b [K] ^a	T_c [K] ^a	P_c [kPa] ^a	V_c [m ³ /kmol] ^a	ω [adim]	Functional group structure
Triolein	822.5	943.2	322.43	3.25	0.565	(CH ₃) ₃ (CH ₂) ₄₁ CH(CH=CH) ₃ (CH ₂ COO) ₃
Trilinolein	820.9	942.8	321.99	3.21	4.599	(CH ₃) ₃ (CH ₂) ₃₅ CH(CH=CH) ₆ (CH ₂ COO) ₃
Tripalmitin	804.6	923.3	366.87	2.94	3.394	(CH ₃) ₃ (CH ₂) ₄₁ CH(CH ₂ COO) ₃
Tristearin	825.5	945.1	328.36	3.29	6.806	(CH ₃) ₃ (CH ₂) ₄₇ CH(CH ₂ COO) ₃

T_b , normal boiling point.

T_c , critical temperature.

P_c , critical pressure.

V_c , critical molar volume.

ω , acentric factor.

^a Properties estimated using Gani method (Gani and Constantinou, 1996).

Table 2
Simulated operating conditions and features for the main process units.

Task	Unit name	Property package	Conditions	Value
Pre-treatment unit	F-100	NRTL-SRK/UNIQUAC-SRK	Temperature	134 °C
			Pressure	0.2 bar
Esterification	CSTR-100	NRTL/UNIQUAC	% water removed	95.38
			Temperature	60 °C
			Pressure	4.05 bar
			Volume	50 m ³
			Molar ratio MeOH:oil	6:1
			Cat. To Oil	1 wt.%
Glycerine washing	TO-100	NRTL/UNIQUAC UNIFAC L-L	Conversion	89.04%
			Pressure	4.05 bar
			Glycerine temperature	25 °C
			Stream temperature	25 °C
Transesterification	CSTR-101/102	NRTL/UNIQUAC	Glycerine mass flow	30 wt.% related to oil
			Temperature	60 °C
			Pressure	4.05 bar
			Volume	25 m ³
			Molar ratio MeOH:Oil	6:1
			Cat. To Oil	1 wt.%
			Conversion	89–94 %
Water washing	TO-101	NRTL/UNIQUAC UNIFAC L-L	Temperature	25 °C
			Pressure	4.05 bar
Water removal	F-101	NRTL-SRK/UNIQUAC-SRK	Water mass flow	30 wt.% related to oil
			Temperature	130 °C
			Pressure	0.2 bar

viscosity, to name a few. Others, included in standard EN-14214:2003 such as cetane number, iodine value, cloud point (CP), pour point (PP) and Cold Filter Plug Point (CFPP) are not directly calculated. In order to improve the property prediction capacity of the simulator, some models have been implemented in the simulator taking advantage of its extensibility using the VBA programming language. Table 3 shows the simulated properties and the models used for such task.

2.5. Process topology of the simulation

The process topology within this work has been selected as testing method for the prediction of the normalized properties. It has been elected for the treatment of a waste vegetable feedstock containing 5 wt.% FFA. The flowsheet is depicted in Fig. 1.

The vegetable oil (sunflower oil as example) is introduced in a flash unit (F-100) in order to remove water residues. Waste cooking oils may contain up to 3 wt.% of water (Loterio et al., 2005). Since flash unit involves vapour–liquid equilibria, special thermodynamic packages were used to simulate this section, enabling the combination of NRTL-SRK and UNIQUAC-SRK models depending on the adequacy of each package to each mixture. Additionally, UNIFAC-VLE was used to calculate missing binary coefficients.

Afterwards, the oil is subjected to esterification (CSTR-100) using MeOH and H₂SO₄ as catalyst. The FFA content in oil was fixed at 5 wt.% related to oil mass.

The resulting stream contains water and catalyst (H₂SO₄) which must be removed before proceeding to transesterification. By adding glycerine most of the resulting contaminants can be removed after one theoretical stage. The washing step is simulated using a liquid–liquid column (TO-100). Stream E-113 contains methanol, glycerine, water and catalyst.

The pre-treated stream E-112 is pumped into the transesterification section, where biodiesel is produced by two serial reactors (CSTR-101 and CSTR-102) achieving conversions of 89% and 94%, respectively. The resulting stream T-117 contains methyl esters (biodiesel), glycerine, methanol, NaOH and unreacted triglycerides. As noted before, reactor operating conditions are shown in Table 2.

After cooling (C-102 in Fig. 1), a water washing step is usually used to remove glycerine, methanol and catalyst. A liquid–liquid column (TO-101) is used to simulate this stage. After washing with water, the mass fraction of biodiesel has grown up to 92 wt.%. The amount of water in stream T-119 may be reduced by using a flash unit (F-101) downstream. After water removal step, FAME concentration achieves up to 97 wt.%.

Methanol, glycerine and water effluents are collected and pumped into a distillation train, which contains two distillation columns. This section is not showed for simplicity.

A summary of the operating conditions for the main process units is shown in Table 2. Table 4 shows the properties and features of the main streams and inputs of the process with sunflower as raw material.

Table 3
Customized user variables and models employed for the determination of some unavailable properties.

Property	Calculation method	References
Kinematic viscosity	Correlations and mixing rule $\ln \mu_{\text{sat-C12.0-C18.0}} = -2.177 - 0.202z + \frac{403.66}{T} + \frac{109.77z}{T}$ $\ln \mu_{\text{C18.1}} = -5.03 + \frac{2051.5}{T}$ $\ln \mu_{\text{C18.2}} = -4.51 + \frac{1822.5}{T}$ $\ln \mu = \sum_i^n y_i \text{CN}_i$	Krisnangkura et al. (2006)
Cloud point	Correlation based in data extracted from Imahara et al. (2006) $\text{CP}(K) = 299.6y_{\text{C16.0}} + 378.5y_{\text{C18.0}} + 266.5y_{\text{C18.1}} + 265.2y_{\text{C18.2}}$	Imahara et al. (2006)
CFPP ^a	Correlation $\text{CFPP} = 3.1417\text{LCSF} - 16.477$ $\text{LCSF} = 0.1y_{\text{C16.0}} + 0.5y_{\text{C18.0}}$	Ramos et al. (2009)
Cetane number	Mixing rule $\text{CN} = \sum_i^n y_i \text{CN}_i$	Ramos et al. (2009)
Iodine value	Mixing rule $\text{IV} = \sum_i^n y_i \text{IV}_i$	-
HHV ^b	Mixing rule $\text{HHV} = \sum_i^n y_i \text{HHV}_i$	Clements (1996)
Flash point	Correlation $\text{FP}(K) = 0.3544 \cdot T_b^{1.14711} \cdot z^{-0.07677}$	Catoire et al. (2006)

Where y_i is the mass fraction (wt.%) of each methyl ester, n is the number of simulated methyl esters, LCSF is the Long Chain Saturated Factor adapted from Ramos et al. (2009), z is the number of carbon atoms, T_b is the normal boiling point of the substance.

^a Cold filter plugging point.

^b Higher heating value.

3. Results and discussion

From the simulation point of view, the quality parameters included in standard EN-14214:2003 can be divided in two categories: those dependent on process topology and those depending on biodiesel composition. The process topology dependent parameters are these for which the thermodynamic package selection has a strong influence. These are represented mainly in the separation, purification and distillation steps. On the other hand, once high biodiesel purity has been achieved, some parameters such as density, viscosity, cetane number and CFPP depend only on the biodiesel composition. The following discussion takes into account these parameter categories.

As stated before, small differences in the composition of the liquid phases along the process could lead to an anomalous determination of the properties of the biodiesel. While classical models as Margules or van Laar are very often employed in simple calculations, or when accuracy is not crucial, in systems like the one described in this work, the determination of activity coefficients by more accurate methods is peremptory. Simple models such as the previously mentioned Margules or van Laar, and other suited to the computerized calculation, principally NRTL and UNIQUAC, have been checked within this work in order to determine which one of them could prevail among the others. Following the criteria of Gess et al. (1991), and bearing in mind that in this case at least two strongly polar compounds (methanol and glycerol) are involved, no clear conclusions could be drawn regarding this issue. Nevertheless, guided by the results obtained with the simulator, NRTL has been chosen as the most reliable of them. It is necessary to mention that much effort is still required to determine to the

maximum extent the best adequacy of these methods to the experimental results.

Table 5 shows the results obtained for the composition of the streams flowing out from the washing towers TO-100 and TO-101, where sunflower oil has been simulated as raw material. NRTL obtains slightly more confident results for the composition of the streams than UNIQUAC does. Unfortunately, to the best of author's knowledge, no experimental data for multicomponent systems such as the simulated one are available, but the simulated component distribution with NRTL shows a trend in good agreement with reported equilibria data for more simple systems like glycerol-methanol-methyl (Andreatta et al., 2008). This behaviour has proved to be consistent with empirical measurements carried out in our laboratories and that are currently under research, as well as from other authors in published matter (Di Felice et al., 2008; Zhou and Boocock, 2006).

Basically, NRTL suggests that almost all triglycerides, FAME's and FFA's join the light phase, while the most part (more than 98 wt.%) of water, glycerol and methanol go to the heavy one. On the other hand, UNIQUAC predicts roughly the same distribution, but assumes that heavy phases are absolutely free of triglycerides, FAME and FFA (see composition of light phase TO-101 in Table 5). The distribution of NaOH, methanol and glycerine in biodiesel cleaning with glycerine (TO-100) and water (TO-101) shows analogous trends than the above mentioned, and suggests also that NRTL results are more consistent with the real situation, as these three polar compounds are prone to dissolve in polar solvents (glycerine and water). Similar results have been obtained with the other two simulated feeds (palm and soybean).

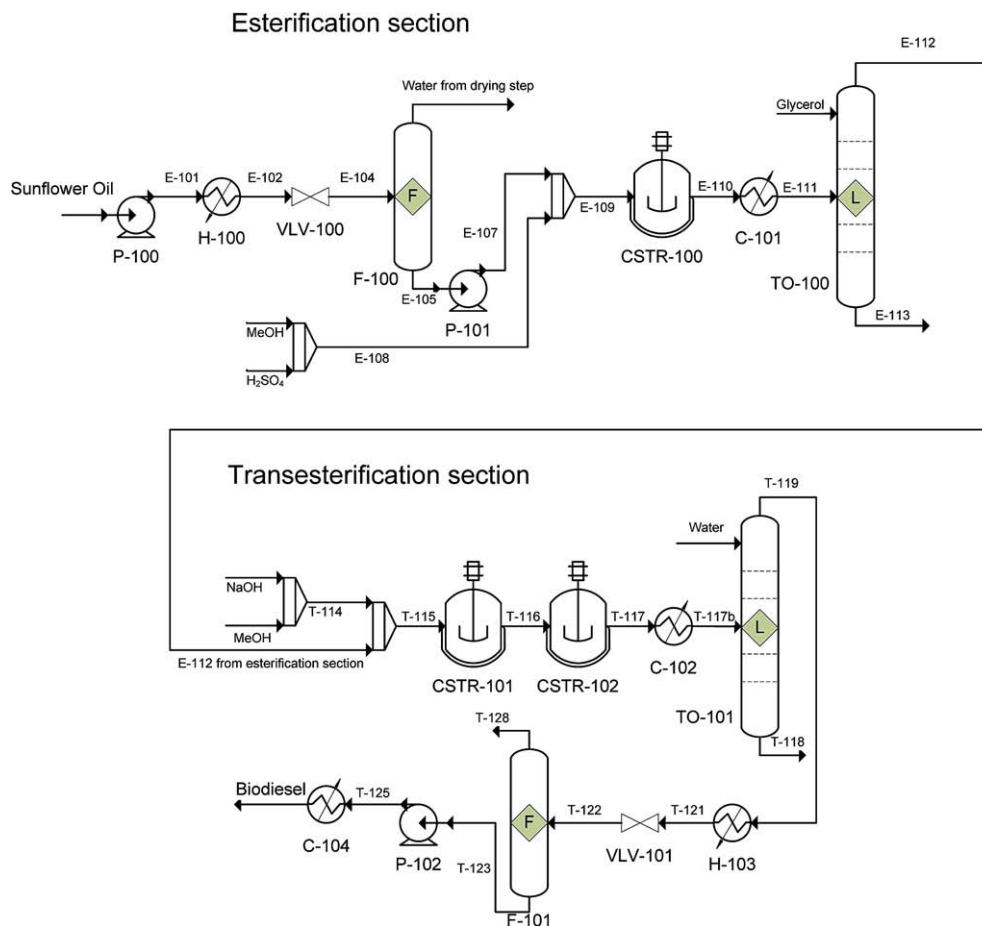

Fig. 1. Process flowsheet.

Table 4

Properties and mass fractions of components in chosen streams of the process. These results were obtained for a sunflower oil (see first column of this table) taken as example.

	Esterification							Transesterification						
	Sunflower	E-104	E-107	E-108	E-110	E-112	E-113	T-114	T-117	T-119	T-118	T-122	Biodiesel	T-128
Temperature [°C]	25	133	134	25	60	25	25	25	60	24	24	129	15.0	25
Pressure [bar]	1.01	0.2	4.05	4.05	4.05	4.05	4.05	4.05	4.05	4.05	4.05	0.2	0.2	4.05
Molar flow [kmol/h]	11.20	11.20	10.75	67.71	78.45	11.78	94.37	56.53	68.30	32.51	177.34	32.51	29.39	3.12
Mass flow [kg/h]	8500	8500	8492	2227	10718	8495	4773	1828	10323	8600	4272	8600	8508	93
Composition [mass fraction]														
Triolein	0.2435	0.2435	0.2438	0.0000	0.1931	0.2428	0.0016	0.0000	0.0007	0.0008	0.0000	0.0008	0.0008	0.0000
Trilinolein	0.6098	0.6098	0.6104	0.0000	0.4836	0.6049	0.0093	0.0000	0.0016	0.0019	0.0000	0.0019	0.0019	0.0000
Tripalmitin	0.0599	0.0599	0.0600	0.0000	0.0475	0.0599	0.0001	0.0000	0.0005	0.0006	0.0000	0.0006	0.0007	0.0000
Tristearin	0.0358	0.0358	0.0358	0.0000	0.0284	0.0358	0.0000	0.0000	0.0003	0.0004	0.0000	0.0004	0.0004	0.0000
Water	0.0010	0.0010	0.0000	0.0000	0.0023	0.0000	0.0052	0.0000	0.0000	0.0013	0.5943	0.0013	0.0001	0.1131
Glycerine	0.0000	0.0000	0.0000	0.0000	0.0000	0.0004	0.5335	0.0000	0.0816	0.0000	0.1971	0.0000	0.0000	0.0006
NaOH	0.0000	0.0000	0.0000	0.0000	0.0000	0.0000	0.0000	0.0465	0.0082	0.0014	0.0171	0.0014	0.0014	0.0000
MeOH	0.0000	0.0000	0.0000	0.9618	0.1958	0.0041	0.4324	0.9535	0.0874	0.0102	0.1906	0.0102	0.0007	0.8790
M-Oleate	0.0000	0.0000	0.0000	0.0000	0.0095	0.0120	0.0000	0.0000	0.2099	0.2517	0.0004	0.2517	0.2544	0.0032
M-Palmitate	0.0000	0.0000	0.0000	0.0000	0.0023	0.0030	0.0000	0.0000	0.0515	0.0617	0.0000	0.0617	0.0624	0.0026
M-Stearate	0.0000	0.0000	0.0000	0.0000	0.0014	0.0018	0.0000	0.0000	0.0307	0.0368	0.0000	0.0368	0.0372	0.0005
M-Linoleate	0.0000	0.0000	0.0000	0.0000	0.0238	0.0300	0.0000	0.0000	0.5232	0.6277	0.0005	0.6277	0.6345	0.0009
Oleic acid	0.0128	0.0128	0.0128	0.0000	0.0011	0.0014	0.0000	0.0000	0.0012	0.0014	0.0000	0.0014	0.0014	0.0000
Linoleic acid	0.0321	0.0321	0.0322	0.0000	0.0028	0.0035	0.0000	0.0000	0.0029	0.0035	0.0000	0.0035	0.0035	0.0000
Palmitic acid	0.0032	0.0032	0.0032	0.0000	0.0003	0.0003	0.0000	0.0000	0.0003	0.0003	0.0000	0.0003	0.0003	0.0000
Stearic acid	0.0019	0.0019	0.0019	0.0000	0.0002	0.0002	0.0000	0.0000	0.0002	0.0002	0.0000	0.0002	0.0002	0.0000
H ₂ SO ₄	0.0000	0.0000	0.0000	0.0382	0.0079	0.0000	0.0178	0.0000	0.0000	0.0000	0.0000	0.0000	0.0000	0.0000

As explained before, the main aim of this simulation was to build up a predictive tool. To achieve this goal 13 parameters contained in EN-14214:2003 standard have been implemented in the simulation tool based on appropriate models (Table 3). For the sake of brevity, only some of them will be shown herein.

Fig. 2 shows the comparison between experimental and simulated density data. Experimental results have been extracted from published papers. Regarding the way in which density has been calculated by Aspen HYSYS®, the method elected was the COSTALD (Hankinson and Thomson, 1979). The results obtained were

Table 5

Comparison between results obtained for NRTL and UNIQUAC property packages in columns TO-100 and TO-101 (see Fig. 1 for flowsheet topology).

Wt. % Component	NRTL modified				UNIQUAC			
	TO-100		TO-101		TO-100		TO-101	
	Light phase	Heavy phase	Light phase	Heavy phase	Light phase	Heavy phase	Light phase	Heavy phase
Triolein	99.63	0.37	99.42	0.58	100.00	0.00	100.00	0.00
Trilinolein	99.14	0.86	100.00	0.00	100.00	0.00	100.00	0.00
Tripalmitin	99.94	0.06	99.95	0.05	100.00	0.00	100.00	0.00
Tristearin	99.95	0.05	99.95	0.05	100.00	0.00	100.00	0.00
Water	0.04	99.96	0.43	99.57	32.26	67.74	45.73	54.58
Glycerine	0.14	99.86	0.03	99.97	5.31	94.69	8.33	91.67
NaOH	0.00	0.00	14.28	85.72	0.00	0.00	75.61	24.39
MeOH	1.64	98.36	9.71	90.29	30.83	69.17	58.92	41.08
Me-Oleate	99.87	0.13	99.91	0.09	99.99	0.01	100.00	0.00
Me-Palmitate	100.00	0.00	99.98	0.02	99.97	0.03	100.00	0.00
Me-Stearate	100.00	0.00	99.99	0.01	99.98	0.02	100.00	0.00
Me-Linoleate	99.94	0.06	99.96	0.04	99.99	0.01	100.00	0.00
Oleic acid	99.07	0.93	99.94	0.06	98.98	1.02	100.00	0.00
Linolein acid	99.45	0.55	99.97	0.03	100.00	0.00	100.00	0.00
Palmitic acid	94.89	5.11	99.82	0.18	96.59	3.41	99.91	0.09
Stearic acid	96.49	3.51	99.77	0.23	98.74	1.26	100.00	0.00
H ₂ SO ₄	0.02	99.98	0.03	99.97	44.69	55.31	78.85	21.15

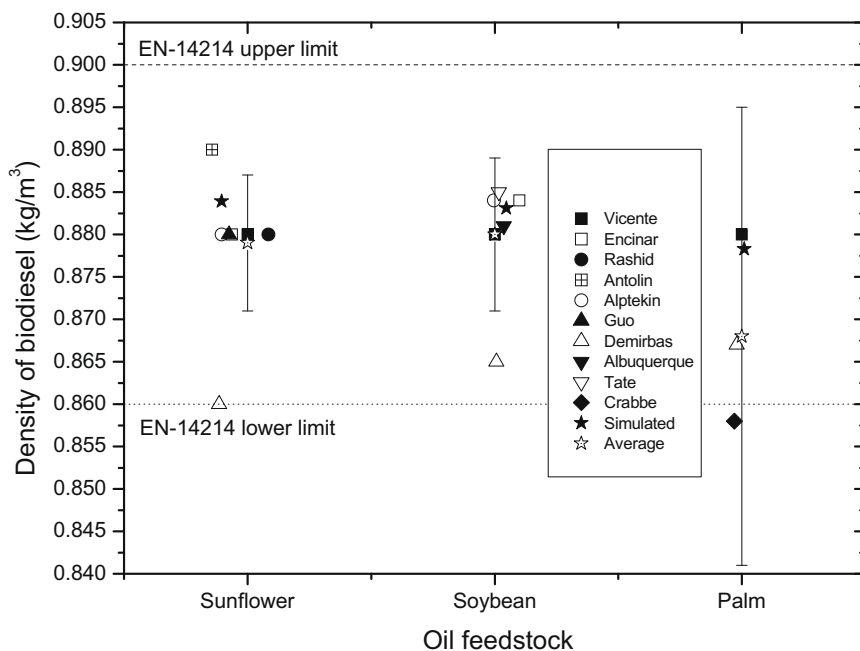

Fig. 2. Comparison between empirical and predicted densities of biodiesel for different oil feedstocks. (■) (Vicente et al., 2007), (□) (Encinar et al., 2005), (●) (Rashid et al., 2008), (⊠) (Antolin et al., 2002), (○) (Alptekin and Canakci, 2008), (▲) (Guo et al., 2009), (△) (Demirbas, 2008), (▼) (Albuquerque et al., 2009), (▽) (Tate et al., 2006) (◆) (Crabbe et al., 2001), (★) simulated and (☆) average).

checked out with other suitable models for the determination of liquid molar volumes like the Modified Rackett model (Rackett, 1970) or the DIPPR liquid volume model. No significant differences were found among them.

The results calculated for the three biodiesels (from sunflower, soybean and palm, respectively) show that the liquid density can be found within the limits of the confidence interval (95% confidence), for the average of the experimental measurements considered. Nevertheless, it should be noted that palm derived biodiesel has a significant dispersion in its data, so it renders a wider confidence interval. The particular features of the palm biodiesel will be underlined with other properties as shown below.

Calculation of kinematic viscosity for liquid mixtures is often complicated, especially in the case of organic compounds, where

chemical structure has a net influence over the micro-scale physical properties. Although several correlations for petroleum fractions and even free fatty acids are available (Clements, 1996; Krisnangkura et al., 2006), very few reliable models have been found to predict the viscosity for methyl esters (Krisnangkura et al., 2006). Moreover, the lack of empirical data makes it difficult to predict the dependence of this parameter with temperature. Most of the research efforts have concentrated in determining data at 40 °C, which is the temperature at which viscosity must be measured as stated by standard EN-14214:2003. In this study, the method proposed by Krisnangkura et al. (2006) has been used.

Fig. 3 exhibits the simulated results as well as a set of empirical viscosity data for the selected biodiesels. For simulated biodiesels from sunflower and palm oils, calculated viscosity can be found

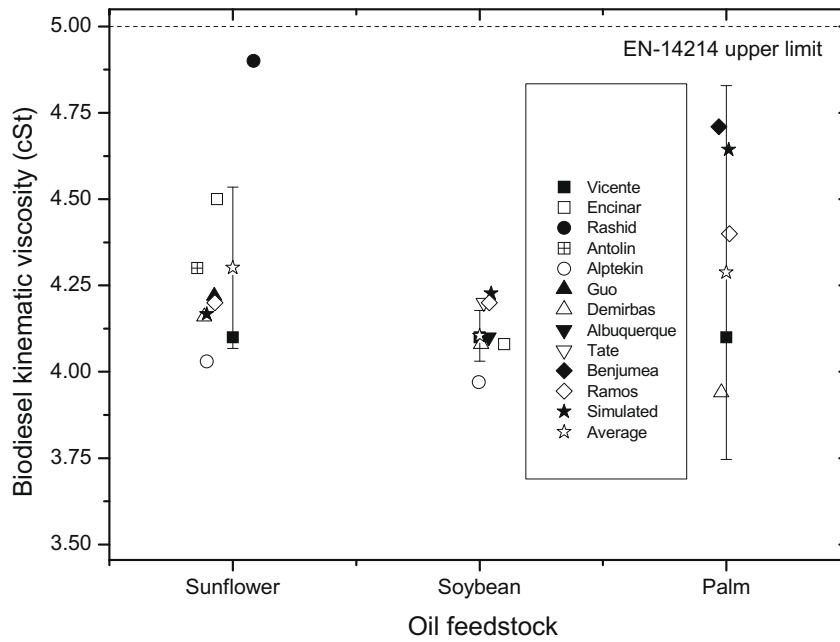

Fig. 3. Comparison between empirical and predicted kinematic viscosities of biodiesel for different oil feedstocks. (■ (Vicente et al., 2007), □ (Encinar et al., 2005), ● (Rashid et al., 2008), ▣ (Antolin et al., 2002), ○ (Alptekin and Canakci, 2008), ▲ (Guo et al., 2009), △ (Demirbas, 2008), ▼ (Albuquerque et al., 2009), ▽ (Tate et al., 2006), ◆ (Benjumea et al., 2008), ◇ (Ramos et al., 2009), ★ simulated and ☆ average).

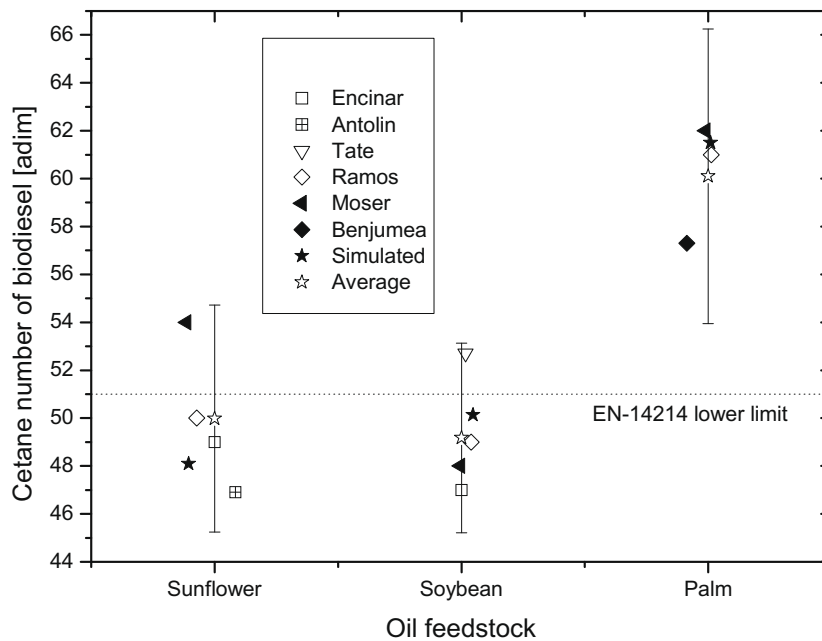

Fig. 4. Comparison between empirical and predicted cetane numbers of biodiesel for different oil feedstocks. (□ (Encinar et al., 2005), ▣ (Antolin et al., 2002), ▽ (Tate et al., 2006), ◆ (Benjumea et al., 2008), ◇ (Ramos et al., 2009), ◀ (Moser, 2008), ★ simulated and ☆ average).

within the confidence interval (depicted in the graph as vertical segments). On the contrary, the resulting value for soybean, exceeds slightly the above mentioned confidence interval (4.227 cSt calculated vs. 4.104 ± 0.073 cSt for the average value). This small difference might be attributed to the above mentioned lack of reliable data and models that, in some cases, can predict viscosities of FAME with an error rounding 8% (Krisnangkura et al., 2006), or even higher when compared to other oils like jatropha biodiesel (Kumar Tiwari et al., 2007).

Cetane number (CN) represents a dimensionless parameter whose expensive determination would make it interesting to calculate if adequate prediction models could be available. In the context of this work, the prediction model has been the one proposed by Clements (1996), which calculates the resulting biodiesel as a weighted linear combination of the CN of the constitutive pure FAME. The results agree reasonably with the empirical measurements (see Fig. 4). At this point, it must be stressed that both, theoretical and experimental data of sunflower and soybean derived

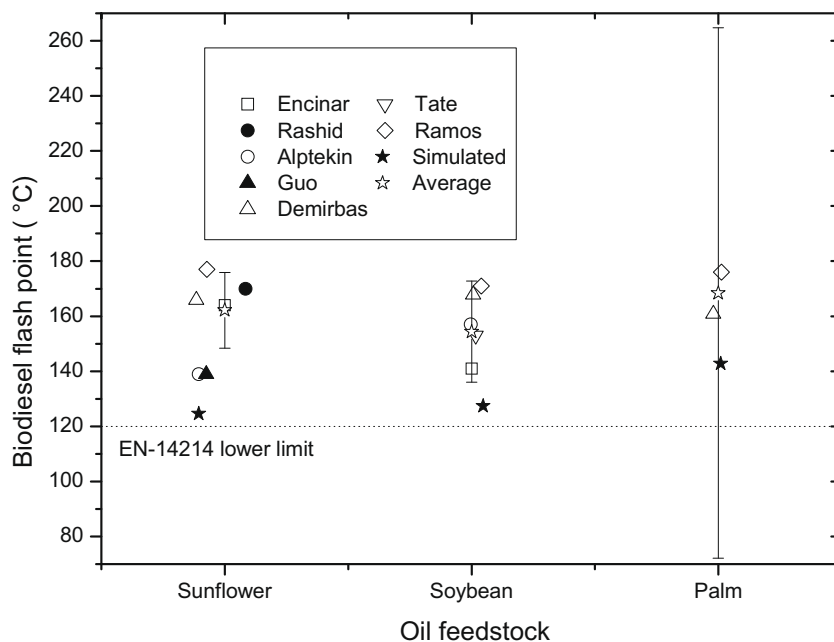

Fig. 5. Comparison between empirical and predicted flash points of biodiesel for different oil feedstocks. (□ (Encinar et al., 2005), ● (Rashid et al., 2008), ○ (Alptekin and Canakci, 2008), ▲ (Guo et al., 2009), △ (Demirbas, 2008), ▽ (Tate et al., 2006), ◇ (Ramos et al., 2009), ★ simulated and ☆ average).

Table 6

Simulated physical properties and experimental data for the oils chosen as feedstocks.

Property	Sunflower		Soybean		Palm		EN-14214:2003 limits
	Sim.	Exp.	Sim.	Exp.	Sim.	Exp.	
Ester content [wt.%]	98.85	99.5 ^a /97.2 ^d	98.8	96.9 ^d /98.2 ^f	98.6	97.7 ^d	Min 96.5
Density @ 15 °C [kg/m ³]	890.36	880 ^b /886 ^b /880 ^c	889.0	884 ^e /884.5 ^f	885.5	-	860–900
Viscosity @ 40 °C [cSt]	4.1	4.1 ^a /4.3 ^b /4.9 ^c /4.2 ^d /4.2 ^e /4.03 ^f	4.1	4.2 ^d /4.08 ^e /4 ^f	4.5	4.5 ^d /4.55 ^g	3.5–5.0
Flash point [°C]	124.6	>110 ^b /177 ^d /157 ^f	127.4	171 ^d /141 ^e /139 ^f	142.8	176 ^d	>120
Cetane number [adim]	48.1	46.9 ^b /50 ^d /49 ^e	50.1	49 ^d /47 ^e	61.5	61 ^d	>51
Iodine value [adim]	131.7	128.5 ^a /132 ^d	120.5	128 ^d	55.2	57 ^d	<120
HHV [MJ/kg]	39.2	40 ^b /45.3 ^c /40.1 ^e	39.2	39.8 ^e	39.1	-	-
CFPP [°C]	-5.5	-2 ^b / ^c -1 ^c / ^d -3 ^d	3.6	-5 ^d	43.1	10 ^d	>0
Cloud Point [°C]	-7.83	1 ^b /1 ^c	-5.4	2 ^e	5.5	-	-

^a Vicente et al. (2007).

^b Antolín et al. (2002).

^c Rashid et al. (2008).

^d Ramos et al. (2009).

^e Encinar et al. (2005).

^f Alptekin and Canakci (2008).

^g Tang et al. (2008).

biodiesels do not accomplish the EN-14214 stipulated value (minimum CN of 51). This issue can be stated as a typical problem derived from the use of single departing oil.

Flash point has been selected due to the wide range of empirical results found in literature, which clearly implies a difficult prediction capability. Although its determination is theoretically simple to achieve in the event of pure substances, the determination in a mixture of FAME, unreacted FFA and alcohols could be difficult enough to remain as an unresolved task for the simulation tool. Throughout this work, the theoretical values have been calculated with an empirical expression extracted from the work of Catoire et al. (2006) that calculates flash point as a function of the normal boiling point and the number of carbon atoms.

In this case (Fig. 5), calculated values for the three feedstock oils underestimate the published experimental data. Consequently, a better prediction model that could be implemented in the process simulation is needed. Arguing the above mentioned, it is due to say that difficult mixtures, which can contain up to 16 different com-

ponents, with scattered boiling points (e.g. from methanol – $T_b = 64.7\text{ °C}$ – to methyl linoleate – $T_b = 278.2\text{ °C}$ –), have a high intrinsic error in its determination, and that minor components (e.g. methanol) can cause a significant reduction in the flash point of the simulated biodiesel. Additionally in the case of palm oil, the number of empirical data is only two. This provokes a huge confidence interval (from 72 to 265 °C) which makes it impractical to use as a comparison basis.

The cold flow properties such as CFPP and CP have been simulated using the appropriate models shown in Table 3. The comparison between experimental and simulated data is shown in Table 6. In these cases the results show an important deviation from the experimental data. A probable reason for these deviations is the relative simplicity of the mathematical models compared with the complexity of the phenomenon involved. A more suitable set of data would be necessary in order to generate new models that could represent more properly the experimental observations.

Other simulated physical properties are shown in Table 6 compared with experimental data reported in bibliography. In this case, the composition of triglycerides for soybean and palm were taken from Ramos et al. (2009).

4. Conclusions

Process simulators have been proved to be a versatile tool to simulate and foresee the properties that a given biodiesel will show, knowing the composition of the oil feedstocks or blends of them. It opens the door to the simulation of other even more interesting feedstocks like used-cooking oil, animal tallow or urban solid wastes that could be mixed with vegetal virgin oils in order to enhance the properties of biodiesel. Thirteen parameters contained in standard EN-14214 have been calculated throughout this work (four shown more-in-depth). Most of them can be considered well suited to experimental data found in literature.

Acknowledgement

Financial aid for the development of this work has been provided by the “Convocatoria propia de proyectos de investigación” program of the Universidad de Zaragoza (UZ2008-TEC-04) (Spain).

References

- Albuquerque, M.C.G., Machado, Y.L., Torres, A.E.B., Azevedo, D.C.S., Cavalcante Jr., C.L., Firmiano, L.R., Parente Jr., E.J.S., 2009. Properties of biodiesel oils formulated using different biomass sources and their blends. *Renewable Energy* 34, 857–859.
- Alptekin, E., Canakci, M., 2008. Determination of the density and the viscosities of biodiesel–diesel fuel blends. *Renewable Energy* 33, 2623–2630.
- Andreatta, A.E., Casás, L.M., Hegel, P., Bottini, S.B., Brignole, E.A., 2008. Phase equilibria in ternary mixtures of methyl oleate, glycerol, and methanol. *Industrial and Engineering Chemistry Research* 47, 5157–5164.
- Antolín, G., Tinaut, F.V., Briceño, Y., Castaño, V., Pérez, C., Ramírez, A.I., 2002. Optimisation of biodiesel production by sunflower oil transesterification. *Bioresource Technology* 83, 111–114.
- Benjumea, P., Agudelo, J., Agudelo, A., 2008. Basic properties of palm oil biodiesel–diesel blends. *Fuel* 87, 2069–2075.
- Berrios, M., Siles, J., Martin, M.A., Martin, A., 2007. A kinetic study of the esterification of free fatty acids (FFA) in sunflower oil. *Fuel* 86, 2383–2388.
- Canakci, M., Van Gerpen, J., 2001. Biodiesel production from oils and fats with high free fatty acids. *Transactions of the ASAE* 44, 1429–1436.
- Catoire, L., Paulmier, S., Naudet, V., 2006. Estimation of closed cup flash points of combustible solvent blends. *Journal of Physical and Chemical Reference Data* 35, 9–14.
- Clements, L.D., 1996. Blending rules for formulating biodiesel fuel. Liquid fuel and industrial products from renewable resources. In: *Proceedings of the 3rd Liquid Fuels Conference* organized by ASAE, Nashville, TN, USA, p. 44.
- Crabbe, E., Nolasco-Hipolito, C., Kobayashi, G., Sonomoto, K., Ishizaki, A., 2001. Biodiesel production from crude palm oil and evaluation of butanol extraction and fuel properties. *Process Biochemistry* 37, 65–71.
- Demirbas, A., 2008. Relationships derived from physical properties of vegetable oil and biodiesel fuels. *Fuel* 87, 1743–1748.
- Demirbas, A., 2009. Progress and recent trends in biodiesel fuels. *Energy Conversion and Management* 50, 14–34.
- Di Felice, R., De Faveri, D., De Andreis, P., Ottonello, P., 2008. Component distribution between light and heavy phases in biodiesel processes. *Industrial and Engineering Chemistry Research* 47, 7862–7867.
- Encinar, J.M., Gonzalez, J.F., Rodriguez-Reinares, A., 2005. Biodiesel from used frying oil. Variables affecting the yields and characteristics of the biodiesel. *Industrial and Engineering Chemistry Research* 44, 5491–5499.
- Gani, R., Constantinou, L., 1996. Molecular structure based estimation of properties for process design. *Fluid Phase Equilibria* 116, 75–86.
- Gess, M.A., Danner, R.P., Nagvekar, M., 1991. *Thermodynamic Analysis of Vapor–Liquid Equilibria: Recommended Models and Standard Database*. American Institute of Chemical Engineers.
- Glicic, S., Skala, D., 2009. The problems in design and detailed analyses of energy consumption for biodiesel synthesis at supercritical conditions. *The Journal of Supercritical Fluids* 49, 293–301.
- Guo, Y., Wei, H., Yang, F., Li, D., Fang, W., Lin, R., 2009. Study on volatility and flash point of the pseudo binary mixtures of sunflowerseed-based biodiesel + ethanol. *Journal of Hazardous Materials* 167, 625–629.
- Hankinson, R.W., Thomson, G.H., 1979. New correlation for saturated densities of liquids and their mixtures. *AIChE Journal* 25, 653–663.
- Imahara, H., Minami, E., Saka, S., 2006. Thermodynamic study on cloud point of biodiesel with its fatty acid composition. *Fuel* 85, 1666–1670.
- Krisnangkura, K., Yimsuwan, T., Pairintra, R., 2006. An empirical approach in predicting biodiesel viscosity at various temperatures. *Fuel* 85, 107–113.
- Kumar Tiwari, A., Kumar, A., Raheman, H., 2007. Biodiesel production from jatropha oil (*Jatropha curcas*) with high free fatty acids: an optimized process. *Biomass and Bioenergy* 31, 569–575.
- Lee, K.W., Yu, J.X., Yan, L., Kim, Y.W., Chung, K.W., 2007. A kinetic study on the transesterification of glyceryl monooleate and soybean used frying oil to biodiesel. *Journal of Industrial and Engineering Chemistry* 13, 799–807.
- Lotero, E., Liu, Y.J., Lopez, D.E., Suwannakarn, K., Bruce, D.A., Goodwin, J.G., 2005. Synthesis of biodiesel via acid catalysis. *Industrial and Engineering Chemistry Research* 44, 5353–5363.
- Moser, B.R., 2008. Influence of blending canola, palm, soybean, and sunflower oil methyl esters on fuel properties of biodiesel. *Energy and Fuels* 20, 4301–4306.
- Pinzi, S., Garcia, I.L., Lopez-Gimenez, F.J., de Castro, M.D.L., Dorado, G., Dorado, M.P., 2009. The ideal vegetable oil-based biodiesel composition: a review of social, economical and technical implications. *Energy and Fuels* 23, 2325–2341.
- Rackett, H.G., 1970. Equation of state for saturated liquids. *Journal of Chemical and Engineering Data* 15, 514.
- Ramos, M.J., Fernández, C.M., Casas, A., Rodríguez, L., Pérez, Á., 2009. Influence of fatty acid composition of raw materials on biodiesel properties. *Bioresource Technology* 100, 261–268.
- Rashid, U., Anwar, F., Moser, B.R., Ashraf, S., 2008. Production of sunflower oil methyl esters by optimized alkali-catalyzed methanolysis. *Biomass and Bioenergy* 32, 1202–1205.
- Tang, H., Salley, S.O., Simon Ng, K.Y., 2008. Fuel properties and precipitate formation at low temperature in soy-, cottonseed-, and poultry fat-based biodiesel blends. *Fuel* 87, 3006–3017.
- Tate, R.E., Watts, K.C., Allen, C.A.W., Wilkie, K.I., 2006. The densities of three biodiesel fuels at temperatures up to 300 °C. *Fuel* 85, 1004–1009.
- Vicente, G., Martínez, M., Aracil, J., 2007. Optimisation of integrated biodiesel production. Part II: a study of the material balance. *Bioresource Technology* 98, 1754–1761.
- West, A.H., Posarac, D., Ellis, N., 2007. Simulation, case studies and optimization of a biodiesel process with a solid acid catalyst. *International Journal of Chemical Reactor Engineering* 5, A37.
- Zhang, Y., Dubé, M.A., McLean, D.D., Kates, M., 2003. Biodiesel production from waste cooking oil: 1. Process design and technological assessment. *Bioresource Technology* 89, 1–16.
- Zhou, W.Y., Boocock, D.G.B., 2006. Phase distributions of alcohol, glycerol, and catalyst in the transesterification of soybean oil. *Journal of the American Oil Chemists Society* 83, 1047–1052.

Artículo II

Water Cleaning of Biodiesel. Effect of Catalyst Concentration, Water Amount, and Washing Temperature on Biodiesel Obtained from Rapeseed Oil and Used Oil

Alberto Gonzalo,^{*,†} Manuel García,[†] José Luis Sánchez,[†] Jesús Arauzo,[†] and José Ángel Peña[‡]

Thermochemical Processes Research Group and Catalysis, Molecular Separations and Reactor Engineering Group, Aragón Institute of Engineering Research (I3A), Universidad de Zaragoza, Mariano Esquillor s/n, Ed. I+D, 50018 Zaragoza, Spain

The effect of changing the NaOH wt % (0.7–0.9%) in the transesterification, the amount of water (30–90 wt % of the biodiesel), and the temperature (40–60 °C) in the water cleaning step of biodiesel has been investigated, specifically the influence of these factors on some properties (acidity, viscosity and density) and contaminants (methanol, Na, glycerine, water, and glycerides) of the resulting biodiesel produced from two different oils (rapeseed and used frying oil) using a three factor-two level experimental design, and statistical analysis by ANOVA of the results. The biodiesels produced from both oils show very similar trends: methanol, sodium, and glycerine are almost completely removed from the biodiesel phase in one single step, whereas the glycerides content is not affected by the washing conditions. Viscosity and density are only very slightly affected by the washing step. The water content of the biodiesel is affected by both the water amount used and the temperature in an inverse way: the higher the temperature and the lower the water amount used in the cleaning step, the higher the water content in biodiesel. This washing step was also simulated in Aspen HYSYS V7.0 software. Using the NRTL thermodynamic package for properties calculation, the results obtained showed a reasonable agreement with experimental ones, although it should be improved for a better calculation of biodiesel final properties.

1. Introduction

In recent years global warming and environmental pollution have become major global issues. The use of fuels coming from biomass such as biodiesel and bioethanol can help to mitigate such issues because of the renewable features of these energy sources.

The above-mentioned bioproducts are the most important biofuels employed up-to-date in the transport sector. Both can be utilized alone, in special motor engines or as additives in fossil diesel and gasoline blends. Actually, biodiesel exhibits many benefits as an alternative fuel: it is derived from a renewable source, its biodegradability and lower ecotoxicity contribute to its beneficial character compared to petroleum-based diesel. Furthermore, biodiesel has a more favorable combustion emission profile, such as low emission of carbon monoxide, particulate matter and unburned hydrocarbons.¹

Biodiesel is a mixture of monoalkyl esters of long chain fatty acids derived from renewable lipid feedstock. In order to carry out this reaction, vegetal oils as well as some kinds of animal tallows, fresh or reused, are forced to react with a short chain alcohol (methanol or ethanol mainly). The products obtained are, depending on the materials employed, fatty acid methyl esters (FAME), fatty acid ethyl esters (FAEE), etc. Due to its lower price, compared to that of ethanol, methanol is the most commonly used alcohol in biodiesel production. European countries are leaders in the production of biodiesel, with Germany being the first producer in the UE.² The most employed vegetable oils are rapeseed, soybean, and sunflower oils. On the other hand, palm oil is considered an excellent

feedstock for biodiesel production in tropical countries such as Thailand, Malaysia, and Colombia.^{3,4}

Transesterification reaction has been traditionally catalyzed by alkali (NaOH or KOH)^{5–7} in a homogeneous reaction, which is the most widespread industrial process. Alternative transesterification methods such as using acid (as H₂SO₄),^{8,9} enzymes,^{10,11} heterogeneous catalysts,^{12–15} or under supercritical conditions,^{16,17} are under research.

After the transesterification reaction and the separation of biodiesel from the glycerine phase, a non miscible byproduct from the reaction, biodiesel must be further processed in order to fulfill cleaning conditions established by relevant standards, such as EN 14214 (EU) or ASTM 6751–07 (USA). Although different cleaning methods are under research (as the use of silica gel,^{18,19} hollow fiber membranes,^{20,21}), at industrial level processes, dry (using ion exchange resins or magnesium silicate to neutralize impurities)²² and wet washing are used. Typically wet washing involves one or more steps of water–biodiesel contact, either acidified or not. The presence of unconverted triglycerides, diglycerides, monoglycerides, glycerol, water, and many other undesired substances such as remains of catalyst, sterol glucosides,²³ and natural antioxidants²⁴ could cause significant engine damage by the consequent loss of power, or even mechanical damage. Therefore, the purification steps are among the most important issues for biodiesel production.

In this work, the change in the content of some contaminants (water, Na, glycerine, glycerides, and methanol) and properties (density, viscosity, and acidity) of biodiesel produced with methanol and two different oils (rapeseed and used frying oil) has been experimentally studied varying the NaOH wt % in the transesterification reaction, the amount of water used in a single cleaning step and the washing temperature.

On the other hand, the suitability of two thermodynamic prediction models (NRTL and UNIQUAC) has been tested by

* To whom correspondence should be addressed. E-mail: agonca@unizar.es.

[†] Thermochemical Processes Research Group.

[‡] Catalysis, Molecular Separations and Reactor Engineering Group.

Table 1. Fatty Acid Composition (% wt)^a

fatty acid	experimental rapeseed oil	simulated rapeseed oil	used frying oil	simulated used frying oil
C12:0	0.01		0.05	
C14:0	0.08	0.10	0.35	0.37
C15:0	0.36		0.04	
C15:1	0.01		0.01	
C16:0	8.82	11.21	13.83	14.64
C16:1	0.43		1.00	
C17:0	0.42		0.56	
C17:1	1.58		0.8	
C18:0	4.76	6.05	6.44	6.82
C18:1	71.84	74.77	55.12	58.36
C18:2	6.19	7.87	18.71	19.81
C18:3	0.74		0.22	
C20:0	0.97		0.38	
C20:1	1.47		1.46	
C20:3	0.45		0.07	
C20:5	0.71		n.d.	
C21:0	n.d.		0.05	
C22:0	n.d.		0.39	
C24:0	1.48		0.29	
C22:6	0.00		0.23	

^a n.d.: not detected.

comparing the experimental results with the values estimated with a simulation tool (Aspen HYSYS V7.0 and Aspen Properties V7.0 software). Such a simulation is very useful for the economic assessment of the process^{25–31} but could also be used for operational logistics and production optimization.^{32,33}

2. Experimental Section

2.1. Biodiesel Preparation. Two different oils were used in the experimental work, rapeseed oil and domestic frying used oil. Fatty acid distribution can be found in Table 1. Used oil was filtered and heated at 120 °C to remove moisture. Acid values of the oils were 1.1 and 1.3 mg KOH/kg for rapeseed and used oil respectively. Prior to the transesterification reaction, a methanol esterification reaction step was carried out for both oils, with the following conditions: 60 °C, alcohol:acid ratio 33:1, sulphuric acid as catalyst, 1 wt % of oil, 2 h reaction time. 500 g of oil were used for the reaction, and afterward, the esterified oils were washed at 60 °C with 150 g of glycerine for 30 min under agitation, the glycerine phase was separated, and water was removed in a rotary evaporator. After the esterification, the acid values of rapeseed and used oils were 0.5 and 0.7 mg KOH/kg of oil respectively.

Esterification and the subsequent transesterification reaction were carried out in a batch stirred reactor of 1 L volume equipped with a reflux condenser, where a cooled fluid is recirculated, and a mechanical stirrer. Stirrer speed was kept at 1000 rpm in order to avoid mass transfer limitations.

Sodium hydroxide was used as the homogeneous catalyst for the transesterification reaction. Its concentration was varied between 0.7 and 0.9 wt % based on the used oil. Methanol was used in a 6:1 molar ratio to oil. Prior to the experiment, a defined amount of sodium hydroxide was dissolved in about 50 g of methanol and later mixed with the rest of methanol to be used. Oil was first introduced in the reactor, and when the temperature of 60 °C was reached, the solution of NaOH in methanol was filled into the reactor. The reaction was carried out for 90 min, in order to ensure a high conversion.

Once the reaction was stopped, the reactor content was transferred to a decanting funnel, where the mixture of biodiesel and glycerine was allowed to separate at ambient temperature for 12 h.

Table 2. Factors Used

factor	coded factor	actual range	coded range
NaOH	x_1	0.7% 0.8% 0.9%	-1 0 +1
water	x_2	30% 60% 90%	-1 0 +1
washing temperature	x_3	40 °C 50 °C 60 °C	-1 0 +1

2.2. Water Washing. A single washing step with water was carried out in the same reaction vessel, under agitation but without reflux condenser, for 30 min. At this time it was checked that it was enough to get a steady concentration of the different compounds measured, and the same time effect was observed in a different work.²² The influence of water amount and washing temperature was studied in the range of 30–90 wt % water related to the biodiesel sample and 30–60 °C.

2.3. Analytical Methods. Reagents used during biodiesel synthesis and purification steps were: methanol (assay (GLC) \geq 99.9%, Carlo Erba Reagents), sulphuric acid (96%), sodium hydroxide and glycerine were supplied by Panreac. Dissolution of methyl heptadecanoate (standard for GC, Fluka Analytical) in heptane (standard for GC, Fluka Analytical) was used as internal standard for the GC determinations.

Biodiesel quality was evaluated according to the European biodiesel standard EN 14214 (2003): (i) density according to the standard EN 12185; (ii) kinematic viscosity at 40 °C, using glass capillary viscometers according to the standard ISO 3104 (1994); (iii) methyl ester contents, by GC according to the standard EN 14103 (2003); (iv) water content, by Karl Fischer coulometric titration according to the standard EN ISO 12937 (2003); (v) acid value, by volumetric titration according to the standard EN 14104 (2003); (vi) methanol was determined by headspace gas chromatography following the method described in EN 14110:2003; (vii) sodium content was determined according to the European standard EN 14108:2003; and (viii) total glycerine and mono-, di-, and triglycerides were determined by gas chromatography following the methods described in norm EN 14105:2003.

Methyl esters were determined using gas chromatography with a flame ionization detector (GC-FID) system, an Agilent 6890 Series GC System gas chromatograph, with a DB-225 MS (Agilent) column (30 m \times 0.25 mm \times 0.25 μ m). The injector temperature was set at 250 °C, and the detector (FID) temperature was set at 250 °C. The used carrier gas was He with a flow of 1 mL/min. Injection was made in a split mode, using a split flow ratio of 35:1, and the volume injected was 1 μ L. The following temperature program was used: 170 °C, then 3 °C/min to 203 °C, then 1.5 °C/min to 214 °C, then 5 °C/min to 230 °C, and holding at that temperature for 16 min.

2.4. Experimental Design. The influence of the NaOH amount used in the transesterification reaction, the water amount and the washing temperature was studied by means of a full factorial (2^3) experimental design, using 3 replicates of the center point (0.8 wt % of NaOH, 45 °C and 60 wt % of water) to evaluate the experimental error, giving a total of 11 experiments. Analysis of variance (ANOVA) was carried out to discriminate the effect, if present, of the experimental factors (NaOH, water amount and washing temperature), by means of the F-test, with a confidence level of 95% ($\alpha = 5\%$).³⁴ Table 2 shows the actual and coded factors used. In coded notation all of the factors vary between -1 and +1, with 0 being the central point. This notation allows for a quick comparison of the influence each factor exerts on the

Table 3. Biodiesel Properties and Contaminants before Washing

	oil					
	rapeseed			used		
NaOH %	0.7	0.8	0.9	0.7	0.8	0.9
acidity (mg KOH/g)	0.14	0.17	0.14	0.10	0.12	0.10
viscosity at 40 °C (mm ² /s)	4.0	4.1	4.1	4.1	4.1	4.3
density at 15 °C (kg/m ³)	880	881	881	879	881	880
water (ppm)	1055.8	1061.8	948.8	772.4	1005.2	1010.3
sodium (mg/kg)	203.8	243.2	256.8	254.7	144.4	259.0
methanol (%)	5.02	4.80	4.79	0.89	4.67	4.61
glycerides (%)	0.38	0.38	0.46	0.32	0.29	0.32
glycerine (%)	0.31	0.05	0.05	0.004	0.04	0.10

observed variables, regardless of the change of the factor. Levels of the factors were chosen as standard values used in the available literature. Naik et al.³⁵ used a catalyst concentration of 1 wt % of oil at 65 °C, Ghadge & Raheman³⁶ used 0.7 wt % KOH as alkaline catalyst, others authors^{37,38} have reported similar transesterification conditions. Berrios & Skelton²² used 0.5:1 to 1:1 water:biodiesel ratio and ambient temperature to 60 °C. He et al.²¹ worked at 1:1 ratio, using three washing steps, and temperatures of 20 to 80 °C. Petrojevic¹⁹ used a higher water:biodiesel ratio and 50 °C. Karaosmanoğlu et al.³⁹ used 1:1 water:biodiesel ratio in three steps and 50 to 80 °C, concluding that 50 °C is the best temperature.

The influence of the operating conditions (wt % of NaOH, washing temperature and water amount) has been studied for three properties—viscosity, density, and acidity—and five contaminants in biodiesel—water, sodium, methanol, glycerides (the sum of mono-, di-, and triglycerides), and glycerine.

3. Results and Discussion

3.1. Effect of the Washing Step. In Table 3, the values of the different properties and contaminant concentration in the biodiesel phase are shown after the transesterification step. Those

values are very similar for the biodiesels prepared from the two oils. The NaOH percentage used in the transesterification reaction does not seem to exert any influence either. Acidity is slightly smaller for the used-oil biodiesel, although the acid value of the used oil is higher than the one of rapeseed oil. Regarding the values obtained after the washing step, in Tables 4 and 5, acidity of the biodiesel increased after the water cleaning, thus indicating that remaining Na in the biodiesel phase can neutralize part of the present acid.

Viscosity of the biodiesels also increases after water washing, which indicates that lower viscosity compounds, as can be in the case of methanol, are removed in the cleaning step. Density is not affected by the transesterification conditions. After the water washing step, the biodiesel density is about 2 kg/m³ higher.

Water in the two oils was 574 ppm (rapeseed) and 193 ppm (used oil). After the transesterification reaction, water content of the biodiesels produced ranged from 800 to 1000 ppm approximately, as shown in Table 3. After the washing step, some biodiesel samples increase their water content, whereas in other it diminishes. As an example, it can be observed that, before washing, biodiesel produced from rapeseed oil with a catalyst concentration of 0.7 wt % had 1055.8 water ppm. After washing this biodiesel at 40 °C with 30 wt % of water, water amount slightly decreases to 1115, whereas using 90 wt % of water in the washing step, it diminishes to 573 ppm. Washing the same biodiesel at 60 °C with 30 wt % of water, 870 ppm of water are detected, whereas using 90 wt % of water, a water content of 1377 ppm is measured. The same behavior is observed for biodiesel produced from used oil. As water solubility in biodiesel is very small, and the amount of water is enough to saturate the biodiesel, these trends can be attributed to the interaction of different compounds present, which change the equilibrium between both phases.

Table 4. Rapeseed Biodiesel Properties and Contaminants after Washing^a

% NaOH	T ^a (°C)	% water	acidity (mg KOH/g)		viscosity at 40 °C (mm ² /s)		water (ppm)		Na (ppm)	methanol (%)
			exp.	sim.	exp.	sim.	exp.	sim.	sim.	sim.
0.7	40	30	0.31	0.15	4.54	4.67	1115.1	1128.2	37.2	0.68
			0.50	0.15	4.42	4.69	573.1	773.8	13.9	0.27
	60	30	1.16	0.15	4.80	4.68	1377.5	1287.6	37.5	0.63
			1.56	0.15	4.56	4.70	870.5	951.2	14.2	0.25
0.9	40	30	0.51	0.15	4.39	4.69	964.3	1113.5	46.9	0.66
			0.57	0.15	4.58	4.70	1140.1	761.8	17.5	0.26
	60	30	0.71	0.15	4.30	4.69	1259.4	1289.4	47.6	0.61
			1.02	0.15	4.74	4.71	1413.4	932.4	17.8	0.24
0.8	50	60	0.45	0.18	4.47	4.70	1023.3	933.2	24.3	0.36
			0.44		4.46		1098.7			
			0.49		4.48		1081.2			

^a Exp.: experimental data; Sim.: simulated data using NRTL thermodynamic model.

Table 5. Used-oil Biodiesel Properties and Contaminants after Washing

% NaOH	T ^a (°C)	% water	acidity (mg KOH/g)		viscosity at 40 °C (mm ² /s)		water (ppm)		Na (ppm)	methanol (%)
			exp.	sim.	exp.	sim.	exp.	sim.	sim.	sim.
0.7	40	30	0.24	0.10	4.50	4.59	1236.6	1133.0	44.18	0.64
			0.45	0.11	4.56	4.61	950.5	794.4	16.47	0.25
	60	30	0.51	0.10	4.53	4.60	1124.5	1313.2	45.07	0.59
			0.93	0.11	4.66	4.61	830.1	974.2	16.89	0.23
0.9	40	30	0.29	0.10	4.56	4.59	970.4	1132.6	45.02	0.64
			0.62	0.11	4.58	4.61	870.0	787.3	16.73	0.25
	60	30	0.73	0.10	4.56	4.60	1218.9	1314.4	45.94	0.59
			1.36	0.11	4.56	4.61	1233.6	965.5	17.15	0.23
0.8	50	60	0.70	0.13	4.61	4.61	998.9	959.0	13.72	0.35
			0.48		4.56		1127.2			
			0.48		4.55		1028.3			

Table 6. Relative Influence of Washing Conditions on Biodiesel from Rapeseed Oil

property	exp./sim.	average	x_1	x_2	x_3	interactions
acidity (mg KOH/g)	exp.	0.79	-0.09	0.12	0.32	$-0.03 \cdot x_1 \cdot x_2$, $0.16 \cdot x_1 \cdot x_3$, $0.06 \cdot x_2 \cdot x_3$
	sim.	0.15 ± 0.01	<i>a</i>	<i>a</i>	<i>a</i>	<i>a</i>
viscosity at 40 °C (mm ² /s)	exp.	4.54	-0.04	0.04	0.06	$0.12 \cdot x_1 \cdot x_2$, $0.04 \cdot x_1 \cdot x_3$, $0.02 \cdot x_2 \cdot x_3$, $0.05 \cdot x_1 \cdot x_2 \cdot x_3$
	sim.	4.69 ± 0.01	<i>a</i>	<i>a</i>	<i>a</i>	<i>a</i>
water (ppm)	exp.	1053.6	18.9	-83.3	45.5	$61.9 \cdot x_1 \cdot x_2$, $105.6 \cdot x_1 \cdot x_3$
	sim.	1029.7	<i>a</i>	-174.9	85.4	<i>a</i>
Na (ppm)	sim.	28.6	3.4	-13.2	<i>a</i>	<i>a</i>
methanol (%)	sim.	0.45	<i>a</i>	-0.19	<i>a</i>	<i>a</i>

^a Not significant.

The basic catalyst is known to distribute between the glycerine and FAME phases,^{40,41} preferably in the glycerine phase as the polar nature of this compound can dissolve a strong electrolyte better than in the FAME phase. In the work of Chiu et al.⁴⁰ the distribution of KOH and H₂SO₄ was studied, finding that the amount of both electrolytes increases in the biodiesel phase if the amount of methanol is increased. Zhou and Boocok⁴¹ found that using 1 wt % NaOH as catalyst, similar to the concentration used in this work, a concentration of 0.06 wt % of NaOCH₃ in the biodiesel phase, which means 260 mg Na/kg, very close to the values shown in Table 3. After washing, the amount of sodium remaining in the biodiesel is negligible, smaller than 1 mg/kg, which is the detection limit of the method, for all the conditions tested. This indicates that, under good mixing and with enough time, one single washing step is sufficient to clean biodiesel of this contaminant.

Methanol is a component that also distributes between the two phases, except for the methanol measured in one experiment (used oil, 0.7 wt % NaOH), the rest of the methanol concentrations measured in the FAME phase before the water washing step are around 5 wt %. These values are similar to the ones measured by Chiu et al.,⁴⁰ Zhou and Boocook,⁴¹ Di Felice et al.,⁴² Komers et al.,⁴³ and Ma et al.,⁴⁴ which are in the range of 3–6 wt % of alcohol in the biodiesel phase in the conditions reached in our reactions. The effect of washing is similar to the one observed for the sodium, the amount of methanol remaining in the biodiesel phase is negligible, around 0.01 wt %, which means that a single washing step reduces this contaminant up to the limit required by standard EN 14214. This is in agreement with previous findings^{42,45} which show that methanol is found preferably in the heavy phase due to its polarity.

The amount of glycerides in the biodiesel does not significantly change after the washing step or between different experimental conditions, being 0.39 ± 0.02 for rapeseed oil biodiesel and 0.30 ± 0.01 for used oil biodiesel. Before washing the content of glycerides was 0.41 ± 0.11 for rapeseed and 0.31 ± 0.04 for used oil biodiesel. This is logical, attending to their nonpolar nature. It could be expected that they will not dissolve in significant amounts in the water phase.

Small amounts of glycerine are also found in the biodiesel phase, due to its polarity. The concentration found in the two biodiesels (rapeseed and used oil) produced in this work are similar to the observed in the binary mixture by Di Felice et al.⁴² at 20 °C, 0.08 wt %. Zhou and Boocock⁴¹ found a higher amount, 0.21 wt %, in ternary mixtures (biodiesel–glycerine–methanol), and Andreatta et al.⁴⁶ only found glycerine in the biodiesel phase at 20 °C when methanol is 50 wt % in the ternary mixture methyl oleate–glycerine–methanol. The presence of other compounds, such as monoglycerides,⁴⁷ and the chemical nature of the methyl esters in biodiesel⁴⁸ also affects the solubility of glycerine in the biodiesel phase. Anyway, although the solubility of glycerine in biodiesel is small, it is

enough to be out of the specification of standard EN 14214, 0.02 wt %. Being a polar compound and water miscible, a single washing step, even in the mildest conditions tested, reduces the glycerine content of the biodiesel phase in an order of magnitude, close to the detection level.

3.2. Effect of the Washing Conditions. As it has been commented in the previous section, the effect of a single water washing step on some properties has a very small or negligible effect. Thus density only increases by 2 kg/m³ after washing, from 880 to 882 kg/m³, for both biodiesels, although statistically significant this is a very small change to take into account, and the glycerides content remains unchanged. The presence of the polar contaminants in biodiesel sodium, methanol and glycerine is reduced to a very low level, much lower than the limits imposed by standard EN 14214, using 30 wt % of water (respect to the weight of biodiesel) and 40 °C. This means that, to fulfill the requirements of that standard, in ideal conditions, possibly even a lower amount of water or temperature could be used, which would be better for the economy of the process and generate a smaller amount of water to be treated.

In Tables 4 and 5 the values of acidity, viscosity, and water content of biodiesel obtained from rapeseed and used oil, respectively, are shown, because they show statistically significant trends regarding the experimental conditions used. As it can be observed, these three properties behave differently depending on the oil used. In Figures 1–3 the observed trends of acidity, viscosity and water content are shown for the biodiesel made of rapeseed oil. Rapeseed biodiesel shows more clearly the effect of the washing conditions, due to the better repetitivity of the central point experiments. Tables 6 and 7 show the relative influence of each factor over the calculated average value experimentally obtained. Thus the change on each property or contaminant by changing from 0 to 1 the coded factor can

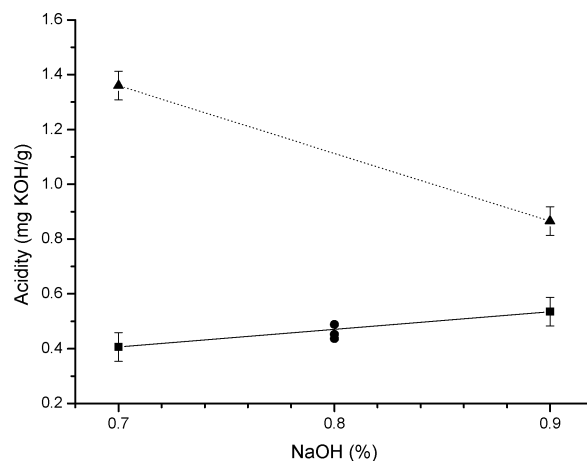

Figure 1. Acidity trend of rapeseed oil biodiesel after washing. ■ 40 °C, ▲ 60 °C, ● central point experiments (0.8% NaOH, 60% water, and 50 °C).

Table 7. Relative Influence of Washing Conditions on Biodiesel from Used Oil

property	exp./sim.	average	x_1	x_2	x_3	interactions
acidity (mg KOH/g)	exp.	0.64	0.11	0.20	0.24	<i>a</i>
	sim.	0.11 ± 0.01	<i>a</i>	<i>a</i>	<i>a</i>	<i>a</i>
viscosity at 40 °C (mm ² /s)	exp.	4.53 ± 0.03	<i>a</i>	<i>a</i>	<i>a</i>	<i>a</i>
	sim.	4.60 ± 0.01	<i>a</i>	<i>a</i>	<i>a</i>	<i>a</i>
water (ppm)	exp.	1089.2	105.1	-89.9	141.0	$172.4 \cdot x_1 \cdot x_2$
	sim.	1051.7	<i>a</i>	-171.5	90.0	<i>a</i>
Na (ppm)	sim.	28.8	<i>a</i>	-13.9	<i>a</i>	<i>a</i>
methanol (%)	sim.	0.43	<i>a</i>	-0.19	<i>a</i>	<i>a</i>

^a Not significant.

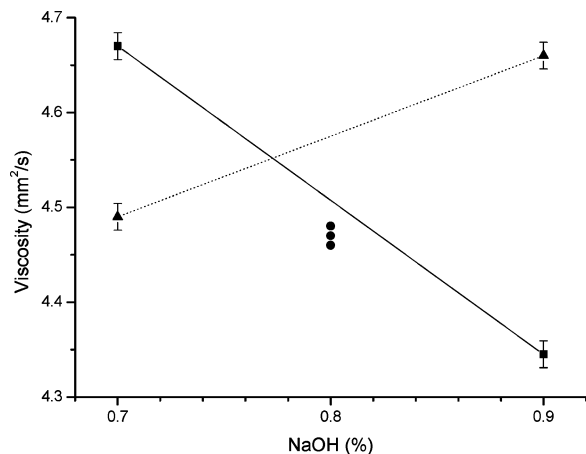

Figure 2. Viscosity trend of rapeseed oil biodiesel after washing. ■ 30% water, ▲ 90% water, and ● central point experiments (0.8% NaOH, 60% water, and 50 °C).

be compared with the change caused by the other factors. The different change observed when one factor is kept at the -1 level or at the +1 level is represented by the interactions column. Regarding the influence of the single factors, the NaOH wt % used in the transesterification is the less important, as its relative influence in Tables 6 and 7 shows the smallest coefficient of the three. Overall, washing temperature is the most significant single factor, only in the water content of rapeseed biodiesel, the effect of changing the water wt % in the washing step shows a greater influence than the washing temperature.

Acidity of rapeseed methyl ester is mainly influenced by washing temperature, increasing with temperature increases. It also shows a significant interaction between NaOH wt % used and washing temperature, as shown in Figure 1: at 60 °C the higher the NaOH wt %, the lower the acidity of the biodiesel, whereas at 40 °C, the acidity increases slightly.

The average acidity of used oil biodiesel is lower than the measured for rapeseed oil biodiesel, and the opposite trend can be observed in the pre-esterified and esterified oils. This might be caused by collateral reactions happening during the washing step, as saponification of free fatty acids, which would be consumed by sodium present in the biodiesel in the presence of water. Anyway the presence of soap has not been detected. The trends observed with the three factors are similar to the ones observed with rapeseed methyl ester, only the NaOH wt % shows a different trend and no interactions are statistically significant.

The most significant factor affecting viscosity of rapeseed biodiesel is an interaction between NaOH wt % and water wt % used in the washing step. As shown in Figure 2 at 30 wt % water, the higher the NaOH wt % used in the transesterification, the lower the viscosity, whereas it increases when the biodiesel is washed at 60 °C. The viscosity of used oil methyl ester, on

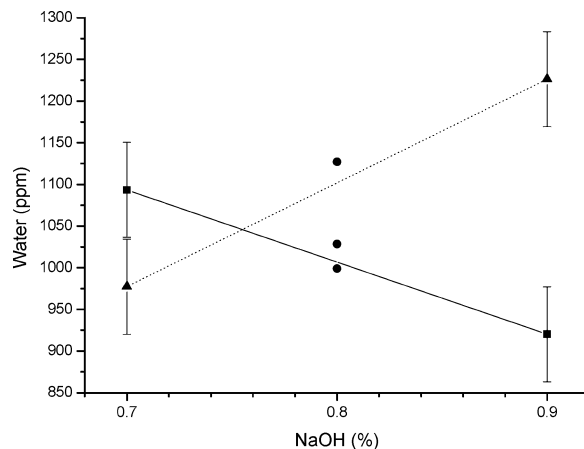

Figure 3. Water content trend of rapeseed oil biodiesel after washing. ■ 40 °C, ▲ 60 °C, ● central point experiments (0.8% NaOH, 60% water, and 50 °C).

the other hand, is not influenced by any of the experimental factors varied.

Water content of both biodiesels produced show very similar trends, although the relative importance of each factor is different: it increases by increasing the NaOH wt % used in the transesterification and the washing temperature and diminishes when the water % used in the washing step is augmented. This could mean that the water remaining in the biodiesel phase is related to the presence of other contaminants, probably of polar nature, than would be present in a higher concentration in the methyl ester phase when less water is used in the cleaning step. The increase in the water content of biodiesel when the washing temperature is increased was also observed by Karaosmanoğlu et al.:³⁹ water content of rapeseed biodiesel increased from 700 to 1600 ppm when the washing temperature increased from 50 to 80 °C. The effect of the NaOH wt %-washing temperature interaction is shown in Figure 3.

4. Theoretical Calculations

In this part, different thermochemical models were used in order to test if the observed trends could be reproduced by these models.

Modeling of biodiesel production focused on several published works. In these articles, alkali- and acid-catalyzed systems^{25,26,32} were largely simulated. Similarly, heterogeneous catalyzed process⁴⁹ and supercritical^{27,29,30} conditions method for biodiesel production were also simulated. The main goal of these studies is the economic assessment.^{28,31} Nevertheless the prediction of properties is an important aim. In this paper we have performed a simulation of the biodiesel washing step in order to obtain the biodiesel physical properties and concentrations of several contaminants.

As in the cited works, commercial simulation software Aspen HYSYS, version V7.0, was used to perform the simulation. Process simulators are commonly used to provide reliable information on process operation owing to their component libraries, comprehensive thermodynamic packages and advanced computational methods.

The procedure for process simulations based on use Aspen HYSYS V7.0 mainly involves defining chemical components, selecting an appropriate thermodynamical package, defining the kinetics of the reactions and finally determining plant capacity and required equipment and operating conditions. In our case only the chemical components and thermodynamical package selection steps have been performed.

Biodiesel was simulated as a mixture of the five most abundant methyl esters, shown in Table 1, and the presence of triglycerides and acidity of the mixture were simulated using triolein and oleic acid respectively as key components, using the experimental values obtained shown in Table 3.

Information on most components can be found in Aspen HYSYS V7.0 component library which contained data for the following components: methanol, glycerol, sodium hydroxide, water, methyl oleate, methyl palmitate, methyl linoleate, methyl stearate, methyl myristate, oleic acid, and triolein.

The selection of the thermodynamic model has a strong influence on liquid–liquid equilibrium calculations, which makes this step especially important. The presence of polar compounds such as methanol and glycerol make the use of the nonrandom two liquids (NRTL) model or UNIQUAC model necessary, but great care must be taken in the estimation of missing binary coefficients. UNIFAC method is usually used in order to estimate the binary coefficients. In the present work, UNIFAC was used and the non calculated values were estimated using the Aspen PLUS Properties V7.0 software. NRTL and UNIQUAC models were compared. The results for UNIQUAC model are not presented due to their large deviation from experimental data; therefore, the NRTL model is the most used thermodynamic model in published literature.^{25,26,30–33}

Aspen HYSYS V7.0 provides some properties for itself such as density and viscosity, but kinematic viscosity must be corrected using tabular calculation options due to observed deviations between experimental and direct simulated biodiesel viscosities. Input values for the tabular calculation method were calculated using a kinematic viscosity model proposed by Krisnangkura et al.⁵⁰

Some considerations must be taken into account; the unreacted glycerides are simulated as triolein because it is the major component in simulated oils and other triglycerides are not available in the HYSYS V7.0 component library. These missing components can be added using the Hypo-component tool but this step is not necessary to obtain the influence of triglycerides and increases the simulation errors. The same argument is used to simulate the biodiesel acidity.

Another limitation is the presence of electrolytes such as NaOH, which is not supported by the selected thermodynamical package; nevertheless the results show a logical trend.

The washing step was simulated using a single stage L-L column where equilibrium conditions between the two phases, biodiesel and water, are attained, pressure drops in different equipment but in this study it was neglected.

The simulation was performed following the experimental scheme: for each experimental run the composition of the mixture was simulated before washing, the resulting stream was introduced in the L-L columns under each experimental condition with the correspondent stream of water (30, 60, or 90 wt % of the biodiesel stream), both at the temperature fixed in the experimental runs (40, 50, or 60 °C).

The simulated properties of the washed biodiesel are also shown in Tables 4 and 5, except for the ones that do not show a significant change. In Tables 6 and 7, the trends for the simulated values of the properties studied are shown, for its comparison with experimental trends. In order to obtain the trends from the simulated values, an ANOVA analysis has also been carried out.

The simulated densities of rapeseed and used oil biodiesel before washing are 876 and 877 kg/m³ close to the actual value of 880 kg/m³ obtained for both biodiesels. After the washing step, biodiesel simulated density increases to 880 kg/m³ being

the average density of 882 kg/m³. The glycerides content of the washed biodiesel calculated are similar to the ones introduced in the biodiesel composition, they increase a little as a consequence of the removal of most of the methanol, but they are not lost in the resulting water stream in significant amounts.

The calculated acidity of both biodiesels do not show any change with the washing step nor with the washing conditions. As it is introduced in the biodiesel stream as a component (oleic acid) that cannot interact with the NaOH, the observed acidity increase after washing can not be accurately simulated.

Viscosity calculation gives slightly higher values than the actual ones, but the differences are small, as can be observed in Tables 4–7.

The simulated water content of both rapeseed and used-oil biodiesel after washing follows a similar trend to the observed data, it diminishes when the amount of washing water is increased and increases when raising washing temperature. On the other hand, in the simulated data, the change in water content is more affected by the amount of water than by washing temperature, see Tables 6 and 7, no effect of the catalyst concentration on the results is observed (which is not surprising, as the presence of an electrolyte as NaOH is not handled properly by the thermodynamic packages currently available), and thus, the interactions observed experimentally between NaOH used and water or temperature (with the latter exerting the strongest influence on the experimental results) are not observed either.

The experimental content of MeOH after washing of both biodiesels produced is negligible, the simulated MeOH, shown in Tables 4 and 5, is also very small, between 0.2 and 0.8 wt %. In this case, the only trend observed in the simulated data is due to the amount of washing water. Neither NaOH nor washing temperature affect the simulated amount of methanol after washing. Regarding the MeOH limit established by standard EN 14214, 0.2 wt % by weight, for several simulated conditions, the predictions wrongly indicate that after washing, further methanol cleaning is needed, thus the simulation tool should be improved. On the other hand, the simulated glycerine content of the washed biodiesels is close to 0, so the distribution of this compound is calculated close to reality by Aspen HYSYS V7.0, as discussed in section 3.1. the glycerine content of the washed biodiesel samples is also negligible.

The simulated NaOH content of the washed biodiesels does not respond either to the experimental points. Although the distribution of this compound cannot be accurately predicted, the simulated compositions show that the amount of water used in the washing step is the most significant parameter (as it can be observed in Table 6 for rapeseed oil biodiesel and Table 7 for used oil biodiesel), decreasing the amount of NaOH in the biodiesel phase if a higher amount of water is used, which is logical due to the polar nature of water, whereas washing temperature does not influence the simulated Na concentration in the biodiesel phase.

5. Conclusions

In this work the water washing of two biodiesels produced from rapeseed oil and used frying oil was studied experimentally. The Aspen HYSYS V7.0 was used to simulate the cleaning step. In regards to the change in some properties and contaminants when the NaOH wt % used in the transesterification, the water amount and washing temperature change. For both biodiesels, polar compounds (methanol, NaOH and glycerine) are almost completely removed by a single water washing step in the conditions tested (30 to 90 wt % of water, 40 to 60 °C) when using 0.7 to 0.9 wt % of NaOH as basic homogeneous

catalyst. Whereas the content of glycerides is not changed significantly by the washing step. The amount of water in the biodiesel phase after the washing step decreases when the washing water is increased and temperature is decreased, although the effect of both factors, water wt % and temperature, depends on the NaOH wt % used, as strong interactions NaOH wt %/amount of water and NaOH wt %/temperature were observed. Biodiesel acidity, viscosity and density increase after the washing step, the increase in density is too small to take it into account. Viscosity of rapeseed biodiesel and acidity are slightly affected by the operating conditions, being temperature the most influential factor.

In order to simulate the biodiesel washing step, two thermodynamic calculation models, NRTL and UNIQUAC were tested using Aspen HYSYS simulation software. The NRTL model gives more accurate results. Anyway acidity is not predicted well, which could be due to a simplification in the biodiesel composition and the absence of interaction coefficients between NaOH and organic compounds. Viscosity, once the original calculation method of Aspen HYSYS V7.0 is corrected, it is calculated correctly, although no effect of operating conditions is predicted. Calculated water content is slightly smaller than the measured one, the observed effect of water amount and temperature are also well predicted, but not the interaction observed of those factors with NaOH. The Na and methanol content are overcalculated, indicating that better activity coefficients should be provided in the prediction models in order to get a better and more useful simulation tool.

Acknowledgment

The authors thank Prof. R. Bilbao, Head of the Thermochemical Processes Group, for supporting this work through funds provided by the Gobierno de Aragón to Research Groups, which is also acknowledged, and the funds provided by Universidad de Zaragoza (project UZ2008-TF-04). The laboratory work done by M. Araguas is highly appreciated.

Literature Cited

- (1) Makareviciene, V.; Janulis, P. Environmental effect of rapeseed oil ethyl ester. *Renew. Energy* **2003**, *28*, 2395.
- (2) Bozbas, K. Biodiesel as an alternative motor fuel: Production and policies in the European Union. *Renew. Sust. Energ. Rev.* **2008**, *12*, 542.
- (3) Johnston, M.; Holloway, T. A global comparison of national biodiesel production potentials. *Environ. Sci. Technol.* **2007**, *41*, 7967.
- (4) Sharma, Y. C.; Singh, B. Development of biodiesel: Current scenario. *Renew. Sust. Energ.* **2009**, *13*, 1646.
- (5) Freedman, B.; Butterfield, R. O.; Pryde, E. H. Transesterification Kinetics of Soybean Oil. *J. Am. Oil Chem. Soc.* **1986**, *63*, 1375.
- (6) Nouredini, H.; Zhu, D. Kinetics of transesterification of soybean oil. *J. Am. Oil Chem. Soc.* **1997**, *74*, 1457.
- (7) Mittelbach, M.; Trathnigg, B. Kinetics of Alkaline Catalyzed Methanolysis of Sunflower Oil. *Fat Sci. Technol.* **1990**, *92*, 145.
- (8) Zheng, S.; Kates, M.; Dubé, M. A.; McLean, D. D. Acid-catalyzed production of biodiesel from waste frying oil. *Biomass Bioenerg.* **2006**, *30*, 267.
- (9) Lotero, E.; Liu, Y. J.; Lopez, D. E.; Suwannakarn, K.; Bruce, D. A.; Goodwin, J. G. Synthesis of biodiesel via acid catalysis. *Ind. Eng. Chem. Res.* **2005**, *44*, 5353.
- (10) Li, N.-W.; Zong, M.-H.; Wu, H. Highly efficient transformation of waste oil to biodiesel by immobilized lipase from *Penicillium expansum*. *Process Biochem.* **2009**, *44*, 685.
- (11) Dizge, N.; Keskinler, B.; Tanriseven, A. Biodiesel production from canola oil by using lipase immobilized onto hydrophobic microporous styrene-divinylbenzene copolymer. *Biochem. Eng. J.* **2009**, *44*, 220.
- (12) Di Serio, M.; Cozzolino, M.; Giordano, M.; Tesser, R.; Patrono, P.; Santacesaria, E. From homogeneous to heterogeneous catalysts in biodiesel production. *Ind. Eng. Chem. Res.* **2007**, *46*, 6379.
- (13) Di Serio, M.; Cozzolino, M.; Tesser, R.; Patrono, P.; Pinzari, F.; Bonelli, B.; Santacesaria, E. Vanadyl phosphate catalysts in biodiesel production. *App. Catal. A-Gen.* **2007**, *320*, 1.
- (14) Lingfeng, C.; Guomin, X.; Bo, X.; Guangyuan, T. Transesterification of cottonseed oil to biodiesel by using heterogeneous solid basic catalysts. *Energy Fuels* **2007**, *21*, 3740.
- (15) Yan, S.; Salley, S. O.; Simon Ng, K. Y. Simultaneous transesterification and esterification of unrefined or waste oils over ZnO-L₂O₃ catalysts. *App. Catal. A-Gen.* **2009**, *353*, 203.
- (16) Madras, G.; Kolluru, C.; Kumar, R. Synthesis of biodiesel in supercritical fluids. *Fuel* **2004**, *83*, 2029.
- (17) Demirbas, A. Biodiesel production from vegetable oils via catalytic and non-catalytic supercritical methanol transesterification methods. *Prog. Energy Combust. Sci.* **2005**, *31*, 466.
- (18) Yori, J. C.; D'Ippolito, S. A.; Pieck, C. L.; Vera, C. R. Deglycerolization of Biodiesel Streams by Adsorption Over Silica Beds. *Energy Fuel* **2007**, *21*, 347.
- (19) Predojevic, Z. J. The production of biodiesel from waste frying oils: A comparison of different purification steps. *Fuel* **2008**, *87*, 3522.
- (20) Wang, Y.; Wang, X.; Liu, Y.; Ou, S.; Tan, Y.; Tang, S. Refining of biodiesel by ceramic membrane separation. *Fuel Process. Technol.* **2009**, *90*, 422.
- (21) He, H.; Guo, X.; Zhu, S. Comparison of membrane extraction with traditional extraction methods for biodiesel production. *J. Am. Oil Chem. Soc.* **2006**, *83*, 457.
- (22) Berrios, M.; Skelton, R. L. Comparison of purification methods for biodiesel. *Chem. Eng. J.* **2008**, *144*, 459.
- (23) Moreau, R. A.; Scott, K. M.; Haas, M. J. The identification and quantification of steryl glucosides in precipitates from commercial biodiesel. *J. Am. Oil Chem. Soc.* **2008**, *85*, 761.
- (24) Tang, H. Y.; De Guzman, R. C.; Salley, S. O.; Ng, K. Y. S. Formation of insolubles in palm oil-, yellow Grease-, and Soybean Oil-Based Biodiesel Blends After Cold Soaking at 4°C. *J. Am. Oil Chem. Soc.* **2008**, *85*, 1173.
- (25) Zhang, Y.; Dubé, M. A.; McLean, D. D.; Kates, M. Biodiesel production from waste cooking oil: 2. Economic assessment and sensitivity analysis. *Bioresour. Technol.* **2003**, *90*, 229.
- (26) Zhang, Y.; Dubé, M. A.; McLean, D. D.; Kates, M. Biodiesel production from waste cooking oil: 1. Process design and technological assessment. *Bioresour. Technol.* **2003**, *89*, 1.
- (27) Van Kasteren, J. M. N.; Nisworo, A. P. A process model to estimate the cost of industrial scale biodiesel production from waste cooking oil by supercritical transesterification. *Resour. Conserv. Recycl.* **2007**, *50*, 442.
- (28) Haas, M. J.; McAloon, A. J.; Yee, W. C.; Foglia, T. A. A process model to estimate biodiesel production costs. *Bioresour. Technol.* **2006**, *97*, 671.
- (29) Glicic, S.; Skala, D. The problems in design and detailed analyses of energy consumption for biodiesel synthesis at supercritical conditions. *J. Supercrit. Fluids* **2009**, *49*, 293.
- (30) West, A. H.; Posarac, D.; Ellis, N. Assessment of four biodiesel production processes using HYSYS.Plant. *Bioresour. Technol.* **2008**, *99*, 6587.
- (31) Apostolakou, A. A.; Kookos, I. K.; Marazioti, C.; Angelopoulos, K. C. Techno-economic analysis of a biodiesel production process from vegetable oils. *Fuel Process. Technol.* **2009**, *90*, 1023.
- (32) Hou, Z.; Zheng, D. Solar utility and renewability evaluation for biodiesel production process. *Appl. Therm. Eng.* **2009**, *29*, 3169.
- (33) Gutiérrez, L. F.; Sánchez, Ó. J.; Cardona, C. A. Process integration possibilities for biodiesel production from palm oil using ethanol obtained from lignocellulosic residues of oil palm industry. *Bioresour. Technol.* **2009**, *100*, 1227.
- (34) Montgomery, D. C. *Design and Analysis of Experiments*; Wiley: New York, 2004.
- (35) Naik, M.; Meher, L. C.; Naik, S. N.; Das, L. M. Production of biodiesel from high free fatty acid Karanja (*Pongamia pinnata*) oil. *Biomass Bioenerg.* **2008**, *32*, 354.
- (36) Ghadge, S. V.; Raheman, H. Biodiesel production from mahua (*Madhuca indica*) oil having high free fatty acids. *Biomass Bioenerg.* **2005**, *28*, 601.
- (37) Lu, H.; Liu, Y.; Zhou, H.; Yang, Y.; Chen, M.; Liang, B. Production of biodiesel from *Jatropha curcas* L. oil. *Comput. Chem. Eng.* **2009**, *33*, 1091.
- (38) Veljkovic, V. B.; Lakicevic, S. H.; Stamenkovic, O. S.; Todorovic, Z. B.; Lazic, M. L. Biodiesel production from tobacco (*Nicotiana tabacum* L.) seed oil with a high content of free fatty acids. *Fuel* **2006**, *85*, 2671.
- (39) Karaosmanoğlu, F.; Cıgızoğlu, K. B.; Tüter, M.; Ertekin, S. Investigation of the Refining Step of Biodiesel Production. *Energy Fuels* **1996**, *10*, 890.

- (40) Chiu, C. W.; Goff, M. J.; Suppes, G. J. Distribution of methanol and catalysts between biodiesel and glycerin phases. *AIChE J.* **2005**, *51*, 1274.
- (41) Zhou, W. Y.; Boocock, D. G. B. Phase distributions of alcohol, glycerol, and catalyst in the transesterification of soybean oil. *J. Am. Oil Chem. Soc.* **2006**, *83*, 1047.
- (42) Di Felice, R.; De Faveri, D.; De Andreis, P.; Ottonello, P. Component Distribution between Light and Heavy Phases in Biodiesel Processes. *Ind. Eng. Chem. Res.* **2008**, *47*, 7862.
- (43) Komers, K.; Tichy, J.; Skopal, F. Ternary Phase-Diagram Biodiesel Fuel-Methanol-Glycerol. *J. Prakt. Chem. Chem.* **1995**, *337*, 328.
- (44) Ma, F. R.; Clements, L. D.; Hanna, M. A. Biodiesel fuel from animal fat. Ancillary studies on transesterification of beef tallow. *Ind. Eng. Chem. Res.* **1998**, *37*, 3768.
- (45) Stloukal, R.; Komers, K.; Machek, J. Ternary phase diagram biodiesel fuel methanol water. *J. Prakt. Chemie Chemiker* **1997**, *339*, 485.
- (46) Andreatta, A. E.; Casás, L. M.; Hegel, P.; Bottini, S. B.; Brignole, E. A. Phase Equilibria in Ternary Mixtures of Methyl Oleate, Glycerol, and Methanol. *Ind. Eng. Chem. Res.* **2008**, *47*, 5157.
- (47) Negi, D. S.; Sobotka, F.; Kimmel, T.; Wozny, G.; Schomacker, R. Liquid-Liquid Phase Equilibrium in Glycerol-Methanol-Methyl Oleate and Glycerol-Monoolein-Methyl Oleate Ternary Systems. *Ind. Eng. Chem. Res.* **2006**, *45*, 3693.
- (48) França, B. B.; Pinto, F. M.; Pessoa, F. L. P.; Uller, A. M. C. Liquid-Liquid Equilibria for Castor Oil Biodiesel + Glycerol + Alcohol. *J. Chem. Eng. Data* **2009**, *54*, 2359.
- (49) Sakai, T.; Kawashima, A.; Koshikawa, T. Economic assessment of batch biodiesel production processes using homogeneous and heterogeneous alkali catalysts. *Bioresour. Technol.* **2009**, *100*, 3268.
- (50) Krisnangkura, K.; Yimsuwan, T.; Pairintra, R. An empirical approach in predicting biodiesel viscosity at various temperatures. *Fuel* **2006**, *85*, 107.

Received for review October 30, 2009

Revised manuscript received February 22, 2010

Accepted March 10, 2010

IE901707Q

Artículo III

MANUEL GARCÍA¹
 ALBERTO GONZALO¹
 JOSÉ LUIS SÁNCHEZ¹
 JESÚS ARAUZO¹
 CATARINA SIMOES²

¹Thermochemical Processes
 Research Group (GPT), Aragón
 Institute of Engineering Research
 (I3A), Universidad de Zaragoza,
 Zaragoza, Spain
²Biodiesel Aragón S.L., Altorricón,
 Huesca, Spain

SCIENTIFIC PAPER

UDC 665.2:66

DOI 10.2298/CICEQ100224058G

METHANOLYSIS AND ETHANOLYSIS OF ANIMAL FATS: A COMPARATIVE STUDY OF THE INFLUENCE OF ALCOHOLS

Biodiesel from animal fats with methanol and ethanol was produced in the presence of sodium methoxide and sodium ethoxide as catalysts. Two samples of pork fats and one natural beef tallow were directly transesterified with a good final product yield: 87.7, 86.7 and 86.3% for methanolysis, and 78.4, 82.6 and 82.7% for ethanolysis, respectively. Methyl ester content was also determined, being higher than 96.5 mass% for all the samples prepared. The presence of natural C17:0 in animal fats makes it necessary to correct the method proposed in the standard EN 14103 (2003). Biodiesel density at 15 °C of the samples was between 870 and 876 kg/m³, within the acceptance range of standard EN 14214, and the dynamic viscosity at 40 °C of the produced biodiesels was in the range of 4.5 to 5.16 mm²/s, also fulfilling requirements of EN 14214 standard. The iodine value is much lower than the superior limit established by EN 14214 standard but oxidation stability (OSI) is lower than the required limit, 6 h, of the standard, which can be attributed to the lack of natural antioxidants in tallows.

Key words: Biodiesel; animal fat; transesterification; ethanolysis; methanolysis.

The growing global emission of carbon dioxide and the progressive reduction of fossil energy resources have been major global concerns for several years now. The use of fuels made from biomass such as biodiesel and bioethanol can help satisfy the need of energy forms with renewable sources.

Biodiesel offers many benefits as an alternative fuel, among which are its derivation from renewable sources as well as its biodegradability and lower ecotoxicity in comparison with petroleum-based diesel. Furthermore, biodiesel has a more favourable combustion emission profile concerning carbon monoxide, particle emission and unburned hydrocarbons [1].

Biodiesel is a mixture of monoalkyl esters of long chain fatty acids derived from renewable lipid feedstock. In order to carry out this reaction, vegetable oils, fresh or used, as well as some kind of animal tallows, are forced to react with a short chain alcohol (methanol or ethanol mainly). Depending on the alcohols used, the products obtained are a mixture of

fatty acid methyl esters (FAME) or fatty acid ethyl esters (FAEE). Biodiesel obtained from ethanol is composed entirely of bio-based materials, making the process more sustainable, but ethanol is currently more expensive than methanol. The most employed vegetable oils for biodiesel industrial production are rapeseed, soybean and sunflower oils [2]. Furthermore, palm oil is considered an excellent feedstock for biodiesel production in tropical countries, such as Thailand, Malaysia and Colombia [2,3]. Beef tallow [4], waste lards and others animal fats [5,6] are also used sometimes in biodiesel production. Biodiesel from these materials doesn't fulfil required properties for its commercialization, so they must be mixed with biodiesel from vegetable oils.

The major problems related to animal fats are the high level of FFA [5] and the poor low temperature properties [7]. Animal fats have a significant content of saturated fatty acids and important properties such as pour point (PP), cloud point (CP) and cold filter plugging point (CFPP) of these biodiesels are usually over reasonable limits and standard specifications (EN 14214). Blending biodiesel from animal fats with biodiesel from vegetable oils is a way to improve these properties with the advantages of low iodine value and higher OSI values. Attending to the differences between FAME and FAEE, Joshi *et al.* [8] report the

Corresponding author: M. García, Thermochemical Processes Research Group (GPT), Aragón Institute of Engineering Research (I3A), Universidad de Zaragoza, Edificio Torres Quevedo, c/ María de Luna Nº3, 50.018 Zaragoza, Spain.

E-mail: manuelgr@unizar.es

Paper received: 24 February, 2010

Paper revised: 12 October, 2010

Paper accepted: 21 October, 2010

effect on cold flow properties of transesterified soybean oil with various mixtures of methanol and ethanol. They found an improvement of these properties while increasing the FAEE content of the produced mixture of esters. Anyway, mixing is a powerful way to obtain biodiesel with good properties. Additionally, the absence of natural antioxidants in fats makes biodiesel less stable for oxidation. Therefore, the use of this biodiesel obtained from the animal fat without mixing is not recommended.

On the other hand, biodiesel from animal fats has a higher calorific value and cetane number [9,10]. Additionally, important environmental and political advantages are that no competition with the food market is created and that an agricultural or industrial waste product is used instead of thrown away [5].

The most widespread industrial transesterification process is the homogeneous reaction catalyzed by alkali (NaOH or KOH) [11-13]. Other transesterification methods such as the use of acid catalysts (as H₂SO₄) [14,15], enzymes [16,17], heterogeneous catalysts [18-21] or the reaction under supercritical conditions [22,23] have industrial applications or are currently being researched.

Industrial-scale production of biodiesel is already being carried out, but still suffers from a high production cost, which is 1.5 to 3 times higher than production cost for fossil diesel [1,24]. This fact is mainly caused by the cost of fresh vegetable oil feedstocks [25]. For this reason, exploring methods to reduce the production cost of biodiesel, including new raw materials like waste vegetable oils or animal fats have attracted the focus of numerous research papers [9,18,26].

In case of significant FFA content in the oil or fat, special transesterification processes are required. Used cooking oils typically contain 0.4-3.3 mass% FFA, and animal fats contain from 5 to 40 mass% FFA [5,10,27]. When an alkali catalyst is added to these feedstocks, FFA reacts with the catalyst to form soap and water. It has been claimed that up to about 1 mass% FFA the reaction can still be catalyzed with an alkali catalyst, however, other authors reduce this limit to 0.5 mass% [28]. The soap formed during the reaction is either removed with the glycerol or washed out during the water wash. When the FFA level is above 5 mass%, the soap inhibits the separation of the methyl esters and glycerol and leads to the formation of an emulsion during the water washing step [29].

Esterifying FFA to alkyl esters in the presence of an acidic catalyst is a possibility of improving the use of high FFA oils in biodiesel production. Esterification can be carried out with homogeneous acid catalysts

such as sulphuric and p-toluene sulfonic acids [30,31]. Unfortunately, the use of homogeneous catalysts requires additional steps in the process which can reduce the economical yield of biodiesel production with animal fats, such as feedstock.

In this work, reaction yield and several properties of biodiesel produced by direct transesterification of 3 samples of animal fats originated from pork and beef tallow were studied using methanol and ethanol as alcohols. The influence of alcohol in some biodiesel properties such as viscosity, density, iodine number and OSI has been studied.

EXPERIMENTAL

Materials and methods

Several samples were used in this study; commercial edible pork fat (PF), crude pork fat (CPF, from LIPSA company Santa Perpetua de Mogoda, Barcelona, Spain) and natural beef tallow (NBT, from slaughterhouses in Tudela, Navarra, Spain). Fat was extracted from beef tallow by heating it and removing the solid residue. The obtained product was finally filtered and stored.

During the experimental period all raw materials were kept at 4 °C. In order to assure a constant sample composition, raw materials were heated and shaken in order to obtain a liquid homogeneous mixture before storing them.

Reagents used during biodiesel synthesis and purification steps were: methanol (assay (GLC) ≥ 99.9%, Carlo Erba Reagents), ethanol (99%, Panreac), sulphuric acid (96%, Panreac), sodium methoxide (ca. 25 mass% solution in methanol, Sigma-Aldrich), sodium ethoxide (ca. 21 mass% solution in ethanol, Sigma-Aldrich) and Magnesium sulphate (anhydrous, Scharlau). A dissolution of methyl heptadecanoate (standard for GC, Fluka Analytical) in heptane (standard for GC, Fluka Analytical) was used as internal standard for the GC determinations.

Table 1 shows the acid value and the fatty acid composition of the raw materials. Acid value was determined by volumetric titration according to the standard ISO 660 (2002). Fatty acid composition was determined using gas chromatography (GC) according to EN 14103 (2003) and ISO 5508 (1990). The fatty acid compositions of obtained FAEE are also reported and, as expected, no important differences can be observed between FAME and FAEE fatty acid profiles.

The acid value in CPF and NBT exceeds the acidity limit proposed by several authors [26,29] for a direct transesterification. In these cases, a pre-esterification using H₂SO₄ as catalyst is recommended.

Table 1. Acid value and fatty acid profile of used fats

	PF	CPF	NBT	PF	CPF	NBT
Acid value, mass% FFA						
Fatty acid	0.21	0.97	0.6	-	-	-
Fatty acid profile, mass%						
	FAME			FAEE		
Capryc (C10:0)	-	-	0.209	-	-	0.171
Lauric (C12:0)	-	-	0.388	-	-	0.339
Myristic (C14:0)	1.410	1.472	4.853	1.346	1.412	4.417
Myristoleic (C14:1)	-	-	0.228	-	-	0.418
Pentadecanoic (C15:0)	0.067	0.050	0.854	0.046	0.032	0.601
Palmitic (C16:0)	26.377	26.762	28.186	26.445	26.798	27.996
Palmitoleic (C16:1)	1.896	2.642	2.031	1.959	2.379	1.937
Margaric (C17:0)	0.415	0.313	1.449	0.390	0.284	1.418
Margaroleic (C17:1)	0.231	0.239	0.365	0.191	0.196	0.309
Stearic (C18:0)	17.114	16.535	23.212	18.558	17.928	24.837
Oleic (C18:1)	35.754	39.140	34.951	36.038	39.257	34.389
Linoleic (C18:2)	13.894	10.464	2.685	12.617	9.677	2.325
Linolenic (C18:3)	1.075	0.772	0.334	1.011	0.640	0.462
Arachidic (C20:0)	0.198	0.205	0.157	0.165	0.173	0.129
Gadoleic (C20:1)	0.667	0.676	0.099	0.597	0.616	0.132
Eicosadienoic (C20:2)	0.448	0.386	-	0.340	0.297	-
Other fatty acids	0.454	0.344	-	0.299	0.313	0.121

However, as shown in this study, the results of a direct transesterification with methanol and sodium methoxide or ethanol and sodium ethoxide as catalysts are very close to the results of a low acidity oil transesterification [32,33].

The following biodiesel properties were evaluated according to EN 14214 (2003), the European biodiesel standard: *λ*) density according to the EN 12185 standard; *ii*) kinematic viscosity at 40°C, using glass capillary viscometers according to the ISO 3104 standard (1994); *iii*) iodine value according to EN 14214 (2003), annex. B; *iv*) OSI according to EN 14112 (2003); *v*) ester and linolenic acid alkyl ester contents, by GC according to the EN 14103 standard (2003); *vi*) water content, by Karl Fischer coulometric titration according to the EN ISO 12937 standard (2003); *vii*) acid value, by volumetric titration according to the EN 14104 standard (2003).

Methyl and ethyl esters were determined using gas chromatography with a flame ionization detector (GC-FID) system, an Agilent 6890 Series GC System gas chromatograph, with a DB-225 MS (Agilent) column (30 m×0.25 mm×0.25 μm). The injector temperature and the detector (FID) temperature were set at 250 °C. The used carrier gas was He with a flow of 1 mL/min. Injection was made in a split mode, using a split flow ratio of 35:1, the volume injected was 1 μL.

The following temperature program was used: 170 °C, then 3 °C/min to 203 °C, then 1.5 °C/min to 214 °C, then 5 °C/min to 230 °C and holding at that temperature for 16 min.

Experimental procedure

The used fats were heated at 70 °C in order to homogenize the mixture previous to the reaction. Synthesis of biodiesel was done by alkaline transesterification in a batch reactor (2000 mL glass vessel) equipped with a mechanical stirrer, a condenser and a thermocouple. The reaction temperature was set to 60 °C for methanolysis and 78 °C for ethanolysis, and stirring speed was set to 600 rpm in order to avoid mass transfer problems.

The reaction conditions were: 6:1 molar ratio of alcohol to fat, 1.0 mass% sodium methoxide or ethoxide, and 3 h reaction time. During the procedure, 500 g of the fat (for all experiments) sample was weighed and transferred into the reactor. When temperature reached 60 or 78 °C for methanolysis and ethanolysis, respectively, MeONa and EtONa, dissolved in the required amount of methanol or ethanol, were added at constant stirring.

Once the reaction was considered complete, the reaction mixture was allowed to decant (2 h for methanolysis and 3 h for ethanolysis) at room temperature.

ture and after that two phases could be identified. The lower phase consisted of glycerol and the upper phase consisted of FAME and FAEE, where the alcohol and the used catalyst are supposed to distribute between both phases.

After the separation step, the alcohol from the biodiesel phase was recovered using a rotary evaporator under reduced pressure (0.2 bar). The obtained biodiesel was washed 3 times with hot (70 °C), acidified (pH 2, sulphuric acid) water to remove residual catalyst, glycerol, alcohol and any soap formed. After separation of the water phase, the biodiesel was dried in a rotary evaporator at reduced pressure, and magnesium sulphate was used to further reduce the biodiesel water content.

RESULTS AND DISCUSSION

Characterization of raw materials

The fatty acid composition of all raw materials is presented in Table 1 in detail. Oleic ester is the dominant one in all cases, up to 34 mass%. A typical characteristic of animal fats is the high amount of saturated esters represented by the presence of palmitic (up to 26 mass%) and stearic (up to 16 mass%) acid alkyl esters. Some minor saturated esters can be found in NBT such as caprylic, lauric, myristic and margaric acid alkyl esters [6]. Table 2 shows the fatty acid compositions of commonly used oils [34]. As can be observed, the saturated esters content for these oils is meaningfully lower in exception to palm oil, which presents a high level of palmitic alkyl ester. Long carbon chain esters such as arachidic, gadoleic and eicosadienoic alkyl esters can also be found in animal fats, especially in NBT. Odd carbon atom number esters can also be found in the transesterified fats, an especially important one being the alkyl heptadecanoate, which is used as an internal standard in the ester content determination. This fact can be explained by taking into account the presence of bacteria in

some animal organisms [35]. Bacteria possess the ability to synthesise odd- and branched-chain fatty acids, consequently ruminant and other animal fats contain odd numbered fatty acids [36].

Esters characterization

Table 3 shows the obtained product yields and the methyl ester content for FAME. Moreover, some final properties of the biodiesel for both, FAME and FAEE are shown: linolenic ester content, density, kinematic viscosity, iodine value, OSI and water content.

Product yield is defined as the weight percentage of the final product (transesterified and purified fat) relative to the weight of fat at the start. They were calculated from the final weight of biodiesel (after all purification steps) and the theoretical material balance, as shown in the following equation:

$$\text{Product yield} = 100 \frac{M_{\text{BIO}} / Pm_{\text{BIO}}}{3M_{\text{FAT}} / Pm_{\text{FAT}}} \quad (1)$$

where M_{BIO} and M_{FAT} are the weight of the obtained biodiesel and the fat, respectively. Pm_{BIO} and Pm_{FAT} are the molar weights of the biodiesel and fat calculated by using the fatty acid profile obtained from the GC analysis and the molar weight of the 4 most abundant components. The results show that all fats (PF, CPF and NBT) can be transesterified with a good final yield using methanol and ethanol as alcohols. The obtained yields for methanolysis reactions are slightly higher than those for ethanolysis. In the case of methanolysis, the solubility of fat in methanol is smaller and the reaction is mass transfer limited at the beginning. On the other hand, the separation of the two phases (biodiesel and glycerol) obtained after the reaction step is quite straightforward, as their miscibility is low. Unlike methanol, ethanol has better solvent properties but the formation of emulsion after the transesterification makes the separation step more complicated and affects the final product yield.

Table 2. Fatty acid composition of commonly used oils [34]

Fatty acid	Rapeseed	Sunflower	Palm	Soybean	Jatropha
Myristic (C14:0)	-	-	-	-	1.4
Palmitic (C16:0)	3.5	6.4	42.6	13.9	15.6
Palmitoleic (C16:1)	-	0.1	0.3	0.3	-
Stearic (C18:0)	0.9	2.9	4.4	2.1	9.7
Oleic (C18:1)	64.1	17.7	40.5	23.2	40.8
Linoleic (C18:2)	22.3	72.9	10.1	56.2	32.1
Linolenic (C18:3)	8.2	-	0.2	4.3	-
Arachidic (C20:0)	-	-	-	-	0.4
Other	0.69	-	1.1	-	-

Table 3. Yield and quality parameters of biodiesel from the used fats

Parameter	FAME			FAEE		
	PF	CPF	NBT	PF	CPF	NBT
Yield, %	87.7	86.7	86.3	78.4	82.6	82.7
Methyl ester content, mass%	96.31 ^a , 98.62 ^b	97.93 ^a , 99.77 ^b	96.95 ^a , 99.43 ^b	>96.5	>96.5	>96.5
Linolenic alkyl ester, mass% (C18:3)	1.075	0.772	0.334	1.075	0.772	0.334
Density at 15 °C, kg/m ³	876.3	873.80	873.31	872.7	871.2	870.3
Kinematic viscosity at 40 °C, mm ² s ⁻¹	4.51	4.57	4.77	5.01	4.98	5.16
Iodine value, gI ₂ /100g	60.0	56.8	37.6	57.9	55.1	36.8
Oxidation stability, h	2.84	6.27	2.56	4.70	8.70	3.60
Water content, ppm	415.3	231.0	358.3	422.7	317.0	349.5

^aWithout correction; ^bwith correction

The methyl ester content for the methanolysis reactions is shown in Table 3. It was measured following the analytical method defined by EN 14214, which uses methyl heptadecanoate (C17:0) as an internal standard, however, this fatty acid exists in animal fats and affects the obtained results. In order to take into account this fact the samples were analysed by GC with and without the internal standard. By applying the correction proposed by Schober *et al.* [37] an increase of the measured biodiesel purity was obtained. The results are in good agreement with other reported data [5] and confirm that the analytical method defined by EN 14214 is not appropriate for purity determination when methyl heptadecanoate is present in the feedstock.

Since commercial biodiesel is produced using methanol as alcohol, no normalized analysis methods for ethyl esters can be found. The use of methyl heptadecanoate as the internal standard for the GC determination does not guarantee a correct ester quantification, but the purity of ethanol based biodiesel has been checked (and considered over 96.5 mass%) by using the GC analysis that confirms that no strange compounds are present in the mixture.

Density values at 15 °C are shown in Table 3 for FAME and FAEE. All biodiesels met the European EN 14214 standard (min. 860, max. 900 kg/m³). FAME densities are slightly higher than FAEE densities but no important differences can be found between them. The obtained data are in good agreement with other published data for both, FAME [4,6,38] and FAEE [39]. An interesting comparison can be made between the densities of fat-made biodiesels and the densities of oil-made biodiesels. Table 4 shows some properties of commonly used oils in the biodiesel production. Density, kinematic viscosity, CFPP (cold filter plugging point) and OSI are shown for both, FAME and FAEE. Comparing Tables 3 and 4 the lower density of fat-made biodiesel can be observed, this fact can be at-

tributed to the presence of higher amounts of low density esters such as palmitic and stearic alkyl esters. These results are in good agreement with those presented by Teixeira *et al.* [40] and Dias *et al.* [41].

Considering the viscosity values shown in Table 3, fatty acid ethyl esters have a higher kinematic viscosity, compared to the values of kinematic viscosity of FAME. The substitution of methanol with higher alcohols is known to increase the kinematic viscosity [42]. Joshi *et al.* [8] found a curvilinear relationship between kinematic viscosity and ethyl ester in a FAME/FAEE mixture. In the present study, two fat-made biodiesels (PF and NBT) exhibit a viscosity value over 5 mm²/s, which is the upper limit for the European standard EN 14214. Table 4 presents the kinematic viscosities of some oil-made biodiesels. Viscosity values for fat-made biodiesel are in general higher than those shown in Table 4 from vegetable oils. This fact is in good agreement with the results reported by Dias *et al.* [41] and Teixeira *et al.* [40] who found a linear dependency between viscosity values and beef tallow biodiesel % in the mixture with soybean made biodiesel.

The iodine values, also shown in Table 3, are significantly lower than those of sunflower oil and soybean oil [43]. Of the three raw materials tested, NBT has the smallest iodine value, which is directly related to the smaller amount of unsaturated compounds, as can be observed in Table 1. These results are in good agreement with the higher unsaturation levels found on vegetable raw materials and other reported values [4, 5]. Joshi *et al.* [8] found higher iodine value in FAME than in FAEE. They propose a mixture in order to reduce high iodine value biodiesels. Similar results are reported by Dias *et al.* [41].

Water and linolenic acid alkyl ester contents meet the European standard for all biodiesels.

Oil stability index (OSI) is an important issue affecting the use of biodiesel. The influence of polyun-

Table 4. Properties of biodiesel from commonly used oils

Property	FAME				FAEE			
	Rapeseed	Sunflower	Palm	Soybean	Rapeseed	Sunflower	Palm	Soybean
Density at 15 °C, g dm ⁻³	888 [33]	880 [33]	875.9 [47]	885 [33]	872-888 [49]	879 [48]	873.8 [46]	882.7 [46]
Kinematic viscosity at 40 °C, mPa s	4.4 [43]	4.2 [43]	4.5 [43]	4.2 [43]	4.7 [49]	-	-	4.6 [8]
CFPP	-10 [43]	-3 [43]	10 [43]	-5 [43]	-	-6 [48]	-	-5 [8]
OSI, h	2 [43]	0.8 [43]	4 [43]	1.3 [43]	-	-	-	6.5 [8]

saturated methyl esters increases the oxidation tendency of biodiesel [44]. It is well known that it is very difficult to meet this limit for biodiesel from commonly used raw materials, unless antioxidants are used. Only two of the obtained biodiesels achieve the minimum limit of six hours for OSI, both produced from CPF with methanol and ethanol.

The relative low stability index reported in Table 3 can be explained by the absence of natural antioxidants in animal fats [45], but reported values are, in general, greater than those for oil-made biodiesel as shown in Table 4 and by Ramos *et al.* [43]. These authors attribute the low OSI of the oil-made biodiesels to the presence of linoleic and linolenic methyl esters due to the position of double bonds in these compounds. Since these compounds have a low amount in animal fats, OSI values are higher for these biodiesels. As seen in Table 3, FAEE displays improved resistance to oxidation compared to FAME. Similar results have been reported by Joshi *et al.* [8] who explain this difference due to the increase in average molecular weight of FAEE compared to FAME.

CONCLUSIONS

Biodiesel synthesis from animal fats was carried out at lab scale by a direct transesterification with methanol and ethanol as alcohols. Good yields, higher than 83 and 78 mass%, were obtained using methanol and ethanol, respectively. The lower yield values in the case of FAEE can be attributed to the problems in the purification step due to the higher inter-solubility of the mixture. Due to the presence of C17:0 in biodiesel as a natural component of animal fats and in light of the results, a correction should be made by the method proposed by EN 14214 for biodiesel purity determination.

The density and iodine values are in the range of the EN 14214 standard for all biodiesels. The obtained iodine values are quite smaller of those for vegetable oil based biodiesel, which is attributed to the presence of high amount of saturated esters. Of the three samples, only the crude pork fat biodiesel shows an OSI high enough to fulfill the requirement of EN

14214 standard. The OSI was higher for the biodiesel produced with ethanol in all samples, however, viscosity values meet the EN 14214 standard for FAME, but FAEE are over this limit.

Acknowledgments

The authors thank the LIPSA Company (Santa Perpetua de Mogoda, Barcelona, Spain) for collaboration in this work.

REFERENCES

- [1] V. Makareviciene, P. Janulis, *Renew. Energy* **28** (2003) 2395-2403
- [2] M. Johnston, T. Holloway, *Environ. Sci. Technol.* **41** (2007) 7967-7973
- [3] Y.C. Sharma, B. Singh, *Renew. Sustain. Energy Rev.* **13** (2009) 1646-1651
- [4] M.E. da Cunha, L.C. Krause, M.S.A. Moraes, C.S. Facini, R.A. Jacques, S.R. Almeida, M.R.A. Rodrigues, E.B. Caramão, *Fuel Process. Technol.* **90** (2009) 570-575
- [5] J.M. Dias, M.C.M. Alvim-Ferraz, M.F. Almeida, *Bioresour. Technol.* **100** (2009) 6355-6361
- [6] D.U. Skala, S. Glišić, I. Lukić, A.M. Orlović, *Hemijaska industrija* **54** (2004) 176-185
- [7] K. Kazancev, V. Makareviciene, V. Paulauskas, P. Janulis, *Eur. J. Lipid Sci. Technol.* **108** (2006) 753-758
- [8] H. Joshi, B.R. Moser, J. Toler, T. Walker, *Biomass Bioenergy*. **34** (2010) 14-20
- [9] M. Gürü, B.D. Artukoglu, A. Keskin, A. Koca, *Energy Convers. Manage.* **50** (2009) 498-502
- [10] L. Canoira, M. Rodriguez-Gamero, E. Querol, R. Alcantara, M. Lapuerta, F. Oliva, *Ind. Eng. Chem. Res.* **47** (2008) 7997-8004
- [11] B. Freedman, R.O. Butterfield, E.H. Pryde, *J. Am. Oil Chem. Soc.* **63** (1986) 1375-1380
- [12] H. Nouredini, D. Zhu, *J. Am. Oil Chem. Soc.* **74** (1997) 1457-1463
- [13] M. Mittelbach, B. Trathnigg, *Fett Wissenschaft Technologie - Fat Sci. Technol.* **92** (1990) 145-148
- [14] S. Zheng, M. Kates, M.A. Dubé, D.D. McLean, *Biomass Bioenergy* **30** (2006) 267-272
- [15] E. Lotero, Y.J. Liu, D.E. Lopez, K. Suwannakarn, D.A. Bruce, J.G. Goodwin, *Ind. Eng. Chem. Res.* **44** (2005) 5353-5363

- [16] N.-W. Li, M.-H. Zong, H. Wu, *Process Biochem.* **44** (2009) 685-688
- [17] N. Dizge, B. Keskinler, A. Tanriseven, *Biochem. Eng. J.* **44** (2009) 220-225
- [18] S. Yan, S.O. Salley, K.Y. Simon Ng, *Appl. Catal. A* **353** (2009) 203-212
- [19] M. Di Serio, M. Cozzolino, M. Giordano, R. Tesser, P. Patrono, E. Santacesaria, *Ind. Eng. Chem. Res.* **46** (2007) 6379-6384
- [20] L.F. Cui, G.M. Xiao, B. Xu, G.Y. Teng, *Energy Fuels* **21** (2007) 3740-3743
- [21] M. Di Serio, M. Cozzolino, R. Tesser, P. Patrono, F. Pinzari, B. Bonelli, E. Santacesaria, *Appl Catal. A* **320** (2007) 1-7
- [22] G. Madras, C. Kolluru, R. Kumar, *Fuel* **83** (2004) 2029-2033
- [23] A. Demirbas, *Prog. Energy Combust. Sci.* **31** (2005) 466-487
- [24] A. Demirbas, *Energy Convers. Manage.* **50** (2009) 14-34
- [25] M. Canakci, J. Van Gerpen, *Trans. ASAE.* **44** (2001) 1429-1436
- [26] G.-T. Jeong, H.-S. Yang, D.-H. Park, *Bioresour. Technol.* **100** (2009) 25-30
- [27] M.L. Pisarello, B. Dalla Costa, G. Mendow, C.A. Querini, *Fuel Process. Technol.* **91** (2010) 1005-1014
- [28] Z. Mark, H. Rafael, S. Darrell, MSU E-TECH Laboratory Report ET-03-003, A Review of the Engineering Aspects of the Biodiesel Industry, 2003
- [29] S.B. Glišić, D.U. Skala, *Chem. Ind. Chem. Eng. Q.* **15** (2009) 159-168
- [30] R. Aafaqi, A.R. Mohamed, S. Bhatia, *J. Chem. Technol. Biotechnol.* **79** (2004) 1127-1134
- [31] U.R. Unnithan, K.K. Tiwari, *Indian J. Technol.* **25** (1987) 477-479
- [32] D.Y.C. Leung, Y. Guo, *Fuel Process. Technol.* **87** (2006) 883-890
- [33] D.Y.C. Leung, X. Wu, M.K.H. Leung, *Appl. Energy.* **87** (2010) 1083-1095
- [34] S.P. Singh, D. Singh, *Renew. Sustain. Energy Rev.* **14** (2010) 200-216
- [35] B. Vlaeminck, V. Fievez, A.R.J. Cabrita, A.J.M. Fonseca, R.J. Dewhurst, *Anim. Feed Sci. Technol.* **131** (2006) 389-417
- [36] T. Rezanka, K. Sigler, *Prog. Lipid Res.* **48** (2009) 206-238
- [37] S. Schober, I. Seidl, M. Mittelbach, *Eur. J. Lipid Sci. Technol.* **108** (2006) 309-314
- [38] H.N. Bhatti, M.A. Hanif, M. Qasim, R. Ata-ur, *Fuel* **87** (2008) 2961-2966
- [39] G.M. Tashtoush, M.I. Al-Widyan, M.M. Al-Jarrah, *Energy Convers. Manage.* **45** (2004) 2697-2711
- [40] L.S.G. Teixeira, M.B. Couto, G.S. Souza, M.A. Filho, J.C.R. Assis, P.R.B. Guimarães, L.A.M. Pontes, S.Q. Almeida, J.S.R. Teixeira, *Biomass Bioenergy* **34** (2010) 438-441
- [41] J.M. Dias, M.C.M. Alvim-Ferraz, M.F. Almeida, *Energy Fuels.* **22** (2008) 3889-3893
- [42] M.G. Kulkarni, A.K. Dalai, N.N. Bakhshi, *Bioresour. Technol.* **98** (2007) 2027-2033
- [43] M.J. Ramos, C.M. Fernández, A. Casas, L. Rodríguez, Á. Pérez, *Bioresour. Technol.* **100** (2009) 261-268
- [44] G. Knothe, *Fuel Process. Technol.* **88** (2007) 669-677
- [45] E. Sendzikiene, V. Makareviciene, P. Janulis, *Pol. J. Environ. Stud.* **14** (2005) 335-339
- [46] S. Baroutian, M.K. Aroua, A.A.A. Raman, N.M.N. Sulaiman, *J. Chem. Eng. Data.* **53** (2008) 2222-2225
- [47] S. Baroutian, M.K. Aroua, A.A.A. Raman, N.M.N. Sulaiman, *J. Chem. Eng. Data.* **53** (2008) 877-880
- [48] J.M. Encinar, J.F. González, A. Rodríguez-Reinares, *Fuel Process. Technol.* **88** (2007) 513-522
- [49] M. Cernoch, M. Hájek, F. Skopal, *Bioresour. Technol.* **101** (2010) 1213-1219.

MANUEL GARCÍA¹
 ALBERTO GONZALO¹
 JOSÉ LUIS SÁNCHEZ¹
 JESÚS ARAUZO¹
 CATARINA SIMOES²

¹Thermochemical Processes
 Research Group (GPT), Aragón
 Institute of Engineering Research
 (I3A), Universidad de Zaragoza,
 Zaragoza, Spain

²Biodiesel Aragón S.L., Altorricón,
 Huesca, Spain

NAUČNI RAD

METANOLIZA I ETANOLIZA ANIMALNIH MASTI: UPOREDNO PROUČAVANJE UTICAJA VRSTE ALKOHOLA

Biodizel je dobijen u reakciji animalnih masti sa metanolom i etanolom u prisustvu natrijum-metoksida i natrijum-etoksida kao katalizatora. Dva uzorka svinjske masti i jednog uzorka prirodnog junećeg loja su podvrgnuti direktnoj transesterifikaciji, pri čemu su ostvareni dobri prinosi proizvoda: 87,7, 86,7 i 86,3% za metanolizu, a 78,4, 82,6 i 82,7% za etanolizu, redom. Sadržaj metil-estara je, takođe, određen i bio je veći od 96,5% za sve proizvode. Prisustvo masne kiseline C17:0 u mastima zahtevalo je korigovanje metode predviđene standardom EN 14103 (2003). Gustina biodizela na 15 °C je bila između 870 i 876 kg/m³, odnosno u granicama standarda EN 14214, dok je kinematički viskozitet bio u opsegu 4,5 do 5,16 mm²/s u skladu sa standardom EN 14214. Jodni broj je mnogo niži od granice utvrđene standardom EN 14214, ali je oksidaciona stabilnost niža od zahtevane granice (6 h), što se može pripisati nedostatku prirodnih antioksidanasa u mastima.

Ključne reči: Biodizel; animalna mast; transesterifikacija; etanoliza; metanoliza.

Artículo IV

Comparison of Methods for Estimating Critical Properties of Alkyl Esters and Its Mixtures

Manuel García,* Juan-José Alba, Alberto Gonzalo, José Luis Sánchez, and Jesús Arauzo

Aragón Institute of Engineering Research (I3A), Universidad de Zaragoza, Mariano Esquillor s/n, I+D Bld., 50018, Zaragoza, Spain

ABSTRACT: Biodiesel is a renewable fuel which can be described chemically as a mixture of different alkyl esters. To predict its different thermophysical properties, critical properties (P_c , T_c , V_c) must be known or estimated. In this work, the use of group contribution and group interaction methods is compared regarding its goodness in the prediction of a widely measured property such as biodiesel density, as there is a lack of data of normal boiling point or densities of pure alkyl esters. The results show that a group interaction method, with the available data of 20 different biodiesels published, can predict better biodiesel density when methanol was used for the transesterification reaction. Data available for biodiesel produced with ethanol are scarcer; only six sets of biodiesel composition and density could be found, and in this case, both group interaction and group contribution methods predict density with a similar error, although more data are needed.

1. INTRODUCTION

Biodiesel is an alternative renewable fuel which has several advantages such as biodegradability and lower ecotoxicity in comparison with petroleum-based diesel¹ and the possibility of producing it at low scales from multiple raw materials.

From the chemical point of view, biodiesel is a mixture of monoalkyl esters of long chain fatty acids. Departing from vegetal oils (fresh or reused) as well as some kinds of animal tallows, they are forced to react with a short-chain alcohol, the most used being methanol and ethanol. The products obtained are fatty acid methyl esters (FAMEs) or fatty acid ethyl esters (FAEEs), respectively, for those two alcohols. Biodiesel obtained from ethanol is composed entirely of biobased materials, making the process more sustainable, but due to its lower price compared to that of ethanol, methanol is the most commonly used alcohol in biodiesel production.² For its commercialization, biodiesel must be further processed to fulfill cleaning conditions established by relevant standards, such as EN 14214:2008+A1:2009 (European Norm) or ASTM 6751-07 (American Society of Testing and Materials).

Depending on the composition of the used raw materials, biodiesel properties can show a low-quality performance in some aspects. For example, the presence of high amounts of unsaturated esters decreases the oxidation and storage stability³ which makes necessary the use of additives. Cold flow properties such as cold filter plugging point (CFPP) and cloud point (CP) are also affected by the chemical composition of raw materials⁴ causing, in some cases, problems in the fuel injection system.^{5,6} Other important thermophysical properties of biodiesel such as density, viscosity, flash point, cetane number, and higher heating value also depend on the fatty ester profile, and its determination or estimation is a key parameter in spray and combustion modeling. To face a biodiesel process simulation, the behavior of these properties has to be known, and other useful properties such as vapor pressure, specific heat, thermal conductivity, and latent heat of vaporization are also necessary.

Predicting the final properties of biodiesel attending its chemical composition is nowadays an interesting issue, due to

the importance of having accurate property models to perform realistic simulations. Many papers dealing with biodiesel property modeling can be found in available literature. Composition-based models, theoretical and empirical, have been reported for density and viscosity.^{7–10} The cetane number¹¹ and iodine value¹² can also be estimated by using empirical correlations, as well as CFPP or CP.^{4,13} Recently, Su et al.¹⁴ have presented a comprehensive study of prediction methods for thermophysical properties of oils and biodiesel.

When theoretical models are used, the critical properties (pressure, P_c ; temperature, T_c ; specific volume, V_c), acentric factor (ω), and normal boiling point (T_{nb}) are needed as input. The experimental determination of these parameters for pure alkyl esters or their mixtures is not a trivial issue, and when no experimental data are available or its determination is too expensive and time-consuming, they must be estimated theoretically. Some methods for estimating P_c , T_c , T_{nb} , V_c , and ω have been published in specialized literature,^{15,16} but given the lack of experimental data, the selection of the proper model is a difficult task. In a very recent paper, Anand et al.¹⁷ performed a comparison of different methods for estimating critical properties and normal boiling point of pure methyl esters. The estimated values were used as input in the calculation of vapor pressure, specific heat capacity, thermal conductivity, and latent heat of vaporization comparing the resulting values with available experimental data.

The selection of a correct model's package is a key step to ensure minimum error in the subsequent calculations. In this paper a comparison of different methods to estimate thermophysical properties of pure methyl and ethyl esters and its mixtures (biodiesel) has been performed. To compare these models, as no experimental data of critical properties and just a few normal boiling points and densities of pure biodiesel

Received: September 26, 2011

Accepted: November 16, 2011

Published: December 12, 2011

Table 1. Description of the Estimation Methods Used for Each Property in the Packages

property	package 1	package 2	package 3
T_{nb}	CG	MP	Y/CG
T_c	CG	MP	A
P_c	WJ	WJ	A
V_c	CG	MP	J
ω	LK	LK	LK

compounds are published, an easily measurable property, density, has been used as a final testing variable.

2. METHODOLOGY

Being able to estimate macroscopic properties of biodiesel, such as density, implies, as well, being able to estimate thermophysical properties related to microscopic factors. Those are critical temperature, critical pressure, critical volume, acentric factor, and normal boiling point of its individual components and of the resulting mixture. These properties must be estimated as accurately as possible to generate the minimum error. For that purpose, different theoretical approaches with a microscopic focus such as the group contribution method and the groups interactions method have been selected based on available literature. Those methods are Constantinou and Gani (CG), Marrero and Pardillo (MP), Wilson and Jasperson (WJ), Ambrose (A), and Joback (J). Lee–Kesler equations (LK) were used in all cases to compute the acentric factor. A detailed description of these methods can be found in Poling et al.¹⁵ and Reid et al.¹⁶

Departing from these models, three different estimation packages have been created and analyzed in this paper. Those packages are listed in Table 1. A part of this work is to evaluate the accuracy of two estimation methodologies, the group contribution method and the group interaction methods, which is the main reason for the creation of packages 1 and 2. In case of package 3 the selected methodologies to estimate the critical properties are based on the group contribution theory, but while CG method is a second-order contribution method, the A and J methods take into account only first-order contributions. Additionally, the Yuan correlation (Y),¹⁸ an empirical correlation specifically designed for FAMEs, was used to compute T_{nb} in package 3 for FAMEs. These three packages constitute three different and representative paths to obtain the critical properties. A detailed explanation of each package can be found in the following section.

The followed procedure is shown in Figure 1: the critical properties, acentric factor, and normal boiling point are computed by using each package for each pure component. After that, two paths have been taken into account to compare the goodness of the proposed packages:

- Densities of pure methyl and ethyl esters at 15 °C (288.15 K) have been computed using the Spencer and Danner¹⁹ modified Rackett equation (eq 1) in combination with the Soave²⁰ equation (eq 2) and compared with experimental pure densities.
- Densities of alkyl ester mixtures (biodiesel) have been computed using the pseudocomponent concept, as explained below, and compared with experimental biodiesel densities.

The density computations are as follows:

$$\rho = \frac{MW_m}{\frac{RT_{cm}}{P_{cm}} Z_{Ra}^{[1 + (1 - T_r)^{2/7}]}} \quad (1)$$

$$Z_{Ra} = 0.02908 - 0.099\omega + 0.04\omega^2 \quad (2)$$

The acentric factor was computed using the following equations (LK);

$$\omega_i = \alpha/\beta \quad (3)$$

$$\alpha = -\ln P_{ci} - 5.92714 + 6.09648\theta^{-1} + 1.28862 \ln \theta - 0.160347\theta^6 \quad (4)$$

$$\beta = 15.2518 - 15.6875\theta^{-1} - 13.4721 \ln \theta + 0.43577\theta^6 \quad (5)$$

$$\theta = T_{nbi}/T_{ci} \quad (6)$$

Table 2 shows the 20 different alkyl esters that have been taken into account for the calculations for the methanol-based biodiesel, but just few of them were used to describe the biodiesel composition in the case of biodiesel obtained with ethanol due to the lack of more accurate compositions published. To compute the thermophysical properties of the mixture, also called the pseudocomponent, the LK mixing rules (LK_{mr}) were applied. Once thermophysical properties of the mixture were estimated, the Rackett–Soave (RS) equation was used to estimate the density values at 15 °C. The estimated data have been compared to the measured data reported by Sanford et al.²¹ in the case of FAME and other references^{22,23} in the case of FAEE.

2.1. Critical Properties and Estimation Packages. *2.1.1. Package 1 (Constantinou and Gani, CG, and Wilson–Jasperson, WJ).* Poling et al.¹⁵ recommended the use of CG method to estimate the T_{nb} and T_c and the WJ method to estimate the P_c . Due to the inexistence of a recommendation to estimate the V_c , the CG method was used as well. The LK equations (eqs 3 to 6) were used to obtain ω . Both models are based on group contribution theory. What makes CG special, as a group contribution method, is the fact that it considers two orders of group contributions. Tables 3 and 4 show the calculated values of T_{nb} , T_c , P_c , and ω for each methyl and ethyl ester, respectively.

2.1.2. Package 2 (Marrero and Pardillo, MP, and Wilson–Jasperson, WJ). In this case, T_{nb} , T_c , and V_c were calculated with the MP model. Poling et al.¹⁵ remark that the MP model is a good one for pure component critical properties estimation without any experimental data, although its range of application is still limited. It has been applied due to the fact that the calculations made were within its range of application. The P_c was calculated using the WJ model. This package was selected because its basis of calculation is the group interactions method or what is effectively a bond interactions method. The main difference between group interactions and group contributions is that the first considers the influence of a particular combination of atoms on the rest of elements that form the molecule, whereas the second builds the molecule group by group, assigning values to them and not to their influence in the rest of the elements that constitute the molecule. The estimated properties values are shown in Tables 5 and 6.

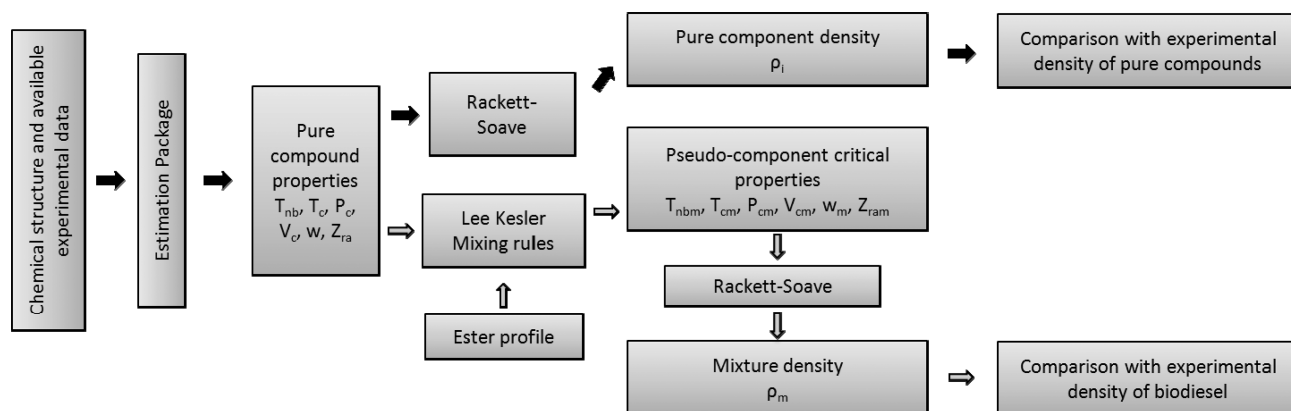

Figure 1. Paths followed to perform the calculations.

Table 2. Fatty Acid Profile of Biodiesel from Different Oil Sources (% Mass Fractions). Data Adapted from References 21, 34, and 35

ester	C8:0	C10:0	C12:0	C14:0	C15:0	C16:0	C17:0	C18:0	C20:0	C22:0	C24:0	C16:1	C17:1	C18:1	C20:1	C22:1	C24:1	C18:2	C18:3	C18:1 (OH)	
																				total	
algae				0.6		6.9		3.0	0.4	0.1		0.2		75.2				12.4	1.2	100	
babassu	0.5	3.8	48.8	17.2		9.7		4.0						14.2				1.8		100	
beef tallow			0.2	2.9	0.6	24.3	1.2	22.8	0.2			2.1	0.4	40.2	0.6			3.3	0.7	99.5	
borage						9.3		3.8		0.2				17.1		2.5	1.5	38.7	26.1	99.2	
camelina oil						5.0		2.2	1.4	0.4	0.3			17.7	9.8	4.5	0.2	18.0	37.9	97.4	
canola oil						3.8		1.9	0.6	0.4	0.2	0.3		63.9			0.2	19.0	9.7	100	
castor						0.9		1.1						3.1				4	0.6	90.3	100
choice white grease				1.3		21.6	0.2	9.0	0.2			2.8	0.3	50.4	0.5	0.3		12.2	1.0	99.8	
coconut 1	6.3	6.0	49.2	18.5		9.1		2.7						6.5				1.7		100	
coconut 2	3.7	3.5	35.7	20.1		14.3		3.9						14.1				4.7		100	
coconut 3	4.1	3.6	35.3	19.8		13.8		3.9						14.3				4.7		99.7	
coffee						11.0		3.4	0.6	0.2	0.1	0.5		70.0	0.1			12.7	0.8	99.4	
corn						12.1		1.8	0.4	0.2		0.1	0.1	27.2				56.2	1.3	99.4	
evening primrose						6.0		1.8						6.6				76.3	9.0	99.7	
hemp						5.2		2.4	0.7	0.5	0.3			13.1				57.1	20.0	99.3	
hepar high IV			0.2	1		20.7	0.3	8.9	0.2	0.2		2.7	0.3	46.7	0.8	0.4	0.1	15.6	0.5	98.6	
hepar low IV		0.1	0.1	1.5		28.0	0.3	20.2	0.2			1.9	0.2	36.1	0.7	0.3		9.7	0.3	99.6	
Jatropha						12.7		5.5	0.2			0.7		39.1				41.6	0.2	100	
linseed						4.4		3.8	0.2	0.3	0.1			20.7				15.9	54.6	100	
Moringa oleifera						5.5		5.8	3.1	4.2	0.4	1.2		76.3	2.0			0.7		99.2	
neem						14.9		20.6	1.6	0.3	0.3	0.1		43.9				17.9	0.4	100	
palm			0.2	0.5		43.4		4.6	0.3	0.1		0.1		41.9				8.6	0.3	100	
poultry fat			0.1	1.0		19.6	0.3	7.5	0.1	0.3		3.2	0.2	36.8		0.4		28.4	2.0	99.9	
rice bran				0.3		12.5		2.1	0.6	0.3	0.2			47.5				35.4	1.1	100	
soybean						9.4		4.1		0.3				22.0				55.3	8.9	100	
sunflower						4.2		3.3		0.7	0.4			63.6				27.6	0.2	100	
used cooking oil			0.1	0.1		11.8	0.1	4.4	0.3	0.4	0.1	0.4	0.1	25.3		0.3		49.5	7.1	100	
yellow grease			0.1	0.5		14.3	0.3	8	0.3	0.3		1.1	0.2	35.6		0.2	0.1	35.0	4.0	100	

2.1.3. Package 3 (Ambrose and Joback). The last package used is the combination of the Joback modification of Lydersen's method for V_c and Ambrose's method for T_c and P_c . The acentric factor was computed using LK equations, and T_{nb} was calculated according to the correlation reported by Yuan et al.¹⁸ (eq 7) in the case of methyl esters, which is an empirical correlation specifically designed for FAMEs with a maximum prediction error of 1.0%. The CG method was used in the case of ethyl esters due to the

inexistence of an experimental correlation. The Ambrose and Joback methods have been reported as proper methods for critical properties estimation and biodiesel density;^{22,24,25} their combination with Yuan's correlation is a good way to check the accuracy of pure theoretical packages. These two methods are also group contribution methods, but the main difference between package 1 and package 3 is that the Ambrose and Joback methods just consider first-order group contributions.

Table 3. Methyl Ester Critical Properties Calculated with Package 1: CG and WJ

methyl ester		T_{nb}	T_c	P_c	V_c	ω
		K	K	kPa	cm ³ ·mol ⁻¹	
methyl octanoate	C8:0	501.80	669.80	2528	553.40	0.85
methyl decanoate	C10:0	531.84	698.81	2099	665.00	0.87
methyl dodecanoate	C12:0	558.02	723.82	1776	776.60	0.87
methyl tetradecanoate	C14:0	581.23	745.79	1523	888.20	0.87
methyl pentadecanoate	C15:0	591.92	755.85	1416	944.00	0.86
methyl hexadecanoate	C16:0	602.07	765.38	1320	999.80	0.85
methyl heptadecanoate	C17:0	611.74	774.43	1233	1055.60	0.84
methyl octadecanoate	C18:0	620.98	783.06	1154	1111.40	0.83
methyl icosanoate	C20:0	638.28	799.17	1016	1223.00	0.79
methyl docosanoate	C22:0	654.24	813.96	899	1334.60	0.76
methyl tetracosanoate	C24:0	669.04	827.63	800	1446.20	0.71
methyl hexadec-9-enoate	C16:1	600.53	765.01	1348	986.41	0.85
methyl cis-10-heptadecenoate	C17:1	610.28	774.08	1258	1042.21	0.84
methyl (Z)-octadec-9-enoate	C18:1	619.58	782.73	1177	1098.01	0.82
methyl (Z)-12-hydroxyoctadec-9-enoate	C18:1 OH	641.91	799.93	1161	1104.94	0.95
methyl cis-11-eicosenoate	C20:1	637.00	798.86	1035	1209.61	0.79
methyl (Z)-13-docosenoate	C22:1	653.05	813.68	915	1321.21	0.76
methyl cis-15-tetracosenoate	C24:1	667.93	827.37	814	1432.81	0.71
methyl (Z,Z)-octadeca-9,12-dienoate	C18:2	618.17	782.39	1200	1084.62	0.82
methyl (Z,Z,Z)-octadeca-9,12,15-trienoate	C18:3	616.75	782.06	1224	1071.23	0.82

Tables 7 and 8 show the calculated values of thermophysical properties for each methyl and ethyl ester.

$$T_{nb} = 218.49 \ln(CN) - 6.933 \quad (7)$$

2.2. Density Calculation. A significant number of papers dealing with the estimation or correlation of biodiesel density can be found in available literature. Yuan et al.²⁶ reported the use of the modified Rackett equation using the data obtained by Tat and Van Gerpen²⁷ to determine Z_{Ra} in a temperature range from (0 to 100) °C. The authors predicted the density of soybean oil based biodiesel taking into account five methyl esters; linoleic acid methyl ester (C18:2), oleic acid methyl ester (C18:1), palmitic acid methyl ester (C16:0), linolenic acid methyl ester (C18:3), and stearic acid methyl ester (C18:0). The critical properties of these esters were calculated using Ambrose's method for T_c and P_c and Lydersen's method for V_c . These authors used the LK equations to compute the acentric factor, and LK mixing rules were used to compute the critical properties of the mixture. Using the same equations, Blangino et al.²⁸ reported a density prediction for soybean-made biodiesel. Baroutian et al.²⁵ used the Rackett modified equation to predict the density of palm oil-based biodiesel. Following the same procedure, other authors reported density predictions for *Jatropha* oil-based methyl esters²⁴ and palm, soybean, corn, canola, and ricebran oil-based ethyl esters.²² Anand et al.²⁹ reported a unified correlation based on the modified Rackett equation. In this case, the Rackett constant was calculated with the Vetere³⁰ equation, and the required normal boiling point was calculated by the CG method, a simple mixing rule, called Kay's mixing rule, was used to obtain the final density values. Clements³¹ reported the use of a correlation to estimate the biodiesel density as a function of temperature. The empirical model proposed by Clements uses the composition (four FAMES

were taken into account) as input and correlates the constants of a temperature-dependent linear equation.

As stated before, the aim of this work is to compare three different models/packages to estimate critical properties of biodiesel by using density as a macroscopic measurable property to compare their suitability. To perform this comparison, 20 alkyl esters have been taken into account to represent the composition of biodiesel.

The Rackett–Soave equation, which is one of the most commonly employed methods to estimate the saturated liquid density, has been applied to the data obtained with the three proposed packages. The Rackett compressibility factor (Z_{Ra}) is also needed, and it is usually computed using experimental density values. If no experimental data are available, the estimation of Z_{Ra} must be performed using one of the correlations proposed by Soave,²⁰ Yamada and Gunn,³² or Vetere.³⁰ In this work, the Soave equation (eq 2) has been used.

3. RESULTS AND DISCUSSION

3.1. Comparison of Experimental and Calculated Normal Boiling Temperature of Alkyl Esters. The lack of experimental data makes it difficult to compare the estimated values of critical properties and boiling point of pure components with experimental ones. To the best of these authors' knowledge, just a few experimental data dealing with normal boiling point of FAMES⁷ or FAAEs³³ are available in open literature.

Figure 2 shows experimental T_{nb} data of some methyl and ethyl esters with the values calculated with the two cited methods (CG and MP). The average relative deviation (ARD %), calculated according to eq 8, is also shown in Figure 2.

$$ARD(\%) = \frac{\sum_i^N (|x_{exp,i} - x_{est,i}|/x_{exp,i})}{N} \cdot 100 \quad (8)$$

Table 4. Ethyl Ester Critical Properties Calculated with Package 1: CG and WJ

ethyl ester		T_{nb}	T_c	P_c	V_c	ω
		K	K	kPa	$\text{cm}^3 \cdot \text{mol}^{-1}$	
ethyl octanoate	C8:0	506.32	675.46	2248	613.80	0.79
ethyl decanoate	C10:0	535.75	703.65	1893	725.40	0.81
ethyl dodecanoate	C12:0	561.47	728.04	1617	837.00	0.81
ethyl tetradecanoate	C14:0	584.31	749.53	1398	948.60	0.81
ethyl pentadecanoate	C15:0	594.84	759.39	1304	1004.40	0.80
ethyl hexadecanoate	C16:0	604.85	768.74	1219	1060.20	0.79
ethyl heptadecanoate	C17:0	614.39	777.63	1142	1116.00	0.78
ethyl octadecanoate	C18:0	623.51	786.11	1071	1171.80	0.77
ethyl icosanoate	C20:0	640.61	801.96	947	1283.40	0.74
ethyl docosanoate	C22:0	656.39	816.54	841	1395.00	0.70
ethyl tetracosanoate	C24:0	671.04	830.03	750	1506.60	0.66
ethyl hexadec-9-enoate	C16:1	599.21	768.38	1244	1046.81	0.73
ethyl <i>cis</i> -10-heptadecenoate	C17:1	609.02	777.29	1157	1102.61	0.72
ethyl (Z)-octadec-9-enoate	C18:1	618.38	785.78	1091	1158.41	0.71
ethyl (Z)-12-hydroxyoctadec-9-enoate	C18:1 OH	640.83	802.71	1072	1102.61	0.83
ethyl <i>cis</i> -11-eicosenoate	C20:1	635.89	801.66	964	1270.01	0.69
ethyl (Z)-13-docosenoate	C22:1	652.03	816.26	851	1381.61	0.65
ethyl <i>cis</i> -15-tetracosenoate	C24:1	666.98	829.77	759	1493.21	0.62
ethyl (Z,Z)-octadeca-9,12-dienoate	C18:2	613.11	785.46	1112	1145.02	0.66
ethyl (Z,Z,Z)-octadeca-9,12,15-trienoate	C18:3	607.70	785.13	1134	1131.63	0.61

Table 5. Methyl Ester Critical Properties Calculated with Package 2: MP and WJ

methyl ester		T_{nb}	T_c	P_c	V_c	ω
		K	K	kPa	$\text{cm}^3 \cdot \text{mol}^{-1}$	
methyl octanoate	C8:0	419.14	574.23	2111	569.10	0.57
methyl decanoate	C10:0	472.47	629.84	1865	682.30	0.68
methyl dodecanoate	C12:0	525.79	685.55	1539	795.50	0.74
methyl tetradecanoate	C14:0	579.11	742.08	1517	908.70	0.88
methyl pentadecanoate	C15:0	595.67	758.01	1425	965.30	0.90
methyl hexadecanoate	C16:0	611.82	774.04	1341	1021.90	0.91
methyl heptadecanoate	C17:0	627.60	790.25	1265	1078.50	0.91
methyl octadecanoate	C18:0	643.03	806.74	1195	1135.10	0.90
methyl icosanoate	C20:0	672.96	840.86	1071	1248.30	0.86
methyl docosanoate	C22:0	701.76	877.01	965	1361.50	0.77
methyl tetracosanoate	C24:0	845.73	1061.64	1012	1474.70	0.77
methyl hexadec-9-enoate	C16:1	613.57	781.37	1377	1001.30	0.86
methyl <i>cis</i> -10-heptadecenoate	C17:1	639.16	809.12	1318	1057.90	0.89
methyl (Z)-octadec-9-enoate	C18:1	644.72	812.21	1224	1114.50	0.88
methyl (Z)-12-hydroxyoctadec-9-enoate	C18:1 OH	728.04	1014.13	1317	1200.30	0.24
methyl <i>cis</i> -11-eicosenoate	C20:1	674.59	844.37	1096	1227.70	0.86
methyl (Z)-13-docosenoate	C22:1	721.99	901.72	1012	1340.90	0.81
methyl <i>cis</i> -15-tetracosenoate	C24:1	793.08	995.17	966	1510.70	0.73
methyl (Z,Z)-octadeca-9,12-dienoate	C18:2	646.42	818.84	1255	1093.90	0.85
methyl (Z,Z,Z)-octadeca-9,12,15-trienoate	C18:3	648.14	826.68	1287	1073.30	0.80

where N is the number of data points, x_{exp} is the experimental value, and x_{est} is the estimated one.

In the case of FAME, a slight ARD difference can be observed between both methods, but ARD values are within an acceptable range. The error of the methods increases slightly in the case of

low molecular weight methyl esters (C8:0 and C10:0), which can mean that more accurate experimental data for low weighted esters are necessary to check the suitability of used estimation methods. Since no experimental data for critical properties are available, a comparison of estimated values cannot be performed

Table 6. Ethyl Ester Critical Properties Calculated with Package 2: MP and WJ

ethyl ester		T_{nb}	T_c	P_c	V_c	ω
		K	K	kPa	$\text{cm}^3 \cdot \text{mol}^{-1}$	
ethyl octanoate	C8:0	440.29	593.80	1955	657.70	0.63
ethyl decanoate	C10:0	493.62	649.64	1744	770.90	0.74
ethyl dodecanoate	C12:0	546.94	705.92	1576	884.10	0.84
ethyl tetradecanoate	C14:0	600.26	763.36	1441	997.30	0.91
ethyl pentadecanoate	C15:0	616.35	779.34	1356	1053.90	0.92
ethyl hexadecanoate	C16:0	632.06	795.53	1278	1110.50	0.92
ethyl heptadecanoate	C17:0	647.43	812.00	1207	1167.10	0.91
ethyl octadecanoate	C18:0	662.48	828.84	1141	1223.70	0.89
ethyl icosanoate	C20:0	691.71	863.92	1025	1336.90	0.82
ethyl docosanoate	C22:0	719.90	901.40	925	1450.10	0.72
ethyl tetracosanoate	C24:0	866.88	1092.86	969	1563.30	0.69
ethyl hexadec-9-enoate	C16:1	633.87	801.98	1194	1089.90	0.82
ethyl <i>cis</i> -10-heptadecenoate	C17:1	659.45	830.41	1252	1146.50	0.90
ethyl (Z)-octadec-9-enoate	C18:1	664.22	833.36	1073	1203.10	0.82
ethyl (Z)-12-hydroxyoctadec-9-enoate	C18:1 OH	747.46	1060.19	1251	1272.50	0.14
ethyl <i>cis</i> -11-eicosenoate	C20:1	693.39	866.40	969	1316.30	0.78
ethyl (Z)-13-docosenoate	C22:1	787.38	983.99	1028	1429.50	0.82
ethyl <i>cis</i> -15-tetracosenoate	C24:1	838.55	1052.57	955	1542.70	0.72
ethyl (Z,Z)-octadeca-9,12-dienoate	C18:2	665.97	839.04	1099	1182.50	0.80
ethyl (Z,Z,Z)-octadeca-9,12,15-trienoate	C18:3	667.75	845.92	1126	1161.90	0.76

Table 7. Methyl Ester Critical Properties Calculated with Package 3: A and J

methyl ester		T_{nb}	T_c	P_c	V_c	ω
		K	K	kPa	$\text{cm}^3 \cdot \text{mol}^{-1}$	
methyl octanoate	C8:0	457.24	619.72	1958	565.50	0.60
methyl decanoate	C10:0	503.40	666.32	1716	677.50	0.69
methyl dodecanoate	C12:0	541.13	701.89	1527	789.50	0.77
methyl tetradecanoate	C14:0	573.02	730.36	1375	901.50	0.86
methyl pentadecanoate	C15:0	587.30	742.66	1310	957.50	0.90
methyl hexadecanoate	C16:0	611.00	766.95	1250	1013.50	0.93
methyl heptadecanoate	C17:0	613.19	764.37	1196	1069.50	0.97
methyl octadecanoate	C18:0	625.02	774.04	1146	1125.50	1.01
methyl icosanoate	C20:0	646.82	791.52	1058	1237.50	1.08
methyl docosanoate	C22:0	666.54	806.98	983	1349.50	1.15
methyl tetracosanoate	C24:0	684.54	820.85	917	1461.50	1.21
methyl hexadec-9-enoate	C16:1	608.00	765.19	1274	993.50	0.92
methyl <i>cis</i> -10-heptadecenoate	C17:1	610.19	762.51	1220	1049.50	0.96
methyl (Z)-octadec-9-enoate	C18:1	622.20	772.34	1168	1105.50	1.00
methyl (Z)-12-hydroxyoctadec-9-enoate	C18:1 OH	686.15	859.29	1234	1118.50	0.95
methyl <i>cis</i> -11-eicosenoate	C20:1	643.82	789.48	1075	1217.50	1.07
methyl (Z)-13-docosenoate	C22:1	663.54	804.83	997	1329.50	1.14
methyl <i>cis</i> -15-tetracosenoate	C24:1	681.54	818.61	931	1441.50	1.20
methyl (Z,Z)-octadeca-9,12-dienoate	C18:2	639.20	795.33	1191	1085.50	0.99
methyl (Z,Z,Z)-octadeca-9,12,15-trienoate	C18:3	639.20	795.33	1183	1065.50	0.98

neither for FAME nor for FAEE. Because of this reason an easily measurable property such as density has been selected to test the proposed calculation packages.

As can be observed in Figure 2, both CG and MP methods overestimate the boiling temperature for FAEE, but the

prediction of T_{nb} can be performed using package 1 with an ARD of 2.52 %; this package has a better accuracy in this case.

3.2. Density of Methyl Esters and Methanol-Based Biodiesel. A comparison of some experimental pure methyl ester density values⁷ with those calculated with the proposed packages

Table 8. Ethyl Ester Critical Properties Calculated with Package 3: A and J

ethyl ester		T_{nb}	T_c	P_c	V_c	ω
		K	K	kPa	$\text{cm}^3 \cdot \text{mol}^{-1}$	
ethyl octanoate	C8:0	506.32	677.84	1829	630.50	0.64
ethyl decanoate	C10:0	535.75	701.72	1616	742.50	0.73
ethyl dodecanoate	C12:0	561.47	721.70	1447	854.50	0.82
ethyl tetradecanoate	C14:0	584.31	738.89	1310	966.50	0.90
ethyl pentadecanoate	C15:0	594.84	746.66	1250	1022.50	0.93
ethyl hexadecanoate	C16:0	604.85	753.97	1196	1078.50	0.97
ethyl heptadecanoate	C17:0	614.39	760.89	1146	1134.50	1.01
ethyl octadecanoate	C18:0	623.51	767.45	1101	1190.50	1.04
ethyl icosanoate	C20:0	640.61	779.64	1019	1302.50	1.11
ethyl docosanoate	C22:0	656.39	790.79	949	1414.50	1.18
ethyl tetracosanoate	C24:0	671.04	801.09	888	1526.50	1.24
ethyl hexadec-9-enoate	C16:1	599.21	748.79	1220	1058.50	0.96
ethyl <i>cis</i> -10-heptadecenoate	C17:1	609.02	755.98	1168	1114.50	1.00
ethyl (<i>Z</i>)-octadec-9-enoate	C18:1	618.38	762.79	1121	1170.50	1.03
ethyl (<i>Z</i>)-12-hydroxyoctadec-9-enoate	C18:1 OH	640.83	797.09	1232	1183.50	1.02
ethyl <i>cis</i> -11-eicosenoate	C20:1	635.89	775.41	1036	1282.50	1.10
ethyl (<i>Z</i>)-13-docosenoate	C22:1	652.03	786.91	964	1394.50	1.17
ethyl <i>cis</i> -15-tetracosenoate	C24:1	666.98	797.51	901	1506.50	1.23
ethyl (<i>Z,Z</i>)-octadeca-9,12-dienoate	C18:2	613.11	757.98	1141	1150.50	1.02
ethyl (<i>Z,Z,Z</i>)-octadeca-9,12,15-trienoate	C18:3	607.70	751.29	1134	1130.50	1.02

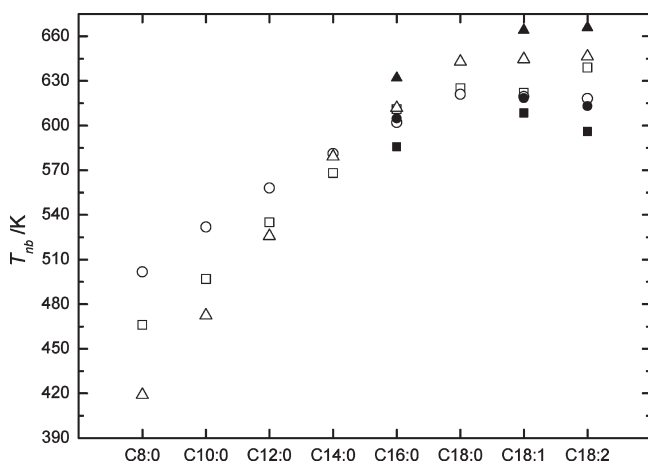

Figure 2. Experimental^{7,33} and estimated values of T_{nb}/K for pure methyl and ethyl esters using CG and MP methods. \square , exp. MeOH; \circ , CG; \triangle , MP; \blacksquare , exp. EtOH; \bullet , CG; \blacktriangle , MP. CG MeOH ARD = 3.25 %, MP MeOH ARD = 3.47 %, CG EtOH ARD = 2.52 %, MP EtOH ARD = 8.75 %.

is shown in Figure 3. ARD values are also reported. It can be observed that package 3 underestimates the densities and shows an ARD of 6.61 %. Package 2 shows a slightly better ARD, but it underestimates the density of high weighted methyl esters such as C20:0 and C21:1. On the other hand, package 1 has the highest ARD, 8.72 %, and overestimates the density of saturated low weighted methyl esters (C8:0 to C15:0). As shown in Table 2, the presence of these esters in biodiesel composition is not usual, and its influence on final biodiesel density is, in most cases, very low. Nevertheless, the results reported are not in

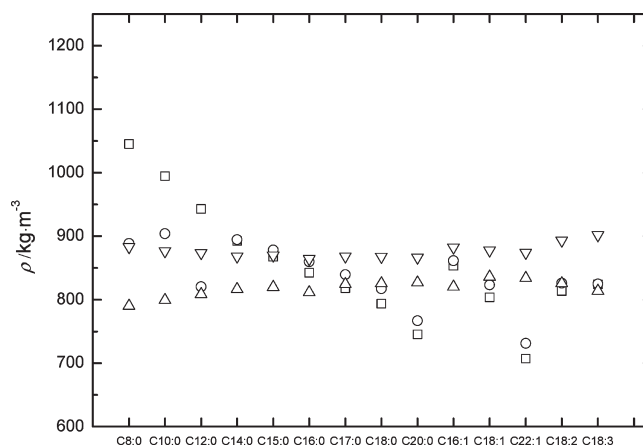

Figure 3. Comparison of pure FAME densities calculated with packages 1 to 3 and experimental values in Lapuerta et al.⁷ \square , package 1; \circ , package 2; \triangle , package 3; ∇ , experimental. ARD (%): package 1 = 8.72, package 2 = 5.42, package 3 = 6.61.

good agreement with the experimental ones in case of low and high chain length esters, while densities of intermediate chain length esters are accurately estimated; this fact may indicate that an improvement is necessary to make the model work in the whole range of chain length.

As commented before, to estimate biodiesel density, following the scheme shown in Figure 1, the critical properties of a pseudocomponent, which represents the biodiesel composition, were calculated by using the LK mixing rules, and the RS equation to estimate density was applied.

Table 9 shows the experimental values of biodiesel density reported by Sanford et al.,²¹ for different raw materials and the

Table 9. Experimental Methanol-Based Biodiesel Density Values^{21,34,35} and Estimated Densities

	exp. ρ	package 1		package 2		package 3	
	kg·m ⁻³	ρ /kg·m ⁻³	error (%)	ρ /kg·m ⁻³	error (%)	ρ /kg·m ⁻³	error (%)
algae 1	878.0	892.7	1.67	879.5	0.17	857.9	2.34
babassu	876.0	892.1	1.84	875.0	0.12	877.3	0.15
beef tallow	874.0	893.7	2.25	875.3	0.15	860.6	1.56
borage	886.5	902.5	1.80	898.8	1.38	875.0	1.32
camelina oil	888.0	915.7	3.12	914.7	3.00	887.2	0.10
canola oil	882.0	894.1	1.37	884.5	0.28	860.8	2.46
castor	899.0	917.0	2.00	873.0	2.89	915.6	1.82
choice white grease	877.0	893.0	1.83	877.7	0.08	860.8	1.89
coconut 1	807.3	893.1	10.63	874.5	8.33	880.4	8.30
coconut 2	874.8	893.0	2.08	875.9	0.13	877.4	0.30
coconut 3	874.7	895.2	2.34	877.9	0.37	879.5	0.55
coffee	881.5	896.6	1.72	883.3	0.20	862.7	2.17
corn	885.0	898.9	1.57	890.8	0.65	870.9	1.62
evening primrose	888.5	896.8	0.93	893.2	0.53	871.3	1.98
hemp	888.5	901.9	1.51	899.3	1.22	876.3	1.40
hepar. high IV	875.5	901.7	2.99	887.2	1.34	870.5	0.58
hepar. low IV	875.5	893.4	2.04	875.8	0.03	860.9	1.70
<i>Jatropha</i>	879.5	893.6	1.61	882.8	0.38	863.0	1.91
linseed	892.5	898.4	0.66	899.0	0.73	873.3	2.19
<i>Moringa oleifera</i>	877.0	897.6	2.35	883.7	0.76	858.7	2.13
neem	884.5	891.6	0.80	876.5	0.91	856.7	3.25
palm	876.0	890.4	1.65	872.3	0.42	860.0	1.86
perilla seed	899.0	899.1	0.01	901.3	0.25	875.7	2.66
poultry fat	880.5	893.5	1.47	880.7	0.02	863.1	2.02
rice bran	885.5	893.6	0.92	882.7	0.31	862.2	2.70
soybean	884.0	895.5	1.30	888.9	0.55	867.6	1.89
sunflower	880.0	893.5	1.53	882.4	0.28	859.5	2.39
used cooking oil	855.5	894.9	4.60	887.0	3.68	866.2	1.23
yellow grease	882.5	893.5	1.25	882.5	0.00	862.9	2.27

estimated values using each package. Additionally, the error (%) for each biodiesel density estimation is also shown. Only two experimental density values are out of the EN 14214 range; coconut 1 and used cooking oil based biodiesel. The low density value in case of coconut 1 biodiesel can be explained due to its high content in low weighted esters (C8:0, C10:0, C12:0, and C14:0) which mean around 80 wt % of that biodiesel. The estimations in this case show high errors, around 10 % for package 1 and 8 % for packages 2 and 3.

To compare with other coconut-based biodiesels, two additional experimental profiles have been taken into account. Coconut 2³⁴ and 3³⁵ show a similar ester profile (see Table 2) to those of coconut 1, but their densities are slightly higher, and they do accomplish the EN 14214 requirements. For coconut 2 and 3 the low weight esters are around 60 wt %, the more plausible explanation being the density differences and the low errors found for the density estimations.

Based on the composition of used cooking oil, which is similar to other reported profiles, the reason of such a density value is not explicable. Used cooking oils usually contain high amounts of impurities which can cause such a behavior if the cleaning step is not carried out properly. In any case, the reported errors are below 5 % for all packages, package 3 being the most accurate with an error of 1.23 %.

Figure 4 shows the error (%) for each biodiesel. With the exception of coconut and UCO biodiesels, both explained before, the error is below 4 % for all packages. Package 2 shows the lowest errors, usually under 1 %, while errors in Packages 1 and 3 are around 2 %. This tendency can also be observed in Figure 5 which shows the experimental versus estimated values for each package. The average relative deviation is also reported. Package 2 shows the lowest ARD of the proposed packages, while packages 1 and 3 over- and underestimate the density values, respectively. As a result, they consider out of the standard range (EN 14214) some biodiesels which do accomplish this specification. In the case of package 2, just a few biodiesels have an error over 1 %; camelina oil, borage, hemp, hepar high IV, castor, coconut 1, and UCO. For the first four biodiesels the explanation of the found deviation could be the high presence of methyl linolenate (C18:3), indicating that more accurate experimental data (normal boiling point and experimental density values) are needed to simulate the critical properties of methyl linolenate. Castor oil based biodiesel shows a similar issue, as the amount of methyl ricinoleate, around 90 wt %, has a strong influence in the final biodiesel properties. The presence of a hydroxyl group in the ricinoleate molecule makes this ester special, so to predict its properties accurately, proper experimental data are needed.

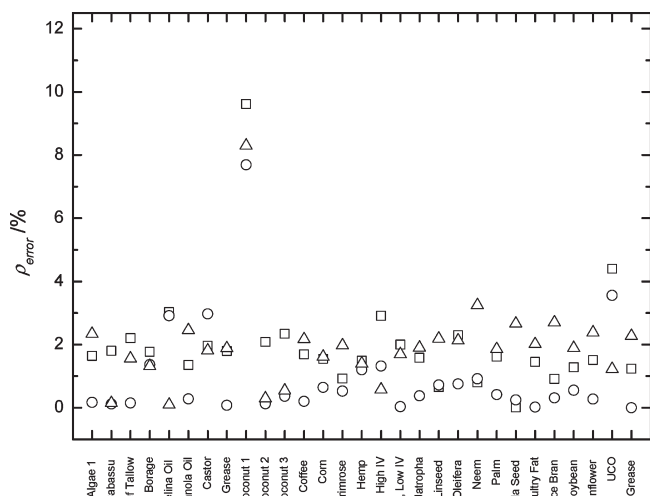

Figure 4. Calculated density errors (%) for each package and biodiesel. □, package 1; ○, package 2; △, package 3.

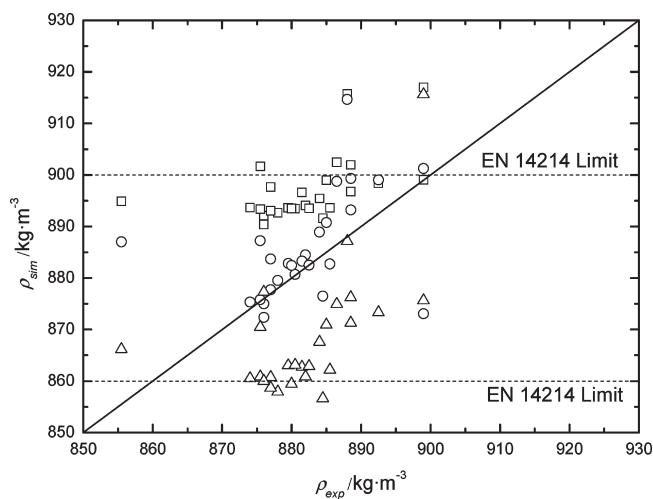

Figure 5. Experimental vs simulated density ($\text{kg}\cdot\text{m}^{-3}$) data for different biodiesels.²¹ □, package 1; ○, package 2; △, package 3. ARD (%): package 1 = 2.05, package 2 = 1.07, package 3 = 2.15.

3.3. Density of Ethyl Esters and Ethanol-Based Biodiesel.

As it has been said before, it is not easy to find pure ethyl ester data. However a few density values can be found in Lapuerta et al.⁷ In Figure 6 the experimental and calculated density values with the three packages and RS equation described above these lines are shown, as well as the calculation of the ARD for each package. The ARD values are higher than those in the FAME density calculation, and unlike the result that has been observed for FAME, package 3 seems to be the best one. On the contrary, package 1 seems to be the worst one to estimate density of pure ethyl esters, almost doubling the ARD from package 3.

While packages 1 and 3 respectively over and underestimate the density of low weighted ethyl esters, package 2 shows a better accuracy. Unfortunately, package 2 underestimates the densities in the case of unsaturated ethyl esters. In this case, the results show that a combination of package 2 and package 3 could be the best option, but once again, the need of new

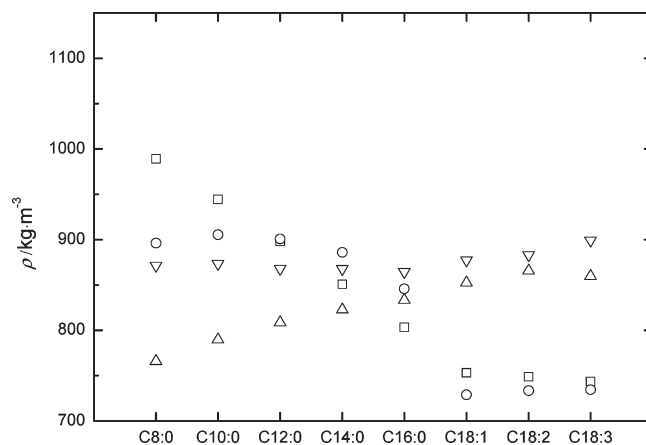

Figure 6. Comparison of pure FAEE densities calculated with packages and reported experimental values in Lapuerta et al.⁷ □, package 1; ○, package 2; △, package 3; ▽, experimental. ARD (%): package 1 = 10.09, package 2 = 8.34, package 3 = 5.81.

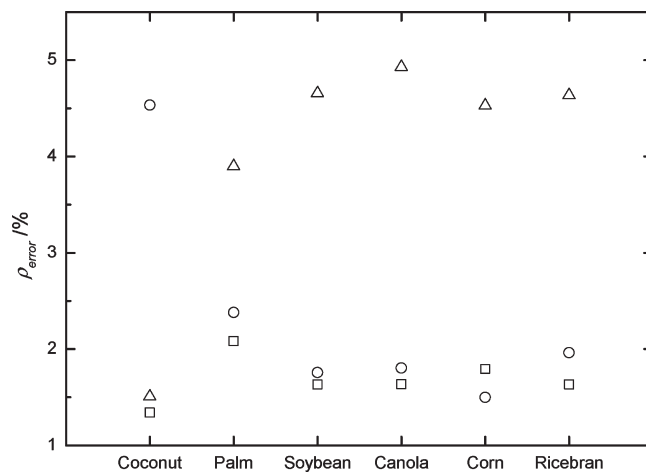

Figure 7. Calculated density errors for each ethyl-based biodiesel. □, package 1; ○, package 2; △, package 3.

experimental density and boiling point data for ethyl esters is clearly a major issue.

Although many papers dealing with ethanolysis of oils and tallows can be found in available literature, just a few of them report an ester profile and density data at 15 °C. Figure 7 shows a comparison of some experimental^{22,23} density values and the estimated ones. It is important to note that just four ethyl esters have been used to describe the composition of the biodiesel due to the lack of a more accurate ester profile description.

Regarding the errors, packages 1 and 2 incur on less error than package 3 compared to the experimental data except for the coconut that, in this case too, shows an awkward behavior; package 1 shows its biggest error for coconut oil, while packages 2 and 3 seem to be relatively accurate. Except for coconut, the error for package 3 is around 4 %, while the error for packages 1 and 2 is most times under 2 %.

Based on the obtained results, it is possible to say that packages 1 and 2 are the best option in the case of ethanol-based biodiesel. In any case, more experimental density data for

ethanol based biodiesel are needed to check the suitability of these models and methods.

4. CONCLUSIONS

In this work three different packages to estimate the critical properties of biodiesel have been compared, using density as a final testing variable. In case of methanol-based biodiesel 20 methyl esters were taken into account, and their critical properties and densities were calculated and compared with available experimental data. Package 2, with an ARD of 5.42 %, showed the highest accuracy when comparing predicted and experimental densities of 14 pure methyl esters. The normal boiling points of some methyl and ethyl esters were also compared with experimental data showing that some improvements are needed, especially for the low weighted methyl esters. The LK mixing rules were used to compute the pseudocomponent critical properties of different methyl ester mixtures, and the results so obtained were compared with experimental ones. The ARD was in all cases lower than 2.1 % and especially for package 2 was 1.0 %. A similar study was performed in the case of ethanol-based biodiesel, but due to the lack of experimental data, just eight ethyl esters were used in the calculations for pure compounds, and four were used in case of ethanol-based biodiesel. Six experimental density values were compared. The results show that packages 1 and 2 are good options to estimate the critical properties of biodiesel mixtures, although more data are needed.

■ AUTHOR INFORMATION

Corresponding Author

*Phone: +34 976 762961. Fax: +34 976 761879. E-mail: manuelgr@unizar.es.

Funding Sources

The authors are grateful to the Spanish Ministry of Science and Innovation for funding this study through project CTQ2010-19811.

■ NOMENCLATURE

T/K	temperature
P/bar	pressure
$V/\text{cm}^3 \cdot \text{mol}^{-1}$	volume
ω	acentric factor
R	universal gas constant
Z	compressibility factor
MW	mass weight
CN	number of carbons in the fatty acid

Subscripts

nb	normal boiling
atm	atmospheric
c	critical
r	reduced
m	relative to mixture
i	component i
Ra	Rackett compressibility factor

■ REFERENCES

- (1) Makareviciene, V.; Janulis, P. Environmental effect of rapeseed oil ethyl ester. *Renewable Energy* **2003**, *28* (15), 2395–2403.
- (2) Demirbas, A. Progress and recent trends in biodiesel fuels. *Energy Convers. Manage.* **2009**, *50* (1), 14–34.

- (3) Karavalakis, G.; Hilari, D.; Givalou, L.; Karonis, D.; Stournas, S. Storage stability and ageing effect of biodiesel blends treated with different antioxidants. *Energy* **2011**, *36* (1), 369–374.
- (4) Bezergianni, S.; Kalogeras, K.; Pilavachi, P. A. On maximizing biodiesel mixing ratio based on final product specifications. *Comput. Chem. Eng.* **2011**, *35* (5), 936–942.
- (5) Rakopoulos, C. D.; Antonopoulos, K. A.; Rakopoulos, D. C.; Hountalas, D. T.; Giakoumis, E. G. Comparative performance and emissions study of a direct injection Diesel engine using blends of Diesel fuel with vegetable oils or bio-diesels of various origins. *Energy Convers. Manage.* **2006**, *47* (18–19), 3272–3287.
- (6) Graboski, M. S.; McCormick, R. L. Combustion of fat and vegetable oil derived fuels in diesel engines. *Prog. Energy Combust. Sci.* **1998**, *24* (2), 125–164.
- (7) Lapuerta, M.; Rodríguez-Fernández, J.; Armas, O. Correlation for the estimation of the density of fatty acid esters fuels and its implications. A proposed Biodiesel Cetane Index. *Chem. Phys. Lipids* **2010**, *163* (7), 720–727.
- (8) Ramírez-Verduzco, L. F.; García-Flores, B. E.; Rodríguez-Rodríguez, J. E.; del Rayo Jaramillo-Jacob, A. Prediction of the density and viscosity in biodiesel blends at various temperatures. *Fuel* **2011**, *90* (5), 1751–1761.
- (9) Pratas, M. J.; Freitas, S.; Oliveira, M. B.; Monteiro, S. C.; Lima, A. S.; Coutinho, J. A. P. Densities and Viscosities of Fatty Acid Methyl and Ethyl Esters. *J. Chem. Eng. Data* **2010**, *55* (9), 3983–3990.
- (10) Tesfa, B.; Mishra, R.; Gu, F.; Powles, N. Prediction models for density and viscosity of biodiesel and their effects on fuel supply system in CI engines. *Renewable Energy* **2010**, *35* (12), 2752–2760.
- (11) Lapuerta, M.; Rodríguez-Fernández, J.; de Mora, E. F. Correlation for the estimation of the cetane number of biodiesel fuels and implications on the iodine number. *Energy Policy* **2009**, *37* (11), 4337–4344.
- (12) Ramos, M. J.; Fernández, C. M.; Casas, A.; Rodríguez, L.; Pérez, Á. Influence of fatty acid composition of raw materials on biodiesel properties. *Bioresour. Technol.* **2009**, *100* (1), 261–268.
- (13) Wu, C.; Zhang, J.; Li, W.; Wang, Y.; Cao, H. Artificial neural network model to predict cold filter plugging point of blended diesel fuels. *Fuel Process. Technol.* **2006**, *87* (7), 585–590.
- (14) Su, Y.-C.; Liu, Y. A.; Diaz Tovar, C. A.; Gani, R. Selection of Prediction Methods for Thermophysical Properties for Process Modeling and Product Design of Biodiesel Manufacturing. *Ind. Eng. Chem. Res.* **2011**, *50* (11), 6809–6836.
- (15) Poling, B. E.; Prausnitz, J. M.; O'Connell, J. P. *The properties of gases and liquids*, 5th ed.; McGraw-Hill: New York, 2001.
- (16) Reid, R. C.; Prausnitz, J. M.; Poling, B. E. *The properties of gases and liquids*, 4th ed.; McGraw-Hill: New York, 1987.
- (17) Anand, K.; Sharma, R. P.; Mehta, P. S. A comprehensive approach for estimating thermo-physical properties of biodiesel fuels. *Appl. Therm. Eng.* **2011**, *31* (2–3), 235–242.
- (18) Yuan, W.; Hansen, A. C.; Zhang, Q. Vapor pressure and normal boiling point predictions for pure methyl esters and biodiesel fuels. *Fuel* **2005**, *84* (7–8), 943–950.
- (19) Spencer, C. F.; Danner, R. P. Improved equation for prediction of saturated liquid density. *J. Chem. Eng. Data* **1972**, *17* (2), 236–241.
- (20) Soave, G. S. A noncubic equation of state for the treatment of hydrocarbon fluids at reservoir conditions. *Ind. Eng. Chem. Res.* **1995**, *34* (11), 3981–3994.
- (21) Sanford, S. D.; White, J. M.; Shah, P. S.; Wee, C.; Valverde, M. A.; Meier, G. R. *Feedstock and Biodiesel Characteristics Report*; Renewable Energy Group, Inc.: Imes, IA, 2009.
- (22) Baroutian, S.; Aroua, M. K.; Raman, A. A. A.; Sulaiman, N. M. N. Densities of Ethyl Esters Produced from Different Vegetable Oils. *J. Chem. Eng. Data* **2008**, *53* (9), 2222–2225.
- (23) Kumar, D.; Kumar, G.; Poonam; Singh, C. P. Fast, easy ethanolation of coconut oil for biodiesel production assisted by ultrasonication. *Ultrason. Sonochem.* **2010**, *17* (3), 555–559.
- (24) Veny, H.; Baroutian, S.; Aroua, M. K.; Hasan, M.; Raman, A. A.; Sulaiman, N. M. N. Density of Jatropha curcas Seed Oil and its Methyl Esters: Measurement and Estimations. *Int. J. Thermophys.* **2009**, *30* (2), 529–541.

- (25) Baroutian, S.; Aroua, M. K.; Raman, A. A. A.; Sulaiman, N. M. N. Density of palm oil-based methyl ester. *J. Chem. Eng. Data* **2008**, *53* (3), 877–880.
- (26) Yuan, W.; Hansen, A. C.; Zhang, Q. Predicting the physical properties of biodiesel for combustion modeling. *Trans. ASAE* **2003**, *46* (6), 1487–1493.
- (27) Tat, M. E.; Van Gerpen, J. H. The specific gravity of biodiesel and its blends with diesel fuel. *J. Am. Oil Chem. Soc.* **2000**, *77* (2), 115–119.
- (28) Blangino, E.; Riveros, A. F.; Romano, S. D. Numerical expressions for viscosity, surface tension and density of biodiesel: analysis and experimental validation. *Phys. Chem. Liq.* **2008**, *46* (5), 527–547.
- (29) Anand, K.; Ranjan, A.; Mehta, P. S. Predicting the Density of Straight and Processed Vegetable Oils from Fatty Acid Composition. *Energy Fuels* **2010**, *24* (5), 3262–3266.
- (30) Vetere, A. Methods to predict the critical constants of organic compounds. *Fluid Phase Equilib.* **1995**, *109* (1), 17–27.
- (31) Clements, L. D., Blending rules for formulating biodiesel fuel. Liquid fuel and industrial products from renewable resources. In *Proceedings of the 3rd Liquid Fuels Conference organized by ASAE*, Nashville, TN, 1996; p 44.
- (32) Yamada, T.; Gunn, R. D. Saturated liquid molar volumes. Rackett equation. *J. Chem. Eng. Data* **1973**, *18* (2), 234–236.
- (33) García Santander, C. M.; Gómez Rueda, S. M.; de Lima da Silva, N.; de Camargo, C. L.; Kieckbusch, T. G.; Wolf Maciel, M. R. Measurements of normal boiling points of fatty acid ethyl esters and triacylglycerols by thermogravimetric analysis. *Fuel* **2011**, *92*, 158–161.
- (34) Nakpong, P.; Wootthikanokkhan, S. High free fatty acid coconut oil as a potential feedstock for biodiesel production in Thailand. *Renewable Energy* **2010**, *35* (8), 1682–1687.
- (35) Feitosa, F. X.; Rodrigues, M. d. L.; Veloso, C. B.; Cavalcante, C. I. L.; Albuquerque, M. n. C. G.; de Sant'Ana, H. B. Viscosities and Densities of Binary Mixtures of Coconut + Colza and Coconut + Soybean Biodiesel at Various Temperatures. *J. Chem. Eng. Data* **2010**, *55* (9), 3909–3914.

Artículo V



Contents lists available at SciVerse ScienceDirect

Fuel

journal homepage: www.elsevier.com/locate/fuel

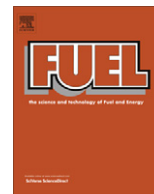

Density of alkyl esters and its mixtures: A comparison and improvement of predictive models

Manuel García*, Juan-José Alba, Alberto Gonzalo, José Luis Sánchez, Jesús Arauzo

Thermochemical Processes Research Group (GPT), University of Zaragoza, Mariano Esquillor s/n, I+D Bld., 50018 Zaragoza, Spain
Aragón Institute of Engineering Research (I3A), Universidad de Zaragoza, Mariano Esquillor s/n, I+D Bld., 50018 Zaragoza, Spain

HIGHLIGHTS

- ▶ The aim of this work is to improve existing models to predict biodiesel density.
- ▶ New density data with methanol and ethanol and detailed composition are presented.
- ▶ A correlation for biodiesel acentric factor has been developed for theoretical prediction.
- ▶ A ethanol biodiesel density empirical model is proposed.

ARTICLE INFO

Article history:

Received 27 February 2012
Received in revised form 8 June 2012
Accepted 19 July 2012
Available online xxxxx

Keywords:

Biodiesel
Density
Modeling
FAME
FAEE

ABSTRACT

Biodiesel density is a key parameter in biodiesel simulations and process development. In this work we selected, evaluated and improved two density models; one theoretical (Rackett–Soave) and one empirical (Lapuerta's method) for methanol based biodiesels (FAME) and ethanol based biodiesel (FAEE). For this purpose, biodiesel was produced from vegetable oils (sunflower, rapeseed, soybean, olive, safflower and two other commercial mixtures of vegetable oils) and animal fats (edible and crude pork fat and beef tallow) using both methanol and ethanol for the transesterification reactions, and blended to get 21 FAME and 21 FAEE, reporting their density and detailed composition. Bibliographic data have also been used. The Rackett–Soave method has been improved by the use of a new acentric factor correlation, whereas the parameters of the empirical one are improved by considering a bigger density data bank. Results show that the evaluated models could be used to estimate the biodiesel density with a good grade of accuracy but the performed modifications improve the accuracy of the models: ARD (%) for FAME; 0.33, and FAEE; 0.26, both calculated with the modification of Rackett–Soave method and ARD (%) for FAME; 0.40 calculated with the modification of Lapuerta's method.

© 2012 Elsevier Ltd. All rights reserved.

1. Introduction

The physicochemical properties of biodiesel have attracted much attention in the last years. As a mixture of different alkyl esters, fatty acid methyl esters (FAMEs) or fatty acid ethyl esters (FAEEs), biodiesel composition depends on the raw materials that are used. Vegetal oils and some kinds of animal tallows are typically used [1] to produce biodiesel but depending on the composition of the used raw materials, biodiesel properties can show a low quality performance in some aspects.

For its commercialization, biodiesel must fulfill the conditions established by relevant standards, such as EN 14214:2008 +

A1:2009 (EU) or ASTM 6751-07 (USA). In addition, the raw materials cost represents more than 80% of the total, [2] which is why the search of new triglycerides sources [1,3] is currently a major issue.

Modeling the final properties of biodiesel could be an interesting tool to find a combination of low-cost raw materials which can be used to produce biodiesel within the ranges established by quality standards. Along these lines, many papers dealing with modeling and estimation of physical properties of biodiesel can be found in available literature. Some properties such as cetane number [4] and iodine value [5] can be estimated by using empirical correlations, as well as Cold Filter Plug Point or Cloud Point [6,7]. A comprehensive study of prediction models for biodiesel properties, including density, was conducted by Su et al. [8].

Biodiesel density is an important variable which has strong influence in the combustion process, engine injection system [9] and spray atomization. The presence of biodiesel in diesel blends affects the fuel thermophysical properties in a high degree and that

* Corresponding author at: Thermochemical Processes Research Group (GPT), University of Zaragoza, Mariano Esquillor s/n, I+D Bld., 50018 Zaragoza, Spain. Tel.: +34 976 762961; fax: +34 976 761879.
E-mail address: manuelgr@unizar.es (M. García).

Nomenclature

Abbreviations

FAME fatty acid methyl esters
 FAEE fatty acid ethyl esters
 FFA free fatty acid
 UD unsaturation degree
 LC length chain
 RD (%) relative deviation
 ARD (%) average relative deviation
 LP Lapuerta's Method

Greeks symbols

ω acentric factor
 ρ density (g cm^{-3})

Symbols

T temperature (K)

P pressure (kPa)
 V volume ($\text{m}^3 \text{mol}^{-1}$)
 R universal gas constant ($\text{J K}^{-1} \text{mol}^{-1}$)
 Z_{Ra} compressibility factor
 MW mass weight (g mol^{-1})

Subscripts

nb normal boiling point
 atm atmospheric
 c critical
 r reduced
 m relative to mixture
 i component i

influence must be taken into account in all estimations and technical calculations such as combustion models, atomization and combustion processes [10]. Moreover, density values are needed to design the biodiesel production process including separation units, such as decanters, centrifugal units, distillation columns and piping. For that reason a prediction tool, capable of estimating the biodiesel density, could be a very useful way to improve the commercial and production strategies by selecting the raw materials prior to the biodiesel production.

In order to estimate biodiesel density two different methodologies are typically used; theoretically based approaches and empirical or semi-empirically based correlations.

One of the most commonly employed methods for estimating the saturated liquid density is the Rackett equation and its modifications [11]. A summary of works dealing with biodiesel density estimation using this method was reported in our previous work [12].

Reid et al. [13] summarize a number of theoretical methods for estimating the saturated liquid density. The Hankinson and Thomson method was modified by Thomson et al. [14] to allow the prediction of compressed liquid volumes and comprises a set of equations in terms of critical properties, tabulated constants and a specially computed acentric factor. Another significant method is the Bhirud [15] method for nonpolar fluids. Using a group contribution method, Elbro et al. [16] reported a method for the prediction of liquid densities as a function of temperature from the triple point to the normal boiling point.

The theoretical models discussed in the previous paragraphs have been developed for the estimation of the density of any liquid, regardless of its composition and origin. A different approach is the use of empirical models or correlations specifically fitted for biodiesel. Just as the theoretical models, the empirical ones use composition as input, and additionally, can use other empirical measurements or composition/structural derived coefficients and improve the accuracy of the predicted density.

The existing models in the literature for estimating biodiesel density are generally based on the composition of biodiesel, usually taking into account the influence of temperature. A summary of equations which represent the dependency of density with temperature was reported by Lapuerta et al. [9]. Moreover, they proposed an equation in terms of the number of atoms in the original alcohol, the number of atoms in the original fatty acid and the number of double bonds in the fatty acid molecule (they use the average values for different biodiesels). The coefficients of the equation were correlated using data available in literature reported by Sanford et al. [17].

Other empirical models have also been used to predict the density of biodiesel–diesel blends. Alptekin and Canacki [18] and Yoon et al. [19] reported models for predicting sunflower, soybean, canola, corn, cottonseed, and waste palm biodiesels–diesel blends. The methodology of these models usually deals with the correlation of experimental data using a linear or polynomial equation. In the same way, Ramírez-Verduzco et al. [20] reported a simple empirical correlation to predict the density of biodiesel blends at various temperatures, which is characterized by only three adjustable parameters.

Recently, artificial neural networks (ANNs) have been used for predicting the final properties of biodiesel with good results [21]. In the same way, Baroutian et al. [22] used an ANN in order to model the temperature dependency of palm oil based biodiesel density.

In this work, a comparison and validation of different selected models (explained in following sections) to estimate biodiesel (FAME and FAEE) density were performed at the temperature established by standards EN 14214 and ASTM 6751 (15 °C).

In order to achieve representative results, biodiesels departing from different raw materials have been produced, mixed and the ester profile and density were analyzed. A bibliographical search was carried out in order to expand the data bank with the aim of selecting the most accurate estimation model for biodiesel density, for both, methanol and ethanol based biodiesel. Using the new experimental data and the bibliographical ones, the reported models were tested and some modifications were introduced in order to improve its accuracy.

2. Materials and methods

2.1. Materials and biodiesel preparation

Sunflower, rapeseed, soybean, olive, safflower and other two kinds of vegetable oils (mixtures of vegetable oils) were purchased, mixed and used directly. Three different animal raw materials were used in this work: commercial edible pork fat, which was purchased and used directly, crude pork fat, which was provided by the Spanish company LIPSA (Santa Perpetua de Mogoda, Barcelona, Spain), and natural beef tallow, acquired in some slaughterhouses in Tudela (Navarra, Spain). Fat was extracted from this beef tallow by heating it and removing the solid residue. The obtained product was finally filtered and stored. The acid value of the animal fats was determined by volumetric titration according to the standard ISO 660 (2002) and all values were below 1 wt.% FFA.

Reagents used during biodiesel synthesis and purification steps were: methanol (assay (GLC) $\geq 99.9\%$, Carlo Erba Reagents), ethanol (99%, Panreac), sulfuric acid (96%, Panreac), sodium methoxide (ca. 25 wt.% solution in methanol, Sigma–Aldrich), sodium ethoxide (ca. 21 wt.% solution in ethanol, Sigma–Aldrich) and Magnesium sulfate (anhydrous, Scharlau). A dissolution of methyl heptadecanoate (standard for GC, Fluka Analytical) in heptane (standard for GC, Fluka Analytical) was used as an internal standard for the GC determinations.

Biodiesel was produced by alkaline transesterification in a batch reactor (2000 mL glass vessel) equipped with a mechanical stirrer, a condenser and a thermocouple. The reaction temperature was set to 60 °C (333.15 K) for methanolysis and 78 °C (351.15 K) for ethanolysis and stirring speed was set to 600 rpm in order to avoid mass transfer problems. A complete description of the experimental procedure can be found elsewhere [23].

2.2. Experimental measurements

Fatty acid composition was determined by gas chromatography (GC) according to EN 14103 (2003) and ISO 5508 (1990). Methyl and ethyl esters were determined using gas chromatography with a flame ionization detector (GC–FID) system, an Agilent 6890 Series GC System gas chromatograph, with a DB-225 MS (Agilent) column (30 m \times 0.25 mm \times 0.25 μ m). The injector and detector (FID) temperatures were set at 250 °C. The used carrier gas was He with a flow of 1 mL/min. Injection was made in a split mode, using a split flow ratio of 35:1, the volume injected was 1 μ L. The following temperature program was used: initial temperature 170 °C, then heating at 3 °C/min to 203 °C, at 1.5 °C/min to 214 °C, then at 5 °C/min to 230 °C and holding at that temperature for 16 min. Density of biodiesel samples was determined according to standard EN 12185.

3. Calculation

3.1. Density data bank

In order to face the validation and improvement of density models, the collection of a data bank is a primary issue. Since the aim of this work is to validate models for density of biodiesel produced through different sources, a detailed description of the composition is required for FAME and FAEE. Although many papers dealing with biodiesel density can be found in available literature, the amount of them which report a detailed ester profile is scarce. For this study we have selected those which report density values at 15 °C (288.15 K) and a minimum of seven alkyl esters in the composition of biodiesel. Therefore, for this study, produced biodiesels have been also analyzed and their composition for FAME and FAEE based biodiesel respectively can be found at www.pangaea.de (<http://dx.doi.org/10.1594/PANGAEA.783283>) in electronic form. Twenty-one samples were produced for FAME and FAEE respectively.

In case of FAME eleven additional data from Refs. [24–29] can be observed in the corresponding figures. Twenty-five data extracted from Sanford et al. [17] and 10 from Pratas et al. [30] were also used to test the models, but these data are not shown in any figure for brevity. In case of ethanol based biodiesel just six data [31,32] with a complete ester profile were found, and are shown in the corresponding figures. Bibliographical reviewed data are not included in the data stored at www.pangaea.de.

3.2. Density calculation

Two different models were chosen for the calculation of density, the Rackett–Soave and the model proposed by Lapuerta et al. [9].

The Rackett–Soave method is a theoretical one, based on the Rackett expression to compute density [11], Eq. (1), and on the Soave equation to compute the factor Z_{Ra} [14], Eq. (2). This method is one of the most used in the past and nowadays bibliography for density prediction, due to its high degree of accuracy and simplicity of application. On the other hand, from the consulted bibliography regarding empirical density models, the expression by Lapuerta et al. [9], Eq. (3), is the one with smallest error.

$$\rho = \frac{MW_m}{\frac{RT_{cm}}{P_{cm}} Z_{Ra}^{1+(1-T_r)^{2/7}}} \quad (1)$$

$$Z_{Ra} = 0.02908 - 0.099\omega + 0.04\omega^2 \quad (2)$$

$$\rho = 851.4714 + \frac{250.718 \cdot UD + 280.899 - 92.180 \cdot (n - 1)}{1.214 + LC} \quad (3)$$

The use of the Rackett–Soave equations (Eqs. (1) and (2)) implies the estimation of critical properties (T_c , P_c and V_c), normal boiling point (T_{nb}) and acentric factor (ω) of each alkyl ester. Since experimental values of critical properties of alkyl esters are not available in open literature, estimation methods were used to perform the calculations. These methods are Constantinou and Gani (CG), Marrero and Pardillo (MP), Wilson & Jasperson (WJ), Ambrose (A), Joback (J) and Lee–Kesler equations (L–K). A detailed description of these methods can be found in Reid et al. [13] and Poling et al. [33]. In a previous work [12] we analyzed the accuracy of these models by selecting a combination of them in order to obtain three estimation packages which can be used to estimate the needed parameters for Rackett–Soave equations. The standard procedure can be seen in Fig. 1.

For clarity we summarize below the methods used in the three packages:

- Package 1. This package calculates the critical properties by the group contribution method. The Constantinou and Gani method (which considers two orders of group contribution) is used to calculate critical temperature (T_c) and volume (V_c) and normal boiling point temperature (T_{nb}), and Wilson–Jasperson method is used to estimate critical pressure (P_c). The acentric factor (ω) is calculated in the three packages by the Lee–Kesler equation.
- Package 2. This package uses a group interaction method, Marrero and Pardillo, to calculate T_c , V_c and T_{nb} . P_c is calculated with the Wilson–Jasperson method as in Package 1.

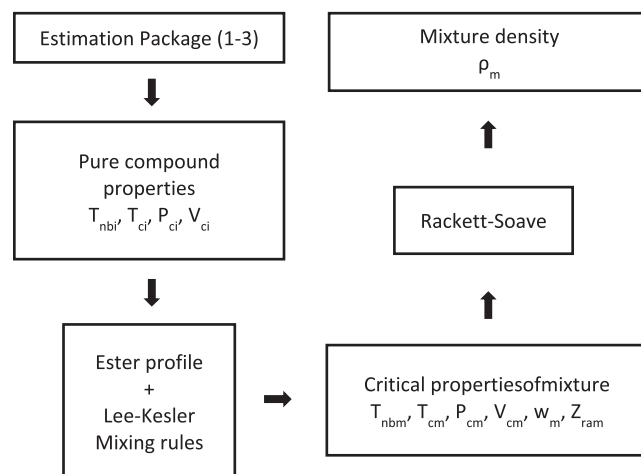

Fig. 1. Standard procedure for density calculations using Rackett–Soave equation.

– Package 3. In this last package we use the Ambrose method for T_c and P_c calculation, and Joback method for V_c . T_{nb} was calculated with the correlation reported by Yuan et al. [34]. This package is also based on the group contribution method, as Package 1, with the difference that this one considers only first order group contributions.

A detailed description of these packages can be found in García et al. [12].

Lapuerta's model was applied directly after computing the necessary parameters, from each biodiesel composition, shown in Eq. (3). LC and UD are the length chain and the unsaturation degree respectively, and n is the number of carbon atoms in the original alcohol used. A description of these parameters can be found in Lapuerta et al. [9].

In order to validate and compare the models used in this work, the relative deviations (RDs) of predicted densities for each biodiesel were estimated according to Eq. (4) and the average relative deviation (ARD) was calculated according to Eq. (5).

$$RD (\%) = \frac{|x_{exp,i} - x_{est,i}|}{x_{exp,i}} \cdot 100 \quad (4)$$

$$ARD (\%) = \frac{\sum_i^N \frac{|x_{exp,i} - x_{est,i}|}{x_{exp,i}}}{N} \cdot 100 \quad (5)$$

4. Results and discussion

In the case of methanol based biodiesel, the amount of available information is appreciably higher than in the case of ethanol based biodiesel and ester profile – density data can be found more easily. Fig. 2 shows the experimental density values of the biodiesels produced in our laboratory (codes 1–21) and retrieved from bibliography (code 22: [24], 23: [25], 24 and 25: [29], 26–29: [26], 30: [27], 31 and 32: [28]). Estimated densities and RD (%) are also shown for each package (1)–(3) using the Rackett–Soave and Lapuerta methods in Figs. 3 and 4. Package 2 and Lapuerta's correlation (Fig. 4) show the lowest ARD. It is important to note that Lapuerta's correlation was fitted using the data reported by Sanford et al. [17] while the data shown in Fig. 2 are experimental, obtained in this work, and reported by other authors. This result indicates that both methodologies, Package 2 (theoretical) and Lapuerta's correlation (empirical), may be used to estimate the biodiesel density with a good grade of accuracy. On the other hand and focusing the attention on the individual RD (%) of biodiesels, castor biodiesel shows a

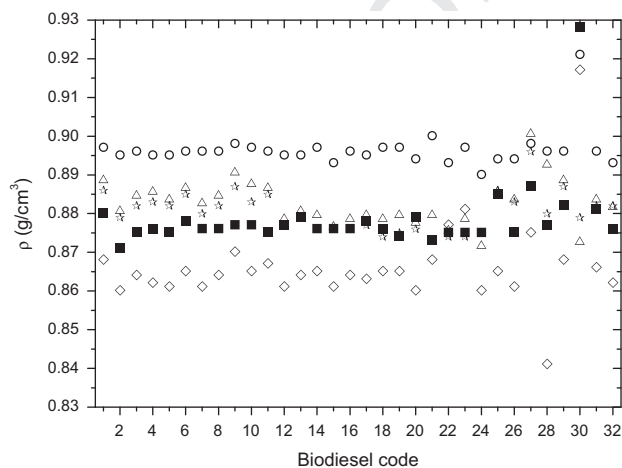

Fig. 2. Experimental and predicted MeOH based biodiesel densities. ■ Experimental, ○ Package 1, △ Package 2, ◇ Package 3, ☆ LP.

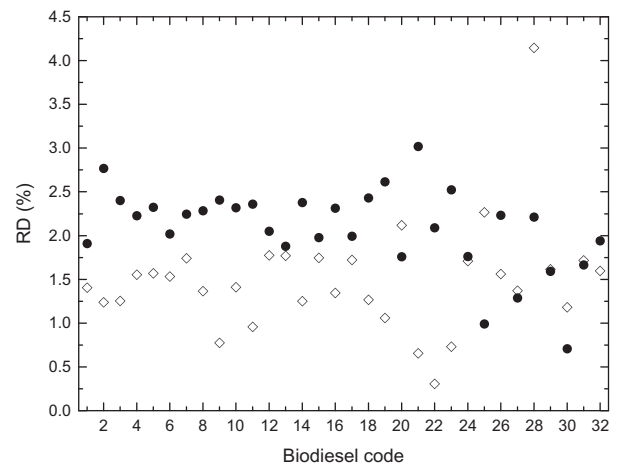

Fig. 3. RD (%) of MeOH based biodiesels using Packages 1 and 3. ●, Package 1; ◇, Package 3.

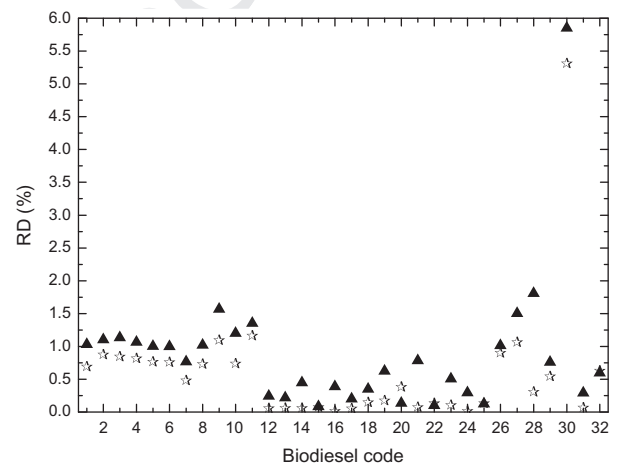

Fig. 4. RD (%) of MeOH based biodiesels using Package 2 and LP correlation. ▲, Package 2; ☆, LP correlation.

slightly higher RD for Package 2 (5.88%) and Lapuerta's method (LP) (5.31%) correlation than for Packages 1 and 3. Biodiesel from castor oil [27] (code 30 in Fig. 2) is composed almost entirely from methyl ricinoleate, which accounts for 90.2% of the methyl esters and is not typically present in other oil sources. The presence in the molecule of a hydroxyl group confers the esters of ricinoleic acid different properties and, in this case, the best models for common biodiesel incur in a higher error for castor biodiesel density.

In order to expand the available data bank, the data reported by Sanford et al. [17] and Pratas et al. [30] in combination with those reported in Fig. 2 were used to compare the estimation methods used, making a total of 67 biodiesels. The ARD's of this complete set are: Package 1 = 2.08%, Package 2 = 0.76%, Package 3 = 1.78%, and LP correlation = 0.66%. The correlation proposed by Lapuerta et al. [9] reports very good results for all biodiesels except for the castor oil based one. Package 2 also incurs in a higher error in this case. The ARD for LP correlation and Package 2 are below 1% indicating a very good accuracy of these methods. Regarding the theoretical approaches to the Rackett–Soave model, the best accuracy is obtained with Package 2, which is based on the group interaction theory to compute the critical properties of biodiesel components.

In the case of ethanol based biodiesels, a data bank composed of twenty-seven biodiesels (21 from this work, and 6 from bibliographical sources) was used for all the calculations. The experimental densities obtained in this work can be also found in

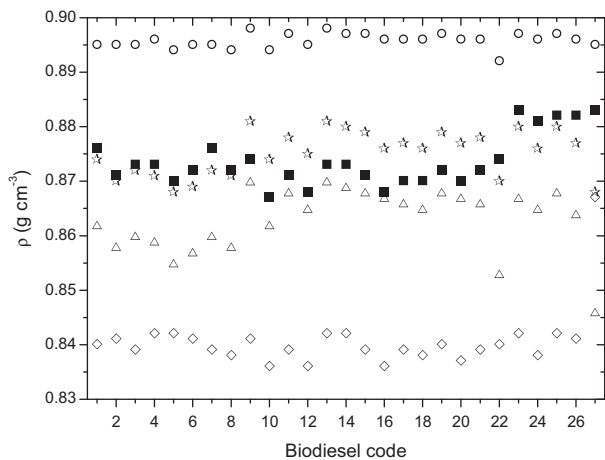

Fig. 5. Experimental and predicted EtOH based biodiesel densities. ■ Experimental, ○ Package 1, △ Package 2, ◇ Package 3, ☆ LP.

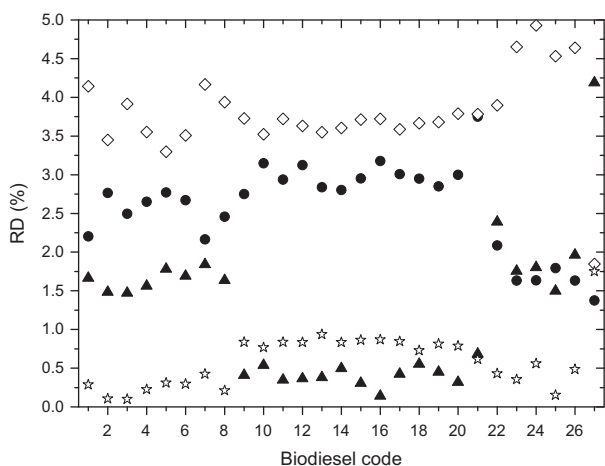

Fig. 6. RD (%) of EtOH based biodiesels. ●, Package 1; ▲, Package 2; ◇, Package 3; ☆, LP correlation.

Fig. 5, with the predicted ones. Biodiesel codes shown in this figure and those that follow for EtOH biodiesel are: 1–21: obtained in this work, 22–26: [32], 27: [31].

As in the case of methanol based biodiesels, Package 2 and Lapuerta's method report the lowest ARD, 1.19% and 0.60% respectively. Following the same tendency as in the case of MeOH biodiesel, packages 1 and 3 over and sub estimate the biodiesel density respectively. Fig. 6 shows the RD (%) for all reported biodiesels. With the exception of palm kernel biodiesel, the RD for Package 2 is below 2.4% showing a good general accuracy. Lapuerta's method shows the best results for both, produced and bibliographical data.

4.1. Modifications on reported methods and correlations

Using the new experimental data reported in this work, from produced biodiesels and collected bibliographical data, some modifications have been performed in order to improve the accuracy of the best models; Package 2 and LP correlation.

Based on Eq. (3), proposed by Lapuerta et al. [9], a new equation (Eq. (6)) for density of FAME biodiesel was adjusted taking into account the 21 measured MeOH based biodiesels and 32 data of Sanford et al. [17]. Constants A to D are adjustable parameters and UD and LC were defined previously. Since parameter n in Eq. (3) is

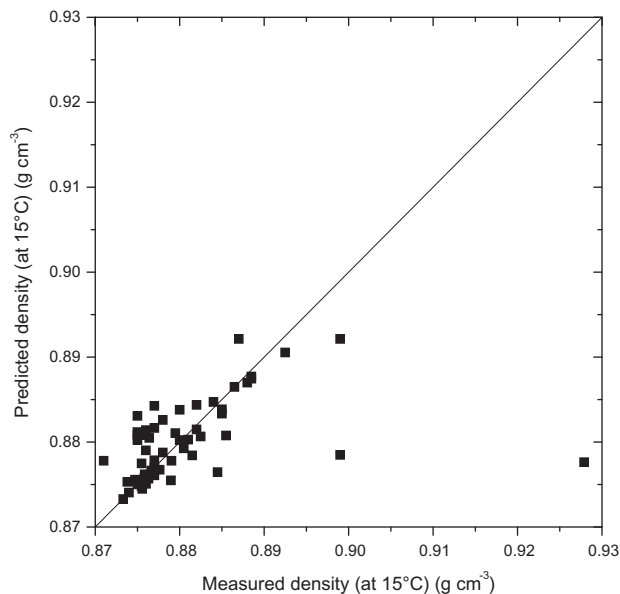

Fig. 7. Estimated vs. measured densities for FAME biodiesel using the modified LP correlation.

equal to 1 in the case of methanol based biodiesels, this parameter was not taken into account in the calculations. In order to obtain the values of these constants, the minimization of the ARD (%) was carried out using the Solver tool available in Excel v2010.

$$\rho = A + \frac{B \cdot UD + C}{D + LC} \quad (6)$$

Once the minimization was performed, the values obtained for the constants are: $A = 0.84913$, $B = 0.21483$, $C = 0.35162$, $D = 1.07833$. Fig. 7 shows the predicted vs. measured density values using Eq. (6) and the new constants. The ARD (%) using this modified correlation is 0.40%. As can be observed in Fig. 7 the modified LP correlation adjusts the measured data well, but also underestimates the density of the castor based biodiesel. The minimal improvement obtained by including more data in the adjusting process of Eq. (6) indicates that the LP correlation was well correlated but can be improved with the new reported data. In both cases the density of castor oil based biodiesels cannot be estimated accurately using these methods.

The modification of Package 2 implies a different strategy due to its theoretical nature. The application of this package involves the estimation of critical properties and the normal boiling point of the mixture (biodiesel), and departing from these values the acentric factor of the mixture (ω_m) is calculated using the Lee–Kesler equations which involve those critical properties of mixture. These equations are actually a correlation of acentric factor and critical properties adjusted by using several data. In this work we propose a new correlation for the estimation of ω_m as a function of the molecular weight of the mixture and critical temperature and pressure of the mixture.

The optimization procedure can be summarized as follows:

- i. The solver tool available in Excel was used to find, for each biodiesel, the acentric factor (mixture) which minimizes the RD (%).
- ii. Departing from the optimal acentric factors ($\omega_{m-opt.}$) previously obtained, a linear equation which correlates $\omega_{m-opt.}$ and T_{cm} , P_{cm} and MW_m was adjusted using partial least squares regression, obtaining the parameters shown in Eq. (7).

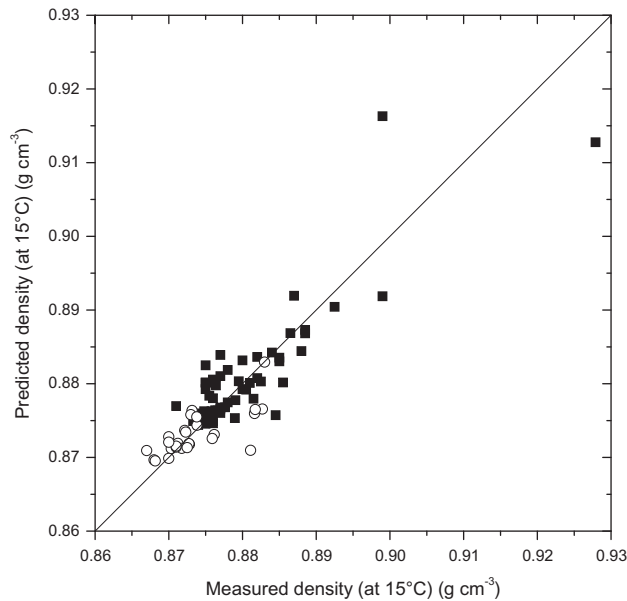

Fig. 8. Estimated vs. measured densities for biodiesel using the modified Package 2. ■ MeOH based biodiesel, ○ EtOH based biodiesel.

$$\omega_m = 3.66098 + 0.00415 \cdot T_{cm} - 0.19871 \cdot P_{cm} - 0.01203 \cdot MW_m \quad (7)$$

The new acentric factor correlation (Eq. (7)), with a correlation coefficient of $R^2 = 0.969$ was used subsequently to calculate Z_{Ra} and finally the density of biodiesels. Fig. 8 shows the predicted densities using Eq. (7) and Package 2 and the experimental values. The ARD (%) for this modified method is 0.33.

Following the same procedure as in the case of methanol based biodiesel, Package 2 was modified and a new acentric factor correlation (Eq. (8)) was adjusted using the available data for ethanol based biodiesels. In this case the correlation coefficient is $R^2 = 0.933$.

$$\omega_m = 5.47113 + 0.00972 \cdot T_{cm} - 0.3485 \cdot P_{cm} - 0.02675 \cdot MW_m \quad (8)$$

Fig. 8 shows the predicted vs. measured density values using the modified Package 2. The ARD (%) using this modified correlation is 0.26% showing an important improvement over the not modified method. In any case, more experimental data for FAEE are needed in order to improve the models in future investigations.

5. Conclusions

Two density models (theoretical and empirical) were evaluated for methanol and ethanol based biodiesels with a large number of experimental and bibliographical data. These models were also improved using the new reported data rendering a good final accuracy for the prediction of biodiesel density at 15 °C. In the case of methanol based biodiesels, the evaluated and improved methods can be considered suitable for using it in a biodiesel simulation or in a biodiesel production plant. As for FAEE models, they report a good accuracy but due to the lack of bibliographical data a complete evaluation cannot be performed. Ethanol based biodiesel is currently under development and their properties are not yet standardized, but the comparison carried out in this work can be a first step in this direction.

Acknowledgement

The Spanish Ministry of Science and Innovation is acknowledged for funding this work through project CTQ2010-19811.

References

- [1] Singh SP, Singh D. Biodiesel production through the use of different sources and characterization of oils and their esters as the substitute of diesel: a review. *Renew Sust Energy Rev* 2010;14:200–16. 433
- [2] Lim S, Teong LK. Recent trends, opportunities and challenges of biodiesel in Malaysia: an overview. *Renew Sust Energy Rev* 2010;14:938–54. 434
- [3] Balat M. Potential alternatives to edible oils for biodiesel production – a review of current work. *Energy Convers Manage* 2011;52:1479–92. 435
- [4] Lapuerta M, Rodríguez-Fernández J, de Mora EF. Correlation for the estimation of the cetane number of biodiesel fuels and implications on the iodine number. *Energy Policy* 2009;37:4337–44. 436
- [5] Ramos MJ, Fernández CM, Casas A, Rodríguez L, Pérez Á. Influence of fatty acid composition of raw materials on biodiesel properties. *Bioresour Technol* 2009;100:261–8. 437
- [6] Wu C, Zhang J, Li W, Wang Y, Cao H. Artificial neural network model to predict cold filter plugging point of blended diesel fuels. *Fuel Process Technol* 2006;87:585–90. 438
- [7] Bezergianni S, Kalogerak K, Pilavachi PA. On maximizing biodiesel mixing ratio based on final product specifications. *Comput Chem Eng* 2011;35:936–42. 439
- [8] Su Y-C, Liu YA, Diaz Tovar CA, Gani R. Selection of prediction methods for thermophysical properties for process modeling and product design of biodiesel manufacturing. *Ind Eng Chem Res* 2011;50:6809–36. 440
- [9] Lapuerta M, Rodríguez-Fernández J, Armas O. Correlation for the estimation of the density of fatty acid esters fuels and its implications. A proposed biodiesel cetane index. *Chem Phys Lipids* 2010;163:720–7. 441
- [10] Yuan W, Hansen AC, Zhang Q. Predicting the physical properties of biodiesel for combustion modeling. *Trans ASAE* 2003;46:1487–93. 442
- [11] Spencer CF, Danner RP. Improved equation for prediction of saturated liquid density. *J Chem Eng Data* 1972;17:236–41. 443
- [12] García M, Alba J-J, Gonzalo A, Sánchez JL, Arauzo J. Comparison of methods for estimating critical properties of alkyl esters and its mixtures. *J Chem Eng Data* 2011;57:208–18. 444
- [13] Reid RC, Prausnitz JM, Poling BE. *The properties of gases and liquids*. 4th ed. New York: McGraw-Hill; 1987. 445
- [14] Thomson GH, Brobst KR, Hankinson RW. An improved correlation for densities of compressed liquids and liquid mixtures. *AIChE J* 1982;28:671–6. 446
- [15] Bhurud VL. Saturated liquid densities of normal fluids. *AIChE J* 1978;24:1127–31. 447
- [16] Elbro HS, Fredenslund A, Rasmussen P. Group contribution method for the prediction of liquid densities as a function of temperature for solvents, oligomers, and polymers. *Ind Eng Chem Res* 1991;30:2576–82. 448
- [17] Sanford SD, White JM, Shah PS, Wee C, Valverde MA, Meier GR. Feedstock and biodiesel characteristics report. Renewable Energy Group, Inc.; 2009. <<http://www.regfuel.com/pdfs/Feedstock%20and%20Biodiesel%20Characteristics%20Report.pdf>>. 449
- [18] Alptekin E, Canakci M. Determination of the density and the viscosities of biodiesel–diesel fuel blends. *Renew Energy* 2008;33:2623–30. 450
- [19] Yoon SH, Park SH, Lee CS. Experimental investigation on the fuel properties of biodiesel and its blends at various temperatures. *Energy Fuel* 2008;22:652–6. 451
- [20] Ramírez-Verduzco LF, García-Flores BE, Rodríguez-Rodríguez JE, delRayo Jaramillo-Jacob A. Prediction of the density and viscosity in biodiesel blends at various temperatures. *Fuel* 2011;90:1751–61. 452
- [21] Balabin RM, Lomakina EI, Safieva RZ. Neural network (ANN) approach to biodiesel analysis: analysis of biodiesel density, kinematic viscosity, methanol and water contents using near infrared (NIR) spectroscopy. *Fuel* 2011;90:2007–15. 453
- [22] Baroutian S, Aroua MK, Raman AA, Sulaiman NM. Prediction of palm oil-based methyl ester biodiesel density using artificial neural networks. *J Appl Sci Data* 2008;8:1938–43. 454
- [23] García M, Gonzalo A, Sánchez JL, Arauzo J, Simoes C. Methanolysis and ethanolysis of animal fats: a comparative study of the influence of alcohols. *Chem Ind Chem Eng Q* 2011;17:91–7. 455
- [24] Nakpong P, Wootthikanokkhan S. High free fatty acid coconut oil as a potential feedstock for biodiesel production in Thailand. *Renew Energy* 2010;35:1682–7. 456
- [25] Feitosa FX, Rodrigues MdL, Veloso CB, Cavalcante CIL, Albuquerque MnCG, de Sant’Ana HB. Viscosities and densities of binary mixtures of coconut + colza and coconut + soybean biodiesel at various temperatures. *J Chem Eng Data* 2010;55:3909–14. 457
- [26] Lang X, Dalai AK, Bakhshi NN, Reaney MJ, Hertz PB. Preparation and characterization of bio-diesels from various bio-oils. *Bioresour Technol* 2001;80:53–62. 458
- [27] Conceição MM, Candeia RA, Silva FC, Bezerra AF, Fernandes JVJ, Souza AG. Thermoanalytical characterization of castor oil biodiesel. *Renew Sust Energy Rev* 2007;11:964–75. 459
- [28] Lu H, Liu Y, Zhou H, Yang Y, Chen M, Liang B. Production of biodiesel from *Jatropha curcas L.* oil. *Comput Chem Eng* 2009;33:1091–6. 460

509
510
511
512
513
514
515
516

- [29] Chen Y-H, Chen J-H, Luo Y-M, Shang N-C, Chang C-H, Chang C-Y, et al. Property modification of jatropha oil biodiesel by blending with other biodiesels or adding antioxidants. *Energy* 2011;36:4415–21.
- [30] Pratas MJ, Freitas SVD, Oliveira MB, Monteiro SC, Lima AS, Coutinho JAP. Biodiesel density: experimental measurements and prediction models. *Energy Fuel* 2011;25:2333–40.
- [31] Alamu OJ, Waheed MA, Jekayinfa SO. Effect of ethanol–palm kernel oil ratio on alkali-catalyzed biodiesel yield. *Fuel* 2008;87:1529–33.

- [32] Baroutian S, Aroua MK, Raman AAA, Sulaiman NMN. Densities of ethyl esters produced from different vegetable oils. *J Chem Eng Data* 2008;53:2222–5.
- [33] Poling BE, Prausnitz JM, O'Connell JP. *The properties of gases and liquids*. 5th ed. New York: McGraw-Hill; 2001.
- [34] Yuan W, Hansen AC, Zhang Q. Vapor pressure and normal boiling point predictions for pure methyl esters and biodiesel fuels. *Fuel* 2005;84:943–50.

517
518
519
520
521
522
523
524
525

UNCORRECTED PROOF

Artículo VI

Empirical modelling of the kinematic viscosity of biodiesel produced with methanol and ethanol.

Manuel García, Juan-José Alba, Alberto Gonzalo, José Luis Sánchez, Jesús Arauzo.*

Thermochemical Processes Research Group (GPT)

Aragón Institute of Engineering Research (I3A), Universidad de Zaragoza. Mariano

Esquillor s/n; I+D Bld., 50018, Zaragoza (Spain).

* Corresponding author
Phone: +34 976 762961
Fax: +34 976 761879
e-mail: manuelgr@unizar.es

Abstract

Biodiesel kinematic viscosity is a key parameter not only concerning process calculations but also to accomplish the requirements of standards, as EN 14214 or ASTM D6751, for its commercialization. In this work three kinematic viscosity models for methanol based biodiesels have been selected and evaluated using a large experimental and bibliographical data bank. A new correlation in terms of composition and molecular description parameters. Regarding ethanol based biodiesel, this correlation, with different fitting parameters can be used to predict the viscosity, but more experimental data are needed in order to validate it.

Keywords

Biodiesel, kinematic viscosity, modelling, FAME, FAEE

Nomenclature

Abbreviations		Symbols	
FAME	Fatty acid methyl esters	T	Temperature (K)
FAEE	Fatty acid ethyl esters	MW	Molecular weight
BM	Biodiesel methanol	N	N° of double bonds
BE	Biodiesel ethanol	z	Fatty acid length chain
GN	Grunberg-Nissan equation	x	Mass fraction
UD	Unsaturation degree	Subscripts	
LC	Length chain	m	Relative to mixture
RD	Relative deviation (%)	i	Component i
ARD	Average relative deviation (%)	sim	Simulated
		exp	Experimental
Greeks symbols			
μ	Dynamic viscosity		
ν	Kinematic viscosity		

1. Introduction

Mixtures of fatty acid methyl esters (FAME) or fatty acid ethyl esters (FAEE), depending on the alcohol used in the transesterification reaction are called biodiesel,

and its properties must accomplish different standards to be commercialized, as the EN 14214 in Europe or the ASTM D6751 in USA. Models dealing with biodiesel properties [1] can be found in available bibliography, usually taking as input variables the composition (ester profile) of biodiesel and/or structural parameters of the molecules that can describe the mixture, as Unsaturation Degree (UD) or Length Chain (LC) [2]. Specifically, viscosity is a key parameter not only in the biodiesel final properties considered in the EN or ASTM standards, but also in biodiesel process simulations. The high kinematic viscosity of oils is the main reason to transesterify them in order to obtain biodiesel, which has a lower viscosity and improves the operational behaviour in current engines. Because of this reason, and taking into account that the amount of different raw materials for biodiesel production has increased in the last years, a model or correlation which can predict the final biodiesel kinematic viscosity is a major issue.

Correlations based on thermodynamic considerations or group contribution methods are available in open literature to estimate the dynamic viscosities of pure liquids in terms of temperature. Specifically, the Thomas, Sastri-Rao, Orrick-Erbar, Letsou-Stiel (for high temperature calculations) [3], Ceriani et al. [4] and Hsu et al. [5] are some of these theoretically based correlations. The Orrick-Erbar and Letsou-Stiel methods were used by Yuan et al. [6] for estimating the dynamic viscosity of biodiesel from various sources obtaining a high relative error. Anand et al. [7] performed a comparison of the results obtained using the Thomas, Sastri-Rao and Orrick-Erbar correlations finding a large deviation for high molecular weighted esters in different biodiesels. They also proposed a modification of the Sastri-Rao correlation obtaining a significant improvement in the average absolute error.

On the other hand, Reid et al. [3] recommend the use of empirical correlations in order to estimate the viscosity of any liquid. Allen et al. [8] proposed a method to estimate the dynamic viscosity of biodiesel fuels from their fatty acid composition, molecular mass and number of double bonds. They reported equations for individual esters (methyl and ethyl esters) and applied a simplification of the Grunberg–Nissan (GN) equation (Eq. 1) in order to predict the final viscosity of the mixture.

$$\ln \mu_m = \sum_{i=1}^n x_i \ln \mu_i \quad (\text{Eq. 1})$$

where μ_m is the dynamic viscosity (mPa·s) of the mixture, μ_i is the dynamic viscosity of component i and x_i represents its mass fraction in the mixture.

Yuan et al. [9] reported a correlation using the Vogel equation (Eq. 2). They are capable of predicting the dynamic viscosities of 15 different pure methyl esters. From the composition of 5 biodiesel fuels, they predict the viscosity with an average absolute error of 3.2 % using the GN equation as mixing rule. Recently, Pratas et al. [10] re-evaluated the Yuan’s model reporting a new set of constants for the Vogel equation.

$$\ln \mu_i = A + \frac{B}{T + C} \quad (\text{Eq. 2})$$

Other experimental correlation of dynamic viscosity as a function of temperature was reported by Rinke et al. [11]. In this case they correlate the temperature dependency by using an exponential function for rapeseed oil based biodiesel and waste cooking oil based biodiesel.

An interesting approach to predict the dynamic viscosity of biodiesel fuels using a topological index was proposed by Yang et al. [12]. Taking into account the molecular structure of fatty acid methyl esters, they proposed an index which reflects the information of the molecular structure of various methyl esters. Combined with the GN equation, they compute a biodiesel topological index which can be used to predict the viscosity. In the case of vegetable oils based biodiesels, the relative error is less than 5.1 %, it increases to 11.4 % in the case of animal fat based biodiesels.

Using structural identifiers, Chang and Liu [13] proposed a simple correlation to estimate dynamic viscosities of methanol based biodiesel components at 40°C. The proposed correlation is based on the number of carbon atoms and double bonds in the pure methyl ester.

The possibility of using the fatty acid composition is a desirable input for a model, but the use of these correlations is limited by the need of density values to obtain the kinematic viscosity, which is the normalized property in the EU and USA standards. Unfortunately, just a few kinematic viscosity models can be found in open literature. Krisnangkura et al. [14] propose a set of correlations for predicting the kinematic viscosity of pure methyl esters in terms of temperature. Ramírez-Verduzco et al. [15] developed a simple but accurate correlation for kinematic viscosity at 40°C using as input variables the molecular weight and the number of double bonds. Knothe and Steidley [16] reported experimental and adjusted kinematic viscosities of pure methyl esters, they proposed the use of a linear mixing rule to compute the final biodiesel viscosity.

In this work we perform an evaluation of these three models (Ramírez-Verduzco et al. [15], Krisnangkura et al. [14], and Knothe and Steidley [16]) for the estimation of viscosity at 40 °C, using bibliographical and experimental data. In the case of methanol based biodiesels, a new model is also proposed and compared with other correlations. In case of ethanol based biodiesels we use our experimental data to generate a new model.

2. Experimental Section

2.1. Materials and Biodiesel Preparation

All samples used in this work were produced departing from the following raw materials; sunflower, rapeseed, soybean, olive, safflower and other two kinds of edible vegetable oils (mixtures of vegetable oils) were purchased, mixed and used directly. Three different animal raw materials were used too. Commercial edible pork fat was purchased and used directly. Crude pork fat was provided by the Spanish company LIPSA (Santa Perpetua de Mogoda, Barcelona, Spain). Natural beef tallow was acquired in some slaughterhouses in Tudela (Navarra, Spain). Fat was extracted from this tallow by heating it and removing the solid residue. The obtained product was finally filtered and stored.

The reagents used during biodiesel synthesis and purification steps were: methanol (assay (GLC) \geq 99.9%, Carlo Erba Reagents), ethanol (99%, Panreac), sulphuric acid (96%, Panreac), sodium methoxide (ca. 25 wt. % solution in methanol, Sigma-Aldrich), sodium ethoxide (ca. 21 wt. % solution in ethanol, Sigma-Aldrich) and Magnesium sulphate (anhydrous, Scharlau). A dissolution of methyl heptadecanoate (standard for

GC, Fluka Analytical) in heptane (standard for GC, Fluka Analytical) was used as internal standard for the GC determinations.

All biodiesel samples were prepared by alkaline transesterification in a batch reactor (2000 mL glass vessel) equipped with a mechanical stirrer, a condenser and a thermocouple. A detailed description of the followed experimental procedure can be found elsewhere [17].

2.2. Experimental Measurements

Fatty acid profile was determined by gas chromatography (GC) according to EN 14103 (2003) and ISO 5508 (1990). Methyl and ethyl esters were determined using gas chromatography with a flame ionization detector (GC-FID) system, an Agilent 6890 Series GC System gas chromatograph, with a DB-225 MS (Agilent) column (30 m x 0.25 mm x 0.25 μ m). The injector and detector (FID) temperatures were set at 250°C. The used carrier gas was He with a flow of 1 mL/min. Injection was made in a split mode, using a split flow ratio of 35:1, the volume injected was 1 μ L. The following temperature program was used: initial temperature 170°C, then heating at 3°C/min to 203°C, at 1.5°C/min to 214°C, then at 5°C/min to 230°C and holding at that temperature for 16 min. Tables 1 and 2 show the methyl and ethyl ester profiles of the mixtures produced, twenty one in each case.

Viscosity of biodiesel samples was determined according to the standard EN ISO 3104, at 40 °C as it is established by standards EN 14214 and ASTM 6751. The interval of confidence of the experimental data was calculated with the standard deviation of five sample viscosity measurements and the student's t distribution (95% confidence level and 4 degrees of freedom), obtaining a maximum value of 0.02 mm²/s, thus it can be

considered that experimental repeatability is good. The measured viscosity values of MeOH and EtOH based biodiesels can be found in Tables 4 and 8 respectively.

3. Methodology

3.1. Viscosity Data Bank

Besides the experimental set of data of FAME and FAEE obtained in this work and taking into account the aim of this paper, it was considered that the selection of a proper data bank, including bibliographical data, is a key issue. The need of a well described composition, alkyl ester profile, was considered the most important criteria when selecting the bibliographical references. In case of MeOH based biodiesels this issue was clearly easier than in case of EtOH based biodiesels, this fact can be observed by considering the number of bibliographical references in both cases.

For MeOH based biodiesels, a total of 49 data points [15, 18-22] (combination of detailed methyl ester profiles with kinematic viscosity measurements) have been used in the subsequent calculations. For EtOH based biodiesels just 4 data points [23-26] could be found with reported experimental values of kinematic viscosity, although, as explained later, they haven't been used in the calculations. The ester profile of this bibliographical set is not shown for the sake of brevity.

Table 1: Methyl ester profile (% wt.) of produced (BM1-BM21) MeOH based biodiesels.

Biodiesel	C14:0	C15:0	C16:0	C17:0	C18:0	C20:0	C22:0	C16:1	C18:1	C20:1	C18:2	C18:3	Total
BM1			6.135		3.681	0.241	0.664	0.079	26.642	0.144	61.896	0.220	99.77
BM2			10.579		3.181	0.388	0.106	0.772	77.419	0.238	6.191	0.685	99.58
BM3			8.410		3.439	0.314	0.387	0.444	51.724	0.189	34.313	0.404	99.67
BM4			4.516		1.611	0.580	0.300	0.239	63.361	1.105	19.297	8.734	99.79
BM5			4.718		1.848	0.518	0.311	0.180	69.986	0.693	16.915	4.505	99.73
BM6			5.297		2.657	0.410	0.489	0.166	44.718	0.623	40.966	4.459	99.84
BM7			5.076		2.028	0.460	0.322	0.140	76.589	0.291	14.420	0.202	99.60
BM8			8.410		3.439	0.314	0.387	0.444	51.724	0.189	34.313	0.404	99.67
BM9			10.044		2.963	0.311	0.218	0.080	24.598	0.000	55.184	6.129	99.59
BM10			4.464		1.544	0.566	0.288	0.220	62.088	1.272	19.319	9.739	99.55
BM11			11.013		1.771	0.403	0.133	0.157	30.266	0.231	55.088	0.772	99.87
BM12	0.664	0.023	18.720	0.216	11.141	0.276	0.045	1.350	56.446	0.417	9.541	0.724	99.56
BM13	0.764	0.029	19.024	0.224	11.553	0.253	0.179	1.368	44.104	0.425	20.975	0.608	99.51
BM14	1.360	0.050	26.410	0.404	18.756	0.181		1.900	35.557	0.618	12.843	1.040	99.12
BM15	0.672	0.029	23.948	0.101	10.994	0.069		3.224	50.969	0.391	8.945	0.380	99.72
BM16	1.179	0.042	25.783	0.322	16.724	0.143		2.251	39.736	0.571	11.689	0.839	99.28
BM17	1.563	0.255	19.101	0.778	15.191	0.229	0.186	1.378	43.918	0.208	16.402	0.286	99.50
BM18	2.168	0.265	26.833	0.950	22.344	0.146		2.042	35.717	0.421	7.623	0.569	99.08
BM19	1.414	0.036	26.885	0.294	18.191	0.183		2.335	38.843	0.634	9.685	0.658	99.16
BM20	1.468	0.226	19.073	0.796	14.852	0.252	0.045	1.463	56.604	0.199	4.194	0.334	99.51
BM21	4.417	0.618	28.080	1.456	25.088	0.138		1.936	34.104	0.139	2.467	0.141	98.58

Table 2: Ethyl ester profile (% wt.) of produced (BE1-BE21) EtOH based biodiesel.

	C10:0	C12:0	C14:0	C15:0	C16:0	C17:0	C18:0	C20:0	C22:0	C24:0	C16:1	C17:1	C18:1	C20:1	C22:1	C24:1	C18:2	C18:3	Total
BE1	0.038	0.042	0.744	0.028	18.959	0.224	11.473	0.228	0.145		1.312	0.133	44.085	0.403			21.378	0.623	99.81
BE2	0.082	0.083	1.412	0.032	26.798	0.284	17.928	0.173			2.379	0.196	39.257	0.616			9.677	0.640	99.56
BE3	0.040	0.039	0.695	0.013	19.044	0.160	10.742	0.262	0.041		1.579	0.135	58.260	0.424			7.809	0.566	99.81
BE4	0.070	0.077	1.346	0.046	26.445	0.390	18.558	0.165			1.959	0.191	36.038	0.597			12.617	1.011	99.51
BE5	0.171	0.339	4.417	0.601	27.996	1.418	24.837	0.129			1.937	0.309	34.389	0.132			2.644	0.143	99.46
BE6	0.058	0.072	2.220	0.262	27.005	0.928	22.267	0.146			2.053	0.292	35.784	0.393			7.473	0.540	99.49
BE7	0.024	0.033	1.583	0.243	19.140	0.762	15.226	0.211	0.155		1.391	0.227	44.006	0.199			16.358	0.230	99.79
BE8	0.020	0.029	1.482	0.226	19.111	0.785	14.685	0.239	0.051		1.469	0.219	56.943	0.200			4.037	0.308	99.80
BE9			0.065		6.120		3.765	0.246	0.695	0.197	0.080		26.467	0.141			62.157	0.068	100.00
BE10					10.757		3.061	0.381	0.106	0.245	0.760		77.570	0.234			6.300	0.585	100.00
BE11			0.051		4.548		1.637	0.581	0.300	0.097	0.247		63.140	1.090		0.113	19.449	8.747	100.00
BE12			0.075		5.100		2.119	0.459	0.321	0.150	0.141		76.747	0.286	0.076	0.169	14.226	0.130	100.00
BE13			0.075		10.575		2.956	0.327	0.407	0.123	0.091		25.198	0.217			54.051	5.980	100.00
BE14			0.032		11.013		1.771	0.403	0.133	0.133	0.157		30.266	0.231			55.088	0.772	100.00
BE15			0.048		4.464		1.544	0.566	0.288	0.082	0.220		62.088	1.272	0.255	0.115	19.319	9.739	100.00
BE16			0.026		7.918		1.841	0.915	2.704	1.671	0.096		56.153	2.024	0.228		26.199	0.224	100.00
BE17			0.042		8.483		3.495	0.313	0.388	0.195	0.462		51.979	0.190		0.138	33.983	0.332	100.00
BE18			0.031		8.791	0.037	3.565	0.344	0.358	0.127	0.425	0.047	59.213	0.192		0.093	26.474	0.303	100.00
BE19			0.049		8.131	0.068	2.545	0.464	0.374		0.197	0.039	46.202	0.729		0.097	34.294	6.811	100.00
BE20			0.026		6.540	0.063	1.774	0.783	1.682		0.162	0.042	60.147	1.836	0.233	0.857	21.268	4.587	100.00
BE21			0.028		9.823	0.039	3.336	0.340	0.332	0.098	0.352	0.040	48.049	0.218		0.102	36.822	0.420	100.00

3.2. Viscosity Calculation and Model Evaluation

Modelling the kinematic viscosity of biodiesel usually involves the calculation of individual components viscosity and the application of a mixing rule in order to compute the viscosity of the resulting mixture. Taking into account that biodiesel can be considered as a non-associated liquid [16], the final viscosity of the mixture can be computed using the following equation, which is also a simplification of the GN equation (Eq. 3):

$$\nu = \sum_{i=1}^n x_i \cdot \nu_i \quad (\text{Eq. 3})$$

where ν is the kinematic viscosity (mm^2/s) of the mixture, ν_i is the kinematic viscosity of component i and x_i represent the mass fraction of this component in the mixture.

The individual FAME viscosity is computed in this work using the reported equations as in the cases of the models proposed by Ramírez-Verduzco et al. [15] (Eq. 4), and Krisnangkura et al. [14] (Eqs. 5- 10). The reported experimental data by Knothe and Steidley [16] were directly used. Table 3 shows the estimated viscosities of individual FAME (at 40°C) using the three kinematic viscosity models.

$$\ln(\nu_i) = -12.503 + 2.496 \cdot \ln(MW_i) - 0.178 \cdot N_i \quad (\text{Eq. 4})$$

$$\ln(v_i)_{C6:0-C12:0} = -2.915 - 0.158 \cdot z + \frac{492.12}{T} + \frac{108.35 \cdot z}{T} \quad (\text{Eq. 5})$$

$$\ln(v_i)_{C12:0-C18:0} = -2.177 - 0.202 \cdot z + \frac{403.66}{T} + \frac{109.77 \cdot z}{T} \quad (\text{Eq. 6})$$

$$\ln(v_i)_{C18:1} = -5.03 + \frac{2051.5}{T} \quad (\text{Eq. 7})$$

$$\ln(v_i)_{C18:2} = -4.51 + \frac{1822.5}{T} \quad (\text{Eq. 8})$$

$$\ln(v_i)_{C18:3} = -4.18 + \frac{1685.5}{T} \quad (\text{Eq. 9})$$

$$\ln(v_i)_{C22:1} = -5.42 + \frac{2326.2}{T} \quad (\text{Eq. 10})$$

Table 3: Kinematic viscosities of individual methyl esters computed with Ramírez-Verduzco et al. and Krisnangkura et al. models and experimental data from Knothe & Steidley

FAMES	MW/g · mol ⁻¹	Ramírez-Verduzco et al. v/mm ² ·s ⁻¹	Krisnangkura et al. v/mm ² ·s ⁻¹	Knothe & Steidley [16] v/mm ² ·s ⁻¹
C8:0	158.24	1.15	1.17	1.19
C10:0	186.29	1.72	1.71	1.72
C12:0	214.34	2.45	2.49	2.43
C14:0	242.40	3.33	3.29	3.30
C15:0	256.42	3.83	3.82	3.84
C16:0	270.45	4.37	4.43	4.38
C17:0	284.48	4.96	5.14	5.03
C18:0	298.50	5.59	5.96	5.85
C20:0	326.56	7.00	8.03	7.40
C22:0	354.61	8.59	10.80	9.31
C24:0	382.66	10.39	14.54	11.53
C16:1	268.43	3.59	n.c.	3.67
C17:1	282.46	4.08	n.c.	4.09
C18:1	296.49	4.60	4.58	4.51
C18:1 OH	312.49	5.25	n.c.	15.44
C20:1	324.54	5.77	n.c.	5.77
C22:1	352.59	7.09	7.45	7.33
C24:1	380.65	8.58	Nd.	8.87
C18:2	294.47	3.79	3.71	3.65
C18:3	292.45	3.11	3.33	3.14

n.c.; Not calculated due to the lack of a proper equation.

As can be observed in Table 3, viscosity values for saturated methyl esters are very close for models and experimental data reported by Knothe & Steidley [16] with the

exception of long chain esters C22:0 and C24:0. Mono- and polyunsaturated values are in good agreement for all models as well. In the case of ricinoleate methyl ester (C18:1-OH), Knothe and Steidley [27] reported an experimental value of 15.44 mm²/s but neither Verduzco's model nor Krisnangkura's model are able to estimate this viscosity. As castor oil is not widely used as biodiesel raw material, it has not been considered in the models proposed.

Since no kinematic viscosity models have been found for FAEE, a new one has been generated from the data produced.

Selecting a model is not a trivial task and it arises when two or more models with different number of parameters can explain the modelled data. In order to compare the different correlations obtained, a test F has been carried out, as shown in the following equations:

$$F_{calc} = \frac{\frac{SSR_A - SSR_B}{SSR_A}}{\frac{p_B - p_A}{n - p_A}} = \frac{SSR_A - SSR_B}{p_B - p_A} \cdot \frac{n - p_A}{SSR_A} \quad (\text{Eq. 11})$$

Where SSR_i is the sum of squared residuals, being the subscript A and B for the two models to be compared, n the number of data used in the regression and p_A and p_B the number of parameters in the models, being p_A < p_B. It is assumed that the model with the higher number of parameters correlates better the data than the other model, so SSR_A > SSR_B.

The F_{calc} value is compared with a tabulated value of $F(F(\alpha, p_B - p_A, n - p_A))$, being α the significance level (0.05 in this work), with $p_B - p_A$, and $n - p_A$ the degrees of freedom. If $F_{\text{calc}} > F(\alpha, p_B - p_A, n - p_A)$, then model B is better than model A.

For models with the same number of parameters, the one with the biggest regression coefficient, R^2 or R^2_{adj} (eq. 12 and 13) was chosen.

$$R^2 = 1 - \frac{SSR}{SST}; \quad SSR = \sum_{i=1}^n (v_i^{\text{experimental}} - v_i^{\text{calculated}})^2; \quad SST = \sum_{i=1}^n (v_i^{\text{experimental}} - \bar{v}_i)^2 \quad (\text{Ec. 12})$$

$$R^2_{\text{adj}} = 1 - \left(\frac{n-1}{n-p} \right) \frac{SSR}{SST} \quad (\text{Ec. 13})$$

4. Results and discussion

It has been reported [25, 27] that biodiesel kinematic viscosity is related to carbon chain length, number of double bonds, and mixture composition. So, different parameters have been calculated from the composition of the available data, to find which of them are better correlated with the viscosity. Those parameters are:

- MW: biodiesel average molecular weight, calculated as $\sum y_i \cdot MW_i$, being the subscript i for the different alkyl esters in biodiesel, and y the mass fraction.
- Ln(MW): natural logarithm of the average molecular weight.
- LC: average carbon length chain, calculated as $\sum y_i \cdot LC_i$
- Ln(LC): natural logarithm of the average carbon length chain

- UD: average number of double bonds, calculated as $\sum y_i \cdot UD_i$, being UD_i the number of double bonds of each alkil ester.
- mono: mass fraction of alkil esters with one double bond
- sat: mass fraction of alkil esters with no double bonds.
- poly: mass fraction of alkil esters with two or more double bonds. It should be noted that mono, poly and sat add one, so the three cannot be used at the same time for the regression.
- lig: mas fraction of light esters (C8:0 a C14:0)

4.1. Methanol based biodiesel

Using the experimental and bibliographical sets of data (a total of 70 points) an analysis of variance (ANOVA) was carried out to find out the sets which better correlated. In this case, the better regression was obtained with the natural logarithm of kinematic viscosity. Not surprisingly, one the sets corresponds with the model proposed by Ramírez-Verduzco et al. [15], equation 15, the other model has one parameter more, as shown in equation 14 and also exhibits a better regression coefficient, as shown in Table 4.

$$\nu(\text{mm}^2 \cdot \text{s}^{-1}) = e^{A+B \cdot MW+C \cdot UD} \quad (\text{Eq. 14})$$

$$\nu(\text{mm}^2 \cdot \text{s}^{-1}) = e^{A+B \cdot MW+C \cdot \text{Ln}(LC)+D \cdot UD} \quad (\text{Eq. 15})$$

Table 4. Parameters obtained for eqs. 14 and 15

	intercept	MW	Ln(MW)	Ln(LC)	UD	R ² /R ² _{adj}
Verduzco	-11,81 ± 2,21		2,37 ± 0,39		-0,15 ± 0,03	0,75/0,74
Eq. 14	-14,51 ± 5,49	-0,03 ± 0,02		8,88 ±3,52	-0,21 ± 0,03	0.81/0.80

Figure 1 shows the experimental and calculated data for both models.

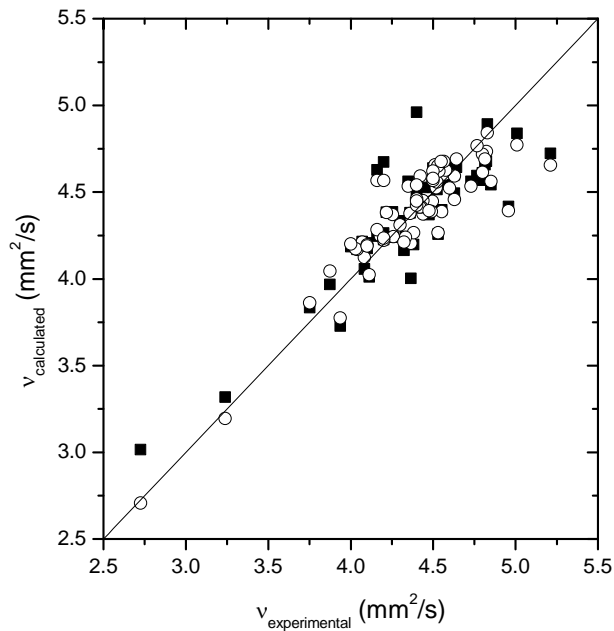

Figure 1. Experimental vs calculated viscosity of biodiesel produced with methanol. ■ equation 14, ○ equation 15

The statistical comparison of both models yields a $F_{\text{calculated}}$ of 16.0, for a significance level of 0.05, so equation 15 is better than equation 14 to predict the kinematic viscosity.

4.2. Ethanol based biodiesel

To the best of author's knowledge, no models for FAEE kinematic viscosity have been reported. The lack of data related to ethanol based biodiesel is the reason because just 5 bibliographical references were found.

Knothe and Steidley [27] reported experimental data of kinematic viscosity of some pure ethyl esters. Using these data, an equation to estimate pure ethyl ester kinematic viscosity has been adjusted. The selected equation is based on the model of Ramírez-Verduzco et al. [15], equation 17;

$$\ln(\nu_i) = A_e + B_e \cdot \ln(MW_i) + C_e \cdot N_i \quad (\text{Eq. 16})$$

The constants A_e , B_e and C_e were adjusted using nonlinear regression ($R^2 = 0.995$) and the viscosities of pure ethyl esters, experimental and calculated with equation 17, are shown in Table 7. Values of the constants are -12.998, 2.5704 and -0.1589 respectively. It is important to note that the viscosity value of ethyl ricinoleate was calculated considering the methyl ricinoleate viscosity and the % of change between methyl oleate and ethyl oleate, this approach was previously used by Knothe & Steidley_ in order to estimate the missing pure methyl ester viscosities. Values reported by equation 16 were used to compute the viscosity of biodiesel BE1-21 produced for this work as well as those of found in bibliography [23-26] by applying GN equation (Eq. 3), and the results are shown in Table 5.

Table 5: Calculated and experimental viscosities of some pure ethyl esters

FAEEs	MW/g · mol ⁻¹	Equation 16 v/mm ² ·s ⁻¹	Knothe and Steidley [27] v/mm ² ·s ⁻¹
C8:0	172.26	1.27	na
C10:0	200.32	1.87	1.87
C12:0	228.37	2.62	2.63
C14:0	256.42	3.52	3.52
C15:0	270.45	4.04	na
C16:0	284.48	4.60	4.57
C17:0	298.50	5.21	na
C18:0	312.53	5.86	5.92

C20:0	340.58	7.31	na
C22:0	368.63	8.96	na
C24:0	396.69	10.82	na
C16:1	282.46	3.85	na
C17:1	296.49	4.37	na
C18:1	310.51	4.92	4.78
C18:1 OH	340.54	18.82*	na
C20:1	338.57	6.14	na
C22:1	366.62	7.53	na
C24:1	394.67	9.11	na
C18:2	308.50	4.12	4.25
C18:3	306.48	3.46	3.42

na: Not available. * Estimated from C18:1_{MeOH} and C18:1_{EtOH} (see text)

Additionally to this model (Eq. 16), a similar procedure than in case of MeOH was applied to ethanol based biodiesels. A first ANOVA of the 26 data yielded a complex model, with a very high number of statistically significant terms (12) compared to the number of data points. Using the Cook's distance [28] criterion, several of the bibliographic data seem to be anomalous, so it was decided to use only the 21 data obtained in our laboratory.

The ANOVA of the reduced set, with the subsequent regression, yielded four different models, with similar regression coefficients, shown in equations 17-20, with the regression coefficients shown in Table 6. As it can be observed, the relationship of FAEE viscosity with composition seems to be somewhat different from the one showed by FAME, as one of the equations which fits the data is linear, something not observed for FAME viscosity. On the other hand, equation 19 corresponds to the model proposed by Ramírez-Verduzco too.

$$\ln(\nu) = 1.635 - 0.227 \cdot poly$$

(Eq. 17)

$$\nu = -6.273 + 0.039 \cdot MW - 0.942 \cdot UD \quad (\text{Eq. 18})$$

$$\ln(\nu) = -12.953 - 0.198 \cdot UD + 2.574 \cdot \ln(MW) \quad (\text{Eq. 19})$$

$$\ln(\nu) = -0.794 + 8.42 \cdot 10^{-3} \cdot MW - 0.198 \cdot UD \quad (\text{Eq. 20})$$

Table 6. Regression coefficients for equations 17-20

Equation	R ²	R ² _{adj}
Ec. 17	0,781	0,770/
Ec. 18	0,896	0,886
Ec. 19	0,896	0,885
Ec. 20	0,896	0,885

In general terms, viscosity of ethanol based biodiesel is slightly higher than methanol based biodiesel [29], Table 8 shows that most of the samples are over or very close to the higher EN 14214 limit for kinematic viscosity (5 mm²/s). The statistical comparison of this models, is shown in Table 7.

Table 7. Comparisons of models for FAEE viscosity

Model	SSR	p	R ² _{adj}	F calculated
Eq. 18	0,103681	3	0,885921	10,562684
Ec. 19	0,104354	3	0,885181	10,501458
Ec. 20	0,104247	3	0,885299	10,511196
Ec. 17	0,219726	2	0,770328	

The tabulated F value is 4.38, so the three regression models of three parameters correlate better than equation 17 the experimental data, being the regression coefficient very similar.

While in case of methanol based biodiesels there are more bibliographical data available, in case of ethanol based biodiesel it is clear that more experimental data are needed to perform a validation of the models and discriminate between them. Anyway, the results show that equations 18 to 20 can be used as first approach to predict the kinematic viscosity of the ethanol biodiesel.

5. Conclusions

Three viscosity models were evaluated for methanol based biodiesels with a large number of experimental data, obtained for this work, and bibliographical data. A new correlation for kinematic viscosity based on composition parameters, with a significant improvement on model accuracy, has been developed. With regard to ethanol based biodiesels, different models have been presented and compared. The statistical comparison of the models show that the increase in fitting parameters justify the use of these new equations proposed in this work. Regarding the prediction of ethanol based biodiesel, more experimental data would be needed in order to get a full validation of this equation.

Acknowledgement

This work has been funded by the Spanish Ministry of Science and Innovation through project CTQ2010-19811

6. Bibliography

- [1] Su, Y.C., Liu, Y. A., Diaz Tovar, C.A., Gani, R., Selection of Prediction Methods for Thermophysical Properties for Process Modeling and Product Design of Biodiesel Manufacturing, *Ind. Eng. Chem. Res*, 50 (2011) 6809-6836.
- [2] Lapuerta, M., Rodríguez-Fernández, J., Armas, O., Correlation for the estimation of the density of fatty acid esters fuels and its implications. A proposed Biodiesel Cetane Index, *Chem. Phys. Lipids.*, 163 (2010) 720-727.
- [3] Reid, R.C., Prausnitz, J.M., Poling, B.E., *The properties of gases and liquids*, 4th ed., McGraw-Hill, New York, 1987.
- [4] Ceriani, R., Goncalves, C.B., Rabelo, J., Caruso, M., Cunha, A.C.C., Cavaleri, F.W., Batista, E.A.C., Meirelles, A.J.A., Group contribution model for predicting viscosity of fatty compounds, *J. Chem. Eng. Data*, 52 (2007) 965-972.
- [5] Hsu, H.-C., Sheu, Y.-W., Tu, C.-H., Viscosity estimation at low temperatures ($T_r < 0.75$) for organic liquids from group contributions, *Chem. Eng. J.*, 88 (2002) 27-35.
- [6] Yuan, W., Hansen, A.C., Zhang, Q., Predicting the physical properties of biodiesel for combustion modeling, *Trans. ASAE*, 46 (2003) 1487-1493.
- [7] Anand, K., Ranjan, A., Mehta, P.S., Estimating the Viscosity of Vegetable Oil and Biodiesel Fuels, *Energ. Fuel*, 24 (2009) 664-672.
- [8] Allen, C.A.W., Watts, K.C., Ackman, R.G., Pegg, M.J., Predicting the viscosity of biodiesel fuels from their fatty acid ester composition, *Fuel*, 78 (1999) 1319-1326.

- [9] Yuan, W., Hansen, A.C., Zhang, Q., Predicting the temperature dependent viscosity of biodiesel fuels, *Fuel*, 88 (2009) 1120-1126.
- [10] Pratas, M.J., Freitas, S., Oliveira, M.B., Monteiro, S.C., Lima, A.S., Coutinho, J.A.P., Densities and Viscosities of Fatty Acid Methyl and Ethyl Esters, *J. Chem. Eng. Data*, 55 (2010) 3983-3990.
- [11] Kerschbaum, S., Rinke, G., Measurement of the temperature dependent viscosity of biodiesel fuels, *Fuel*, 83 (2004) 287-291.
- [12] Shu, Q., Yang, B., Yang, J., Qing, S., Predicting the viscosity of biodiesel fuels based on the mixture topological index method, *Fuel*, 86 (2007) 1849-1854.
- [13] Chang, A.F., Liu, Y.A., Integrated Process Modeling and Product Design of Biodiesel Manufacturing, *Ind. Eng. Chem. Res*, 49 (2010) 1197-1213.
- [14] Krisnangkura, K., Yimsuwan, T., Pairintra, R., An empirical approach in predicting biodiesel viscosity at various temperatures, *Fuel*, 85 (2006) 107-113.
- [15] Ramírez-Verduzco, L.F., Rodríguez-Rodríguez, J.E., Jaramillo-Jacob, A.d.R., Predicting cetane number, kinematic viscosity, density and higher heating value of biodiesel from its fatty acid methyl ester composition, *Fuel*, (2011).
- [16] Knothe, G., Steidley, K.R., Kinematic viscosity of fatty acid methyl esters: Prediction, calculated viscosity contribution of esters with unavailable data, and carbon-oxygen equivalents, *Fuel*, 90 (2011) 3217-3224.
- [17] García, M., Gonzalo, A., Sánchez, J.L., Arauzo, J., Simoes, C., Methanolysis and ethanolysis of animal fats: A comparative study of the influence of alcohols, *Chem. Ind. Chem. Eng. Q*, 17 (2011) 91-97.
- [18] Sanford, S.D., White, J.M., Shah, P.S., Wee, C., Valverde, M.A., Meier, G.R., Feedstock and Biodiesel Characteristics Report, in, Renewable Energy Group, Inc., 2009.
- [19] Rashid, U., Anwar, F., Moser, B.R., Knothe, G., Moringa oleifera oil: A possible source of biodiesel, *Bioresour. Technol.*, 99 (2008) 8175-8179.
- [20] Sarin, R., Sharma, M., Sinharay, S., Malhotra, R.K., Jatropha-Palm biodiesel blends: An optimum mix for Asia, *Fuel*, 86 (2007) 1365-1371.
- [21] Krahl, J., Knothe, G., Munack, A., Ruschel, Y., Schröder, O., Hallier, E., Westphal, G., Bünger, J., Comparison of exhaust emissions and their mutagenicity from the combustion of biodiesel, vegetable oil, gas-to-liquid and petrodiesel fuels, *Fuel*, 88 (2009) 1064-1069.
- [22] Ramos, M.J., Fernández, C.M., Casas, A., Rodríguez, L., Pérez, Á., Influence of fatty acid composition of raw materials on biodiesel properties, *Bioresour. Technol.*, 100 (2009) 261-268.
- [23] Joshi, H., Moser, B.R., Toler, J., Walker, T., Preparation and fuel properties of mixtures of soybean oil methyl and ethyl esters, *Biomass Bioenergy*, 34 (2010) 14-20.
- [24] de Lima da Silva, N.v., Benedito Batistella, C.s., Maciel Filho, R., Maciel, M.R.W., Biodiesel Production from Castor Oil: Optimization of Alkaline Ethanolysis, *Energ. Fuel*, 23 (2009) 5636-5642.
- [25] Issariyakul, T., Kulkarni, M.G., Meher, L.C., Dalai, A.K., Bakhshi, N.N., Biodiesel production from mixtures of canola oil and used cooking oil, *Chem. Eng. J.*, 140 (2008) 77-85.
- [26] Kulkarni, M.G., Dalai, A.K., Bakhshi, N.N., Transesterification of canola oil in mixed methanol/ethanol system and use of esters as lubricity additive, *Bioresour. Technol.*, 98 (2007) 2027-2033.
- [27] Knothe, G., Steidley, K.R., Kinematic viscosity of biodiesel fuel components and related compounds. Influence of compound structure and comparison to petrodiesel fuel components, *Fuel*, 84 (2005) 1059-1065.

[28] Cook, R.D., Detection of influential observation in linear-regression, Technometrics, 19 (1977) 15-18.

[29] Stamenković, O.S., Veličković, A.V., Veljković, V.B., The production of biodiesel from vegetable oils by ethanolsis: Current state and perspectives, Fuel, 90 (2011) 3141-3155.