



THE UNIVERSITY *of* EDINBURGH

Edinburgh Research Explorer

A rotator for single-crystal neutron diffraction at high pressure

Citation for published version:

Fang, J, Bull, CL, Hamidov, H, Loveday, JS, Gutmann, MJ, Nelmes, RJ & Kamenev, KV 2010, 'A rotator for single-crystal neutron diffraction at high pressure' *Review of Scientific Instruments*, vol. 81, no. 11, 113901. DOI: 10.1063/1.3494606

Digital Object Identifier (DOI):

[10.1063/1.3494606](https://doi.org/10.1063/1.3494606)

Link:

[Link to publication record in Edinburgh Research Explorer](#)

Document Version:

Publisher's PDF, also known as Version of record

Published In:

Review of Scientific Instruments

General rights

Copyright for the publications made accessible via the Edinburgh Research Explorer is retained by the author(s) and / or other copyright owners and it is a condition of accessing these publications that users recognise and abide by the legal requirements associated with these rights.

Take down policy

The University of Edinburgh has made every reasonable effort to ensure that Edinburgh Research Explorer content complies with UK legislation. If you believe that the public display of this file breaches copyright please contact openaccess@ed.ac.uk providing details, and we will remove access to the work immediately and investigate your claim.



A rotator for single-crystal neutron diffraction at high pressure

J. Fang, C. L. Bull, H. Hamidov, J. S. Loveday, M. J. Gutmann et al.

Citation: *Rev. Sci. Instrum.* **81**, 113901 (2010); doi: 10.1063/1.3494606

View online: <http://dx.doi.org/10.1063/1.3494606>

View Table of Contents: <http://rsi.aip.org/resource/1/RSINAK/v81/i11>

Published by the [American Institute of Physics](#).

Related Articles

Contributions of the electronic spin and orbital current to the CoCl₂ magnetic field probed in polarised neutron diffraction experiments

J. Chem. Phys. **137**, 064107 (2012)

Experimental arrangements suitable for the acquisition of inelastic neutron scattering spectra of heterogeneous catalysts

Rev. Sci. Instrum. **82**, 034101 (2011)

A large volume cell for in situ neutron diffraction studies of hydrothermal crystallizations

Rev. Sci. Instrum. **81**, 105107 (2010)

Neutron scattering study of internal void structure in RDX

J. Appl. Phys. **107**, 103527 (2010)

Short-range order and collective dynamics of poly(vinyl acetate): A combined study by neutron scattering and molecular dynamics simulations

J. Chem. Phys. **129**, 224903 (2008)

Additional information on *Rev. Sci. Instrum.*

Journal Homepage: <http://rsi.aip.org>

Journal Information: http://rsi.aip.org/about/about_the_journal

Top downloads: http://rsi.aip.org/features/most_downloaded

Information for Authors: <http://rsi.aip.org/authors>

ADVERTISEMENT

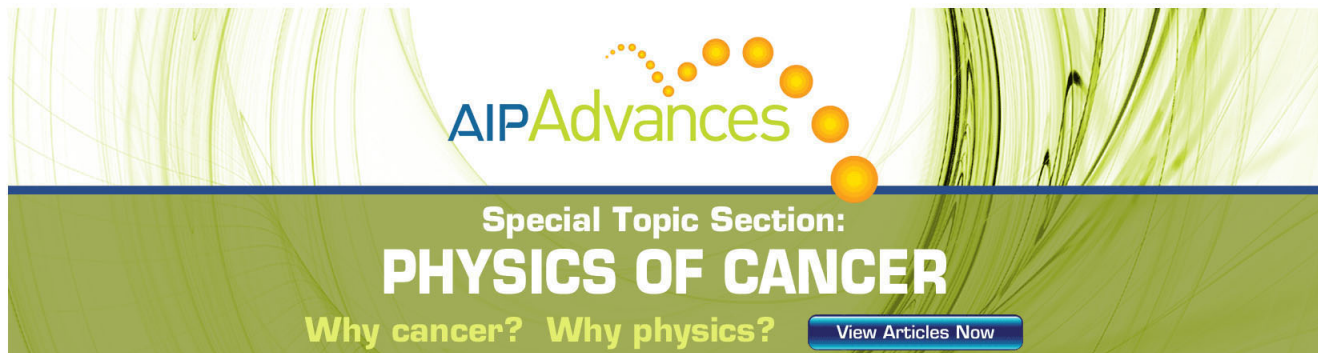

AIP Advances

Special Topic Section:
PHYSICS OF CANCER

Why cancer? Why physics? [View Articles Now](#)

A rotator for single-crystal neutron diffraction at high pressure

J. Fang,¹ C. L. Bull,² H. Hamidov,² J. S. Loveday,² M. J. Gutmann,³ R. J. Nelmes,² and K. V. Kamenev^{1,a)}

¹*School of Engineering and Centre for Science at Extreme Conditions, University of Edinburgh, Edinburgh EH9 3JZ, United Kingdom*

²*SUPA, School of Physics and Astronomy and Centre for Science at Extreme Conditions, University of Edinburgh, Edinburgh EH9 3JZ, United Kingdom*

³*ISIS Facility, Rutherford Appleton Laboratory, Chilton, Didcot, Oxon OX11 0QX, United Kingdom*

(Received 28 July 2010; accepted 6 September 2010; published online 3 November 2010)

We present a modified Paris–Edinburgh press which allows rotation of the anvils and the sample under applied load. The device is designed to overcome the problem of having large segments of reciprocal space obscured by the tie rods of the press during single-crystal neutron-scattering experiments. The modified press features custom designed hydraulic bearings and provides controls for precision rotation and positioning. The advantages of using the device for increasing the number of measurable reflections are illustrated with the results of neutron-diffraction experiments on a single crystal of germanium rotated under a load of 70 tonnes. © 2010 American Institute of Physics. [doi:10.1063/1.3494606]

I. INTRODUCTION

Since its invention in the early 1990s, the Paris–Edinburgh (PE) press has become one of the most widely used devices for high-pressure neutron scattering to date.^{1–3} By using an arrangement of two opposed single-toroidal or double-toroidal anvils^{4–6} and null-scattering metallic gaskets, it is possible to routinely achieve pressures in excess of 25 GPa on large samples. The PE press is still one of the most compact devices for its given load capabilities, and can be found in many neutron and synchrotron facilities around the world.^{7–9}

The standard PE press, e.g., its V4 variant shown in Fig. 1(a), has four tie rods which restrict the equatorial aperture to four separate $\sim 66^\circ$ windows [Fig. 1(b)].⁷ While a restricted angular aperture generally poses no major limitations in powder neutron-diffraction measurements on instruments such as HiPr/PEARL at the ISIS spallation neutron source in the U.K., the tie rods do significantly obstruct access to reciprocal space for single-crystal diffraction and inelastic techniques at pulsed and constant wavelength sources. In order to reduce this problem, the VX variant of the PE press with a larger aperture access was developed.¹⁰ This two-column variant of the PE press provides two increased openings of 140° in the equatorial plane [Fig. 1(c)]. It also has an increased opening angle of $\pm 30^\circ$ out of the equatorial plane, compared to $\pm 7^\circ$ in the V4 variants. This press has been used successfully up to 12 GPa, both at spallation and monochromatic sources, for performing high-resolution single-crystal diffraction measurements.^{11,12} However, despite the wide choice of wavelengths available at both the ISIS and Institut Laue-Langevin (ILL), the two tie rods still create

blind spots in reciprocal space. The solution to this problem would be to rotate the crystal relative to the tie rods, while maintaining the load on the sample.

A portable stress cell, roPEC, based on the V7 PE press, has recently been reported and has been specifically designed for torsional testing of materials by rotating one of the anvils with respect to the other.¹³ Topographic deformation experiments were performed using roPEC at pressures of up to 5.0 GPa under loads of up to 35 tonnes. This device is not suitable for single-crystal neutron-scattering techniques since both anvils would be required to rotate together - at the same rate in the same direction - in order to maintain the integrity of the sample, by not shearing or tilting the sample while rotating.

A system with both opposing anvils rotating together has been built for high-pressure x-ray microtomography studies. In this device, based on a Drickamer anvil apparatus, pressures of up to 8 GPa have been attained at 25 tonnes of load.¹⁴ In another study performed in this device, a maximum pressure of 11.5 GPa at 8.5 tonnes has been reported.¹⁵ However, as a result of the intrinsically low flux of neutron sources, the sample volume (between 1 and 5 mm³) required for single-crystal studies using neutrons is significantly larger than those needed for synchrotron experiments. Therefore, a significantly larger axial thrust is required to pressurize the large sample volume. The thrust is ultimately limited by the strength of the anvils used with the PE press. For neutron-diffraction studies of single crystals, anvils with a 20° bevel have been found to provide a larger out of equatorial plane scattering angle, while withstanding a load of up to 70 tonnes¹⁶ (for more discussion see Sec. III A). Here we describe the design of a device that is capable of rotating two 20° anvils together under this load within a modified variant of the V4 PE press.³ We have developed the device with the V4 press because the tie rods need to be lengthened to ac-

^{a)}Electronic mail: k.kamenev@ed.ac.uk.

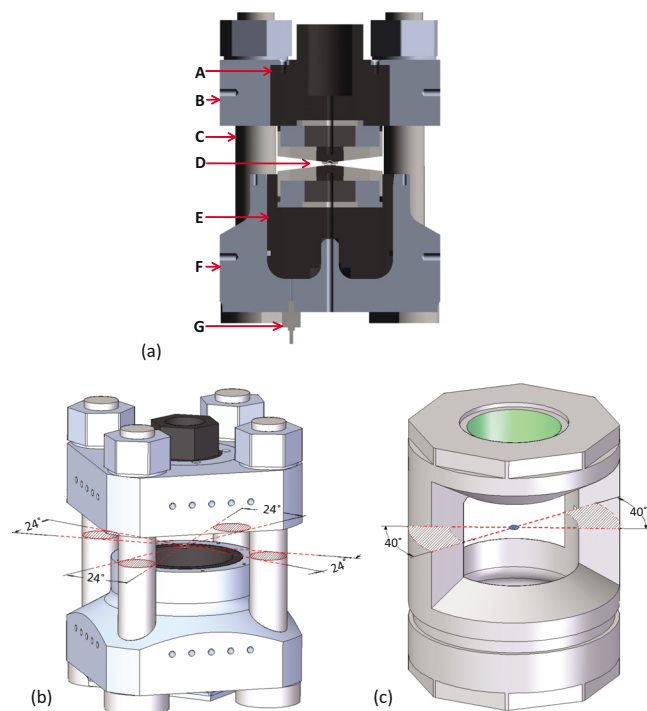

FIG. 1. (Color online) (a) and (b) The four tie-rod V4 press and (c) the two column VX press, and their equatorial apertures. (a) The structure of the V4 cell (A) the breech, (B) the top platen, (C) the tie rods, (D) the anvil/gasket assembly and seats, (E) the piston, (F) the bottom platen, and (G) port for connecting hydraulic pump. (b) In a V4 standard press, each tie rod obstructs the diffracted beam by a sector of $\sim 24^\circ$, adding up to approximately 96° in total. The equatorial aperture is $\sim 66^\circ \times 4$ as a result. (c) In a VX variant press, each column obscures the diffracted neutrons by a sector of $\sim 40^\circ$, leaving the equatorial aperture to be $\sim 140^\circ \times 2$.

commodate the rotation mechanism, and this is more difficult for the VX press. We refer to this new device as the RV4.

II. HIGH PRESSURE ROTATABLE APPARATUS

The RV4 consists of a modified V4 PE press with extended tie rods and a structure on one side that supports the motor, the gearbox, and the pinions. The system has been designed to withstand static loads of up to 150 tonnes. The ANSYS[®] finite element analysis (FEA) software package has been used extensively for calculating stress distribution and deformation in the system under this load.¹⁷ Below, we describe the design of the device and each of its components.

A. General layout of the RV4

A cross-sectional view of the apparatus is presented in Fig. 2(a). A central structure is supported by the loading frame of a standard V4 PE press. It makes use of the following principal elements: the top platen (B) with the breech (A), the bottom platen (F) with the ram (E), and the anvil/gasket assembly (D). (Note that the press is shown the other way up from the standard view in Fig. 1, in the orientation required for mounting on the single-crystal diffractometers used in this work.) These parts have not been modified and are as in Fig. 1(a). However, the tie rods (C in Fig. 2) have been extended to accommodate the extra height required for the installation of the thrust bearings (L1,L2) and extended anvil supports (I1,I2). The modified tie rods are made of the

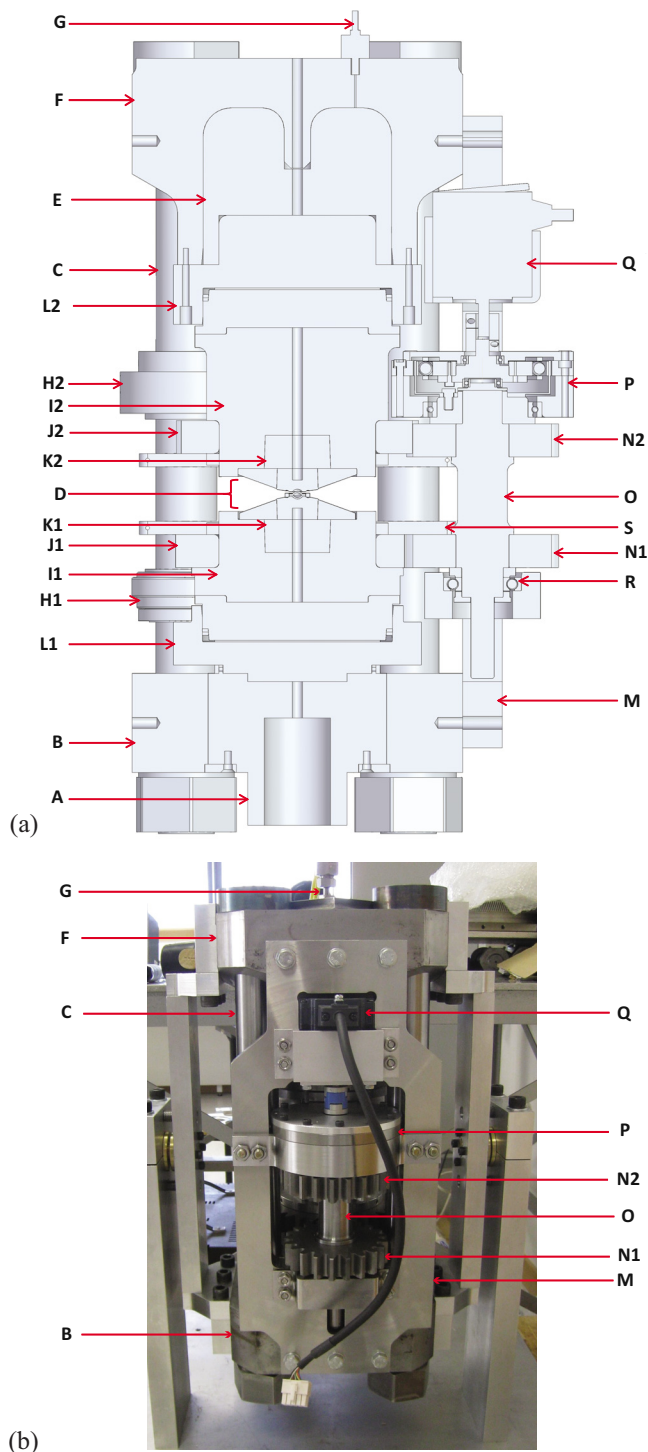

FIG. 2. (Color online) (a) Cross-sectional view of the RV4 cell and (b) photo of the side frame mounted on the PE press: (A) breech; (B) top platen; (C) tie rods; (D) anvil/gasket and sample assembly; (E) piston; (F) bottom platen; (G) port for connecting hydraulic pump; (H1,H2) needle bearings; (I1,I2) top and bottom extended anvil supports; (J1,J2) 35-tooth gears; (K1,K2) tungsten carbide anvil seats; (L1,L2) top and bottom hydraulic bearing assembly; (M) side frame; (N1,N2) 21-tooth pinions made of EN36 steel; (O) side shaft made of EN24 steel; (P) Harmonic Drive[™] gearbox; (Q) stepper motor; (R) supporting ball bearings; and (S) removable brackets.

same material as the original set,¹⁸ and are 70% longer than the original tie rods of a standard V4 press. The axial elongation of the tie rods at a load of 150 tonnes calculated using FEA is less than 0.9 mm.

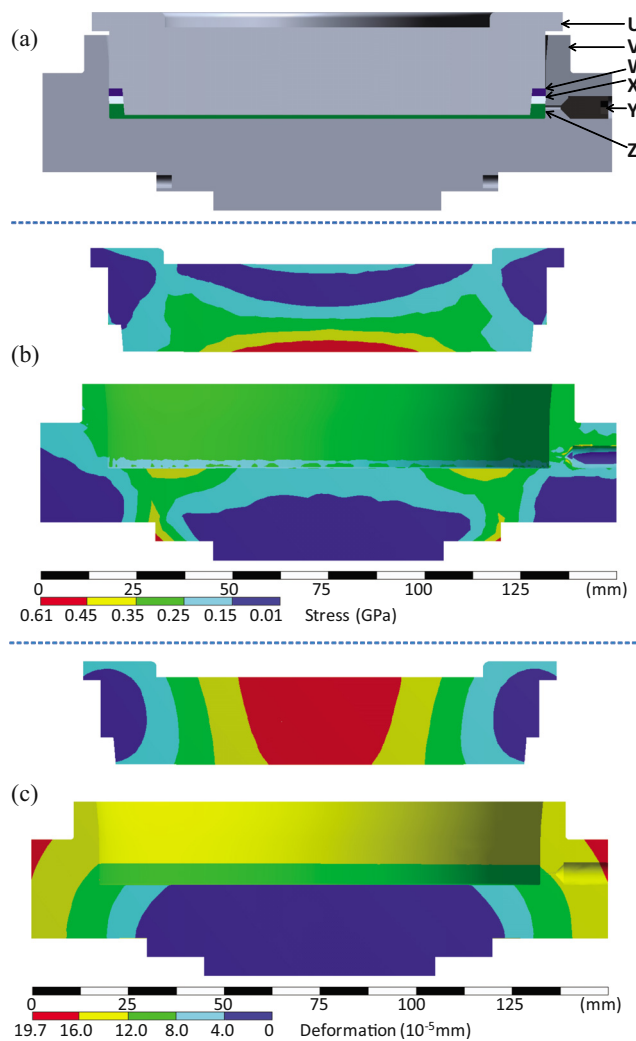

FIG. 3. (Color online) Cross-sectional view of the hydraulic bearing. (a) The hydraulic bearing assembly and parts: (U) piston; (V) cylindrical housing; (W) a Teflon[®] sealing ring; (X) a nylon ring; (Y) sealing grub screw; and (Z) hydraulic oil. (b) The von Mises stress distribution calculated by FEA. The maximum stress at 150 tonnes is approximately 0.61 GPa in the bearing housing and 0.58 GPa in the piston. (c) The deformation calculated by FEA. The maximum deformation at 150 tonnes is approximately 18 μm in the bearing housing and 20 μm in the piston.

Attached to the breech (A) and the piston (E) is a set of hydraulic bearings (L1,L2) (Fig. 2 and in more detail, Fig. 3). The bearings ensure that only the extended anvil supports (I1,I2) and the anvils (D) can rotate, while the breech and the piston are prevented from rotation during the operation of the system. The design of the hydraulic bearings is discussed in detail in Sec. II B. The extended anvil supports (I1,I2) are manufactured from maraging steel and have tungsten carbide inserts (K1,K2 respectively) fretted into them in order to support the anvils (D). Two gears (J1,J2) encircle and are attached to the top (I1) and the bottom (I2) extended anvil supports.

The side structure is an independent assembly that is mounted on the top and bottom platens (B,F). It supports the components that drive the gears (J1,J2). A steel side frame (M) provides support for the motor (Q), gearbox (P), side shaft (O), pinions (N1,N2), and supporting ball bearings (R). The ac stepper motor (Q) has an output torque of no less than

1.3 N m when turning at up to 500 rpm.¹⁹ It is linked by a coupling to the Harmonic Drive[™] gearbox (P) with a maximum output torque of 360 N m and 160:1 reduction ratio.²⁰ The resulting geared torque is then transmitted to the side shaft (O) which has two pinions (N1,N2) mounted on it through which the torque is transferred to the hexagonally hollowed gears (J1,J2). These two pairs of gears and pinions, with a reduction ratio of 5:3, are custom built by HPC Gears Ltd.²¹ The maximum calculated driving torque on the gears of the central shafts is 373 N m. However, after taking into consideration the efficiency of various components along the mechanical transmission chain, this figure is reduced to just over 200 N m.

The overall dimensions of the assembled RV4 are 48 cm \times 27 cm \times 20 cm. The mass of the whole device is approximately 125 kg.

B. Design challenges and solutions

Two significant technical problems emerged during the development of the system, and we will describe them in this section as we are aware that they are common to other similar applications. The first problem is related to a large static friction in the mechanical bearings. In the first version of the RV4, instead of hydraulic bearings (L1,L2) we used thrust roller bearings. These bearings had an inner diameter of 60 mm, an outer diameter of 130 mm, and an overall height of 42 mm, and they were the largest commercially available roller bearings that would fit between the tie rods.²² According to the manufacturer's specifications, they were rated to take a static axial load of at least 93 tonnes and were the only type of thrust bearings commercially available that met the requirements in terms of size, load capability, and self-alignment. We have since found that the bearings produce a large frictional resistance to movement and, as a result, our system initially only operated to loads of up to 25 tonnes. Mechanical bearings are employed in the existing rotator systems described above¹³⁻¹⁵, and we now understand that this has been a limiting factor in achieving rotation at higher loads.

We resolved the problem by developing compact heavy-duty hydraulic bearings. The design of the hydraulic bearing is shown in Fig. 3(a). It consists of a cylindrical housing (V) and a piston (U) separated by an approximately 1 mm thick layer of hydraulic oil (Z). Rings (W) and (X) made of Teflon[®] and nylon, respectively, are mounted on the piston. The rings seal the oil and at the same time ensure low friction of rotation. The grub screw (Y) seals the small opening in the housing used for the bleeding of air and excess oil during the assembly of the bearing. The housing of the bearing and piston can be made of maraging or stainless steel. The results of the stress and deformation simulation of the bearing under the load of 150 tonnes are shown in Figs. 3(b) and 3(c), respectively, for maraging steel. The bearings have been verified by experimental test in a version made with stainless steel, and shown to be able to withstand a static load of over 150 tonnes and to operate in the RV4 to 100 tonnes with much less frictional moment than the mechanical roller bearings. It has also been shown that the seals have

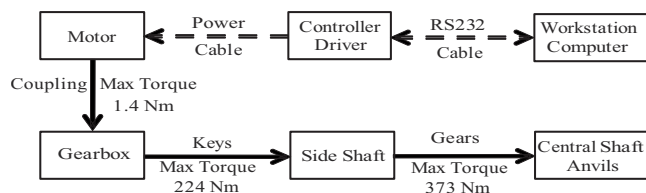

FIG. 4. Diagram of the RV4 control system. The torque shown is the maximum calculated output from the corresponding components in the system without taking into account the loss of efficiency of the components.

good resistance to wear and are suitable for continuous use in the RV4.

The other problem we encountered was that the extended anvil supports (I1,I2) tilted under a large torque delivered from the pinions (N1,N2) through the gears (J1,J2) (Fig. 2). The force is directed away from the side shaft (O) and the magnitude of the resulting deflection of the sample position has been shown to reach $\pm 0.5 \text{ mm}$ when the anvils are rotated under a load of approximately 70 tonnes. Not only may this cause damage to the single-crystal samples, but it can also lead to an increase in friction inside the hydraulic bearings or ultimately to seizing of the piston and the housing of the bearing as they become axially misaligned.

To prevent the extended anvil supports from tilting and to provide support against the side force from the pinions, four needle roller bearings with sleeves (H1,H2), Fig. 2, are mounted on the two tie rods opposite to the side structure. The sleeves are machined to high tolerances to give them the proper location with respect to the extended anvil supports. By using these supports, the displacement of the sample from an axial position during anvil rotation has been reduced to less than $\pm 0.1 \text{ mm}$.

C. Rotation control and dynamic characteristics

The rotational motion is driven by a single-phase ac closed-loop stepper motor with a driver and a built-in controller package. The controller communicates with the host computer via a serial protocol, which can be incorporated into the communication between the workstations controlling sample environment and data acquisition on diffractometers such as the single-crystal instruments SXD at ISIS and D9 at ILL. The output of the motor has a resolution of 0.36° per step in the motor shaft, which is translated to only 0.00135° per step in the anvils. (The total reduction ratio between the motor shaft and the anvils delivered via the gearbox and the gear/pinion mechanism is 800:3.) The continuous operation speed of $360^\circ/\text{s}$ for the stepper motor thus translates into $1.35^\circ/\text{s}$ rotation in the anvils assembly. The control communication system, with the schematics of mechanical transmission, is shown in Fig. 4.

The total resulting backlash of the mechanical system, resulting mainly from the meshing of the gear/pinion pairs, was found to be approximately 0.5° during online testing. The RV4 can be operated in the same direction (i.e., only clockwise or only counterclockwise 360° rotation without collision or problems with the hydraulic hoses twisting) in which case there is no backlash and a high precision positioning of the crystal can be achieved to within $\pm 0.2^\circ$. If the

rotator is operated in both directions, corrections for backlash are introduced by the drive software. Additionally, a mechanical microswitch manufactured by Honeywell is installed on the housing of the bottom bearing as a reference of the position. It alleviates the “backlash-introduced positioning error” by providing a reference home position which is checked regularly during its operation to ensure that no loss of position has occurred. During neutron-diffraction experiments, the RV4 is expected to provide rotation of the sample through small angles and at low RPMs.

III. SINGLE-CRYSTAL NEUTRON-SCATTERING EXPERIMENT

A. Experimental techniques

For high-pressure single-crystal neutron-scattering experiments, the choice of the opposing anvil and gasket assembly depends on many factors such as the required range of sample pressures, the size of the sample, and orientation of the press relative to the incident and diffracted beam. Available options of these opposing anvils for the Paris-Edinburgh press include single-toroidal anvils¹⁻³ and double-toroidal anvils,^{7,8} typically manufactured from tungsten carbide, sintered diamond, or cubic boron nitride with gaskets made of titanium-zirconium alloy, pyrophyllite, beryllium-copper alloy, or other deformable low-scattering or null-scattering neutron-scattering materials.²³ For the study set out below, we have used single-toroidal anvils made of tungsten carbide which are bevelled with a 20° angle.¹⁶ For the original implementation of the PE press on the POLARIS and then the HiPr/PEARL beamlines at ISIS, a 7° bevel angle was adopted to match the acceptance angle of the 90° detector banks for powder diffraction collection.¹ As already noted, a variant with a bevel angle of 20° has now been developed to allow a greater angular access for single-crystal data collection. However, this is achieved at the cost of ultimate load capability in that the support provided by the hardened steel fretage is dependent on the bevel angle. 20° anvils have been successfully used in VX presses to approximately 8 GPa in single-crystal neutron-diffraction studies.¹¹ In the RV4, both 7° and 20° single-toroidal bevel anvils fit in with the top (I1) and bottom (I2) extended anvil supports (Fig. 2). Six M3 grub screws peg the outer frets of the anvils ensuring that the anvil assembly rotates with the extended anvil support.

It is necessary to mount the press with the breech at the bottom of the support assembly on the SXD instrument and the position of the RV4 with respect to the instrument's vacuum tank, as shown in Fig. 5. With the breech fully inserted, there is a 3 mm gap between the anvils. When the sample and gaskets are to be loaded into the cell, the breech (A in Fig. 2) can be withdrawn by 5 mm from its fully inserted position so that the hydraulic bearing (L1) and extended anvil support (I1), with its anvil, are lowered, while the components on the other side (I2, J2, K2, and L2 in Fig. 2) remain in place supported by removable brackets mounted on the tie rods (S). With the breech withdrawn, there is then a total gap of 8 mm between the top and bottom anvils available for placing the gasket and sample in place, and transfer-

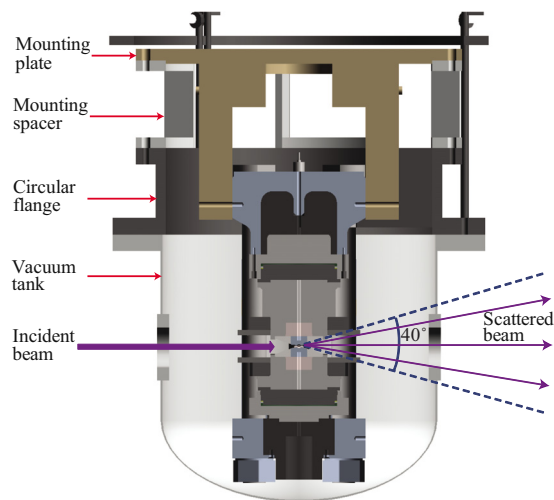

FIG. 5. (Color online) Cross-sectional view of the RV4 experimental setup at the SXD instrument, ISIS. The vertical angular aperture for the scattered beam is 40° as a pair of 20° bevelled anvils was utilized in the experiment to maximize access to reciprocal space. Surrounding the setup are the six ZnS scintillator detectors centered on the equatorial plane of the instrument that can be accessed for high-pressure measurements (Refs. 24 and 25). The RV4 is shown in the projection in which the steel side frame is behind the press.

ring pressure transmitting media into the sample space. Once the gasket assembly, sample, and pressure transmitting medium are inserted between the anvils, the breech can be screwed upward to its home position to close the gap between the anvils, and a load is then applied to seal the gasket assembly preventing the loss of the pressure transmitting medium.

B. Neutron-diffraction experiment on D9 and SXD

Initial testing was performed on a single crystal of squaric acid using the D9 monochromatic-beam diffractometer at the ILL reactor source. Adaptor plates were manufactured to allow the press to be mounted on an XYZ table attached to the ω table of the instrument, and the hardware controlling the rotation mechanism was incorporated into the instrument control software (MAD). This meant that it was possible to accurately control the rotation of the anvils to bring a specific reflection of squaric acid into the diffraction position. This initial testing was performed up to 25 tonnes in the first version of the RV4 with the mechanical thrust roller bearings, and the hardware was found to fully integrate into the D9 instrument and associated software.

In situ high-pressure neutron-scattering experiments have also been performed on a single crystal of germanium. The single-crystal diffractometer at the ISIS pulsed neutron source (SXD) was used. The configuration of the RV4 mounted in the SXD instrument is shown schematically in Fig. 5. SXD utilizes polychromatic pulses of neutrons, and allows access to large volumes of reciprocal space simultaneously by time-of-flight Laue techniques.^{11,24,25} The details of the sample loading and orientation process were the same as described by Bull *et al.*¹¹ A pair of 20° bevelled anvils was mounted in the RV4 press and modified encapsulated gaskets^{11,23} made of null-scattering TiZr alloy (67:33 molar ratio) were used. A cylindrically shaped single crystal of ger-

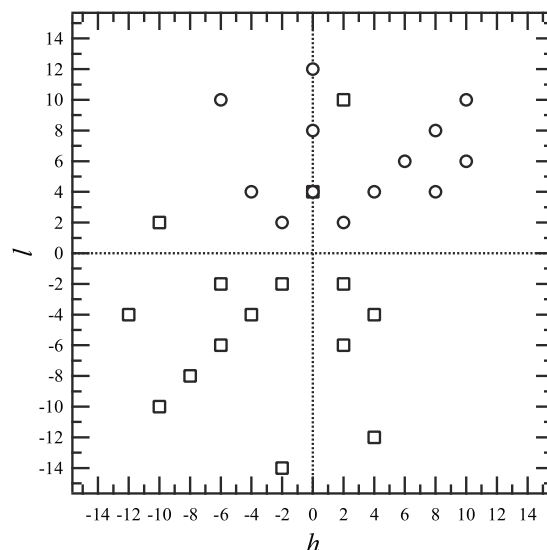

FIG. 6. The map of all the $h0l$ reflections strong enough to be observed during the SXD experiment on a single crystal of germanium at 70 tonnes in the RV4. The h and l Miller indices are shown along the x and y axes, respectively. The reflections in the original orientation of the crystal are shown as squares. The reflections observed from the same $h0l$ layer after rotation of the crystal by 44.6° are shown as circles. Note that 004 is the only reflection visible in both orientations of the sample.

manium, of approximately 3 mm diameter and 1 mm height (see Bull *et al.*¹¹), was mounted on the flat surface of a modified gasket and a deuterated methanol:ethanol (4:1) mixture was used as a quasihydrostatic pressure medium. To reduce the background inherent from the anvils, gasket, and press, the steel of the anvils and RV4 in the incident and diffracted beam path were covered with thin cadmium sheets. The beam size was defined further by the jaws of the SXD instrument itself.²⁴

With the sample loaded into the gasket and the pressure medium placed in the sample chamber, the load on the press was increased in order to seal the gasket assembly and prevent the loss of the volatile pressure medium. The press assembly was mounted on SXD in an orientation which minimizes shadowing of the detectors by the tie rods. With an applied load of 7 tonnes, the sample was very close to ambient pressure, and a diffraction measurement was made to determine the sample orientation. The hydraulic load on the piston was then sequentially increased and the changes in the diffraction patterns were observed after each 10-tonne step increase of load. This was to ensure that the crystal was not damaged and to monitor the generated sample pressure. At 70 tonnes a sample pressure of ~ 6 GPa was achieved and a data set was collected for a period of approximately 6 h.

On completion of the data collection the bearings, the extended anvil supports, the anvils, and the sample were rotated by 44.6° , to bring previously inaccessible reflections out of the “shadow” of the tie rods. Figure 6 shows all the reflections strong enough to be observed in the 6 hour run from the horizontal $h0l$ layer. The reflections observed in the original position of the sample are shown as squares, and those observed after rotation are shown as circles (Fig. 6). The substantially increased access to reciprocal space is clear. The reflections obtained after rotation were observed at

positions predicted by the same rotation of the initial orientation matrix of the crystal, and reflections were unaltered in their shape and intensity. This indicates that a good quasi-hydrostatic environment was maintained during the increase of applied load and that there was no mismatch in rotation of the two anvils sufficient to cause any detectable shearing of the sample crystal.

IV. CONCLUSIONS

We have designed and built a modified variant of the Paris–Edinburgh press for performing co-rotation of the two anvils and the sample under high pressure. The device has been developed for performing *in situ* neutron-diffraction experiments on single crystals. It features custom-built hydraulic bearings, and provisions are made to improve the stability of the device during the rotation. The mechanical drive system, which includes the motor, the gearbox, the pinions, and the gears, is designed to provide a reliable and steady rotational movement under load. The electronics control system ensures the precision positioning of the sample with respect to the incident beam and the detectors during the measurement, and can be easily integrated into the sample control environment at neutron sources. The design of the device has been optimized by using FEA in order to achieve the best possible performance while keeping the dimensions and the weight to a minimum. The RV4 has been designed to withstand a static load of 150 tonnes. Its rotational performance has been tested during an experiment on a single crystal of germanium at 70 tonnes on the SXD instrument (ISIS, RAL). And operation up to 100 tonnes has been confirmed in off-line tests.

In terms of the mechanical performance of the rotator, it would be possible to extend its range of use in experiments to loads over 100 tonnes, possibly to 150 tonnes, by using maraging steel for the construction and making some design modifications arising from tests of this first device. The combination of higher loads and some reduction in sample size can be expected to extend the usable pressure range to 17 GPa or more. Pressures beyond that should be reachable by designing a higher capacity version of the rotator for the higher-capacity (400-tonnes) V7 press²⁶ which is 25% wider and 40% taller than the V4 and VX presses.

ACKNOWLEDGMENTS

The authors would like to thank Mr. Paul Aitken (CSEC), Mr. John Archer (ILL), and Mr. John Allibon (ILL) for their technical assistance. They would also like to express their appreciation to Dr. Stefan Klotz for his constructive comments and suggestions. The work is funded by the Engineering and Physical Sciences Research Council, U.K. (Grant No. EP/E031099/1).

- ¹J. M. Besson, R. J. Nelmes, G. Hamel, J. S. Loveday, G. Weill, and S. Hull, *Physica B* **180–181**, 907 (1992).
- ²J. M. Besson, G. Weill, G. Hamel, R. J. Nelmes, J. S. Loveday, and S. Hull, *Phys. Rev. B* **45**, 2613 (1992).
- ³J. M. Besson, Ph. Pruzan, S. Klotz, G. Hamel, B. Silvi, R. J. Nelmes, J. S. Loveday, R. M. Wilson, and S. Hull, *Phys. Rev. B* **49**, 12540 (1994).
- ⁴L. G. Khvostantsev, V. A. Sidorov, and A. P. Novikov, *High Temp. - High Press.* **9**, 637 (1977).
- ⁵L. G. Khvostantsev, *High Temp. - High Press.* **16**, 165 (1983).
- ⁶L. G. Khvostantsev, *High Temp. - High Press.* **16**, 171 (1983).
- ⁷J. M. Besson and R. J. Nelmes, *Physica B* **213–214**, 31 (1995).
- ⁸S. Klotz, J. M. Besson, G. Hamel, R. J. Nelmes, J. S. Loveday, W. G. Marshall, and R. M. Wilson, *Appl. Phys. Lett.* **66**, 1735 (1995).
- ⁹S. Klotz, J. M. Besson, G. Hamel, R. J. Nelmes, J. S. Loveday, and W. G. Marshall, *High Press. Res.* **14**, 249 (1996).
- ¹⁰S. Klotz, G. Hamel, and J. Frelat, *High Press. Res.* **24**, 219 (2004).
- ¹¹C. L. Bull, M. Guthrie, R. J. Nelmes, J. S. Loveday, K. Komatsu, H. Hamidov, and M. J. Gutmann, *High Press. Res.* **29**, 780 (2009).
- ¹²C. L. Bull, M. Guthrie, R. J. Nelmes, J. S. Loveday, H. Hamidov, and M. J. Gutmann, *High Press. Res.* **29**, 644 (2009).
- ¹³G. D. Bromiley, S. A. T. Redfern, Y. L. Godec, G. Hamel, and S. Klotz, *High Press. Res.* **29**, 306 (2009).
- ¹⁴Y. Wang, T. Uchida, F. Westferro, M. L. Rivers, N. Nishiyama, J. Gebhardt, C. E. Leshner, and S. R. Sutton, *Rev. Sci. Instrum.* **76**, 073709 (2005).
- ¹⁵C. E. Leshner, Y. Wang, S. Gaudio, A. Clark, N. Nishiyama, and M. Rivers, *Phys. Earth Planet. Inter.* **174**, 292 (2009).
- ¹⁶C. L. Bull, M. Guthrie, S. Klotz, J. Philippe, T. Strässle, R. J. Nelmes, J. S. Loveday, and G. Hamel, *High Press. Res.* **25**, 229 (2005).
- ¹⁷ANSYS, Inc., <http://www.ansys.com/>.
- ¹⁸Maraging steel 819AW was supplied by Aubert & Duval, <http://www.aubertduval.com/>.
- ¹⁹The ac stepper motor model AS66ACEP from Oriental Motor Corp., <http://www.orientalmotor.com/>.
- ²⁰Harmonic Drive™ gearbox is manufactured by Harmonic Drive AG, <http://www.harmonicdrive.de/>.
- ²¹HPC Gears, <http://www.hpcgears.com/>.
- ²²Thrust roller bearings model 29412E manufactured by SKF, <http://www.skf.com/>.
- ²³W. G. Marshall and D. J. Francis, *J. Appl. Crystallogr.* **35**, 122 (2002).
- ²⁴D. A. Keen, M. J. Gutmann, and C. C. Wilson, *J. Appl. Crystallogr.* **39**, 714 (2006).
- ²⁵M. J. Gutmann, D. A. Keen, and C. C. Wilson, *High Press. Res.* **23**, 313 (2003).
- ²⁶Y. Le Godec, G. Hamel, D. Martinez-Garcia, T. Hammouda, V. L. Solozhenko, and S. Klotz, *High Press. Res.* **25**, 243 (2005).