



DIGITAL ACCESS TO SCHOLARSHIP AT HARVARD

Message Passing Inference with Chemical Reaction Networks

The Harvard community has made this article openly available.
[Please share](#) how this access benefits you. Your story matters.

Citation	Napp, Nils E and Ryan Adams. 2013. "Message passing inference with chemical reaction networks." In Advances in Neural Information Processing Systems 26, ed. Christopher J.C. Burges, Léon Bottou and Max Welling and Zoubin Ghahramani and Kilian Q. Weinberger, 2247--2255. Red Hook, NY: Curran Associates, Inc. Paper presented at the 27th Annual Conference on Neural Information Processing Systems 2013, December 5-10, 2013, Lake Tahoe, Nevada, USA.
Published Version	http://papers.nips.cc/paper/4901-message-passing-inference-with-chemical-reaction-networks
Accessed	February 19, 2015 4:05:18 PM EST
Citable Link	http://nrs.harvard.edu/urn-3:HUL.InstRepos:12559584
Terms of Use	This article was downloaded from Harvard University's DASH repository, and is made available under the terms and conditions applicable to Open Access Policy Articles, as set forth at http://nrs.harvard.edu/urn-3:HUL.InstRepos:dash.current.terms-of-use#OAP

(Article begins on next page)

Message Passing Inference with Chemical Reaction Networks

Nils Napp and Ryan Prescott Adams
School of Engineering and Applied Sciences
Harvard University
Cambridge, MA 02138
{nnapp, rpa}@seas.harvard.edu

Abstract

Recent work on molecular programming has explored new possibilities for computational abstractions with biomolecules, including logic gates, neural networks, and linear systems. In the future such abstractions might enable nanoscale devices that can sense and control the world at a molecular scale. Just as in macroscale robotics, it is critical that such devices can learn about their environment and reason under uncertainty. At this small scale, systems are typically modeled as chemical reaction networks. In this work, we develop a procedure that can take arbitrary probabilistic graphical models, represented as factor graphs over discrete random variables, and compile them into chemical reaction networks that implement inference. In particular, we show that marginalization based on sum-product message passing can be implemented in terms of reactions between chemical species whose concentrations represent probabilities. We show algebraically that the steady state concentration of these species correspond to the marginal distributions of the random variables in the graph and validate the results in simulations. As with standard sum-product inference, this procedure yields exact results for tree-structured graphs, and approximate solutions for loopy graphs.

1 Introduction

Recent advances in nanoscale devices and biomolecular synthesis have opened up new and exciting possibilities for constructing microscopic systems that can sense and autonomously manipulate the world. Necessary to such advances is the development of computational mechanisms and associated abstractions for algorithmic control of these nanorobots. Work on molecular programming has resulted in *in vitro* biomolecular implementations of various such abstractions, including logic gates [12], artificial neural networks [6, 7, 10], tiled self-assembly models [8, 11], and linear systems [3, 9, 16]. Similarly, *in vivo*, gene regulatory networks can be designed that when transformed into cells implement devices such as oscillators [5], intracellularly coupled oscillators [4], or distributed algorithms such as pattern formation [1]. Many critical information processing tasks can be framed in terms of probabilistic inference, in which noisy or incomplete information is accumulated to produce statistical estimates of hidden structure. In fact, we believe that this particular computational abstraction is ideally suited to the noisy and often poorly characterized microscopic world. In this work, we develop a chemical reaction network for performing inference in probabilistic graphical models. We show that conventional message passing schemes, such as belief propagation, map relatively straightforwardly onto sets of chemical reactions, which we think of as the “assembly language” of both *in vitro* and *in vivo* computation at the molecular scale. The long-term possibilities of such technology are myriad: adaptive and tissue-sensitive drug delivery, *in situ* chemical sensing, and identification of disease states.

Let G be a factor graph over N random variables $\{x_n\}_{n=1}^N$ where x_n takes one of K_n discrete values. The global N -dimensional random variable \mathbf{x} takes on values in the (potentially huge) product space $\mathbf{K} = \prod_{n=1}^N \{1, \dots, K_n\}$. The other nodes of G are called factors and every edge in G connects exactly one factor node and one variable node. In general, G can have J factors $\{\psi_j(\mathbf{x}^j)\}_{j=1}^J$ where we use $\mathbf{x}^j = \text{ne}(j)$ to indicate the subset of random variables that neighbors of factor j . Each \mathbf{x}^j takes on values in the (potentially much smaller) space $\mathbf{K}^j = \prod_{n \in \text{ne}(j)} \{1, \dots, K_n\}$, and each ψ_j is a non-negative scalar function on \mathbf{K}^j . Together the structure of G and the particular factors ψ_j define a joint distribution on \mathbf{x} :

$$\Pr(\mathbf{x}) = \Pr(x_1, x_2, \dots, x_N) = \frac{1}{Z} \prod_{j=1}^J \psi_j(\mathbf{x}^j), \quad (1)$$

where Z is the appropriate normalizing constant. Figure 1a shows a simple factor graph with two variable nodes and three factors. It implies that the the joint distribution x_1 and x_2 has the form $\Pr(x_1, x_2) = \frac{1}{Z} \psi_1(x_1) \psi_2(x_2) \psi_3(x_1, x_2)$.

The sum-product algorithm (belief propagation) is an dynamic programming technique for performing marginalization in a factor graph. That is, it computes sums of the form:

$$\Pr(x_n) = \frac{1}{Z} \sum_{\mathbf{x} \setminus x_n} \prod_{j=1}^J \psi_j(\mathbf{x}^j). \quad (2)$$

For tree-structured factor graphs, the sum-product algorithm efficiently recovers the exact marginals. For more general graphs, the sum-product algorithm often converges to useful approximations. This approximate situation is called *loopy belief propagation*.

The sum-product algorithm proceeds by passing “messages” along the graph edges. There are two kinds of messages messages from a factor node to a variable node and messages from a variable node to a factor node. In order to make clear what quantities are represented by chemical species concentrations in Section 4, we use somewhat unconventional notation. The k th entry of the *sum* message from factor node j to variable node n is denoted $S_k^{(j \rightarrow n)}$ and the entire K_n -dimensional vector is denoted by $\mathbf{S}^{(j \rightarrow n)}$. The k th entry of the *product* message from variable n to factor node j is denoted by $P_k^{(n \rightarrow j)}$ and the entire K_j -dimensional vector is denoted $\mathbf{P}^{(n \rightarrow j)}$. Figure 1a shows a simple factor graph with message names and their directions shown as gray arrows. Sum messages from j are computed as the weighted sum of product messages over the domain \mathbf{K}^j of ψ_j :

$$S_k^{(j \rightarrow n)} = \sum_{\mathbf{k}_n^j = k} \psi_j(\mathbf{x}^j = \mathbf{k}^j) \prod_{n' \in \text{ne}(j) \setminus n} P_{\mathbf{k}_{n'}^j}^{(n' \rightarrow j)}. \quad (3)$$

where $\text{ne}(j) \setminus n$ refers to the variable node neighbors of j except n and $\mathbf{k}_n^j = k$ to the set of all $\mathbf{k}^j \in K^j$ where the entry in the dimension of n is fixed to k . Product messages are computed by taking the component-wise product of incoming sum messages:

$$P_k^{(n \rightarrow j)} = \prod_{j' \in \text{ne}(n) \setminus j} S_k^{(j' \rightarrow n)}, \quad (4)$$

The variable node marginals can be found using the product of incoming sum messages:

$$\Pr(x_n = k) = \prod_{j \in \text{ne}(n)} S_k^{(j \rightarrow n)}. \quad (5)$$

The sum-product algorithm corresponds to fixed-point iterations that are minimizing the Bethe free energy. This observation leads to both partial-update or *damped* variants of sum-product, as well as asynchronous versions [14, Ch.6][15]. The validity of damped asynchronous sum-product is what enables us to frame the computation as a chemical reaction network. The continuous ODE description of species concentrations that represent messages can be thought of as an infinitesimally small version of damped asynchronous update rules.

3 Chemical Reaction Networks

The following model describes how a set of M chemical species $\mathcal{Z} = \{Z_1, Z_2, \dots, Z_M\}$ interact and their concentrations evolve over time. Each *reaction* has the general form

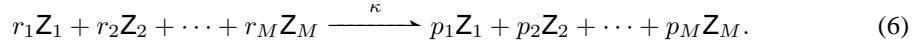

In this generic representation most of the coefficients $r_m \in \mathbb{N}$ and $p_m \in \mathbb{N}$ are typically zero (where \mathbb{N} indicates non-negative integers). The species on the left with non-zero coefficients are called *reactants* and are consumed during the reaction. The species on the right with non-zero entries are called *products* and are produced during the reaction. Species that participate in a reaction, i.e., $r_m > 0$, but where no net consumption or production occurs, $r_m = p_m$, are called *catalysts*. They change the dynamics of a particular reaction without being changed themselves.

A *reaction network* over a given set of species consists of a set of Q reactions $\mathcal{R} = \{R_1, R_2, \dots, R_Q\}$, where each reaction is a triple of reaction parameters (6),

$$R_q = (\mathbf{r}^q, \kappa_q, \mathbf{p}^q). \quad (7)$$

For example, in a reaction $R_q \in \mathcal{R}$ where species \mathbf{Z}_1 and \mathbf{Z}_3 form a new chemical species \mathbf{Z}_5 at a rate of κ_q , the reactant vector \mathbf{r}^q is zero everywhere except at $\mathbf{r}_1^q = \mathbf{r}_3^q = 1$. The associated product vector \mathbf{p}^q is zero everywhere except at $\mathbf{p}_5^q = 1$. In the reaction notation where non-participating species are dropped reaction R_q is can be compactly written as

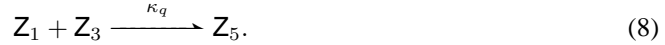

3.1 Mass Action Kinetics

The concentration of each chemical species \mathbf{Z}_m is denoted by $[\mathbf{Z}_m]$. A reaction network describes the evolution of species concentrations as a set of coupled non-linear differential equations. For each species concentration $[\mathbf{Z}_m]$ the rate of change is given by *mass action kinetics*,

$$\frac{d[\mathbf{Z}_m]}{dt} = \sum_{q=1}^Q \kappa_q \prod_{m'=1}^M [\mathbf{Z}_{m'}]^{r_{m'}^q} (\mathbf{p}_m^q - \mathbf{r}_m^q). \quad (9)$$

Based on the fact that reactant coefficients appear as powers, the sum $\sum_{m=1}^M \mathbf{r}_m$ is called the *order* of a reaction. For example, if the only reaction in a network were the second order reaction (8), the concentration dynamics of $[\mathbf{Z}_1]$ would be

$$\frac{d[\mathbf{Z}_1]}{dt} = -\kappa_q [\mathbf{Z}_1][\mathbf{Z}_3]. \quad (10)$$

We design reaction networks where the *equilibrium* concentration of some species corresponds to the result we are interested in computing. In general, chemical systems can exhibit complex dynamical behaviors, be dominated non-equilibrium dynamics, and grow without bounds (at least their models can). As such, we need to be sure that equilibrium solutions exists and that the system will approach it. The reaction networks in the following section do not contain auto-catalytic reactions, that would create mass, or require flux of some fuel that provides energy. Instead, we design a *closed* system where different species catalyze one another. By taking a thermodynamic view of this abstracted physical model, an equilibrium solution is guaranteed to exist and the system will stably approach it. Non-equilibrium behavior, such as oscillations are at best transient.

4 Representing Graphical Models with Reaction Networks

In the following compilation procedure, each message and marginal probability is represented by a set distinct chemical species. We design networks that cause them interact in such a way that, at steady state the concentration of some species represent the marginal distributions of the variable nodes in a factor graph. When information arrives the network equilibrates to the new, correct, value. Since messages in the sum-product inference algorithm are computed from other messages, the reaction networks that implement sending messages describe how species from one message catalyze the species of another message.

Beliefs and messages are represented as concentrations of chemical species: each component of a sum message, $S_k^{(j \rightarrow n)}$, has an associated chemical species $\mathbf{S}_k^{(j \rightarrow n)}$; each component of a product message, $P_k^{(n \rightarrow j)}$, has an associated chemical species $\mathbf{P}_k^{(n \rightarrow j)}$; and each component of a marginal

probability distribution, $\Pr(x_n = k)$, has an associated chemical species \mathbf{P}_k^n . In addition, each message and marginal probability distribution has a chemical species with a zero subscript that represents unassigned probability mass. Together, the set of species associated with a messages or marginal probability are called a *belief species*, and the reaction networks presented in the subsequent sections are designed to conserve species – and by extension their concentrations – with each such set. For example, the concentration of belief species $\mathcal{P}^n = \{\mathbf{P}_k^n\}_{k=0}^{K_n}$ of $\Pr(x_n)$ have a constant sum, $\sum_{k=0}^{K_n} [\mathbf{P}_k^n] = \text{const}$, determined by the initial concentrations. These sets belief species are a chemical representation of the left hand sides of Equations 3–5. The next few sections present reaction networks whose dynamics implement their right hand sides.

4.1 Belief Recycling Reactions

Each set of belief species has an associated set of reactions that recycle assigned probabilities to the unassigned species. By continuously and dynamically re-allocating probability mass, the resulting reaction network can adapt to changing potential functions ψ_j , i.e. new information.

For example, the factor graph shown in Figure 1a has 8 distinct sets of belief species – 2 representing marginal probabilities of x_1 and x_2 , and 6 (ignoring messages to leaf factor nodes) representing messages. The associate recycling reactions are

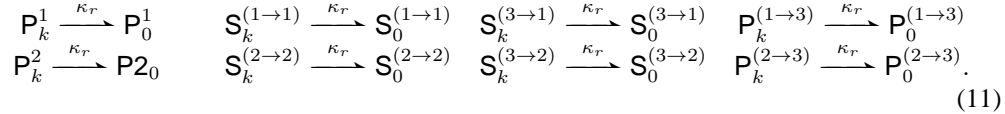

By choosing a smaller rate κ_r less of the probability mass will be unassigned at steady state, i.e. quantities will be closer to normalized, however the speed at which the reaction network reaches steady state decreases, see Section 5.

4.2 Sum Messages

In the reactions that implement messages from factor to variable nodes, the message species of incoming messages catalyze the assignment of the outgoing message species and the entry in the factor table determine the associated rate constant. The k th message component from a factor node ψ_j to the variable node x_n is implemented by a reactions of the form

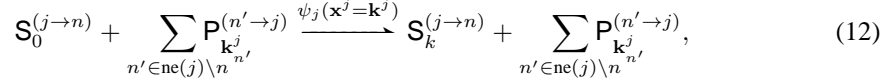

where the n th component of \mathbf{k}^j is clamped to k , $\mathbf{k}_n^j = k$. Using the law of mass action, the kinetics for each sum message species are given by

$$\frac{d[\mathbf{S}_k^{(j \rightarrow n)}]}{dt} = \sum_{\mathbf{k}_n^j = k} \psi_j(\mathbf{x}^j = \mathbf{k}^j) [\mathbf{S}_0^{(j \rightarrow n)}] \prod_{n' \in \text{ne}(j) \setminus n} [\mathbf{P}_{\mathbf{k}_{n'}^j}^{(n' \rightarrow j)}] - \kappa_r [\mathbf{S}_k^{(j \rightarrow n)}]. \quad (13)$$

At steady state the concentration of $\mathbf{S}_k^{(j \rightarrow n)}$ is given by

$$\frac{\kappa_r}{[\mathbf{S}_0^{(j \rightarrow n)}]} [\mathbf{S}_k^{(j \rightarrow n)}] = \sum_{\mathbf{k}_n^j = k} \psi_j(\mathbf{x}^j = \mathbf{k}^j) \prod_{n' \in \text{ne}(j) \setminus n} [\mathbf{P}_{\mathbf{k}_{n'}^j}^{(n' \rightarrow j)}]. \quad (14)$$

Where all $[\mathbf{S}_k^{(j \rightarrow n)}]$ species concentrations have the same factor $\frac{\kappa_r}{[\mathbf{S}_0^{(j \rightarrow n)}]}$. Their relative concentrations are exactly the message according to the to Equation (3). As κ_r decreases, the concentration of unassigned probability mass decreases and the concentration normalized by the constant sum of all the related belief species can be interpreted as a probability. For example, in the simple example the four factor-to-variable messages in the simple example graph shown in Figure 1(a) can be implemented with the reactions

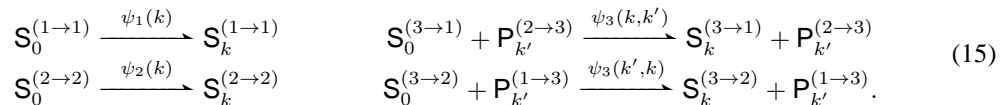

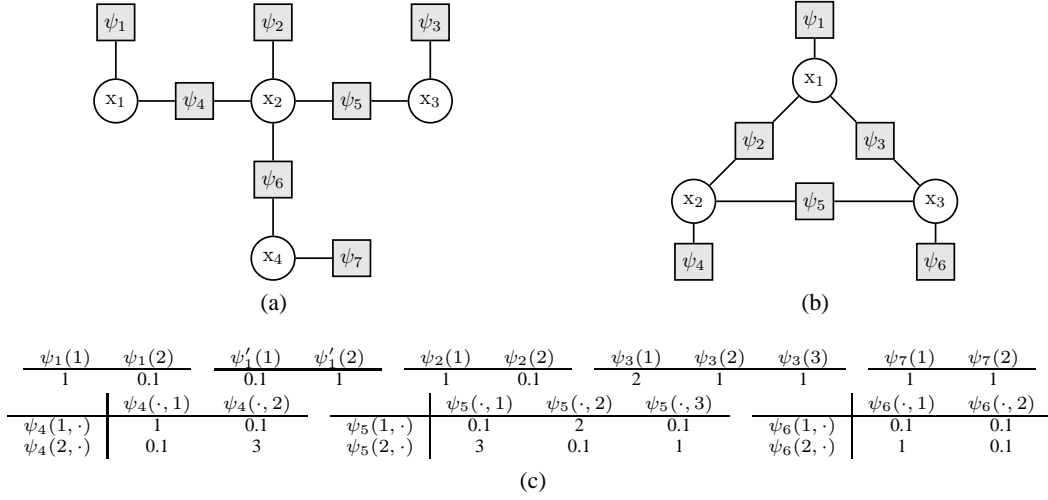
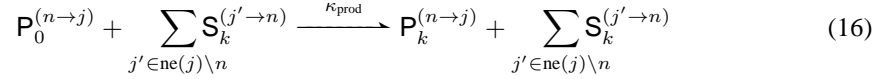

Figure 2: Examples of non-trivial factor graphs. (a) Four variable factor graph with binary factors. The factor leaves can be used to specify information about a particular random variable. (b) Example of a small three variable cyclic graph. (c) Factors for (a) used in simulation experiments in Sec. 5.1.

4.3 Product Messages

Reaction networks that implement variable to factor node messages have a similar, but slightly simpler, structure. Again, each components species of the message is catalyzed by all incoming messages species but only of the same component species. The rate constant for all product message reactions is the same κ_{prod} resulting in a reactions of the following form for a message from variable node n to factor node j ,



The dynamics of the message component species is given by

$$\frac{d[\mathbf{P}_k^{(n \rightarrow j)}]}{dt} = \kappa_{\text{prod}}[\mathbf{P}_0^{(n \rightarrow j)}] \prod_{j' \in \text{ne}(j) \setminus n} [\mathbf{S}_k^{(j' \rightarrow n)}] - \kappa_r[\mathbf{P}_k^{(n \rightarrow j)}]. \quad (17)$$

At steady state the concentration of $\mathbf{P}_k^{(n \rightarrow j)}$ is given by

$$\frac{\kappa_r}{\kappa_{\text{prod}}[\mathbf{P}_0^{(n \rightarrow j)}]}[\mathbf{P}_k^{(n \rightarrow j)}] = \prod_{j' \in \text{ne}(j) \setminus n} [\mathbf{S}_k^{(j' \rightarrow n)}]. \quad (18)$$

Again, since all the component species of product messages have the same multiplier $\frac{\kappa_r}{\kappa_{\text{prod}}[\mathbf{P}_0^{(n \rightarrow j)}]}[\mathbf{P}_k^{(n \rightarrow j)}]$, the steady state species concentrations compute the correct message according to Equation 4. For example, the two different sets of variable to factor messages in Figure 1a are

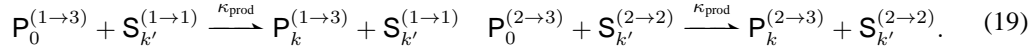

Similarly, the reactions to compute the marginal probabilities of x_1 and x_2 in Figure 1a are

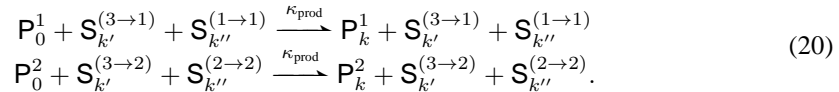

The two global rate constants κ_{prod} and κ_r can be adjusted to trade-off speed vs. accuracy of the solution, see Section 5.

Together, reactions for recycling probability mass, implementing sum-product messages, and implementing product messages define a reaction network whose equilibrium computes the messages and

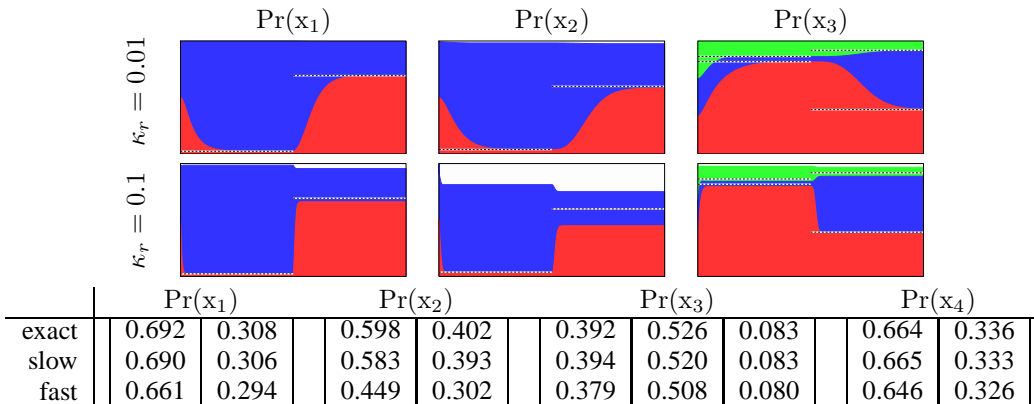

Figure 3: Inference results for factor graph in Figure 2(a). Colored boxes show the trajectories of a belief species set in a simulated reaction network. The simulation time (3000 sec) is along the x -dimension. Half way through the simulation the factor attached to x_1 changes from ψ_1 to ψ'_1 , and the exact marginal distribution for each period is shown as a back-white dashed line. The white area at the top indicates unassigned probability mass. These plots show the clear tradeoff between speed (higher value of κ_r) and accuracy (less unassigned probability mass). The exact numerical answers at 3000 sec are given in the table.

marginal probabilities via the sum-product algorithm. As probability mass is continuously recycled, messages computed on partial information will re-adjust and settle to the correct value. There is a clear dependence of messages. Sum messages from leaf nodes do not depend on any other messages. Once they are computed, i.e. the reactions have equilibrated, the message species continue to catalyze the next set of messages until they have reached the the correct value, etc.

5 Simulation Experiments

This section presents simulation results of factor graphs that have been compiled into reaction networks via the procedure in Section 4. All simulations were performed using the SimBiology Toolbox in Matlab with the 'sundials' solver. The conserved concentration for all sets of belief species were set to 1, so plots of concentrations can be directly interpreted as probabilities. Figure 2 shows the two graphical models for which we present detailed simulation results in the next two sections.

5.1 Tree-Structured Factor Graphs

To demonstrate the functionality and features of the compilation procedure described in Section 4, we compiled the 4 variable factor graph shown in Figure 2a into a reaction network. When x_1, x_2, x_3 and x_4 have discrete states $K_1 = K_2 = K_4 = 2$ and $K_3 = 3$, the resulting network has 64 chemical species and 105 reactions. The largest reaction is of 5th order to compute the marginal distribution of x_2 . We instantiated the factors as shown in Figure 2c and initialized all message and marginal species to be uniform. To show that the network continuously performs inference and can adapt to new information, we changed the factor ψ_1 to ψ'_1 half way through the simulation. In terms of information, the new factor implies that $\Pr(x_1 = 2)$ suddenly more likely. In terms of reactions the change means that $S_0^{(1 \rightarrow 1)}$ is now more likely to turn into $S_2^{(1 \rightarrow 1)}$. In a biological reaction network, such a change could be induced by up-regulating, or activating a catalyst due to a new chemical signal. This new information changes the probability distribution of all the variable in the graph and the network equilibrates to these new values, see Figure 3.

The only two free parameters are κ_{prod} and κ_r . Since only κ_r has a direct effect on all sets of belief species, we fixed $\kappa_{\text{prod}} = 50$ and varied κ_r . Small values of κ_r results in better approximation as less of the probability mass in each belief species set is in an unassigned state. However, small values of κ_r slow the dynamics of the network. Larger values of κ_r result in faster dynamics, but more of the probability mass remains unassigned, top white area in Figure 3. We should note, that at equilibrium, the relative assignments of probabilities are still correct, see Equation 14 and Equation 18.

The compilation procedure also works for factor graphs with larger factors. When replacing the two of the binary factors ψ_5 and ψ_6 in Figure 2a with a new tertiary factor ψ'_5 that is connected to x_2, x_3 ,

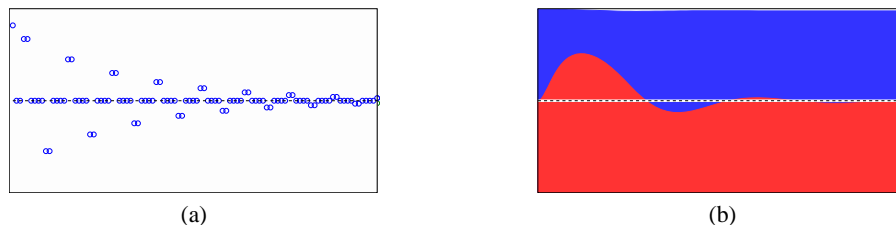

Figure 4: (a) The belief of $\Pr(x_1 = 1)$ as function of iteration in loopy belief propagation. All messages are updated simultaneously at every time step. After 100 iterations the oscillations abate and the belief converges to the correct estimate indicated by the dashed line. (b) Trajectory of PA_i species concentrations. The simulation time is 3000 sec and the different colors indicate the belief of about either of the two states. The dotted line indicates the exact marginal distribution of x_1 .

and x_4 the compiled reaction network has 58 species and 115 reactions. The largest reaction is of order 4. Larger factors can reduce the number of species since there are fewer edges and associated messages to represent, however, the domain sizes \mathbf{K}^j of the individual factors grows exponentially and in the number of neighbors and thus require more reactions to implement.

5.2 Loopy Belief Propagation

These networks can also be used on factor graphs that are not trees. Figure 2b shows a cyclic graph which we compiled to reactions and simulated. When $K_n = 2$ for all variables the resulting reaction network has 54 species and 84 reactions. We chose factor tables that anti-correlate neighbors and leaf factors that prefer the same state.

Figure 4 shows the results of performing both loopy belief propagation and simulation results for the compiled reaction network. Both exhibit decaying oscillations, but settle to the correct marginal distribution. Since the reaction network is essentially performing damped loopy belief propagation with an infinitesimal time step, the reaction network implementation should always converge.

6 Conclusion

We present a compilation procedure for taking arbitrary factor graphs over discrete random variables and construct a reaction network that performs the sum-product message passing algorithm for computing marginal distributions.

These reaction networks exploit the fact that the message structure of the sum-product algorithm maps neatly onto the model of mass action kinetics. By construction, conserved sets of belief species in the network perform implicit and continuous normalization of all messages and marginal distributions. The correct behavior of the network implementation relies on higher order reactions to implement multiplicative operations. However, physically high order reaction are exceedingly unlikely to proceed in a single step. While we can simulate and validate our implementation with respect to the mass action model, a physical implementation will require an additional translation step, e.g. along the lines of [13] with intermediate species of binary reactions.

One aspect that this paper did not address, but we believe is important, is how parameter uncertainty and noise affect the reaction network implementations of inference algorithms. Ideally, they would be robust to parameter uncertainty and random fluctuations. To address the former one could directly compute the parameter sensitivity in this deterministic model. To address the latter, we plan to look at other semantic interpretations of chemical reaction networks, such as the linear noise approximation or the stochastic chemical kinetics model.

In addition to further analyzing this particular algorithm we would like to implement others, e.g. max-product, parameter learning, and dynamic state estimation, as reaction networks. We believe that statistical inference provides the right tools for tackling noise and uncertainty at a microscopic level, and that reaction networks are the right language for specifying systems at that scale.

Acknowledgements

We are grateful to Wyss Institute for Biologically Inspired Engineering at Harvard, especially Prof. Radhika Nagpal, for supporting this research. We would also like to thank our colleagues and reviewers for their helpful feedback.

References

- [1] Subhayu Basu, Yoram Gerchman, Cynthia H. Collins, Frances H. Arnold, and Ron Weiss. A synthetic multicellular system for programmed pattern formation. *Nature*, 434:1130–1134, 2005.
- [2] Christopher M. Bishop. *Pattern Recognition and Machine Learning*. Information Science and Statistics. Springer, 2006.
- [3] Ho-Lin Chen, David Doty, and David Soloveichik. Deterministic function computation with chemical reaction networks. In Darko Stefanovic and Andrew Turberfield, editors, *DNA Computing and Molecular Programming*, volume 7433 of *Lecture Notes in Computer Science*, pages 25–42. Springer Berlin Heidelberg, 2012.
- [4] Tal Danino, Octavio Mondragon-Palomino, Lev Tsimring, and Jeff Hasty. A synchronized quorum of genetic clocks. *Nature*, 463:326–330, 2010.
- [5] Michael B. Elowitz and Stanislas Leibler. A synthetic oscillatory network of transcriptional regulators. *Nature*, 403:335–338, 2000.
- [6] A Hjelmfelt, E D Weinberger, and J Ross. Chemical implementation of neural networks and turing machines. *Proceedings of the National Academy of Sciences*, 88(24):10983–10987, 1991.
- [7] Erik Winfree Jongmin Kim, John J. Hopfield. Neural network computation by in vitro transcriptional circuits. In *Advances in Neural Information Processing Systems 17 (NIPS 2004)*. MIT Press, 2004.
- [8] Chengde Mao, Thomas H. LaBean, John H. Reif, and Nadrian C. Seeman. Logical computation using algorithmic self-assembly of dna triple-crossover molecules. *Nature*, 407:493–496, 2000.
- [9] K. Oishi and E. Klavins. Biomolecular implementation of linear i/o systems. *Systems Biology, IET*, 5(4):252–260, 2011.
- [10] Lulu Qian, Erik Winfree, and Jehoshua Bruck. Neural network computation with dna strand displacement cascades. *Nature*, 475:368–372, 2011.
- [11] Paul W. K Rothmund, Nick Papadakis, and Erik Winfree. Algorithmic self-assembly of dna sierpinski triangles. *PLoS Biol*, 2(12):e424, 12 2004.
- [12] Georg Seelig, David Soloveichik, David Yu Zhang, and Erik Winfree. Enzyme-free nucleic acid logic circuits. *Science*, 314(5805):1585–1588, 2006.
- [13] David Soloveichik, Georg Seelig, and Erik Winfree. Dna as a universal substrate for chemical kinetics. *Proceedings of the National Academy of Sciences*, 107(12):5393–5398, 2010.
- [14] Benjamin Vigoda. *Analog Logic: Continuous-Time Analog Circuits for Statistical Signal Processing*. PhD thesis, Massachusetts Institute of Technology, 2003.
- [15] Jonathan S. Yedidia, W.T. Freeman, and Y. Weiss. Constructing free-energy approximations and generalized belief propagation algorithms. *Information Theory, IEEE Transactions on*, 51(7):2282–2312, 2005.
- [16] David Yu Zhang and Georg Seelig. Dna-based fixed gain amplifiers and linear classifier circuits. In Yasubumi Sakakibara and Yongli Mi, editors, *DNA Computing and Molecular Programming*, volume 6518 of *Lecture Notes in Computer Science*, pages 176–186. Springer Berlin Heidelberg, 2011.