



DIGITAL ACCESS TO SCHOLARSHIP AT HARVARD

Supersymmetric Gauge Theories, Intersecting Branes and Free Fermions

The Harvard community has made this article openly available.
[Please share](#) how this access benefits you. Your story matters.

Citation	Dijkgraaf, Robbert, Lotte Hollands, Piotr Sulkowski, and Cumrun Vafa. 2008. Supersymmetric gauge theories, intersecting branes and free fermions. <i>Journal of High Energy Physics</i> 2008(02): 106.
Published Version	doi:10.1088/1126-6708/2008/02/106
Accessed	February 19, 2015 9:12:34 AM EST
Citable Link	http://nrs.harvard.edu/urn-3:HUL.InstRepos:8152243
Terms of Use	This article was downloaded from Harvard University's DASH repository, and is made available under the terms and conditions applicable to Open Access Policy Articles, as set forth at http://nrs.harvard.edu/urn-3:HUL.InstRepos:dash.current.terms-of-use#OAP

(Article begins on next page)

SUPERSYMMETRIC GAUGE THEORIES, INTERSECTING BRANES AND FREE FERMIONS

Robbert Dijkgraaf^{1,2} Lotte Hollands¹ Piotr Sułkowski^{1,3,4} and Cumrun Vafa⁵

¹*Institute for Theoretical Physics, and* ²*KdV Institute for Mathematics,
University of Amsterdam, Valckenierstraat 65, 1018 XE Amsterdam, The Netherlands*

³*Institute for Theoretical Physics, Warsaw University,
and* ⁴*Soltan Institute for Nuclear Studies,
ul. Hoża 69, PL-00-681 Warsaw, Poland*

⁵*Jefferson Physical Laboratory, Harvard University, Cambridge, MA 02138, USA*

Abstract

We show that various holomorphic quantities in supersymmetric gauge theories can be conveniently computed by configurations of D4-branes and D6-branes. These D-branes intersect along a Riemann surface that is described by a holomorphic curve in a complex surface. The resulting I-brane carries two-dimensional chiral fermions on its world-volume. This system can be mapped directly to the topological string on a large class of non-compact Calabi-Yau manifolds. Inclusion of the string coupling constant corresponds to turning on a constant B -field on the complex surface, which makes this space non-commutative. Including all string loop corrections the free fermion theory is elegantly formulated in terms of holonomic D -modules that replace the classical holomorphic curve in the quantum case.

1 Introduction

Substantial progress has been made in understanding four-dimensional supersymmetric gauge theories in terms of elegant exact solutions. A constant factor in all these solutions has been the relation to two-dimensional geometry and conformal field theory. Many quantities in gauge theory have turned out to be expressible in terms of an effective Riemann surface or complex curve Σ and a particular quantum field theory living on this curve. An ubiquitous role in all this is played by free fermion systems.

Perhaps the first example has been Montonen-Olive S-duality in $\mathcal{N} = 4$ supersymmetric gauge theories [1]. These field theories are invariant under $SL(2, \mathbb{Z})$ transformations of the complexified gauge coupling τ . This includes in particular the strong-weak coupling S-duality $\tau \rightarrow -1/\tau$.

These S-dualities are closely related to the modular invariance of a CFT on a two-torus. Indeed, in certain cases the partition function on a four-manifold M has been shown to exactly reproduce the character of a two-dimensional conformal field theory [2]. This connection was first shown in the beautiful mathematical work of Nakajima, who showed that in the case of ALE singularities there exists an action of an affine Kac-Moody algebra on the cohomology of the instanton moduli space [16]. Many of the CFT's that arise in this fashion are closely related to free fermion systems or equivalently chiral bosons. A well-known example is that of a $K3$ manifold, which gives the partition function of the heterotic string. These relations between four-dimensional and two-dimensional systems are most naturally understood by considering six-dimensional theories on the space $M \times T^2$, a connection that we will make good use of in this paper.

A second example is the celebrated Seiberg-Witten [3] solution of $\mathcal{N} = 2$ gauge theories, which involves a spectral curve Σ of general genus. Many properties of the gauge theory are captured by the geometry of this curve. For example, BPS masses are related to the periods of a particular meromorphic one-form on Σ and the holomorphic gauge coupling matrix $\tau_{IJ}(t)$, that appears in the low-energy $U(1)^N$ abelian gauge theory Lagrangian as

$$\int d^4x \tau_{IJ} F_+^I \wedge F_+^J,$$

can be identified with the period matrix of Σ as a function of the moduli t .

In $\mathcal{N} = 1$ a closely related structure arises because certain holomorphic quantities, such as the superpotential and gauge couplings, can be computed exactly by sums over planar diagrams [4]. The corresponding large N matrix model can be solved in terms of an effective geometry that again in many cases takes the form of a Riemann surface Σ

endowed with a particular meromorphic one-form.

These relations extend beyond classical field theory on Σ . For example, in both $\mathcal{N} = 2$ and $\mathcal{N} = 1$ theories one can compute the effective action that results from coupling the field theory to a four-dimensional curved background metric [5, 6, 7]. In these cases the coefficient \mathcal{F}_1 for the coupling $R_+ \wedge R_+$ takes a particularly nice form: it can be expressed as

$$\mathcal{F}_1(t) = -\frac{1}{2} \log \det \Delta_\Sigma$$

where Δ_Σ is the (chiral) Laplacian on the curve Σ . So, using the boson-fermion correspondence, the gravitational coupling in four dimensions is captured by a quantum field theory of free fermions on Σ .

F-terms in supersymmetric gauge theories are closely related to topological string theories, since these gauge theories can be geometrically engineered by considering specific decoupling limits of type II string compactifications on well-chosen Calabi-Yau manifolds [8, 9, 10]. In many cases the relevant non-compact Calabi-Yau manifold takes the form

$$uv + P(x, y) = 0,$$

where $P(x, y) = 0$ defines the corresponding curve Σ embedded in \mathbb{C}^2 or $\mathbb{C}^* \times \mathbb{C}^*$. In this fashion also a role can be given for the higher loop amplitudes \mathcal{F}_g of the topological string. In [11] it has been shown that also these higher genus terms can be computed using free fermions on Σ , but now the fermions should be given a “quantum character” closely related to a quantization of the coordinates x, y . We will elucidate this phenomenon at the end of this paper using the formalism of \mathcal{D} -modules.

Also Nekrasov has shown that by working equivariantly with respect to the $U(1)$ action on \mathbb{R}^4 , the higher \mathcal{F}_g terms make an appearance in $\mathcal{N} = 2$ theories [12, 13]. From this point of view the corresponding integrable systems are solved naturally by means of free fermions too.

In this paper we shed some new light on the ubiquity of these free fermion systems. Our strategy will be to map the supersymmetric gauge theory to a system of intersecting D-branes. One immediate advantage of this reformulation is that it makes the relation between $\mathcal{N} = 4$ gauge theories on ALE spaces and two-dimensional CFT transparent.

These intersecting branes turn out to also provide a natural setting for understanding the higher genus corrections \mathcal{F}_g in terms of non-commutative geometry. In fact, one of our conclusions will be that in the full quantum theory these fermions should not be considered as local fields, but as sections of a \mathcal{D} -module.

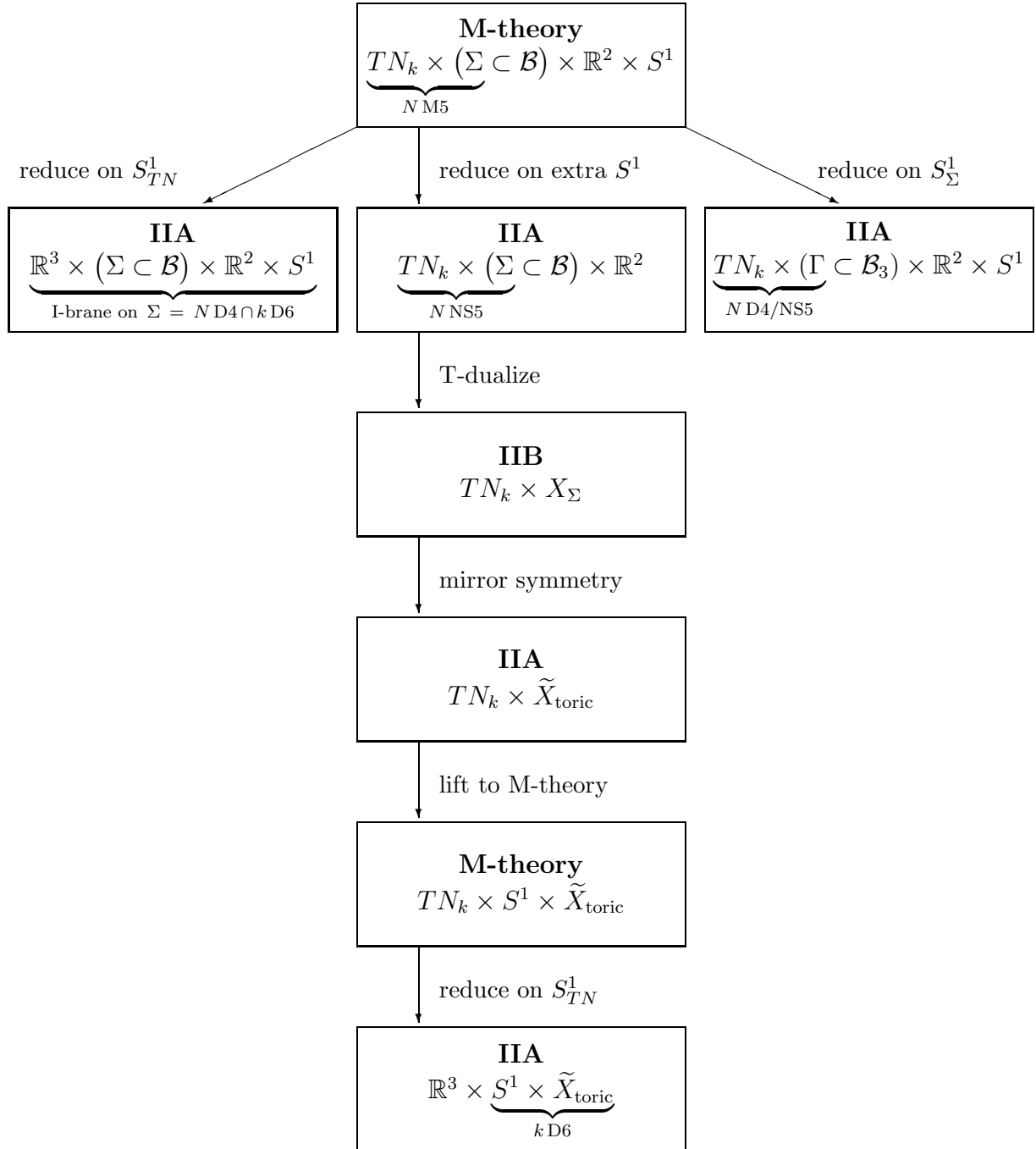

Fig. 1: *Web of dualities considered in the paper.*

Our considerations will be based on a chain of dualities, relating various string and M-theory compactifications with branes and fluxes. For convenience we present these dualities, whose precise details will be explained subsequently, in figure 1.

The plan of this paper is as follows: in section 2 we discuss $\mathcal{N} = 4$ supersymmetric gauge theories on ALE and Taub-NUT manifolds. We show how results of Nakajima are naturally reproduced by mapping the gauge theory, realized via D4-branes in IIA string theory, to an intersecting brane system on a T^2 . A crucial role is played by the level-rank duality. Section 3 generalizes this approach to arbitrary Riemann surfaces. In this way we make contact with $\mathcal{N} = 2$ and $\mathcal{N} = 1$ gauge theories on one hand, and Calabi-Yau compactifications of type II superstrings on the other. Finally, in section 4 we show that higher genus amplitudes of the topological string in these backgrounds can be captured by turning on a B -field, making the geometry non-commutative. The appropriate mathematical formalism to understand the free fermions turns out to be the theory of \mathcal{D} -modules. We illustrate this formalism of a conformal field theory of \mathcal{D} -modules with some concrete examples in (space-time) genus 0, 1, and 2.

2 $\mathcal{N} = 4$ theories on ALE spaces

Let us start by considering a $U(N)$ $\mathcal{N} = 4$ supersymmetric gauge theory on a, possibly non-compact, four-manifold M . We will take M to be a hyper-Kähler manifold. In this case the ordinary $\mathcal{N} = 4$ supersymmetric gauge theory is equivalent to a topologically twisted one (as some supercharges are preserved on hyper-Kähler manifolds). Including the topological couplings θ and $v \in H^2(M, \mathbb{Z})$, the action is given by

$$S = - \int \frac{i}{4\pi} \tau \operatorname{Tr}(F_+ \wedge F_+) + v \wedge \operatorname{Tr} F_+ + c.c.,$$

where the complexified gauge coupling τ is given by

$$\tau = \frac{\theta}{2\pi} + \frac{4\pi i}{g^2}. \quad (2.1)$$

Here complex conjugation not only changes τ and v into their anti-holomorphic conjugates, but also maps the self-dual part F_+ of the field strength to the anti-self-dual part F_- . In the topologically twisted theory only instantons contribute¹ and the partition function of the $U(N)$ gauge theory becomes a holomorphic function of the coupling τ (up to possible holomorphic anomalies). The v -dependence is entirely captured by the $U(1)$ factor and is in general given in terms of Siegel theta-functions of signature (b_+^2, b_-^2)

$$\sum_{p \in H^2(M, \mathbb{Z})} e^{i\pi(\tau p_+^2 - \bar{\tau} p_-^2)} e^{2\pi i(v \cdot p_+ - \bar{v} \cdot p_-)}.$$

¹In our choice of twisting (and conventions) these are given by self-dual solutions with $F_- = 0$.

Here p and v are elements of $H^2(M, \mathbb{Z})$, so that $v \cdot p$ (and likewise p^2) refers to the intersection product $\int_M v \wedge p$. Clearly this contribution only becomes holomorphic in the case that $b_-^2 = 0$.

Because of S-duality the partition function $Z(v, \tau)$ of this gauge theory is expected to be given by a Jacobi form determined by the geometry M [2]. That is, it should have the following transformation properties:

$$Z\left(\frac{v}{c\tau + d}, \frac{a\tau + b}{c\tau + d}\right) = (c\tau + d)^w e^{2\pi i \kappa c v^2 / (c\tau + d)} Z(v, \tau), \quad \begin{bmatrix} a & b \\ c & d \end{bmatrix} \in SL(2, \mathbb{Z}).$$

$$Z(v + n\tau + m, \tau) = e^{-2\pi i \kappa (n^2 \tau + 2n \cdot v)} Z(v, \tau), \quad n, m \in H^2(M, \mathbb{Z}) \cong \mathbb{Z}^{b_2}.$$

The weight of the Jacobi-form $w = -\chi(M)$ is given by minus the (regularized) Euler number of M and its index is $\kappa = N$.

Using the localization to instantons, the partition function has a Fourier expansion of the form

$$Z(v, \tau) = \sum_{m \in H^2(M), n \geq 0} d(m, n) y^m q^{n-c/24},$$

where $y = e^{2\pi i v}$, $q = e^{2\pi i \tau}$ and $c = N\chi(M)$. The coefficients $d(n, m)$ are roughly computed as the Euler number of the moduli space of $U(N)$ instantons on M with total instanton numbers $c_1 = m$ and $ch_2 = n$.

In general the coefficients $d(m, n)$ are believed to be integers, because they have a direct interpretation as computing BPS invariants in a five-dimensional gauge theory. If we consider a D4-brane wrapping the five-manifold $M \times S^1$, then we can compute $d(m, n)$ as the index²

$$d(m, n) = \text{Tr}(-1)^F \in \mathbb{Z},$$

in the subsector of field configurations on M of given instanton numbers m, n . Here we interpret the S^1 as Euclidean time.

From the string theory point of view the modular invariance of Z is explained naturally by lifting the D4-brane to M-theory, where it becomes an M5-brane on the product manifold

$$M \times T^2.$$

The world-volume theory of the M5-brane is (in the low-energy limit) the rather mysterious six-dimensional $U(N)$ conformal field theory with $(0, 2)$ supersymmetry. The

²Here and in the subsequent sections we assume that the two fermion zero modes associated to the center of mass movements of the D4-brane have been absorbed.

complexified gauge coupling τ can now be interpreted as the modulus of the elliptic curve T^2 , while the Wilson loops of the 3-form potential C_3 along this curve are related to the couplings v , as we explain in more detail in section 2.4. With this interpretation the action of modular group $SL(2, \mathbb{Z})$ on v and τ is the obvious geometric one.

2.1 Gauge theory on ALE spaces

We now want to turn to a very concrete case, where we take M to be a non-compact ALE space. Such a manifold can be written as the (possibly resolved) orbifold

$$M_\Gamma \rightarrow \mathbb{C}^2/\Gamma,$$

with Γ a finite subgroup of $SU(2)$. These Kleinian singularities have an ADE classification. For the A_{k-1} singularity, that we will mostly restrict to in this paper, Γ is given by the cyclic group \mathbb{Z}_k .

We do however have to address the fact that the four-manifold M_Γ is non-compact, so that we have to fix boundary conditions for the gauge field. The boundary at infinity is given by the Lens space S^3/Γ and here the $U(N)$ gauge field should approach a flat connection. Up to gauge equivalence this flat connection is labeled by an N -dimensional representation of the quotient group Γ , that is, an element

$$\rho \in \text{Hom}(\Gamma, U(N)).$$

If ρ_i label the irreducible representations of Γ , then ρ can be decomposed as

$$\rho = \bigoplus_i N_i \rho_i,$$

where the multiplicities N_i are non-negative integers satisfying the restriction

$$\sum_i N_i d_i = N, \quad d_i = \dim \rho_i.$$

Now the famous McKay correspondence [14, 15]

$$\Gamma \leftrightarrow \widehat{\mathfrak{g}},$$

relates the finite subgroups $\Gamma \subset SU(2)$ with corresponding simple Lie algebras \mathfrak{g} of ADE type, or more properly their affine extensions $\widehat{\mathfrak{g}}$. We will denote the compact Lie group corresponding to the Lie algebra \mathfrak{g} as G . In the McKay correspondence the irreducible representations ρ_i of the finite group Γ are related to the nodes of the extended Dynkin

diagram of the affine algebra $\widehat{\mathfrak{g}}$. The dimensions d_i of these irreps can then be identified with the dual Dynkin indices.

Through the McKay correspondence each N -dimensional representation ρ of Γ determines an integrable highest-weight representation of $\widehat{\mathfrak{g}}_N$ at level N . We will denote this (infinite-dimensional) Lie algebra representation as V_ρ . In particular for $\Gamma = \mathbb{Z}_k$, which is the case that we will mostly concentrate on, flat connections on S^3/\mathbb{Z}_k thus get identified with integrable representations of $\widehat{su}(k)_N$. In this particular case all Dynkin indices satisfy $d_i = 1$.

With ρ labeling the boundary conditions of the gauge field at infinity, we will get a vector-valued partition function $Z_\rho(v, \tau)$. Formally the $U(N)$ gauge theory partition function on the ALE manifold again has an expansion

$$Z_\rho(v, \tau) = \sum_{n,m} d(m, n) y^m q^{h_\rho + n - c/24},$$

where $c = Nk$ with k the regularized Euler number of the A_{k-1} manifold [2]. The usual instanton numbers given by the second Chern class $n = ch_2$ in the exponent are now shifted by a rational number h_ρ , which is related to the Chern-Simons invariant of the flat connection ρ . As we explain in section 2.6, h_ρ gets mapped to the conformal dimension of the corresponding integrable weight in the affine Lie algebra $\widehat{\mathfrak{g}}$ related to Γ by the McKay correspondence. S-duality will act non-trivially on the boundary conditions ρ , and therefore $Z_\rho(v, \tau)$ will be a vector-valued Jacobi form [2].

For these ALE spaces the instanton computations can be explicitly performed, because there exists a generalized ADHM construction in which the instanton moduli space is represented as a quiver variety. The physical intuition underlying this formalism has been justified by the beautiful mathematical work of Nakajima [16, 17], who has proven that on the middle dimensional cohomology of the instanton moduli space one can actually realize the action of the affine Kac-Moody algebra $\widehat{\mathfrak{g}}_N$ in terms of geometric operations. In fact, this work leads to the identification

$$Z_\rho(v, \tau) = \text{Tr}_{V_\rho} (y^{J_0} q^{L_0 - c/24}) = \chi_\rho(v, \tau),$$

with V_ρ the integrable highest-weight representation of $\widehat{\mathfrak{g}}_N$ and χ_ρ its affine character. Here c is the appropriate central charge of the corresponding WZW model. A remarkable fact is that, in the case of a $U(N)$ gauge theory on a \mathbb{Z}_k singularity, we find an action of $\widehat{su}(k)_N$ and not of the gauge group $SU(N)$. This is an important example of the familiar level-rank duality of affine Lie algebras.

Now, interestingly, Frenkel has suggested [18] that, if one works equivariantly for the action of the gauge group $SU(N)$ at infinity (we ignore the $U(1)$ part for the moment), there would similarly be an action of the $\widehat{su}(N)_k$ affine Lie algebra. Physically this means “ ungauging ” the $SU(N)$ at infinity. In other words, we consider making the $SU(N)$ into a global symmetry instead of a gauge symmetry at the boundary. This suggestion has recently been confirmed in [19]. So, depending on how we deal with the theory at infinity, there are reasons to expect both affine symmetry structures to appear and have a combined action of the Lie algebra

$$\widehat{su}(N)_K \times \widehat{su}(k)_N.$$

We will now turn to a dual string theory realization, where this structure indeed becomes transparent.

2.2 The Taub-NUT geometry

In order to study this gauge system within string theory, we use a trick that proved to be very effectively in relating 4d and 5d black holes [20, 21, 22, 23, 24] and is in line with the duality between ALE spaces and 5-brane geometries [25]. We will replace the local A_{k-1} singularity with a Taub-NUT geometry. This can be best understood as a S^1 compactification of the singularity. The TN_k geometry is a hyper-Kähler manifold with metric [26, 27],

$$ds_{TN}^2 = R^2 \left[\frac{1}{V} (d\chi + \alpha)^2 + V d\vec{x}^2 \right],$$

with $\chi \in S^1$ (with period 4π) and $\vec{x} \in \mathbb{R}^3$. Here the function V and 1-form α are determined as

$$V(\vec{x}) = 1 + \sum_{a=1}^k \frac{1}{|\vec{x} - \vec{x}_a|}, \quad d\alpha = *_3 dV.$$

The Taub-NUT manifold can be thought as a (singular) circle fibration

$$\begin{array}{ccc} S^1 & \rightarrow & TN_k \\ & & \downarrow \\ & & \mathbb{R}^3 \end{array}$$

where the size of the S^1 shrinks at the points $\vec{x}_1, \dots, \vec{x}_k \in \mathbb{R}^3$. These positions are the hyperkähler moduli of the space. The total manifold is however perfectly smooth. At infinity it approximates the cylinder $\mathbb{R}^3 \times S^1$ where the S^1 has fixed radius R , but is

non-trivially fibered over the S^2 at infinity as a monopole bundle of charge (first Chern class) k

$$\int_{S^2} d\alpha = 2\pi k.$$

In the core, where we can ignore the constant 1 that appears in the expression for the potential $V(\vec{x})$, the Taub-NUT geometry can be approximated by the (resolved) A_{k-1} singularity.

The manifold TN_k has non-trivial 2-cycles $C_{a,b} \cong S^2$ that are fibered over the line segments joining the locations \vec{x}_a and \vec{x}_b in \mathbb{R}^3 . Only $k-1$ of these cycles are homologically independent. As a basis we can pick the cycles

$$C_a := C_{a,a+1}, \quad a = 1, \dots, k-1.$$

The intersection matrix of these 2-cycles gives the Cartan matrix of A_{k-1} .

From a dual perspective, there are k independent normalizable harmonic 2-forms ω_a on TN_k , that can be chosen to be localized around the centers or NUTs \vec{x}_a . With

$$V_a = \frac{1}{|\vec{x} - \vec{x}_a|}, \quad d\alpha_a = *dV_a,$$

they are given as

$$\omega_a = d\eta_a, \quad \eta_a = \alpha_a - \frac{V_a}{V}(d\chi + \alpha).$$

Furthermore, these 2-forms satisfy

$$\int_{TN} \omega_a \wedge \omega_b = 16\pi^2 \delta_{ab},$$

and are dual to the cycles $C_{a,b}$

$$\int_{C_{a,b}} \omega_c = 4\pi(\delta_{ac} - \delta_{bc}).$$

A special role is played by the sum of these harmonic 2-forms

$$\omega = \sum_a \omega_a. \tag{2.2}$$

This is the unique normalizable harmonic 2-form that is invariant under the tri-holomorphic $U(1)$ isometry of TN . The form ω has zero pairings with all the cycles C_{ab} . In the “decompactification limit”, where TN_k gets replaced by A_{k-1} , the linear combination ω becomes non-normalizable, while the $k-1$ two-forms orthogonal to it survive.

We will make convenient use of the following elegant interpretation of the two-form ω . Consider the $U(1)$ action on the TN_k manifold that rotates the S^1 fiber. It is generated by a Killing vector field ξ . Let η be the corresponding dual one-form given as $\eta_\mu = g_{\mu\nu}\xi^\nu$, where we used the TN -metric to convert the vector field to a one-form. Up to an overall rescaling this gives

$$\eta = \frac{1}{V}(d\chi + \alpha). \quad (2.3)$$

In terms of this one-form, ω is given by $\omega = d\eta$.

2.3 String theory realization

Our strategy in this paper will be that, since we consider the twisted partition function of the topological field theory, the answer will be formally independent of the radius R of the Taub-NUT geometry. So we can take both the limit $R \rightarrow \infty$, where we recover the result for the ALE space $\mathbb{C}^2/\mathbb{Z}_k$, and the limit $R \rightarrow 0$, where the problem becomes essentially three-dimensional.

Now, there are some subtleties with this argument, since a priori the partition function of the gauge theory on the TN manifold is *not* identical to that of the ALE space. In particular there are new topological configurations of the gauge field that can contribute. These can be thought of as monopoles going around the S^1 at infinity. We will come back to this subtle point later.

In type IIA string theory, the partition function of the $\mathcal{N} = 4$ SYM theory on the TN_k manifold can be obtained by considering a compactification of the form

$$(IIA) \quad TN \times S^1 \times \mathbb{R}^5,$$

and wrapping N D4-branes on $TN \times S^1$. This is a special case of the situation presented in the box on the right-hand side in fig. 1, with $\Gamma = S^1$, $\mathcal{B}_3 = S^1 \times \mathbb{R}^2$, and S^1 decompactified. In the decoupling limit the partition function of this set of D-branes will reproduce the Vafa-Witten partition function on TN_k . This partition function can be also written as an index

$$Z(v, \tau) = \text{Tr} \left((-1)^F e^{-\beta H} e^{in\theta} e^{2\pi imv} \right)$$

where $\beta = 2\pi R_9$ is the circumference of the “9th dimension” S^1 , and $m = c_1$, $n = ch_2$ are the Chern characters of the gauge bundle on the TN_k space. Here we can think of the theta angle θ as the Wilson loop for the graviphoton field C_1 along the S^1 . Similarly v is the Wilson loop for C_3 . The gauge coupling of the 4d gauge theory is now identified as

$$\frac{1}{g^2} = \frac{\beta}{g_s \ell_s}.$$

Because only BPS configurations contribute in this index, again only the holomorphic combination τ (2.1) will appear.

We can now further lift this configuration to M-theory with an additional S^1 of size $R_{11} = g_s l_s$, where we obtain the compactification

$$(M) \quad TN \times T^2 \times \mathbb{R}^5,$$

now with N M5-branes wrapping the six-manifold $TN_k \times T^2$. This corresponds to the top box in fig. 1, with $\Sigma = T^2$. As we remarked earlier, after this lift the coupling constant τ is interpreted as the geometric modulus of the elliptic curve T^2 . In particular its imaginary part is given by the ratio R_9/R_{11} . Dimensionally reducing the six-dimensional $U(N)$ theory on the M5-brane world-volume over the Taub-NUT space gives a two-dimensional $(0, 8)$ superconformal field theory, in which the gauge theory partition function is computed as the elliptic genus

$$Z = \text{Tr} \left((-1)^F y^{J_0} q^{L_0 - c/24} \right).$$

In order to further analyze this system we switch to yet another duality frame by compactifying back to Type IIA theory, but now along the S^1 fiber in the Taub-NUT geometry. This is the familiar 9-11 exchange. In this fashion we end up with a IIA compactification on

$$(IIA) \quad \mathbb{R}^3 \times T^2 \times \mathbb{R}^5,$$

with N D4-branes wrapping $\mathbb{R}^3 \times T^2$. However, because the circle fibration of the TN space has singular points, we have to include D6-branes as well. In fact, there will be k D6-branes that wrap $T^2 \times \mathbb{R}^5$ and are localized at the points $\vec{x}_1, \dots, \vec{x}_k$ in the \mathbb{R}^3 . This situation is represented in the box on the left-hand side in fig. 1.

Summarizing, we get a system of N D4-branes and k D6-branes intersecting along the T^2 . This intersection locus is called the I-brane and it is depicted in fig. 2. We will now study this I-brane system in greater detail.

2.4 The D4-D6 system and free fermions

A collection of D4-branes and D6-branes that intersect along two (flat) dimensions is a supersymmetric configuration. One way to see this is that after some T-dualities, it can be related to a D0-D8 or D1-D9 system. The supersymmetry in this case is of type $(0, 8)$. The massless modes of the 4-6 open strings stretching between the D4 and D6 branes reside entirely in the Ramond sector. All modes in the NS sector are massive.

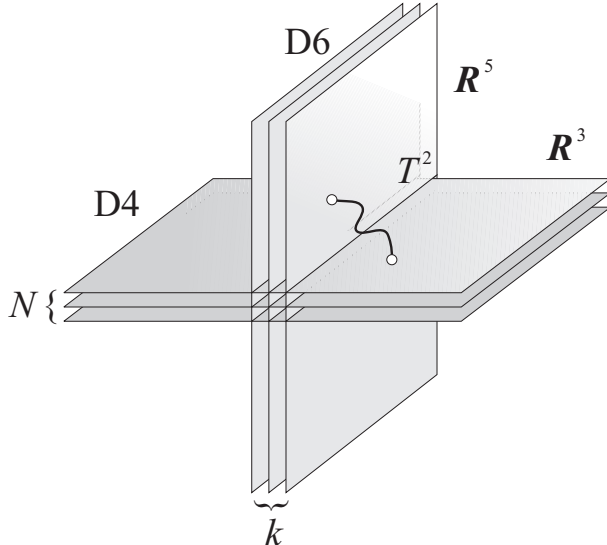

Fig. 2: Configuration of intersecting $D4$ and $D6$ -branes with one of the 4-6 open strings that gives rise to a chiral fermion localized on the I-brane.

These massless modes are well-known to be chiral fermions on the two-dimensional I-brane [28, 29, 30]. If we have N D4-branes and k D6-branes, the chiral fermions

$$\psi_{i,\bar{a}}(z), \psi_{\bar{i},a}^\dagger(z), \quad i = 1, \dots, N, \quad a = 1, \dots, k$$

transform in the bifundamental representations (N, \bar{k}) and (\bar{N}, k) of $U(N) \times U(k)$. Since we are computing an index, we can take the $\alpha' \rightarrow 0$ limit, in which all massive modes decouple. In this limit we are just left with the chiral fermions. Their action is necessarily free and given by

$$I = \int d^2z \psi^\dagger \bar{\partial}_{A+\tilde{A}} \psi,$$

where A and \tilde{A} are the restrictions to the I-brane T^2 of the $U(N)$ and $U(k)$ gauge fields, that live on the worldvolumes of the D4-branes and the D6-branes respectively. (Here we have absorbed the overall coupling constant).

Under the two $U(1)$'s the fermions have charge $(+1, -1)$. Therefore the overall (diagonal) $U(1)$ decouples and the fermions effectively couple to the gauge group

$$U(1) \times SU(N) \times SU(k),$$

where the remaining $U(1)$ is the anti-diagonal. At this point we ignore certain discrete identifications under the \mathbb{Z}_N and \mathbb{Z}_k centers, that we will return to later.

Zero modes

A special role is played by the zero-modes of the D-brane gauge fields. In the supersymmetric configuration we can have both a non-trivial flat $U(N)$ and $U(k)$ gauge field turned on along the T^2 . We will denote these moduli as u_i and v_a respectively. The partition function of the chiral fermions on the I-brane will be a function $Z(u, v, \tau)$ of both the flat connections u, v and the modulus τ . It will transform as a (generalized) Jacobi-form under the action of $SL(2, \mathbb{Z})$ on the two-torus.

The couplings u and v have straightforward identifications in the $\mathcal{N} = 4$ gauge theory on the TN space. First of all, the parameters u_i are Wilson loops along the circle of the $D4$ compactified on $TN \times S^1$, and so in the four-dimensional theory they just describe the values of the scalar fields on the Higgs moduli space. That is, they parametrize the positions u_i of the N $D4$ -branes along the S^1 . Clearly, we are not interested in describing these kind of configurations where the gauge group $U(N)$ gets broken to $U(1)^N$ (or some intermediate case). Therefore we will in general put $u = 0$.

The parameters v_a are the Wilson lines on the $D6$ -branes and are directly related to fluxes along the non-trivial two-cycles of TN_k and (in the limiting case) on the A_{k-1} geometry. To see this, let us briefly review how the world-volume fields of the $D6$ -branes are related to the TN geometry in the M-theory compactification.

First of all, the positions of the NUTs \vec{x}_a of the TN manifold are given by the vev's of the three scalar Higgs fields of the 6+1 dimensional gauge theory on the $D6$ -brane. In a similar fashion the $U(1)$ gauge fields \tilde{A}_a on the $D6$ -branes are obtained from the 3-form C_3 field in M-theory. More precisely, if ω_a are the k harmonic two-forms on TN_k introduced in section 2.2, we have a decomposition

$$C_3 = \sum_a \omega_a \wedge \tilde{A}_a. \quad (2.4)$$

We recall that the forms ω_a are localized around the centers \vec{x}_a of the TN geometry (the fixed points of the circle action). So in this fashion the bulk C_3 field gets replaced by k $U(1)$ brane fields \tilde{A}_a . This relation also holds for a single $D6$ -brane, because the two-form ω is normalizable in the TN_1 geometry. Relation (2.4) holds in particular for a flat connection, in which case we get the M-theory background

$$C_3 = \sum_a v_a \omega_a \wedge dz + c.c.$$

Reducing this 3-form down to the type IIA configuration on $TN \times S^1$ gives a mixture of NS B fields and RR C_3 fields on the Taub-NUT geometry. Finally, in the $\mathcal{N} = 4$ gauge

theory this translates (for an instanton background) into a topological coupling

$$\int v \wedge \text{Tr} F_+ + \bar{v} \wedge \text{Tr} F_-,$$

with v the harmonic two-form

$$v = \sum_a v_a \omega_a.$$

The existence of this coupling can also be seen by recalling that the M5-brane action contains the term $\int H \wedge C_3$. On the manifold $M \times T^2$ the tensor field strength H reduces as $H = F_+ \wedge d\bar{z} + F_- \wedge dz$ and similarly one has $C_3 = v \wedge dz + \bar{v} \wedge d\bar{z}$, which gives the above result. If one thinks of the gauge theory in terms of a D3-brane, the couplings v, \bar{v} are the fluxes of the complexified 2-form combination $B_{RR} + \tau B_{NS}$.

Chiral anomaly

We should address another point: the chiral fermions on the I-brane are obviously anomalous. Under a gauge transformation of, say, the $U(N)$ gauge field

$$\delta A = D\xi,$$

the effective action of the fermions transforms as

$$k \int_{T^2} \text{Tr}(\xi F_A).$$

A similar story holds for the $U(k)$ gauge symmetry. Nonetheless, the overall theory including both the chiral fermions on the I-brane and the gauge fields in the bulk of the D-branes is consistent, due to the coupling between both systems. The consistency is ensured by Chern-Simons terms in the D-brane actions, which cancel the anomaly through the process of anomaly inflow [28, 31]. For example, on the D4-brane there is a term coupling to the RR 2-form (graviphoton) field strength G_2 :

$$I_{CS} = \frac{1}{2\pi} \int_{T^2 \times \mathbb{R}^3} G_2 \wedge CS(A), \tag{2.5}$$

with Chern-Simons term

$$CS(A) = \text{Tr} \left(A dA + \frac{2}{3} A \wedge A \wedge A \right).$$

Because of the presence of the D6-branes, the 2-form G_2 is no longer closed, but satisfies instead

$$dG_2 = 2\pi k \cdot \delta_{T^2}.$$

Therefore under a gauge transformation $\delta A = D\xi$ the D4-brane action gives the required compensating term

$$\delta I_{CS} = \frac{1}{2\pi} \int G_2 \wedge d \text{Tr}(\xi F_A) = -k \int_{T^2} \text{Tr}(\xi F_A),$$

which makes the whole system gauge invariant.

2.5 Conformal embeddings and level-rank duality

The system of intersecting branes gives an elegant realization of the level-rank duality

$$\widehat{su}(N)_k \leftrightarrow \widehat{su}(k)_N$$

that is well-known in CFT and 3d topological field theory. The analysis has been conducted in [31] for a system of D5-D5 branes, which is of course T-dual to the D4-D6 system that we consider in this paper. Hence we can follow this analysis to a large extent.

The system of Nk free fermions has central charge $c = Nk$ and gives a realization of the $\widehat{u}(Nk)_1$ affine symmetry at level one. In terms of affine Kac-Moody Lie groups we have the embedding

$$\widehat{u}(1)_{Nk} \times \widehat{su}(N)_k \times \widehat{su}(k)_N \subset \widehat{u}(Nk)_1. \quad (2.6)$$

This is a conformal embedding, in the sense that the central charges of the WZW models on both sides are equal. Indeed, using that the central charge of $\widehat{su}(N)_k$ is

$$c_{N,k} = \frac{k(N^2 - 1)}{k + N},$$

it is easily checked that

$$1 + c_{N,k} + c_{k,N} = Nk.$$

The generators for these commuting subalgebras are bilinears constructed out of the fermions $\psi_{i,a}$ and their conjugates $\psi_{i,a}^\dagger$. In terms of these fields one can define the currents of the $\widehat{u}(N)_k$ and $\widehat{u}(k)_N$ subalgebras as respectively

$$J_{j\bar{k}}(z) = \sum_a \psi_j^a \psi_{\bar{k}a}^\dagger,$$

and

$$J_{\bar{a}b}(z) = \sum_j \psi_{j,\bar{a}} \psi_b^{\dagger j}.$$

Now it is exactly the conformal embedding (2.6) that gives the most elegant explanation of level-rank duality. This correspondence should be considered as the affine version

of the well-known Schur-Weyl duality for finite-dimensional Lie groups. Let us recall that the latter is obtained by considering the (commuting) actions of the unitary group and symmetric group

$$U(N) \times S_k \subset U(Nk)$$

on the vector space \mathbb{C}^{Nk} , regarded as the k -th tensor product of the fundamental representation \mathbb{C}^N . Schur-Weyl duality is the statement that the corresponding group algebras are maximally commuting in $\text{End}((\mathbb{C}^N)^{\otimes k})$, in the sense that the two algebras are each other's commutants. Under these actions one obtains the decomposition

$$\mathbb{C}^{Nk} = \bigotimes_{\rho} V_{\rho} \otimes \tilde{V}_{\rho},$$

with V_{ρ} and \tilde{V}_{ρ} irreducible representations of $u(N)$ and S_k respectively. Here ρ runs over all partitions of k with at most N parts. This duality gives the famous pairing between the representation theory of the unitary group and the symmetric group.

In the affine case we have a similar situation, where we now take the k 'th tensor product of the N free fermion Fock spaces, viewed as the fundamental representation of $\widehat{u}(N)_1$. The symmetric group S_k gets replaced by $\widehat{u}(k)_N$ (which reminds one of constructions in D-branes and matrix string theory, where the symmetry group appears as the Weyl group of a non-Abelian symmetry). The affine Lie algebras

$$\widehat{u}(1)_{Nk} \times \widehat{su}(N)_k \times \widehat{su}(k)_N$$

again have the property that they form maximally commuting subalgebras within $\widehat{u}(Nk)_1$. The total Fock space $\mathcal{F}^{\otimes Nk}$ of Nk free fermions now decomposes under the embedding (2.6) as

$$\mathcal{F}^{\otimes Nk} = \bigoplus_{\rho} U_{\|\rho\|} \otimes V_{\rho} \otimes \tilde{V}_{\tilde{\rho}}. \quad (2.7)$$

Here $U_{\|\rho\|}$, V_{ρ} and $\tilde{V}_{\tilde{\rho}}$ denote irreducible integrable representations of $\widehat{u}(1)_{Nk}$, $\widehat{su}(k)_N$, and $\widehat{su}(N)_k$ respectively.

The precise formula for the decomposition (2.7) is a bit complicated, in particular due to the role of the overall $U(1)$ symmetry, and is given in detail in appendix A. But roughly it can be understood as follows: the irreducible representations of $\widehat{u}(N)_k$ are given by Young diagrams that fit into a box of size $N \times k$. Similarly, the representations of $\widehat{u}(k)_N$ fit in a reflected box of size $k \times N$. In this fashion level-rank duality relates a representation V_{ρ} of $\widehat{u}(N)_k$ to the representation $\tilde{V}_{\tilde{\rho}}$ of $\widehat{u}(k)_N$ labeled by the transposed

Young diagram. If we factor out the $\widehat{u}(1)_{Nk}$ action, we get a representation of charge $\|\rho\|$, which is related to the total number of boxes $|\rho|$ in ρ (or equivalently $\widetilde{\rho}$).

At the level of the partition function we have a similar decomposition into characters. To write this in more generality it is useful to add the Cartan generators. That is, we consider the characters for $\widehat{u}(N)_k$ that are given by

$$\chi_{\rho}^{\widehat{u}(N)_k}(u, \tau) = \text{Tr}_{V_{\rho}} \left(e^{2\pi i u_j J_0^j} q^{L_0 - c_{N,k}/24} \right),$$

and similarly for $\widehat{u}(k)_N$ we have

$$\chi_{\widetilde{\rho}}^{\widehat{u}(k)_N}(v, \tau) = \text{Tr}_{\widetilde{V}_{\widetilde{\rho}}} \left(e^{2\pi i v_a J_0^a} q^{L_0 - c_{k,N}/24} \right).$$

Here the diagonal currents

$$J_0^j = \oint \frac{dz}{2\pi i} J_{jj}(z), \quad J_0^a = \oint \frac{dz}{2\pi i} J_{aa}(z)$$

generate the Cartan tori $U(1)^N \subset U(N)$ and $U(1)^k \subset U(k)$.

Including the Wilson lines u and v for the $U(N)$ and $U(k)$ gauge fields, the partition function of the I-brane system is given by the character of the fermion Fock space

$$\begin{aligned} Z_I(u, v, \tau) &= \text{Tr}_{\mathcal{F}} \left(e^{2\pi i (u_j J_0^j + v_a J_0^a)} q^{L_0 - \frac{Nk}{24}} \right) \\ &= q^{-\frac{Nk}{24}} \prod_{\substack{j=1, \dots, N \\ a=1, \dots, k}} \prod_{n \geq 0} \left(1 + e^{2\pi i (u_j + v_a)} q^{n+1/2} \right) \left(1 + e^{-2\pi i (u_j + v_a)} q^{n+1/2} \right). \end{aligned} \quad (2.8)$$

Writing the decomposition (2.7) in terms of characters gives

$$Z_I(u, v, \tau) = \sum_{[\rho] \subset \mathcal{Y}_{N-1,k}} \sum_{j=0}^{N-1} \sum_{a=0}^{k-1} \chi_{|\rho|+jk+aN}^{\widehat{u}(1)_{Nk}}(N|u| + k|v|, \tau) \chi_{\sigma_N^j(\rho)}^{\widehat{su}(N)_k}(\bar{u}, \tau) \chi_{\sigma_k^a(\widetilde{\rho})}^{\widehat{su}(k)_N}(\bar{v}, \tau),$$

where the Young diagrams $\rho \in \mathcal{Y}_{N-1,k}$ of size $(N-1) \times k$ represent $\widehat{su}(N)_k$ integrable representations and σ denote generators of the outer automorphism groups \mathbb{Z}_N and \mathbb{Z}_k that connect the centers of $SU(N)$ and $SU(k)$ to the $U(1)$ factor (see again the appendix for notation and more details).

2.6 Deriving the McKay-Nakajima correspondence

In the intersecting D-brane configuration both the D4-branes and the D6-branes are non-compact. So, we can choose both the $U(N)$ and $U(k)$ gauge groups to be non-dynamical and freeze the background gauge fields A and \widetilde{A} . In fact, this set-up is entirely symmetric between the two gauge systems, which makes level-rank duality transparent.

However, in order to make contact with the $\mathcal{N} = 4$ gauge theory computation, we will have to break this symmetry. Clearly, we want the $U(N)$ gauge field to be dynamical — our starting point was to compute the partition function of the $U(N)$ Yang-Mills theory. The $U(k)$ symmetry should however *not* be dynamical, since we want to freeze the geometry of the Taub-NUT manifold. So, to derive the gauge theory result, we will have to integrate out the $U(N)$ gauge field A on the I-brane. Particular attention has to be paid to the $U(1)$ factor in the CFT on the I-brane. We will argue that in this string theory set-up we should not take that to be dynamical.

Therefore we are dealing with a partially gauged CFT or coset theory

$$\widehat{u}(Nk)_1 / \widehat{su}(N)_k.$$

In particular the $\widehat{su}(N)_k$ WZW model will be replaced by the corresponding G/G model. Gauging the model will reduce the characters. (Note that this only makes sense if the Coulomb parameters u are set to zero. If not, we can only gauge the residual gauge symmetry, which leads to fractionalization and a product structure.) In the gauged WZW model, which is a topological field theory, only the ground state remains in each irreducible integrable representation. So we have a reduction

$$\chi_\rho^{\widehat{su}(N)_k}(\bar{u}, \tau) \rightarrow q^{h_\rho - c/24},$$

with h_ρ the conformal dimension of the ground state representation ρ . Note that the choice of ρ corresponds exactly to the boundary condition for the gauge theory on the A_{k-1} manifold. We will explain this fact, that is crucial to the McKay correspondence, in a moment.

Gauging the full I-brane theory and restricting to the sector ρ finally gives

$$Z_I(u, v, \tau) \rightarrow Z_\rho^{N,k}(v, \tau) = q^{h_\rho - c/24} \sum_{a=0}^{k-1} \chi_{|\rho|+aN}^{\widehat{u}(1)_{Nk}}(k|v|, \tau) \chi_{\sigma_k^a(\bar{\rho})}^{\widehat{su}(k)_N}(\bar{v}, \tau).$$

Up to the $\chi^{\widehat{u}(1)_{Nk}}$ factor, this reproduces the results presented in [2, 16] for ALE spaces, which involve just $\widehat{su}(k)_N$ characters. This extra factor is due to additional monopoles mentioned in section 2.3. They are related to the finite radius S^1 at infinity of the Taub-NUT space and are absent in case of ALE geometries.

In fact, the extra $U(1)$ factor can already be seen at the classical level, because the extra normalizable harmonic two-form ω in (2.2) disappears in the decompactification limit where TN_k degenerates into A_{k-1} . The lattice $H^2(TN_k, \mathbb{Z})$ is isomorphic to \mathbb{Z}^k with

the standard inner product and contains the root lattice A_{k-1} as a sublattice given by $\sum_I n_I = 0$. Note also that the lattice \mathbb{Z}^k is not even, which explains why the I-brane partition function has a fermionic character and only transforms under a subgroup of $SL(2, \mathbb{Z})$ that leaves invariant the spin structure on T^2 .

Relating the boundary conditions

By relating the original four-dimensional gauge theory to the intersecting brane picture one can in fact derive the McKay correspondence directly. Moreover we can understand the appearance of characters of the WZW models (for both the $SU(N)$ and the $SU(k)$ symmetry) in a more natural way in this set-up. Recall that the $SU(N)$ gauge theory on the A_{k-1} singularity or TN_k manifold is specified by a boundary state. This state is given by picking a flat connection on the boundary that is topologically S^3/\mathbb{Z}_k . If we think of this system in radial quantization near the boundary, where we consider a wave function for the time evolution along

$$S^3/\mathbb{Z}_k \times \mathbb{R},$$

we have a Hilbert space with one state $|\rho\rangle$ for each N -dimensional representation

$$\rho: \mathbb{Z}_k \rightarrow U(N).$$

After the duality to the I-brane system, we are dealing with a five-dimensional $SU(N)$ gauge theory on $\mathbb{R}^3 \times T^2$, with k D6-branes intersecting it along $\{p\} \times T^2$ where p is (say) the origin of \mathbb{R}^3 . Here the boundary of the D4-brane system is $S^2 \times T^2$. In other words, near the boundary the space-time geometry looks like $\mathbb{R} \times S^2 \times T^2$. We now ask ourselves what specifies the boundary states for this theory. Since we need a finite energy condition, this is equivalent to considering the IR limit of the theory. In M-theory the S^1 -bundle over S^2 carries a first Chern class k , which translates into the flux of the graviphoton field strength

$$\int_{S^2} G_2 = 2\pi k.$$

Therefore the term

$$\int_{S^2 \times T^2 \times \mathbb{R}} G_2 \wedge CS(A),$$

living on the D4 brane, leads upon reduction on S^2 (as is done in [31]) to the term

$$I_{CS} = 2\pi k \int_{T^2 \times \mathbb{R}} CS(A).$$

Hence we have learned that the boundary condition for the D4-brane requires specifying a state of the $SU(N)$ Chern-Simons theory at level k living on T^2 . The Hilbert space for

Chern-Simons theory on T^2 is well-known to have a state for each integrable representation of the $\widehat{u}(N)_k$ WZW model, which up to the level-rank duality described in the previous section, gives the McKay correspondence.

In fact, the full level-rank duality can be brought to life. Just as we discussed for the N D4-branes, a $SU(k)$ gauge theory lives on the k D6-branes on $T^2 \times \mathbb{R}^5$. The boundary of the space is $S^4 \times T^2$. Furthermore, taking into account that the N D4-branes source the G_4 RR flux through S^4 , we get, as in the above, a $SU(k)$ Chern-Simons theory at level N living on $T^2 \times \mathbb{R}$. Therefore the boundary condition should be specified by a state in the Hilbert space of the $SU(k)$ Chern-Simons theory on T^2 . So we see three distinct ways to specify the boundary conditions: as a representation of \mathbb{Z}_k in $SU(N)$, as a character of $SU(N)$ at level k , and as a character of $SU(k)$ at level N . Thus we have learned that, quite independently of the fermionic realization, there should be an equivalence between these objects.

To make the map more clearly we could try to show that the choice of the flat connection of the $SU(N)$ theory on S^3/\mathbb{Z}_k gets mapped to the characters that we have discussed in the dual intersecting brane picture. To accomplish this, recall that the original $SU(N)$ action on the A_{k-1} space leads to a boundary term (modulo an integer multiple of $2\pi i\tau$) given by the Chern-Simons invariant

$$\frac{\tau}{4\pi i} \int_{A_{k-1}} \text{Tr} F \wedge F = \frac{\tau}{4\pi i} \int_{S^3/\mathbb{Z}_k} CS(A).$$

Restricting to a particular flat connection on S^3/\mathbb{Z}_k yields the value of the classical Chern-Simons action.

If we show that

$$S(\rho) = \frac{1}{8\pi^2} \int_{S^3/\mathbb{Z}_k} CS(A)$$

for the flat connection ρ on S^3/\mathbb{Z}_k gets mapped to the conformal dimension h_ρ of the corresponding state of the quantum Chern-Simons theory on T^2 , we would have completed a direct check of the map, because the gauge coupling constant τ above is nothing but the modulus of the torus in the dual description.

To see how this works, let us first consider the abelian case of $N = 1$. In that case the flat connection ρ is given by a phase $e^{2\pi i n/k}$ with $n \in \mathbb{Z}/k\mathbb{Z}$. The corresponding CS term gives

$$S^{U(1)}(\rho) = \frac{n^2}{2k}.$$

This is the conformal dimension of a primary state of the $U(1)$ WZW model at level k .

A general $U(N)$ connection can always be diagonalized to $U(1)^N$, which therefore gives integers $n_1, \dots, n_N \in \mathbb{Z}/k\mathbb{Z}$. The Chern-Simons action is therefore given by

$$S^{U(N)}(\rho) = \sum_{I=1}^N \frac{n_I^2}{2k}.$$

On the other hand, a conformal dimension of a primary state in the corresponding WZW model is given by

$$h_\rho = \frac{C_2(\rho)}{2(k+N)},$$

where ρ is an irreducible integrable $\widehat{u}(N)_k$ weight. Such a weight can be encoded in a Young diagram with at most N rows of lengths R_I . There is a natural change of basis $n_I = R_I + \rho_I^{\text{Weyl}}$ where we shift by the Weyl vector ρ^{Weyl} . If we decompose $U(N)$ into $SU(N)$ and $U(1)$, the basis n_I cannot be longer than k , which relates to the condition $n_I \in \mathbb{Z}_k$ on the Chern-Simons side. In this basis the second Casimir C_2 takes a simple form. Therefore the conformal dimension becomes

$$h_\rho = -\frac{N(N^2-1)}{24(k+N)} + \frac{1}{2(k+N)} \sum_{I=1}^N n_I^2.$$

The constant term combines nicely with the central charge contribution $-c_{N,k}/24$ to give an overall constant $(N^2-1)/24$. Apart from this term we see that h_ρ indeed matches the expression for $S^{U(N)}(\rho)$ given above, up to the usual quantum shift $k \rightarrow k+N$.

According to the McKay correspondence one might expect to find a relation between representations of \mathbb{Z}_k and $\widehat{u}(k)_N$ integrable weights. Instead, we have just shown how $\widehat{u}(N)_k$ weights ρ arise. Nonetheless, one can relate integrable weights of those algebras by a transposition of the corresponding Young diagrams. Then the conformal dimensions of $\widehat{u}(k)_N$ weights $\tilde{\rho}$ are determined by the relation [32]

$$h_\rho + h_{\tilde{\rho}} = \frac{|\rho|}{2} - \frac{|\rho|^2}{2Nk},$$

which is a consequence of the level-rank duality described in appendix A. The above chain of arguments connects \mathbb{Z}_k representations and $\widehat{u}(k)_N$ integrable weights, thereby realizing the McKay correspondence.

2.7 Orientifolds and SO/Sp gauge groups

So far we have considered a system of N D4-branes and k D6-branes intersecting along a torus, whose low energy theory is described by $U(N)$ and $U(k)$ gauge theories on each

stack of branes, together with bifundamental fermions. We can reduce this system to orthogonal or symplectic gauge groups in a standard way by adding an orientifold plane. This construction can also be lifted to M-theory. Let us recall that D6-branes in our system originated from a Taub-NUT solution in M-theory. The O6-orientifold can also be understood from M-theory perspective, and it corresponds to the Atiyah-Hitchin space [33]. Combining both ingredients, it is possible to construct the M-theory background for a collection of D6-branes with an O6-plane. The details of this construction are explained in [33].

Let us see what are the consequences of introducing the orientifold into our I-brane system. We start with a stack of k D6-branes. To get orthogonal or symplectic gauge groups one should add an orientifold O6-plane parallel to D6-branes [35], which induces an orientifold projection Ω which acts on the Chan-Paton factors via a matrix γ_Ω . Let us recall there are in fact two species O6 $^\pm$ of such an orientifold. As the Ω must square to identity, this requires

$$\gamma_\Omega^t = \pm \gamma_\Omega,$$

with the \pm sign corresponding to O6 $^\pm$ -plane, which gives respectively $SO(k)$ and $Sp(2k)$ gauge group. In the former case k can be even or odd; k odd requires having *half-branes*, fixed to the orientifold plane (as explained *e.g.* in [34]).

Let us add now N D4-branes intersecting D6 along two directions. The presence of O6 $^\pm$ -plane induces appropriate reduction of the D4 gauge group as well. The easiest way to argue what gauge group arises is as follows. We can perform a T-duality along three directions to get a system of D1-D9-branes, now with a spacetime-filling O9-plane. This is analogous to the D5-D9-O9 system in [35], in which case the gauge groups on both stacks of branes must be different (either orthogonal on D5-branes and symplectic on D9-branes, or the other way round); the derivation of this fact is a consequence of having 4 possible mixed Neumann-Dirichlet boundary conditions for open strings stretched between branes. On the contrary, for D1-D9-O9 system there is twice as many possible mixed boundary conditions, which in consequence leads to the same gauge group on both stack of branes. By T-duality we also expect to get the same gauge groups in D4-D6 system under orientifold projection.

Let us explain now that the appearance of the same type of gauge groups is consistent with character decompositions resulting from consistent conformal embeddings or the existence of the so-called dual pairs of affine Lie algebras related to systems of free fermions. We have already come across one such consistent embedding in (2.6) for $\widehat{u}(Nk)_1$. A dual

pair of affine algebras in this case is $(\widehat{su}(N)_k, \widehat{su}(k)_N)$. These two algebras are related by the level-rank duality discussed in the appendix A. As proved in [36, 37], all other consistent dual pairs are necessarily of one of the following forms

$$\begin{aligned} &(\widehat{sp}(2N)_k, \widehat{sp}(2k)_N), \\ &(\widehat{so}(2N+1)_{2k+1}, \widehat{so}(2k+1)_{2N+1}), \\ &(\widehat{so}(2N)_{2k+1}, \widehat{so}(2k+1)_{2N}), \\ &(\widehat{so}(2N)_{2k}, \widehat{so}(2k)_{2N}). \end{aligned}$$

Corresponding expressions in terms of characters, analogous to (A.40), are also given in [37]. The crucial point is that both elements of those pair involve algebras of the same type, which confirms and agrees with the string theoretic orientifold analysis above.

Finally we wish to stress that the appearance of U , Sp and SO gauge groups which we considered so far in this paper is related to the fact that their respective affine Lie algebras can be realized in terms of free fermions, which arise on the I-brane from our perspective. It turns out there are other Lie groups G whose affine algebras have free fermion realization. There is a finite number of them, and fermionic realizations can be found only if there exists a symmetric space of the form G'/G for some other group G' [38]. It is an interesting question whether I-brane configurations could be engineered in string theory which would support fermions realizing all those affine algebras, and what would be a physical interpretation of the corresponding symmetric spaces.

From a geometric point of view we can remark the following. For ALE singularities of A -type and D -type a non-compact dimension can be compactified on a S^1 to give Taub-NUT geometries. For exceptional groups such manifolds do not exist. But one can compactify *two* directions on a T^2 to give an elliptic fibration. In this setting exotic singularities can appear as well. Such construction have a direct analogue in type IIB string theory where they correspond to a collection of (p, q) 7-branes [39]. The I-brane is now generalized to the intersection of N D3-branes with this non-abelian 7-brane configuration [40]. However, there is in general no regime where all the 7-branes are weakly coupled, so it is not straightforward to write down the I-brane system.

3 $\mathcal{N} = 2$ gauge theories and curved I-branes

There is no reason why the above argument relating gauge theories on an A_{k-1} singularity to an I-brane system produced by k intersecting D6-branes, cannot be restricted

to the trivial case of an A_0 “singularity”. That is, with the same methods we can try to compute the partition function of the supersymmetric gauge theory on \mathbb{R}^4 by embedding it into a TN_1 manifold, which we can then think of as interpolating smoothly between \mathbb{R}^4 and $\mathbb{R}^3 \times S^1$, depending on the value of its compactification radius R . Of course, in this duality we do take the size of a circle in M-theory from large to small, and therefore the relation between the gauge theory and the I-brane system should be considered as a strong-weak duality in string theory.

For example, we could consider the simplest possible case of a $U(1)$ gauge theory corresponding to a single D4-brane on \mathbb{R}^4 . Using the duality with I-branes this theory would be then mapped to a single chiral fermion $\psi(z)$ on the I-brane. Note that, for the appropriate values of the background moduli, this $U(1)$ gauge theory has a stringy nature and there are still point-like instantons in this model (bound states with D0-branes), which explains why this partition function is non-trivial function of the gauge coupling τ :

$$Z(\tau) = \frac{\theta_3(v, \tau)}{\eta(\tau)} = \sum_{n \in \mathbb{Z}} \frac{e^{\pi i \tau n^2 + 2\pi i v n}}{\eta(\tau)},$$

with

$$\eta(\tau) = q^{1/24} \prod_{n>0} (1 - q^n).$$

Up to now we have only been considering I-branes with worldsheet T^2 . However, we can generalize this easily to more general topologies. In this fashion we will naturally relate to gauge theories with less than maximal supersymmetry.

3.1 I-branes on general curves

We will now turn to gauge theories with $\mathcal{N} = 2$ and $\mathcal{N} = 1$ supersymmetry. It is well-known that these models can be engineered in string theory by considering more complicated compactifications and brane configurations. In fact, in many ways the most elegant starting point is an M5-brane configuration in M-theory.

Let us start with the compactification

$$(M) \quad TN \times \mathcal{B} \times \widetilde{\mathbb{R}}^3,$$

corresponding to the top box in fig. 1 (with S^1 decompactified). Here we have denoted the three non-compact directions as $\widetilde{\mathbb{R}}^3$ to distinguish them from the \mathbb{R}^3 in the base of TN . We further pick \mathcal{B} to be a flat complex surface that is topologically a T^4 or some

decompactification of it. That is, in the most general case \mathcal{B} will be a product

$$\mathcal{B} = E \times E'$$

of two elliptic curves. But more often we will consider the degenerations $\mathcal{B} = \mathbb{C}^* \times \mathbb{C}^*$ and $\mathcal{B} = \mathbb{C} \times \mathbb{C}$, or any mixed combination. (In the relation with integrable hierarchies the cases \mathbb{C} , \mathbb{C}^* , and E correspond to rational, trigonometric, and elliptic solutions respectively.) We will denote the affine coordinates on \mathcal{B} as $(x, y) \in \mathcal{B}$. The complex surface \mathcal{B} has a (2,0) holomorphic form

$$\omega = dx \wedge dy.$$

We will now pick a holomorphic curve Σ inside \mathcal{B} given by an equation

$$\Sigma : P(x, y) = 0,$$

and wrap for the moment a single M5-brane over $TN \times \Sigma$. Because Σ is holomorphically embedded this is a configuration with $\mathcal{N} = 2$ supersymmetry in four dimensions.

Now there are two obvious reductions to type IIA string theory depending on whether we take the S^1 in the Taub-NUT fibration, or an S^1 inside \mathcal{B} . In the first case we obtain the Type IIA compactification of the form

$$(IIA) \quad \mathbb{R}^3 \times \mathcal{B} \times \widetilde{\mathbb{R}}^3.$$

Again there will be a D4-brane wrapping $\mathbb{R}^3 \times \Sigma$ with $\Sigma \subset \mathcal{B}$, together with k D6-branes wrapping $\mathcal{B} \times \widetilde{\mathbb{R}}^3$. In this case the I-brane is completely wrapping the curve Σ . This configuration is illustrated in fig. 3.

In this generalized geometry we should consider the free fermion system on a higher genus Riemann surface with action

$$I = \int_{\Sigma} \psi^\dagger \bar{\partial} \psi.$$

In the dual interpretation we will compactify \mathcal{B} along a S^1 down to a three dimensional base \mathcal{B}_3 . The curve Σ , and therefore also the M5-brane, will partially wrap this S^1 . Consequently, we arrive at a configuration of NS 5-branes and D4-branes that are spanned between them [41]. In the classical situation discussed by Witten we take $\mathcal{B} = \mathbb{C} \times \mathbb{C}^*$ and end up with a IIA string theory on

$$(IIA) \quad TN \times \mathbb{R}^6$$

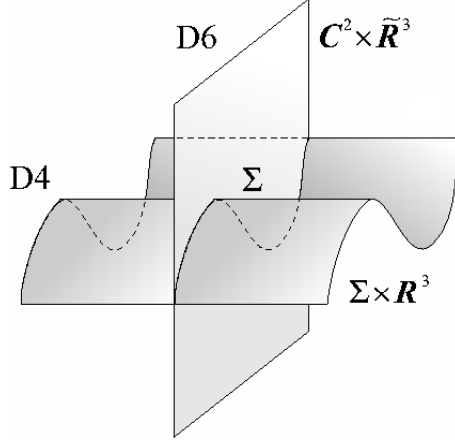

Fig. 3: A more general configuration of D4 and D6-branes where the intersection locus is an affine holomorphic curve Σ .

with a set of parallel NS 5-branes with D4-branes ending on them. This is exactly the brane configuration that engineers $\mathcal{N} = 2$ gauge theories.

In this case we can again compare the I-brane with the gauge theory computation. In the gauge theory we are computing two contributions. Firstly, there is a gauge coupling matrix τ_{IJ} of the $U(1)^g$ fields F^I

$$\int_{TN} \frac{i}{4\pi} \tau_{IJ} F_+^I \wedge F_+^J + v_I \wedge F_+^I.$$

for a genus g curve Σ . On the TN geometry the gauge field strengths F^I have fluxes in the lattice

$$[F^I/2\pi] = p^I \in H^2(TN, \mathbb{Z}).$$

Since the cohomology lattice $H^2(TN, \mathbb{Z}) \cong \mathbb{Z}^k$, these fluxes are labeled by integers p_a^I with $I = 1, \dots, g$ and $a = 1, \dots, k$.

Secondly, there is a gravitational coupling \mathcal{F}_1 that appears in the term

$$\int_{TN} \mathcal{F}_1(\tau) \text{Tr} R_+ \wedge R_+.$$

Since the regularized Euler number of TN_k equals k , combining these two terms yields the partition function

$$Z_{gauge} = \sum_{p_a^I \in \mathbb{Z}} e^{\pi i p_a^I \tau_{IJ} p^{J,a} + 2\pi i v_I^a p_a^I} e^{k \mathcal{F}_1}. \quad (3.9)$$

In the I-brane model the partition function Z_{gauge} is nothing but the determinant of the chiral Dirac operator acting on k free fermions living on the “spectral curve” Σ_g ,

coupled to the flat $U(k)$ connection v on corresponding rank k vector bundle $\mathcal{E} \rightarrow \Sigma$. So we are led in a very direct way to

$$Z_{gauge} = \det \bar{\partial}_{\mathcal{E}}. \quad (3.10)$$

The results (3.9) and (3.10) are just the usual bosonization formula, where the fermion determinant is equivalent to a sum over the lattice of momenta together with a boson determinant. Here we use the identification

$$\mathcal{F}_1 = -\frac{1}{2} \log \det \Delta_{\Sigma}.$$

To complete this map we need to show why the p^I are identified with fermion currents on the Riemann surface through the corresponding cycle, but this is relatively clear. Consider a cycle α_I on the Riemann surface and a disc ending on this cycle (which can always be done as Σ is contractible in the full CY). Then the statement that F^I is turned on corresponds to the fact that the integral of the corresponding flux over this disc is not zero. Since the fermions are charged under the $U(k)$ gauge group, this means that they pick up a phase as they go along this cycle on the Riemann surface (the Aharonov-Bohm effect). Thus the holonomy of the fermions correlates with the p^I . Later (in section 3.4), we provide an alternative view of the fluxes p^I : they also correspond to D4-branes, wrapping 4-cycles of the Calabi-Yau and bound to the D6-brane.

3.2 The duality chain

Holomorphic quantities in supersymmetric gauge theories are intimately connected to topological string amplitudes on the Calabi-Yau geometry that engineer the gauge system. We now want to connect our results to topological strings by going through another chain of dualities, represented by the vertical sequence of boxes in fig. 1. For this we consider a slightly more general compactification of M-theory, namely

$$(M) \quad TN \times \mathcal{B} \times \mathbb{R}^2 \times S^1,$$

corresponding to the top box in fig. 1. The extra S^1 does not really influence the earlier results, since the D6-branes remain non-compact and therefore the gauge theory that they support stays non-dynamical. Hence the I-brane configuration remains the same. In the other compactification with an ensemble of NS 5-branes and D4-branes we can now perform a T-duality on S^1 to give a web of (p, q) 5-branes in Type IIB, which is another familiar and convenient realization of the $\mathcal{N} = 2$ system.

However, in this situation there is an obvious third possible compactification to type IIA, by just reducing on the extra S^1 that we have introduced. This will give IIA on

$$(IIA) \quad TN \times \mathcal{B} \times \mathbb{R}^2$$

with N NS 5-branes wrapping $TN \times \Sigma$. We haven't gained much in this step, but now we can T-dualize the NS 5-brane away to remain with a purely geometric situation [25, 42]. In general a T-duality *transverse* to a set of N NS 5-branes produces a local A_{N-1} singularity of the form

$$uv = z^N. \tag{3.11}$$

In the case of a single 5-brane $N = 1$ this gives an A_0 “singularity”. We recall that world-sheet instanton effects are important to understand this very non-trivial duality [25, 43, 44].

Applying this T-duality in the present set-up gives us a type IIB compactification of the form

$$(IIB) \quad TN \times X,$$

where X is now a non-compact Calabi-Yau geometry of the form

$$X : uv + P(x, y) = 0.$$

This can be regarded as a \mathbb{C}^* fibration over \mathcal{B} where the fibers degenerate to a pair of intersecting lines $uv = 0$ over the locus Σ given by $P(x, y) = 0$. This is just an application of (3.11) in the case $N = 1$, where z is the local coordinate transverse to the curve Σ .

Once we are in this completely geometric phase, without any further branes, further dualities can bring us into other familiar, but fully equivalent configurations. Mirror symmetry gives us the background

$$(IIA) \quad TN \times \tilde{X},$$

where the mirror CY geometry \tilde{X} has a toric description.

Finally we can go up again to eleven-dimensional M-theory

$$(M) \quad TN \times \tilde{X} \times S^1.$$

This is actually the situation considered in [45, 20, 23] where five-dimensional black hole degeneracies were computed.

In fact, we can close the chain of dualities, by reducing once more to type IIA on the S^1 fiber of the TN to obtain

$$(IIA) \quad \mathbb{R}^3 \times \tilde{X} \times S^1,$$

where now we have k D6-branes wrapping $\tilde{X} \times S^1$. This is the situation where one computes Donaldson-Thomas invariants, which can be viewed as BPS bound states of D0-D2-branes to the D6-brane [46, 47], at least when the background moduli are in the right regime for these bound states to exist [48].

Fermion charges and $U(1)$ fluxes

It might be good to follow the fermion numbers p^1, \dots, p^g (through the handles of the Riemann surface) and the dual $U(1)$ holonomies v_1, \dots, v_g (that couple to these fluxes) through this chain of dualities. We pick $k = 1$ for simplicity. First we remark that we have to choose a basis of A -cycles on Σ to define these quantities.

In the IIB compactification on $TN \times X$ the quantum numbers p^I appear as fluxes of the RR field G_5 through a basis of 3-cycles of the Calabi-Yau X . In reduction of G_5 to the four-dimensional low-energy theory on TN this gives the $U(1)$ gauge fields F^I of the vector multiplets that appear in the gauge coupling

$$\int_{TN} \tau_{IJ} F_+^I \wedge F_+^J.$$

After mapping this configuration to IIA theory on $\mathbb{R}^3 \times S^1 \times \tilde{X}$ with a D6-brane wrapping $S^1 \times \tilde{X}$, the flux p is carried by the $U(1)$ gauge field strength F on the world-volume of the D6-brane, $[F^I/2\pi] = p^I \in H^2(\tilde{X}, \mathbb{Z})$. This can be interpreted as a bound state of a single D6-brane with p D4-branes. In a similar fashion the Wilson lines v_I are mapped to potentials for the D4-branes. So in this duality frame we can simply shift the fermion number by adding D4-branes.

3.3 Fermions and BPS states

Perhaps it is clarifying to compare the chiral fermions, that appear so naturally in the intersecting brane system, to the usual BPS states. This is most naturally done in the M-theory picture, where we consider a M5-brane with topology $TN_k \times \Sigma$.

First of all, the chiral fermions are given by the open fundamental strings that stretch between D4-branes and D6-branes. These strings are lifted to open M2-branes in M-theory. The topology of these membranes is a two-dimensional disc D^2 , whose boundary

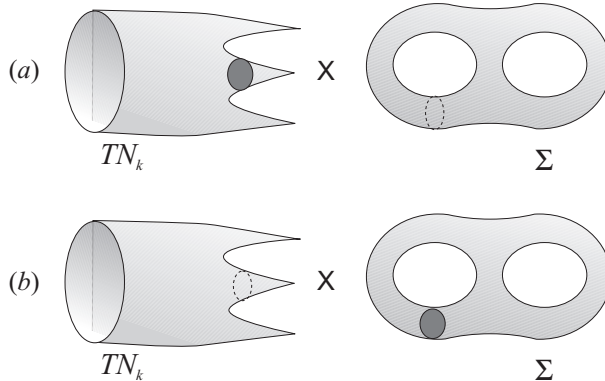

Fig. 4: Two kinds of open M2-brane instantons that contribute to a M5-brane with geometry $TN_k \times \Sigma$: (a) the free fermions, massless at the NUTs of TN_k ; (b) the usual BPS states that become massless when the Riemann surface Σ pinches.

S^1 lies on the M5-brane. It will encircle the S^1 of the Taub-NUT geometry. One way to see this is that the BPS mass of these open M2-brane states is given by

$$Z = \int_{D^2} \omega = \oint_{S^1} \eta,$$

where η is the one-form (2.3) on TN . This mass goes to zero exactly when the M2-brane approaches one of the NUTs of the Taub-NUT geometry. There the chiral fermions appear. The time trajectory of these objects will lie on the Riemann surface Σ . So, if we compute a fermion one-loop diagram, this is represented in M-theory in terms of open M2-brane world-volumes with geometry $D^2 \times S^1$ and boundary $T^2 = S^1 \times S^1$ on the M5-brane. Note that the S^1 on the TN factor is filled in by a disc. This is illustrated in fig. 4a.

On the other hand we have the traditional BPS states in $\mathcal{N} = 2$ compactifications. For example, in the IIB compactification on $TN_k \times X$ these will be given by D3-branes that wrap special Lagrangian 3-cycles in X . After the duality that maps this compactification to a M5-brane, these states become open M2-branes with the topology of a disc as well. But now the boundary S^1 of these discs will lie on the surface Σ . The time trajectory will be along the space-time TN_k . More invariantly, we have again M2-branes with world-volumes $D^2 \times S^1$ and boundary $S^1 \times S^1$, but now the S^1 on the Riemann surface Σ is filled in. This makes sense, since the mass of the BPS states, given by

$$Z = \oint y dx,$$

goes to zero exactly when the surface Σ is pinched or forms a long neck. These states are the M-theory interpretation of the well-known massless monopoles of Seiberg and Witten [41, 49, 50].

In a full quantum theory of the M5-brane, both kinds of open M2-branes should contribute to the partition function. In fact, the boundaries of these M2-branes are the celebrated self-dual strings that should describe the M5-brane world-volume theory [51, 42]. Clearly the corresponding massless states are contributing in different regimes. In that sense the relation between the free fermions and the usual BPS states can be considered as a strong-weak coupling duality.

Chiral fermions localized on the curve Σ have also appeared in the B-model topological string theory on $\mathbb{R}^4 \times X$ [11], in the context of topological vertex. It is natural to ask if these are the same fermions as we have encountered in this paper. An important property of these fermions in the context of topological vertex is that the insertions of the operators $\psi(x_i)$, that create fermions (which is of course not the same as the quanta of the corresponding field), change the geometry of the curve. The fermions will produce extra poles in the meromorphic differential ydx which encodes the embedding of the curve as $P(x, y) = 0$. We have the identification $y = \partial\phi(x)$, and by bosonization the operator product with a fermion insertion gives a single pole at each fermion insertion

$$\partial\phi(x) \cdot \psi(x_i) \sim \frac{1}{x - x_i} \psi(x_i).$$

In the superstring such a correlator

$$\langle \psi(x_1) \cdots \psi(x_n) \rangle$$

of fermion creation operators corresponds to the insertion of D5-branes in type IIB compactification. These 5-branes all have topology $\mathbb{R}^4 \times \mathbb{C}$, where in the Calabi-Yau $uv + P(x, y)$ they are located at specific points x_i of the curve $P(x, y) = 0$ along the line $v = 0$ (so they are parametrized by the remaining coordinate u). Having this extra pole for y means that the Riemann surface has extra tubes attached to it at $x = x_i$.

If we T-dualize this geometry to replace the Calabi-Yau X by an NS5-brane wrapping $\mathbb{R}^4 \times \Sigma$, the D5-branes, which are all transverse to Σ , will become D4-branes. So we get an NS5-brane with a bunch of D4-branes attached, that all end on the NS5-brane. This configuration can be lifted to M-theory to give a single irreducible M5-brane, now with “spikes” at the positions x_1, \dots, x_n . So we indeed see that the two kinds of fermions (or at least their sources) are directly related and have the same effect on the geometry of the Riemann surface.

3.4 Counting BPS states and the topological string theory

In Type II compactifications on Calabi-Yau geometries F-terms in the effective action in four dimensions can be computed using topological string theory techniques. We now want to see how these kind of computations can be mapped to the I-brane model.

Starting point will be the end of the chain of dualities of section 3.2: the IIA compactification on $\mathbb{R}^3 \times S^1 \times \tilde{X}$ with \tilde{X} a (non-compact) Calabi-Yau geometry, where we wrap a D6-brane along $S^1 \times \tilde{X}$. This is the set-up of Donaldson-Thomas theory. With the right background values of the moduli turned on, the topological string partition function can be reproduced as an index that counts BPS states degeneracies of D-branes in this configuration .

More precisely, the topological string theory partition function in the A-model naturally splits in a classical and a quantum (or instanton) contribution

$$Z_{top}(t, \lambda) = \exp\left(-\frac{t^3}{6\lambda^2} - \frac{1}{24}t \cdot c_2\right) Z_{qu}(t, \lambda). \quad (3.12)$$

Here $t \in H^2(\tilde{X})$ is the complexified Kähler class, λ the topological string coupling constant, and $c_2 = c_2(\tilde{X})$. As before the wedge product is used to multiply forms. The quantum contribution is decomposed as

$$Z_{qu}(t, \lambda) = \sum_{g \geq 0} \lambda^{2g-2} \mathcal{F}_g(t),$$

with the genus g free energy expressed in terms of the Gromov-Witten invariants of degree d as

$$\mathcal{F}_g(t) = \sum_d GW_g(d) e^{d \cdot t}.$$

We can now use the fact that Z_{qu} has a dual interpretation as the Donaldson-Thomas partition function counting D0-D2-D6 bound states (we ignore here a subtlety with the degree zero maps) [20, 23, 46, 47, 52]

$$Z_{qu}(t, \lambda) = \sum_{n,d} DT(n, d) e^{-n\lambda} e^{d \cdot t}. \quad (3.13)$$

In this sum $n \in H_0(\tilde{X}, \mathbb{Z}) \cong \mathbb{Z}$ and $d \in H_2(\tilde{X}, \mathbb{Z})$ are the numbers of D0-branes and D2-branes. The integers $DT(n, d)$ are the Donaldson-Thomas invariants of the ideal sheaves with these characteristic classes. From the BPS counting perspective it is also natural to add the exponential cubic prefactor in (3.12), since this is nothing but the tension of a single D6-brane (including the geometrically induced D2-brane charge).

In type IIA string theory set-up the complex parameters λ and t can be expressed in terms of geometric moduli of the S^1 and the Calabi-Yau \tilde{X} , and the Wilson loops of the flat RR fields C_1 and C_3 . In particular, we can write

$$\lambda = \frac{\beta}{\ell_s g_s} + i\theta, \quad (3.14)$$

with

$$\beta = 2\pi R_9 = \oint_{S^1} ds$$

the length of the Euclidean time circle S^1 , and θ the Wilson loop

$$\theta = \oint_{S^1} C_1.$$

That is, λ can be written as the holonomy of the complexified one-form $ds/g_s + iC_1$ (in string units). An important remark is that, as expressed in equation (3.13), for BPS states θ and β only appear in the *holomorphic* combination (3.14). In the same way the parameter t is given by the integral of the complex 3-form $k \wedge ds/g_s + iC_3$ over S^1 .

It is rather trivial to also include the coupling to D4-branes in this BPS sum. As explained before, such a bound state of p D4-branes to a D6-brane is given by a flux of the $U(1)$ gauge field on the D6-brane. We can think of this as a non-trivial first Chern class of the line bundle over the D6-brane that wraps \tilde{X} . Tensoring with this extra line bundle will not change the BPS degeneracy, since the moduli space of such twisted sheaves is isomorphic to that of the untwisted one. The only thing that changes are the induced D0 and D2 charges, that shift as

$$\begin{aligned} d &\rightarrow d - \frac{1}{2}p^2 - \frac{1}{24}c_2 \\ n &\rightarrow n + d \cdot p + \frac{1}{6}p^3 + \frac{1}{24}p \wedge c_2. \end{aligned} \quad (3.15)$$

So, if we also include a sum over the number of D4-branes, weighted by a potential v , we get a generalized partition function

$$\begin{aligned} Z(v, t, \lambda) &= \sum_{p \in H^2(\tilde{X}, \mathbb{Z})} e^{p(v-t^2/2\lambda)} e^{-(p^2/2+c_2/24)t} e^{-(p^3/6+pc_2/24)\lambda} e^{-t^3/6\lambda^2} Z_{qu}(t + p\lambda, \lambda) \\ &= \sum_{p \in H^2(\tilde{X}, \mathbb{Z})} e^{pv} Z_{top}(t + p\lambda, \lambda). \end{aligned} \quad (3.16)$$

Apart from adding the D6-brane tension $-t^3/6\lambda^2$, we have also added the tension $-pt^2/2\lambda$ of the D4-branes. The structure (3.16) will be the object that we want to identify with

the I-brane partition function and that should be computable in terms of free fermions. It should be remarked that the partition function (3.16) was also found in [53], where a dual object was studied: a NS 5-brane wrapping \tilde{X} . Also in [13] a partition function of this type was considered and directly related to fermionic expressions.

Let us now follow this D-brane set-up through the duality chain. Before we do this, though, let us note that the above expression for $Z(v, t, \lambda)$ has an interesting limit for $\lambda \rightarrow 0$, where only genus zero and one contribute. In that case we have

$$Z_{top}(t + p\lambda) \sim \exp \left[\frac{1}{\lambda^2} \mathcal{F}_0(t) + \frac{1}{\lambda} p^I Z_I + \frac{1}{2} p^I p^J \tau_{IJ} + \mathcal{F}_1(t) + \mathcal{O}(\lambda) \right]. \quad (3.17)$$

If we now subtract the singular terms (which have a straightforward interpretation as we shall see in a moment), we are left with the familiar $\lambda = 0$ answer

$$Z(v, t) = \sum_p e^{\frac{1}{2} p \cdot \tau \cdot p + p \cdot v} e^{\mathcal{F}_1}.$$

3.5 Topological strings and I-branes

If we lift the configuration of the previous section to M-theory, we end up with a purely geometric compactification on $TN \times S^1 \times \tilde{X}$. Asymptotically this geometry has a T^2 fibration over \mathbb{R}^3 . The ratio of the radii of the two circles of this two-torus is given by

$$\frac{\beta}{2\pi g_s \ell_s} = \frac{R_9}{R_{11}}.$$

The complex modulus of this T^2 is given by $\lambda/2\pi i$. If we exchange the roles of the 9th and 11th dimension, we will perform a modular transformation or S-duality

$$\lambda \rightarrow 4\pi^2/\lambda.$$

Equivalently, in the dual IIA compactification on $TN \times \tilde{X}$ the asymptotic values for the radius of the circle fibration and the graviphoton Wilson line are given by $-1/\lambda$. In the somewhat singular limit $\beta \rightarrow 0$ we are left with $\lambda = \theta/2\pi$ and so after the duality we have a graviphoton proportional to $1/\lambda$. Now this Wilson loop only makes sense asymptotically, since this S^1 is contractible in TN . In fact, the graviphoton gauge field is given by

$$C_1 = \frac{1}{\lambda} \eta,$$

where the one-form η is our friend (2.3). This field is not flat but has curvature

$$G_2 = dC_1 = \frac{1}{\lambda} \omega. \quad (3.18)$$

Here ω is the unique harmonic 2-form that is invariant under the tri-holomorphic circle action (2.2). Note that this is a natural choice, since in the case of TN_1 this form reduces to the usual constant self-dual two-form in the center \mathbb{R}^4 (up to hyper-Kähler rotations).

Summarizing, the topological string partition function will be reproduced by a IIA compactification on $TN \times \tilde{X}$ with graviphoton flux given by (3.18). Note that in this case the graviphoton is *inversely* proportional to the topological string coupling!

It is now straightforward to follow this flux further through the duality chain. In the type IIB compactification on $TN \times X$ the self-dual 5-form RR field G_5 is given by

$$G_5 = \frac{1}{\lambda} \omega \wedge \Omega.$$

with Ω the holomorphic $(3, 0)$ form on the Calabi-Yau X .

We will now T-dualize this configuration to the IIA background that includes a NS5-brane. In that case there is 4-form RR-flux

$$G_4 = \frac{1}{\lambda} \omega \wedge dx \wedge dy. \tag{3.19}$$

Here $dx \wedge dy$ is the $(2, 0)$ form on the complex surface \mathcal{B} . This 4-form flux can be directly lifted to M theory, where we have the geometry

$$TN \times \mathcal{B} \times \mathbb{R}^3.$$

Now we have to discuss what the interpretation of this flux is, if we reduce to IIA theory along the S^1 inside TN to produce our system of intersecting branes. In that case we will have an extra set of D6-branes with geometry $\mathcal{B} \times \mathbb{R}^3$. We want to argue that the G_4 flux becomes a constant NS B -field on their world-volumes.

As a preparation, let us recall again how the world-volume fields of the D6-branes are related to the TN geometry in the M-theory compactification. First of all, the centers \vec{x}_a of the TN manifold are given by the vev's of the three scalar Higgs fields of the 6+1 dimensional gauge theory on the D6-brane. In a similar fashion the $U(1)$ gauge fields A_a on the D6-branes are obtained from the 3-form C_3 field in M-theory. More precisely, if ω_a are the k harmonic two-forms on TN_k introduced in section 2, we have a decomposition

$$C_3 = \sum_a \omega_a \wedge A_a.$$

We recall that the forms ω_a are localized around the centers \vec{x}_a of the TN geometry. So in this fashion a bulk field gets replaced by a brane field. This relation also holds for a single D6-brane, because ω is normalizable in TN_1 .

As a direct consequence of this, the reduction of the 4-form field strength $G = dC$ can be identified with the curvature of the gauge field

$$G_4 = \sum_a \omega_a \wedge F_a.$$

Combining this relation with the presence of the flux (3.19), we find that in the I-brane configuration the D6-branes support a constant flux

$$\sum_a F_a = \frac{1}{\lambda} dx \wedge dy.$$

There is simple and equivalent way to induce such a constant magnetic field on all of the D6-branes: turn on a NS B -field in the IIA background. We can therefore conclude that in the presence of the background flux (3.19) translates into a constant B_{NS} field induced on the surface \mathcal{B}

$$B_{NS} = \frac{1}{\lambda} dx \wedge dy.$$

In the next section we will discuss the full consequences of this.

4 Topological strings and \mathcal{D} -modules

As we have seen in the previous section, ignoring all non-compact directions, the essence of the intersecting brane configuration is a D6-brane on the complex surface \mathcal{B} with a D4-brane wrapped along the curve

$$\Sigma : P(x, y) = 0.$$

In addition a constant B -field

$$B = \frac{1}{\lambda} dx \wedge dy \tag{4.20}$$

is turned on. In this section we will argue that this set-up is most naturally described using the formalism of \mathcal{D} -modules. But at this point we first want to point out one immediate and more elementary consequence of the B -field. The presence of the flux induces a $U(1)$ gauge field on the D6-brane

$$A = \frac{1}{\lambda} y dx. \tag{4.21}$$

For the 4-6 strings we have to restrict A to Σ . Therefore the chiral fermions are coupled to a non-zero $U(1)$ gauge field. This background gauge field gives a contribution to the

effective action on Σ of the form

$$\mathcal{F} = \frac{1}{2} \sum_I \oint_{a^I} A \oint_{b_I} A.$$

Here (a^I, b_I) is a canonical basis of $H_1(\Sigma, \mathbb{Z})$. Plugging the expression for A we obtain precisely the (genus zero) prepotential of topological string theory

$$\mathcal{F} = \frac{1}{\lambda^2} \mathcal{F}_0, \tag{4.22}$$

where, as always,

$$Z^I = \oint_{a^I} y dx, \quad \partial_I \mathcal{F}_0 = \oint_{b_I} y dx.$$

In fact, we can also include a non-trivial flux p^I through the cycles a^I . This will give a second contribution to the free energy given by

$$p^I \oint_{b_I} A = \frac{1}{\lambda} p^I \partial_I \mathcal{F}_0. \tag{4.23}$$

We recognize the contributions (4.22) and (4.23) as the genus zero contributions in the expansion for small λ of the general expression (3.17).

4.1 I-branes and \mathcal{D} -modules

Let us now explain how \mathcal{D} -modules naturally appear in the I-brane set-up. (See also [54] for a much more involved setting.) First of all, by very general arguments the algebra \mathcal{A} of open string fields on the D6-brane is naturally non-commutative. This is a consequence of the fact that the Riemann surface that describes the interaction

$$\mathcal{A} \otimes \mathcal{A} \rightarrow \mathcal{A}$$

only has a cyclic symmetry (see fig. 5).

This non-commutativity is particularly clear if one includes a B -field as in (4.20). One simple way to see this is, that in the presence of such a B -field a gauge field A is induced that couples to the open strings. The gauge field satisfies $dA = B$ and can be chosen as

$$A = \frac{1}{\lambda} y dx.$$

Therefore, on the 6-6 strings there is a boundary term

$$\int A = \int dt \frac{1}{\lambda} y \dot{x}.$$

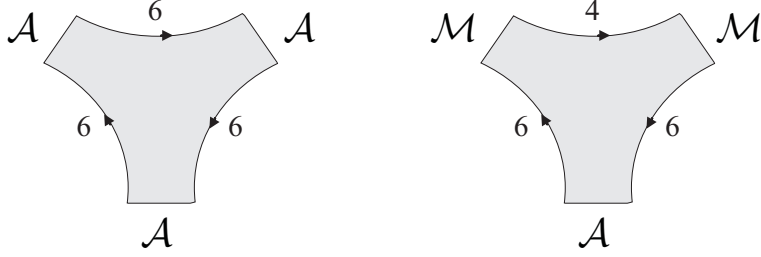

Fig. 5: The 6-6 strings naturally form a non-commutative algebra \mathcal{A} , whereas the 4-6 strings are a module \mathcal{M} for the algebra \mathcal{A} .

If we reduce this term to the zero-modes of the strings we get the usual term of quantum mechanics, where λ plays the role of \hbar . Therefore the coordinates x and y become non-commutative operators

$$[\hat{x}, \hat{y}] = \lambda.$$

So, the zero-slope limit of the algebra \mathcal{A} becomes the Heisenberg algebra, generated by the variables \hat{x}, \hat{y} . This is also known as the non-commutative or quantum plane. In the case where $\mathcal{B} = \mathbb{C}^2$ we can identify this algebra with the algebra of differential operators on \mathbb{C}

$$\mathcal{A} \cong \mathcal{D}_{\mathbb{C}}.$$

The algebra $\mathcal{D}_{\mathbb{C}}$ consists of all operators

$$D = \sum_i a_i(x) \partial^i, \quad \partial = \frac{\partial}{\partial x}.$$

Here we have identified $\hat{y} = -\lambda \partial$.

Now suppose that we add some other brane to this system, in our case a D4-brane localized on Σ . We pick x as our local coordinate, so that, once restricted to the curve, the variable y is given by a function $y = p(x)$. Now the space of 4-6 open strings, that we will denote as \mathcal{M} , is by definition a module for the algebra \mathcal{A} of 6-6 strings. This is a simple consequence of the fact that a 6-6 string acting on a 4-6 string produces again a 4-6 string, as depicted in fig. 5. Therefore there is an action

$$\mathcal{A} \times \mathcal{M} \rightarrow \mathcal{M}.$$

(More completely, \mathcal{M} is a \mathcal{A} - \mathcal{B} bimodule, where \mathcal{B} is the algebra of 4-4 open strings.)

Modules for the algebra of differential operators are called \mathcal{D} -modules. In this case we are interested in \mathcal{D} -modules that in the semi-classical limit reduce to curves or equivalently Lagrangians. Such \mathcal{D} -modules are called holonomic.

So we can draw the following conclusion: in the presence of a background flux, the chiral fermions on the I-brane should no longer be regarded as *local fields* or sections of the spin bundle $K^{1/2}$. Instead they should be interpreted as sections of a non-commutative \mathcal{D} -module.

Notice that if Σ is a non-compact curve, having marked points at infinity, the symplectic form $dx \wedge dy$ becomes very large at the asymptotic legs. This can be seen by using the appropriate variables at infinity $x' = 1/x$ and $y' = 1/y$. In these variables the B -field becomes singular which means that the non-commutativity goes to zero. This explains why it makes sense to speak about the usual free chiral fermions at infinity, and to discuss their nontrivial transformation properties from patch to patch as in [11]. Considering compact spectral curves seems to be much more involved from this perspective.

Let us explain such structures with a simple example of a \mathcal{D} -module. We start with the commuting case, in which the algebra \mathcal{A} is given by the ring \mathcal{O} of functions on the plane. If the spectral curve Σ is given by $P = 0$, then we can write $\mathcal{M} = \mathcal{O}/\mathcal{I}_\Sigma$ as the quotient

$$\mathcal{M} = \mathcal{O}/\mathcal{I}_\Sigma,$$

where $\mathcal{I}_\Sigma = \mathcal{O} \cdot P$ is the ideal of functions vanishing on Σ .

Now suppose that P is not a polynomial, but a differential operator

$$P \in \mathcal{D}.$$

Then we can similarly define a \mathcal{D} -module as an equivalence class of differential operators

$$\mathcal{M} = \mathcal{D}/\mathcal{D}P.$$

One way to think about such a module is in terms of a formal solution to the equation

$$P\Psi = 0. \tag{4.24}$$

Clearly, any differential operator of the form $D \cdot P$ will annihilate Ψ , so that \mathcal{M} can also be realized as the vector space of expressions of the form

$$\mathcal{M} = \{D\Psi; D \in \mathcal{D}\}.$$

Mathematically, the module \mathcal{M} captures the solutions of the differential equation (4.24) in the following fashion. Suppose that one would want to solve this equation for a function Ψ that takes value in some function space \mathcal{V} , *e.g.* the space of square-integrable functions on \mathbb{R} . Such a space \mathcal{V} is itself a \mathcal{D} -module. Namely, \hat{x} and \hat{y} are realized as

multiplication by x and the differential $-\lambda\partial_x$. One of the important properties of \mathcal{D} -modules is that the space of solutions of $P\Psi = 0$ in \mathcal{V} is given by algebra homomorphisms

$$\mathrm{Hom}_{\mathcal{D}}(\mathcal{M}, \mathcal{E})$$

where the gauge bundle \mathcal{E} is in general some torsion-free sheaf on Σ .

The \mathcal{D} -module \mathcal{M} and the corresponding differential operator P should be considered as the non-commutative generalization of the classical curve Σ . This is the “quantum spectral curve” from the theory of quantization of integrable systems, as is known from the geometric Langlands perspective [54]. Within the context of string theory it is clear that there should be a *unique* \mathcal{D} -module that corresponds to the curve Σ . This prescription should fix possible normal ordering ambiguities in P . It would be interesting to understand this directly from the mathematical formalism.

4.2 A simple example: rational curves

Let us illustrate this with a very simple example: the curve $y = 0$. Topologically $\Sigma = \mathbb{C}$ can be viewed as a disc and in the fermion CFT it will correspond to a state in the Fock space \mathcal{F} . In this case the corresponding \mathcal{D} -module just consists of the polynomials in x

$$\mathcal{M} = \mathbb{C}[x]$$

and \hat{y} is realized as $-\lambda\partial_x$. The one-form ydx vanishes identically. The free fermion theory based on this module consists of the usual vacuum state $|0\rangle$.

But now we can make a small variation, by picking the curve

$$y = p(x),$$

with $p(x)$ some function. In this case the (meromorphic) one-form is $p(x)dx$. The corresponding \mathcal{D} -module is still isomorphic to $\mathbb{C}[x]$ as a vector space, but now the operator \hat{y} is represented as

$$\hat{y} = -\lambda\partial_x + p(x).$$

Of course, there is an obvious map between these two modules: we simply multiply the functions $\psi(x) \in \mathbb{C}[x]$ as

$$\psi(x) \rightarrow e^{-S(x)/\lambda}\psi(x), \quad \partial S(x) = p(x)dx.$$

In the quantum field theory, where $\psi(x)$ becomes an operator acting on the Fock space \mathcal{F} , this correspondence is represented by a linear map U such that

$$U \cdot \psi(x) \cdot U^{-1} = e^{-S(x)/\lambda}\psi(x).$$

If $S(x) = \sum_k t_k x^k$ such a map is given by

$$U = \exp \sum_k \frac{1}{\lambda} t_k \alpha_k$$

where $\sum_k \alpha_k x^{-k-1} = \partial\phi(x) =: \psi^\dagger \psi(x)$: is the usual mode expansion of the $U(1)$ current. Here we use that $[\alpha_k, \psi(x)] = x^k \psi(x)$. The corresponding state in the Sato Grassmannian is given by $U|0\rangle$. Since $\alpha_k|0\rangle = 0$ for $k \geq 0$, this state is only different from the vacuum if the function $S(x)$ (or $p(x)$) has poles.

4.3 Conifold and $c=1$ string

Another illustrative case is a canonical example in any text on \mathcal{D} -modules (see *e.g.* [55, 56]), namely the operator

$$P = -\lambda x \partial_x - \mu.$$

Now there is an interesting singularity at $x = 0$.

In the physical context this case corresponds to one of the best studied examples in string theory: the so-called $c = 1$ string (see *e.g.* [57, 58, 59, 60, 61, 62, 63]). At the self-dual radius the partiton function of the $c = 1$ string is given by

$$\begin{aligned} \mathcal{F}_{c=1}(\mu, \lambda) &= -\frac{1}{2} \left(\frac{\mu}{\lambda}\right)^2 \log \mu + \frac{1}{12} \log \mu \\ &+ \sum_{g \geq 2} (-1)^{g-1} \frac{B_{2g}}{2g(2g-2)} \left(\frac{\lambda}{\mu}\right)^{2g-2}, \end{aligned} \quad (4.25)$$

with μ the cosmological constant, λ the string coupling, and B_{2g} the Bernoulli numbers. This model has a dual interpretation in terms of B-model topological strings on the deformed conifold geometry [57]

$$uv + xy = \mu.$$

Geometrically the $c = 1$ model is thus characterized by the presence of a holomorphic curve in $\mathbb{C} \times \mathbb{C}$ defined by

$$\Sigma : xy = \mu. \quad (4.26)$$

The curve $\Sigma \cong \mathbb{C}^*$ has two asymptotic regions, $U : x \rightarrow \infty$ or $V : y \rightarrow \infty$. Therefore in the usual operator formalism there is a linear operator S that acts between the two state spaces associated to the two boundaries.

First consider the limit $\lambda = 0$. In this regime the I-brane degrees of freedom are just conventional chiral fermions ψ on Σ , which can be expanded as

$$\begin{aligned}\psi(x) &= \sum_{n \in \mathbb{Z}+1/2} \psi_n x^{-n-1/2} \sqrt{dx} \quad \text{and} \quad \psi^\dagger(x) = \sum_{n \in \mathbb{Z}+1/2} \psi_n^\dagger x^{-n-1/2} \sqrt{dx} \quad \text{in } U, \\ \tilde{\psi}(y) &= \sum_{n \in \mathbb{Z}+1/2} \tilde{\psi}_n y^{-n-1/2} \sqrt{dy} \quad \text{and} \quad \tilde{\psi}^\dagger(y) = \sum_{n \in \mathbb{Z}+1/2} \tilde{\psi}_n^\dagger y^{-n-1/2} \sqrt{dy} \quad \text{in } V.\end{aligned}$$

The genus 1 part \mathcal{F}_1 of the free energy is obtained from the partition function of ψ . It can be computed by assigning the usual Dirac vacuum $|0\rangle$ to U and likewise the conjugate state $\langle 0|$ to V . The partition function is then computed as

$$Z = \langle 0|S|0\rangle,$$

where S transforms ψ from the V -patch to the U -patch, *i.e.* $\tilde{\psi}(y) = S\psi(x)S^{-1}$. Substituting $y = \mu/x$ gives $S\psi_n S^{-1} = \mu^n \tilde{\psi}_{-n}$. Since the state $|0\rangle$ can be thought as a semi-infinite wedge built up from the differentials $dx^{n+1/2}$ and similarly $\langle 0|$ is made up from the wedge product of $dy^{n+1/2}$ we find that

$$e^{\mathcal{F}_1} = \langle 0|S|0\rangle = \prod_{n \geq 1/2} \mu^{-n}. \quad (4.27)$$

This expression can be computed using ζ -function regularization to give the familiar answer $\mathcal{F}_1 = \frac{1}{12} \log \mu$.

In order to go beyond 1-loop, we should think in terms of \mathcal{D} -modules. The $c = 1$ \mathcal{D} -module is represented by

$$\begin{aligned}\mathcal{M} &= \mathcal{D}/\mathcal{D}P, \quad \text{with } P = -\lambda x \partial_x - \mu \text{ in } U, \\ \tilde{\mathcal{M}} &= \mathcal{D}/\mathcal{D}\tilde{P}, \quad \text{with } \tilde{P} = \lambda y \partial_y - \mu + \lambda \text{ in } V.\end{aligned}$$

Nonetheless, it is easily seen that any solution $u(x)$ of $Pu = 0$ gives a solution $v = 1/yu(y)$ of $\tilde{P}v = 0$ and vice versa. Hence \mathcal{M} and $\tilde{\mathcal{M}}$ are equivalent. Notice that the fundamental solution of $Pu = 0$ is given by $\Psi = x^{-\mu/\lambda}$. Furthermore, since any element in \mathcal{M} can be reduced to either x^m or y^m using the relation $xy = \mu$, we can represent the action of \mathcal{D} on this module as

$$\begin{aligned}\hat{x}(x^m) &= x^{m+1} \\ \hat{y}(x^m) &= \left(-\lambda \partial_x + \frac{\mu}{x}\right) x^m \\ \hat{x}(y^m) &= \left(\lambda \partial_y + \frac{\mu - \lambda}{y}\right) y^m \\ \hat{y}(y^m) &= y^{m+1}.\end{aligned}$$

A basis of a representation of \mathcal{M} on which \hat{x} and \hat{y} just act by multiplication by x resp. differentiation with respect to x is given by

$$\begin{aligned} v_{1m}(x) &= x^m \cdot x^{-\mu/\lambda}, \\ v_{2m}(x) &= \int dy e^{-xy/\lambda} y^{m-1} \cdot y^{\mu/\lambda}. \end{aligned}$$

Indeed, differentiation with respect to x clearly gives the same result as applying \hat{y} . Moreover, multiplying v_{2m} by x gives

$$x \cdot v_{2m}(x) = \lambda \int dy e^{-xy/\lambda} \frac{\partial}{\partial y} (y^{m-1+\mu/\lambda}) = (\mu + \lambda(m-1))v_{2(m-1)}.$$

Notice that if we had restricted ourselves to \mathcal{O}_Σ and taken the limit $\lambda \rightarrow 0$, we would have only found the standard basis x^m , $m \geq 0$.

Similarly, in the region V one can verify that

$$\begin{aligned} \hat{y}(y^m) &= y^{m+1} \\ \hat{x}(y^m) &= \left(\lambda \partial_x + \frac{\mu - \lambda}{x} \right) x^m \\ \hat{y}(x^m) &= \left(-\lambda \partial_y + \frac{\mu}{y} \right) y^m \\ \hat{x}(x^m) &= x^{m+1}. \end{aligned}$$

Hence in the representation of $\widetilde{\mathcal{M}}$ defined by

$$\begin{aligned} \tilde{v}_{1m}(y) &= y^{m-1} \cdot y^{\mu/\lambda}, \\ \tilde{v}_{2m}(y) &= \int dx e^{xy/\lambda} x^m \cdot x^{-\mu/\lambda}, \end{aligned}$$

y and ∂_y act in the usual way. Since we moved over to representations of the \mathcal{D} -module where the differential operator acts as we are used to, the S transformation that connects the U and the V patch and thereby exchanges \hat{x} and \hat{y} must be a Fourier transformation. This is clear from the expressions for the basis elements v and \tilde{v} : S interchanges $v_{1m}(x)$ with $\tilde{v}_{2m}(y)$, and $v_{2m}(x)$ with $\tilde{v}_{1m}(y)$. So we immediately find the result of [11].

The partition function Z of this system can now be easily computed in two ways. First exactly, to give the all-genus answer. And secondly we use the stationary phase approximation to show the relation with the previous calculations. Notice that $v_{2m}(x)$ almost equals the gamma-function $\Gamma(x) = \int_0^\infty dt e^{-t} t^{x-1}$. Indeed,

$$v_{2m}(x) = \frac{\lambda}{x} \int dy' e^{-y'} \left(\frac{\lambda y'}{x} \right)^{m-1+\mu/\lambda} = \left(\frac{\lambda}{x} \right)^{m+\mu/\lambda} \Gamma(m + \mu/\lambda).$$

Comparing this with $\tilde{v}_{1m}(y)$ implies that the free energy \mathcal{F} equals

$$\mathcal{F}(\mu, \lambda) = \sum_{m \geq 0} \left(m + \frac{\mu}{\lambda}\right) \log \left(\frac{\lambda}{\mu}\right) + \log \Gamma(m + \mu/\lambda).$$

This function satisfies the recursion relation

$$\mathcal{F}\left(\frac{\mu}{\lambda} + \frac{1}{2}\right) - \mathcal{F}\left(\frac{\mu}{\lambda} - \frac{1}{2}\right) = \left(\frac{1}{2} - \frac{\mu}{\lambda}\right) \log \left(\frac{\lambda}{\mu}\right) - \log \Gamma\left(\frac{\mu}{\lambda} - \frac{1}{2}\right),$$

from which we conclude (see Appendix A in [13]) that \mathcal{F} is the well-known answer for the $c = 1$ string, up to linear terms in μ and λ .

$$\mathcal{F}_{c=1}(\mu, \lambda) = \frac{1}{4} \int \frac{dt}{t} \frac{e^{-it(\frac{\mu}{\lambda})}}{\sinh^2(t/2)} + \text{Pol}_1(\mu, \lambda)$$

which indeed reproduces (4.25). In particular, we also recover \mathcal{F}_1 from equation (4.27).

To reproduce the λ expansion we can approximate the full genus answer using the Euler-Maclaurin formula or apply the stationary phase approximation to v_{2m} . This yields as zeroth order contribution to v_{2m}

$$e^{-\mu/\lambda} \left(\frac{\mu}{x}\right)^{m-1+\mu/\lambda},$$

while the subdominant contribution is given by

$$\sqrt{\frac{2\pi\lambda\mu}{x^2}}.$$

So in total we find that

$$v_{2m}(x) = \sqrt{2\pi\lambda} (\mu/e)^{\mu/\lambda} x^{\mu/\lambda} \mu^{m-1/2} x^{-m} \psi_{qu}\left(\frac{\mu}{x}\right),$$

which summarizes the contributions we found before, genus zero $x^{\mu/\lambda}$ and genus one $\mu^{m-1/2}$, plus the higher order contributions that are collected in ψ_{qu} .

4.4 The topological vertex

An important step to understand more general curves is the case of the topological vertex [64]. Its mirror is a genus zero curve with three punctures given by the equation

$$x + y - 1 = 0$$

in $\mathbb{C}^* \times \mathbb{C}^*$. In this case the symplectic form is given by $du \wedge dv$ where u, v are logarithmic coordinates: $x = e^u$ and $y = e^v$. The corresponding \mathcal{D} -module is now given by the operator [11]

$$P = e^u + e^{-\lambda \partial_u} - 1.$$

P is actually a difference operator, instead of a differential operator, so we have to generalize the notion of a \mathcal{D} -module somewhat. This is a well-known procedure in the field of quantum groups. These quantum groups appear because in the \mathbb{C}^* case the operators \hat{x} and \hat{y} now satisfy the Weyl algebra or q -commutation relation

$$\hat{x} \hat{y} = q \hat{y} \hat{x}, \quad q = e^\lambda.$$

The fundamental solution to $P\Psi = 0$ is the quantum dilogarithm

$$\Psi(u) = \prod_{n=1}^{\infty} \frac{1}{(1 - e^u q^n)}.$$

The corresponding module \mathcal{M} for the Weyl algebra can again be written in terms of the coordinate u or in terms of the dual variable v . There is another unitary map U that implements this transformation on the free fermion fields. Because of the hidden cyclic symmetry of the vertex, this can be made transparent by writing it as

$$e^{u_1} + e^{u_2} + e^{u_3} = 0.$$

Up to an overall rescaling of the three variables u_i , the map U satisfies $U^3 = 1$. This line of reasoning leads one directly to the formalism of [11], but we will not pursue this here in more detail. We reach the important conclusion that the notion of a quantum curve, as expressed in the concept of a (generalized) \mathcal{D} -module, is the right framework to derive the complicated transformations of [11]. We will now use this correspondence in two concrete examples of compact curves.

4.5 Elliptic curves

A well-studied example is the geometry mirror to the total space of a rank two bundle over an elliptic curve

$$\tilde{X} : \mathcal{O}(-r) \oplus \mathcal{O}(r) \rightarrow T^2. \tag{4.28}$$

The latter has a description in toric geometry as glueing the toric propagator to itself with a framing factor r . This changes the intersection of $[T^2]$ with the 4-cycles that project onto T^2 into $\pm r$ [65]. In this section we show how one can use the picture we

have developed in this paper, and in particular the free fermionic systems living on the boundary of the non-commutative plane, to completely solve this model and recover the existing results for the all genus topological string amplitudes for this background.

This model has a simple interpretation in the B-model obtained after mirror symmetry. Note that we can write the geometry (4.28) as a global quotient of $\mathbb{C}^* \times \mathbb{C} \times \mathbb{C}$. If we pick toric coordinates (e^u, e^v, e^w) , the identification is

$$(u, v, w) \sim (u + t, v + ru, w - ru).$$

This transformation is an affine transformation consisting of a shift $(t, 0, 0)$ and a linear map

$$A = \begin{pmatrix} 1 & 0 & 0 \\ r & 1 & 0 \\ -r & 0 & 1 \end{pmatrix} \in SL(3, \mathbb{Z}).$$

The linear transformation A is the monodromy of the fiber, when we view this non-compact CY as a T^3 fibration. Mirror symmetry will now replace the torus fibers with their duals, and the monodromy A with the dual monodromy A^{-T} . So the B-model can be described as a quotient of the dual coordinates given by

$$(u, v, w) \sim (u + t - rv + rw, v, w).$$

In order to map this B-model to the NS 5-brane and finally the I-brane, we have to perform one more T-duality on the combination $v + w$. That coordinate is not touched by the action of the framing and it will be subsequently ignored. If we relabel the coordinates as

$$x = u, \quad y = v - w,$$

we see that this gives indeed a T^2 curve, embedded as the zero section $y = 0$ in the geometry \mathcal{B} defined as the quotient of $\mathbb{C}^* \times \mathbb{C}$ by

$$(x, y) \sim (x + t - ry, y). \tag{4.29}$$

Now the A-model topological string partition function can be computed as [65, 66]

$$Z_{top}(t, \lambda) = e^{-t^3/6r^2\lambda^2} Q^{-1/24} \sum_R Q^{|R|} q^{r\kappa_R/2},$$

where $Q = e^{-t}$ with t the Kähler parameter of the torus and $q = e^{-\lambda}$, whereas $|R|$ is the number of boxes of the corresponding Young tableaux and $\kappa_R = 2 \sum_{\square \in R} i(\square) - j(\square)$.

After the mirror transformation t becomes the modulus of the elliptic curve T^2 . The instanton part of Z_{top} can be rewritten in the form

$$Z_{qu}(t, \lambda) = \oint \frac{dy}{2\pi iy} \prod_{n=0}^{\infty} \left(1 + y Q^{n+1/2} q^{r(n+1/2)^2/2}\right) \left(1 + y^{-1} Q^{n+1/2} q^{-r(n+1/2)^2/2}\right) \quad (4.30)$$

which is familiar from [67, 68] in the case $r = 1$. In this model the genus zero answer does not have instanton contributions and so is given entirely by the classical cubic form $\mathcal{F}_0(t) = -\frac{1}{6r^2}t^3$, while at genus one the classical and quantum contributions combine into

$$\mathcal{F}_1(t) = -\log \eta(Q).$$

The g -loop contributions \mathcal{F}_g , for $g > 1$ and $r > 0$, incorporate only quantum effects.

In fact, it is well-known that this answer is reproduced by a chiral fermion field with action [69]

$$S = \frac{1}{\pi} \int_{T^2} d^2x \psi^\dagger (\bar{\partial} - r\lambda \partial^2) \psi. \quad (4.31)$$

We will rederive this same answer from the fermionic perspective we have developed in this paper below. For now note that this action can be bosonized into [68, 70]

$$S = \frac{1}{\pi} \int_{T^2} d^2x \left(\frac{1}{2} \partial\phi \bar{\partial}\phi - \frac{r\lambda}{6} (\partial\phi)^3 \right), \quad (4.32)$$

which is closely related to the Kodaira-Spencer field theory on the Calabi-Yau manifold. This Kodaira-Spencer theory reduces to a free boson ϕ on a cylinder, while the framing quantizes into an action of the zero mode of the W^3 operator [11]

$$W_0^3 = \oint dx \frac{(\partial\phi)^3}{3}.$$

This implies that W_0^3 defines how to glue the torus quantum mechanically,

$$Z_{top} = \text{Tr} \exp \left(-\frac{r\lambda}{2} W_0^3 \right),$$

explaining (4.32). The action of W_0^3 is quadratic in the fermions and therefore acts on the single fermion states.

The topological string partition function (4.30) is obtained as the fermion number zero sector. Including also a sum over the $U(1)$ flux gives the full fermion partition function that corresponds to the I-brane. This can be thought of as a generalized Jacobi triple

formula [71]. Adding the classical contributions we obtain

$$\begin{aligned}
Z(v, t, \lambda) &= e^{-t^3/6r^2\lambda^2} Q^{-1/24} \prod_{n=0}^{\infty} (1 + yQ^{n+1/2}q^{r(n+1/2)^2/2})(1 + y^{-1}Q^{n+1/2}q^{-r(n+1/2)^2/2}) \\
&= \sum_{p=-\infty}^{\infty} y^p e^{-t^3/6r^2\lambda^2} e^{-pt^2/2r\lambda} Q^{p^2/2-1/24} q^{rp^3/6-rp/24} Z_{qu}(t + rp\lambda, \lambda) \\
&= \sum_{p=-\infty}^{\infty} y^p Z_{top}(t + rp\lambda, \lambda).
\end{aligned}$$

In the second line we have extracted a factor $e^{-t^2/2r\lambda}$ out of y . This is the result of turning on flux in the I-brane set-up, and corresponds to the D4-brane tension on the BPS side. Notice that the combination $rp \in r\mathbb{Z}$. This is because rp is the Poincaré dual of the four-cycle having intersection number $\pm r$ with $[T^2]$. So this reproduces indeed formula (3.16) with an appropriate choice of cubic form. For $r = 0$ this result reduces to the standard Jacobi triple formula

$$Z_{r=0} = \frac{\theta_3(y, Q)}{\eta(Q)} = \sum_{n \in \mathbb{Z}} \frac{Q^{n^2/2} y^n}{\eta(Q)}.$$

We now come to deriving (4.31) from the perspective of this paper. From the considerations of this paper it is clear that we have a free fermion system living on T^2 with the *standard* action. The only subtlety has to do with the fact that T^2 is at the boundary of a non-commutative plane and as we will see this is crucial in recovering (4.31). From (4.29) we see that $x \sim x + t - ry$. If we treated y as commuting with x we could set it to $y = 0$ and we have a copy of the torus. But here we know that y does not commute with x . So we have a free fermion on a torus where the modulus is changed from

$$t \rightarrow t - ry.$$

The variation of t can be absorbed into the fermionic action by the usual Beltrami differential $\mu_{\bar{z}}^z = \delta t$:

$$S = \frac{1}{\pi} \int_{T^2} d^2x \psi^\dagger (\bar{\partial} + \mu\partial) \psi.$$

Here we need to substitute $\mu = \delta t = -ry$. In the classical case where y is commuting, this would give $\mu = 0$ and we get the same system as the usual fermions. However, since x and y do not commute, we should view $y = \lambda\partial_x$ leading to $\mu = -ry = -r\lambda\partial_x$. Substituting this operator for μ in the above action reproduces (4.31). We have thus rederived the known result for the topological string in this background from our framework.

4.6 Genus two curves

An interesting generalization of the elliptic curve example is given by a B-model geometry containing a genus two curve. This model can be constructed using the topological vertex technology. Although the vertex technology is able to deal with arbitrary curves, it might be instructive to see this explicit case in more detail.

Let us start in the A-model with the toric diagram of the resolved conifold $\mathcal{O}(-1) \oplus \mathcal{O}(-1) \rightarrow \mathbb{P}^1$ and identify the two pairs of parallel external legs, as shown in fig. 6. We refer to this geometry as \tilde{X} . The B-model geometry corresponding to \tilde{X} is a locally elliptic Calabi-Yau X , described by an equation of the form $uv = P(x, y)$, where P vanishes on some compact genus two Riemann surface Σ .

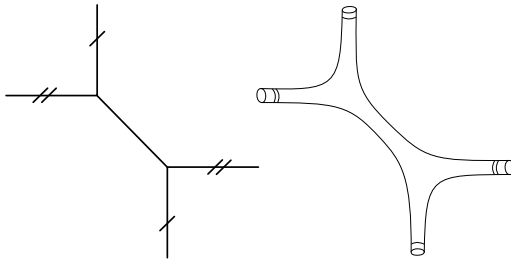

Fig. 6: *The resolved conifold with identified legs (left) and its mirror (right).*

This B-model geometry is well-studied in [10] as an example of an elliptic threefold geometrically engineering a six-dimensional gauge theory on $\mathbb{R}^4 \times T^2$. The prepotential of this gauge theory is computed as the A-model partition function of \tilde{X} . Since this is a topological vertex calculation, the all-genus partition function is known. Moreover, instanton calculus in the six-dimensional gauge theory shows that it can be elegantly rewritten in terms of the equivariant elliptic genus of an instanton moduli space. The equivariant parameter q equals $e^{-\lambda}$ on the A-model side.

Explicitly, the A-model on \tilde{X} can be expressed in topological vertices as

$$Z_{qu}(Q_1, Q_2, Q_3) = \sum_{R_1, R_2, R_3} Q_1^{R_1} Q_2^{R_2} Q_3^{R_3} (-)^{l_{R_1} + l_{R_2} + l_{R_3}} C_{R_1 R_2 R_3} C_{R_1^t R_2^t R_3^t},$$

where Q_i represent the exponentiated Kähler classes of the legs with attached $U(N)$ representations R_i , and where $C_{R_1 R_2 R_3}$ is the topological vertex. Notice that $C_{R_1 R_2 R_3}$ is symmetric under permutations of the R_i , while in terms of the toric graph it is more natural to use the variables

$$Q_\sigma := Q_2 Q_3, \quad Q_\rho := Q_1 Q_3, \quad Q_\nu = Q_3,$$

that exhibit the \mathbb{Z}_2 symmetry between Q_σ and Q_ρ . Using these definitions

$$Z_{qu}(q, \rho, \sigma, \nu) = \sum_R Q_\rho^{l_R} \prod_{\square \in R} \frac{(1 - Q_\nu q^{h(\square)})(1 - Q_\nu^{-1} q^{h(\square)})}{(1 - q^{h(\square)})^2} \\ \times \prod_{k=1}^{\infty} \frac{(1 - Q_\sigma^k Q_\nu q^{h(\square)})(1 - Q_\sigma^k Q_\nu q^{-h(\square)})(1 - Q_\sigma^k Q_\nu^{-1} q^{h(\square)})(1 - Q_\sigma^k Q_\nu^{-1} q^{-h(\square)})}{(1 - Q_\sigma^k q^{h(\square)})^2 (1 - Q_\sigma^k q^{-h(\square)})^2 (1 - Q_\sigma^k)}.$$

And this may be rewritten as [72]

$$Z_{qu}(q, \rho, \sigma, \nu) = \sum_{k \geq 0} Q_\rho^k \chi((\mathbb{C}^2)^{[k]}; Q_\sigma, Q_\nu)(q, q^{-1}) \quad (4.33) \\ = \prod_{j \in (\mathbb{Z}/2)_{\geq 0}} \prod_{\substack{a, k \geq 0, \\ c, l \geq 1}} \prod_{b = -j}^j \left(\frac{(1 - Q_\rho^l Q_\sigma^a Q_\nu^{c-1} q^{2b+k+1})(1 - Q_\rho^l Q_\sigma^a Q_\nu^{c+1} q^{2b+k+1})}{(1 - Q_\rho^l Q_\sigma^a Q_\nu^c q^{2b+k+2})(1 - Q_\rho^l Q_\sigma^a Q_\nu^c q^{2b+k})} \right)^{(k+1)C(a, j, c)}$$

with $b = -j, -j+1, \dots, j-1, j$ and $q = e^{-\lambda}$, whereas the coefficients $C(a, j, c)$ are related to the equivariant elliptic genus of \mathbb{C}^2 in the following way

$$\chi(\mathbb{C}^2, y, p, q) = \prod_{n \geq 1} \frac{(1 - yp^n q)(1 - y^{-1} p^n q^{-1})(1 - yp^n q^{-1})(1 - y^{-1} p^n q)}{(1 - p^n q)(1 - p^n q^{-1})(1 - p^n q^{-1})(1 - p^n q)} \\ = \sum_{a \geq 0} \sum_{j \in (\mathbb{Z}/2)_{\geq 0}, c \in \mathbb{Z}} C(a, j, c) p^a (q^{2j} + q^{2(j-1)} + \dots + q^{-2j}) y^c.$$

Starting with the IIA background $TN_1 \times \tilde{X}$ and going backwards through the duality chain, we find ourselves in the I-brane set-up on $\mathbb{R}^3 \times T^4 \times \mathbb{R}^2 \times S^1$. The genus two curve Σ is holomorphically embedded in the abelian surface T^4 by the Abel-Jacobi map. The I-brane is the intersection of a D4-brane wrapping $\mathbb{R}^3 \times \Sigma$ and a D6-brane wrapping $T^4 \times \mathbb{R}^2 \times S^1$. The aim of this section is to give an interpretation of the above A-model result on \tilde{X} in the I-brane picture.

The case $\lambda = 0$

As a result of the duality chain, we expect that the 1-loop free energy $\mathcal{F}_{1, \text{top}}$ of the topological A-model yields the free energy $\mathcal{F}_{1, \text{boson}} = -\frac{1}{2} \log \det \Delta_\Sigma$ of a free chiral boson on Σ . Another sum over the lattice of momenta should then result in the chiral fermion determinant. Since not only the A-model partition function, but also the partition function of chiral bosons on a genus two surface is known, we can perform an explicit check of these conjectures.

The genus two curve Σ can be given explicitly as the zero locus of a generalized theta-function on T^4 [10], and its 2×2 period matrix is expressed in terms of the mirror

Kähler moduli $\{\rho, \sigma, \nu\}$. Twenty-four chiral bosons on Σ are described by $\Phi_{10}(\rho, \sigma, \nu)$, the unique automorphic form of weight 10 of $Sp(2, \mathbb{Z})$ [73, 74]. The partition function of a single chiral boson may be written as the generating function of the elliptic genus of a symmetric product of TN_1 's [75]

$$\begin{aligned} Z_{boson}(\rho, \sigma, \nu) &= \frac{1}{\Phi_{10}(\rho, \sigma, \nu)^{1/24}} = \sum_N e^{2\pi i N \sigma} \chi_{\rho, \nu}(TN_1^N/S_N) \\ &= e^{-\pi i(\rho + \sigma + \nu)/12} \prod_{(k, l, m) > 0} (1 - e^{2\pi i(k\rho + l\sigma + m\nu)})^{-c(4kl - m^2)}. \end{aligned} \quad (4.34)$$

The numbers $c(4kl - m^2) \in \mathbb{Q}$ are defined in terms of the elliptic genus of $K3$.

$$\chi(K3, \tau, z) = \sum_{h \geq 0, m \in \mathbb{Z}} 24 c(4h - m^2) e^{2\pi i(h\tau + mz)},$$

the unique weak Jacobi form of index 1 and weight 0. Here we have used that $K3$ is generically a combination of 24 TN_1 's.

Looking back at the A-model partition function (4.33), it turns out that singling out the λ^0 -part yields a sum of the same form as (4.34)

$$\mathcal{F}_{1, qu}(\rho, \sigma, \nu) = \tilde{c}(kl, m) \prod_{(k, l, m)} \log(1 - e^{2\pi i(k\rho + l\sigma + m\nu)}),$$

where the coefficients $\tilde{c}(kl, m)$ are related to the Fourier coefficients $C(a, j, c)$ as

$$\begin{aligned} &\tilde{c}(kl, m) = \\ &- \sum_{j \in (\mathbb{Z}/2)_{\geq 0}} \sum_{b=-j}^j \left[\left(2b^2 - \frac{1}{12}\right) (C(kl, j, m+1) + C(kl, j, m-1)) - \left(4b^2 + \frac{5}{6}\right) C(kl, j, m) \right]. \end{aligned}$$

Actually, precisely the same relation can be found by relating the elliptic genus of $K3$ and the equivariant elliptic genus of \mathbb{C}^2 :

$$\begin{aligned} \chi(K3, y, p) &= -y^{-1} \int_{K3} x^2 \prod_{n \geq 1} \frac{(1 - yp^{n-1}q^{-1})(1 - yp^{n-1}q)(1 - y^{-1}p^n q^{-1})(1 - y^{-1}p^n q)}{(1 - p^{n-1}q^{-1})(1 - p^{n-1}q)(1 - p^n q^{-1})(1 - p^n q)} \\ &= - \int_{K3} x^2 \left(\frac{y + y^{-1} - q - q^{-1}}{A(x)A(-x)} \right) \chi(\mathbb{C}^2, y, p, q), \end{aligned} \quad (4.35)$$

with $q = e^x$ and $A(x) := \sum_{k \geq 0} \frac{x^k}{(k+1)!}$. So after adding the classical contributions to $\mathcal{F}_{1, qu}(\tilde{X})$ (proportional to the Kähler class $t = \rho + \sigma + \nu$) we may conclude that the chiral

boson determinant on Σ equals the 1-loop partition function of the B-model topological string on X

$$Z_{boson}(\rho, \sigma, \nu) = e^{\mathcal{F}_{1,top}}(\rho, \sigma, \nu).$$

In order to find the total contribution for λ small, we have to consider $\mathcal{F}_{0,top}$ as well. In the B-model on X its second derivative has a simple interpretation: it's just the period matrix τ_{ij} of the genus two curve Σ . In terms of the mirror map, these periods will have classical contributions linear in ρ, σ and τ , and quantum corrections determined by $Z_{qu}(\tilde{X})$. We will write these down in the next paragraph. Right now, let us conclude with

$$Z_{fermion}(\rho, \sigma, \nu) = \sum_{p_1, p_2 \in \mathbb{Z}} e^{\pi i p_i \tau_{ij} p_j} e^{\mathcal{F}_{1,top}}(\rho, \sigma, \nu).$$

Automorphic properties

Knowing the full instanton partition function (4.33) makes it possible to examine the λ -corrections to $\mathcal{F}_{1,top}$ explicitly. In fact, let us start more generally with the Gopakumar-Vafa partition function

$$Z_{qu} = \prod_{\Sigma \in H_2} \prod_{j \in \mathbb{Z}/2} \prod_{b=-j}^j \prod_{k=1}^{\infty} (1 - q^{2b+k} Q^\Sigma)^{(-1)^{2j+1} k N_\Sigma^{2j}}.$$

In order to get the g -loop free energies we note that

$$\begin{aligned} \log \prod_{m \geq 1} (1 - Y q^{m+l})^m &= \\ &= -\frac{1}{\lambda^2} \text{Li}_3(Y) + \frac{1}{2} (l^2 - \frac{1}{6}) \log(1 - Y) - \lambda^2 \left(\frac{1}{240} - \frac{l^2}{24} + \frac{l^4}{24} \right) \text{Li}_{-1}(Y) - \dots \\ &=: -\sum_{g \geq 0} \lambda^{2g-2} P_{2g}(l) \sum_{n \geq 1} n^{2g-3} Y^n, \end{aligned}$$

where the degree $2g$ polynomials $P_{2g}(l)$ are defined through the last equality. Hence

$$\mathcal{F}_{qu} = -\sum_{g \geq 0} \lambda^{2g-2} \sum_{\Sigma \in H_2} \sum_{j \in \mathbb{Z}/2} \sum_{b=-j}^j (-1)^{2j+1} P_{2g}(2b) N_\Sigma^{2j} \sum_{n=1}^{\infty} n^{2g-3} (Q^\Sigma)^n.$$

Making this expansion for the genus two Calabi-Yau X reveals that the coefficients

$$c_\Sigma^g = \sum_{j \in \mathbb{Z}/2} \sum_{b=-j}^j (-1)^{2j+1} P_{2g}(2b) N_\Sigma^{2j}$$

are the Fourier coefficients of Jacobi forms $J_g(q, y) = \sum_{k,l} c_g(k, l) q^k y^l$ of weight $2g - 2$ and index 1. More precisely, we can write the \mathcal{F}_g 's as

$$\begin{aligned}
\mathcal{F}_g(\lambda; Q_\rho, Q_\sigma, Q_\nu) &= -\lambda^{2g-2} \sum_{k,l,m} c_g(kl, m) \sum_{n \geq 1} n^{2g-3} (Q_\rho^k Q_\sigma^l Q_\nu^m)^n \\
&= - \sum_{N \geq 0} Q_\rho^N \sum_{kn=N} n^{2g-3} \sum_{l \geq 0, m} c_g(kl, m) Q_\sigma^{ln} Q_\nu^{mn} \\
&= - \sum_{kn=N} N^{2g-3} \sum_{b=0, \dots, k-1} k^{2-2g} Q_\rho^N J_g \left(\frac{n\sigma + b}{k}, n\nu \right) \\
&= - \sum_{N \geq 0} Q_\rho^N T_{g,N}(J_g),
\end{aligned}$$

where $T_{g,N}$ are Hecke operators acting on Jacobi forms of weight $2g - 2$. This implies that all $\mathcal{F}_{g,top}$'s are lifts of Jacobi forms, and therefore automorphic forms of $O(3, 2, \mathbb{Z}) = Sp(4, \mathbb{Z})$ [76].

Interpretation in the duality chain

First of all, notice that the partition function of \tilde{X} can be build out of topological vertices, and as such is known to have an interpretation in terms of chiral bosons and fermions [64, 11, 77, 78]. The duality chain elucidates these observations: the chiral fermions can be identified with the intersecting brane fermions. Moreover, the B -field on the D6-brane makes it necessary to treat these fermions as noncommutative objects, which gives an explanation for the nontrivial transformation properties in [11].

In terms of the gauge theory picture we can just refer to [10]. Here it is shown that the six dimensional gauge theory on $TN_1 \times T^2$ can be engineered with matrix model techniques, revealing Σ as the Seiberg-Witten curve, whose period matrix equals the second derivative of $\mathcal{F}_{0,top}$.

Finally, the automorphic properties of \mathcal{F}_{top} seems to fit in best in the M5-brane frame of the duality chain. Recall that S-duality relates IIB on $TN_1 \times X$ to a NS5-brane wrapping around $TN_1 \times \Sigma$ in the background $TN_1 \times T^4 \times \mathbb{R}^2$. This lifts to a M5-brane in M-theory on $TN_1 \times T^4 \times \mathbb{R}^2 \times S^1$. Since the M5-brane partition function is expected to be an automorphic form of $O(3, 2, \mathbb{Z})$ [79], this perspective offers a physical reason for the automorphic properties.

Actually, we know exactly which Jacobi forms enter: $J_0 = \phi_{-2,1}$ is the unique Jacobi form of weight -2 and index 1, $J_1 = -\frac{1}{12}\phi_{0,1} = -\frac{1}{24}\chi(K3, q, y)$ as we encountered before, $J_2 = \frac{1}{240}E_4\phi_{-2,1}$, $J_3 = -\frac{1}{6048}E_6\phi_{-2,1}$ and $J_4 = \frac{1}{172800}E_4^2\phi_{-2,1}$ etc. Interestingly, these can

all be defined as twisted elliptic genera of TN_1 in the sense that (compare with (4.35))

$$J_g(q, y) = -y^{-1} \int_{TN_1} x^{4-2g} \prod_{n \geq 1} \frac{(1 - yp^{n-1}q^{-1})(1 - yp^{n-1}q)(1 - y^{-1}p^nq^{-1})(1 - y^{-1}p^nq)}{(1 - p^{n-1}q^{-1})(1 - p^{n-1}q)(1 - p^nq^{-1})(1 - p^nq)},$$

coinciding with the M5-brane point of view and longing for a two dimensional conformal field theory interpretation.

5 Summary and outlook

In this paper we have provided a unifying point of view on various four-dimensional supersymmetric gauge theories, by relating them to two-dimensional conformal field theories and free fermion systems. This is accomplished by realizing the supersymmetric gauge theories as a system of D4 and NS5-branes, which can be lifted to an M5-brane configuration. By reducing this M5-brane to the so-called I-brane, i.e. a system of D4 and D6-branes intersecting along a spectral curve Σ , the free fermions arise as massless states of open strings living on Σ . This curve plays a fundamental role in our considerations, and in particular it encodes much information about gauge theories. First of all, it relates to a number of supersymmetries in gauge theories: $\mathcal{N} = 4$ theories arise for $\Sigma = T^2$, while $\mathcal{N} = 2$ theories for curved Σ .

If the number k of D6-branes in the I-brane configuration is larger than one, the world-volume of the corresponding gauge theory is related to a non-trivial ALE space of A_{k-1} type. This fact proved very useful while re-examining the connection between $\mathcal{N} = 4$ theories and conformal field theories, originally discovered by Nakajima [16] and further explained by Vafa and Witten as a consequence of the S-duality [2]. In particular, we showed that the full I-brane partition function is given simply by the fermionic character, which reduces to the Nakajima-Vafa-Witten results upon decoupling in the gauge theory limit. This perspective also allowed us to derive the McKay correspondence from a string-theory perspective.

In the analysis of $\mathcal{N} = 2$ theories from the I-brane viewpoint it was crucial to realize that the curve Σ becomes non-commutative, with coordinates becoming operators satisfying

$$[\hat{x}, \hat{y}] = \lambda,$$

while the non-commutativity parameter λ gets identified with a value of NS B -field turned on along the D6-brane. Starting from the I-brane with a single D6-brane we presented

a duality chain which relates it to the B-model topological strings on a local elliptic Calabi-Yau defined by an equation of the form

$$uv + P(x, y) = 0.$$

Simultaneously, the locus $P(x, y) = 0$ represents the I-brane curve Σ embedded in a non-commutative plane. This enables an interpretation of the all-genus topological string partition function in terms of physical non-commutative free fermions which only have support on Σ , and, mathematically, leads us to their formulation in terms of holonomic \mathcal{D} -modules. The relation to \mathcal{D} -modules provides an elegant explanation of unusual transformation properties of those fermions resembling Fourier transformations, and allows them to be identified with the fermions introduced in [11], thereby realizing the latter ones from a physical string-theoretic point of view.

* * *

There are various open problems related to the results described above, which we hope to address in the future. Let us name just a few of them. First of all, we only considered gauge theories with extended supersymmetry. However it would be interesting to connect also $\mathcal{N} = 1$ theories to I-brane configurations. This should be possible, especially in view of the fact that relations between $\mathcal{N} = 1$ theories and topological strings are already well-understood [4]. Even more appealing would be to understand metastable non-supersymmetric gauge theories in terms of I-branes [80, 81]. For example they can be realized in a system of D4- $\overline{\text{D4}}$ branes spanned between NS5-branes [82], which could be implemented into one duality frame arising in our considerations.

Secondly, it would be interesting to extend the analysis of curved I-branes to cases with more than just a single D6-brane. In particular it might shed some light on a connection between topological strings and Donaldson-Thomas invariants, so far understood only in case of a single D6-brane wrapped on a Calabi-Yau manifold — which is the configuration ending the duality chain described in section 3.2. Understanding the physics of an arbitrary number of wrapped D6-branes would extend known relations between Donaldson-Thomas, Pandharipande-Thomas [83], Gopakumar-Vafa and Gromov-Witten invariants and could give a deeper understanding of them.

Furthermore, more general geometries on which gauge theories are defined could be analyzed, together with corresponding I-brane configurations. In this paper we focused mainly on $U(N)$ gauge theories on Taub-NUT geometries, and explained how replacing them by Atiyah-Hitchin spaces relates to a presence of orientifold planes in the I-brane

system and leads to Sp/SO gauge groups. Those $U/Sp/SO$ gauge groups are intimately related to various affine Lie algebras, realized in terms of free fermions on the I-brane. However, as shown in [38], there is a long list of affine Lie algebras which can be realized in terms of free fermions. Is it possible to engineer I-brane configurations which would support all those kinds of fermions and Lie groups?

On the other hand, we might consider further examples of target space curves, either using orbifold techniques and making contact with vast literature on CHL orbifolds [84, 85], or by considering toric curves of higher genus. So far we have succeeded in writing down the I-brane action for a propagator in a toric geometry, but not yet for a three-vertex. It would be nice to be able to explain the genus two example from such a perspective.

Finally, we have just made a first step in uncovering the relevance of \mathcal{D} -modules in string theory. Of course, these objects have already entered the field through the Langlands program [54], where they relate to eigenbranes of the 't Hooft operator in the four-dimensional twisted gauge theory. However, in that context the \mathcal{D} -modules appear as non-commutative structures on coisotropic branes in the A-model, whereas our set-up is purely physical and holomorphic.

Let us here make a few more remarks about the relation of \mathcal{D} -modules with integrable hierarchies. Recall that solutions of the KP hierarchy can be written down in the form of elements $W = w_1 \wedge w_2 \wedge \dots$ of a Grassmannian. They are characterized by their index, which is determined by the projection of the subspace onto the vacuum. The big cell is a dense subset of the index zero Grassmannian and contains those elements that project bijectively onto the Dirac vacuum. A dense subset of the big cell admits a geometrical description in terms of a torsion-free sheaf \mathcal{E} on an algebraic curve Σ , together with a trivialization of both Σ and \mathcal{E} at some point x_∞ . This is called the Krichever correspondence. Holomorphic sections of \mathcal{E} on Σ/x_∞ determine an element W of the Grassmannian. Since these sections can be interpreted as fermions ψ living on Σ , V is the subspace that ψ sweeps out in the Hilbert space $L^2(S^1)$. Their index being zero means that there are as many excitations as gaps. The tau-function of the hierarchy in these cases has the interpretation as the fermion determinant $\det \bar{\partial}_{\mathcal{E}}$.

Interestingly, examples as Hermitean matrix models are part of the big cell, but not of this dense subset. From our I-brane perspective we expect that, in analogy to the case of classical free fermions on a Riemann surface, the total topological partition function should be given by some generalized determinant of non-commutative fermions, reducing to the usual fermion determinant when $\lambda = 0$. It would be exciting to find such a generalization.

Yet another remark is that it is well-known that the total big cell has an interpretation in terms of a class of \mathcal{D} -modules \mathcal{M} on a disk; by localizing the \mathcal{D} -module \mathcal{M} at x_∞ we find an element W of the big cell. In the work of Ben-Zvi and Nevins [86] this picture is extended (with so-called \mathcal{D} -lattices) and the notion of a corresponding Lax operator K (with the help of micro-operators) to the whole Grassmannian. This led them to studying \mathcal{D} -bundles on curves and paved the way for a natural relation with Calogero-Moser systems. However, the \mathcal{D} -bundles they introduce can be seen as non-commutative analogues of torsion-free sheaves on a ruled surface, whose support covers all of this surface. This is unlike the \mathcal{D} -modules we encounter, which just have their support on the spectral curve Σ . Still, this might be an interesting arena to explore further.

And lastly, it would be great to connect to recent developments by Eynard, Marino and others (see e.g. [77, 78]), who formulate the B-model on locally elliptic Calabi-Yau's given by an equation of the form $uv = P(x, y)$ in terms of a simple recursion relation. This formalism, that is closely related to the Kodaira-Spencer formulation of the B-model, can be viewed as the bosonized version of our fermionic formulation. It would be interesting to understand this non-commutative version of the familiar boson/fermion correspondence and its interpretation in terms of \mathcal{D} -modules in more detail.

Acknowledgments

We would like to thank M. Aganagic, D. Ben-Zvi, S. Cherkis, B. Eynard, J. Manschot, W. Nahm, M. Rocek, G. Segal, E. Verlinde, E. Witten for discussions.

We would like to thank the 5th Simons Workshop in Mathematics and Physics at Stony Brook (C.V. and R.D.) and the Aspen Center for Physics (R.D.) for inspiring surroundings and discussions. The research of R.D., L.H. and P.S. was supported by a NWO Spinoza grant and the FOM program *String Theory and Quantum Gravity*. P.S. was also supported by MNiSW grant N202-004-31/0060. The research of C.V. was supported in part by NSF grants PHY-0244821 and DMS-0244464.

A Level-rank duality and $U(Nk)_1$ decomposition

The affine algebras $\widehat{su}(N)_k$ and $\widehat{su}(k)_N$ are related by the so-called level-rank duality [18, 36, 87, 32, 37], which maps to each other orbits of their irreducible integrable representations under outer automorphism groups. Let us explain this in more detail. The Dynkin diagram of $\widehat{su}(N)_k$ consists of N nodes permuted in a cyclic order by the outer automorphism group \mathbb{Z}_N . This induces also an action on affine irreducible integrable representations. There are

$$\frac{(N+k-1)!}{(N-1)!k!} \quad (\text{A.36})$$

such representations of $\widehat{su}(N)_k$, which can be identified in a standard way with Young diagrams ρ with at most $N-1$ rows and at most k columns. We denote the set of such diagrams by $\mathcal{Y}_{N-1,k}$. In particular, the generator of the outer automorphism group σ_N , the so-called basic outer automorphism, has a simple realization in terms of a Young diagram $\rho = (\rho_1, \dots, \rho_{N-1})$ corresponding to a given integrable representation. The action of σ_N amounts to adding a row of length k as a first row of ρ , and then reducing the diagram, *i.e.* removing ρ_{N-1} columns which acquired a length N (so that indeed $\sigma_N(\rho) \in \mathcal{Y}_{N-1,k}$),

$$\sigma_N(\rho_1, \dots, \rho_{N-1}) = (k - \rho_{N-1}, \rho_1 - \rho_{N-1}, \dots, \rho_{N-2} - \rho_{N-1}). \quad (\text{A.37})$$

It follows that $\sigma_N^N(\rho) = \rho$, as expected for \mathbb{Z}_N symmetry. All N irreducible integrable representations related by an action of σ_N constitute an orbit denoted as $[\rho] \subset \mathcal{Y}_{N-1,k}$. As an example, the \mathbb{Z}_4 orbit generated from $\widehat{su}(4)_3$ irreducible integrable representation corresponding to a diagram $\rho = (2, 1) \in \mathcal{Y}_{3,3}$ is given by

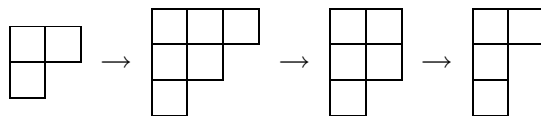

The number of such \mathbb{Z}_N orbits is given by (A.36) divided by N . For both $\widehat{su}(N)_k$ and $\widehat{su}(k)_N$ this number is the same, therefore a bijection between orbits of their integrable irreducible representations exists. The level-rank duality is a statement that for $\widehat{su}(N)_k$ orbit represented by a diagram $\rho \in \mathcal{Y}_{N-1,k}$ there is a canonical bijection realized as

$$\begin{aligned} \mathcal{Y}_{N-1,k} \supset [\rho] &= \{\sigma_N^j(\rho) \mid j = 0, \dots, N-1\} \mapsto \\ &\mapsto \{\sigma_k^a(\rho^t) \mid a = 0, \dots, k-1\} = [\rho^t] \subset \mathcal{Y}_{k-1,N}, \end{aligned} \quad (\text{A.38})$$

where t denotes a transposition and a diagram ρ^t should be reduced (*i.e.* all columns of length k should be removed if ρ_1 was equal to k).

The level-rank duality can also be formulated in terms of the embedding

$$\widehat{u}(1)_{Nk} \times \widehat{su}(N)_k \times \widehat{su}(k)_N \subset \widehat{u}(Nk)_1.$$

The $\widehat{u}(Nk)_1$ affine Lie algebra can be realized in terms of Nk free fermions, so that their total Fock space $\mathcal{F}^{\otimes Nk}$ decomposes under this embedding as

$$\mathcal{F}^{\otimes Nk} = \bigoplus_{\rho} U_{\|\rho\|} \otimes V_{\rho} \otimes \widetilde{V}_{\widetilde{\rho}}, \quad (\text{A.39})$$

where $U_{\|\rho\|}$, V_{ρ} and $\widetilde{V}_{\widetilde{\rho}}$ denote irreducible integrable representations of $\widehat{u}(1)_{Nk}$, $\widehat{su}(k)_N$, and $\widehat{su}(N)_k$ respectively. In the above decomposition only those pairs $(\rho, \widetilde{\rho})$ arise, which represent orbits mapped to each other by the duality (A.38). For a given $\widehat{su}(N)_k$ orbit $[\rho]$ represented by ρ , these pairs are therefore of the form $(\sigma_N^j(\rho), \sigma_k^a(\rho^t))$, where σ_N and σ_k are appropriate outer automorphism groups. The $U(1)$ charge corresponding to such a pair is $\|\rho\| = (|\rho| + jk + aN) \bmod Nk$, where $|\rho|$ is the number of boxes in the Young diagram ρ . With such identifications, the decomposition (A.39) can be written in terms of characters as [37]

$$\chi^{\widehat{u}(Nk)_1}(u, v, \tau) = \sum_{[\rho] \subset \mathcal{Y}_{N-1, k}} \sum_{j=0}^{N-1} \sum_{a=0}^{k-1} \chi_{|\rho|+jk+aN}^{\widehat{u}(1)_{Nk}}(N|u| + k|v|, \tau) \chi_{\sigma_N^j(\rho)}^{\widehat{su}(N)_k}(\bar{u}, \tau) \chi_{\sigma_k^a(\rho^t)}^{\widehat{su}(k)_N}(\bar{v}, \tau). \quad (\text{A.40})$$



Here $u = (u_j)_{j=1 \dots N}$ are elements of the Cartan subalgebra of $u(N)$, $|u| = \sum_j u_j$ and \bar{u} denotes the traceless part. Similarly $v = (v_a)_{a=1 \dots k}$ are elements of Cartan subalgebra of $u(k)$. $\chi_{\rho}^{\widehat{su}(N)_k}(\bar{u}, \tau)$ are characters of $\widehat{su}(N)_k$ at level k for an integrable irreducible representation specified by a Young diagram ρ , and $\chi_j^{\widehat{u}(1)_N}$ characters are defined as

$$\chi_j^{\widehat{u}(1)_N}(z, \tau) = \frac{1}{\eta(q)} \sum_{n \in \mathbb{Z}} q^{\frac{N}{2}(n+j/N)^2} e^{2\pi i z(n+j/N)}$$

for $q = e^{2\pi i \tau}$.

As an example of a decomposition (A.39) let us consider the case of $\widehat{u}(1)_{12} \times \widehat{su}(4)_3 \times \widehat{su}(3)_4 \subset \widehat{u}(12)_1$, with $N = 4$ and $k = 3$. From (A.36) we deduce there are 5 orbits of outer automorphism groups \mathbb{Z}_4 and \mathbb{Z}_3 . Let us consider $\widehat{su}(4)_3$ integrable representation related to a diagram $\rho = \square$, and the corresponding $\widehat{su}(3)_4$ diagram $\rho^t = \square$. The two orbits under σ_4 and σ_3 are shown respectively in the first row and column of a table below. All 12 pairs of representations appear in the decomposition (A.39) with $\widehat{u}(1)_{12}$ charges given in the table. Note that acting with σ_4 takes us to another pair of weights given by a step

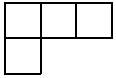
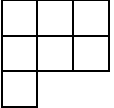
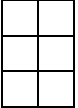
to the right in the table, and increases $\widehat{u}(1)_{12}$ charge by 3 (modulo 12). The action of σ_3 takes us a step to the bottom in the table and increases $\widehat{u}(1)_{12}$ charge by 4 (modulo 12). Of course the same table would be generated if we started building it from any other element of these two orbits.

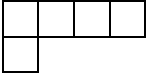
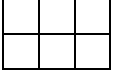
	→		→		→	
	1	4	7	10		
	5	8	11	2		
	9	0	3	6		

Pairs of $\widehat{su}(4)_3 \times \widehat{su}(3)_4$ integrable weights with the same fixed $\widehat{u}(1)_{12}$ charge arising in the decomposition of $\widehat{u}(12)_1$ are easily found if all 5 such tables of orbits are drawn. For example for charge 0 we then get

$$\begin{aligned}
 & \bullet \otimes \bullet + \begin{array}{|c|c|c|} \hline \square & \square & \square \\ \hline \square & & \end{array} \otimes \begin{array}{|c|c|c|} \hline \square & \square & \square \\ \hline \square & \square & \square \\ \hline \end{array} + \begin{array}{|c|c|} \hline \square & \square \\ \hline \square & \square \\ \hline \end{array} \otimes \begin{array}{|c|c|c|c|} \hline \square & \square & \square & \square \\ \hline \square & \square & & \end{array} + \\
 & + \begin{array}{|c|c|c|} \hline \square & \square & \square \\ \hline \square & \square & \square \\ \hline \square & & \end{array} \otimes \begin{array}{|c|c|c|} \hline \square & \square & \square \\ \hline \square & \square & \square \\ \hline \square & \square & \square \\ \hline \end{array} + \begin{array}{|c|c|} \hline \square & \square \\ \hline \square & \square \\ \hline \square & \square \\ \hline \end{array} \otimes \begin{array}{|c|c|} \hline \square & \square \\ \hline \square & \square \\ \hline \end{array}
 \end{aligned}$$

References

- [1] C. Montonen and D. I. Olive, *Magnetic monopoles as gauge particles?*, Phys. Lett. **B72** (1977) 117.
- [2] C. Vafa, E. Witten, *A strong coupling test of S-duality*, Nucl. Phys. **B431** (1994) 3-77, hep-th/9408074.
- [3] N. Seiberg, E. Witten, *Monopole condensation, and confinement in N=2 supersymmetric Yang-Mills theory*, Nucl. Phys. **B426** (1994) 19-52, hep-th/9407087.
- [4] R. Dijkgraaf, C. Vafa, *A perturbative window into non-perturbative physics*, hep-th/0208048.

- [5] G. Moore, E. Witten, *Integration over the u -plane in Donaldson theory*, Adv. Theor. Math. Phys. **1** (1998) 298-387, [9709193](#).
- [6] A. Klemm, M. Marino, S. Theisen, *Gravitational corrections in supersymmetric gauge theory and matrix models*, JHEP 0303 (2003) 051, [hep-th/0211216](#).
- [7] R. Dijkgraaf, A. Sinkovics, M. Temurhan, *Matrix models and gravitational corrections*, Adv. Theor. Math. Phys. **7** (2004) 1155-1176, [hep-th/0211241](#).
- [8] S. Katz, A. Klemm, C. Vafa, *Geometric engineering of quantum field theories*, Nucl. Phys. **B497** (1997) 173-195, [hep-th/9609239](#).
- [9] S. Katz, P. Mayr, C. Vafa, *Mirror symmetry and exact solution of $4d \mathcal{N} = 2$ gauge theories I*, Adv. Theor. Math. Phys. **1** (1998) 53-114, [hep-th/9706110](#).
- [10] T. Hollowood, A. Iqbal, C. Vafa, *Matrix models, geometric engineering and elliptic genera*, [hep-th/0310272](#).
- [11] M. Aganagic, R. Dijkgraaf, A. Klemm, M. Marino, C. Vafa, *Topological strings and integrable hierarchies*, [hep-th/0312085](#).
- [12] N. Nekrasov, *Seiberg-Witten prepotential from instanton counting*, Adv. Theor. Math. Phys. **7** (2004) 831-864, [hep-th/0206161](#).
- [13] N. Nekrasov, A. Okounkov, *Seiberg-Witten theory and random partitions*, [hep-th/0306238](#).
- [14] J. McKay, *Graphs, singularities, and finite groups*, Proc. Symp. Pure Math. 37 (1980) 183-186.
- [15] P. Slodowy, *Platonic solids, Kleinian singularities, and Lie groups in Algebraic geometry*, Lecture Notes in Mathematics, vol. **1008**, J. Dolgachev, Ed. (Springer-Verlag, 1983), 102.
- [16] H. Nakajima, *Instantons on ALE spaces, quiver varieties, and Kac-Moody algebras*, Duke Math. **76** (1994), 365-416.
- [17] H. Nakajima, *Instantons and affine Lie algebras*, Nucl. Phys. Proc. Suppl. **46** (1996) 154-161, [alg-geom/9510003](#).

- [18] I. Frenkel, *Representations of affine Lie algebras, Hecke modular forms and Korteweg-De Vries type equations*, in *Lie Algebras and Related Topics*, Lecture Notes in Mathematics, vol. **933**, D. Winter, Ed. (Springer-Verlag, Berlin, 1982), 71.
- [19] A. Licata, *Framed rank r torsion-free sheaves on CP^2 and representations of the affine Lie algebra $\widehat{gl}(r)$* , math.RT/0607690.
- [20] D. Gaiotto, A. Strominger and X. Yin, *New connections between 4d and 5d black holes*, JHEP 0602 (2006) 024, hep-th/0503217.
- [21] D. Gaiotto, A. Strominger and X. Yin, *5D black rings and 4d black holes*, JHEP 0602 (2006) 023, hep-th/0503217.
- [22] D. Shih, A. Strominger, X. Yin, *Recounting dyons in $\mathcal{N} = 4$ string theory*, JHEP 0610 (2006) 087, hep-th/0505094.
- [23] R. Dijkgraaf, C. Vafa, and E. Verlinde, *M-theory and a topological string duality*, hep-th/0602087.
- [24] I. Bena, D-E. Diaconescu, B. Florea, *Black string entropy and Fourier-Mukai transform*, hep-th/0610068.
- [25] H. Ooguri, C. Vafa, *Two-dimensional black hole and singularities of CY manifolds*, Nucl.Phys. **B463** (1996) 55-72, hep-th/9511164.
- [26] P. Ruback, *The motion of Kaluza-Klein monopoles*, Commun. Math. Phys. **107** (1986) 93-102.
- [27] A. Sen, *Dynamics of multiple Kaluza-Klein monopoles in M- and string theory*, Adv. Theor. Math. Phys. **1** (1998) 115-126, hep-th/9707042.
- [28] M. Green, J. Harvey, G. Moore, *I-brane inflow and anomalous couplings on D-branes*, Class. Quant. Grav. **14** (1997) 47-52, hep-th/9605033.
- [29] C. Bachas, M. Green, A. Schwimmer, *(8, 0) Quantum mechanics and symmetry enhancement in type I' superstrings*, hep-th/9712086.
- [30] L. Hung, *Comments on I1-branes*, hep-th/0612207.
- [31] N. Itzhaki, D. Kutasov, N. Seiberg, *I-brane dynamics*, JHEP 0601 (2006) 119, hep-th/0508025.

- [32] S. Naculich, H. Riggs and H. Schnitzer, *Group level duality in WZW models and Chern-Simons theory*, Phys. Lett. B **246** (1990) 417.
- [33] A. Sen, *A note on enhanced gauge symmetries in M- and string theory*, hep-th/9707123.
- [34] N. Evans, C. Johnson, A. Shapere, *Orientifolds, branes, and duality of 4d gauge theories*, hep-th/9703210.
- [35] E. Gimon, J. Polchinski, *Consistency conditions for orientifolds and D-manifolds*, hep-th/9601038.
- [36] M. Jimbo, T. Miwa, *On a duality of branching rules for affine Lie algebras*, Adv. Stud. Pure Math. **6** (1985) 17-65.
- [37] K. Hasegawa, *Spin module versions of Weyl's reciprocity theorem for classical Kac-Moody Lie algebras - An application to branching rule duality*, RIMS, Kyoto Univ. **25** (1989) 741-828.
- [38] P. Goddard, W. Nahm and D. Olive, *Symmetric spaces, Sugawara's energy momentum tensor in two-dimensions and free fermions*, Phys. Lett. **B160** (1985) 111.
- [39] D. Morrison and C. Vafa, *Compactifications of F-theory on Calabi-Yau threefolds I and II*, Nucl. Phys. **B473** (1996) 74-92, hep-th/9602114, and Nucl. Phys. **B476** (1996) 437-469, hep-th/9603161.
- [40] J. Harvey, A. Royston, *Localized modes at a D-brane-O-plane intersection and heterotic Alice strings*, arXiv:0709.1482.
- [41] E. Witten, *Solutions of four-dimensional field theories via M-theory*, Nucl.Phys. **B500** (1997) 3-42, hep-th/9703166.
- [42] A. Klemm, W. Lerche, P. Mayr, C. Vafa, N. Warner, *Self-dual strings and $\mathcal{N} = 2$ supersymmetric field theory*, Nucl.Phys. **B477** (1996) 746-766, hep-th/9604034.
- [43] D. Tong, *NS5-branes, T-duality and worldsheet instantons*, JHEP 0207 (2002) 013, hep-th/0204186.
- [44] J. Harvey, S. Jensen, *Worldsheet instanton corrections to the Kaluza-Klein monopole*, JHEP 0510 (2005) 028, hep-th/0507204.

- [45] R. Gopakumar and C. Vafa *M-theory and topological strings I and II*, hep-th/9809187 and hep-th/981217.
- [46] A. Iqbal, N. Nekrasov, A. Okounkov, C. Vafa, *Quantum foam and topological strings*, hep-th/0312022.
- [47] D. Maulik, N. Nekrasov, A. Okounkov, R. Pandharipande, *Gromov-Witten theory and Donaldson-Thomas theory, I-II*, math.AG/0312059, math.AG/0406092.
- [48] F. Denef and G. Moore, *Split states, entropy enigmas, holes and halos*, hep-th/0702146.
- [49] M. Henningson, P. Yi, *Four-dimensional BPS-spectra via M-theory*, Phys. Rev. **D57** (1998) 1291, hep-th/9707251.
- [50] N. D. Lambert, P. West, *Monopole dynamics from the M-fivebrane*, Nucl. Phys. **B556** (1999) 177-196, hep-th/9811025.
- [51] M. Duff, J. Lu, *Black and super p-branes in diverse dimensions*, Nucl. Phys. **B416** (1994) 301-334, hep-th/9306052.
- [52] A. Okounkov, N. Reshetikhin, C. Vafa, *Quantum Calabi-Yau and classical crystals*, hep-th/0309208.
- [53] R. Dijkgraaf, E. Verlinde and M. Vonk, *On the partition sum of the NS five-brane*, hep-th/0205281.
- [54] A. Kapustin and E. Witten, *Electric-magnetic duality and the geometric Langlands program*, hep-th/0604151.
- [55] M. Kashiwara, *D-modules and micolocal calculus*, Transl. Math. Monographs **217**, AMS 2000.
- [56] J. Bernstein, *Algebraic theory of \mathcal{D} -modules*, <http://www.math.uchicago.edu/~arinkin/langlands/Bernstein/>
- [57] D. Ghoshal and C. Vafa, *$c = 1$ String as the topological theory of the conifold*, hep-th/9506122.
- [58] C. Imbimbo and S. Mukhi, *The topological matrix model of $c = 1$ string*, Nucl. Phys. **B449** (1995) hep-th/9505127.

- [59] D. Ghoshal, C. Imbimbo and S. Mukhi, *Topological 2d string theory: higher genus amplitudes and W_∞ identities*, Nucl. Phys. **B440** (1995) 355 hep-th/9410034.
- [60] S. Mukhi and C. Vafa, *Two-dimensional black-hole as a topological coset model of $c = 1$ string theory*, Nucl. Phys. **B407** (1993) 667 hep-th/9301083.
- [61] R. Dijkgraaf, G. Moore and R. Plesser, *The partition function of 2d string theory*, Nucl. Phys. **B394** (1993) hep-th/9208031.
- [62] J. Distler and C. Vafa, *A critical matrix model at $c = 1$* , Mod. Phys. Lett. **A6** (1991) 259.
- [63] I. Klebanov and D. Gross, *One-dimensional string theory on a circle*, Nucl. Phys. **B344** (1990) 475.
- [64] M. Aganagic, A. Klemm, M. Marino, C. Vafa, *The topological vertex*, hep-th/0305132.
- [65] C. Vafa, *Two dimensional Yang-Mills, black holes and topological strings*, hep-th/0406058.
- [66] J. Bryan and R. Pandharipande, *The local Gromov-Witten theory of curves*, math/0411037.
- [67] R. Dijkgraaf, *Mirror symmetry and elliptic curves*, in "The moduli space of curves", Progress in Mathematics **129** (Birkhauser, 1995)) 149–163.
- [68] M. Douglas, *Conformal field theory techniques in large N Yang-Mills theory*, hep-th/9311130.
- [69] R. Dijkgraaf, *Chiral deformations of conformal field theories*, Nucl. Phys. **B493** (1997) 588.
- [70] D. Gross and I. Klebanov, *Fermionic string field theory of $c = 1$ two-dimensional quantum gravity*, Nucl. Phys. **B352** (1991) 671–688.
- [71] M. Kaneko and D. Zagier, *A generalized Jacobi theta function and quasimodular forms*, in "The moduli space of curves," Progress in Mathematics **129** (Birkhauser, 1995)) 162–172.
- [72] J. Li, K. Liu and J. Zhou, *Topological string partition functions as equivariant indices*, math.AG/0412089.

- [73] G. Moore, *Modular forms and twoloop string physics*, Phys. Lett. **B176** (1986) 369.
- [74] A. Belavin, V. Knizhnik, A. Morozov and A. Perelemov, *Two and three loop amplitudes in the bosonic string theory*, Phys. Lett. **B177** (1986) 324.
- [75] R. Dijkgraaf, E. Verlinde, H. Verlinde, *Counting dyons in $N=4$ string theory*, Nucl.Phys. **B484** (1997) 543-561, [hep-th/9607026](#).
- [76] R. Borcherds, *Automorphic forms on $O_{s+2,2}(R)$ and infinite products*, Invent. Math. **120**, 161-213 (1995).
- [77] B. Eynard and N. Orantin, *Invariants of algebraic curves and topological expansion* [math-ph/0702045](#).
- [78] V. Bouchard, A. Klemm, M. Marino and S. Pasquetti, *Remodeling the B-model*, [hep-th/0709.1453](#).
- [79] R. Dijkgraaf, *The mathematics of five-branes*, ICM lecture, [hep-th/9810157](#).
- [80] K. Intriligator, N. Seiberg and D. Shih, *Dynamical SUSY breaking in meta-stable vacua*, JHEP 0604 (2006) 021, [hep-th/0602239](#).
- [81] M. Aganagic, C. Beem, J. Seo and C. Vafa, *Geometrically induced metastability and holography*, [hep-th/0610249](#).
- [82] J. Marsano, K. Papadodimas and M. Shigemori, *Nonsupersymmetric brane/antibrane configurations in type IIA and M theory*, [arXiv:0705.0983](#).
- [83] R. Pandharipande and R. Thomas, *Curve counting via stable pairs in the derived category* [math.AG/0707.2348](#).
- [84] D. Jatkar, A. Sen, *Dyon spectrum in CHL models*, JHEP 0604 (2006) 018, [hep-th/0510147](#).
- [85] J. David, D. Jatkar and A. Sen, *Dyon spectrum in generic $N=4$ supersymmetric \mathbb{Z}_N orbifolds*, JHEP 0701 (2007) 016, [hep-th/0609109](#).
- [86] D. Ben-Zvi and T. Nevins, *\mathcal{D} -bundles and integrable hierchies*, [math.AG/0603720](#).
- [87] T. Nakanishi and A. Tsuchiya, *Level-rank duality of WZW models in conformal field theory*, Commun. Math. Phys. **144** (1992) 351-372.