



Vaasan yliopisto
UNIVERSITY OF VAASA

OSUVA Open
Science

This is a self-archived – parallel published version of this article in the publication archive of the University of Vaasa. It might differ from the original.

Power system flexibility improvement with a focus on demand response and wind power variability

Author(s): Vahidi, Behrooz; Dadkhah, Akbar; Shafie-khah, Miadreza; Catalao, Joao

Title: Power system flexibility improvement with a focus on demand response and wind power variability

Year: 2020

Version: Accepted manuscript

Copyright ©2020 IET. This paper is a postprint of a paper submitted to and accepted for publication in *Iet renewable power generation* and is subject to Institution of Engineering and Technology Copyright. The copy of record is available at the IET Digital Library.

Please cite the original version:

Vahidi, B., Dadkhah, A., Shafie-khah, M., & Catalao, J., (2020). Power system flexibility improvement with a focus on demand response and wind power variability. *Iet renewable power generation*. <https://doi.org/10.1049/iet-rpg.2019.0123>

Power System Flexibility Improvement with a Focus on Demand Response and Wind Power Variability

Akbar Dadkhah¹, Behrooz Vahidi^{1,*}, Miadreza Shafie-khah², João P.S. Catalão³

¹ Department of Electrical Engineering, Amirkabir University of Technology, Tehran, Iran

² School of Technology and Innovations, University of Vaasa, 65200 Vaasa, Finland

³ Faculty of Engineering of the University of Porto and INESC TEC, 4200-465 Porto, Portugal

*vahidi@aut.ac.ir

Abstract: Unpredictable system component contingencies have imposed vulnerability on power systems, which are under high renewables penetration nowadays. Intermittent nature of renewable energy sources has made this unpredictability even worse than before and calls for excellent adaptability. This paper proposes a flexible security-constrained structure to meet the superior flexibility by coordination of generation and demand sides. In the suggested model, demand-side flexibility is enabled via an optimum real-time (RT) pricing program, while the commitment of conventional units through providing up and down operational reserves improves the flexibility of supply-side. The behaviour of two types of customers is characterized to define an accurate model of demand response and the effect of customers' preferences on the optimal operation of power networks. Conclusively, the proposed model optimizes RT prices in the face of contingency events as well as wind power penetration. System operators together with customers could benefit from the proposed method to schedule generation and consumption units reliably.

Keywords: Demand response, Customers' behaviour, Network contingencies, Wind power uncertainty, Reliability.

Nomenclature

Indices

b, b'	Index of system buses
c	Index of network components
g	Index of generation units
l	Index of transmission lines
m	Index for segments of linearized fuel cost
NB	Number of system buses
NC	Number of network components
NG	Number of generation units
NG_b	Number of generators on bus b
NL	Number of transmission lines
NM	Number of segments for piecewise linearized fuel cost
NS	Number of scenarios
NT	Number of hours
NW	Number of wind power units
s	Index of scenarios
t, t'	Index of time periods
R_g^D	Ramp down of unit g (MW/h)

w Index of wind power units

Parameters

C_g^{SU}	Start-up cost of unit g (\$)
C_{gt}^{SU}	Start-up cost of unit g at hour t (\$)
$C_g(m)$	Slope of segment m in fuel cost curve of unit g (\$/MWh)
C_g	Min. fuel cost of unit g (\$/h)
C_{gt}^{DSR}	Down-spinning reserve cost of unit g at hour t (\$/MWh)
C_{gt}^{USR}	Up-spinning reserve cost of unit g at hour t (\$/MWh)
d_{bt}^0	Basic demand of bus b at hour t (MW)
\overline{DRP}_b	Max. customers' response to DR at bus b
\overline{ELNS}	Max. limit of ELNS
$E_{tt'}$	Elasticity of demand
\underline{P}_g	Min. output of generation unit g (MW)
\overline{P}_g	Max. output of generation unit g (MW)
$\overline{P}_{gt(m)}$	Max. output power of segment m for unit g
$\overline{P}_l, \underline{P}_l$	Max./Min. permitted flow of power in line l
\overline{P}_{wts}	Available power of wind power unit w in scenario s and hour t (MW)
L_{bts}^{shed}	Load shedding at bus b at hour t in

R_g^U	Ramp up of unit g (MW/h)		
V^{crit}	Value of wind power curtailment (\$/MWh)	$P_{bb't}$	Active power through line between buses b and b' at hour t
V^{FIT}	FIT value (\$/MWh)	$P_{gt}^{(m)}$	Generation of segment m in linearized fuel cost curve (MW)
V_{bt}^{shed}	Value of lost load at bus b at hour t (\$/MWh)	P_{gt}^{Sch}	Scheduled power of unit g at hour t (MW)
ρ_s	Probability of outage in scenario s	P_{wts}^{crt}	Curtailed power of wind power unit w in scenario s hour t (MW)
π_{bt}^0	Basic price of bus b at hour t (\$/MWh)	P_{wts}^{inc}	Incorporated power of wind power unit w in scenario s hour t (MW)
Variables		P_{wt}^{Sch}	Scheduled power of wind power unit w at hour t (MW)
C_{gt}	Fuel cost of generation unit g at hour t (\$)	USR_{gt}^{Sch}	Scheduled up-spinning reserve of unit g at hour t (MW)
d_{bt}	Demand of bus b at hour t after DR implementation (MW)	USR_{gts}^{dep}	Deployed up-spinning reserve of unit g at hour t in scenario s (MW)
DSR_{gt}^{Sch}	Scheduled down-spinning reserve of unit g at hour t (MW)	$X_{bb'}$	Reactance of line between buses b and b'
DSR_{gts}^{dep}	Deployed down-spinning reserve of unit g at hour t in scenario s (MW)	Γ	Spinning reserve market lead time
I_{gt}	Binary status (off -on) of generation unit g at hour t	μ_{gs}	State of reserve of generating unit g in scenario s
		θ_{bts}	Voltage angle at bus b at hour t in scenario s

1. Introduction

The flexibility is the ability of a power system to respond to change in supply and demand at all periods and balance them. Unpredictable renewable energy supply can make this equilibrium hard to attain. Independent system operators (ISO) face significant challenges due to unforeseen network component contingencies as well as the uncertainty of renewable energy resources in the electricity supply side. As a result, the power system stability is disturbed. For enhancing the stability, the ISO should schedule some production units at a non-optimal generation level according to the units' constraints. In addition, flexible demand-side resources and system operations could support network flexibility [1].

Ref. [2] has studied the influence of expanded penetration of renewable energy resources on thermal power plants operation. In response to considerable changes in supply and demand sides, network components should operate in a flexible manner to provide uninterrupted services while the operational cost is in a reasonable range. Latest publications incorporated wind power uncertainty to unit commitment (UC) problem. Authors have introduced a unit commitment model in [3] to elucidate the variation between ramp-capability and power-capacity reserves considering the wind power uncertainty. In [4], researchers developed a probabilistic UC approach for balancing wind power uncertainties. In [5], authors designed a developed energy hub and presented a mathematical formulation for deterministic and stochastic situations of renewable resources, power demand, and price. Papers such as [6-7]

have deployed transmission switching in a unit commitment problem to improve wind power utilization and grid flexibility. However, they have neglected demand-side activities. Ref. [8] suggests an optimization model for the security constraint unit commitment (SCUC) taking into account the uncertainty of wind power. A comprehensive review is presented in [9] considering additional flexibility in power systems in response to uncertainty from the penetration of renewable power resources. Market clearing by means of optimization methods can assist power system operators to make near-optimal decisions. In addition, due to hardship in making a distinction between ramping capability, load following and regulation reserves, some investigations should measure the prices and payments.

Demand response (DR), as a fundamental element of future smart grids, not only mitigates the impacts of uncertain renewable energy resources but also can be utilized either to cut high energy prices or when the safety of power systems is in danger. Several reports employed DR to enable customers' potential for enhancing the flexibility of the network in the face of renewable energy penetration. In Ref. [10], authors have modelled several flexible resources such as energy storages, parking lots and a DR program with a focus on the ramp products to provide enough flexibility in response to the penetration of renewable energy resources. A flexibility metric is presented in Ref. [11] to calculate the possible flexibility of conventional generators. Researchers have incorporated the proposed model into the day-ahead market clearing to assess the flexibility of energy storages and DR. However, the mentioned works have not considered the outages of network components such as generation units or transmission lines. In addition, the

authors mainly focused on generation-side scheduling and ramp products. Calculation of optimal prices and customers' payment considering consumers' role have been neglected in their works. Ref. [12] proposed an IGDT-based model for economically dispatching of generating units considering the existence of wind power uncertainties. The proposed RS IGDT-based model gives the chance to achieve lower network cost under uncertain scenarios. Authors have not considered different types of customers for ideal price design in the power system. Also, contingencies as a result of network component outages have not been taken into account in their work. Ref. [13] discussed a frequency based approach for the provision of primary operating reserve from residential consumers. Authors endeavoured to answer crucial questions concerning the implementation of DR for a variety of individual appliances in a thermodynamic load model and investigated the frequency regulation. Ref. [14] presented some metrics related to diverse stakeholders to evaluate building-to-grid DR flexibility from heat pump aggregations. Authors proposed precise control algorithms for the aggregations through a residential power consumption tool. The aggregator which is responsible for extracting the flexibility from individual consumers and providing various services to DR buyers could model each load individually. Compared to Refs. [13, 14], the current paper looks at the total usage in the power system rather than individual usage pattern modelling for only residential loads. Authors consider that ISO aims to manage the grid and ensures its flexibility considering a total load for each bus. In this regard, DR programs allow the ISO to schedule an appropriate generation capacity. The authors in [15] mainly focused on the role of the incentive-based DR penetration in a smart distribution system. For estimating the system reliability, authors applied a new hybrid technique based on the best possible load-dispatch and sequential Monte Carlo. The reserve market modelling and optimal price calculation have been overlooked in [15]. Also, they have focused on demand-side solutions, and supply-side management and the link between supply and demand sides have been neglected.

Ref. [16] has analysed a parametric model to find the relation between the generation cost and the necessary parameters of the flexible ramp product. No uncertainty has considered in the proposed deterministic model, while the model of this paper considers the wind power uncertainty. Besides, our model looks at the customers' role and impacts of products such as up/down spinning reserves.

In Ref. [17], the authors modelled an emergency DR program in the unit commitment problem and examined its impact in reliability improvement in case of failure of generation units. It is worth noting that the outage of transmission lines and the uncertainty of renewable energy sources have been neglected in their works.

Availability of DR is not only dependent on the operation of electric appliances but also can be influenced by customers' behaviours. In the electricity market, financial gain is the main motivation for consumers to engage in DR programs. So, considerable mistakes may occur in evaluating the flexibility commitment of DR if the impacts of consumers are overlooked. Engagement in DR can characterize consumers and is reflected in price elasticity

matrix (PEM) structure and components. It is an undeniable fact that the elasticity of electricity demand can change with the shift in price like any other commodities. In practical situations, low price periods are considered to have low values of own-elasticity components. In [18], the information of a regression investigation was modified and used for obtaining the elasticity variables which can increase with growing price signals. A comprehensive socio-economic study based on real data is essential for measuring PEM values in a specific society. Detailed PEMs can be developed to the model the behaviour of consumers for applying several enhancements to DR programs. Authors have offered an algorithm for reshaping the electricity demand profile in Ref. [19]. The proposed algorithm considers the customer eagerness to participate in DR, price elasticity, and customers comfort by determining a price signal, which minimizes their electricity bill when shifting their adaptable load. A real-time price design approach is introduced in Ref. [20] to support consumer participation in energy delivery. The proposed DR program which is designed on behalf of the Load Serving Entity (LSE) aims to maximize its revenue. However, Refs. [19,20] have not taken into account price design for optimal supply-side scheduling and improving the network flexibility which ISO is responsible for.

On the above premises, we extend a clear model and some constraints to characterize the availability of customer DR capabilities. It can explain how the readiness of various consumers to join DR programs influences their economic profitability as well as the flexibility of a power system with a high share of wind power.

A two-phase SCUC program is presented for enhancing the flexibility of the system through an optimal real-time (RT) pricing scheme. The proposed reliability evaluation method in this paper is formulated as a mixed-integer linear DC optimal power flow which can be modelled in GAMS and solved using CPLEX as a powerful Mixed-Integer Linear Programming (MILP) solver. Although the problem formulation is a "two stages" problem, it is solved in one step. It is noteworthy that the solving engine of MATPOWER Optimal Scheduling Tool (MOST) can be also CPLEX as a high-performance solver to study stochastic day-ahead (SCUC) and DR problems Refs. [21,22]. Therefore, the solving engine of both MOST and GAMS can be the same. The proposed framework will be illustrated using numerical examples applied to the IEEE Reliability Test System (RTS). However, the discussions and conclusions in this paper won't lose their general validity and can be extrapolated further than the scenarios and cases studied in this piece of work. Although the literature presents valuable findings, the subsequent viewpoints indicate that our proposed approach is different from existing strategies.

- The proposed method focuses on total usage rather than individual usage pattern modelling.
- This paper develops a pricing algorithm for determination of optimum RT tariff rates with the aim to minimize operating costs.
- Our method aims to provide essential flexibility by planning generation units and responsive

consumers to supply network stability in the face of wind power uncertainty as well as network contingencies

- The proposed model investigates the effect of two different consumers' reaction on network operation considering the wind power unreliability and emergency conditions.

The structure of the manuscript is as follows: Section 2 illustrates the proposed model and its mathematical definition. The test system is presented in Section 3. Section 4 gives the simulation results, and at last, this paper is concluded in Section 5.

2. Problem formulation

The introduced adaptable security constrained scheduling structure optimizes the operation of demand and supply sides. Two-phase stochastic programming is utilized for the most advantageous planning of supply-side. The primary phase gives decisions as the output of the day-ahead market of the system. The second-phase measures network component outages and wind power uncertainty in order to get a single day-ahead market clearing. Demand-side participation is also included in the suggested formulation using a developed economic model of loads. In fact, the eagerness of customers to join DR programs is characterized by the customer participation rate [12]. It varies between [0, 1], the larger the participation rate is the more consumers will change their demand when asked. Several participation rates (0.1, 0.2 and 0.3) are considered in Ref [12] in order to analyse the influence of risk preferences on the time-of-use DR implementation. In Ref. [23], authors have represented the impact of customers' participation level in Emergency DR programs on the microgrid operation.

In another line of research, it was found that between 5% to 15% of consumers in the United States participated in DR programs [24, 25]. Results of a survey from Australians over all states and regions showed that approximately 80% of respondents were not familiar with DR programs. It means that if in the most optimistic scenario, 20% of consumers know about DR and half of them participate in DR programs, still 10% of consumers join DR plans [26]. Considering all these studies, customer participation rate in DR not only depends on their comfort level but also on the socioeconomics, source of power etc. So, 10% is assumed as the participation rate considering mentioned references.

The initial demand profile, consumers' elasticity data and their participation rate are entered as required inputs. After calculating RT rates at each load bus and time period, the supply-side planning division has an input which is the reshaped demand. Consequently, the objective function sees the effects of elasticity as change in load and the amount of load shedding. These values also affect the reserve values. This connection between demand-side and supply-side can guarantee an acceptable and adaptable power system operation. Finally, the output variables pertaining to economic and flexibility operation targets of ISO is extracted as outputs. A schematic of the calculation process is given (see Fig. 1).

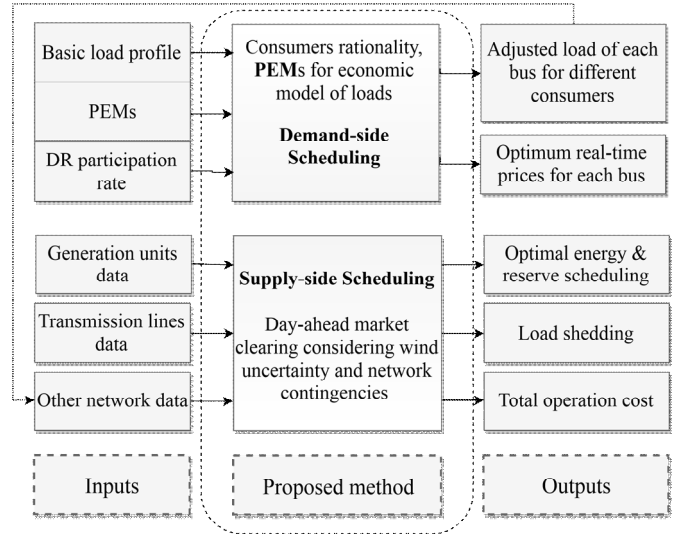

Fig. 1 Schematic of the proposed model

2.1. DR formulation

PEM is the most practical way in DR modelling and can represent the behaviour and preference of consumers. The elasticity of demand can be characterized in this model as demand change in t th interval with respect to the price deviation in t' th period (See Eq. (1)) [27].

$$E_{tt'} = \frac{\pi_{t'}^0 \delta d_t}{d_t^0 \delta \pi_{t'}} , \quad t' = 1, 2, 3, \dots, 24 \quad (1)$$

The demand elasticity comprises a single-period and multi-period responses. The single-period response deals with the ongoing period; hence, it changes the energy usage in the corresponding interval and is not able to shift the load to other periods. In the multi-period response, customers can change their usage in any period based on electricity price adjustment. In the modelling of multi-period response, elasticity factors include self-elasticity and mutual-elasticity values. According to Eq. (1), the definition of self-elasticity and mutual-elasticity coefficients can be specified as Eqs. (2) and (3).

$$E_{tt'} \leq 0, \quad \text{if } t = t' \quad (2)$$

$$E_{tt'} \geq 0, \quad \text{if } t \neq t' \quad (3)$$

Ref. [27] presented a complete economic model of DR. The overall model of DR will be achieved by Eq. (4) by considering the concept of cross- and own- elasticity.

In the RT demand response program, the utilities set the highest prices at the peak hours. It makes clear the relation between energy rate and the load, the increase of tariffs can flatten the load profile in the peak hours.

$$d_t = d_t^0 \left\{ 1 + \frac{\sum_{t'=1}^{24} E_{t'} [\pi_{t'} - \pi_{t'}^0]}{\pi_{t'}^0} \right\} \quad (4)$$

2.2. Demand response constraints

Several limitations must be considered to find an appropriate pricing program. We intend to design a DR program to make use of the maximum amount of DR potential and consumers responsiveness to our flexibility improvement. So, we assume a situation in which the lowest price is designed for the lowest demand period (see Fig. 2 [28]). ISO should raise the electricity price according to the demand until getting to the highest amount of consumption, which happens at the eighteenth period.

In this way, consumers are encouraged to shift their shiftable loads to the lowest price period. As a result, we have a flatter load profile and less amount of load shedding after DR implementation. We develop twenty-four limitations for change in price $\delta\pi_{bt}$, as shown in the Eq. (5).

$$\delta\pi_{bt} = \frac{\pi_{bt} - \pi_{bt}^0}{\pi_{bt}^0} \quad (5)$$

Larger $\delta\pi_{bt}$ should be set for hours with more consumption compared to other times (see Fig. 2 [28]). This limit for ($t = 2-8$) should be negative, which implies less expensive tariffs than the flat rate. For ($t = 1, 9, 15, 16, 23$ and 24), $\delta\pi_{bt}$ is set to be free and for the other times is set to be positive, which means consumers face higher electricity prices than the flat rate. Eq. (6) shows the highest capacity of customers for changing their loads; the maximum amount of load that can be changed at different time intervals and each bus.

$$-\overline{DRP}_b d_{bt}^0 \leq \delta d_{bt} \leq \overline{DRP}_b d_{bt}^0 \quad (6)$$

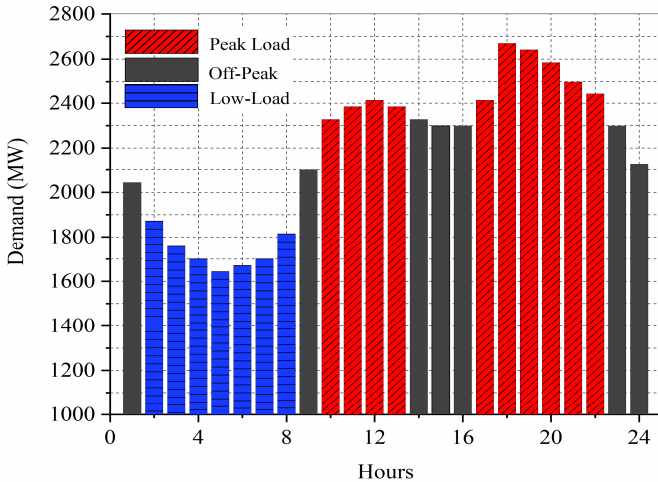

Fig. 2. Hourly load profile

Eq. (7) shows that during DR exertion, overall energy usage at every bus has to remain invariable to guarantee the users' convenience. In other words, loads are shifted from peak hours to low-load and off-peak hours. In reality, less electricity would be consumed in higher prices and the shiftable loads shift their electricity usage to lower prices hours.

$$\sum_{t=1}^{NT} \delta d_{bt} = 0 \quad (7)$$

2.3. Objective function

This part gives the recommended structure of the SCUC problem considering the reliability measures and DR. The objective function is the expected operational cost and incorporates two stages as shown in Eq. (8). The primary stage calculates electricity market costs, including power generation, down- and up-spinning reserves, and start-up costs to clear the day ahead market.

The next stage which is related to the scenario realization covers the possibility of each component outage and wind uncertainty, compulsory load shedding costs, and rescheduled down- and up-spinning reserves in each scenario.

Although Feed-In-Tariff (FIT) do not incentivize market-efficient participation of renewables on a short-term basis, according to outputs of some research manuscripts [29-31], it is rather a common perception that FITs can attract investment into renewables. So, the authors consider the FIT mechanism to persuade wind production units to contribute to power generation.

$$\min TC = \sum_{t=1}^{NT} \sum_{g=1}^{NG} \left[C_{gt} I_{gt} + C_{gt}^{SU} \right] + \left[+ C_{gt}^{USR} USR_{gt}^{sch} + C_{gt}^{DSR} DSR_{gt}^{sch} \right] + \left\{ \sum_{t=1}^{NT} \sum_{g=1}^{NG} (C_{gts}^{USR} USR_{gts}^{dep} + C_{gts}^{DSR} DSR_{gts}^{dep}) \right\} + \left\{ \sum_{s=1}^S \rho_s \left[\sum_{t=1}^{NT} \sum_{b=1}^{NB} V_{bt}^{shed} L_{bts}^{shed} + \sum_{t=1}^{NT} \sum_{w=1}^{NW} (V_{wts}^{FIT} P_{wts}^{inc} + V_{wts}^{crt} P_{wts}^{crt}) \right] \right\} \quad (8)$$

Furthermore, wind power curtailment cost is also considered for demonstrating the condition that operation limitations do not permit the wind power incorporation.

An incremental cost function in a linear piecewise style can demonstrate the fuel expense in thermal units. Eq. (9) shows the generation cost of each unit k at the simulation time i .

$$C_{gt} = C_g(m) I_{gt} + \sum_{m=1}^{NM} C_g^f P_{gt}(m) \quad (9)$$

where:

$$0 \leq P_{gt}(m) \leq \overline{p_{gt}(m)} \quad (10)$$

2.3.1 First stage constraints: For defining the primary stage constraints which relate to the power market, scenarios are overlooked:

- Start-up cost limitations of production units

$$0 \leq C_{gt}^{SU} \leq C_g^{SU} (I_{gt} - I_{g,t-1}) \quad (11)$$

Eq. (12) shows the linear definition of the programmed power of production units P_{gt}^{Sch} .

$$P_{gt}^{Sch} = \underline{p}_g I_{gt} + \sum_{m=1}^{NM} P_{gt}(m) \quad (12)$$

Limitation of wind power production

$$0 \leq P_{wt}^{Sch} \leq P_w^{inst} \quad (13)$$

The energy offer of a wind farm w is submitted as P_w^{inst} in Eq. (13) with a value equal to the installed capacity of the wind farm.

- Limitations of down - and up-spinning reserve

The reliability of the system against the changes in demand-side and supply-side are assured by down- and up-spinning reserves. Eqs. (14-17) show the limitations of spinning reserves capacity and the market lead time of spinning reserves Γ .

$$P_{gt}^{Sch} + USR_{gt}^{Sch} \leq \overline{p}_g I_{gt} \quad (14)$$

$$P_{gt}^{Sch} - DSR_{gt}^{Sch} \geq \underline{p}_g I_{gt} \quad (15)$$

$$0 \leq USR_{gt}^{Sch} \leq R_g^U \Gamma \quad (16)$$

$$0 \leq DSR_{gt}^{Sch} \leq R_g^D \Gamma \quad (17)$$

- Production units up and down limits

$$P_{gt}^{Sch} - P_{g,t-1}^{Sch} \leq R_g^U I_{g,t} + \underline{p}_g (1 - I_{g,t-1}) \quad (18)$$

$$P_{g,t-1}^{Sch} - P_{gt}^{Sch} \leq R_g^D I_{g,t-1} + \underline{p}_g (I - I_{gt}) \quad (19)$$

- Production units' up and down time limits

$$\sum_{t'=t+2}^{t+\Gamma_g^+} (I - I_{g,t'}) + \Gamma_g^+ (I_{gt} - I_{g,t-1}) \leq \Gamma_g^+ \quad (20)$$

$$\sum_{t'=t+2}^{t+\Gamma_g^-} I_{gt'} + \Gamma_g^- (I_{g,t-1} - I_{gt}) \leq \Gamma_g^- \quad (21)$$

- Active power equilibrium limit

$$\sum_{g=1}^{NG} P_{gt}^{Sch} - d_{bt}^0 - \delta d_{bt} = \sum_{\substack{b'=1 \\ b'b}}^{NB} P_{bb't} \quad (22)$$

$$P_{bb't} = \frac{1}{X_{bb'}} (\theta_{bt} - \theta_{b't}) \quad (23)$$

- Ramp-down and Ramp-up constraint

$$-R_g^D \leq P_{gt}^{Sch} - P_{g,t-1}^{Sch} \leq R_g^U \quad (24)$$

The total generated power at supply-side should satisfy the total energy consumption at the demand-side. d_{bt} is the demand for bus b at hour t .

$$\sum_{g=1}^{NG} P_{gt}^{Sch} + \sum_{w=1}^{NW} P_{wt}^{Sch} = \sum_{b=1}^{NB} d_{bt} \quad (25)$$

2.3.2 Second stage constraints:

- The restriction of active power balance in scenarios

Power balance at every bus should be guaranteed by load blocks and generation units in each event. So, Eq. (26) show the DC power flow equation. γ and χ are utilized as two binary parameters for presenting the accessibility of transmission lines and production units, correspondingly. During the component outages, their values are 0. When we have no component outage, they are considered 1.

$$\sum_{g=1}^{NGb} \chi P_{gt}^{Sch} - d_{bt} - L_{bts}^{shed} + \sum_{g=1}^{NGb} USR_{gts}^{dep} \quad (26)$$

$$- \sum_{g=1}^{NGb} DSR_{gts}^{dep} + (P_{wts}^{inc} - P_{wts}^{crt}) = \sum_l^{NL} \gamma P_{lts}$$

$$P_{lts} = \frac{l}{X_{bb'}} (\theta_{bts} - \theta_{b'ts}) \quad (27)$$

- Up and down spinning reserve limits

$$0 \leq USR_{gts}^{dep} \leq \mu_{gs} USR_{gt}^{Sch} \quad (28)$$

$$0 \leq DSR_{gts}^{dep} \leq \mu_{gs} DSR_{gt}^{Sch} \quad (29)$$

μ_{gs} is 0 for generator g and in scenario s if generator outage has occurred and it is considered as 1 otherwise.

- Load shedding constraint

The adjusted load at each bus after executing RT demand response program in each scenario ought to remain more than the amount of load reduction, as Eq. (30).

$$0 \leq L_{bts}^{shed} \leq d_{bt} \quad (30)$$

- Transmission line power limit
The transmission flow limits are considered in Eq. (31). For each line, the power flow through the line should consider this limitation.

$$-\overline{P}_l \leq P_{lts} \leq +\overline{P}_l \quad (31)$$

- Limitation of wind power units

The total wind power capacity is more than the amount of incorporated power of each wind farm. It is noteworthy that scheduled and curtailed power of each wind power unit are positive values. So, the amount of wind power capacity is more than the summation of incorporated and curtailed power of wind farms (see Eqs. (32) and (33)).

$$0 \leq P_{wts}^{inc} \leq \overline{P}_{wts}, \quad 0 \leq P_{wts}^{crt} \quad (32)$$

$$P_{wts}^{inc} + P_{wts}^{crt} \leq \overline{P}_{wts} \quad (33)$$

2.4. Reliability Assessment

This paper utilizes an expected load not served (ELNS) index for measuring the reliability of the system as presented in [32]. Eq. (34) calculates the ELNS by multiplying the load shedding value in each scenario and the plausibility of component loss. The highest permissible quantity of ELNS set by the ISO guarantees the reliable power generation and consumption planning (see Eq. (35)).

$$ELNS_t = \sum_{b=1}^{NB} \sum_{s=1}^{NS} \rho_s L_{bts}^{shed} \quad (34)$$

$$ELNS_t \leq \overline{ELNS} \quad (35)$$

3. Test System

Fig. 3 shows the IEEE 79-bus test system; including 26 generation units, two wind farms, 38 transmission lines, and the overall load capacity of 2670 MW. The hourly load profile is extracted from [28] and divided into three categories, low consumption (2-8), off-peak (1, 9, 14-16, 23, 24) and peak (10-13, 17-22) hours. Furthermore, price elasticity matrices are extracted from Ref. [18]. The value of the maximum incremental cost of energy generation of each production unit is supposed as the deployed up- and down-spinning reserves. In [28], complete data of loads, transmission lines, and generation units are presented, as well as reliability data. We selected bus 2 and bus 21 to add wind farms to. Considering a large-scale integration of renewable energy resources, we decided to reach a position that wind farms provide 30% (1200 MW) of the total generation capacity.

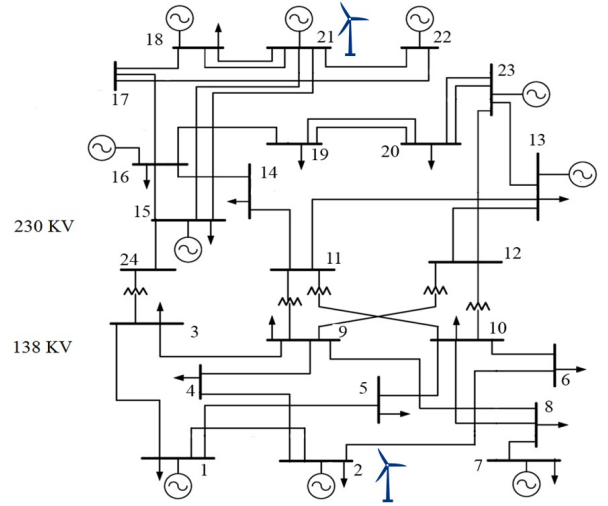

Fig. 3. Single line diagram of the test system

The FIT incentive value and wind power curtailment cost are supposed to be 20 and 35 \$/MWh, respectively. The value of wind curtailment cost is chosen higher than the value of FIT incentive to convince the ISO to incorporate maximum accessible wind power. Our proposed method employs the process of Ref. [33] for calculating wind speed and the corresponding wind power. The authors of Ref. [33] introduced a common wind speed model to obtain the wind speed probability distribution for any geographic area. They also developed a power production model of a wind turbine generator placed at a distinct geographic position. This strategy would be useful for wind farm locations without sufficient historical information. The mechanism represented in Ref. [34] is applied for scenario generation and model the wind power uncertainty. In Ref. [34] a two-step procedure is employed to solve a stochastic problem for the joint market clearing.

In the first stage, a Monte Carlo simulation and the roulette wheel mechanism are employed for adaptive scenario production to model the stochastic performance of network contingencies as well as load changes. The roulette wheel mechanism selects the load uncertainty and its probability distribution for the respective scenario. Concurrently, authors implement the MCS based on the FOR of network components for other sources of unpredictability. It was assumed that probability distribution and FOR of network units are available.

Value of loss load (VoLL) is one of the critical factors that has a prominent role in the rate of load shedding allocation. This value can change by a change in the type of customers, time, duration, time of advanced notification, and other particular features of an outage. In practice, some consumers like industrial ones have higher VoLL than others and hence, are ready to spend more for higher security levels than those with less VoLL. So, its calculation needs a full study for each network. However, VoLL is generally considered between \$0/MWh and \$53,907/MWh [35]. As shown in Ref. [36], the amount of not supplied energy decreases with sharp slope when VoLL is in the range between \$100/MWh and \$1000/MWh. High VoLL during peak hours imposes excessive costs on the system operator, who can manage demand response programs to mitigate such high expenses [17]. Operators could penalize

the load not served by penalties equal to the market price, two times the market price, and five times the market price. However, when the penalty becomes high (analogous to the VoLL), operators may prefer to apply DR for some loads instead of paying for the penalty [37]. Considering these references, in our manuscript where the flat rate is approximately 23.4 \$/MWh, we set the VoLL for off-peak hours almost ten-times of the flat rate (200\$/MWh), a larger amount for peak hours (300 \$/MWh), and a less amount for low-load hours (100\$/MWh).

4. Simulation results

The target of the proposed framework is ensuring reliable and flexible operation of the network by calculating hourly RT rates, where the energy consumption should remain constant (see Eq. (7)).

In order to evaluate the efficiency of the proposed model, the authors consider four case studies. Target is providing operational flexibility from technical and monetary viewpoints. Case 1 considers the wind power uncertainty and flat rate tariffs. Case 2 is similar to the first one except that in this case DR is included through optimal RT program. The RT tariffs are optimally calculated to obtain the minimum operation cost. Case 3 is again the same as the first one, but this case contains wind power scenarios and component contingencies using the N-1 criterion. Case 4 is like the third one except that in this case DR is incorporated.

4.1. Case 1: Influence of wind power variations on generation planning without DR

This case with a flat rate pricing program takes into account the impact of wind power uncertainty on the system operation. The necessary flexibility is provided entirely by conventional supply-side power plants through the operational reserve. The whole operation cost and customers' payment, in this case, are \$749345 and \$1226616, respectively.

Figs. 4 and 5 show a meaningful similarity between the hourly demand and operation cost in the first case. Customers' payment is calculated by the sum of multiplying the real-time price and real-time consumption at each hour. The amount of involuntary load shedding due to infeasibilities in wind power generation and the wind power curtailment are calculated 0.088% (2.35 MWh) and 0.32% (8.63 MWh) of the overall power demand, respectively.

4.2. Case 2: Influence of wind power variations on generation-side scheduling considering DR

This case with an RT pricing scheme takes into account the influence of wind power volatility on the system operation. Supply-side and demand-side cooperation provides the necessary supplementary flexibility.

As mentioned in the second section, 10 percent of consumers are assumed to be the responsive ones. First, authors considered all of responsive consumers (10%) as SR ones that change their demand at the current time interval in response to changes in price at the corresponding hour. These customers do not optimise their consumption and

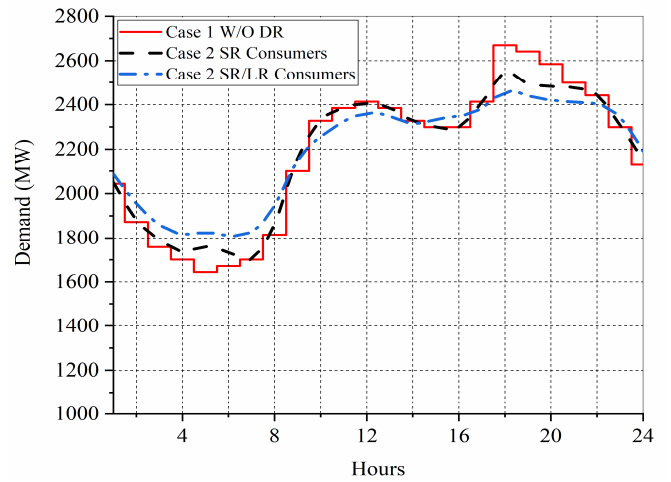

Fig. 4. Consumption profile for case 1 and case 2

their PEM only consists of diagonal elements with various values. Accordingly, the whole operation cost and customers' payment, are reduced to \$745240 and \$1102099, respectively. Results show 1% reduction in operation cost and 10% reduction in customers' payment compared to case 1. The amount of involuntary load shedding due to infeasibilities in wind power generation and the wind power curtailment are calculated 0.076% (2.05 MWh) and 0.23% (6.21 MWh) of the overall power demand, respectively. This reduction in load shedding amount and operation cost compared to the previous case proves the applicability of DR implementation in flexibility enhancement.

A different type of consumers may participate in DR so-called long range (LR) consumers who shift their usage over a broad span of hours. These consumers optimise their consumption in maximum acceptable range. In other words, their perception goes from the current time interval into the past (1st hour) and future (24th hour). It is supposed that half of the responsive consumers are SR and the other half are LR consumers. It means that we have 5% of whole consumers are SR ones and 5% of them are LR. As a result, the total operation cost is \$724877, 4% reduction compared to case 1.

Table 1 presents the calculated RT rates for different customers in case 2. The adjusted load curve in Fig.4 confirms that the load in peak intervals declines and the load in low-load intervals increases in comparison with case 1. In fact, high calculated RT rates for peak hours motivate consumers to change their consumption behaviour.

It is notable that, although various RT rates are calculated for different load buses to reach the best solution, we report only average hourly rates because of a large amount of data. For SR consumers, hourly load standard deviation and average peak are reduced from 329.89 MW and 2476 MW to 288.11 (87%) MW and 2365 (95%), respectively as a result of applying an appropriate RT pricing scheme in which average prices are reduced from 23.4 to 21.3 (91%).

These results confirm the potential of demand-side flexibility in providing a flatter load profile in systems with high penetration of wind power. For the situation that LR and SR consumers are considered together, hourly load standard deviation and average peak are reduced to 264.56 (80%) MW and 2301 (93%) MW, respectively.

Fig. 5 shows the hourly total operating cost for two different types of consumers. It shows the efficiency of the proposed scheduling model on operation cost reduction in peak intervals by shifting load to low-load times. Consumers like LR ones with the ability to shift their usage over a broader span of hours could get more benefit of this reduction.

Table 1 Optimal RT rates (\$/MWh) in case 2

Hour	LR/SR	SR	Hour	LR/SR	SR
1	18.41	21.79	13	26.46	23.19
2	16.99	19.44	14	26.07	23.19
3	14.82	15.08	15	22.51	23.19
4	14.82	15.08	16	22.43	23.19
5	14.66	14.92	17	27.82	25.06
6	14.74	14.92	18	30.12	26.91
7	15.19	15.89	19	29.26	25.60
8	15.19	15.89	20	28.31	24.97
9	15.58	16.12	21	27.96	24.97
10	26.88	24.79	22	23.35	23.40
11	26.39	23.04	23	21.05	23.40
12	27.46	24.22	24	18.90	23.00

Some terms of operation cost are given in Table 2 to assess the usefulness of the proposed model from the economic perspective. LR consumers are better options than SR ones in supporting wind power incorporation due to the wind power cost reduction and involuntary load shedding decrease in the face of wind power instability. In addition, LR consumers decrease the call for reserve due to the load reduction in peak hours.

It is notable that the increase in reserve cost for SR consumers in case 2 compared to case 1 is due to the fact that capacity reserve cost and deployed reserve cost are increased. This could be as a result of more required reserves in low load and off-peak hours to which the peak loads are shifted. If we had curtailable loads, the need for reserves would be decreased. In addition, although load shifting strategy is an effective strategy in facilitating wind power integration due to reducing wind power spillage in the face of wind power uncertainty, the FIT cost is increased and this will increase the total wind power cost in case 2 compared to case 1.

4.3. Case 3: Influence of wind power variations and component contingencies on generation planning without DR

This case considers N-1 contingencies and wind power uncertainty in order to examine optimal supply-side scheduling under a flat rate price scheme.

Table 2 Operation cost in cases 1 and 2

	Start-Up + Energy Cost (\$)	Reserve Cost (\$)	Wind Power Cost (\$)	Load Shedding (\$)
Case 1	497529	42608	208729	468
Case 2 (SR)	488484	45788	210536	428
Case 2 (SR/LR)	475053	39197	210212	415

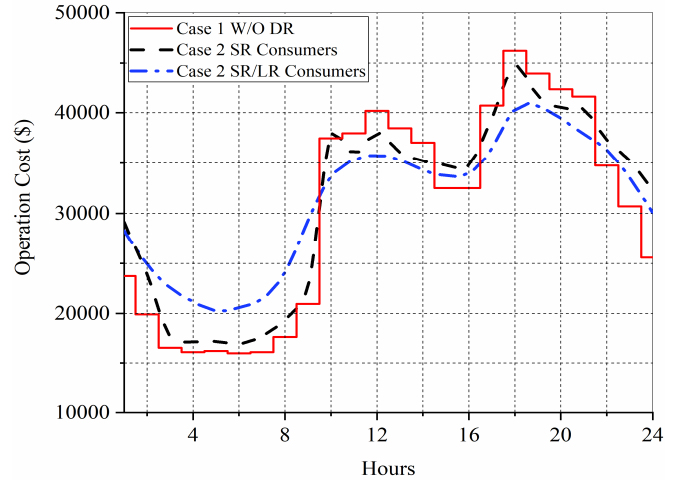

Fig. 5. Comparison of operation cost for case 1 and case 2

In this condition, operators should provide the necessary supplementary flexibility through the supply-side unit commitment. As a result, a unit commitment is obtained with the total operation cost of \$1,157,330. This (\$407,985) 54% increase in operation cost compared to case 1 is due to the fact that the ISO has to dispatch most expensive units even for 24 hours a day in order to preserve nonstop services with the smallest amount of load shedding. Provision of superior flexibility levels imposes some extra costs to the system operator due to the fact that in such conditions the peak load units should be started-up and work at a non-economically efficiency point. In addition, in this case, the cost of customers' comfort as a result of compulsory load shedding is added to the total operation cost. The quantity of calculated compulsory load shedding is 15.32% (409.08 MWh) of total system load, which can bring consumer dissatisfaction and extra costs. It means that ISO needs some healing actions such as DR implementation or using storages to reduce the customers' dissatisfaction and operation cost.

4.4. Case 4: Influence of wind power variations and component contingencies on generation planning considering DR

This case analyses the system flexibility as a result of supply-side and demand-side collaboration considering both component contingencies and wind uncertainty. Demand-side scheduling part is included in the problem using an effective RT program. RT program implementation with SR consumers reduces the total operation cost to \$1,067,223 (92 % of case 3) and enhances the system flexibility by declining the load shedding value to 52.14 MWh (13% of case 3). It is notable that, if like case 2 half of the responsive consumers are SR and the other half are LR ones, the operation cost and involuntary load shedding decrease to \$986,501 (85% of case 3) and 39.39 MWh (9.6% of case 3), respectively. The average of optimal RT rates at each hour is calculated and given in Table 3. Results show that in this case, the price change is more than the price adjustment in case 2 where the system only faced wind instability.

Fig. 6 presents the hourly system consumption profile, while Fig. 7 shows the comparison of operation cost for case 3 and case 4, respectively.

Comparison of operation cost in Fig. 7 shows that LR consumers act more efficiently in comparison with SR consumers in the face of component contingencies, especially in the peak period.

Moreover, details of operation cost in case 3 and case 4 in Table 4 verify the ability of supplementary flexibility in enhancing power system operation from the economic and technical point of view. In case 3, some generation buses are committed in all the scheduling time while the operator schedules others for nearly half of the scheduling horizon.

In case 4, when SR consumers participate in the DR, different units are committed for only 4 hours a day. Therefore, repeated commitment and re-commitment of units increase the start-up cost. On the other hand, when half of the customers are LR ones, the mentioned units are not committed at all. As a result, the start-up cost is diminished compared to the other cases.

Table 3 Optimal RT rates (\$/MWh) in case 4

Hour	LR/SR	SR	Hour	LR/SR	SR
1	20.41	21.79	13	26.55	24.12
2	16.78	19.06	14	25.14	23.42
3	14.59	14.78	15	23.08	23.19
4	14.52	14.78	16	22.81	23.19
5	14.23	14.49	17	27.89	25.81
6	14.40	14.63	18	30.41	27.99
7	15.17	15.58	19	29.49	26.80
8	15.17	15.58	20	28.44	26.02
9	15.93	16.12	21	28.36	25.94
10	27.02	25.53	22	24.64	24.29
11	26.46	23.96	23	22.65	23.61
12	27.68	25.43	24	21.05	23.00

Table 4 Operation cost in cases 3 and 4

	Start-Up + Energy Cost (\$)	Reserve Cost (\$)	Wind Power Cost (\$)	Load Shedding (\$)
Case 3	790973	67370	200878	98103
Case 4 (SR)	778665	71525	203989	13039
Case 4 SR/LR)	702434	73027	201206	9831

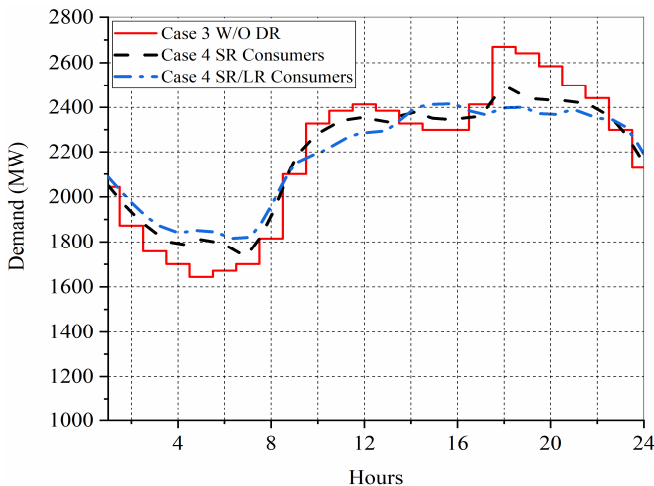

Fig. 6. Consumption profile for case 3 and case 4

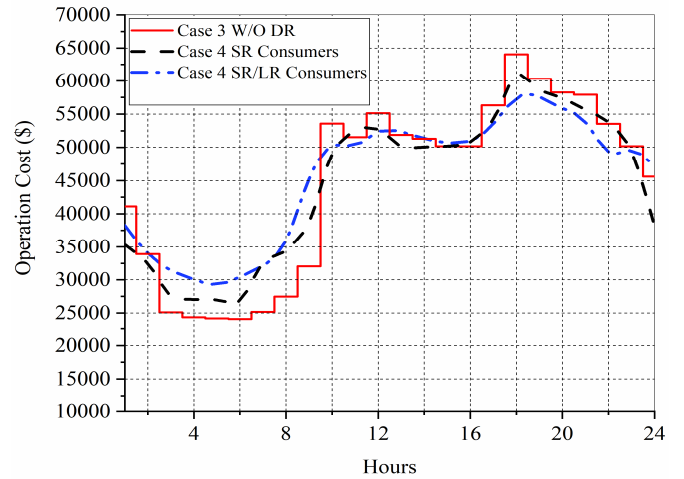

Fig. 7. Comparison of operation cost for case 3 and case 4

An identical reason can be applied for energy cost decrease as a consequence of SR and LR consumers' participation. Moreover, the load shedding cost is diminished by almost 87% and 90% because of the participation of SR and LR consumers, respectively. Thus, the authors conclude that in the emergency events, LR consumers could help the system more efficiently.

5. Conclusion

DR is one of the most effective and cheapest tools for ISO to improve network reliability while facing uncertainty and contingencies. This paper has modelled a security-constrained unit commitment structure in order to coordinate the operation of both supply-side and demand-side in the face of wind uncertainty and component contingencies. An optimum real-time pricing scheme was designed considering customers' behaviour to facilitate demand-side responsiveness and to assist the ISO to minimize the total operating costs. The simulation results illustrated that DR implementation led to a similar flexibility level at the generation-side and demand-side scheduling accessible with conventional units at a lower cost. Network cost is reduced up to 8%, and reliability is enhanced up to 88% percent for SR consumers. 15% decrease in operation cost and 90% reduction in load shedding value for a mixture of SR/LR consumers prove our claim that customers who have the ability to change their consumption over a broader time span are more effective in the case of both emergency events and wind power generation instability. A flatter load profile to the maximum extent and 10% reduction in average RT price as a result of DR implementation are other pieces of evidence that show the value of the proposed model to overcome power network issues such as network outages and the uncertainty of the renewable energy resources. Besides, the incorporation of DR influenced reserves deployment and customers' payment. The proposed model with such notable characteristics is an appropriate tool for managing power system fluctuation in response to wind power changes as well as unforeseen contingencies. Based on the obtained results, a few suggestions could be made to

enhance the operation of power systems with flexible consumers:

- Considering the more flexibility potential of LR consumers, regulations should be restructured to allow the highest participation rate of this type of consumers in DR events or even incentives should be designed to motivate other consumers to act like SRs.
- There are side effects from DR provided by consumers, such as comfort loss. Optimization algorithms could be designed to bring an excellent balance between maximum flexibility and minimum corresponding negative impact. In addition, DR programs could be modelled through a scenario-based customers' participation factor estimation. These ideas could be the focus of future works.

6. References

- [1] Cochran, J., Miller, M., Zinaman, O., et al.: 'Flexibility in 21st century power systems (No. NREL/TP-6A20-61721).' National Renewable Energy Lab.(NREL), Golden, CO (United States), 2014.
- [2] Eser, P., Singh, A., Chokani, N., et al.: 'Effect of increased renewables generation on operation of thermal power plants', *Applied Energy*, 2016, 164, pp. 723-732.
- [3] G. Morales-España, R. Baldick, J. García-González, A. Ramos, "Power-capacity and ramp-capability reserves for wind integration in power-based UC," *IEEE Trans. Sustainable Energy*, vol. 7, no. 2, pp.614-624, 2016.
- [4] Kiran, B.D.H. and Kumari, M.S.: 'Demand response and pumped hydro storage scheduling for balancing wind power uncertainties: A probabilistic unit commitment approach', *International Journal of Electrical Power & Energy Systems*, 2016, 81, pp.114-122.
- [5] Pazouki, S. and Haghifam, M.R.: 'Optimal planning and scheduling of energy hub in presence of wind, storage and demand response under uncertainty', *Int. J. Electr. Power & Energy Systems*, 2016, 80, pp.219-239.
- [6] Nikoobakht, A., Aghaei, J., Mardaneh, M., et al.: 'Moving beyond the optimal transmission switching: stochastic linearized SCUC for the integration of wind power generation and equipment failures uncertainties', *IET Generation, Transmission & Distribution*, 2017.
- [7] Nikoobakht, A., Mardaneh, M., Aghaei, J., et al.: 'Flexible power system operation accommodating uncertain wind power generation using transmission topology control: an improved linearized AC SCUC model', *IET Generation, Trans. & Distribution*, 2017, 11(1), pp.142-153.
- [8] Shao, C., Wang, X., Shahidehpour, M., et al.: 'Security-constrained unit commitment with flexible uncertainty set for variable wind power', *IEEE Transactions on Sustainable Energy*, 2017, 8(3), pp.1237-1246.
- [9] Alizadeh, M.I., Moghaddam, M.P., Amjady, N., et al.: 'Flexibility in future power systems with high renewable penetration: A review', *Ren. and Sustainable Energy Reviews*, 2016, 57, pp.1186-1193.
- [10] Heydarian-Forushani, E., Golshan, M.E.H., Shafie-khah, M., et al.: 'Optimal Operation of Emerging Flexible Resources Considering Sub-Hourly Flexible Ramp Product.' *IEEE Transactions on Sustainable Energy*, 2018, 9(2), pp.916-929.
- [11] Heydarian-Forushani, E., Golshan, M.E.H. and Siano, P., 'Evaluating the Operational Flexibility of Generation Mixture with an Innovative Techno-Economic Measure.' *IEEE Transactions on Power Systems*, 2018., 33(2), pp.2205-2218.
- [12] Dai X, Wang Y, Yang S, Zhang K. IGDT-based economic dispatch considering the uncertainty of wind and demand response. *IET Renewable Power Generation*. 2018 Oct 29.
- [13] Qazi, H.W. and Flynn, D.: 'Analysing the impact of large-scale decentralised demand side response on frequency stability', *International Journal of Electrical Power & Energy Systems*, 2016, 80, pp.1-9.
- [14] Zhang L, Good N, Mancarella P. Building-to-grid flexibility: Modelling and assessment metrics for residential demand response from heat pump aggregations. *Applied Energy*. 2019 Jan 1; 233:709-23.
- [15] Zeng, B., Wu, G., Wang, J., et al.: 'Impact of behaviour-driven demand response on supply adequacy in smart distribution systems', *Applied Energy*, 2017, 202, pp.125-137.
- [16] Wu, C., Hug, G. and Kar, S., 'Risk-limiting economic dispatch for electricity markets with flexible ramping products.' *IEEE Transactions on Power Systems*, 2016, 31(3), pp.1990-2003.
- [17] Aghaei, J., Alizadeh, M.I., Siano, P., et al.: 'Contribution of emergency demand response programs in power system reliability', *Energy*, 2016, 103, pp. 688-696
- [18] Dadkhah, A. and Vahidi, B.: 'On the network economic, technical and reliability characteristics improvement through demand-response implementation considering consumers' behaviour', *IET Generation, Transmission & Distribution*, 2017, 12(2), pp.431-440.
- [19] Ismael I, Saeed M, Kaddah S, Abdelkader S. Demand response for indirect load control in smart grid using novel price modification algorithm. *IET Renewable Power Generation*. 2018 Nov 22.
- [20] Karimi H, Jadid S, Saboori H. Multi-objective bi-level optimisation to design real-time pricing for demand response programs in retail markets. *IET Generation, Transmission & Distribution*. 2018 Dec 10;13(8):1287-96.
- [21] Lamadrid AJ, Munoz-Alvarez D, Murillo-Sanchez CE, Zimmerman RD, Shin HD, Thomas RJ. Using the Matpower Optimal Scheduling Tool to Test Power System Operation Methodologies Under Uncertainty. *IEEE Transactions on Sustainable Energy*. 2018 Aug 17.
- [22] Sgouras KI, Dimitrellos DI, Bakirtzis AG, Labridis DP. Quantitative risk management by demand response in distribution networks. *IEEE Transactions on Power Systems*. 2018 Jul 18;33(2):1496-506.
- [23] Imani, M.H., Niknejad, P. and Barzegaran, M.R. "The impact of customers' participation level and various incentive values on implementing emergency demand response program in microgrid operation." *International Journal of Electrical Power & Energy Systems*, 2018, 96, pp.114-125.
- [24] "Survey", <https://www.utilitydive.com/news/survey-only-14-of-utility-customers-participate-in-demand-response-progra/277222/>
- [25] ACEEE Summer Study on Energy Efficiency in Buildings., 'Targeting Small Businesses--The Search for 80/20 in the 20/80 World' (ACEEE, 2016), pp. 1-13
- [26] Australian Renewable Energy Agency., 'Demand Response Customer Insights Report' (Think Place, 2018), pp. 1-68
- [27] Aalami, H.A., Moghaddam, M.P., Yousefi, G.R.: 'Evaluation of nonlinear models for time-based rates demand response programs', *Int. J. Electr. Power Energy Syst.*, 2015, 65, pp. 282-290
- [28] Grigg, C., Wong, P., Albrecht, P., et al.: 'The IEEE reliability test system-1996', *IEEE Trans. Power Syst.*, 1999, 14, (3), pp. 1010-1020
- [29] Allen DJ. Analysis of the uptake of small and medium scale wind turbines under the Feed-in Tariff in Great Britain (Doctoral dissertation, University of Leeds).
- [30] He Y, Pang Y, Zhang J, Xia T, Zhang T. Feed-in tariff mechanisms for large-scale wind power in China. *Renewable and Sustainable Energy Reviews*. 2015 Nov 1; 51:9-17.
- [31] Hirschhausen, von, C. 2014. The German "Energiewende"—An introduction. *Economics of Energy and Environmental Policy* 3(2): 1-12
- [32] Bouffard, F., Galiana, F.D.: 'An electricity market with a probabilistic spinning reserve criterion', *IEEE Trans. Power Syst.*, 2004, 19, (1), pp. 300-307
- [33] Karki, R., Hu, P. and Billinton, R.: 'A simplified wind power generation model for reliability evaluation', *IEEE Trans. on Energy conversion*, 2006,21(2), pp.533-540.
- [34] Amjady, N., Aghaei, J. and Shayanfar, H.A.: 'Stochastic multiobjective market clearing of joint energy and reserves auctions ensuring power system security', *IEEE Trans. on Power Systems*, 2009, 24(4), pp.1841-1854.
- [35] Majzoobi, A. and Khodaei, A.: 'Application of microgrids in supporting distribution grid flexibility', *IEEE Trans. on Power Systems*, 2017, 32(5), pp.3660-3669.
- [36] Aghaei, J., Amjady, N., Baharvandi, A., et al.: 'Generation and transmission expansion planning: MILP-based probabilistic model', *IEEE Trans. on Power Systems*, 2014, 29(4), pp.1592-1601.
- [37] Parhizi, S., Khodaei, A. and Shahidehpour, M.: 'Market-Based Versus Price-Based Microgrid Optimal Scheduling', *IEEE Transactions on Smart Grid*, 2018, 9(2), pp.615-623.