

Ultimate and Residual Strength Assessment of Ship Structures

ARTJOMS KUZNECOVS

DEPARTMENT OF MECHANICS AND MARITIME SCIENCES
CHALMERS UNIVERSITY OF TECHNOLOGY
Gothenburg, Sweden 2020
www.chalmers.se

THESIS FOR THE DEGREE OF LICENTIATE OF ENGINEERING

Ultimate and Residual Strength Assessment of Ship Structures

ARTJOMS KUZNECOVS



Department of Mechanics and Maritime Sciences
CHALMERS UNIVERSITY OF TECHNOLOGY
Gothenburg, Sweden 2020

Ultimate and Residual Strength Assessment of Ship Structures

ARTJOMS KUZNECOVS

© ARTJOMS KUZNECOVS, 2020

Report No 2020:07

Chalmers University of Technology
Department of Mechanics and Maritime Sciences
Division of Marine Technology
SE-412 96, Gothenburg
Sweden
Telephone: + 46 (0)31-772 1000

Printed by Chalmers Reproservice
Gothenburg, Sweden 2020

Ultimate and Residual Strength Assessment of Ship Structures

ARTJOMS KUZNECOVS

Chalmers University of Technology

Department of Mechanics and Maritime Sciences

Division of Marine Technology

Abstract

The prevention of ship structural failures and reduction of accident consequences contribute to increased safety at sea and reduced environmental impact. A need for reliable and efficient ship designs facilitates knowledge accumulation and the development of tools for the assessment of hull structural responses to acting loads. Important in this regard, ship design criteria are the ultimate and residual strengths of a hull that determine whether a ship may be safely operated in intact and accidentally damaged conditions. Thus, an accurate and reliable procedure for estimating a ship's strength accounting for all actual foreseeable scenarios and reasonably practicable conditions is necessary.

The main objective of this thesis is to develop a new precise and time-efficient methodology for the assessment of the ultimate and residual strength under vertical and biaxial loading conditions. A coastal oil tanker and a RoPax vessel were chosen for the parametric study of the ship's structural arrangement, load type and corrosion effect on the crashworthiness and ultimate strength. Collision simulations under varying conditions were carried out by means of the finite element method. The assessment of the ultimate and residual strength was performed with the Smith method together with finite element analyses.

The thesis work contributed to a better understanding of the modelling and analysis setup for the realistic ultimate and residual strength estimates. A new approach for modelling corrosion in ship structures, which includes models for plate thickness reduction and corroded materials, was developed. Different collision damage modelling techniques were compared, and the importance of making full collision simulations, including plastic deformations and residual strains, was shown. The differences and limitations of the finite element and Smith methods were discussed, and improvements to the Smith method along with a new calibration procedure were introduced. The study resulted in a new unified methodology, combining the precision of the finite element method and the efficiency of the Smith method, for the assessment of the ultimate and residual strength of ships.

Keywords: age-related degradation, collision, corrosion, nonlinear FEA, residual strength, ship structures, Smith method, ultimate strength.

Preface

This thesis is comprised of the research work carried out at the Division of Marine Technology, Department of Mechanics and Maritime Sciences at the Chalmers University of Technology during the years 2018 – 2020. Financial support for this research was provided from the project SHARC (structural and hydro mechanical assessment of risk in collision and grounding) funded by the Swedish Transport Administration under grant agreement: TRV 2019/42277.

I would like to express my gratitude to my supervisors Professor Jonas W. Ringsberg and Adjunct Professor Erland Johnson for inspiring me through their dedication to work, marine engineering and science. Their professional guidance and thoughtful support have helped me to reach this milestone, and more to come. I am very grateful to Dr. Zhiyuan Li and Dr. Shun-Han Yang for their great support during the early stages of my academic life. In addition, I would like to thank Dr. Per Hogström for the kind support on models and engaging discussions.

I would also like to thank all my colleagues at the Division of Marine Technology for creating a fruitful environment where I could find inspiration and new ideas. Likewise, thank you Xiao Lang for becoming a good friend.

This thesis is dedicated to my beloved family and to my high school teacher Elena A. Averyanihina, who laid a grain of curiosity into my mind.

Artjoms Kuznecovs
Gothenburg, March 2020

Komarovo

Divers search for treasures, but I don't need any
I don't want ships to sink in the deep blue sea
For a week, until the 2nd I am going to Komarovo,
I don't want ships to sink in the deep blue sea

Lyrics: *Mikhail Tanich*

Music: *Igor Nikolaev*

Contents

Abstract	i
Preface	iii
List of appended papers.....	ix
List of other published papers by the author	xi
Nomenclature	xiii
1 Introduction	1
1.1 Background and motivation	1
1.2 Objective.....	6
1.3 Assumptions and limitations	6
1.4 Outline of the thesis.....	8
2 Overview of methods for the collision and ultimate and residual strength analyses	9
2.1 Ultimate strength	9
2.2 Ship-ship collisions	14
2.3 Age-related degradation - corrosion	15
2.4 Material modelling	17
3 Numerical models and methodology	19
3.1 Methods, software and numerical codes	20
3.2 Scenario-based parametric analyses	20
3.2.1 Case study vessels	21
3.2.2 Collision parameters	21
3.2.3 Constitutive material and damage models	22
3.2.4 Corrosion modelling	22
3.2.5 Loading conditions.....	23
3.2.6 Summary of the scenarios studied	24
3.3 Numerical model of ship-to-ship collisions	25
3.3.1 Description of the finite element models	25
3.3.2 Setup of ship-to-ship collision analyses.....	25
3.3.3 Energy analyses.....	25
3.4 Numerical model of the ultimate strength analysis	26
3.4.1 Finite element analyses	26
3.4.2 The Smith method.....	27
3.5 Post-processing of the ultimate strength analyses	28
3.5.1 RSI analyses.....	29

3.5.2 Calibration of the Smith method.....	29
4 Results	31
4.1 Summary of Paper I.....	31
4.2 Summary of Paper II	34
5 Conclusions	39
6 Future work.....	41
7 References	45

List of appended papers

For each of the two appended papers, the author of this thesis contributed to the ideas presented, planned the paper with the co-authors, performed the numerical simulations, and wrote the manuscript together with the co-authors.

- Paper I** Ringsberg, J.W., Zhiyuan, L., Johnson, E., Kuznecovs, A., Shafieisabet, R. (2018). *Reduction in ultimate strength capacity of corroded ships involved in collision accidents*. Ships and Offshore Structures, 13: 155-166. DOI:10.1080/17445302.2018.1429158.
- Paper II** Kuznecovs, A., Ringsberg, J.W., Johnson, E., Yamada, Y. (2020). *Ultimate limit state analysis of a double-hull tanker subjected to biaxial bending in intact and collision-damaged conditions*. Submitted for publication in Ocean Engineering (under review).

List of other published papers by the author

Paper A Ringsberg, J.W., Zhiyuan, L., Kuznecovs, A., Johnson, E. (2018). *Analysis of the ultimate strength of corroded ships involved in collision accidents and subjected to biaxial bending*. Progress in Maritime Technology and Engineering - Proceedings of the 4th International Conference on Maritime Technology and Engineering (MARTECH 2018): 327-336, 7-9 May 2018, Lisbon, Portugal, Eds: Soares, C.G., Santos, T.A., DOI: 10.1201/9780429505294-38.

Paper B Kuznecovs, A., Ringsberg, J.W., Yang, S-H., Johnson, E., Johansson, A. (2019). *A methodology for design and fatigue analysis of power cables for wave energy converters*. International Journal of Fatigue, 122: 61-71. DOI: 10.1016/j.ijfatigue.2019.01.011.

Nomenclature

Greek notations

β	Shape factor [-]
χ	Curvature [m^{-1}]

Latin notations

CF	Calibration factor [-]
M_{UV}, M_{UH}	Vertical and horizontal ultimate bending moments respectively [Nm]
M_y, M_z	Bending moments about y- and z-axes respectively [Nm]
$R_{IE, struck}$	Internal energy share ratio for the struck ship [-]

Abbreviations

BWH	Bressan-Williams-Hill Criterion
CDI	Collision Damage Index
CP	Control Point
CPU	Central Processing Unit
CSR	Common Structural Rules
CSR-H	Common Structural Rules Harmonized
DE	Material Damage Evolution Model
DI	Material Damage Initiation Model
DOF	Degree of Freedom
FE	Finite Element
FEA	Finite Element Analysis
FEM	Finite Element Method
GBS	International Goal-Based Ship Constructions Standards
IACS	International Association of Classification Societies
IMO	International Maritime Organization
ISFEM	Intelligent Supersize Finite Element Method
ISSC	International Ship and Offshore Structures Congress
ISUM	Idealized Structural Unit Method
LSE	Load-Shortening Elongation Curve
MV	Motor Vessel
NA	Neutral Axis
NFEM	Nonlinear Finite Element Method
NVA	Det Norske Veritas Grade A Steel
RoPax	Roll-on/Roll-off Passenger Vessel
RSI	Residual Strength Index
SLS	Serviceability Limit State
SOLAS	The International Convention for the Safety of Life at Sea
SSC	Ship Structure Committee
ULS	Ultimate Limit State
URSA	Ultimate and Residual Strength Assessment
VLCC	Very Large Crude Carrier

1 Introduction

Waterborne transport has become widely spread due to its efficiency and is a vital part of existing communication systems. The main task of a cargo vessel is to transport goods between ports of call in the most efficient and sustainable way. From a naval architect perspective, this means providing a safe and reliable ship design with a large cargo carrying capacity and high performance, on the one hand, and with reduced energy consumption, low environmental impact and minimized related expenses, on the other hand.

Nevertheless, water- and wave-induced bending is the dominant load acting on a ship. At certain loading conditions and because of the ship's structural response to the imposed loads, the ultimate limit state (ULS) of a structure may be reached. The limit state is a condition under which a particular structural element or an entire structure fails to perform its designated functions, and the ULS is characterized by global collapse of the structure. In the worst-case scenario, the excess of the maximum load carrying capacity of a hull, i.e., the ultimate strength, can result in the loss of a ship, of lives and negative environmental consequences. To ensure a safe design, it is crucial to have extensive knowledge and proper tools for the assessment of the ultimate strength for intact, age-degraded or accidentally damaged ship structures.

The following section explains the concept of the ultimate strength and provides background and motivation for research within the field of the ULS of ship structures.

1.1 Background and motivation

The ultimate strength is the maximum load carrying capacity that a structure can sustain until the ultimate limit state - a condition when collapse of a structure due to the loss of stiffness and strength occurs - is reached. There have been several accidents due to structural failure caused by excess ultimate bending strength in modern shipping history (Sumi, 2019), and some disastrous examples are shown in Figure 1. The very large crude carrier (VLCC), Energy Concentration, broke its back in 1980 during an oil discharge operation (Rutherford, 1990). Despite the accident occurring in calm waters, the cargo distribution led to hogging bending moments in excess of the ship's design longitudinal strength and resulted in bottom failure by stiffener tripping.

In 1997, an old and improperly maintained product tanker, MV Nakhodka, with great structural degradation due to corrosion in the fore part broke in two off the coast of Japan (Watanabe and Ohtsubo, 1998; Yao et al., 1998). The cargo loading condition and wave-induced bending moment during heavy seas exceeded the ultimate strength of the structure, which was reduced by half due to corrosion. The progressive collapse was initiated in the bottom by a fracture, and the ship broke in two in sagging. Several years later, another severely corroded single hull tanker, MV Prestige, broke in two and sank in 2002 near the Spanish coast (SSC, 2003). The vessel was counterflooded to minimize the consequences of the initial damage to the bottom plating and remained afloat for six days. However, due to continuous wave impact and internal sloshing, the tanker broke in two in a sagging condition. Both accidents with tankers resulted in oil leakages that caused tremendous negative environmental impacts.

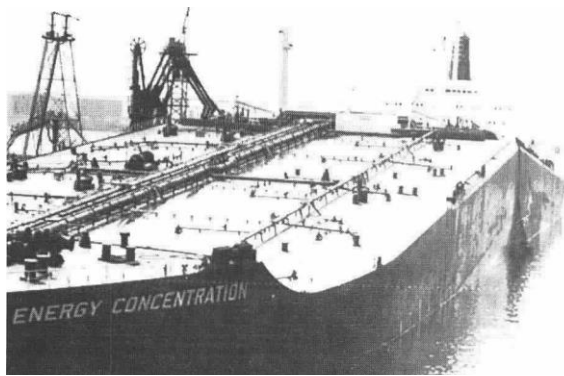

(a)

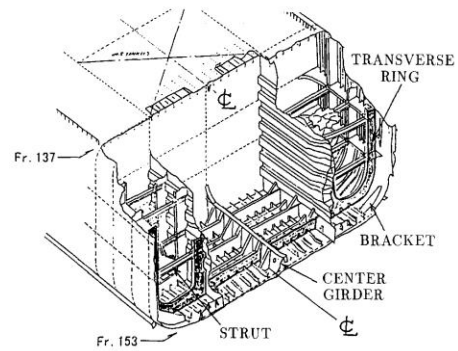

(b)



(c)



(d)

Figure 1. Examples of accidents when the ultimate strength of ships was exceeded: (a) hinged hull of the VLCC Energy Concentration in the Port of Rotterdam, 1980 (Rutherford, 1990); (b) sketch of the fractured aft part of the MV Nakhodka lying on the seabed 2500 m below sea level, 1997 (Yao et al., 1998); (c) the MV Prestige just before sinking, 2002 (SSC, 2003); (d) aft section of the MOL Comfort container vessel after separation, 2013 (MRCC Mumbai, 2013).

One of the most recent examples of ship losses related to the exceedance of the ULS occurred as late as 2013. During extreme weather conditions, the large container vessel MOL Comfort broke in two in a hogging condition (ClassNK, 2014). The vessel had an adequate design longitudinal strength that was estimated to be 150% of the wave-induced bending moments. However, the buckling collapse of the bottom panel occurred under biaxial compression due to the superposition of local lateral loads and vertical bending. The loss of this vessel triggered classification societies and researchers worldwide to revisit existing ship rules and guidelines related to the ULS in ship design and maintenance rules.

To stipulate technological development and prevent future accidents, both technical causes and their backgrounds must be identified by examining historical accidents when the ultimate strength of ships is exceeded. During the 1970s-1980s, the rapid upsizing of oil tankers and bulk carriers took place. Such large vessels, such as the bulk carrier Onomichi Maru (Yamamoto et al., 1983), had never been built before, but old practices and techniques were utilized during design and construction. Knowledge regarding how to treat such large vessels was lacking. A similar problem appeared later in the 2000s when container vessels with unconventional structural arrangements and innovative designs became widely used and grew in size. Ships such as the MOL Comfort and MSC Napoli (MAIB, 2008) unpredictably suffered severe damage in hogging under slamming loads.

In addition to lack of knowledge, another source of increased risks associated with the exceedance of the ultimate strength emerged in the 1990s. Poorly maintained or substandard ships, e.g., MV Nakhodka, MV Erika (CPEM, 2000) and MV Prestige oil tankers, suffered from severe corrosion damage, and the ultimate strength was drastically decreased compared to their design values. Finally, a disastrous operational condition due to human error may also result in an accident similar to that of the VLCC Energy Concentration. Consequently, as history shows, minimizing risks associated with transportation of goods by sea is crucial for the sustainable development of the shipping industry and the society benefiting from it. Thus, a safe and reliable design of ships together with properly defined procedures for regular operations and action in case of accidents is naturally important to reach the goal of achieving sustainable shipping. This objective is supported by the SOLAS convention and International Goal-Based Ship Constructions Standards (GBS) (IMO, 2010):

“Ships shall be designed and constructed for a specified design life to be safe and environmentally friendly, when properly operated and maintained under the specified operating and environmental conditions, in intact and specified damage conditions, throughout their life”.

This is a high-level objective or Tier I goal in the GBS framework (see Figure 2) that addresses the structural safety of bulk carriers and oil tankers. The GBS became mandatory for bulk carriers and oil tankers 150 m in length and above. According to the GBS Tier II functional requirement, ships shall be designed to have adequate ultimate strength or the maximum global hull girder load carrying capacity and shall be verified for a representative longitudinal bending moment (IMO, 2010).

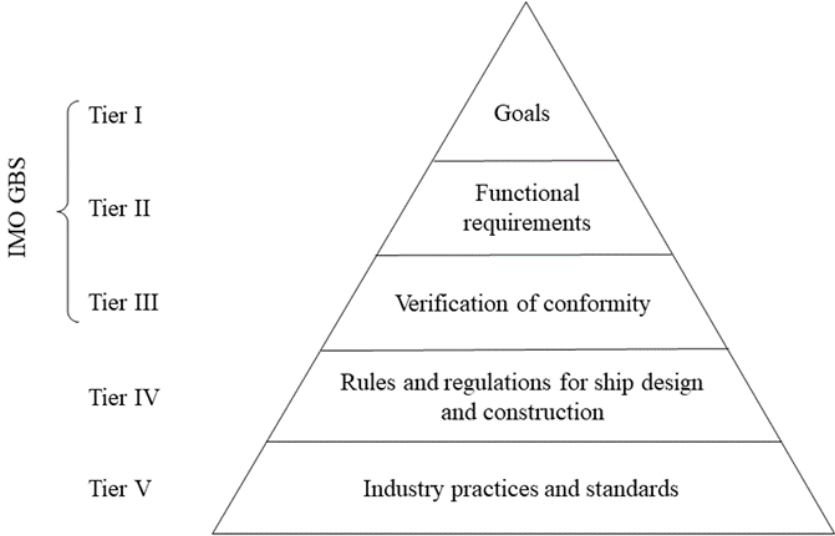

Figure 2. Goal-based standards framework (IMO, 2010).

As described earlier in this section, the ultimate strength is the maximum load carrying capacity that a structure can sustain until the ultimate limit state - a condition when collapse of a structure due to the loss of stiffness and strength occurs - is reached. The loss of capacity may be affiliated with the yielding or fracture of separate structural members that have reached their maximum load carrying capacity. Yielding refers to the irreversible deformation after the load is relieved, and a fracture is attributed to the separation of a component into several parts due to an imposed load. Instability from buckling and plastic collapse is another factor affecting the structural load carrying capacity. Buckling is an elastic instability resulting in the sudden large deflections of structural components, and plastic collapse is initiated by local deformations in yield.

Structural dimensions are usually defined by the proportional limit of a system (see point A in Figure 3) to avoid large or permanent deformations of a structure or its components. The design load level defines the loading limit a structure is expected to not exceed; hence, it will always respond elastically to all loads it is subjected to without permanent deformation due to its plasticity. This level is defined according to the serviceability limit state (SLS) of the structure. If the proportional limit is exceeded, then the response of the structure is no longer elastic due to the initial yielding and is followed by the buckling strength (point B). If the point of the ultimate strength (point C) is exceeded, then no judgement of the safety margin can be made. To ensure an adequate safety margin, namely, the difference between the ultimate strength and an extreme applied load, it is necessary to account for uncertainties related to loads, materials, geometry, and software. Thus, an efficient and safe structure can be obtained.

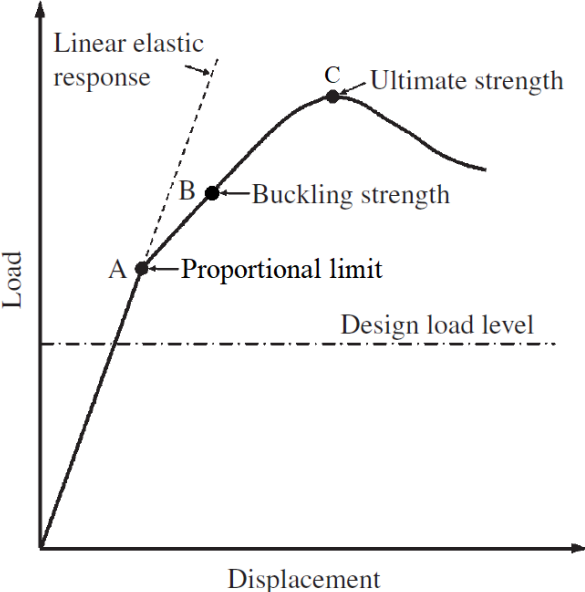

Figure 3. ULS behaviour of structures.

An assessment of the ultimate strength is required to estimate the robustness and survivability of a structure with existing in-service or accident-induced damage. After several accidents, such as in the case of the MV Prestige (SSC, 2003), the concept of “residual strength” was introduced to GBS under a new SOLAS regulation II-1/3-10 (IMO, 2010). Residual strength refers to the ability of a structure to withstand wave-induced and internal loads under specified damaged conditions. A residual strength assessment refers to a ship hull’s condition and survivability beyond point C in Figure 3.

A ship hull’s capacity to sustain imposed vertical bending loads, i.e., pure sagging or hogging, is the fundamental ULS design criterion. However, due to operation in oblique waves, roll motions of a vessel or list, a combination of vertical and horizontal bending moments may occur. This loading condition is also referred to as biaxial bending. If a biaxial bending load is applied, then the resulting response of a hull structure will no longer be symmetric. Similar loading conditions can give rise to torsional loads, which are especially important for consideration for hulls with open cross-sectional profiles, such as container vessels.

Structural safety is a critical requirement and thus necessitates accurate and reliable procedures for the estimation of a ship’s bending strength. The ultimate strength can be assessed experimentally, numerically or analytically. Full-scale experimental investigations are usually

expensive and impractical during design. Numerical simulations of hull bending by the nonlinear finite element method (FEM) to obtain the ULS of ships are becoming more extensively used due to increased computational capacities. The main advantage of the FEM is the possibility of having very detailed geometrical, material and load models. In addition, complex loading conditions, such as in the case of the MOL Comfort, may be investigated in detail, and thus, new findings may be used for the enhancement of existing designs and codes. Another advantage of the FEM is the possibility of capturing realistic damage due to ship grounding or ship collision accidents, for example. The effect of damage opening together with associated deformations and residual stresses on the ultimate strength are studied by following bending simulations; see procedure by Yamada (2014), for example. Numerical simulations carried out by the FEM are time consuming and costly for large-scale structures such as ships.

Analytical methods have been developed continuously to provide simple, fast, and sufficiently accurate tools for the prediction of the ultimate strength (ISSC, 2018). The most common approach to assess the ultimate strength is a progressive collapse method proposed by Smith (1977). In the Smith method, the ship’s cross section is divided into independent structural elements. Curvature is applied incrementally, and the average strains of the elements are found by making use of the plane bending assumption; i.e., plane sections remain planar during bending. The response of each element is found as an average stress according to the predefined load-shortening elongation (LSE) curve (see Figure 4). LSE curves are defined for both the compression and tension states. The yielding and buckling behaviour of plates and plate-stiffener combinations are considered as well. The reactive bending moment for every curvature increment is then found as a sum of the stress contributions from each element around the instant neutral axis. Since the neutral axis is moving, the sectional response becomes highly nonlinear. The result is a moment-curvature relationship with its peak value representing the ultimate strength of the hull.

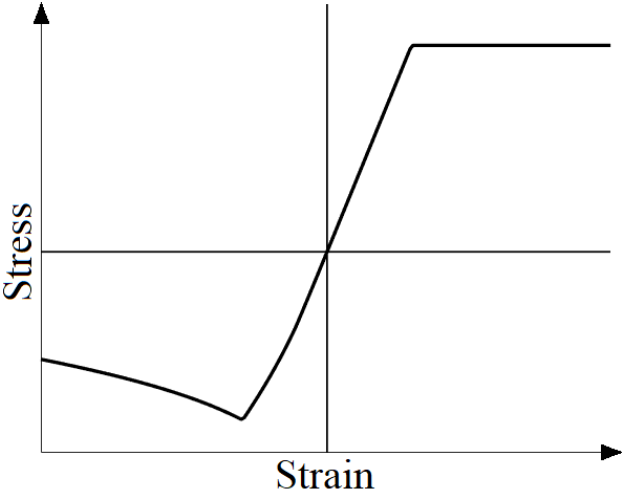

Figure 4. A schematic LSE curve with consideration of element buckling during compression.

The methods are not limited to the FEM and the Smith method. A historical overview and state-of-the-art methods for ULS analyses are given in Section 2. This section presents the motivation behind the development of the ULS assessment procedures together with the main principles and limitations behind the theories and methods.

1.2 Objective

Finite element-based analyses can be time consuming, both from a modelling and simulation perspective, while Smith-type methods require significantly less computation time. Finite element models can be made very detailed and realistic for the scenarios they are designed to simulate, but recent studies of semi-empirical Smith-type methods have shown that the difference between them under vertical bending conditions is acceptable. However, the conformity of the two methods under biaxial bending conditions has not been well studied.

As shown by Yamada and Ogawa (2011), the direct numerical simulation of ship-ship collisions for an estimation of the damage extent is an important tool for capturing the actual deformations and residual stresses that affect the residual strength of a ship structure. Meanwhile, residual strength FE analyses are mainly carried out with simplified damage openings, usually with prismatic box shapes. The dimensions of the box opening are either assumed or determined statistically or numerically. Only a few studies consider realistic damage openings due to collision accidents with both residual stresses and plastic deformations for ULS assessments by applying the FEM.

There have been few studies in the literature that systematically present the consequences of both corrosion on the collision resistance and the ultimate strength. Moreover, most frequently, the corrosion onset is represented by a reduction in the material thickness, while a change in material properties is usually omitted or assumed to be of no importance.

The main objective of this thesis is to develop a precise and time-efficient methodology for the ultimate and residual strength assessment of ship structures under vertical and biaxial bending. The procedure should be applicable for intact and damaged (i.e., with a damage opening) ships. Moreover, it should be possible to compare newly built ships with age-related corrosion damage to assess the residual strength. The research presented in the thesis has defined the following four main goals:

- (i) Propose a methodology for modelling corroded vessels in FEM simulations that includes models for plate thickness reduction and corroded materials. Quantify the reduction in the ultimate strength capacity of a ship structure using the proposed methodology compared to the state-of-the-art procedure.
- (ii) With regard to the ultimate strength, quantify the importance of making full FE collision analyses for the residual strength assessment, instead of using simplified collision damage shapes without plastic deformations and residual strains.
- (iii) Quantify the necessity of studying the ultimate and residual strength under biaxial bending loads where the location and orientation of the force neutral axis are continuously updated.
- (iv) Develop a methodology that unifies the simplicity of the Smith method and the fidelity of FE analyses in a new method that is efficient and accurate.

1.3 Assumptions and limitations

Engineering problems are usually very complex and may incorporate combined loads acting on very large and sophisticated structures. However, to make a safe and reliable design, it is necessary to predict the structural behaviour under certain circumstances. To achieve that, models describing the processes and mechanics of the problem are developed with some simplifications of reality. These simplifications or assumptions are unavoidable to make the problem solvable. The use of models and methods based on some assumptions can be justified

if they predict the behaviour reasonably well in a well-defined range of conditions. Therefore, the assumptions and limitations of the methods selected are presented in the current section.

One of the study limitations is that the constitutive models of corroded materials, describing the materials' behaviour due to different loads, are based on experimental data by Garbatov et al. (2014; 2017). However, due to lack of data on necking strain, when a large local deformation in tension and the post-necking behaviour of the material are initiated, it was assumed that the corroded material follows linear plastic hardening and fails after reaching the fracture strain. The thickness reduction of plating associated with corrosion was assumed to be linearly time-dependent with the vessel's age. To ensure a conservative solution, it was assumed that ships were never re-coated to represent severe corrosion conditions.

The main purpose of FE ship-ship collision simulations was to obtain realistic structural damage. Thus, only internal collision mechanics were considered; i.e., motions of the colliding ships and their interaction with the surrounding water were omitted. This assumption holds reasonably well if colliding ships are of similar size and the duration of the impact is short (Zhang et al., 2019a). Another restriction was that residual stresses and initial imperfections due to fabrication were disregarded.

The bending load in the ULS FE simulations was applied by the rotation of end planes around fixed points (see Section 3.4.1). Compared to four-point bending, the applied approach can impede the translation and rotation of the actual force neutral axis, which can result in an erroneous failure sequence. Moreover, in the case of intact ship models, hull girder collapse can occur outside the midship section since no instability triggers were present. The effect of the boundary conditions on the measured ultimate moments was not established.

The ULS analyses were also performed by the Smith method, which is based on Euler-Bernoulli beam theory and incorporates the following assumptions:

- (i) Plane sections remain planar after bending
- (ii) Sections keep their shape after bending
- (iii) Small deformations

Assumption (i), however, can be violated after either the plastic or stability limits of the structure components are reached if the force equilibrium is sustained. In general, this is the main concern in the post-ultimate condition of the hull girder. Assumption (ii) means that no sideways distortion of the cross section is present. A ship hull can be exposed both to bending and torsional loads, and both assumptions (i) and (ii) imply that the imposed load is pure bending. Thus, to enable a comparison of the FE and the Smith methods, only pure bending loads were considered in the study. Based on assumption (iii), Smith (1977) proposed that if the bending load was applied gradually and the curvature increments were sufficiently small, then no iterative procedure was required to find the stress distribution within the cross section.

The response of the independent structural elements in the Smith method was described by semi-numerical equations, which were defined according to IACS (2019), where the nonlinear behaviour of the structure elements was defined using the Ramberg-Osgood formula with a correction for the plasticity. This approach may lead to the underestimated bending stiffness of the girder in the post-elastic region. In addition, the collapse of structural components in compression is limited to the interframe collapse modes. Thus, the Smith method may not be suitable for unconventional lightweight hulls constructed from high-tensile steels or aluminium, which may fail in grillage collapse modes (ISSC, 2018). The accuracy of equations defining LSE curves is discussed in Section 2.1.

Materials in the Smith method were modelled as elastic-perfectly plastic. This assumption implies limitations on the inelastic behaviour of the structural components. Thus, the response of the ship structure may be affected at the ultimate and post-ultimate states. The damage propagation and strain hardening were excluded from the calculations. The plastic deformation and distortion of separate structural members affected by collision were not considered. Additionally, the residual stresses due to collision accidents were disregarded. Only the damage opening extent and location were modelled (see Section 3.4.2).

Finally, it must be clarified that two ship types with different structural designs were investigated in this study. The applied rules and guidelines regarding corrosion margins vary accordingly. Therefore, the results from this study cannot be applied generally to all kinds of ships.

1.4 Outline of the thesis

The structure of the thesis is as follows: Section 2 presents an overview of existing methods for ultimate and residual strength analyses. Section 3 presents numerical models and methods used in the thesis together with their limitations and assumptions. Section 4 presents a brief summary of the results presented in the two appended papers. The conclusions are presented in Section 5, followed by suggestions for future work in Section 6.

2 Overview of methods for the collision and ultimate and residual strength analyses

This section presents an overview of existing methods for the collision, ultimate and residual strength analyses. The pros and cons of the methods, various material and corrosion models together with their effect on the crashworthiness and ULS are discussed.

2.1 Ultimate strength

Modern ships are steel plated structures that generally have an elongated prismatic shape. Brunel in 1850 was the first to consider a ship hull as a thin-walled beam and applied the beam theory to ships during the design and construction of The Great Eastern – the largest ship of its time (Rutherford, 1990); see Figure 5. Decades later, the theory of longitudinal strength was formalized by John (1874) and became a standard in ship structural design. John assumed a wave of the same length as that of a ship on which it is acting. The main principles of Brunel's and John's works are still relevant and are still used today. However, in both Brunel's and John's works, the plating thickness was determined based on the breaking or rupture strength of the material. Thus, the yielding, buckling and ultimate strength phenomena were omitted.

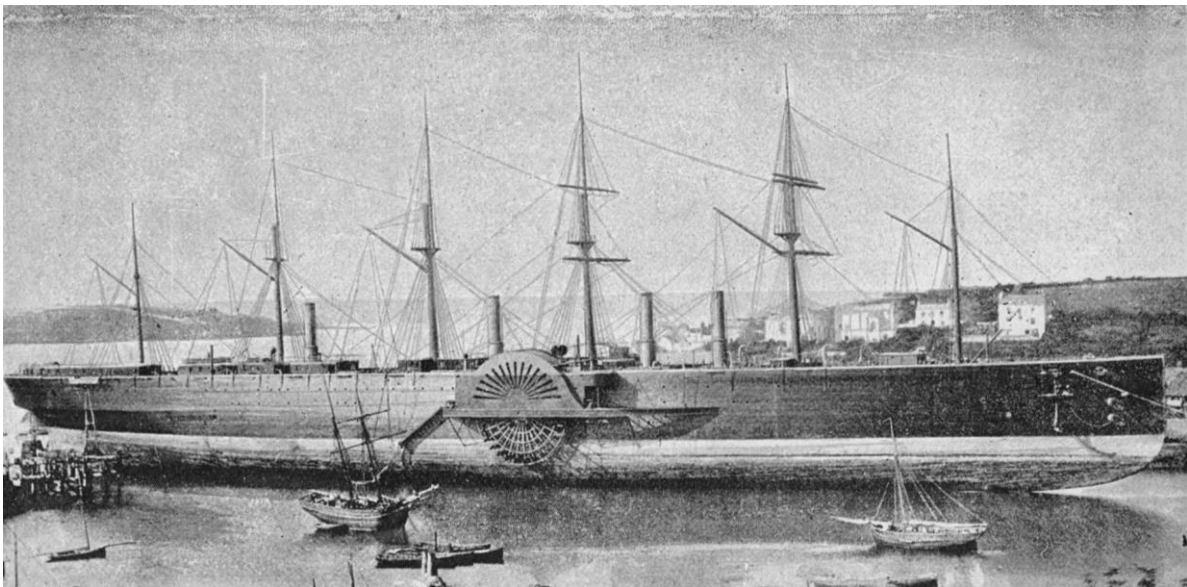

Figure 5. The Great Eastern (Maginnis, 1900).

Closed-form methods

The first attempt to calculate a ship's global ultimate strength in bending with respect to yielding and buckling was done by Caldwell (1965) by idealizing a cross section consisting of stiffened panels with panels of equivalent thickness, i.e., by simplifying the geometry; see Figure 6b. The strength is found by a closed-form semi-analytical expression based on the presumed stress distribution due to bending with buckling reduction factors. The approach with the assumed stress distribution was further extended in Paik and Mansour (1995) and Paik et al. (2013) and resulted in an explicit analytical equation for calculating the ultimate strength. The described closed-form methods are based on the assumption that the ULS is determined by the condition when all structural members have reached their peak capacity simultaneously, i.e., the force neutral axis (NA) is fixed. The assumption neglects that ultimate failure is a progressive event and that some of the components may fail prior to the ULS. Moreover, the post-ultimate behaviour of a hull cannot be captured.

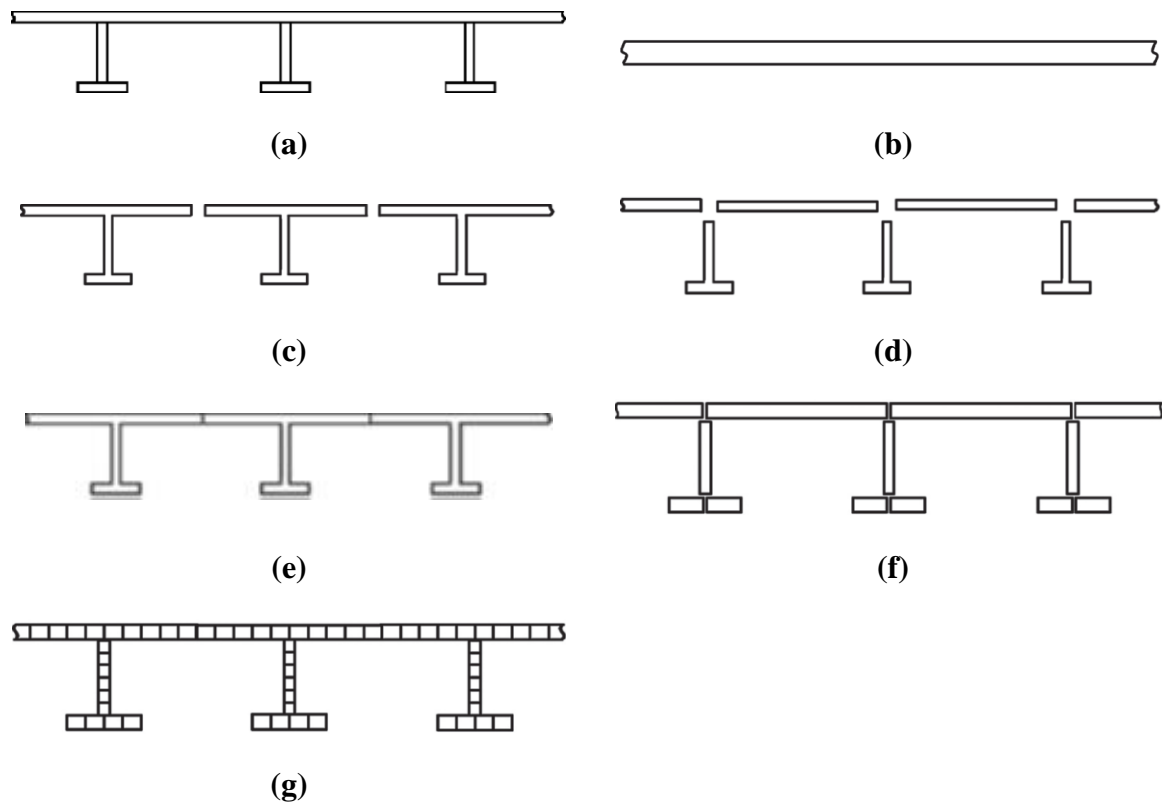

Figure 6. Different idealizations of: **(a)** a typical stiffened plate; **(b)** equivalent thickness model; **(c)** plate-stiffener combination model; **(d)** plate-stiffener separation model; **(e)** large-sized special purpose finite elements; **(f)** supersize finite element model; and **(g)** finite element model (Paik, 2018).

Progressive collapse methods

The hull failure of the VLCC Energy Concentration was investigated by Rutherford (1990). After a retrospective analysis of the accident, it was concluded that the modelling of the progressive buckling collapse of compressed parts is essential for the correct prediction of the bending resistance. The progressive collapse method that Rutherford applied was proposed by Smith (1977). The Smith method incorporates a simplification of the hull's cross section by subdividing it into several structural elements acting independently only in the axial direction according to either the plate-stiffener combination or separation scheme (see Figures 6c and 6d, respectively). The main principles and assumptions of the Smith method are described in Sections 1.1. and 1.3. Dow et al. (1981) examined the trustworthiness of the Smith approach and compared the results with box girder vertical bending tests conducted by Dowling et al. (1973). The agreement between numerical assessment and tests was found to be satisfactory for small-scale models. In addition, we investigated the effect of so-called “hard corner” elements (see Section 3.4.2. for details) and demonstrated the importance of their inclusion in the Smith-type models.

Several variations and modifications of the Smith method were proposed by other researchers: Gordo and Soares (1996), Choung et al. (2012), Fujikubo et al. (2012) and Tekgoz et al. (2018). The focus of the introduced improvements was on enabling the calculation of the ultimate strength under asymmetrical conditions either due to geometry or applied loading. The cross-sectional symmetry can be violated if damage opening due to, e.g., collision or grounding, is introduced. An early application of the progressive collapse analysis method to damaged structures is described in a study by Smith and Dow (1981). Damage in the bottom and side-

shell plating were considered, but the force NA was restricted from rotation. To address the issues associated with asymmetry, it is important to allow the rotation of a force neutral axis. Otherwise, values of bending ultimate strength are overestimated. Currently, classification rules require checking for pure vertical bending only with the constrained rotation of the NA, while an uncertainty in the strength estimates under damaged conditions is covered by applying safety factors (IACS, 2019).

To account for asymmetry due to loading, i.e., the combination of vertical and horizontal bending moments, Gordo and Soares (1997) proposed an interaction equation. Coefficients describing the shape of the interaction curve were based on the biaxial analysis of the intact tanker and container ships with the approximate Smith-based method, see Gordo and Soares (1996). Later, the same methodology was applied to damaged ship structures with assumed accidental damage openings by Gordo and Soares (2000).

The Smith-type method with the procedure proposed by Fujikubo et al. (2012) was applied by Makouei et al. (2015) to obtain a direct design formula to predict the normalized residual strength of damaged vessels. A good correlation between the applied progressive collapse analysis method and box girder bending tests carried out by Lee et al. (2008) and Saad-Eldeen et al. (2010) was found. Moreover, it was reaffirmed that the constrained rotation of force NA results in an overestimation of residual strength. Damage in the hull of a double hull tanker studied was characterized by a “damage box” - a parallelepiped with given dimensions.

Hussein and Soares (2009) applied the Smith method for the ultimate and residual strength assessment of double hull tankers designed according to Common Structural Rules (CSR) (IACS, 2019). Damaged cases were based on assumed idealized damage openings according to the rules. The residual strength index (RSI), initially proposed by Fang and Das (2004), was utilized as a convenient measure for the comparison of damaged and intact hulls. The reliability analysis of damaged ships has shown that the still-water and wave-induced bending moments are equally important. The increase in still-water bending moment due to damage and flooding was considered.

Load-shortening elongation (LSE) curves

Every element’s response to imposed strain loads in the Smith method is prescribed by load-shortening elongation (LSE) curves; see Figure 4. LSE curves can be obtained by applying semi-empirical formulae, by direct calculations using the FEM or by experiments. A much improved understanding of plate buckling was gained with the help of finite element numerical methods. LSE curves for square plate elements are summarized in ISSC (1979) and are presented as diagrams for different slenderness ratios and initial distortion and residual stress levels. The effect of initial imperfections on the ultimate compressive strength of long rectangular plates was investigated by Dow and Smith (1984) and Smith et al. (1988). Geometrical nonlinear plate theory was applied in the panel ultimate limit state (PULS) models, recognized by Det Norske Veritas and is used for the prediction of the ultimate capacity limit of stiffened panels (Steen et al., 2004). While the accuracy of the Smith method is enhanced by using databases with LSE curves obtained from FE analyses (Downes et al., 2017), the approach lacks generality and requires a separate FE simulation for every beam-column combination.

One of the first attempts to formulate general approximate relations describing LSE curves was conducted by Gordo and Soares (1993). Idealized LSE curves are common for codes utilizing the Smith method and are prescribed for use by the classification societies’ rules (IACS, 2019; BV, 2020). The effect of initial distortions and residual stress due to manufacturing is accounted

for by the reduced effective plating width (Faulkner, 1975) according to expressions derived by Frankland (1940) and Faulkner (Caldwell, 1965). Alternative equations for calculating the ultimate strength of stiffened panels with initial imperfections were proposed by Masaoka and Mansour (2008), and Zhang and Khan (2009).

Chen and Soares (2015) have shown that compared to the FE solution, the LSE according to the CSR for bulk carriers (IACS, 2006) underestimates the ultimate strength of stiffened panels with weld-induced residual stress and deformation by 2.1%. Similar trends in the beam-column elements' pre-ultimate conditions were observed by Gannon et al. (2016), but with an overestimation of the post-ultimate capacity by the idealized LSE curves. Notably, this behaviour can give nonconservative results for the global hull girder ultimate strength, despite the lower values for the element's compressive strength.

More advanced numerical methods

In parallel to the development of the Smith method, Ueda and Rashed (1984) proposed the idealized structural unit method (ISUM). At the time of the development of these methods, the computing power was very limited (Beghin, 2013). The aim with the ISUM, as with the Smith method, was to reduce modelling efforts and computational times required in the conventional FEM while preserving an acceptable accuracy during the nonlinear analysis of large plated structures (Paik and Thayamballi, 2002). To reduce the number of degrees of freedom (DOFs) and, consequently, the complexity of a problem, the structure of interest in the ISUM is modelled with special purpose finite elements representing one large-sized structural component (see Figure 6e). The special purpose elements are formulated to model the actual nonlinear behaviour of structural units. The idea behind the Smith method is similar to the ISUM; thus, it can be classified as a type of ISUM with a cross section composed of inter-independent elements and tailored for specific loading conditions.

With increased computing power available, more DOFs could be introduced for enhanced accuracy. The intelligent supersize finite element method (ISFEM) proposed by Hughes and Paik (2013) and implemented in ALPS/HULL software (ALPS/HULL, 2017) is similar to the FEM. The ISFEM model consists of large rectangular plate elements with preformulated nonlinear behaviour. The assembly of elements in ISFEM is performed in a similar manner to that in FEM (see Figure 6f). ISFEM can be used for progressive collapse analyses under combined biaxial bending, shearing forces and torsional moments. Some examples of successful ISFEM applications are found in Faisal et al. (2017) and Youssef et al. (2017), among others.

Faisal et al. (2017) statistically analysed a large data set with historical collision accidents of oil tankers and selected representative damage cases. The residual strength with idealized damage openings was analysed with ISFEM, and probability density functions for the RSIs were proposed as a method for the rapid hull collapse strength estimation after a collision. At the same time, the ISFEM was used for the development of diagrams for the rapid assessment of ship safety, showing relations between the collision damage index (CDI) and RSI (Youssef et al., 2017). The CDIs, defined as a reduction in the vertical moment of inertia, were obtained for 4 case vessels with simplified probabilistic damage patterns.

Nonlinear finite element simulations

Elastic analyses, initial yielding and assumed stress distributions are simple ultimate strength assessment methods; see "Closed-form methods" in Section 2.1. The use of simple methods is well suited for making first estimates during the design phase. The advanced Smith method,

ISUM and ISFEM are more accurate than experiments and can handle nonlinear responses and asymmetric geometries and loadings. However, the most accurate models with a high level of detail can be obtained by using the nonlinear finite element method (NFEM). FE models may include high geometry precision (see Figure 6g), nonlinear material properties and complex loading conditions. In addition, the post-ultimate behaviour of a structure can be explicitly captured.

One of the earliest attempts to apply the NFEM for global hull girder collapse analysis was carried out by Chen (1983). Today, the application of the NFEM has become widespread due to both increased computational capacities and a better understanding of modelling techniques. Yamada (2014) investigated the ULS of bulk carriers after a ship-ship collision. ULS analyses were performed by means of the FEA, and the results were compared to the Smith method. A fairly good agreement between the methods was found, with the Smith method giving slightly more conservative results in terms of safety, reaffirming the conclusions drawn in an earlier study by Yamada and Ogawa (2011). It was also found that the artificially assumed damage opening can result in an overestimation of the residual strength compared to the realistic collision damage, including deformations and residual stresses obtained by FE collision analysis.

The effect of boundary conditions and an extension of the FE model on the ultimate strength estimates under biaxial bending was studied by Tekgoz et al. (2018). It has been observed that while the number of bays or transverse sections included in the model have a negligible effect on the ULS, its effect is more pronounced in the post-ultimate regime. The opposite was reported during the ISSC (2012) benchmark study, where it was found that the hull girder model has to be sufficiently large to capture the ULS correctly. Since sophisticated modelling techniques are required, some practical recommendations for the FEM setup of ULS simulations are summarized in ISSC (2018). In addition, Corak and Parunov (2020) conducted an assessment of the structural reliability of oil tankers in the Adriatic Sea. Residual strength in vertical and horizontal bending was calculated with regression equations, and the biaxial strength was found through the interaction equation. While the damage extent was obtained by NFEM collision simulations, the coefficients for regression and interaction equations were developed based on NFEM ULS simulations with an assumed collision damage opening shape and size (Parunov et al., 2018).

Complex FE models allow the consideration of combined loading conditions, omitted in Smith-type methods otherwise. Darie et al. (2013) investigated the ultimate hull girder capacity in hogging under combined global and local loads under alternate loading conditions by means of the FEA and compared the results with the Smith method. Compared to the Smith method, a reduction in the ultimate strength by approximately 20% was found via the FEA due to the presence of local loads resulting in bending of the double bottom. These findings were supported by recent research by Tatsumi et al. (2020) and Tatsumi and Fujikubo (2020). Moreover, many efforts have been made to estimate procedures for the correct estimation of the ships' residual strength due to accidental damage. The deliberate modelling of a damage type and characteristics is crucially important for the realistic prediction of the remaining load carrying capacity of a damaged vessel. Thus, a procedure for estimating the damage associated with accidents is necessary.

2.2 Ship-ship collisions

One of the most important accident scenarios for consideration during the design of a crashworthy vessel with adequate residual strength is a ship-ship collision that represents 20% of serious accidents at sea globally (Papanikolaou et al., 2015) and 26% involving ships under the flag of European Union member states (EMSA, 2019). A similar distribution over accidents by type is observed in Swedish territorial waters (Transportstyrelsen, 2017). See Figure 7 for a recent collision example.



Figure 7. Collision between Ro-Ro Ulysse and containership CSL Virgin Star (Marine Nationale, 2018).

In a collision accident, the safety margin against the ultimate limit strength may be greatly reduced depending on the collision scenario and the resulting damage opening shape, size and location in the struck vessel. Thus, the estimation of collision consequences is an important task prior to the residual strength assessments. Several studies have numerically investigated how the hull's structural response and resulting damage opening are affected by different collision parameters, namely, the collision velocity, impact location, collision angle, indenter shape and properties, struck vessel type and structural arrangement (Hogström and Ringsberg, 2013; Ringsberg et al., 2017; Yamada et al., 2005; Zhang et al., 2019b). For oblique collision angles, the damage opening area is reduced since more energy is dissipated by sliding friction compared to a collision at a right angle (Ringsberg et al., 2017). It was reported in Hogström and Ringsberg (2012); Ringsberg et al. (2017) that the damage extent is greatly overestimated if the striking bow structure is modelled as a rigid indenter and all impact energy is absorbed by the struck ship. Different impact locations were studied by Baxevanis (2019), and the largest damage opening area was observed when the deformable forecastle of the striking ship was missing the side structure of the struck vessel. Since the bulbous bow structure is very stiff, most of the energy was dissipated by folding and crushing of the struck side structure. It was also found that if a striking ship with a larger draft and forecastle is involved in collision, then the opening area is smaller, while surrounding plastic deformations are extensive.

2.3 Age-related degradation - corrosion

Steel plated structures exposed to sea environments are prone to corrosion. Corrosion damage can negatively affect the crashworthiness of ships since it reduces the ship structure's capacity to sustain the loads it is subjected to. The reduced strength of corroded structures is associated with a loss of the effective thickness that can resist loads on the one hand and with a reduced stiffness and yield limit of the material on the other hand. Altered material properties affect the range of the elastic response, stability and maximum load carrying capacity of the structural components. Therefore, the ships' ultimate strength and crashworthiness after years of operation can be reduced drastically due to corrosion onset compared to the as-built condition. Liu et al. (2018) numerically showed that the ability of a ship structure to absorb energy during impact caused by stranding, a grounding event similar to a collision from an internal mechanics perspective when tension and folding/crushing are the main failure modes, is drastically reduced by the presence of corrosion. Due to the reduced ability of resisting impact loads, the damage to the struck structure is more extensive, and the opening area is larger. The ultimate strength of plated structures is also reduced due to corrosion effects. Poorly maintained substandard ships may have serious corrosion damage that can result in structural failure because of the reduced bending strength. The MV Nakhodka in 1997, MV Erika in 1999 and MV Prestige in 2002 are examples of break-in-two accidents preceded by severe deterioration due to corrosion.

Corrosion wastage is a material loss from the surface resulting in a reduction in the effective plate thickness and, consequently, the load carrying ability of a member affected by corrosion. Paik et al. (2003a; 2003b) developed nonlinear time-dependent corrosion wastage models after statistically analysing tanker and bulk carrier structures and proposing different corrosion rates for different structural member groups depending on their respective location and orientation. Later, an advanced statistical method for the empirical formulation of time-dependent corrosion wastage models was proposed by Paik and Kim (2012). Recently, a novel approach and new probabilistic model for corrosion degradation for tankers and bulkers, including probabilistic uncertainty, were derived by Lampe and Hamann (2018). Campanile et al. (2015) presented a study on the residual strength of bulk carriers, including the effect from corrosion, using a corrosion model proposed by Paik et al. (2003b). The results show how the influence of material corrosion leads to a significant decrease in the RSI. There are several investigations on the buckling ultimate strength that support this finding for intact structures that suffer from either minor or major corrosion wastage, e.g., Saad-Eldeen et al. (2011).

To compensate for material loss, industrial practices require a corrosion margin to be added to the net required thickness according to the net scantling approach (IACS, 2019). The IACS regulation of CSR-H requires a reduction in the corrosion margin, according to the net scantling approach, by 50% when evaluating the ultimate strength as well as the residual strength (IACS, 2019). The importance and influence of various corrosion addition practices were investigated by Kim et al. (2014). It was shown that the effect of corrosion additions decreases with the increased length of a vessel and that sagging bending moments are more critical for the ultimate strength than hogging.

In addition to the decrease in the material thickness, the plate surface has many pits due to the corrosion nonuniform onset. During loading, geometrical irregularities give rise to stress concentrations that negatively affect the plate's ultimate strength. The modelling of pits in large-scale structures is impractical and requires large computational efforts at the current state of computer technology. One way of handling the problem and accounting for the effect of pits is to apply a phenomenological approach when it is assumed that material properties depend on the degree of degradation; i.e., a plate with even surface acts as if pit distortions were present.

This approach was initially proposed by Garbatov et al. (2014), who developed corrosion grade-dependent material models based on the tensile strength tests of corroded specimens (see Figure 8).



Figure 8. A box girder that was initially corroded in real sea water conditions from which the specimens for the tensile strength tests were cut from (Saad-Eldeen et al., 2011).

To sustain good conditions and extend the operational lifetime of a ship's structure, it is regularly maintained and repaired while dry-docked. During repair work, corroded surfaces can be treated in different ways: by sandblasting, sand-paper cleaning, high-pressure fresh-water cleaning or hammering. It was shown in Garbatov et al. (2016; 2019) that the mechanical properties of corroded plates will be affected differently depending on the selected corrosion treatment procedure. A risk-based framework for maintenance planning including degradation due to corrosion was developed by Garbatov et al. (2018).

Garbatov et al. (2017) compared the numerical and experimental results of load carrying capacity tests of stiffened plates subjected to nonuniform corrosion degradation. It was reaffirmed that corrosion is of paramount importance for the ultimate strength and is affected by the degree of degradation, pit density and change in material properties. Woloszyk et al. (2018) numerically investigated the effect of changes in material characteristics due to altered corrosion degradation levels, initial imperfections and boundary conditions on the ultimate strength of plates and proposed an approach for avoiding the use of pitted surfaces by an alternative equivalent thickness approach. It is claimed that such an approach may be employed for efficient ultimate strength assessments.

The crashworthiness of ships subjected to corrosion has been rarely studied. The effect of corrosion is typically represented as a plate thickness reduction; see Ringsberg et al. (2017), Jurisic et al. (2017) and Yamada and Ogawa (2011). Recently, the change in material properties due to corrosion was considered by Campanile et al. (2018a; 2018b) in a study on the residual strength of a single-side bulk carrier and a double hull oil tanker (case vessels from the ISSC (2012) benchmark study) subjected to collision and corrosion damage by applying the Smith-type method. The corrosion onset was represented by the wastage combined with the applied randomness in the material properties. Simplified collision damage openings were obtained by making use of two collision models, namely, deterministic and stochastic. The maximum failure probability was found. One of the study outcomes, supporting the necessity of accurate accidental damage predictions, was that deterministic collision damage openings prescribed by different rules need revision since they are unlikely to be representative for residual strength analyses.

2.4 Material modelling

Samuelides (2015) presented methods for determining the damage of ship structures and discussed the importance of proper material modelling. Constitutive models define the material's behaviour during an imposed load: its initially elastic response followed by plastification, strain hardening until damage initiation (DI), damage evolution (DE) and, finally, its fracture. In the case of impact loads, such as a collision, all abovementioned parameters define energy absorption by the structural components, their crushing modes and, consequently, the overall resulting damage. In addition, material constitutive models define the collapse modes, the yielding criteria of structural components during bending and the global progressive collapse behaviour.

Correct material modelling with the proper choice of failure criteria is crucial for realistic numerical collision and grounding simulations. It was shown by Calle and Alves (2015) that failure strain and crack propagation are highly dependent on the mesh size. Hogström et al. (2009) compared existing material failure models by experiments and numerical simulations, including the Bressan-Williams-Hill (BWH) criterion proposed by Alsos et al. (2008). It was confirmed that the Barba's law relation (Barba, 1880) applied by Yamada et al. (2005) and Alsos et al. (2009) for FE simulations is valid for the strain evaluation after necking. The material modelling aspects, the uncertainties of the input in the finite element simulations and their importance for ship survivability after collision were studied in Hogström and Ringsberg (2012). Furthermore, Ehlers (2010a; 2010b; 2010c) conducted a series of works, including experiments, on the analysis of the material failure criterion to simulate rupture during collision simulations. It was shown that the failure strain is element length-dependent and that the choice of the material relation affects the accuracy of the nonlinear finite element simulations. The study was extended by investigating the properties of shipbuilding steel exposed to subzero temperatures and their influence on the collision resistance of ships (Ehlers and Ostby, 2012).

Marinatos and Samuelides (2015) worked towards a unified methodology for material modelling in ship collision and grounding simulations with respect to the material curve, rupture criterion, mesh size and strain rate effects. These researchers have shown that the consistency in numerical results is obtained with the use of an equivalent plastic strain relation. Storheim et al. (2015) developed a damage-based failure model for coarsely meshed structures based on the power law plasticity with the BWH criterion and a coupled damage model after incipient necking.

3 Numerical models and methodology

This section presents a short summary of the methods and models used throughout Papers I and II, before examples of the key results are presented in Section 4. A new methodology is presented in the thesis for the ultimate and residual strength assessments. The workflow is shown in Figure 9 and consists of four main steps. First, the study case scenario is identified with the selection of representative initial conditions and input parameters. In the next stage, a collision simulation is performed to obtain a realistic damage opening, followed by ultimate strength analysis. Both the FE and Smith methods are applied. Finally, the obtained results are post-processed, and the results obtained by the Smith method are calibrated. This section follows the structure of the workflow, and methodology is presented in Sections 3.2-3.5, preceded by a description of the software and numerical codes used in Section 3.1.

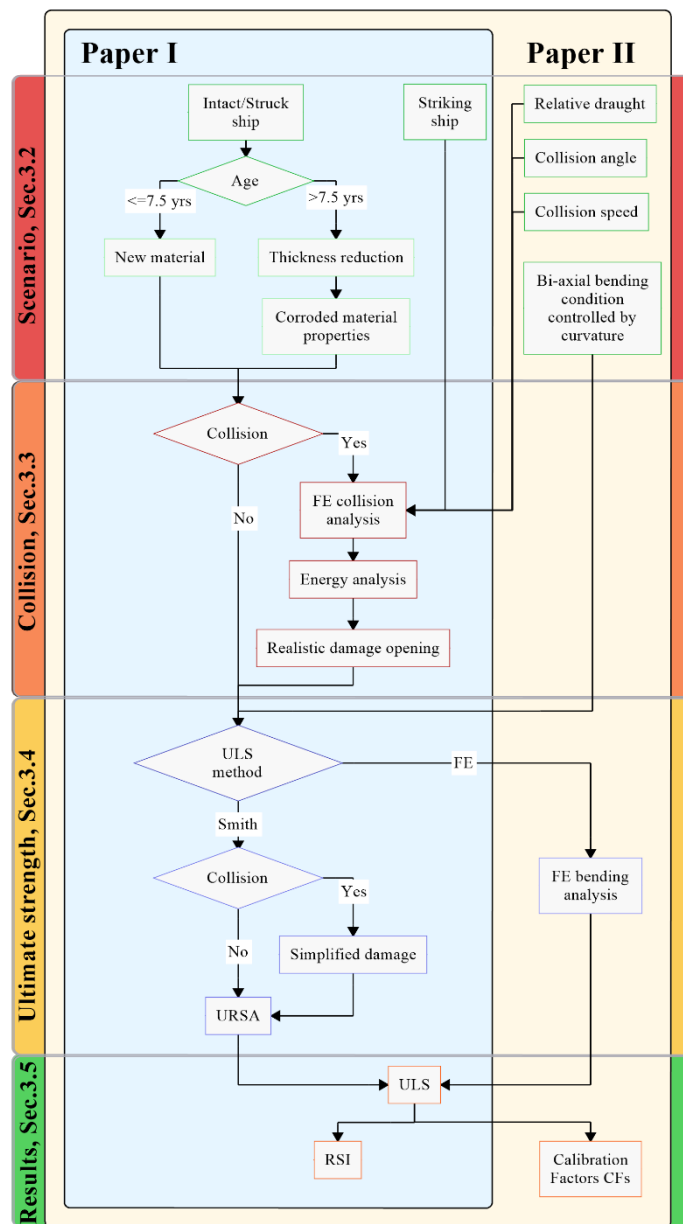

Figure 9. Methodology developed during the thesis work.

3.1 Methods, software and numerical codes

The methodology for the FE collision simulations was developed in Paper I and, to a large extent, was based on the works by (Hogström and Ringsberg, 2012; 2013) and Ringsberg et al. (2017). The FE analyses were carried out using the software Abaqus/Explicit ver. 6.13-3 (Dassault Systemes, 2013). The vertical ultimate strength was assessed by an in-house MATLAB code URSA (Ultimate and Residual Strength Assessment). This code was developed by the author of this thesis and is based on the Smith-type method proposed by Fujikubo et al. (2012). The Smith method applied is an incremental semi-numerical method for the simplified ULS analysis of ships subjected to pure bending.

The URSA code was verified against other studies in the literature by Kuznecovs and Shafieisabet (2017). The method was used due its ability to consider the instant translation and rotation of the force neutral axis (NA) during bending. The reader is referred to the works by Fujikubo et al. (2012), Kuznecovs and Shafieisabet (2017) and Paper I for a detailed description of the methodology. The consideration of biaxial bending conditions and other refinements to the code were introduced and presented in Paper II together with the implementation of the methodology for ULS analyses by means of FEA.

In the numerical simulations using the FE method, a substantial amount of time and effort is required to prepare the model and to conduct the simulation. Computational times and costs are high, but detailed results and the possibility of investigating different failure modes and post-collapse characteristics justify it for a few FEAs. For the same type of analysis, the Smith method is less computationally demanding and much faster than the FE method. One FE bending simulation takes up to 60 CPU hours, while for the same type of analysis and same computational power available, the Smith method requires less than a minute. However, the Smith method has limitations in the type of results that can ultimately be provided. Thus, to enhance the efficiency of the ULS analyses while maintaining good accuracy, a methodology for the calibration of the results from the Smith method by few FEAs was developed and presented in Paper II.

3.2 Scenario-based parametric analyses

Case study ships of selected type and size are common along the west coast of Sweden (see Figure 10), where ship traffic density is high and there are crossing ship traffic and fairways between Denmark and Sweden. Concerns regarding the negative environmental consequences in the case of ship collision accidents and the risk of ship loss have been raised. Hence, the ultimate and residual strength of this type of ship are relevant for studying both intact and collision-damaged conditions. The sensitivity of the crashworthiness and the calculated ultimate strength capacity of the ship due to its physical condition is also an important factor that can be investigated by comparing the properties of newly built ships and ships aged due to corrosion. The strength capacity of the ship structure must also be known for biaxial bending conditions to account for arbitrary wave encounter loading conditions, especially for damaged ship structures. The following subsections provide a brief summary of the assumptions and settings in the scenario-based simulations presented in Papers I and II.



Figure 10. A typical coastal product tanker for operation in Nordic countries (Veritas Tankers Rederi AB).

3.2.1 Case study vessels

Two different ships, namely, one coastal oil tanker and one coastal RoPax ship, were studied for comparison of their ultimate and residual strengths (see Figure 11). Coastal oil tankers are used for the transportation of oil/chemical products in inland or coastal waters or for bunkering (fuelling). Since the tanker was built for operation in the Northern and Baltic seas, it has an ice belt (i.e. the outer side plating near the waterline has extra thickness). For compliance with regulations, the tanker has a double hull structure. RoPax is a vessel intended for freight of vehicles and passenger accommodation. The vessel has an outer weather deck and two interior vehicle decks. Both vessels have longitudinally stiffened double bottom and decks, while double side-shells are stiffened transversely.



Figure 11. The geometry of the inner structure of: **(left)** the coastal oil tanker; **(middle)** the RoPax ship; and **(right)** the bulbous bow section of the striking tanker ship.

The striking ship was a tanker of a similar size (see Figure 10). In the work by Hogström and Ringsberg (2012), it was shown that modelling of a striking vessel as a rigid structure will overestimate the damage to a struck ship. Thus, to obtain realistic damage, the striking tanker was modelled with a deformable bow section in the as-built condition. Detailed information regarding the dimensions and structural arrangement of the vessels can be found in Paper I.

3.2.2 Collision parameters

The focus of this thesis with regard to accidental damage is on ship side collisions between two similar-sized vessels. Different collision angles and impact locations were investigated by Ringsberg et al. (2017) and Baxevanis (2019), respectively. To obtain the largest damage opening to the side plating and obtain the most critical condition from the ULS perspective, the collision scenario in the study was a right-angle collision with the struck ship fixed. The collision impact was always amidships and between the bulkheads and web frames. The maximum bending moment is usually attained at the midship section, and because of that, it is important to check whether a hull around midships will have adequate strength under intact and collision-damaged conditions. In addition, ships are more vulnerable to collision impacts between frames. The relative vertical location of colliding vessels was aligned by the keel level (see Figure 15a).

Usually, real collision speeds vary between 5 and 7 knots, and these two speeds were investigated by Ringsberg et al. (2017). Collision simulations in Paper I were performed with an initial impact speed of 7 knots. The effect of different collision speeds on the crashworthiness was parametrically studied in Paper II. The speed range was larger and varied between 2 and 8 knots. In addition, contact friction coefficients were taken as 0.3 and 0.5 for non-corroded corroded materials, respectively. The value of 0.3 was applied even to the wetted outer surfaces, i.e., below the waterline, regardless of the corrosion state, as marine biofouling acts as a lubricant and decreases the friction between plates.

3.2.3 Constitutive material and damage models

The case study ships were built with NVA grade shipbuilding mild steel. Henceforth, materials for newly built and aged vessels are called non-corroded and corroded materials, respectively (see Section 2.3). The non-corroded NVA material was represented by a nonlinear elastic-plastic constitutive material model with isotropic hardening following the power law. The influence of strain rate effects was considered using the Cowper-Symonds relationship (Cowper and Symonds, 1957). Two models were combined to represent the material characteristics for failure and degradation leading to fracture: a model for damage initiation (DI) and a model for damage evolution (DE). In the current study, the shear criterion is used for damage initiation (DI) at the point of necking, and it is followed by a bilinear law for DE up to the point of fracture, in accordance with the recommendations relating to the element size in FE models made in (Hogström et al., 2009). See Paper I for a detailed description of the material modelling.

3.2.4 Corrosion modelling

During the lifetime of a ship, the hull is subjected to corrosion, which results in a reduced thickness of its structural members and altered material properties. The material loss and reduction of the thickness were determined by the time-dependent corrosion wastage model proposed by Paik et al. (2003a), with a corrosion margin reduction. Materials for every structural member are assigned individually according to the reduction in the as-built thicknesses, since different hull parts may have a nonuniform corrosion onset due to different environments they are exposed to (see Figure 12).

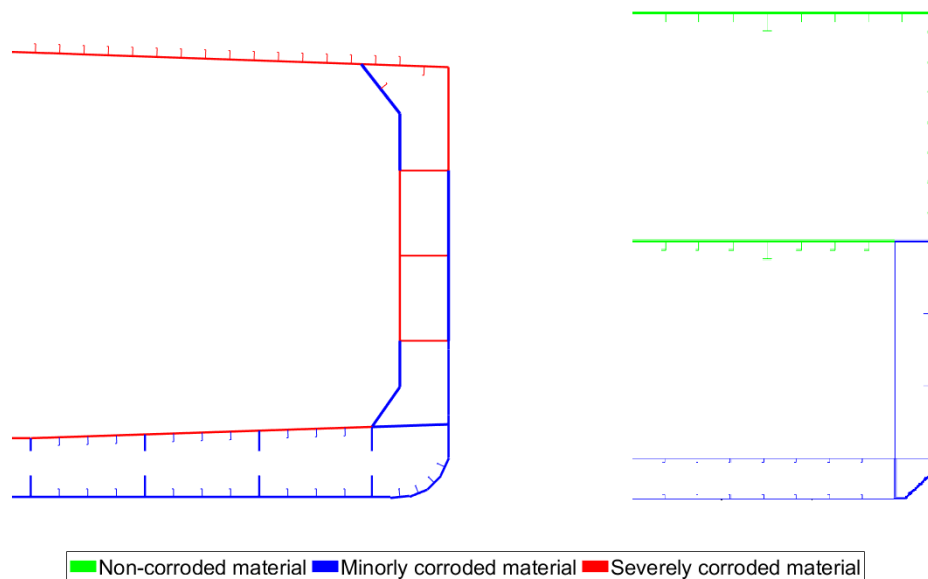

Figure 12. Corrosion patterns of: **(left)** the tanker and **(right)** the RoPax vessels at the age of 25 years.

Three different representations of NVA steel were used depending on the grade of corrosion: NVA virgin (non-corroded), NVA minorly corroded and NVA severely corroded; see Figure 13 for their respective strain-stress curves. A summary of all material parameters can be found in Paper I.

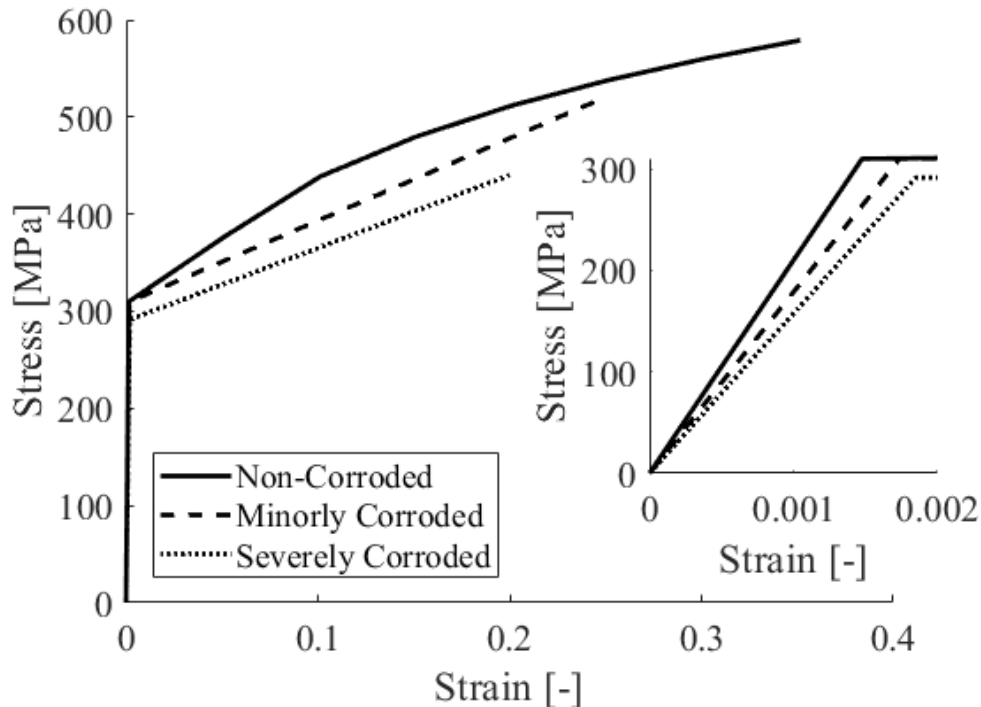

Figure 13. The true strain-stress curves for the non-corroded, minorly and severely corroded materials.

The constitutive material parameters for the minorly and severely corroded NVA steels were obtained using an approach proposed in Garbatov et al. (2014). Both materials were represented by a bilinear elastic-plastic constitutive material model, where the isotropic hardening of the inelastic stress-strain relation between the yield and ultimate tensile stresses was linear. The damage model of the corroded materials was represented solely by the shear failure criterion in FE models. The influence of considering a strain rate dependence or DE model for corroded materials was found to be minor (Ringsberg et al., 2017) and, hence, was excluded from the FEA with corroded material properties. The friction coefficient of the corroded surfaces in contact was altered, from 0.3 to 0.5, due to increased surface roughness; see Section 3.2.2 for details.

3.2.5 Loading conditions

The main loading condition experienced by a ship structure is bending induced by still water conditions (including cargo weight distribution) and waves. If the ship is sailing in heading or following seas, then the hull girder is normally subjected to vertical bending, resulting in pure hogging or sagging moments. However, in the case of oblique waves or a heeling angle resulting from partial flooding or parametric rolling, the ship is subjected to a combination of both vertical and horizontal bending moments, referred to as biaxial moment (see Figure 14). Vertical bending conditions were studied in Paper I. After consequent extensions and modifications to the numerical models and methods, the ULS under biaxial bending was investigated in Paper II. In the current study, torsion is omitted, but the effect of the combination of bending and torsional loads is an interesting issue and can be studied in the future.

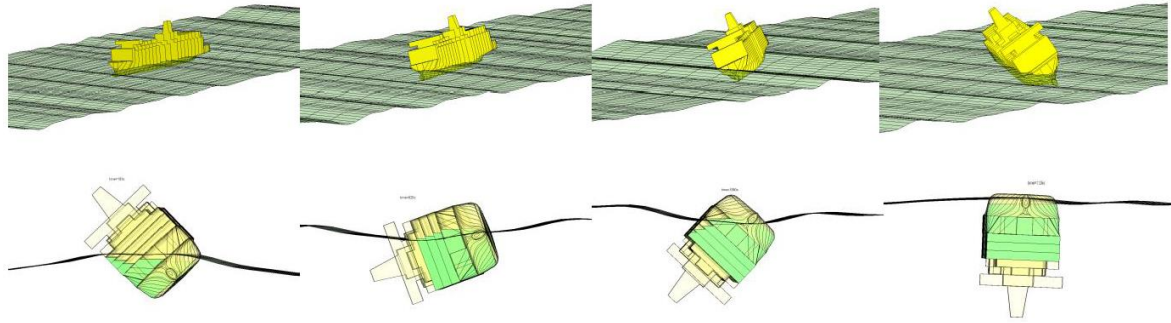

Figure 14. Example when a ship is experiencing biaxial bending loads (Schreuder, 2014).

3.2.6 Summary of the scenarios studied

In total, 32 different cases were investigated in Papers I and II with two ship types under vertical and biaxial bending and various ship conditions: intact hull structure, collision-damaged hull structure, newly built condition, and ship hull aged due to corrosion. The corrosion onset was represented either as a corrosion wastage or as a combination of the wastage and corroded material properties (see Sections 2.3 and 3.2.4). A summary of all cases is presented in Table 1, together with ULS assessment methods used and references to appended papers where results were published.

Table 1. Summary of study cases in Papers I and II.

Case	Scenario				Collision speed (kn)	Ultimate strength		Paper
	Vessel	Corrosion		Smith		FEA		
		Physical condition	Wastage				Material properties	
T1I	Tanker	New	-	-	Intact	x	x	I & II
T2I	Tanker	Minor	x	-	Intact	x	-	I
T3I	Tanker	Severe	x	-	Intact	x	-	I
T4I	Tanker	Minor	x	x	Intact	x	-	I
T5I	Tanker	Severe	x	x	Intact	x	x	I & II
T2D(V7)	Tanker	Minor	x	-	7	x	-	I
T3D(V7)	Tanker	Severe	x	-	7	x	-	I
T4D(V7)	Tanker	Minor	x	x	7	x	-	I
T1D(V2)	Tanker	New	-	-	2	-	-	II
T1D(V3)	Tanker	New	-	-	3	-	-	II
T1D(V4)	Tanker	New	-	-	4	-	-	II
T1D(V5)	Tanker	New	-	-	5	x	x	I & II
T1D(V6)	Tanker	New	-	-	6	-	-	II
T1D(V7)	Tanker	New	-	-	7	x	-	I & II
T1D(V8)	Tanker	New	-	-	8	-	-	II
T5D(V2)	Tanker	Severe	x	x	2	-	-	II
T5D(V3)	Tanker	Severe	x	x	3	-	-	II
T5D(V4)	Tanker	Severe	x	x	4	-	-	II
T5D(V5)	Tanker	Severe	x	x	5	x	x	I & II
T5D(V6)	Tanker	Severe	x	x	6	-	-	II
T5D(V7)	Tanker	Severe	x	x	7	x	-	I & II
T5D(V8)	Tanker	Severe	x	x	8	-	-	II
R1I	RoPax	New	-	-	Intact	x	-	I
R2I	RoPax	Minor	x	-	Intact	x	-	I
R3I	RoPax	Severe	x	-	Intact	x	-	I
R4I	RoPax	Minor	x	x	Intact	x	-	I
R5I	RoPax	Severe	x	x	Intact	x	-	I
R1D	RoPax	New	-	-	7	x	-	I
R2D	RoPax	Minor	x	-	7	x	-	I
R3D	RoPax	Severe	x	-	7	x	-	I
R4D	RoPax	Minor	x	x	7	x	-	I
R5D	RoPax	Severe	x	x	7	x	-	I

3.3 Numerical model of ship-to-ship collisions

Prior to the ultimate strength and residual strength assessments, collision simulations were carried out to obtain realistic damage openings with plastic deformations in surrounding structures. Moreover, the analyses allowed us to study the relations between the crashworthiness, residual strength, striking speed and corrosion grade. The results from collision simulations were also used to study the influence of the damage opening and the associated plastic deformation representation on the ship's residual strength.

3.3.1 Description of the finite element models

The FE model of the struck ship in collision analyses was made sufficiently large to avoid an influence from the boundary conditions on the numerical solution and the calculated shape and size of the damage opening. The bow section of the striking tanker was modelled as deformable and restricted to only move in a prescribed right-angle collision direction (see Figure 15a). The striking ship was given different initial forward velocities corresponding to different kinetic energies; see Section 3.3.3. The velocity of the striking bow gradually decreased to zero knots during the collision event as the energy was dissipated through deformations, fractures and friction in the structures.

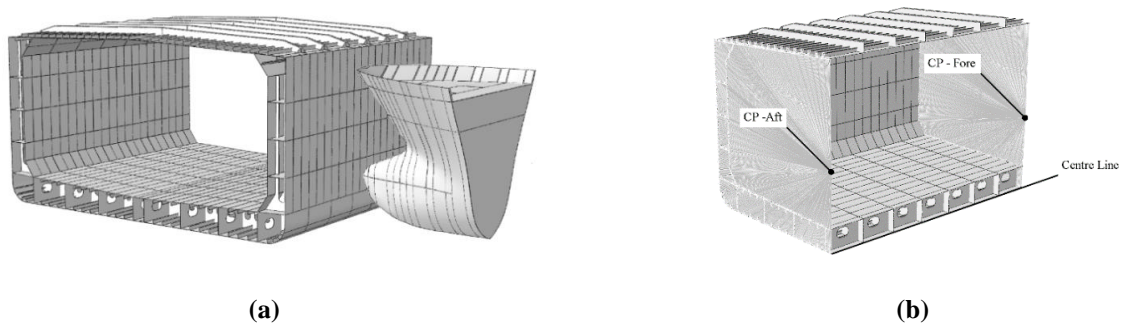

Figure 15. Definition of the collision scenario with: (a) positioning of the striking bow and struck vessel hull; (b) constrained FE model of the struck vessel showing the CPs.

All nodes at the fore and aft faces of the struck ship hull were connected to control points (CP) through a multipoint constraint with a rigid beam connection. The CPs were fixed in all degrees of freedom during the collision simulations (see Figure 15b). A thorough description of collision FE models is given in Papers I and II.

3.3.2 Setup of ship-to-ship collision analyses

The FE meshes were made of four-node shell elements with reduced integration (S4R in Abaqus/Explicit) and five section points through the thickness; however, some triangular elements (S3R in Abaqus/Explicit) were also used. A convergence analysis for the explicit FE analysis was carried out, which resulted in an element size of 60 mm. The properties of the material for the DI and DE models were included in this convergence analysis to incorporate the mesh-dependent effects. The element length/thickness ratio was 5 in the part of the model with the highest sheet thickness. Time integration was accomplished by utilizing the explicit time stepping scheme combined with an automatic choice of time step. More details regarding the collision simulation setup are given in Paper I.

3.3.3 Energy analyses

The energy analysis of collision simulations is an important tool for verification that the impact damage was fully developed. In addition, comparing the energy share between parts involved

in the collision accident provides insight into how the kinetic energy was absorbed and what the deformation patterns were.

The internal energy during a collision is comprised of the elastically stored energy and the dissipated energies from the plastic deformation and damage. The sum of these energies corresponds to the total kinetic energy of the striking tanker at the outset of an analysis. This type of analysis was performed in Paper II to investigate different collision scenarios with respect to the crashworthiness according to NORSOK (2004) to select a representative case for subsequent residual strength assessments.

3.4 Numerical model of the ultimate strength analysis

Ultimate strength analyses were performed with the FE and the Smith methods to enable a comparison of the methods and to study whether a new method combining the advantages of both is feasible. This section presents a brief description of the models for the respective methods that were used for the simulations and calculations.

3.4.1 Finite element analyses

The FE model presented in Section 3.3 was used to estimate the ultimate strength capacity of the vessel during biaxial loading conditions. To ensure that the ultimate bending moment was reached, the FE model was bent in a prescribed direction beyond its ultimate state condition. The bending was applied to the FE model through displacement control, where the bending curvature was increased gradually by the rotation of the end planes through controlled rotations of the CPs. To preserve pure bending, the hull was simply supported through the CPs; see Figure 16 for a schematic and Paper II for a detailed description of how the CPs were defined. By controlling the ratio between the horizontal and vertical rotations, the desired biaxial bending condition was achieved. The reaction moment at the CPs was recorded for every curvature increment during bending. The maximum point on the obtained total bending moment-total curvature curve defined the ultimate strength as its ULS bending moment and corresponding curvature.

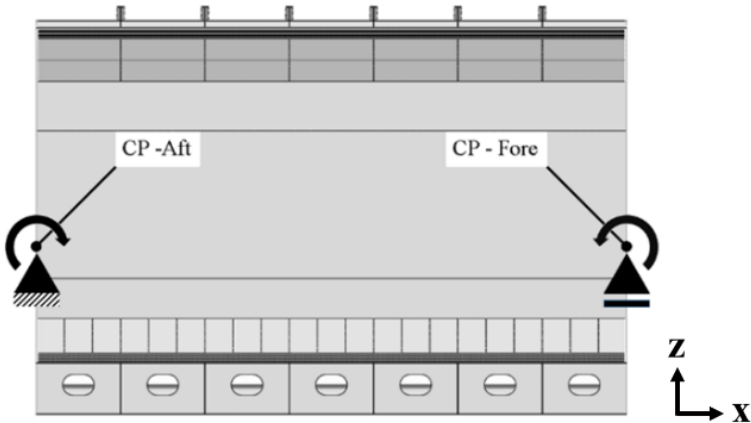

Figure 16. Illustration of the boundary conditions during bending simulations.

A convergence analysis presented in Paper II showed that a loading time of 1.00 s was appropriate for the FE model used in the current investigation. This study did not include initial deformations and imperfections in the FE model, which was supported by the argument that such imperfections were not (and are normally not) incorporated in the FE model used in the ship collision simulations.

For ULS analyses of a hull with collision damage, the bow of the striking ship was removed after the collision simulation was complete, and the same bending analysis procedure was applied to the damaged hull. In Paper II, the importance of using realistic damage patterns for residual strength assessments was shown by studying various damage opening modelling techniques.

3.4.2 The Smith method

In the Smith method, the hull is modelled by a single representative cross section where the maximum bending loads without shear are assumed to be applied. The cross section of the hull is divided into three types of structural elements: stiffened plates, stiffeners and hard corners. The discretization is according to the plate-stiffener combination model; see Section 2.1 and Figure 17.

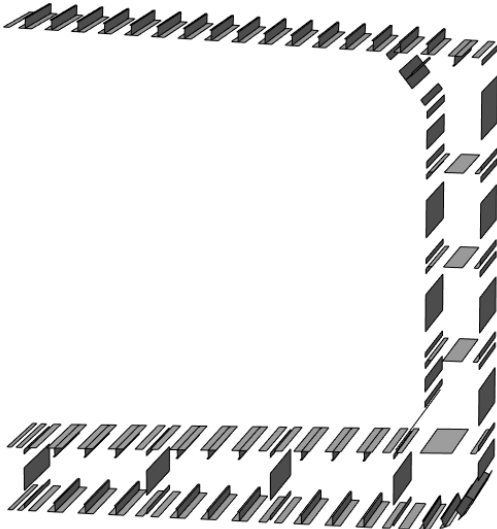

Figure 17. Example of discretization of a cross section in the Smith method models.

As defined in the CSR-H rules (IACS, 2019), the material in this simplified analysis, in contrast to the more advanced and realistic material models used in an FE model and described in Section 3.2.3, was modelled as elastic-perfectly plastic. Furthermore, the influence of corrosion was determined following the method presented in Section 3.2.4. Note that only the elastic modulus and the yield stress were changed because the material curve of the Smith method ship model must be represented by an elastic-perfectly plastic curve. Initial imperfections and residual stresses, e.g., due to welding, were implicitly included in the Smith method through the equations that define the LSE curves, as prescribed by the CSR-H rules.

Hull damage caused by a collision event was modelled by removing and adjusting the geometry of the structural elements corresponding to the ruptured and severely plastically deformed elements in the ship's cross section (see Figure 18). The LSE curves of the modified elements were adjusted accordingly. The longitudinal location of the representative cross section was chosen from the FEA of the collision event by the identification of the cross section that had the most extensive damage in the transverse plane. This is a new methodology that has not been found in other scientific publications.

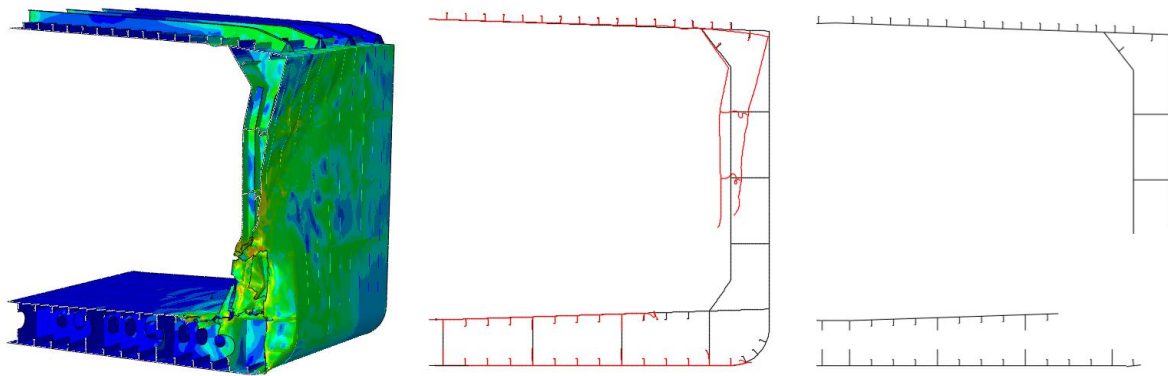

Figure 18. Damage modelling in the Smith method.

3.5 Post-processing of the ultimate strength analyses

The change in the global structural response during biaxial bending was found under the prescribed moment ratio by incrementally increasing the curvature. The obtained increments of the bending moment and the curvature were added to their cumulative values. The theory behind the calculations in the in-house code URSA can be found in Paper II. By plotting the bending moment versus the curvature, the ULS is identified as the peak value of the bending moment for the specific loading condition.

ULS analyses according to the two different methods were repeated for many combinations of horizontal and vertical bending moments for several cases in Paper II. By plotting the ultimate bending moment maxima in a polar diagram, an interaction curve describing the ship's ultimate strength for its specific bending and structural condition was produced for all possible biaxial bending moment combinations. Polar diagrams show the bending moment loading ratios in degrees and the ULS values in the radial direction (see Figure 19), where 90° and 270° correspond to hogging and sagging, respectively. Pure horizontal bending with the port side in tension occurs at 0°, and compression occurs at 180°.

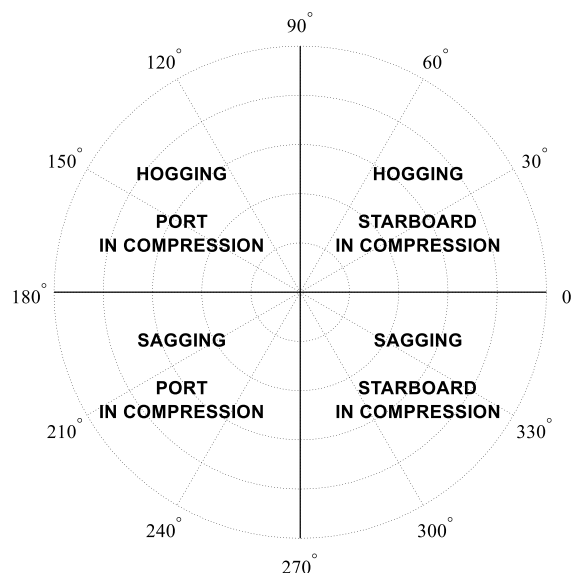

Figure 19. Definition of the ship structure ULS responses and bending moment ratios in a biaxial polar diagram.

3.5.1 RSI analyses

The evaluation of the reduction in the ultimate strength due to damage can be made by calculating the ratio of the ship's ultimate bending moments under damaged and intact conditions, i.e., the residual strength index (RSI). During the parametric study, a comparison of the RSI values will reveal the dependencies between various input parameters and their effect on the residual strength. The RSI2 index proposed by Yamada and Ogawa (2011) has the same "meaning", but the ultimate moment is normalized by the theoretical fully plastic bending moment. Because the RSI2 values will always be less than unity, buckling is omitted in the calculations of the fully plastic bending moment.

In Paper I, only the Smith method was used for the ULS analyses, and the RSI2 index was used to show the difference in the ultimate strength between the sagging and hogging loading conditions. In Paper II, the intention was to compare results from the Smith method with FEAs; thus, the RSI index was utilized instead.

3.5.2 Calibration of the Smith method

One of the advantages of using the FE method for ULS analyses is the possibility of performing a detailed and accurate analysis of each specific load combination and "simulation scenario". However, if a high resolution of data points in the ULS interaction curve must be obtained, then these analyses will demand long computational times; see Paper II for a discussion. To enhance the efficiency of the calculations and preserve good accuracy simultaneously, a "calibration" method using a curve fitting procedure was developed that makes use of as few FEAs as possible to generate correction factors for the results of the Smith method.

An interaction curve for an intact and non-corroded ship can be approximated by Equation (1), where M_y and M_z are coordinates on the "fitted" curve, M_{UH} and M_{UV} are the ultimate horizontal and vertical bending moments, respectively, and β is a shape factor.

$$\left(\frac{M_y}{M_{UV}}\right)^\beta + \left(\frac{M_z}{M_{UH}}\right)^\beta = 1 \quad (1)$$

To generalize the calibration procedure, Paper II presents a curve fitting procedure that is unique to each quadrant on a polar diagram. Based on the curves fitted using Equation (1) in each quadrant, both for the FEA and the Smith method, calibration factors (CF) were calculated as the ratio between the two methods' fitted parameters. The CF s for the pure horizontal and vertical ultimate bending moments were defined as $CF_H = M_{UH,FEA}/M_{UH,Smith}$ and $CF_V = M_{UV,FEA}/M_{UV,Smith}$, respectively. The new shape factor was defined as $\beta_{CF} = \beta_{FEA}/\beta_{Smith}$. The new formulation of a "calibrated interaction curve" using the Smith method can then be described by Equation (2).

$$\left(\frac{M_y}{M_{UV,Smith}CF_V}\right)^{\beta_{Smith}\beta_{CF}} + \left(\frac{M_z}{M_{UH,Smith}CF_H}\right)^{\beta_{Smith}\beta_{CF}} = 1 \quad (2)$$

4 Results

This section presents a summary of the appended papers I and II. It highlights the main achievements and presents a selection of important results from Papers I and II, respectively.

4.1 Summary of Paper I

The objective of Paper I is to study the effects of ship-ship collisions and the progressive deterioration due to corrosion on the vertical ultimate strength of ships. The crashworthiness of non-corroded and corroded struck vessels is quantified in terms of the shape and size of the damage opening in the side-shell structure. Explicit finite element (FE) analyses are presented where several factors, such as the collided ship type, corrosion margin thickness and material characteristics, vary systematically in a parametric study. See Table 1 in Section 3.2.6 for a summary of the selected study cases. The struck ships are represented either by a RoPax ship or a coastal oil tanker vessel (see Section 3.2.1). The ultimate strength of the struck vessel is calculated using the Smith method according to Sections 1.1 and 3.4.2.

The projected shape and size of the damage openings of the RoPax ship (R) and the coastal oil tanker (T) from the FE analyses are presented in Figure 20. It was found that there is a small increase of 6% in the size of the damage opening of the inner side-shell when only the corrosion margin is reduced, cf. R1D and R3D. The influence from the corrosion material model together with corrosion margin reduction is much more prominent, and the increase in the damage opening size in the inner side-shell is 92% between a newly built ship (R1D) and a minorly corroded ship (R5D). The same trend was found for the tanker as for the RoPax ship: a reduction of the corrosion margin results in an increase in the damage opening by 2%, cf. T1D and T3D. Compared with the virgin material model (T3D), the inclusion of models for the minorly and severely corroded materials (T5D) resulted in a larger damage opening. The results show that the damage opening size in the inner side-shell is almost 4 times larger in the corroded tanker (T5D) than in the as-built tanker (T1D).

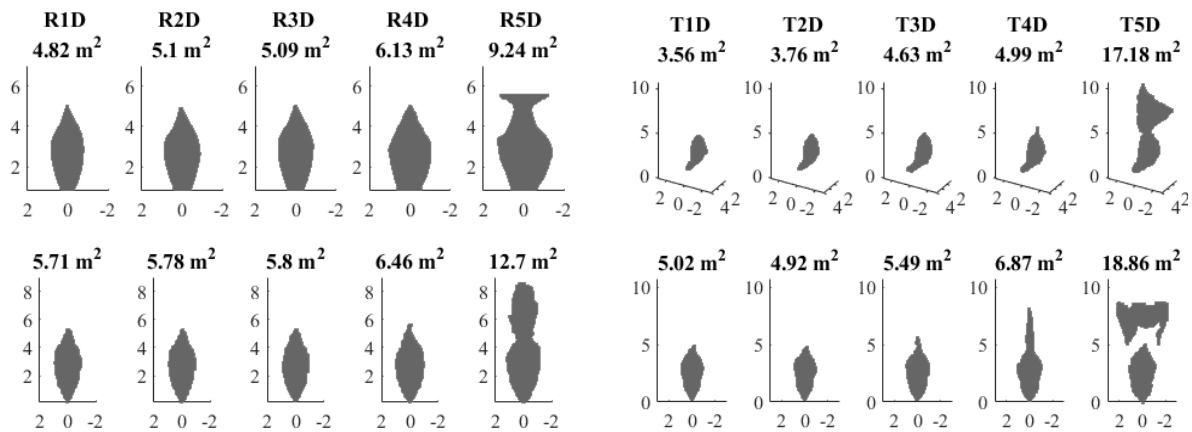

Figure 20. Shape and size of the damage openings for the RoPax (R) and coastal oil tanker (T) cases: (**upper**) inner side-shell and (**lower**) outer side-shell.

It was concluded in Paper I that the crashworthiness analyses of corroded ships involved in collision accidents should be carried out considering not only a reduction in the corrosion margin alone, which is a common practice, but also but also a constitutive material model representative of the corrosion grade. If these factors are not considered together, then the size of the damage opening will be underestimated, and since the bending strength of a struck ship depends on the shape, size and location of the damage opening, the residual strength analyses will be nonconservative and unsafe.

The ultimate strength results for the intact case study vessels at different corrosion states are presented in Figure 21 as the ultimate vertical bending moment versus the curvature. The ultimate strength of the RoPax in the sagging condition (negative moments) was governed by the buckling collapse of the upper and main decks, while in the hogging condition (positive moments), it was determined by the buckling of the double bottom structure. The progressive collapse of the tanker during sagging was initiated by the buckling of the strength deck, while during hogging, the instability of the double bottom was the triggering mechanism.

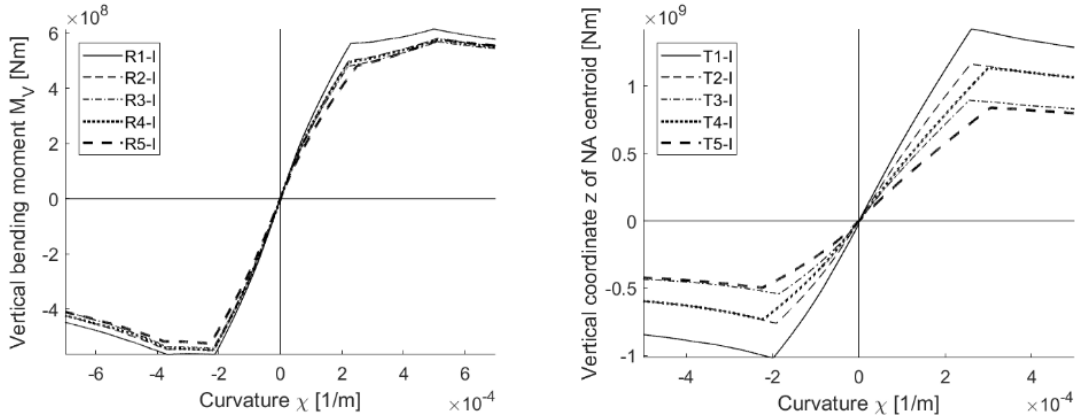

Figure 21. Ultimate strength analysis of the undamaged: **(left)** RoPax ship and **(right)** tanker presented as the vertical bending moment versus curvature.

The influence of the rotation of the force NA under vertical bending and damaged conditions was studied by comparing the results with and without the rotation of the NA in Kuznecovs and Shafieisabet (2017) and by plotting the stress distribution for both vessels in Papers II and A (see Figure 22). The error due to the constrained rotation of the NA may vary from 5% during pure vertical bending to 25% during biaxial bending. Thus, the importance of allowing both the translational and rotational movements of the NA was reaffirmed.

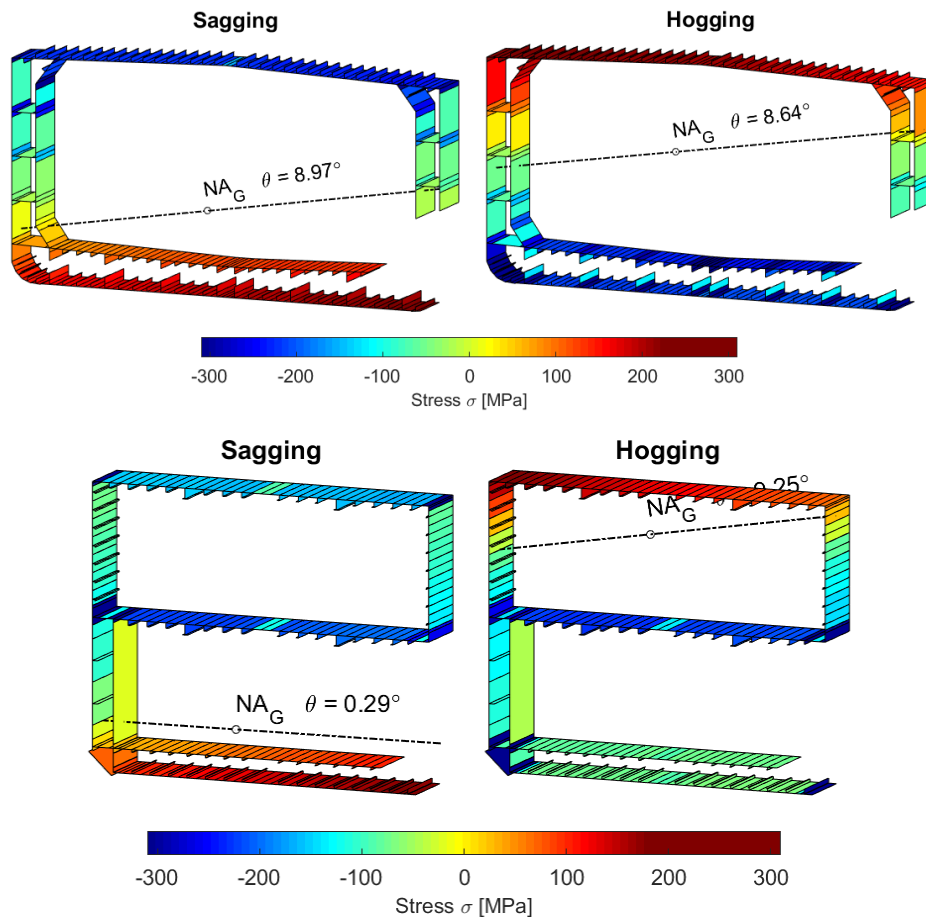

Figure 22. Axial average stress distribution of the: **(upper)** T1D and **(lower)** R1D at the ultimate strength point.

The ships' residual strength was quantified by the RSI2 index; see Section 3.5.1 for definition. Figure 23 presents diagrams that illustrate how the RSI2 index is changed for intact and damaged ships that have different corrosion conditions in the model. The residual ultimate strength capacity is decreased for both ships as the corrosion margin is reduced. A comparison between the cases R3I and R5I, as well as R3D and R5D, shows how important it is to use an appropriate constitutive model for the corroded material together with the material properties representative of a corroded structure/material. This is also true for the coastal oil tanker; however, the reduction in the corrosion margin has a larger influence on the RSI2 value for this ship type. The same collapse modes and failure locations were identified for both intact and damaged cases.

For the RoPax ship, the ultimate moment reduction in hogging and sagging between the damaged R1D and R5D is 21% and 15%, respectively. A larger reduction in hogging for RoPax was expected since the damage opening is mainly located on the compression side. For the coastal oil tanker, the same analysis between T1D and T5D shows a reduction of 41% and 55% in hogging and sagging, respectively. The damage openings in the coastal oil tanker are in locations where the structural elements contribute significantly to the moment of inertia and structural strength; the RoPax ship is less sensitive to this in its structural design. The collision damage extent in the T5D case was up to the sheer strake, which drastically reduced the moment of inertia around the horizontal axis. In addition, the corrosion rate was higher in the weather deck than in the bottom structure, cf. Figure 12 and made the tanker's hull girder more sensitive to sagging loads.

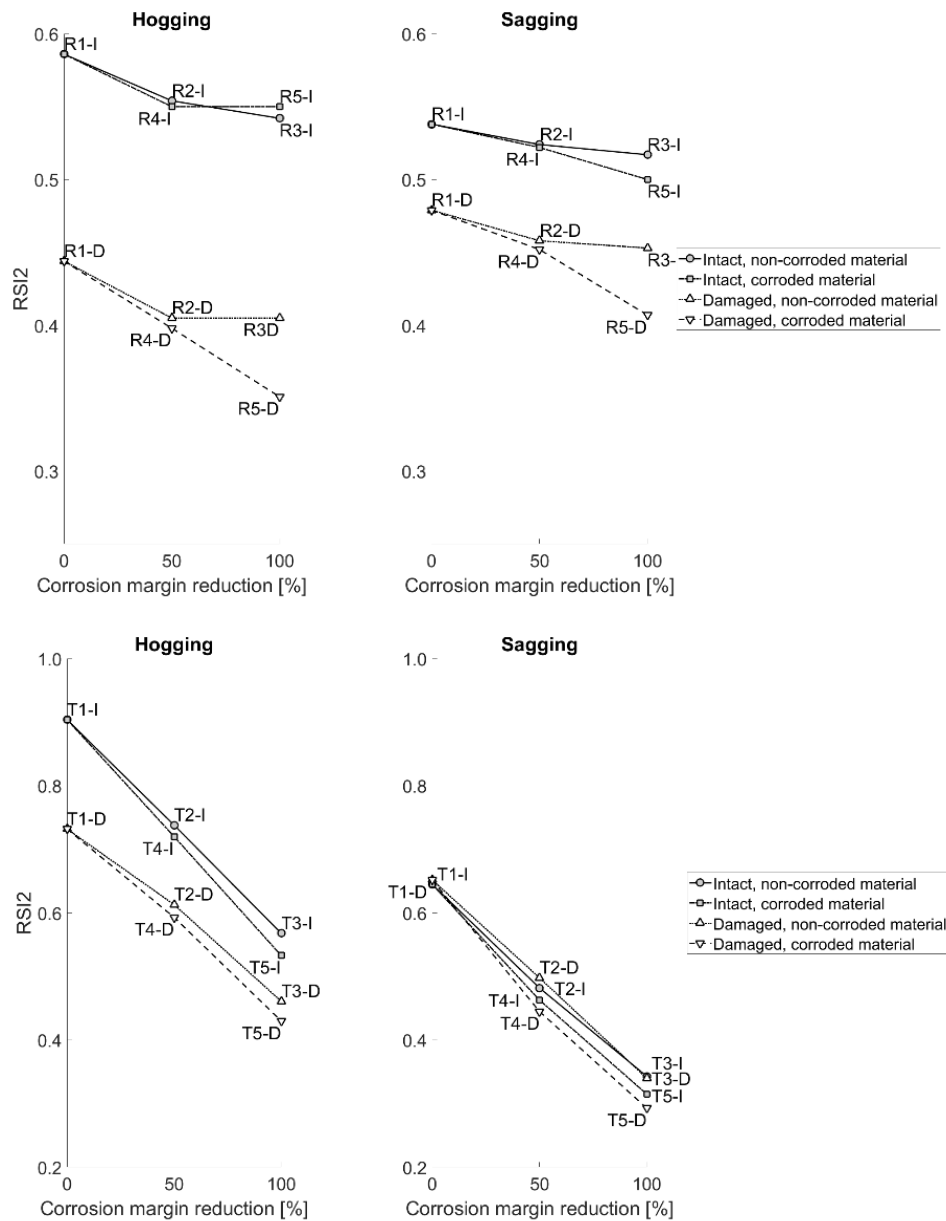

Figure 23. RSI2 index versus the corrosion margin: (**upper**) the RoPax ship and (**lower**) the coastal oil tanker.

4.2 Summary of Paper II

Paper II presents a further development of the analysis tools and simulation techniques from Paper I. The material and corrosion models from Paper I were applied in Paper II. The most important development stages are: (i) the extension of both the Smith method and FE models to account for biaxial loading conditions; (ii) the comparison of results from the Smith method and FEAs; and (iii) a proposal for a new methodology combining the advantages of both methods.

The abovementioned steps were carried out on a number of case study scenarios. Beyond the typical collision speed of 7 knots used in Paper I, a parametric study was conducted for different collision speeds to identify a representative case for ultimate strength analyses. Moreover, various representations of collision damage were compared to justify the reasonable level of simplification. Two corrosion scenarios were investigated in Paper II: with no corrosion and

as-built thicknesses, and full corrosion margin deduction from the offered scantlings together with an adjustment of the material properties. See Table 1 in Section 3.2.6 and appended Paper II for a full description of the scenarios.

The results of the collision speed parametric study are presented as the structural deformations due to collision (see Figure 24), energy share ratio and damage opening areas (see Figure 25). The structural deformation and the relative internal energy share ratio for the struck ship, $R_{IE, struck}$ (see Paper II for definition), showed that the T1 and T5 tankers corresponded to shared-energy and ductile designs, respectively, according to NORSOK (2004). The only exception was T5 at a collision speed of 5 knots when there was a drastic increase in the damage opening area due to the dramatic destruction in the upper part of the double side plating. These observations served as motivation for the choice of the reference collision speed for biaxial strength analyses.

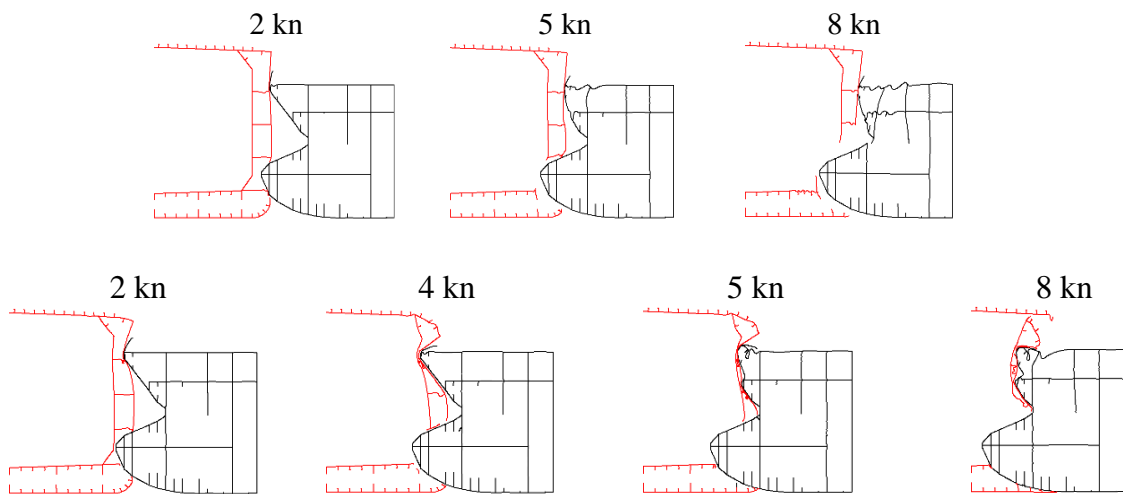

Figure 24. Deformations from the FEA of ship collisions: the struck ship is **(upper)** non-corroded (T1) and **(lower)** corroded (T5).

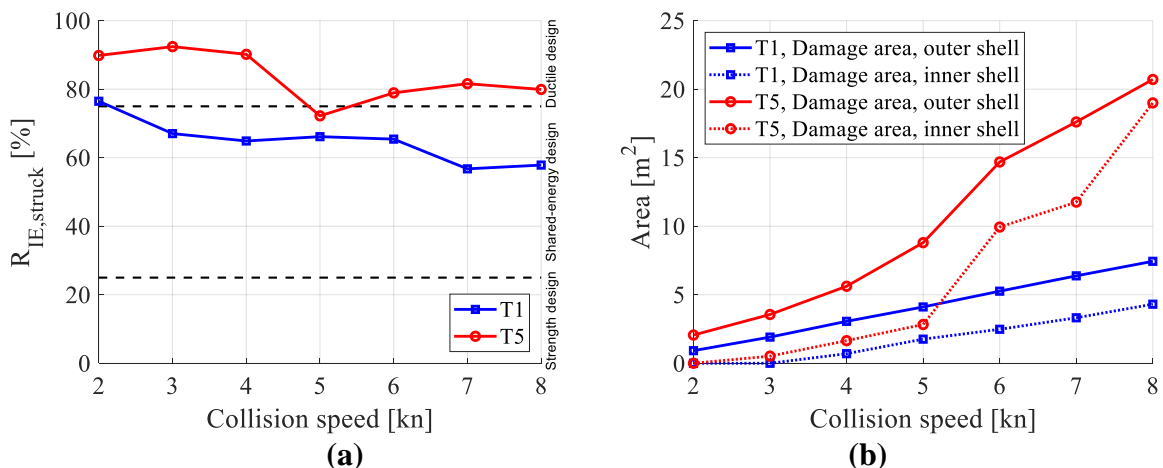

Figure 25. (a) Internal energy share ratio of the struck vessel, $R_{IE, struck}$, for different collision speeds, and (b) projected damage opening areas in the struck ship's inner and outer side-shells.

The ULS analyses with the FE method incorporate the damage opening with plastic deformations of the surrounding structures. In the Smith method, however, the corresponding damage is simplified by making several assumptions. A study was carried out in Paper II to

investigate how the different degrees of simplification of collision-damaged structure modelling affect the ULS (see Figure 26), where the FE method is assumed to be a reference case. The analyses were limited to hogging and sagging conditions and were compared to full ULS FEA carried out by restarting the ship collision FEA after the struck vessel was removed. A detailed description of the cases investigated is presented in Paper II. The results showed that all simplification techniques, including the Smith method, overestimated the ultimate strength compared to the full FEA solution by up to 40%. Thus, the recommendation for residual strength analyses is to apply the damage opening together with the associated plastic deformations and residual stresses from the full collision FEA.

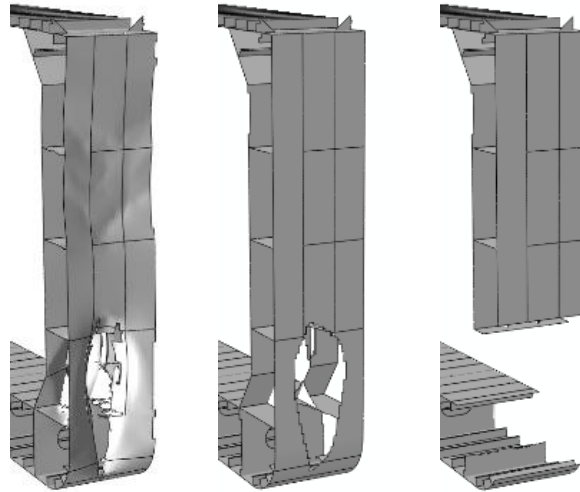

Figure 26. Different collision damage models: **(left)** damage opening with surrounding plastic deformations, **(middle)** damage opening without surrounding plastic deformations and **(right)** simplified box-shaped damage opening without plastic deformations. Note: only the midship section is shown.

Figure 27 presents the interaction curves of the ultimate bending moments during biaxial loading conditions from the FEA and the Smith method proposed in this investigation. The agreement between the methods was good for the pure vertical bending conditions: the discrepancies between the Smith method and FEA were 8% and 5% for hogging and sagging, respectively. For all other loading combinations, the Smith method showed a larger ultimate strength than the FEA. The shortcomings of the Smith method, discussed in Sections 1.3 and 2.1, resulted in a larger difference between the two methods. In addition, for the corroded ship structure case T5I shown in Figure 27b, the trend was the same; the Smith method gave a slightly larger ultimate strength than the FEA. Notably, there was also a significant reduction in the ultimate strength capacity between T1I and T5I due to corrosion, reaffirming the trends found in Paper I.

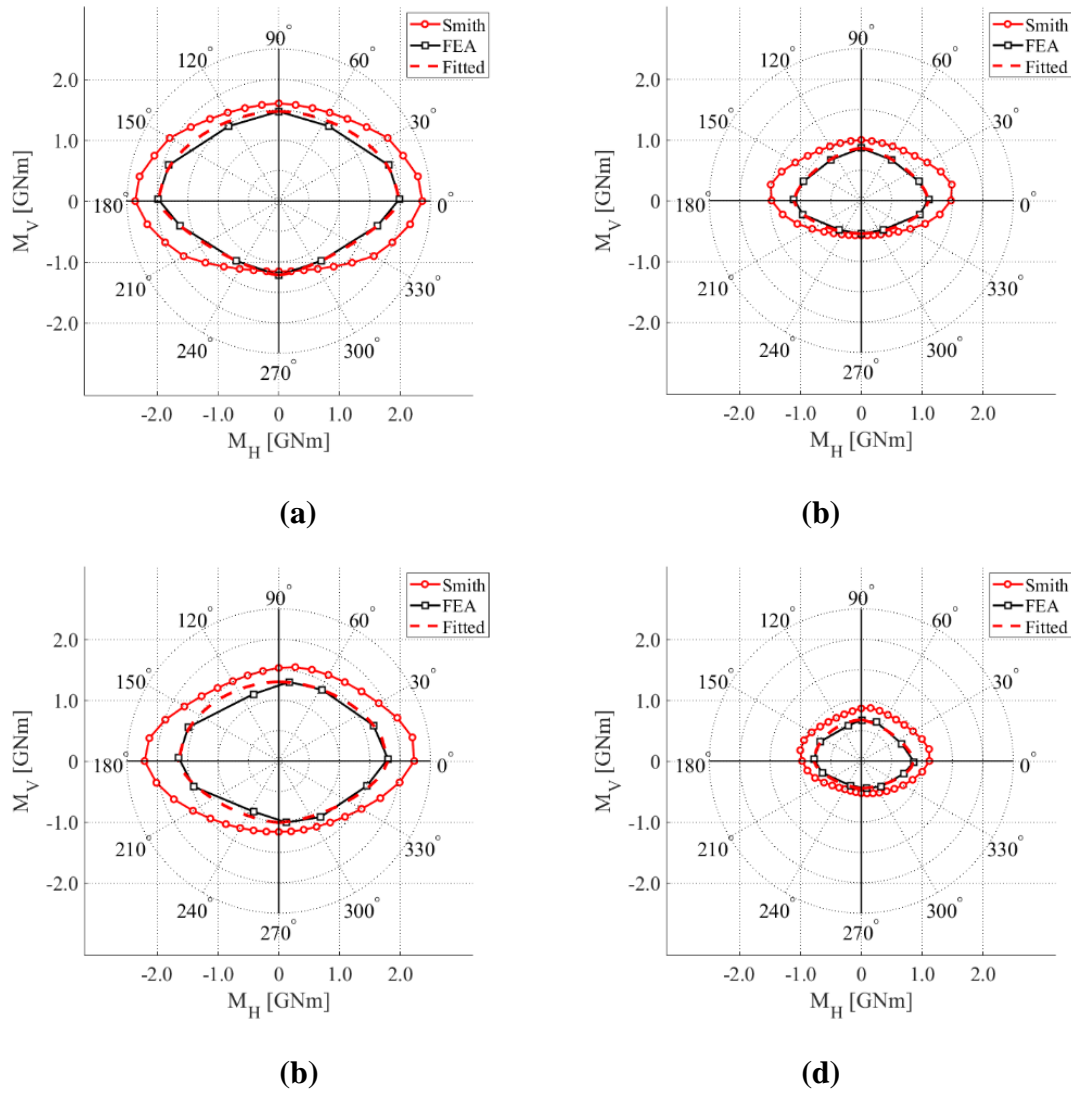

Figure 27. Interaction curves for the FEA, the Smith method and the calibrated Smith method for: (a) T1I, (b) T5I, (c) T1D, and (d) T5D.

Figures 27c and 27d present the results from the damaged ship structures with the damage opening on the port side of the ship. The asymmetry due to the single-side damage opening was captured by both the FEA and the Smith method. The largest reduction in the ultimate strength for case T1D occurred in the second and third quadrants when the damaged side of the ship was in compression (see Figure 19). There was also a minor effect in the first and fourth quadrants compared to the T1I case, where the modelling of the damage opening showed a larger effect for the FEA than for the Smith method model. For the corroded ship case T5D, there was a significant reduction in the ultimate strength compared to T1D, whereas, in the T5I case, there was a larger reduction in the sagging condition than in the hogging condition. In contrast, with the T1D case, the FEA results for T5D showed a large reduction in the first quadrant when the damaged side of the ship was in tension. An analysis of all FEAs showed that this can be explained by the damage and plastic deformations caused by the forecandle (see Figure 24), which led to a large reduction in strength, especially for these combinations of horizontal and vertical bending moments.

In addition to the results obtained by the FEA and the Smith method, Figure 27 presents the results for the calibrated interaction curves. The results showed good agreement between the

FEA and the Smith method with calibrated values according to Section 3.5.2. A summary of all curve-fitted parameters needed to plot the interaction curves is presented in Paper II. To achieve an accurate solution, the recommendation from Paper II is to calibrate the interaction curve with ultimate strength values from the 12 FEAs. With the new method after calibration is complete, an interaction curve with 35 points can be obtained in less than 5 CPU minutes, while calculation of each point by the FEA with the same computational power takes up to 60 CPU hours. The relative error between interaction curves obtained by FEAs and with the new methodology is within 5%. Thus, with the proposed procedure, which requires only a few FEA results together with the Smith method, a high-resolution interaction curve can be obtained with high confidence and rapidness compared to the time it takes to run many FEAs to obtain the same interaction curve resolution.

5 Conclusions

With the gained knowledge in mind and fast and reliable tools at hands, it is feasible to devise safer designs, to assess acute situations and take necessary measures in due course in the case of accidents. Therefore, by making informed decisions, with all necessary information at hands, and relying on engineering judgement, the safety at sea can be increased. This thesis contributed to a better understanding of how the collision conditions, structural arrangement, age-related degradation and load type affect the crashworthiness and ultimate strength of ships. A new unified methodology, combining the precision of the finite element method and the efficiency of the Smith method, for the assessment of the ultimate and residual strength of ships was developed and presented. Several conclusions regarding the modelling and analyses setup for realistic ultimate and residual strength estimates were drawn.

A new methodology for corrosion modelling was proposed and applied in the study. It was found that both a reduction in the plating thickness and altered material properties due to corrosion damage have a large negative effect on the ship crashworthiness and ultimate bending strength. The increase in the collision damage opening area can be from 2% to up to four times for the wastage model per recognized procedure alone and the combination of wastage and corroded material models, respectively. The reduction in ultimate strength can be underestimated by 4%-12% if only the corrosion wastage is applied. Thus, for both the ULS and collision FE analyses of aged ships, it is recommended to consider a proposed modelling procedure for a corroded structure that accounts for both a reduction in the corrosion margin and changed material properties. Additionally, in the collision FEA, a friction coefficient representative of corroded metal surfaces must be used.

Different collision damage opening modelling approaches were investigated. It was concluded that a correct estimation of the damage opening's location, shape and size is important for ultimate strength analyses. Otherwise, the ship's ultimate strength under damaged conditions may be overestimated by 40%. This finding resulted in the following three recommendations: (i) the shape and size of the damage opening should not be simplified to simplistic shapes; (ii) a representative constitutive material model for the material's true characteristics should be used; and (iii) the deformed structures and plastic strains should not be disregarded. An FE-based approach is thus recommended.

The thesis presented ultimate strength analyses carried out by the FE and Smith methods. The differences between the methods and their sources were discussed and analysed. It was confirmed that a consideration of biaxial bending loads is of paramount importance for the correct assessment of the ultimate and residual strengths. It was found that the ultimate strength may be overestimated by 5%-25% if the rotation of the force neutral axis is constrained. Hence, the importance of a correct definition of the force neutral axis in the Smith method for asymmetrically loaded or damaged cross sections was justified. The difference up to 25% between the FE and Smith methods is attributed to the limitations of the Smith method: simplified material and damage modelling. Hence, the Smith method resulted in unconservative results for safe ship design with respect to the ultimate strength.

However, the results from the ultimate strength analyses of the collision-damaged hull structures showed that both methods captured the expected asymmetric ultimate strength response due to asymmetric damage. A new procedure for the calibration of the Smith method results by few FE analyses was proposed and applied. With this procedure, the advantages of detailed FEA for a damaged ship structure and corrosion are utilized together with the calculation efficiency of the Smith method. The proposal also gives a safe ship design procedure

with ultimate strength bending moments that are not overestimated (error within 5%) due to model simplifications or other errors.

6 Future work

During the research work, several areas for methodology improvements together with possible solutions were identified. In addition, knowledge gaps and possible development paths were established, and some thoughts on future studies are presented below.

Enhancements of the methods

To better quantify uncertainties related to the Smith method applied in the URSA code, ultimate and residual strength analyses can be carried out on various well studied ship hulls, and the results can be compared with other available research studies. This goal incorporates extensive geometry modelling. For these purposes, it would be beneficial to develop a tool for the translation of drawings into models consisting of various structural elements, as per the Smith method. In addition, the tool can be designed for the implementation of damage openings and structural deformations. Later, the tool can be further extended for work with 3D finite element meshes for the automated application of initial imperfections, since existing semi-empirical models depend on the structural element type. Moreover, it may have other applications for work with analytical and simplified methods, e.g., stressed skin structures. This tool will increase both the accuracy of ship hull models and work performance in future research projects.

The axial stress response during bending varies not only within the hull's cross section but also in every structural element. In the Smith method, a uniform stress distribution within an element is assumed. This assumption holds reasonably well for large structures and their elements placed far away from the bending neutral axis. However, it was shown by Anyfantis (2019) that the strength of elements laying in the vicinity of the neutral axis can be overestimated by 10% if the effect of local load eccentricity is omitted. Thus, it is believed that the implementation of the proposed simple formulation for the correction of ultimate compressive stress will enhance the accuracy and increase the reliability of the code.

Another area for improvement is the estimation and application of a suitable procedure for the treatment of curved plate elements that are stiffer and stronger than flat plates due to their geometry. For example, the average stress-strain relationships developed by Maeno et al. (2004) and Seo et al. (2016) for curved plates and stiffened curved plates, respectively, could be adopted. Another modelling uncertainty in the URSA is associated with longitudinal girders with openings. In the method applied in the current work, these structural members are modelled as two independent stiffened plate elements with a distance between them corresponding to the opening breadth. A recent investigation on the topic by Doan et al. (2020) could provide a clue on how to handle this type of element in a better manner.

Different methods for increasing the calculation precision are the substitution of idealized stress-strain relationship curves based on analytic formulae, as defined in CSR-H rules with the LSE curves obtained through finite element simulations. It was shown by Downes et al. (2017) and in the benchmark study by ISSC (2000) that FE-based LSE curves result in better accuracy of ultimate strength analyses. Since relatively simple models are sufficient for the assessment of the axial strength of structural elements, an internal FE solver within the URSA code could be developed for automatization purposes.

Finally, it is still highly uncertain how structural elements deformed by impact should be treated in simplified analysis methods to capture complex shapes and responses as accurately as possible. After the release of impact forces, elements are plastically deformed, and residual strains remain. The presence of residual strains can affect the strength of elements. For instance,

Cai et al. (2015) and Toh et al. (2016) proposed closed-form expressions to predict the ultimate strength of stiffened plates accounting for impact-induced residual stress and deformation. Thus, resolving the issue will likely enhance the trustworthiness of residual strength assessments.

Extensions of methods

At present, the simplified analysis method implemented considers pure bending only. This is the case when progressive collapse takes place where the bending moment is at its maximum, i.e., when the shear stresses are zero. While this is a common approach to assess the vessel's ultimate strength, it is still possible that a hull collapse will occur under combined the bending moment and shear. In addition to bending, shear forces can be caused by torsional loads in oblique seas or when a ship is listed. It is known that shear stresses will influence the yielding and buckling conditions (Tanaka et al., 2015; Yao and Fujikubo, 2016) and, consequently, will affect the global girder strength.

If a hull's cross section has an open profile, e.g., container vessel or bulk carrier, warping can become an important issue for consideration. This behaviour gives rise to additional non-uniformly distributed normal stresses, and hence, the cross section is no longer planar due to warping deformation. The issue can be addressed by applying methods proposed by Kitarovic and Zanic (2014). However, the application of alternative methods and more recent research should be conducted.

Normally, the hull experiences the maximum moment around the midships. Hence, under a pure bending load, it is sufficient to check the ultimate strength at a single location. If the hull response due to the combination of bending moments and shear forces is of interest, then the ultimate strength should be evaluated at various locations along the hull. Therefore, a tool for ULS checking throughout the length of a ship in the URSA code could be a useful option.

In addition to global bending loads, the outer bottom and side plating can experience local bending loads due to external hydrostatic pressure or internal cargo loads. The combined hogging moment and local pressure loads affect the global strength negatively due to increased compressive forces acting on the outer bottom and the reduced effectiveness of the inner bottom plating (Darie et al., 2013; Tatsumi and Fujikubo, 2020). Therefore, the consideration of the phenomena can increase the reliability of the ULS analysis code.

For the rapid assessment of the consequences of collisions and grounding accidents, it could be beneficial to either develop or adopt existing semi-analytical models for damage opening shapes. The implementation of such models will enable parametric studies and risk analyses along ship routes.

Moreover, it could be of great interest to investigate how crack propagation during progressive collapse or cyclic loading can be predicted and utilized with simplified methods. Dynamic changes in the damage opening shape and size will presumably influence the flooding rate, seakeeping properties and distribution of loads acting on a hull structure. Eventually, with the crack propagation model at hand, break-in-two accidents can be foreseen.

New applications of the developed methods

Discussion on the structural response due to combined loads shows the great importance of correctly estimating still water and wave loads together with the pressure distribution on wetted surfaces that should be based on relevant and properly selected representative sea states. This

requires the analysis of the ship's hydrostatics and motions. In the case of damaged vessels, liquid cargo outflow and progressive flooding will play a crucial role in the redistribution of loads. Estimating the hazardous scenario's time-dependent conditions and assessing the ultimate and residual strength of a vessel dynamically could potentially provide better insight into the risks associated with harsh weather conditions and accidental damage.

To achieve that goal, both structural and hydrostatic analysis procedures should be applied in the interaction with each other. To make the results generic, simulations and analyses are performed for different vessel types, sea states, and wave encounter directions. The assessment of accidental scenarios can be carried out with respect to the damaged ship's motions and stability, the risk of capsizing and sinking, and the time required for evacuation and rescue. Furthermore, the methodology can be extended by investigating the in- and outflow of liquid cargo and sea water. The simulation results to be used for studying its effect on ship stability, structural integrity and environment.

It is believed that both academia, industry and society in general can benefit from the research at the current state and its further development. To secure that, all necessary efforts will be made for making the research available, which means sharing gained experience and helping to utilize the research. All relevant parties will be provided with information regarding the assumptions, limitations and drawbacks of the methodology developed. Possible risks associated with its application are to be clearly stated and possible unintended consequences will be identified to the largest possible extent to allow for making informed decisions.

7 References

- ALPS/HULL. (2017). A Computer Program for the Progressive Collapse Analysis of Ship's Hull Structures. Stevensville, MD: MAESTRO Marine LLC.
- Alsos, H.S., Amdahl, J., & Hopperstad, O.S. (2009). On the Resistance to Penetration of Stiffened Plates, Part II: Numerical Analysis. *International Journal of Impact Engineering*, 36, 875-887.
- Alsos, H.S., Hopperstad, O.S., Törnqvist, R., & Amdahl, J. (2008). Analytical and Numerical Analysis of Sheet Metal Instability Using a Stress Based Criterion. *International Journal of Solids and Structures*, 45, 2042-2055.
- Anyfantis, K. (2019). *Ultimate Compressive Strength of Eccentrically Loaded Stiffened Panels in Ship Structures: a Computational Study*. Paper presented at the ASME 2019 38th International Conference on Ocean, Offshore and Arctic Engineering OMAE2019, Glasgow, Scotland, UK.
- Barba, M.J. (1880). Resistance des Matériaux. Epreuves de résistance a la traction. Étude sur les allongements des métaux après rupture. *Mémoires de la Société des Ingénieurs Civils, Part I*, 682.
- Baxevanis, D. (2019). *Residual Strength Assessment of Corroded Ships Involved in Ship-to-Ship Collisions*. (MSc). Chalmers University of Technology, Gothenburg, Sweden. (2019/85)
- Beghin, D. (2013). Technical evolution in the ship structural analysis over the last 50 years. *Ships and Offshore Structures*, 8(3-4), 337-345.
- BV, Bureau Veritas. (2020). *Rules for the Classification of Steel Ships, Part B - Hull and Stability*. Bureau Veritas Marine & Offshore. Paris, France.
- Cai, J., Jiang, X., & Lodewijks, G. (2015). *Ultimate Strength of Damaged Stiffened Panels Subjected to Uniaxial Compressive Loads Accounting for Impact Induced Residual Stress and Deformation*. Paper presented at the ASME 2015 34th International Conference on Ocean, Offshore and Arctic Engineering OMAE 2015, St. John's, Newfoundland, Canada.
- Caldwell, J.B. (1965). Ultimate Longitudinal Strength. *Transactions of RINA*, 107, 411-430.
- Calle, M.A.G., & Alves, M. (2015). A Review-Analysis on Material Failure Modeling in Ship Collision. *Ocean Engineering*, 106, 20-38.
- Campanile, A., Piscopo, V., & Scamardella, A. (2015). Statistical Properties of Bulk Carrier Residual Strength. *Ocean Engineering*, 106, 47-67.
- Campanile, A., Piscopo, V., & Scamardella, A. (2018a). Comparative Analysis Among Deterministic and Stochastic Collision Damage Models for Oil Tanker and Bulk Carrier Reliability. *International Journal of Naval Architecture and Ocean Engineering*, 10, 21-36.
- Campanile, A., Piscopo, V., & Scamardella, A. (2018b). Conditional Reliability of Bulk Carriers Damaged by Ship Collisions. *Marine Structures*, 58, 321-341.
- Chen, B.Q., & Soares, C.G. (2015). Study on Ultimate Strength of Ship Plates with Calculated Weld-Induced Residual Stress. In C. G. Soares & T. A. Santos (Eds.), *Maritime Technology and Engineering* (pp. 513-521). London, UK: Taylor & Francis Group.
- Chen, K.Y. (1983). Ultimate Strength of Ship Structures. *Trans SNAME*, 91, 149-168.
- Choung, J., Nam, J.-M., & Ha, T.-B. (2012). Assessment of Residual Ultimate Strength of an Asymmetrically Damaged Tanker Considering Rotational and Translational Shifts of Neutral Axis Plane. *Marine Structures*, 25, 71-84.
- ClassNK. (2014). *Investigation Report on Structural Safety of Large Container Ships*. The Investigative Panel on Large Container Ship Safety.

- Corak, M., & Parunov, J. (2020). Structural Reliability of Oil Tanker in the Adriatic Sea Damaged in Collision and Exposed to Combined Bending Moments. *Journal of Offshore Mechanics and Arctic Engineering*, 142(3), 0311031-0311039.
- Cowper, G.R., & Symonds, P.S. (1957). *Strain-Hardening and Strain-Rate Effects in the Impact Loading of Cantilever Beams* (Tech. Rep. 28). Brown University, Division of Applied Mechanics. Providence, RI, USA.
- CPEM. (2000). *Report of the Enquiry into the Sinking of the Erika off the Coast of Brittany on 12 December 1999*. Permanent Commission of Enquiry into Accidents at Sea (CPEM).
- Darie, I., Roerup, J., & Wolf, V. (2013). *Ultimate Strength of a Cape Size Bulk Carrier under Combined Global and Local Loads*. Paper presented at the PRADS2013, CECO, Changwon City, Korea, October 20-25, 1173-1180.
- Dassault Systemes. (2013). *Abaqus Analysis User's Guide*.
- Doan, V.T., Liu, B., Garbatov, Y., Wu, W., & Soares, C. G. (2020). Strength assessment of aluminium and steel stiffened panels with openings on longitudinal girders. *Ocean Engineering*, 200, 107047.
- Dow, R.S., Hugill, R.C., Clark, J.D., & Smith, C.S. (1981). *Evaluation of Ultimate Ship Hull Strength*. Paper presented at the Ship Structures Symposium '81: Extreme Loads Response, Arlington, Virginia, USA, October 19-20, 133-148.
- Dow, R.S., & Smith, C.S. (1984). Effects of Localized Imperfections on Compressive Strength of Long Rectangular Plates. *Journal of Construction Steel Research*, 4, 51-76.
- Dowling, P.J., Chatterjee, S., Frieze, P.A., & Moolani, F.M. (1973). *Experimental and Predicted Collapse Behaviour of Rectangular Steel Box Girders*. Paper presented at the International Conference on Steel Box Girder Bridges, London, February 13-14, 77-94.
- Downes, J., Tayyar, G.K., Kvan, I., & Choung, J. (2017). A New Procedure for Load-Shortening and -Elongation Data for Progressive Collapse Method. *International Journal of Naval Architecture and Ocean Engineering*, 9, 705-719.
- Ehlers, S. (2010a). The Influence of the Material Relation on the Accuracy of Collision Simulations. *Marine Structures*, 23, 462-474.
- Ehlers, S. (2010b). A Procedure to Optimize Ship Side Structures for Crashworthiness. *Proceedings of the Institution of Mechanical Engineers Part M: Journal of Engineering for Maritime Environment*, 224, 1-11.
- Ehlers, S. (2010c). Strain and Stress Relation Until Fracture for Finite Element Simulations of a Thin Circular Plate. *Thin-Walled Structures*, 48, 1-8.
- Ehlers, S., & Ostby, E. (2012). Increased Crashworthiness due to Arctic Conditions – The Influence of Sub-Zero Temperature. *Marine Structures*, 28, 86-100.
- EMSA, European Maritime Safety Agency. (2019). *Annual Overview of Marine Casualties and Incidents*.
- Faisal, Muhammad, Noh, Sung Hwan, Kawsar, Md. Rokan Uddin, Youssef, Samy A.M., Seo, Jung Kwan, Ha, Yeon Chul, & Paik, Jeom Kee. (2017). Rapid hull collapse strength calculations of double hull oil tankers after collisions. *Ships and Offshore Structures*, 12(5), 624-639.
- Fang, C., & Das, P.K. (2004). *Hull Girder Ultimate Strength of Damaged Ships*. Paper presented at the 9th Symposium on Practical Design of Ships and Other Floating Structures PRADS2004, Luebeck-Travemuende, Germany.
- Faulkner, D. (1975). A Review of Effective Plating for Use in the Analysis of Stiffened Plating in Bending and Compression. *Journal of Ship Research*, 19(1), 1-17.
- Frankland, J.M. (1940). *The Strength of Ship Plating Under Edge Compression* (469). U.S. Experimental Model Basin. Navy Yard, Washington, D.C.
- Fujikubo, M., Takemura, K., Oka, S., Alie, M.Z.M., & Iijima, K. (2012). Residual Hull Girder Strength of Asymmetrically Damaged Ships. *Journal of the Japan Society of Naval Architects and Ocean Engineers*, 16, 131-140.

- Gannon, L., Liu, Y., Pegg, N.G., & Smith, M.J. (2016). Nonlinear Collapse Analysis of Stiffened Plates Considering Welding-Induced Residual Stress and Distortion. *Ships and Offshore Structures*, 11(3), 228-244.
- Garbatov, Y., Parunov, J., Kodvanj, J., Saad-Eldeen, S., & Soares, C.G. (2016). Experimental Assessment of Tensile Strength of Corroded Steel Specimens Subjected to Sandblast and Sandpaper Cleaning. *Marine Structures*, 49, 18-30.
- Garbatov, Y., Saad-Eldeen, S., Soares, C. G., Parunov, J., & Kodvanj, J. (2019). Tensile Test Analysis of Corroded Cleaned Aged Steel Specimens. *Corrosion Engineering*, 54(2), 154-162.
- Garbatov, Y., Sisci, F., & Ventura, M. (2018). Risk-Based Framework for Ship and Structural Design Accounting for Maintenance Planning. *Ocean Engineering*, 166, 12-25.
- Garbatov, Y., Soares, C. G., Parunov, J., & Kodvanj, J. (2014). Tensile Strength Assessment of Corroded Small Scale Specimens. *Corrosion Science*, 85, 295-303.
- Garbatov, Y., Tekgoz, M., & Soares, C. G. (2017). Experimental and Numerical Strength Assessment of Stiffened Plates Subjected to Severe Non-Uniform Corrosion Degradation and Compressive Load. *Ships and Offshore Structures*, 12(4), 461-473.
- Gordo, J.M., & Soares, C.G. (1993). Approximate Load Shortening Curves for Stiffened Plates Under Uniaxial Compression. *Integrity of Offshore Structures*, 5, 189-211.
- Gordo, J.M., & Soares, C.G. (1996). Approximate Method to Evaluate the Hull Girder Collapse Strength. *Marine Structures*, 9, 449-470.
- Gordo, J.M., & Soares, C.G. (1997). Interaction Equation for the Collapse of Tankers and Containerships Under Combined Bending Moments. *Journal of Ship Research*, 41(3), 230-240.
- Gordo, J.M., & Soares, C.G. (2000). *Residual Strength of Damaged Ship Hulls*. Paper presented at the Ninth IMAM Conference, Napoli, Italy, January, 79-86.
- Hogström, P., & Ringsberg, J.W. (2012). An Extensive Study of a Ship's Survivability After Collision – A Parameter Study of Material Characteristics, Non-Linear FEA and Damage Stability Analyses. *Marine Structures*, 27, 1-28.
- Hogström, P., & Ringsberg, J.W. (2013). Assessment of the Crashworthiness of a Selection of Innovative Ship Structures. *Ocean Engineering*, 59, 58-72.
- Hogström, P., Ringsberg, J.W., & Johnson, E. (2009). An Experimental and Numerical Study of the Effects of Length Scale and Strain Rate on the Necking and Fracture Behaviours in Sheet Metals. *International Journal of Impact Engineering*, 36, 1194-1203.
- Hughes, O.F., & Paik, J.K. (2013). *Ship Structural Analysis and Design*. Alexandria, VA: Society of Naval Architects and Marine Engineers (SNAME).
- Hussein, A.W., & Soares, C.G. (2009). Reliability and Residual Strength of Double Hull Tankers Designed According to the New IACS Common Structural Rules. *Ocean Engineering*, 36(17-18), 1446-1459.
- IACS, International Association of Classification Societies. (2006). *Common Structural Rules for Bulk Carriers*.
- IACS, International Association of Classification Societies. (2019). *Common Structural Rules for Bulk Carriers and Oil Tankers*.
- IMO, International Maritime Organization. (2010). *Resolution MSC.287 - Adoption of the International Goal-Based Ship Construction Standards for Bulk Carriers and Oil Tankers*.
- ISSC, International Ship and Offshore Structures Congress. (1979). *Committee II.2 on Non-Linear Structural Response*. Paris, France.
- ISSC, International Ship and Offshore Structures Congress. (2000). *Committee VI. 2 Ultimate Hull Girder Strength*. Nagasaki, Japan.
- ISSC, International Ship and Offshore Structures Congress. (2012). *Committee III.1 Ultimate Strength*. Rostock, Germany.

- ISSC, International Ship and Offshore Structures Congress. (2018). *Committee III.1 Ultimate Strength*. Liege, Belgium; Amsterdam, The Netherlands.
- John, W.G. (1874). The Strength of Iron Ships. *Transactions of INA*.
- Juriscic, P., Parunov, J., & Garbatov, Y. (2017). Ageing Effects on Ship Structural Integrity. *Brodogradnja*, 68(2), 15-28.
- Kim, D.K., Kim, H.B., Zhang, X., Li, C.G., & Paik, J.K. (2014). Ultimate Strength Performance of Tankers Associated with Industry Corrosion Addition Practices. *International Journal of Naval Architecture and Ocean Engineering*, 6, 507-528.
- Kitarovic, S., & Zanic, V. (2014). Approximate Approach to Progressive Collapse Analysis of the Monotonous Thin-Walled Structures in Vertical Bending. *Marine Structures*, 39, 255-286.
- Kuznecovs, A., & Shafieisabet, R. (2017). *Analysis of the Ultimate Limit State of Corroded Ships after Collision*. (Master thesis report: X-17/376). Chalmers University of Technology, Gothenburg, Sweden.
- Lampe, J., & Hamann, R. (2018). Probabilistic Model for Corrosion Degradation of Tanker and Bulk Carrier. *Marine Structures*, 61, 309-325.
- Lee, T.-K., Rim, C.W., Han, D.-S., Kim, B.H., Lee, J.-M., & Kim, K.S. (2008). *A Study of Ultimate Collapse Strength in Sagging of Ship Structures with Side Collision Damage*. Paper presented at the 18th International Offshore and Polar Engineering Conference, Vancouver, BC, Canada, July 6-11, 503-508.
- Liu, B., Garbatov, Y., Zhu, L., & Soares, C. G. (2018). Numerical Assessment of the Structural Crashworthiness of Corroded Ship Hulls in Stranding. *Ocean Engineering*, 170, 276-285.
- Maeno, Y, Yamaguchi, H, Fujii, Y, & Yao, T. (2004). *Buckling/Plastic Collapse Behaviour and Strength of Bilge Circle and Its Contribution to Ultimate Longitudinal Strength of Ship's Hull Girder*. Paper presented at the The 14th International Offshore and Polar Engineering Conference, ISOPE, Toulon, France.
- Maginnis, A.J. (1900). *The Atlantic Ferry: Its Ships, Men and Working*. London, UK: Whittaker & Co.
- MAIB, Marine Accident Investigation Branch. (2008). *Report on the Investigation of the Structural Failure of MSC Napoli English Channel on 18 January 2007*. Southampton, United Kingdom.
- Makouei, S.H., Teixeira, A.P., & Soares, C.G. (2015). A Study on the Progressive Collapse Behaviour of a Damaged Hull Girder. In C. G. Soares & T. A. Santos (Eds.), *Maritime Technology and Engineering* (pp. 405-415). London, UK: Taylor & Francis Group.
- Marinatos, J.N., & Samuelides, M.S. (2015). Towards a Unified Methodology for the Simulation of Rupture in Collision and Grounding of Ships. *Marine Structures*, 42, 1-32.
- Marine Nationale. (2018). Collision en Corse : 96.000 heures de travail par plus de 500 personnes. 34 bateaux et 11 aéronefs mobilisés. Retour en images. Twitter: Marine Nationale Retrieved from <https://t.co/wFco70rluB>.
- Masaoka, K., & Mansour, A.E. (2008). Compressive Strength of Stiffened Plates with Imperfections: Simple Design Equations. *Journal of Ship Research*, 52(3), 227-337.
- MRCC Mumbai, Maritime Rescue Coordination Centre. (2013).
- NORSOK. (2004). NORSOK Standard. *Design of Steel Structures* (Vol. N-004): Standards Norway.
- Paik, J.K. (2018). *Ultimate Limit State Analysis and Design of Plated Structures* (2 ed.). Hoboken, NJ: John Wiley & Sons.
- Paik, J.K., & Kim, D.K. (2012). Advanced Method for the Development of an Empirical Model to Predict Time-Dependent Corrosion Wastage. *Corrosion Science*, 63, 51-58.

- Paik, J.K., Kim, D.K., Park, D.H., Kim, H.B., Mansour, A.E., & Caldwell, J.B. (2013). Modified Paik-Mansour Formula for Ultimate Strength Calculations of Ship Hulls. *Ships and Offshore Structures*, 8, 245-260.
- Paik, J.K., Lee, J.M., Hwang, J.S., & Park, Young II. (2003a). A Time-Dependent Corrosion Wastage Model for the Structures of Single- and Double-Hull Tankers and FSOs and FPSOs. *Marine Technology*, 40(3), 201-217.
- Paik, J.K., Lee, J.M., Park, Y.II, Hwang, J.S., & Kim, C.W. (2003b). Time-variant ultimate longitudinal strength of corroded bulk carriers. *Marine Structures*, 16(8), 567-600.
- Paik, J.K., & Mansour, A.E. (1995). A Simple Formulation for Predicting the Ultimate Strength of Ships. *Journal of Marine Science and Technology*, 1, 52-62.
- Paik, J.K., & Thayamballi, A.K. (2002). A Concise Introduction to the Idealized Structural Unit Method for Nonlinear Analysis of Large Plated Structures and its Application. *Thin-Walled Structures*, 41, 329-355.
- Papanikolaou, A., Bitha, K., Eliopoulou, E., & Ventikos, N.P. (2015). *Statistical Analysis of Ship Accidents that Occured in the Period 1990-2012 and Assessment of Safety Level of Ship Types*. Paper presented at the Maritime Technology and Engineering, Lisbon.
- Parunov, J., Rudan, S., Gledić, I., & Primorac, B.B. (2018). Finite Element Study of Residual Ultimate Strength of a Double hull Oil Tanker with Simplified Collision Damage and Subjected to Bi-Axial Bending. *Ships and Offshore Structures*, 13(S1), S25-S36.
- Ringsberg, J.W., Li, Z., & Johnson, E. (2017). *Performance Assessment of the Crashworthiness of Corroded Ship Hulls*. Paper presented at the Sixth International Conference on Marine Structures (MARSTRUCT2017), Lisbon, Portugal, May 8-10, 523-531.
- Rutherford, S.E. (1990). Ultimate Longitudinal Strength of Ships: A Case Study. *SNAME Transactions*, 98, 441-471.
- Saad-Eldeen, S., Garbatov, Y., & Soares, C. G. (2011). Experimental Assessment of the Ultimate Strength of a Box Girder Subjected to Severe Corrosion. *Marine Structures*, 24, 338-357.
- Saad-Eldeen, S., Garbatov, Y., & Soares, C.G. (2010). *Experimental Assessment of the Ultimate Strength of a Box Girder Subjected to Four-Point Bending Moment*. Paper presented at the 11th Int. Symp. on Practical Design of Ships and other Floating Structures, Rio de Janeiro, Brasil, September 19-24, 1134-1143.
- Samuelides, M.S. (2015). Recent advances and future trends in structural crashworthiness of ship structures subjected to impact loads. *Ships and Offshore Structures*, 10(5), 488-497.
- Schreuder, M. (2014). *Development, Implementation, Validation and Applications of a Method for Simulation of Damaged and Intact Ships in Waves*. (Dissertation no. 3653). Chalmers University of Technology, Gothenburg, Sweden.
- Seo, J.K., Song, C.H., Park, J.S., & Paik, J.K. (2016). Nonlinear Structural Behaviour and Design Formulae for Calculating the Ultimate Strength of Stiffened Curved Plates Under Axial Compression. *Thin-Walled Structures*, 107, 1-17.
- Smith, C.S. (1977). *Influence of Local Compressive Failure on Ultimate Longitudinal Strength of a Ship's Hull*. Paper presented at the PRADS - International Symposium on Practical Design in Shipbuilding, Tokyo, Japan.
- Smith, C.S., Davidson, P.C., Chapman, J.C., & Dowling, P.J. (1988). Strength and Stiffness of Ships' Plating under In-Plane Compression and Tension. *Royal Institution of Naval Architects Transactions*, 130, 277-296.
- Smith, C.S., & Dow, R.S. (1981). Residual Strength of Damaged Steel Ships and Offshore Structures. *Journal of Construction Steel Research*, 1(4).
- SSC, Ship Structure Committee. (2003). *Prestige: Complete Hull Failure in a Singe-Hull Tanker*. Retrieved from http://www.shipstructure.org/case_studies/prestige/Prestige.pdf

- Steen, E., Byklum, E., Vilming, K.G., & Ostvold, T.K. (2004). *Computerized Buckling Models for Ultimate Strength Assessment of Stiffened Ship Hull Panles*. Paper presented at the 9th Symposium on Practical Design of Ships and Other Floating Structures, Luebeck-Travemuende, Germany, September 12-17, 235-242.
- Storheim, M., Alsos, H.S., Hopperstad, O.S., & Amdahl, J. (2015). A Damage-Based Failure Model for Coarsely Meshed Shell Structures. *International Journal of Impact Engineering*, 83, 59-75.
- Sumi, Y. (2019). Structural safety of ships developed by lessons learned from the 100-year history of break-in-two accidents. *Marine Structures*, 64, 481-491.
- Tanaka, Y., Ogawa, Y., Tatsumi, A., & Fujikubo, M. (2015). Analysis Method of Ultimate Hull Girder Strength Under Combined Loads. *Ships and Offshore Structures*, 10(5), 587-598.
- Tatsumi, A., & Fujikubo, M. (2020). Ultimate Strength of Container Ships Subjected to Combined Hogging Moment and Bottom Local Loads Part 1: Nonlinear Finite Element Analysis. *Marine Structures*, 69, 102683.
- Tatsumi, A., Ko, H. H. H., & Fujikubo, M. (2020). Ultimate strength of container ships subjected to combined hogging moment and bottom local loads. *Marine Structures*, 71, 102738.
- Tekgoz, M., Garbatov, Y., & Soares, C. G. (2018). Strength Assessment of an Intact and Damaged Container Ship Subjected to Asymmetrical Bending Loadings. *Marine Structures*, 58, 172-198.
- Toh, K., Maeda, S., & Yoshikawa, T. (2016). *A Study on the Simplified Calculation Method for the Residual Ultimate Strength of Damaged Hull Structures*. Paper presented at the ASME 2016 35th International Conference on Ocean, Offshore and Arctic Engineering OMAE 2016, Busan, South Korea.
- Transportstyrelsen. (2017). *Transportstyrelsens Säkerhetsöversikt, Luftfart och Sjöfart*. Sjö- och luftfartsavdelningen.
- Ueda, Y., & Rashed, S.M.H. (1984). The Idealized Structural Unit Method and its Application to Deep Girder Structures. *Computers & Structures*, 18(2), 277-293.
- Watanabe, I., & Ohtsubo, H. (1998). Analysis of the Accident of the MV Nakhodka. Part 1. Estimation of Wave Loads. *Marine Science and Technology*, 3, 171-180.
- Veritas Tankers Rederi AB. Retrieved from <https://www.veritastankers.com/astoria>.
- Woloszyk, K., Kahsin, M., & Garbatov, Y. (2018). Numerical Assessment of Ultimate Strength of Severe Corroded Stiffened Plates. *Engineering Structures*, 168, 346-354.
- Yamada, Y. (2014). *Numerical Study on the Residual Ultimate Strength of Hull Girder of a Bulk Carrier after Ship-Ship Collision*. Paper presented at the ASME 2014 33rd International Conference on Ocean, Offshore and Arctic Engineering OMAE2014, San Francisco, California, USA, June 8-13, V04AT02A06.
- Yamada, Y., Endo, H., & Pedersen, P. T. (2005). *Numerical Study on the Effect of Buffer Bow Structure in Ship-Ship Collision*. Paper presented at the 15th International Offshore and Polar Engineering Conference, Seoul, Korea, June 19-24, 604-611.
- Yamada, Y., & Ogawa, Y. (2011). Study on the Residual Ultimate Longitudinal Strength of Hull Girder of a Bulk Carrier Against a Sagging Moment after Ship Collision. In *Advances in Marine Structures* (pp. 429-436). London, UK: Taylor & Francis Group.
- Yamamoto, Y., Ohtsubo, H., Iwai, Y., Watanabe, I., Kumano, A., Fujino, M., . . . Kuroiwa, T. (1983). Disastrous Damage of a Bulk Carrier due to Slamming. *Journal of Society of Naval Architects of Japan*, 154, 516-524.
- Yao, T., & Fujikubo, M. (2016). Progressive Collapse Behavior and Ultimate Strength of Hull Girder of Ship and Ship-Like Structures in Longitudinal Bending. In *Buckling and Ultimate Strength of Ship and Ship-Like Floating Structures*. Oxford, UK: Butterworth-Heinemann.

- Yao, T., Sumi, Y., Takemoto, H., Kumano, A., Sueoka, H., & Ohtsubo, H. (1998). Analysis of the Accident of the MV Nakhodka. Part 2. Estimation of Structural Strength. *Marine Science and Technology*, 3, 181-193.
- Youssef, S.A.M., Noh, S.H., & Paik, J.K. (2017). A New Method for Assessing the Safety of Ships Damaged by Collisions. *Ships and Offshore Structures*, 12(6), 862-872.
- Zhang, S., & Khan, I. (2009). Buckling and Ultimate Capability of Plates and Stiffened Panels in Axial Compression. *Marine Structures*, 22, 791-808.
- Zhang, S., Pedersen, P. T., & Villavicencio, R. (2019a). *Probability and Mechanics of Ship Collision and Grounding*. Oxford, UK: Butterworth-Heinemann.
- Zhang, S., Villavicencio, R., Zhu, L., & Pedersen, P. T. (2019b). Ship Collision Damage Assessment and Validation with Experiments and Numerical Simulations. *Marine Structures*, 63, 239-256.