



Munich Personal RePEc Archive

Firm Pay Dynamics

Engbom, Niklas and Moser, Christian

New York University, Columbia University

3 February 2020

Online at <https://mpra.ub.uni-muenchen.de/98477/>

MPRA Paper No. 98477, posted 05 Feb 2020 19:56 UTC

Firm Pay Dynamics*

Niklas Engbom[†]

Christian Moser[‡]

February 3, 2020

Abstract

We study the nature of firm pay dynamics using matched employer-employee data from Sweden, including rich, administrative firm financial data. To this end, we propose and estimate a statistical model that extends the seminal framework by [Abowd, Kramarz, and Margolis \(1999a\)](#), henceforth AKM) to flexibly account for time-varying firm pay policies. We validate our approach by showing that firm-year pay variation is systematically related to firm financial performance. Subsequently, we apply our methodology to assess the role of firm pay dynamics in accounting for a rise in earnings inequality in Sweden, to investigate the properties of the distribution of within-firm pay differences over time, to measure the degree of firm pay mobility, and to quantify the relative contribution of ex-ante versus ex-post heterogeneity towards firm pay differences over the firm life cycle. We conclude that no more than two thirds of firm pay heterogeneity are permanent, with persistent and transitory fluctuations in firm pay constituting the remainder.

Keywords: Wage Determination, Mobility, Worker and Firm Heterogeneity, Two-Way Fixed Effects Model, AKM, Firm Dynamics, Inequality Trends, Income Risk, Insurance within the Firm

JEL classification: J31, D22, D31, E24, M13

*We are grateful to Benjamin Friedrich, Émilien Gouin-Bonenfant, Matthias Kehrig, Fabian Lange, Rasmus Lentz, Alexandre Mas, Oskar Nordström Skans, Raffaele Saggio, Johannes Schmieder, Ian Schmutte, and Mikkel Sølvsten for helpful discussions. We also thank attendants at the 2019 Models of Linked Employer-Employee Data Conference in New York City, the 2019 German Economists Abroad Conference in Frankfurt, and seminar participants at Columbia University for their comments. Rachel Williams provided excellent research assistance. All errors are our own.

[†]Stern School of Business, New York University. E-mail: niklas.engbom@gmail.com.

[‡]Graduate School of Business, Columbia University. E-mail: c.moser@columbia.edu.

1 Introduction

A burgeoning literature studies the role of firms in accounting for worker-level labor market outcomes, in particular for the distribution of pay.¹ Much of this literature builds on the seminal framework by [Abowd, Kramarz, and Margolis \(1999a\)](#), henceforth AKM), which controls for both worker and firm fixed effects (henceforth FEs) among other covariates. A great strength of this framework is that it allows one to simultaneously account for unobserved but time-invariant worker and firm heterogeneity in pay. However, a strong assumption underlying this framework is that firm pay is constant over arbitrarily long time horizons. In sharp contrast, canonical models of firm dynamics postulate that firms are subject to idiosyncratic shocks (e.g., [Hopenhayn, 1992](#)) and the empirical evidence confirms that worker-firm rent sharing responds to such shocks (e.g., [Guiso et al., 2005](#)). This raises a sequence of important questions: How dynamic is firm pay? Why do firms adjust their pay over time? And what are the implications of firm pay dynamics for short-run versus long-run pay inequality?

In pursuit of answers to these questions, we develop a new empirical framework that controls for idiosyncratically time-varying firm pay policies. We estimate and validate the framework on 30 years of detailed matched employer-employee data from Sweden and use it to study the nature of firm pay dynamics. Our results suggest that there is substantial variation in firm-year pay (relative to a model with fixed firm pay policies), that trends in incumbent firm pay policies explain a large rise in pay inequality in Sweden over the past decades, and that there is significant mean reversion in firm pay resulting in sizable firm pay mobility at various time horizons. Altogether our results highlight the importance of modeling firm pay as a dynamic object.

To study firm pay dynamics, we extend the seminal framework by AKM to allow for idiosyncratically time-varying firm pay policies via a set of fully flexible firm-year FEs. We show that, analogous to the usual notion of a connected set ([Abowd et al., 2002](#)), the firm-year FE model is identified for a set of firms and workers that are linked through worker transitions between firm-years.² To quantify the importance of firm-year pay policies, we estimate a sequence of firm-year

¹See [Card et al. \(2018\)](#) for a recent overview of this literature. Notably, [Card et al. \(2013b\)](#) argue that increasing dispersion in pay across firms accounts for a significant share of the overall trend of increasing wage inequality in Germany, and [Alvarez et al. \(2018\)](#) find that a compression in firm pay was an important factor behind a large decline in earnings inequality in Brazil over the past decades.

²While, in theory, the largest connected set in our firm-year FE model and that in the AKM firm FE model are not congruent, we find that in practice they are virtually identical and cover close to the entire set of worker-year observations.

FE specifications with increasingly higher minimum firm size thresholds on the Swedish linked employer-employee data from 1986–2015. Variation in firm-year pay policies explain a significant share of the overall variance in log monthly earnings, ranging from 18 to 10 percent across specifications. The correlation between the estimated firm-year and worker components of pay ranges from 1 to 13 percent across specifications. Moreover, as we increase the minimum firm size threshold across specifications, we find a gradually lower variance of the estimated firm-year component of pay and a gradually higher correlation between firm-year and worker components of pay, consistent with the presence of limited-mobility bias in the population data (Andrews et al., 2008). However, the variance components and the worker/firm-year correlation stabilize around a minimum firm size threshold of 10 workers.

To validate our empirical approach, we document that our firm-year FE estimates are strongly positively correlated with firm financial performance, such as firm-level productivity measured by value added per worker, sales per worker, firm size, and assets per worker. Within-firm differences in firm-year FEs also covary positively with firm financials. Finally, the estimated firm-year effects are closely related, but far from identical, to a set of AKM firm FEs and raw firm-level mean earnings. Together, these observations give us confidence in the validity of our proposed framework.

After successfully validating our empirical approach, we proceed to exploit the strengths of our framework in various applications related to firm pay dynamics. We first dissect secular trends in firm pay inequality in Sweden over the past 30 years. We document that dispersion in firm pay has increased over this period, mirroring trends in, for instance, Germany (Card et al., 2013b) and the US (Song et al., 2018). We find that a large share of this increase is due to changes in the distribution of firm pay policies as proxied by the distribution of firm-year FEs. The increase in firm pay inequality has been particularly pronounced in the right tail of the distribution of firm pay and a large share of the increase has taken place among incumbent firms. Importantly, a framework with firm FEs, like the original work by AKM and follow-up work including Card et al. (2013b) and Song et al. (2018), would have been unable to attribute this increase in firm pay inequality to the changing behavior of incumbent firms, since that framework by construction rules out any within-firm differences in firm FEs.

We proceed to dissect the distribution of firm pay changes, exploiting the large scale and long panel of our data. The distribution of firm pay changes displays excess kurtosis, mirror-

ing individual-level earnings changes. In other words, the tails of the distribution of firm pay changes has more mass in the tails relative to a normal distribution. From the perspective of a risk-averse worker, the standard deviation of firm pay changes hence fails to fully reflect the welfare consequences of firm pay dynamics.

Next, we show that the distribution of firm-year FEs at new firms is lower on average, more dispersed, and more left-skewed than that at all firms in the population. Furthermore, there are some substantial fluctuations in initial firm pay across cohorts of firms. We find that pay at startups is relatively more sensitive to the business cycle, rising by more than that of incumbents during expansions and falling by more during recessions. For example, the cyclical component of new firms' pay (relative to that of all firms) extracted using a Hodrick-Prescott (HP) filter at annual frequency has a correlation of 35 percent with the negative of the unemployment rate.

Finally, to quantify the relative importance of permanent differences versus persistent and transitory fluctuations in firm pay, we borrow from the literature on individual earnings dynamics to study the structure of the autocovariance structure of firm pay (MaCurdy, 1982; Abowd and Card, 1989; Sterk et al., 2018). Partly consistent with the AKM firm FE approach, we find that in an unbalanced panel of firms permanent firm pay heterogeneity plays a quantitatively important role, accounting for 62 percent of the long-run variance of firm-year FEs. A persistent AR(1) component accounts for another 31 percent, with an estimated annual autocorrelation of 67 percent. The remaining 7 percent of the long-run variance in firm-year FEs is due to independent and identically distributed (iid) transitory fluctuations. We conclude that while firm pay is persistent, there is a quantitatively important dynamic component of firm pay.

Altogether, our findings suggest that firm pay dynamics are both statistically and economically meaningful and that firms play an important role in the transmission of both idiosyncratic firm-level and aggregate shocks to worker-level outcomes, in particular pay.

Related literature. With the new availability of administrative linked employer-employee datasets, a large empirical literature has studied the determinants of worker and firm heterogeneity in wage determination. The econometric framework commonly employed in this literature is the seminal two-way FEs model by AKM, which identifies worker and firm FEs separately from workers switching employers over time. Many studies have built on this framework and highlighted the importance of firm FEs in explaining both cross-sectional patterns of wage dispersion and time

trends in wage dispersion. To study cross-sectional wage dispersion, an econometrician would commonly estimate the AKM model within a fixed time window (Abowd et al., 1999b, 2002; Card et al., 2018; Sorkin, 2018). To study time trends in wage dispersion, an econometrician would commonly estimate the AKM model within rolling time windows and compare cross-sectional estimates across time windows (Card et al., 2013b; Song et al., 2018; Alvarez et al., 2018).

While this literature has delivered insights of great importance, it has at least two salient limitations. First, firm pay policies are assumed to be fixed within a given time window. Second, to the extent that firm pay policies change between consecutive time windows among incumbent firms, the empirical model is almost certainly misspecified and silent on how these changes come about. We fill this gap by proposing a more flexible empirical model that allows for idiosyncratically time-varying firm pay policies, which we capture through a set of firm-year FEs. Allowing for time-varying firm pay policies allows us to measure fluctuations in firm pay at all frequencies within a single estimation time window.

To allow for firm-specific fluctuations in pay seems natural in light of a large parallel literature studying the pass-through of firm-level shocks to worker-level outcomes (Van Reenen, 1996; Guiso et al., 2005; Lemieux et al., 2009; Card et al., 2013a; Kline et al., 2019a; Garin and Silvério, 2019; Kehrig and Vincent, 2019; Chan et al., 2019; Moser et al., 2019). Much of this literature is concerned with estimating rent-sharing elasticities for incumbent workers who remain employed. Recent exceptions include Lamadon (2016) and Friedrich et al. (2019), who explicitly model worker mobility between firms. Relative to previous work, our empirical approach has the advantage that, first, we do not need to take a stance on the sources of the fluctuations in firm pay and, second, we obtain worker selection-corrected estimates of firm pay that does not depend on the pattern of stayers versus switchers across firms.

In contemporaneous work, Lachowska et al. (2019) develop a similar framework for estimating firm-year pay heterogeneity subject to leave-one-out bias correction based on a method by Kline et al. (2019b), which they apply to data from the US state of Washington. Our works share the application of such a framework to study time trends in firm pay. Notable aspects that distinguish our work from theirs include our use of detailed firm financials data, our study of various moments of the distribution of within-firm pay differences, our exploration of firm pay mobility, and our focus on ex-ante versus ex-post firm pay heterogeneity. These are examples of the important issues that our framework can help address, which to the best of our knowledge have not been

previously explored.

Our empirical findings also help discipline a new generation of structural models of firm heterogeneity in the labor market. While, traditionally, a large class of models have assumed that firm (pay) heterogeneity is fixed (Burdett and Mortensen, 1998; Bagger and Lentz, 2018; Engbom and Moser, 2018), a new generation of models allows for rich idiosyncratic dynamics in firm pay (Moscarini and Postel-Vinay, 2012; Lise and Robin, 2017; Moscarini and Postel-Vinay, 2018; Bilal et al., 2019; Elsby and Gottfries, 2019). These models are at times silent about the nature of wage setting, since only the value or surplus of a match is theoretically pinned down. Our rich set of empirical facts on firm pay dynamics can help discipline the wage setting side of these models, which is of great interest for further structural work related to the wage distribution.

Outline. The rest of the paper is structured as follows. Section 2 describes and summarizes the linked employer-employee records and firm financials data from Sweden. Section 3 introduces the firm-year FE model, discusses identification, presents a variance decomposition for the estimated model, and validates the model findings with regards to alternative firm pay measures and observable firm financials. Section 4 explores various dimensions of firm pay dynamics. It dissects the distribution of firm pay over time, and studies various moments of the distribution of within-firm pay differences, documents patterns of firm pay mobility. It also analyzes the relative importance of ex-ante versus ex-post firm pay heterogeneity, including the distribution of firm pay at firm entry and a statistical decomposition of the long-run variance of firm pay into permanent, persistent, and transitory components. Finally, Section 5 concludes.

2 Data

In this section, we describe our data sources, discuss variable construction and sample selection, and present summary statistics.

2.1 Data Sources and Variable Definitions

To study worker and firm pay dynamics, we analyze rich linked employer-employee data covering the universe of workers and firms in Sweden.³ Specifically, we combine data from three

³These data have some advantages over comparable data available in the U.S. and most other countries. Notably, they contain information on the characteristics of essentially all workers, firms, and jobs in the economy.

sources. First, we draw worker demographics data from the *Registerbaserad Arbetsmarknadsstatistik (RAMS)*. Second, we use employment register data from the *Longitudinell Integrationsdatabas för Sjukförsäkrings- och Arbetsmarknadsstudier (LISA)*. Third, we obtain firm financials data from the *Företagens Ekonomi (FEK)*. These data are originally reported to Swedish government agencies and subsequently consolidated by the Swedish statistical agency, *Statistiska Centralbyrån (SCB)*, to make them available in anonymized form to approved researchers. We describe the three datasets in detail in Appendix [A.1](#).

2.2 Sample Selection

We focus on private sector employees age 18–64 between 1997 and 2015. We limit attention to these years since we have close-to-complete coverage of income and balance sheet information for private sector firms during this period. We further restrict attention to each worker’s main employment spell in every year, which we select by choosing the employment spell with the highest annual earnings.

2.3 Summary Statistics

Table [1](#) summarizes the data. In total, the merged dataset comprises over 18 million individual-year observations. Mean monthly earnings are 10.25 log SEK, which corresponds to around 3,000 USD. The average worker is just below 40 years old and earns 10.25 log SEK (SEK 28,282 or USD 2,938) per month. Around 21 percent of workers hold a higher-education degree. The average firm employs 1,420 workers, is a little over 19 years old, has SEK 4.60 billion in sales, SEK 1.28 billion in value added, SEK 5.48 billion in assets, SEK 2.61 billion in debt (and hence SEK 2.87 billion in equity), and invests SEK 0.13 billion on average.

3 Measuring Firm-Year Pay Heterogeneity

In this section, we introduce an empirical model of firm pay dynamics. Building on the seminal framework by AKM, our goal is to estimate dynamic firm pay heterogeneity while simultaneously controlling for permanent (unobserved) worker heterogeneity.

Table 1. Summary statistics

	Mean	Std. dev.
Panel A. Worker-level variables		
Worker age (years)	39.62	11.10
Share with college degree	0.213	
Monthly earnings (log SEK)	10.25	0.48
Panel B. Firm-level variables		
Firm size (thousands of employees)	1.42	3.05
Firm age (years)	19.20	8.37
Sales (billion SEK)	4.60	10.45
Value added (billion SEK)	1.28	4.13
Assets (billion SEK)	5.48	2.34
Debt (billion SEK)	2.61	9.19
Equity (billion SEK)	2.87	10.84
Investment (billion SEK)	0.13	0.53
Observations	18,412,038	

Note: All monetary variables are in constant 2014 SEK. The number of observations is the number of worker-years. Source: LISA, RAMS, FEK.

3.1 The Firm-Year Fixed Effects Model

We posit the following firm-year FEs model for pay of individual i employed at firm j in year t :

$$y_{ijt} = \alpha_i + \psi_{jt} + \gamma_t + X_{it}\beta + \varepsilon_{ijt}, \quad (1)$$

where y_{ijt} is log earnings, α_i is a worker fixed effect, ψ_{jt} is a firm-year fixed effect restricted to have population mean zero in each year, γ_t is a year fixed effect, X_{it} is a set of time-varying worker controls, and ε_{ijt} is an error term.

Our object of interest in equation (1) are the firm-year FEs, ψ_{jt} , which we interpret as firm pay policies. Such firm pay policies take the form of proportional relative pay premia for workers at a given physical firm in a given year. The simple but important difference between this specification and the original AKM specification is that equation (1) allows for time-varying firm-year FEs, ψ_{jt} . In contrast, AKM and a vast follow-up literature restricts attention to time-invariant firm FEs, ψ_j . Pay policies may be heterogeneous across firms due to labor market frictions or deviations from the perfect-labor-markets benchmark (Engbom and Moser, 2018), the presence of compensating differentials (Rosen, 1986), or both (Morchio and Moser, 2019). Pay policies may change idiosyncratically due to pass-through of firm-level productivity shocks (Guiso et al., 2005), changes in

firm financial conditions (Moser et al., 2019), or firm life-cycle dynamics (Babina et al., 2019).

The inclusion of worker FEs, α_i , in equation (1) allows us to separately control for permanent worker heterogeneity, including unobservable ability differences. Accounting for worker heterogeneity has proven to be of first-order importance in a number of contexts, including labor markets where heterogeneous workers are not randomly or uniformly allocated across firms (Card et al., 2013b; Song et al., 2018). In our context, these controls are crucial because without them it would be impossible to tell apart changes in workforce composition in terms of unobservable time-invariant worker characteristics from changes in firm pay policies.

The specification in equation (1) also controls for standard time-varying observable worker characteristics, X_{it} , including a restricted set of education-specific age dummies. Due to the well-known problem of collinearity between age, cohort, and time, it is not feasible to include unrestricted age dummies or a linear term in age. Following the argument in Card et al. (2018), we normalize age dummies to be constant between ages 50 to 64 based on the raw earnings profile being approximately flat around those ages.⁴

Finally, ε_{ijt} is an error term satisfying the usual strict exogeneity condition: $\mathbb{E}[\varepsilon_{ijt}|i, jt, t, X_{it}] = 0$. As shown by Card et al. (2013b), a sufficient condition for this to hold is that the assignment of workers across (young and old) firms obeys a strict exogeneity condition with respect to ε_{ijt} : $\mathbb{P}[J(i, t) = j | \varepsilon_{ijt}] = \mathbb{P}[J(i, t) = j]$ for all i and t . This assumption is consistent with worker mobility based on worker identity and the identity of all (past, present, and future) firm-years in the economy. However, as in the original AKM model, it rules out mobility based on the residual ε_{ijt} .

To relate our firm-year FEs model to the original firm FEs model by AKM, note that both models are special cases of a generalized firm-set-of-years FEs model. Formally, let firms be indexed by $j \in \mathcal{J}$ and let years be indexed by $t \in \mathcal{T}$. Fix a partition $\mathcal{P} = \{P_k\}_{k=1, \dots, N_p}$ of cardinality $N_p \geq 1$ of the set of years \mathcal{T} .⁵ Now consider the analogue of the regression model in equation (1) but with a firm-set-of-years fixed effect ψ_{jp} for each firm $j \in \mathcal{J}$ and set of years $P \in \mathcal{P}$. This model reduces to the firm FEs model by AKM if $\mathcal{P} = \{\mathcal{T}\}$ with $N_p = 1$, while it reduces to our firm-year FEs model if $\mathcal{P} = \mathcal{T}$ with $N_p = |\mathcal{T}|$. An advantage of the firm-year FEs model over the AKM model is that the former reduces to the latter if in reality firm pay policies are time invariant. Conversely, the AKM model is misspecified if true firm pay policies are time varying.⁶

⁴Alternatively, one could include higher-order (second and above) age polynomial terms as in Card et al. (2013b).

⁵That is, $P_k \subseteq \mathcal{T} \forall k$, $P_k \neq \emptyset \forall k$, $\bigcup_{k=1, \dots, N_p} P_k = \mathcal{T}$, and $P_k \cap P_{k'} = \emptyset$ for any $1 \leq k < k' \leq N_p$.

⁶Another popular approach in the literature is a rolling time window model (Card et al., 2013b; Alvarez et al.,

3.2 Identification

Identification of the firm-year FEs model proceeds analogously to that of the AKM model. The only material difference is that the notion of “physical firms” in the AKM model is replaced with “firm-years” in the firm-year FEs model. To see this, it will be useful to revisit the definition of *connectedness* first in the context of the two-way effects model by AKM and then in the context of our firm-year FEs model.⁷

We first recall the notion of a connected set in the context of the AKM firm FEs model. Identification of the firm FEs model by AKM is obtained within connected sets of observations, where connections are formed through worker mobility across physical firms (Abowd et al., 2002). Physical firms can exist for multiple years, connected sets are defined by switches between physical firms, and workers moving between physical firms constitute switches. Firm FEs within a connected set are relative to the fixed effect of one normalized physical firm. Intuitively, conditional changes in pay as workers switch physical firms identify relative firm pay policies.

We now transpose the notion of a connected set to our firm-year FEs model. Identification of the firm-year FEs framework is obtained within connected sets, where connections are formed through worker mobility across firm-years. Physical firms switch identity each year, connected sets are defined by switches across firm-years, and repeat worker observations (including stayers at physical firms) constitute switches. Firm-year FEs within a connected set are relative to the fixed effect of one normalized firm-year. Intuitively, conditional changes in pay as workers switch firm-years identify relative firm pay policies.

Figure 1 illustrates identification of connected sets in the firm-year FEs model with two periods (indexed $t = 1, 2$) and two firms (indexed A and B) with two employees each (shown as circles). If all workers stay at their original employer, as in panel (a), then two connected sets are formed, one around each physical firm over time. In contrast, if some, but not all, workers switch across physical firms, as in panel (b), the connected set spans both physical firms.

2018; Lachowska et al., 2019), which repeatedly estimates firm FEs models within overlapping periods. A potential advantage of the rolling time window approach is that, in principal, it allows for time-varying unobserved worker heterogeneity. However, one of its disadvantages is that, to the extent that one observes within-firm (within-worker) variation in estimated firm (worker) FEs across time windows, the model is generally misspecified.

⁷Further details and formal definitions of connectedness are contained in Appendix B.1.

Figure 1. Illustrating identification of the connected set(s)

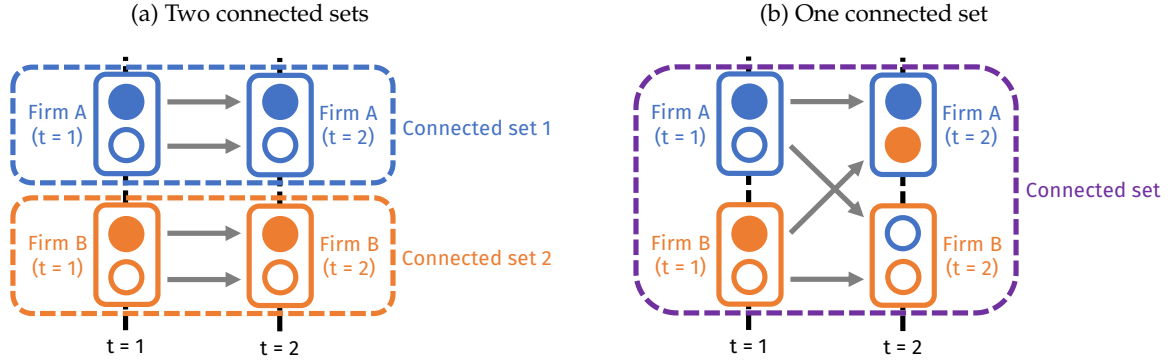

Note: Solid rectangles represent firm-years, with firm A in blue and firm B in orange. Solid and hollow circles represent workers, with worker 1 in solid blue, worker 2 in hollow blue, worker 3 in solid orange, and worker 4 in hollow orange. Vertical dashed lines represent time, with period $t = 1$ to the left and period $t = 2$ to the right. Solid arrows represent worker transitions across firm-years. Dashed rectangles represent the connected set(s) formed by worker transitions across firm-years.

3.3 Variance Decompositions

Based on our estimate of equation (1) via ordinary least squares (OLS) for workers in the largest connected set, we implement a popular variance decomposition (Abowd et al., 1999a; Card et al., 2013b, 2016; Alvarez et al., 2018; Sorkin, 2018; Song et al., 2018). Specifically, we decompose the variance of log earnings into components due to permanent worker heterogeneity, firm-year heterogeneity, the aggregate state, time-varying worker characteristics, covariance terms or sorting, and the residual:

$$Var(y_{ijt}) = Var(\hat{\alpha}_i) + Var(\hat{\psi}_{jt}) + Var(\hat{\gamma}_t) + Var(X_{it}\hat{\beta}) + 2 \sum Cov(\cdot) + Var(\hat{\varepsilon}_{ijt}) \quad (2)$$

Results of the variance decomposition in equation (2) are presented in Table 2. To address concerns about limited-mobility bias affecting the second moments of fixed effect estimates (Abowd et al., 2004; Andrews et al., 2008, 2012; Kline et al., 2019b), we present results for different minimum firm size cutoffs between 1 and 100 in columns (1)–(5).

Our main result is that estimated firm-year effects account for between 4.4 log points (19 percent) and 1.9 log points (8 percent) of the total variance of log earnings, with decreasing levels (shares) for higher minimum firm size cutoffs. The covariance terms, primarily due to the covariance between estimated worker effects and firm-year effects, account for between 0.0 log points (0 percent) and 1.8 log points (8 percent) of the total variance of log earnings, with corresponding

correlation ranging from 0.011 to 0.127. Compared to a variance decomposition based on the traditional AKM specification with firm FEs—see Table 6 of Appendix B.2—firm-year effects account for up to 1.2 log points (up to 46 percent) more of the variance in log earnings.

The contribution in levels and shares of the variance of firm-year effects toward the total variance of log earnings is decreasing over the range of very small firm size cutoffs. This is consistent with the presence of limited-mobility bias (Abowd et al., 2004; Andrews et al., 2008, 2012) leading to biased quadratic forms, specifically a downward-biased correlation between worker and firm-year effects (Kline et al., 2019b). Such incidental parameter problems are particularly likely to arise in our firm-year effects model, which features a greater number of parameters compared to the traditional AKM model. Alleviating these concerns, we find that both the level and share of the variance of firm-year effects as well as the correlation between worker and firm-year effects stabilize around a minimum firm size threshold of 10 employees. This gives us confidence that the incidental-parameters problem is less binding and estimation results are reliable for a minimum firm size cutoff of 10 or more employees.

Finally, it is worth noting that the connected set of workers in our firm-year effects model spans between 98 and 100 percent of worker-years, similar to results for the traditional AKM model.

Table 2. Variance decomposition based on levels of firm-year FEs

	(1)	(2)	(3)	(4)	(5)
$Var(y_{ijt})$	0.235	0.230	0.231	0.234	0.235
$Var(\hat{\alpha}_i)$	0.124	0.121	0.125	0.130	0.132
$Var(\hat{\psi}_{jt})$	0.044	0.028	0.022	0.019	0.019
$Var(X_{it}\hat{\beta})$	0.025	0.024	0.022	0.020	0.019
$2 \times \sum Cov(\cdot)$	0.000	0.011	0.016	0.018	0.018
$Var(\hat{\varepsilon}_{ijt})$	0.044	0.046	0.047	0.047	0.047
$Corr(\hat{\alpha}_i, \hat{\psi}_{jt})$	0.011	0.094	0.124	0.129	0.127
Observations	21,145,007	18,425,427	15,091,142	11,313,701	9,392,584
Unique workers	3,056,376	2,801,551	2,437,724	1,959,034	1,685,029
Unique firms	2,134,700	628,190	202,346	51,833	23,761
Largest connected set	98.1%	99.9%	100.0%	100.0%	100.0%
R^2	0.814	0.799	0.798	0.801	0.802
Firm FE type	Firm-year	Firm-year	Firm-year	Firm-year	Firm-year
Income concept	Earnings	Earnings	Earnings	Earnings	Earnings
Minimum firm size	1	5	15	50	100

Note: Variance decomposition is based on earnings equation (2): $y_{ijt} = \alpha_i + \psi_{jt} + \gamma_t + X_{it}\beta + \varepsilon_{ijt}$. The resulting variance decomposition is $Var(y_{ijt}) = Var(\hat{\alpha}_i) + Var(\hat{\psi}_{jt}) + Var(\gamma_t) + Var(X_{it}\hat{\beta}) + 2\sum Cov(\cdot) + Var(\hat{\varepsilon}_{ijt})$. Largest connected set is stated in terms of the fraction of worker-years. Source: LISA, RAMS.

3.4 Comparing firm pay measures

It will be useful to compare estimates of firm-year FEs in our model to alternative firm pay measures. To this end, Figure 2 compares different moments of the distribution of firm-year FEs and firm FEs, respectively, against corresponding firm-level mean earnings in the raw data.

Panel (a) of Figure 2 shows that mean firm FEs and mean firm-year FEs are highly correlated.⁸ Both have a slope with regards to firm-level mean earnings of less than one, indicating that there is positive assortative matching between worker types and firm types that explains some of the dispersion in firm-level mean earnings. Finally, firm-year FEs are significantly more increasing in firm-level mean earnings compared to firm FEs, indicating that yearly variation in firm pay is picked up by the firm-year FEs specification but not by the firm FEs specification.

Panel (b) of Figure 2 shows that there is sizable dispersion in both firm FEs and firm-year FEs conditional on firm-level mean earnings, which is suggestive of heterogeneity in the composition of worker types across firms with similar pay. All three moments—the 10th, 50th, and 90th percentiles—of the conditional firm FEs distribution and the conditional firm-year FEs distribution are essentially monotonically increasing in firm-level mean earnings. Finally, dispersion in firm-year FEs conditional on firm-level mean earnings, relative to that of firm FEs, is slightly higher, particularly in the tails of the distribution of firm-level mean earnings.

Figure 2. Comparison between firm FEs, firm-year FEs, and firm-level mean earnings

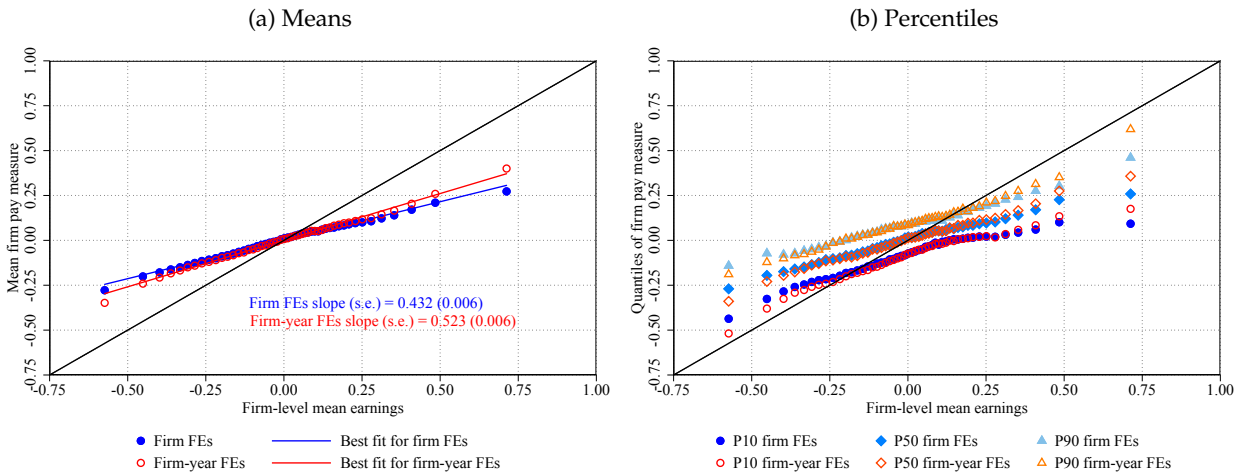

Note: Figure shows binned scatter plots of mean firm pay measures with linear best fit lines (panel (a)) and of various percentiles of the conditional distribution of firm pay measures (panel (b)) as a function of mean firm-level earnings bins. Source: LISA, RAMS.

⁸In a projection of firm FEs on firm-year FEs, we find an estimated slope coefficient of 0.751 and standard error of 0.012—see Figure 16 in Appendix B.4. Conversely, in a projection of firm-year FEs on firm FEs, we find a result similar to that by Lachowska et al. (2019) of an estimated slope coefficient that is indistinguishable from unity, with a point estimate of 1.009 and standard error of 0.005—see Figure 17 in Appendix B.4.

3.5 Determinants of Firm-Year Pay

Why do firms pay differently in the cross section? What leads them to change pay policies over time? To answer these questions, we follow the two-stage methodology in [Alvarez et al. \(2018\)](#) and project estimated firm-year FEs from equation (1) onto observable firm characteristics.⁹ Specifically, we estimate the following worker-weighted second-stage regression for firm j in year t :

$$\widehat{\psi}_{jt} = Z_{jt}\delta + \eta_{jt}, \quad (3)$$

where $\widehat{\psi}_{jt}$ is the estimated first-stage firm-year fixed effect, Z_{jt} is a vector of observable firm characteristics (possibly including a firm-specific constant), and η_{jt} is a firm-level error term.

Determinants of firm pay in the cross section. Figure 3 presents a first glance at the bivariate relationship between our estimated firm-year FEs and key firm financial indicators: value added per worker in panel (a), sales per worker in panel (b), firm size in panel (c), and assets per worker in panel (d). In many theories of the labor market, these firm variables are strongly tied to firm pay. We find a visually strong relationship between each of these characteristics and our estimated firm-year FEs, lending cross-sectional support to the interpretation of ψ_{jt} as a firm pay policy.¹⁰

Building on the second-stage regression in equation (3), we formalize this visual evidence in Table 3, which presents both univariate correlation coefficients including year FEs in column (1) and also multivariate regression coefficients from a regression including all available firm characteristics simultaneously in the same specification in column (2). The univariate results in column (1) show confirm the results of our visual analysis. The multivariate results in column (2) show that among all available firm characteristics, firm-year FEs have the highest estimated elasticity with respect to value added per worker, followed by debt per worker (possibly a proxy for past investments), assets per worker, and sales per worker. The R^2 of the multivariate regression is 0.385, suggesting that a relatively sparse set of firm characteristics explains a substantial fraction of firm-year pay variation.

⁹In Appendix B.3, we conduct the parallel exercise of projecting estimated worker FEs from our augmented AKM equation (1) onto observable worker characteristics.

¹⁰Similar relationships between AKM FEs and firm characteristics have been found in previous work by [Barth et al. \(2016\)](#), [Card et al. \(2016\)](#), and [Alvarez et al. \(2018\)](#).

Figure 3. Second stage results: Estimated firm pay versus firm characteristics

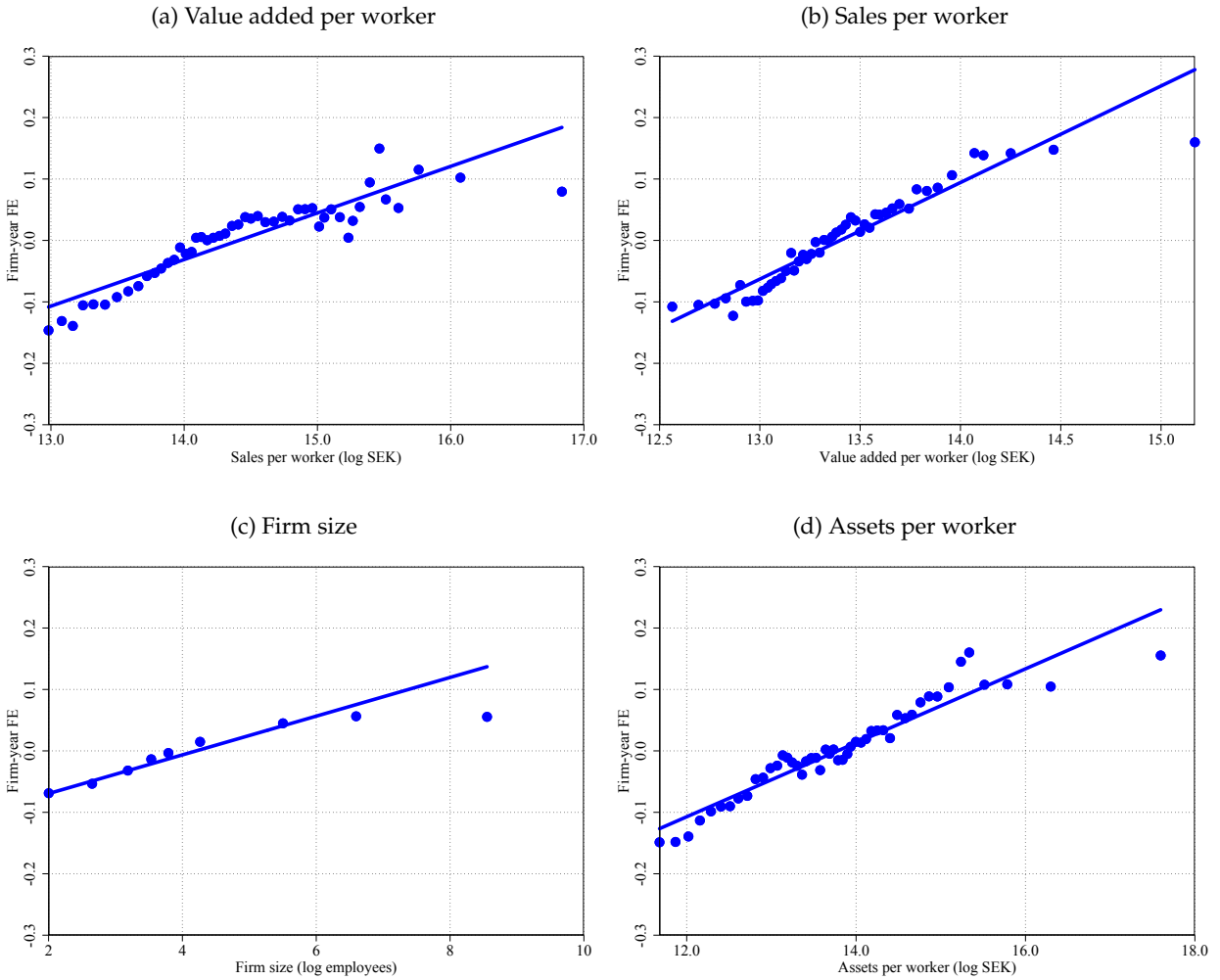

Note: Figure shows binscatter plot with linear best fit lines for firm-year FEs as a function of value added per worker in panel (a), sales per worker in panel (b), firm size in panel (c), and assets per worker in panel (d). Source: LISA, RAMS, FEK.

Table 3. Second stage results: Regression analysis of firm pay versus firm characteristics

	(1)	(2)
	Univariate	Multivariate
Firm size (log employees)	0.023	0.008
Firm age (years)	0.035	-0.002
Sales per worker (log SEK)	0.070	0.013
Value added per worker (log SEK)	0.121	0.056
Assets per worker (log SEK)	0.056	0.014
Debt per worker (log SEK)	0.056	0.018
Equity per worker (log SEK)	0.036	0.004
Investment per worker (log SEK)	0.022	-0.004
Observations	13,865,483	13,865,483
R^2		0.385
Year FE	Yes	Yes

Note: Table shows second-stage regressions based on equation (3). Column (1) shows results of univariate regressions with only one explanatory variable at a time. Column (2) shows results of a multivariate regression that simultaneously includes all firm characteristics. All results are significant at the 1% level. *Source:* LISA, RAMS, FEK.

Determinants of firm pay dynamics. A growing literature has highlighted the role of employers in imperfectly insuring their workers against productivity shocks (Van Reenen, 1996; Guiso et al., 2005; Lemieux et al., 2009; Lamadon, 2016; Friedrich et al., 2019; Kline et al., 2019a). To shed light on the determinants of firm pay dynamics, we use the detailed firm financials data available in the FEK dataset from 2003 onwards. Figure 4 plots the relationship between differences at various lag lengths in value added per worker, sales per worker, firm size, and assets per worker on the horizontal axis against changes in firm pay on the vertical axis.

Evidently, firms that become more productive increase pay, while firms that become less productive leave pay unchanged. The latter may be consistent with real price rigidities (recall that we are using real wages). As the time horizon increases, the pattern becomes more pronounced (and the kink around zero gradually disappears). This pattern would, for instance, be consistent with productivity shocks having a permanent and transitory component, and firms primarily adjusting pay in response to the permanent component. As the time horizon lengthens, more weight is effectively put on the permanent component, which accounts for the more pronounced link between changes in firm pay and productivity.

We also link changes in firm pay to changes in other firm observables. As for productivity, firms that receive positive shocks to sales per worker or assets per worker increase pay, with the

patterns again becoming more pronounced as the time horizon rises. The comovement of firm pay and size, however, is not particularly pronounced. The fact that firm pay dynamics are related to firm productivity dynamics suggests that the mean reversion observed in Figure 4 is not just the result of measurement error in the firm component of pay, but reflects a more fundamental link between firm performance and pay.

Figure 4. Change in firm pay versus change in other firm observables

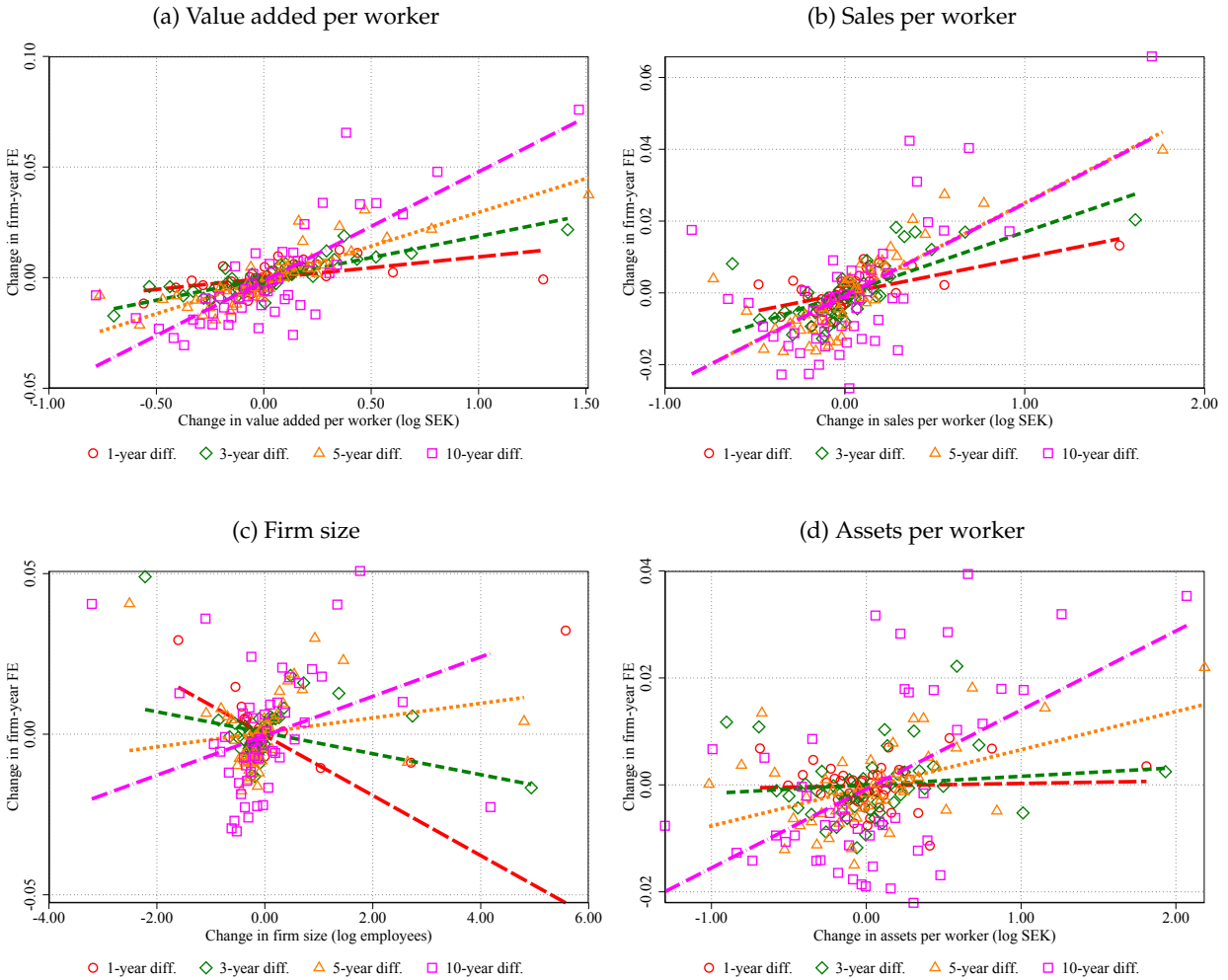

Note: Figure shows binned scatter plot with linear best fit lines for differenced firm-year FEs as a function of value added per worker in panel (a), sales per worker in panel (b), firm size in panel (c), and assets per worker in panel (d). Differences are taken at lag lengths of 1 year (red circles), 3 years (green diamonds), 5 years (orange triangles), and 10 years (pink squares). *Source:* LISA, RAMS, FEK.

4 Firm Pay Dynamics

In this section, we empirically study the nature of firm pay dynamics. Specifically, we investigate the firm pay distribution over time, the distribution of changes in firm pay, firm pay mobility, and ex-ante versus ex-post firm pay heterogeneity. To analyze firm pay dynamics, unless noted otherwise, we focus on an unbalanced and employment-weighted panel of firms that fall above a minimum firm size threshold of 10 employees, consistent with our preferred firm-year FEs specification from Section 3.3.

4.1 Firm Pay Distribution over Time

We document significant between-firm pay differences initially and an increase therein over time for Sweden between 1986 and 2015. Figure 5 plots the evolution of various percentiles of the firm-level mean earnings distribution. Panel (a) shows percentile levels, with differences in average firm-level pay of 64 log points between the P95 and the P5 of the firm pay distribution in 1986. Turning to the normalized percentile evolution in panel (b), there has been a substantial increase in the dispersion of firm-year FEs over time, with the P95 growing by 15 log points but the P5 declining by 9 log points.

Figure 5. Evolution of firm-level mean earnings, 1986–2015

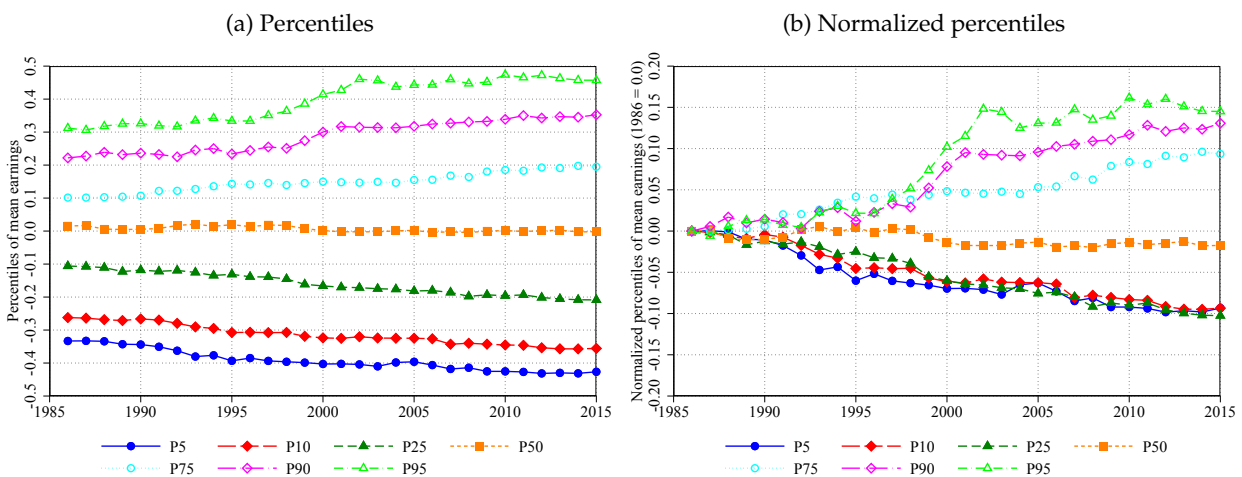

Note: Figure shows various percentiles of the distribution of firm-level mean log earnings in levels (panel (a)) and relative to the year 1986 (panel (b)) for an unbalanced and employment-weighted panel of firms. Source: LISA, RAMS.

How much of the observed divergence in the firm-level mean earnings distribution is accounted for by changes in firm pay policies, as opposed to changes in worker composition? Figure

6 plots the evolution of various percentiles of the firm-year FE distribution. Initial dispersion in firm-year FEs is lower than that of raw firm-level mean earnings, indicating that high paid workers tend to work for high paying firms. Moreover, the dispersion of firm-year FEs increases rapidly between 1986 and 2015, driven by the top of the firm pay distribution. For example, the P95 grows by 12 log points but the P5 declines by 6 log points over the period 1986–2015.

Figure 6. Evolution of firm-year FEs, 1986–2015

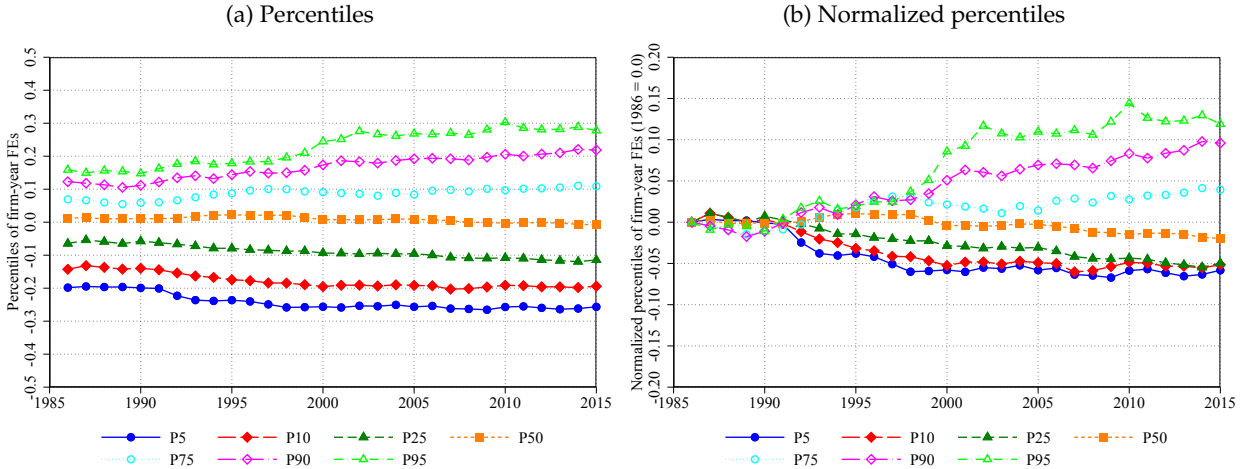

Note: Figure shows various percentiles of the distribution of firm-year FEs in levels (panel (a)) and relative to the year 1986 (panel (b)) for an unbalanced and employment-weighted panel of firms. Source: LISA, RAMS.

To show that this trend is not driven purely by worker reallocation and firm selection, Appendix C.1 repeats the same graph for an unbalanced and unweighted panel (i.e., controlling for worker reallocation, see Figure 18), for a balanced and weighted panel (i.e., controlling for firm selection, see Figure 19), and for a balanced and unweighted panel (i.e., controlling for both the allocation of workers and firm selection, see Figure 20), respectively. While worker reallocation and firm selection play an important role, there have been significant changes in firm pay policies behind the trends documented in Figures 5 and 6. To see this, note that even the balanced and unweighted panel of firm pay (Figure 20) shows a strong divergence of firm pay over time, with the P95 growing by 11 log points but the P5 declining by 2 log points over the period 1986–2015.

We conclude that firm pay policies are important for understanding between-firm pay differences, that firm pay dynamics are important for understanding the evolution of earnings inequality in Sweden over the last three decades, and that incumbent firm pay dynamics are a significant driver behind these trends.

4.2 Distribution of Within-Firm Differences in Firm Pay

To illustrate that firm pay changes importantly within firms over time, Figure 7 shows the distribution of within-firm differences in firm-year FEs at various lag lengths between 1 and 25 years for a balanced and employment-weighted panel of firms.¹¹

The density of 1-year differences in firm-year FEs is centered just below zero (mean of -0.013), is very concentrated (variance of 0.002), has a relatively thicker right tail (skewness of 1.244), and has thick tails (kurtosis of 37.503).¹² At higher lag lengths, we observe a significantly higher mean, lower skewness, and lower kurtosis of the distribution of differences in firm-year FEs relative to that for shorter lag lengths. For example, for a 25-year lag, firms on average increase their pay by 5.9 log points, with associated variance of 0.025, skewness of 0.312, and kurtosis of 4.830.¹³

Figure 7. Distribution of firm-year FE differences at various lag lengths

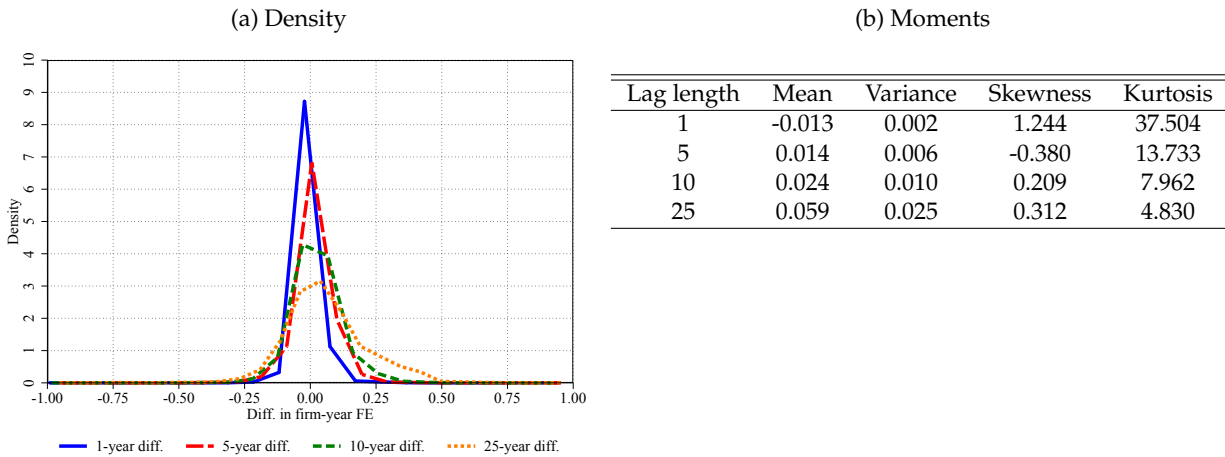

Note: Figure shows nonparametric Epanechnikov kernel density estimates of the distribution of the within-firm changes in firm-year FEs at various lag lengths in panel (a) and moments of the distribution at various lag lengths in panel (b). Source: LISA, RAMS.

These findings suggest that there are both transitory and permanent parts to a firm's pay policy. On one hand, if firm pay was perfectly persistent, we would see a degenerate distribution of differences in firm-year FEs at all lag lengths. On the other hand, if firm pay was perfectly transitory or due to iid measurement error, the distribution of differences in firm-year FEs would be invariant to the lag length. In contrast, our findings indicate that, over time, incumbent firms

¹¹Using a balanced panel for differences at various lag lengths allows us to control for firm selection. For this exercise, we construct weights as the average employment of a given firm between two periods.

¹²We remind the reader that we de-meaned firm-year fixed effects at the population level every year and that here we study a subsample of firms in a balanced panel. Therefore, negative mean firm-year pay differences in the balanced panel do not necessarily reflect negative raw earnings growth.

¹³Large positive long-run differences in firm-year pay can be reconciled with negative short-run differences in firm-year pay by reallocation of workers between firms with declining versus increasing pay.

change their pay more positively with greater variance but lower skewness and kurtosis to the firm pay differences.

The use of firm-year FEs paints a picture that is slightly different in interesting ways compared to just looking at raw firm-level mean earnings. To put our results in context and highlight the value of our methodology, Figure 21 in Appendix C.2 shows the same statistics without controlling for changes in worker composition based on unobservable worker characteristics. Compared to the raw measure of firm-level mean earnings, our firm-year FE methodology reveals that mean changes in firm pay policies are more negative, less dispersed, less (more) positively skewed at shorter (longer) lag lengths, and of lower (higher) kurtosis at shorter (longer) lag lengths.

4.3 Firm Pay Mobility

The transitory versus permanent aspects of firm pay are intimately related to the concept of income mobility (Shorrocks, 1978; Kopczuk et al., 2010; Black and Devereux, 2011). Conceptually, the degree of mobility in firm pay relates the cross-sectional distribution of firm pay (“short-run inequality”) to the distribution of period-average firm pay (“long-run inequality”). In a world with zero mobility, firms have a constant pay policy, as estimated in the classical AKM framework. In contrast, in a world with full mobility each firm’s current pay policy is independent of its future pay policies.

To illustrate the empirical degree of firm pay mobility, Figure 8 plots the mean future firm-year FE as a function of the current firm-year FE quantile for a balanced and unweighted panel of firms.¹⁴ Panel (a) plots a firm’s current firm-year FE in some year t on the horizontal axis against its average firm-year FE in year $t + \tau$ on the vertical axis, for $\tau = 1, 5, 10, 25$. There is clear mean reversion in firm pay levels. Firm pay on average increases among currently low-paying firms, while it decreases among currently high-paying firms. Moreover, currently low-paying (high-paying) firms are increasingly less likely to remain low-paying (high-paying) over increasing time horizons. The magnitude of mean reversion is economically significant. The currently lowest-paying firms on average increase their pay by 5, 10, 14, and 20 log points over the subsequent 1, 5, 10, and 25 years. The currently highest-paying firms on average decrease their pay by 12, 18, 23, and 35 log points over the subsequent 1, 5, 10, and 25 years.

¹⁴Using a balanced and unweighted panel facilitates interpretation of these graphs. For unbalanced panels, mean future pay ranks need not equal the mean due to firm entry and exit over time. For weighted panels, worker mobility by itself could drive a wedge between future and current firm pay ranks.

Panel (b) of Figure 8 plots a firm's current rank in the firm-year FE distribution in some year t on the horizontal axis against its average rank in the analogous distribution in year $t + \tau$ on the vertical axis, for $\tau = 1, 5, 10, 25$. If firm pay were fixed over time, as is assumed in the classical AKM framework, all colored lines would collapse to the 45-degree line. Instead, we clearly see firms that are currently below the 55th percentile of the firm pay ladder on average gain ranks, while firms that are currently above that percentile on average lose ranks. Moreover, this pattern becomes more pronounced with the lag length. Firms ranked near the bottom of the current firm pay distribution on average gain around 4, 9, 12, and 22 percentile ranks in a time span of 1, 5, 10, and 25 years. Firms ranked near the top of the current firm pay distribution on average lose around 8, 14, 19, and 35 percentile ranks in a time span of 1, 5, 10, and 25 years.

Figure 8. Mean mobility in firm-year FEs

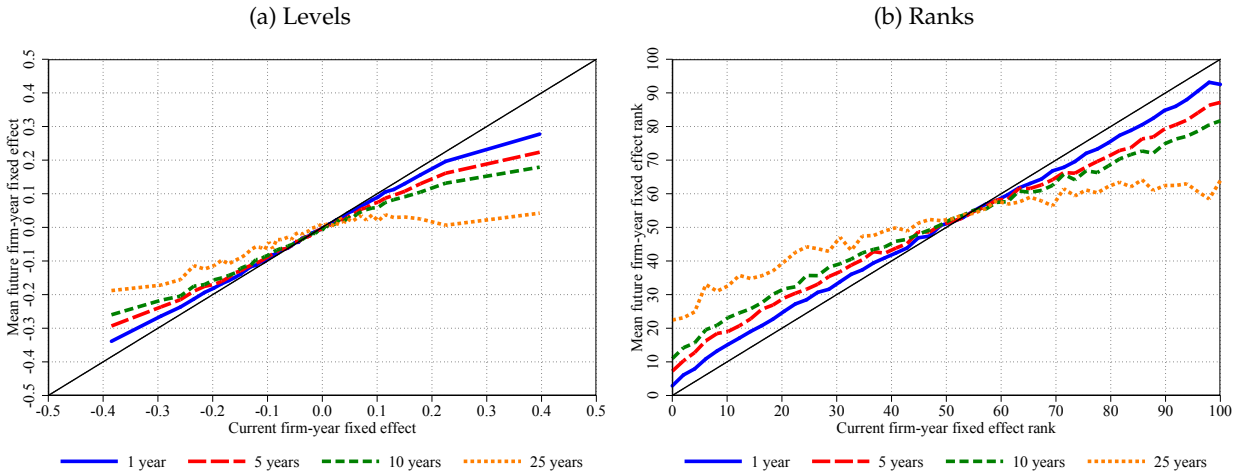

Note: Figure shows the mean future level (panel (a)) and percentile ranks (panel (b)) of firm-year FEs conditional on the current firm-year fixed effect at various lag lengths. Source: LISA, RAMS.

Firm pay mobility is not a uniform phenomenon. Instead, similarly ranked firms experience different mobility patterns. Figure 9 plots various percentiles of the distribution of firm pay levels and ranks after 1 year (panels (a)–(b)), 5 years (panels (c)–(d)), 10 years (panels (e)–(f)), and 25 years (panels (g)–(h)) conditional on current firm pay rank. Several points are worth noting. First, median mobility in levels and ranks is close to zero at short time horizons, but significant, especially in the tails of the distribution, at longer horizons. Second, there is significant dispersion in future firm pay levels and ranks conditional on current firm pay at all lag lengths, as measured by the P90-P10 differential of the conditional distribution of future ranks. Third, this dispersion in future firm pay levels and ranks increases with the time horizon.

Figure 9. Percentiles of mobility in firm-year FEs

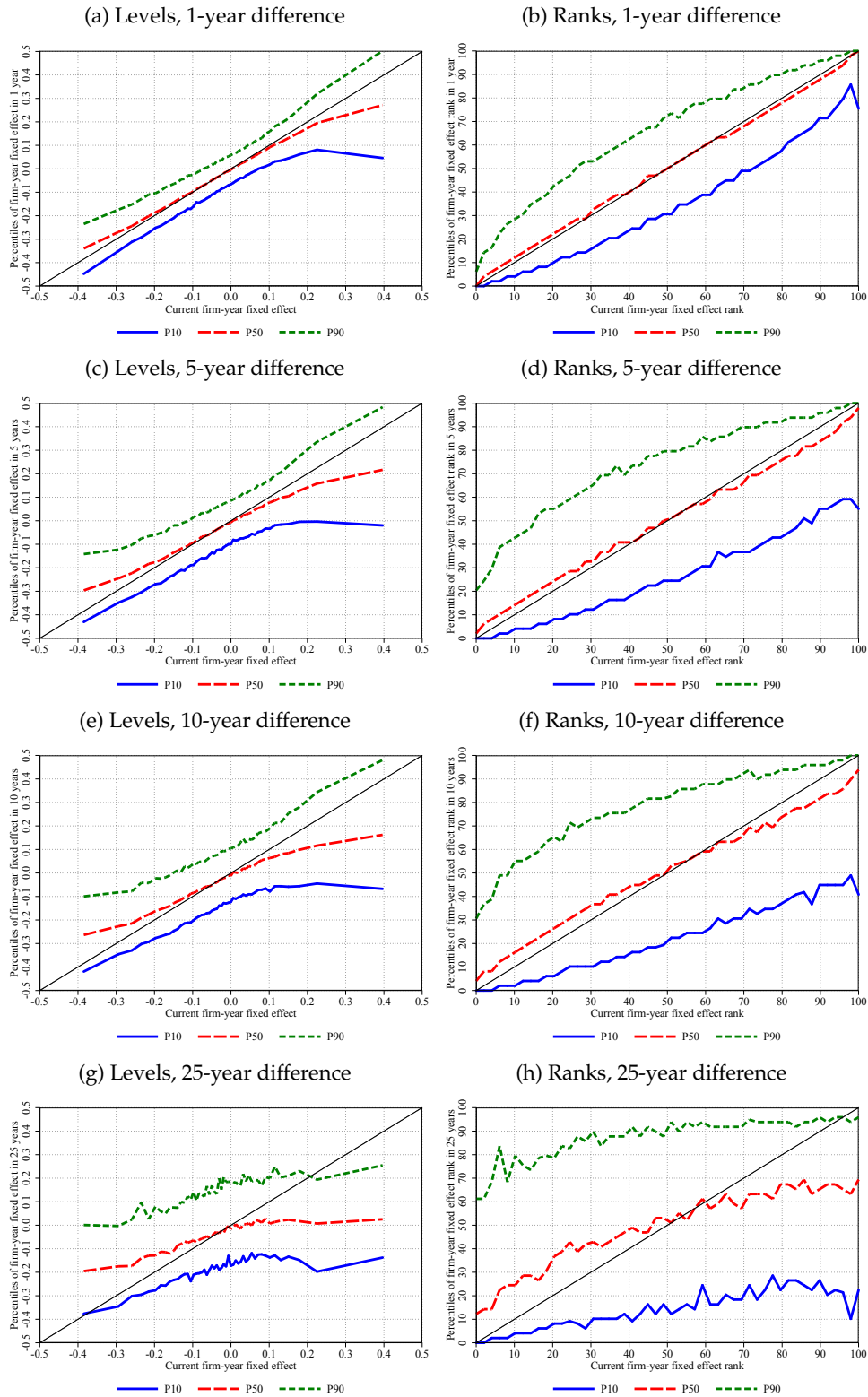

Note: Figure shows various percentiles of future levels (panels (a), (c), (e), and (g)) and percentile ranks (panels (b), (d), (f), and (h)) of the firm-level mean earnings distribution conditional on the current firm-year fixed effect at various lag lengths. Source: LISA, RAMS.

A direct and intuitive summary index of firm pay mobility is the rank correlation in firm-year FEs from some year t to some future year $t + \tau$, which is a statistic commonly used in other contexts (Bourguignon et al., 1991; Kopczuk et al., 2010; Chetty et al., 2014). Table 4 shows the empirical rank correlations in firm-year FEs for $\tau = 1, 5, 10, 25$ for unbalanced versus balanced and unweighted versus weighted firm panels. The rank correlation at a lag length of 1 year ranges from 0.834 to 0.930. To provide some context, these numbers are comparable to Kopczuk et al. (2010)'s estimates of 1-year rank correlations of around 0.900 in individual earnings in U.S. Social Security data from 1986 to 2003. Balanced and weighted rank correlation tend to be higher than the unbalanced and unweighted ones, indicating more stability in pay among large incumbent firms. The rank correlation declines to 0.717–0.828 at a lag length of 5 years, to 0.627–0.731 at a lag length of 10 years, and to 0.346–0.376 at a lag length of 25 years. Again, to put these numbers into context, Kopczuk et al. (2010) report comparable 20-year rank correlations of around 0.494 in individual earnings in the U.S. from 1978 to 1998.¹⁵

Table 4. Rank correlations for firm-year FEs at various lag lengths

Lag length	Unbalanced		Balanced	
	Unweighted	Weighted	Unweighted	Weighted
1	0.834	0.885	0.878	0.930
5	0.717	0.792	0.757	0.828
10	0.627	0.708	0.660	0.731
25	0.355	0.346	0.376	0.367

Note: Table shows rank correlations for firm-year FEs at various lag lengths for unbalanced vs. balanced, and unweighted vs. weighted panels of firms. *Source:* LISA, RAMS.

To highlight the value added of our firm-year FE methodology, we repeat our mobility exercises using raw data on firm-level mean earnings, the results of which are shown in Figures 22–23 of Appendix C.3. Relative to what the unadjusted raw data suggests, we find greater degrees of mobility in firm pay using our firm-year FE methodology. Furthermore, the additional mobility picked up by our firm-year FE estimates is unlikely to be attributable solely to measurement error since the increase in mobility going from 1-year to 25-year lag lengths is significantly larger than

¹⁵We also compute the Shorrocks mobility index (Shorrocks, 1978) based on the variance of firm-year FEs over the period 1986–2015 to be 0.396. The Shorrocks mobility index, M , is defined as

$$M = 1 - \frac{\text{Var}_{jt}(\bar{\hat{\psi}}_j)}{\sum_{t=1}^T \text{Var}_j(\hat{\psi}_{jt}) / T} : \quad \bar{\hat{\psi}}_j \equiv \sum_{t=1}^T \hat{\psi}_{jt} / T$$

We borrow this definition from Kopczuk et al. (2010) who do not compute the Shorrocks mobility index over individual earnings for periods longer than five years or based on the variance of logs using U.S. Social Security data.

that in the raw data.

4.4 Ex-Ante versus Ex-Post Firm Pay Heterogeneity

In light of the above evidence on firm pay mobility, a natural question is to what extent higher paying firms are born so versus become so over time? To the extent that some firms are high paying already from the start, what accounts for this initial pay heterogeneity? To the extent that some firms become high paying over time, what accounts for these pay dynamics?

A long literature on individual income dynamics (MaCurdy, 1982; Abowd and Card, 1989; Guvenen, 2009; Guvenen and Smith, 2014), recently also applied to firm size dynamics (Sterk et al., 2018), demonstrates that the autocovariance structure of earnings (firm size) contains important information about the nature of ex-ante heterogeneity versus ex-post shocks facing individuals (firms). We adapt this framework to understand the nature of firm pay dynamics.

Firm pay heterogeneity at firm entry. A firm's capacity or willingness to pay its workers may be correlated with firm age, for example due to firm life-cycle changes in credit constraints, productivity, and market power. Furthermore, the distribution of firm pay may not just shift uniformly over firm age but instead change shape due to ex-post heterogeneity affecting some firms more than others. To understand the relative importance of ex-ante versus ex-post heterogeneity, we first investigate the distribution of pay at newly established firms.¹⁶

Figure 10 compares the distribution of pay at newly established firms to that of all firms in the economy. Panel (a) compares estimated firm-year FEs between the two groups. It is visually evident that new firms have lower mean pay, more mass in the left tail of the distribution, and less mass in the middle of the distribution relative to all firms in the economy. Panel (b) makes clear that new firms have excess mass in the lower 30 percentiles and lack mass particularly between the 50th and 80th percentiles of the economy-wide distribution of firm pay.¹⁷

¹⁶Since new firms tend to be small (Haltiwanger et al., 2013), for robustness we repeated all exercises in this section without any minimum firm size threshold. The results without any minimum firm size threshold, shown in Figures 24–28 in Appendix C.4 are qualitatively very similar.

¹⁷Figure 25 in Appendix C.4 further splits the group of "all firms" into different age groups. It shows that most of the differences in the firm pay distribution are between new firms and those age 5 and above.

Figure 10. Distribution of firm-year FEs at new firms versus all firms

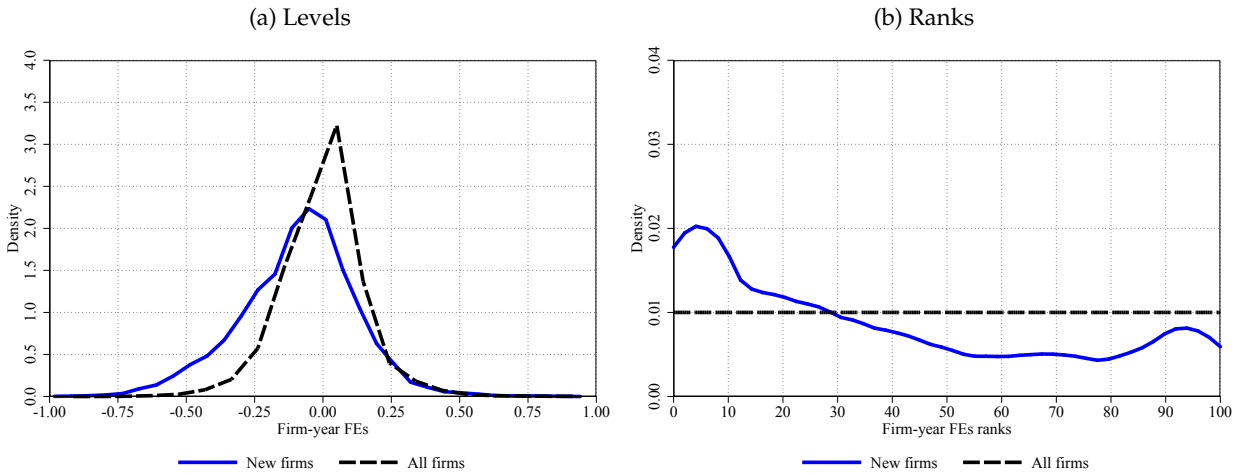

Note: Figure shows nonparametric Epanechnikov kernel density estimates of the distribution of firm-year FEs for new firms compared to all firms (a) and the distribution of firm-year FE population ranks for new firms compared to all firms (b). Source: LISA, RAMS.

Figure 11 compares the firm pay distributions of different firm cohorts. While new firms are on average lower paying than all firms (as demonstrated by Figure 10), panel (a) shows significant variation between cohorts in their initial pay. Overall, between 1990 and 2015, new firm cohorts have seen declining average firm pay but an increase in the variance and skewness of firm pay. Panel (b) shows that between 1990 and 2015 there has been a marked increase in mass of firm pay in the lower 20 percentiles and a decrease in mass above the median, measured in relation to the population of all firms.

Figure 11. Distribution of firm-year FEs by firm cohort

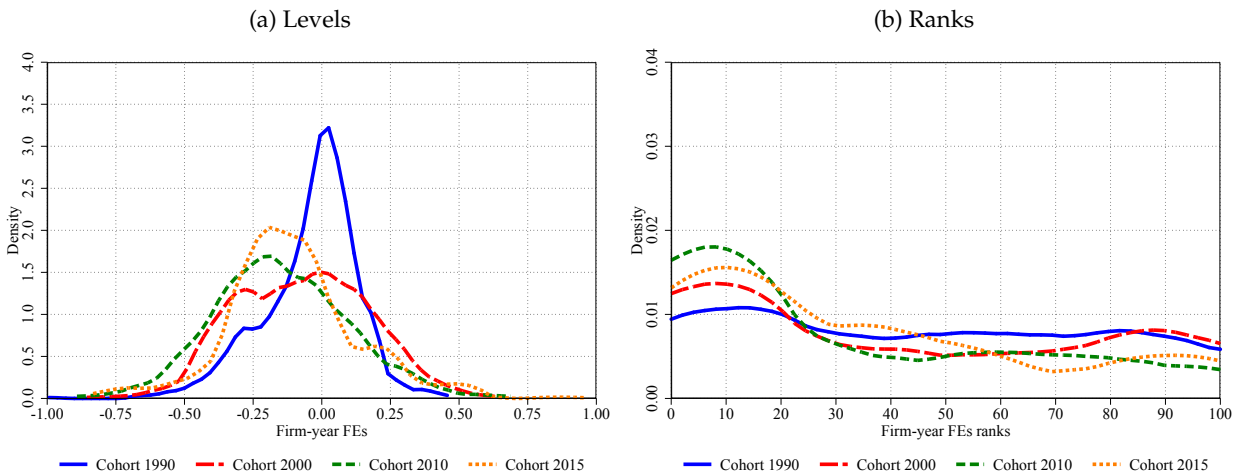

Note: Figure shows nonparametric Epanechnikov kernel density estimates of the distribution of firm-year FEs for new firms from various cohorts (a) and the distribution of firm-year FE population ranks for new firms from various cohorts (b). Source: LISA, RAMS.

Next, we filter average firm-year FEs among new firms at business-cycle frequency, and show their cyclical component relative to three business cycle indicators in Figure 12.¹⁸ It is important to note that since firm-year fixed effects are already de-measured every year, any fluctuations in mean pay of new firms reflect excess volatility of new firms relative to the population of all firms in a given year. Panel (a) shows a correlation of 0.355 between the cyclical component of firm-year pay and that of the composite of the unemployment rate between 1986–2015. Put differently, mean pay at new firms is procyclical (or, rather, more procyclical than economy-wide mean firm pay), that is, higher during economic expansions than during contractions (again, relative to economy-wide firm pay). Panels (b) and (c) of the same figure also show a positive correlation between mean pay at new firms and two other business cycle indicators, namely the cyclical component of real GDP (panel (b), correlation of 0.193) and that of real GDP per capita (panel (c), correlation of 0.181).

Statistical model. To jointly study the relative contributions of ex-ante and ex-post heterogeneity towards firm pay differences, we leverage an insight from a long literature on individual income dynamics (MaCurdy, 1982; Abowd and Card, 1989; Guvenen, 2009; Guvenen and Smith, 2014), recently also applied to firm size dynamics (Sterk et al., 2018), in inspecting the autocorrelation function of firm pay. Specifically, we treat our estimates of firm-year FEs as data on which we estimate the following statistical model for ψ_{jt} :

$$\psi_{jt} = \zeta_j + u_{jt} + \varepsilon_{jt} \quad (4)$$

The first term, ζ_j , in equation (4) is a permanent component that captures permanent differences in pay across firms and drawn at time of inception of the firm from some distribution with finite mean μ and variance σ_ζ^2 :

$$\zeta_j \sim iid \left(\mu, \sigma_\zeta^2 \right) \quad (5)$$

The second term, u_{jt} , is a persistent firm pay component, which follows a first-order autore-

¹⁸To extract business-cycle frequency statistics, we use the HP filter with smoothing parameter $\lambda = 6.25$, as recommended by Ravn and Uhlig (2002).

Figure 12. HP-filtered cyclical components of mean firm-year FE of new cohort

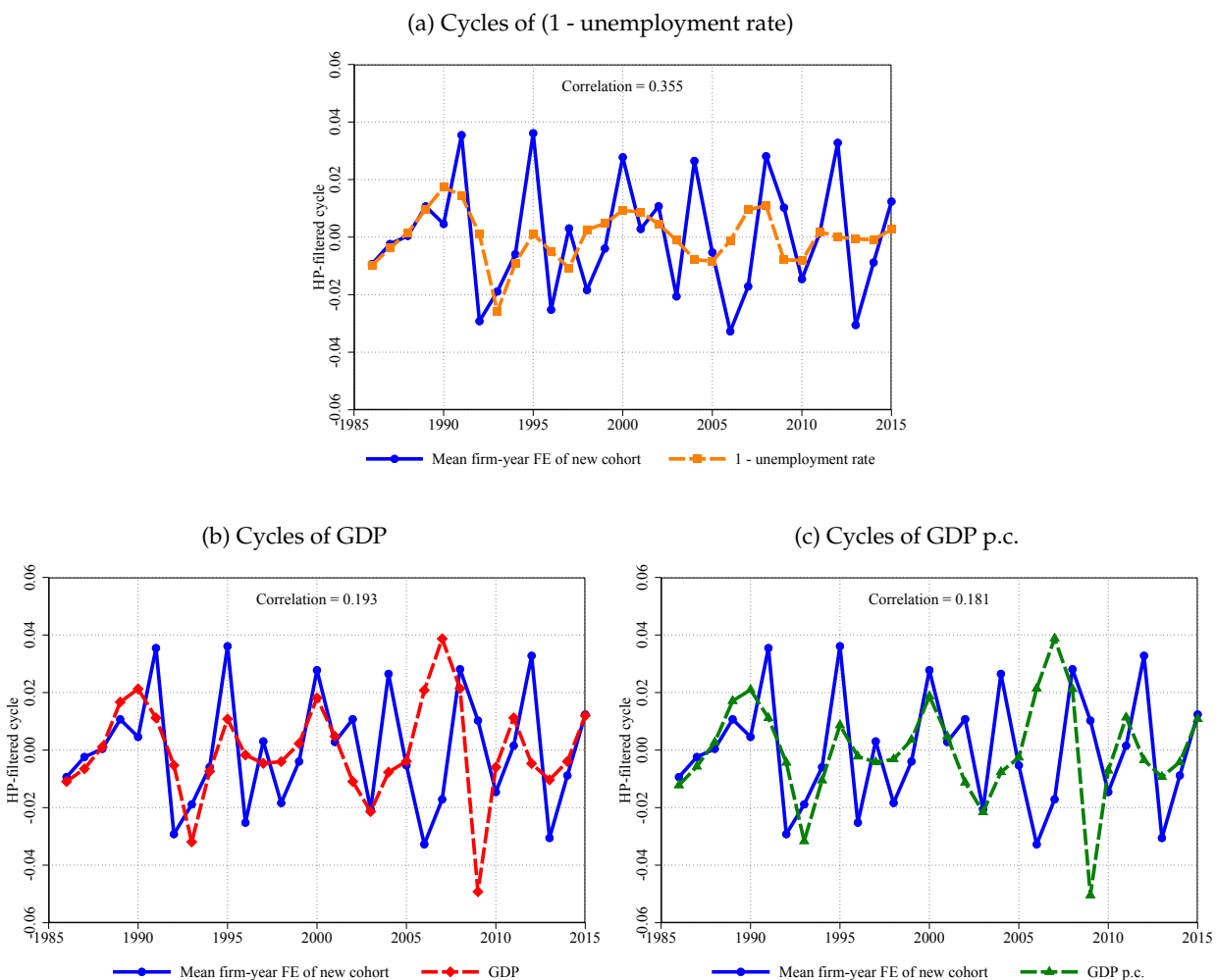

Note: Mean firm-year FE is relative to population of all firms, which is mean zero in each year. Cyclical components are extracted from the annual time series using an HP filter with smoothing parameter $\lambda = 6.25$, as recommended by Ravn and Uhlig (2002). Source: LISA, RAMS, IMF WEO.

gressive process with autocorrelation $\rho \in (0, 1)$ and finite variance of iid innovations, σ_v^2 :

$$u_{jt} = \rho u_{jt-1} + v_{jt}, \quad v_{jt} \sim iid(0, \sigma_v^2) \quad (6)$$

The third term, ε_{jt} , is a purely transitory firm pay component, which is iid with normalized mean zero and finite variance σ_ε^2 :

$$\varepsilon_{jt} \sim iid(0, \sigma_\varepsilon^2) \quad (7)$$

Given this assumed structure for firm pay dynamics, the autocovariance matrix provides useful information to identify the underlying parameters of the statistical model. In particular, the autocovariance of firm pay between firm age a and firm age $a + t$, that is at lag length $t \geq 0$, is summarized by the following autocovariance function:¹⁹

$$\mathbb{C}(a, a + t) \equiv Cov(\psi_{ja}, \psi_{ja+t}) = \sigma_\xi^2 + \rho^t \sum_{i=0}^a \rho^{2i} \sigma_v^2 + \mathbf{1}[t = 0] \sigma_\varepsilon^2, \quad (8)$$

where $\mathbf{1}[t = 0]$ is an indicator function for the lag length t being zero. Hence, the covariances can be expressed as the function of four objects: the variance of the permanent component, σ_ξ^2 , the variance of innovations to the persistent component, σ_v^2 , the autocorrelation of the persistent component, ρ , and the variance of the temporary component, σ_ε^2 . Provided a set of at least four autocovariances, one would hence in general expect to be able to recover the underlying parameters. We do so by method of moments estimation.

Figure 13 summarizes the autocovariance structure of firm pay.²⁰ The top left panel plots the standard deviation of firm pay for firms between age 1 and age 19, while the right panel graphs the autocorrelation of firm pay. In particular, the line labeled a graphs the autocorrelation between the firm-year FE at age a , $\hat{\psi}_{ja}$, and that h years later, $\hat{\psi}_{ja+h}$, for a set of initial ages $a = 1, 2, \dots, 10$. The bottom two panels repeat the exercise for a balanced panel of firms. Firm selection contributes to modest compression in firm pay dispersion as firms age. To a first-order, however, dispersion in firm pay does not change much with firm age. Three observations are noteworthy with respect

¹⁹This can be seen by substituting backwards to write firm pay at time $a + t$ as the discounted sum of past innovations.

²⁰Although differing in their setting and methodology, our estimated autocorrelations (autocovariances) are comparable to those in Lachowska et al. (2019) using wage data from the US state of Washington and the leave-one-out estimator developed by Kline et al. (2019b).

to the autocorrelation. First, it falls rapidly between year a and year $a + 1$, suggesting that the firm component of pay has a transitory component. Second, it continues to decline as the time horizon widens, although at a slower pace, consistent with the effects of a persistent component gradually dissipating. Third, it appears to level off at a strictly positive value, indicating the presence of a permanent component. That is, some firms consistently pay more.

Figure 13. Standard deviation and autocorrelation of firm pay, unbalanced & balanced panels

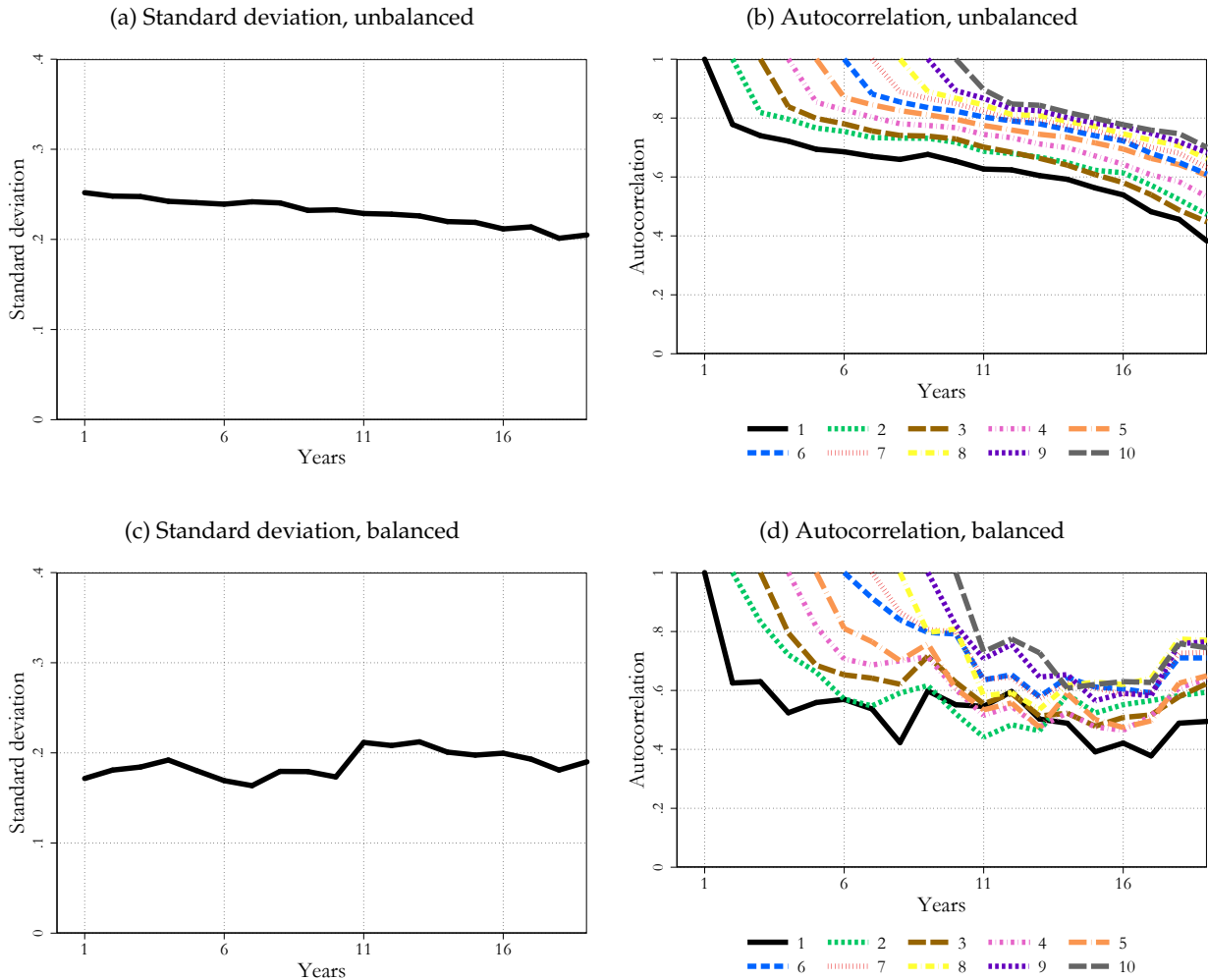

Note: Figure shows estimates of the standard deviation (panels (a) and (c)) and the autocorrelation function (panels (b) and (d)) at various lag lengths and for various birth firm cohorts, both for an unbalanced worker-weighted panel of firms (panels (a) and (b)) and for an unbalanced worker-weighted panel of firms (panels (c) and (d)). *Source:* LISA, RAMS.

The left panel of Table 5 presents the estimated values for the statistical process in equation (4) based on the autocovariance structure of firm pay for the balanced (unbalanced) panel.²¹ The

²¹Figure 29 in Appendix C.4 suggests that the estimated parameters in Table 5 are globally well-identified. In particular, the criterion minimum distance function is steep around its minimum in all four cases, although particularly so for the standard deviation of the permanent component and the autocorrelation and somewhat less so for the standard deviation of the idiosyncratic component.

standard deviation of the permanent component equals 0.118 (0.181), confirming the intuition based on Figure 13 that permanent heterogeneity across firms plays an important role behind cross-sectional dispersion in firm pay. The standard deviation of innovations to the persistent component equals 0.054 (0.095) and the autocorrelation is 0.914 (0.669). These estimates imply that as a cohort of firms ages, the cross-sectional dispersion of the persistent component limits to $\sigma_v^2 / (1 - \rho^2) = 0.018$ (0.016). Hence, while the balanced and unbalanced panels differ in terms of the estimated persistence of the persistent component, they provide a similar answer in terms of the relative importance of the persistent component in the long-run. Finally, the variance of the fully transitory component is 0.08 (0.06).

Table 5. Parameter estimates of statistical process for firm pay

	Parameter estimates				Share of long-run variance		
	ρ	σ_ξ	σ_v	σ_ε	Permanent	Persistent	Transitory
balanced	0.914	0.118	0.054	0.084	0.360	0.458	0.182
unbalanced	0.669	0.181	0.095	0.060	0.622	0.310	0.068

Note: Table shows parameter estimates of the statistical model in equations (4)–(7) for an unbalanced and balanced employment-weighted panel of firms. *Source:* LISA, RAMS.

We are now ready to quantify the contribution of permanent, persistent, and transitory heterogeneity towards empirical firm pay dispersion. To this end, we take the limit of the autocovariance function in equation (8) for $t = 0$ as $a \rightarrow \infty$ to obtain an expression for the asymptotic variance of firm pay:

$$\lim_{a \rightarrow \infty} \mathbf{C}(a, a) = \lim_{a \rightarrow \infty} \text{Var}(\psi_{ja}) = \sigma_\xi^2 + \frac{\sigma_v^2}{1 - \rho^2} + \sigma_\varepsilon^2 \quad (9)$$

Combining equation (9) with the parameter estimates in Table 5, we find that in a balanced (unbalanced) panel of old firms, permanent heterogeneity accounts for approximately 36 (62) percent of the overall cross-sectional variance of firm pay, persistent heterogeneity accounts for around 46 (31) percent, and transitory heterogeneity accounts for 18 (7) percent.

We conclude that—in contrast to the classical AKM framework, which assumes that firm pay policies are fixed—between one third and two thirds of firm pay heterogeneity are permanent, with persistent and transitory fluctuations in firm pay explaining the remainder.

5 Conclusion

A key assumption shared by a large literature building on the seminal work by AKM is that firm pay policies are fixed. In contrast, we propose and estimate an empirical model that accounts for idiosyncratically time-varying firm pay policies. We validate our approach by showing that firm-year pay variation is systematically related to firm financial performance.

Moving from time-invariant to time-varying firm pay policies represents an important paradigm shift. Our approach sheds new light on the drivers of increasing dispersion in firm pay in Sweden, a trend similar to that recently highlighted in other countries (Card et al., 2013b; Song et al., 2018). We find that a substantial part of the increase over time is due to changing pay at incumbent firms rather than purely driven by firm turnover. Furthermore, since firm pay is mean-reverting, cross-sectional variance estimates on short panels tend to overestimate long-run inequality in firm pay. We show that pay at newly established firms, relative to the population of all firms, is procyclical. Finally, we estimate that between one third and two thirds of the long-run cross-sectional firm pay dispersion is due to permanent firm heterogeneity.

Overall, our empirical findings suggest that dynamic firm heterogeneity is important for understanding the anatomy of pay differences across workers in the labor market. Future work, especially theoretical models of worker and firm heterogeneity in the labor market, should be consistent with these empirical findings. An interesting avenue for future research will be to explore the implications of our empirical findings for equilibrium worker mobility decisions, for understanding the structural sources of firm pay dynamics, and for designing social insurance policies.

References

- Abowd, John M. and David Card, "On the Covariance Structure of Earnings and Hours Changes," *Econometrica*, March 1989, 57 (2), 411–445.
- , Francis Kramarz, and David N. Margolis, "High Wage Workers and High Wage Firms," *Econometrica*, 1999, 67 (2), 251–333.
- , –, Paul Lengermann, and Sébastien Pérez-Duarte, "Are Good Workers Employed by Good Firms? A Test of a Simple Assortative Matching Model for France and the United States," *Working Paper*, 2004.
- , Hampton Finer, and Francis Kramarz, "Individual and Firm Heterogeneity in Compensation: An Analysis of Matched Longitudinal Employer-Employee Data for the State of Washington," in John C. Haltiwanger, Julia I. Lane, James R. Spletzer, Jules J.M. Theeuwes, and Kenneth R. Troske, eds., *The Creation and Analysis of Employer-Employee Matched Data*, Amsterdam: North Holland, 1999, pp. 3–24.

- , **Robert H. Creecy**, and **Francis Kramarz**, “Computing Person and Firm Effects Using Linked Longitudinal Employer-Employee Data,” Technical Report, Center for Economic Studies, US Census Bureau 2002.
- Alvarez, Jorge, Felipe Benguria, Niklas Engbom, and Christian Moser**, “Firms and the Decline in Earnings Inequality in Brazil,” *American Economic Journal: Macroeconomics*, 2018, 10 (1), 149–89.
- Andrews, Martyn J., Leonard Gill, Thorsten Schank, and Richard Upward**, “High Wage Workers and Low Wage Firms: Negative Assortative Matching or Limited Mobility Bias?,” *Journal of the Royal Statistical Society: Series A (Statistics in Society)*, 2008, 171 (3), 673–697.
- , – , – , and – , “High Wage Workers Match with High Wage Firms: Clear Evidence of the Effects of Limited Mobility Bias,” *Economics Letters*, 2012, 117 (3), 824–827.
- Babina, Tania, Wenting Ma, Christian Moser, Paige Ouimet, and Rebecca Zarutskie**, “Pay, Employment, and Dynamics of Young Firms,” *Federal Reserve Bank of Minneapolis, Opportunity and Inclusive Growth Institute Working Paper*, 2019, 21.
- Bagger, Jesper and Rasmus Lentz**, “An Empirical Model of Wage Dispersion with Sorting,” *The Review of Economic Studies*, 2018, 86 (1), 153–190.
- Barth, Erling, Alex Bryson, James C. Davis, and Richard Freeman**, “It’s Where You Work: Increases in the Dispersion of Earnings Across Establishments and Individuals in the United States,” *Journal of Labor Economics*, 2016, 34 (S2), S67–S97.
- Bilal, Adrien, Niklas Engbom, Simon Mongey, and Giovanni L. Violante**, “Firm and Worker Dynamics in a Frictional Labor Market,” Working Paper, Princeton University 2019.
- Black, Sandra E. and Paul J. Devereux**, “Recent Developments in Intergenerational Mobility,” in O. Ashenfelter and D. Card, eds., *Handbook of Labor Economics*, Vol. 4 of *Handbook of Labor Economics*, Elsevier, 2011, chapter 16, pp. 1487–1541.
- Bourguignon, Francois, Christian Morrisson, and Anthony Atkinson**, *Empirical Studies of Earnings Mobility*, Vol. 52, Chur, Switzerland: Harwood Academic Publishers, 02 1991.
- Burdett, Kenneth and Dale T. Mortensen**, “Wage Differentials, Employer Size, and Unemployment,” *International Economic Review*, 1998, pp. 257–273.
- Card, David, Ana Rute Cardoso, and Patrick Kline**, “Bargaining, Sorting, and the Gender Wage Gap: Quantifying the Impact of Firms on the Relative Pay of Women,” *The Quarterly Journal of Economics*, 2016, 131 (2), 633–686.
- , – , **Jörg Heining, and Patrick Kline**, “Firms and Labor Market Inequality: Evidence and Some Theory,” *Journal of Labor Economics*, 2018, 36 (S1), S13–S70.
- , **Francesco Devicienti, and Agata Maida**, “Rent-Sharing, Holdup, and Wages: Evidence from Matched Panel Data,” *The Review of Economic Studies*, 2013, 81 (1), 84–111.
- , **Jörg Heining, and Patrick Kline**, “Workplace Heterogeneity and the Rise of West German Wage Inequality,” *Quarterly Journal of Economics*, 2013, 128 (3), 967–1015.
- Chan, Mons, Ming Xu, and Sergio Salgado**, “Heterogeneous Passthrough from TFP to Wages,” Working Paper, 2019.
- Chetty, Raj, Nathaniel Hendren, Patrick Kline, and Emmanuel Saez**, “Where is the Land of Opportunity? The Geography of Intergenerational Mobility in the United States,” *Quarterly Journal of Economics*, 2014, 129 (4), 1553–1623.
- Elsby, Michael W. L. and Axel Gottfries**, “Firm Dynamics, On-the-Job Search, and Labor Market Fluctuations,” Working Paper, 2019.
- Engbom, Niklas and Christian Moser**, “Earnings Inequality and the Minimum Wage: Evidence from Brazil,” *Federal Reserve Bank of Minneapolis, Opportunity and Inclusive Growth Institute Working Paper*, 2018, 7.
- Friedrich, Benjamin, Lisa Laun, Costas Meghir, and Luigi Pistaferri**, “Earnings Dynamics and Firm-Level Shocks,” Working Paper, National Bureau of Economic Research 2019.
- Garin, Andrew and Filipe Silvério**, “How Responsive are Wages to Demand within the Firm? Evidence from Idiosyncratic Export Demand Shocks,” Working Papers w201902, Banco de Portugal, Economics and Research Department 2019.
- Guiso, Luigi, Luigi Pistaferri, and Fabiano Schivardi**, “Insurance within the Firm,” *Journal of*

- Political Economy*, 2005, 113 (5), 1054–1087.
- Guvenen, Fatih**, “An Empirical Investigation of Labor Income Processes,” *Review of Economic Dynamics*, 2009, 12 (1), 58–79.
- **and Anthony A. Smith**, “Inferring Labor Income Risk and Partial Insurance from Economic Choices,” *Econometrica*, 2014, 82 (6), 2085–2129.
- Haltiwanger, John, Ron S. Jarmin, and Javier Miranda**, “Who Creates Jobs? Small versus Large versus Young,” *Review of Economics and Statistics*, 2013, 95 (2), 347–361.
- Hopenhayn, Hugo A.**, “Entry, Exit, and Firm Dynamics in Long Run Equilibrium,” *Econometrica*, 1992, pp. 1127–1150.
- Kehrig, Matthias and Nicolas Vincent**, “Good Dispersion, Bad Dispersion,” Working Paper, National Bureau of Economic Research 2019.
- Kline, Patrick, Neviana Petkova, Heidi Williams, and Owen Zidar**, “Who Profits from Patents? Rent-Sharing at Innovative Firms,” *The Quarterly Journal of Economics*, 2019, 134 (3), 1343–1404.
- , **Raffaele Saggio, and Mikkel Sølvsten**, “Leave-Out Estimation of Variance Components,” Technical Report, National Bureau of Economic Research 2019.
- Kopczuk, Wojciech, Emmanuel Saez, and Jae Song**, “Earnings Inequality and Mobility in the United States: Evidence from Social Security Data since 1937,” *Quarterly Journal of Economics*, 2010, 125 (1), 91–128.
- Lachowska, Marta, Alexandre Mas, Raffaele Saggio, and Stephen A. Woodbury**, “Do Firm Effects Drift? Evidence from Washington Administrative Data,” *Working Paper*, 2019.
- Lamadon, Thibaut**, “Productivity Shocks, Long-Term Contracts and Earnings Dynamics,” *Working Paper*, 2016.
- Lemieux, Thomas, W. Bentley MacLeod, and Daniel Parent**, “Performance Pay and Wage Inequality,” *The Quarterly Journal of Economics*, 2009, 124 (1), 1–49.
- Lise, Jeremy and Jean-Marc Robin**, “The Macrodynamics of Sorting between Workers and Firms,” *American Economic Review*, 2017, 107 (4), 1104–35.
- MaCurdy, Thomas E.**, “The Use of Time Series Processes to Model the Error Structure of Earnings in a Longitudinal Data Analysis,” *Journal of Econometrics*, 1982, 18 (1), 83–114.
- Morchio, Iacopo and Christian Moser**, “The Gender Gap: Micro Sources and Macro Consequences,” 2019.
- Moscarini, Giuseppe and Fabien Postel-Vinay**, “The Contribution of Large and Small Employers to Job Creation in Times of High and Low Unemployment,” *American Economic Review*, 2012, 102 (6), 2509–39.
- **and –**, “The Cyclical Job Ladder,” *Annual Review of Economics*, 2018, 10 (1), 165–188.
- Moser, Christian, Farzad Saidi, and Benjamin Wirth**, “The Effects of Credit Supply on Wage Inequality between and within Firms,” *Working Paper*, 2019.
- Ravn, Morten O. and Harald Uhlig**, “On Adjusting the Hodrick-Prescott Filter for the Frequency of Observations,” *The Review of Economics and Statistics*, 2002, 84 (2), 371–376.
- Reenen, John Van**, “The Creation and Capture of Rents: Wages and Innovation in a Panel of UK Companies,” *The Quarterly Journal of Economics*, 1996, 111 (1), 195–226.
- Rosen, Sherwin**, “The Theory of Equalizing Differences,” *Handbook of Labor Economics*, 1986, 1, 641–692.
- Shorrocks, Anthony**, “Income Inequality and Income Mobility,” *Journal of Economic Theory*, 1978, 19 (2), 376–393.
- Song, Jae, David J. Price, Fatih Guvenen, Nicholas Bloom, and Till Von Wachter**, “Firming Up Inequality,” *The Quarterly Journal of Economics*, 2018, 134 (1), 1–50.
- Sorkin, Isaac**, “Ranking Firms Using Revealed Preference,” *The Quarterly Journal of Economics*, 2018, 133 (3), 1331–1393.
- Sterk, Vincent, Petr Sedlacek, and Benjamin Pugsley**, “The Nature of Firm Growth,” 2018.

A Appendix: Data

A.1 Detailed dataset description

Worker demographics data (LISA). The LISA database contains annual data on all adults who are registered in Sweden on December 31 of a given year. The variable list includes year of birth, gender, years of education, field of study, municipality of residence, marital status, number and age of children, and a unique, anonymized individual identifier. We aggregate years of education into five categorical groups, roughly corresponding to the US equivalent of less than high school, high school, some college, college, and postgraduate studies.

Employment register data (RAMS). The RAMS database contains information about all job spells in Sweden since 1985, including gross annual earnings, start and end month of the employment spell, worker type (employee or self-employed), and some information on the employer, including location and whether it is private or public (in the latter case distinguishing between municipality, region or national government). These data are reported by firms on behalf of workers to Swedish tax authorities for the purpose of tax collection. As such, they arguably suffer from little measurement error. Through unique firm, establishment and individual identifiers, we are able to link these spell data to characteristics of individuals and firms from the LISA and FEK.

Based on these data, we construct a measure of gross monthly earnings for each employment spell in the sample, which we convert to real values using Sweden's national consumer price index. We also use these data to impute a measure of firm age, based on the year in which the first individual appeared in the firm. As in many administrative data sets, firm and establishment identifiers sometimes change for reasons such as changes in ownership, etc. We assign a consistent firm and establishment ID by exploiting longitudinal information contained in worker flows.²²

Firm financials data (FEK). The FEK database contains a rich set of annual income and balance sheet data on firms and establishments. SCB has collected some form of these data since 1968. Data since 1985 are made available for research purposes. Up to 1997, data were collected only for the largest firms and a sample of smaller firms. Over the 1997–2002 period, coverage was

²²For two employers with at least five employees, if a set of workers of size greater than half of the workforce of employer j in year t constitutes more than half of the workforce of employer j' in year $t + 1$, then we classify employers j and j' as the same firm.

gradually expanded to cover the universe of private sector firms in Sweden.²³

The data contain information about firms' sector, revenues, input costs, compensation of employees, assets (long-term and short-term), liabilities (long-term and short-term), equity, investments, etc. Based on these data, we construct a measure of real value added per worker by subtracting costs of intermediates from total sales, converting the difference to real values using the national CPI, and dividing this by total annual firm employment. We similarly proceed to construct real per-worker measures of assets, liabilities, equity and investment.

B Appendix: Measuring Firm-Year Pay Heterogeneity

B.1 Details of identification

In this section, we provide details of model identification discussed in Section 3.2 by formalization the definition of a *connected set* in the context of both the original AKM model and our firm-year FE model. To this end, let workers be indexed by $i \in \mathcal{I}$, let firms be indexed by $j \in \mathcal{J}$, and let years be indexed by $t \in \mathcal{T}$. Then let $J : \mathcal{I} \times \mathcal{T} \rightarrow \mathcal{J}$ denote the function identifying for each worker i in year t their current employer $j = J(i, t)$.

Definition of connected set in AKM framework. Given $(\mathcal{I}, \mathcal{J}, \mathcal{T}, J(\cdot))$, consider the induced set of transitions between physical firms given by

$$\mathcal{E}^{AKM} = \{(j, j') \in \mathcal{J}^2 \mid \exists i \in \mathcal{I}, \exists t, t' \in \mathcal{T} \text{ s.t. } j = J(i, t) \wedge j' = J(i, t')\}.$$

Now consider the (undirected) graph $\mathcal{G}^{AKM} = (\mathcal{J}, \mathcal{E}^{AKM})$ consisting of the vertex set \mathcal{J} and the edge set \mathcal{E}^{AKM} . A *connected set of firms* are the vertices of a maximally connected subgraph of \mathcal{G}^{AKM} . That is, the connected set of firms containing a given firm $j \in \mathcal{J}$ is given by

$$\mathcal{C}_j^{AKM} = \bigcup \{C \subseteq \mathcal{J} \mid j \in C \wedge \forall (j', j'') \in C^2 : \exists i \in \mathcal{I}, \exists t', t'' \in \mathcal{T} \text{ s.t. } j' = J(i, t') \wedge j'' = J(i, t'')\}.$$

²³Data also exist at the level of establishments since 2004, but since both time coverage and the economic content of these data are more limited, we focus on firms as the relevant employer concept.

The *connected set of worker-years* containing a given worker-year $(i, t) \in \mathcal{I} \times \mathcal{T}$ is defined as

$$\mathcal{C}_{i,t}^{AKM} = \left\{ (i', t') \in \mathcal{I} \times \mathcal{T} \mid J(i', t') \in \mathcal{C}_{J(i,t)}^{AKM} \right\}.$$

Definition of connected set in firm-year FE framework. The definition of a connected set in the firm-year FE framework proceeds analogously to that in the original AKM framework. Given $(\mathcal{I}, \mathcal{J}, \mathcal{T}, J(\cdot))$, consider the induced set of transitions between firm-years given by

$$\mathcal{E} = \left\{ ((j, t), (j', t')) \in (\mathcal{J} \times \mathcal{T})^2 \mid \exists i \in \mathcal{I} \text{ s.t. } j = J(i, t) \wedge j' = J(i, t') \right\}.$$

Now consider the (undirected) graph $\mathcal{G} = (\mathcal{J} \times \mathcal{T}, \mathcal{E})$ consisting of the vertex set $\mathcal{J} \times \mathcal{T}$ and the edge set \mathcal{E} . A *connected set of firms* are the vertices of a maximally connected subgraph of \mathcal{G} . That is, the connected set of firms containing a given firm-year $(j, t) \in \mathcal{J} \times \mathcal{T}$ is given by

$$\mathcal{C}_{j,t} = \bigcup \left\{ C \subseteq \mathcal{J} \times \mathcal{T} \mid (j, t) \in C \wedge \forall ((j', t'), (j'', t'')) \in C^2 : \exists i \in \mathcal{I} \text{ s.t. } j' = J(i, t') \wedge j'' = J(i, t'') \right\}.$$

The *connected set of worker-years* containing a given worker-year $(i, t) \in \mathcal{I} \times \mathcal{T}$ is defined as

$$\mathcal{C}_{i,t} = \left\{ (i', t') \in \mathcal{I} \times \mathcal{T} \mid (J(i', t'), t') \in \mathcal{C}_{J(i,t),t} \right\}.$$

Detailed illustrations. Figure 14 illustrates 5 cases of identification of connected sets in the firm-year FE model with two periods (indexed $t = 1, 2$) and two firms (indexed A and B) with two employees each (shown as circles). Panels (a) and (b) are reproduced from Figure 1 and discussed in Section 3.1. The remaining panels show cases with firm entry and exit, and with worker entry and exit.

Panel (c) illustrates the case of Firm B exiting after period 1 and Firm C appearing as a new entrant in period 2. At the same time, all workers from the exiting Firm B are observed transitioning between periods to the entering Firm C. In this case, two connected sets are formed: one around Firm A across periods, the other around Firm B in period 1 and Firm C in period 2. Indeed, this case is isomorphic to that in panel (a) without firm entry or exit. The reason for this is that in the firm-year FE model, “physical firms” change identity every year, so only the allocation of workers, but not entry and exit of firms, is a meaningful distinction.

Panel (d) illustrates the case of firm entry and exit as in panel (c) but with additional worker mobility between Firm B in period 1 and Firm A in period 2 (and also mobility between Firm A in period 1 and Firm C in period 2, although this is redundant). As a result, one connected set is formed around all firm-years. For the same reason as in the previous paragraph, this case is isomorphic to that in panel (b) without firm entry or exit.

When does a firm-year not form part of a larger connected set? The answer is: whenever it is not connected through worker mobility to any other firm-years. Panel (e) illustrates such a case with worker entry and exit (an analogous example could be constructed with firm entry and exit). Firm B exists for both periods but no worker is observed switching from Firm B in period 1 to any other firm in period 2, and similarly no worker is observed switching to Firm B in period 2 from any other firm in period 1. As a result, both Firm B in period 1 and Firm B in period 2 are disconnected from the rest of the economy, that is, they each lie in a singleton connected set.

Figure 14. Illustrating identification of the connected set(s), details

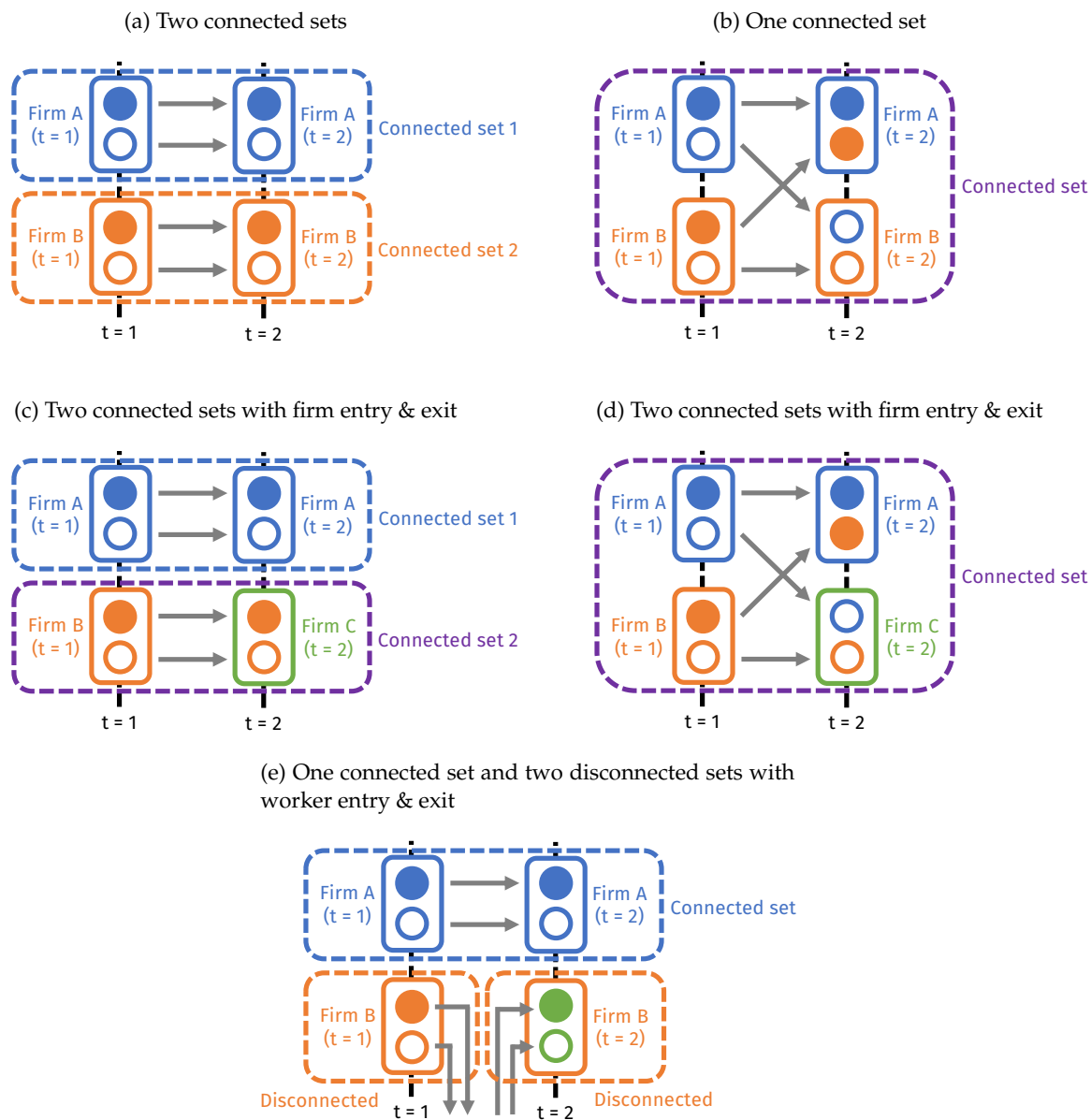

Note: Solid rectangles represent firm-years, with firm A in blue and firm B in orange. Solid and hollow circles represent workers, with worker 1 in solid blue, worker 2 in hollow blue, worker 3 in solid orange, and worker 4 in hollow orange. Vertical dashed lines represent time, with period $t = 1$ to the left and period $t = 2$ to the right. Solid arrows represent worker transitions across firm-years. Dashed rectangles represent the connected set(s) formed by worker transitions across firm-years.

B.2 First-Stage Results for AKM Specification with Firm FE

Table 6. Variance decomposition based on firm FE

	(1)	(2)	(3)	(4)	(5)
$Var(y_{ijt})$	0.236	0.230	0.231	0.234	0.235
$Var(\hat{\alpha}_i)$	0.121	0.120	0.125	0.130	0.131
$Var(\hat{\psi}_j)$	0.032	0.021	0.016	0.013	0.013
$Var(\gamma_t)$	0.003	0.003	0.003	0.004	0.004
$Var(X_{it}\hat{\beta})$	0.025	0.024	0.022	0.020	0.019
$2 \times \sum Cov(\cdot)$	0.003	0.012	0.015	0.017	0.019
$Var(\hat{\varepsilon}_{ijt})$	0.051	0.051	0.050	0.050	0.049
$Corr(\hat{\alpha}_i, \hat{\psi}_{jt})$	0.056	0.134	0.169	0.181	0.182
Observations	21,145,007	18,425,427	15,091,142	11,313,701	9,392,584
Unique workers	3,056,376	2,801,551	2,437,724	1,959,034	1,685,029
Unique firms	411,361	112,262	33,754	8,303	3,656
Largest connected set	98.5%	99.9%	100.0%	100.0%	100.0%
R^2	0.782	0.779	0.783	0.788	0.790
Firm FE type	Firm	Firm	Firm	Firm	Firm
Income concept	Earnings	Earnings	Earnings	Earnings	Earnings
Minimum firm size	1	5	15	50	100

Note: Variance decomposition is based on the following earnings equation: $y_{ijt} = \alpha_i + \psi_j + \gamma_t + X_{it}\beta + \varepsilon_{ijt}$. The resulting variance decomposition is $Var(y_{ijt}) = Var(\hat{\alpha}_i) + Var(\hat{\psi}_j) + Var(\gamma_t) + Var(X_{it}\hat{\beta}) + 2\sum Cov(\cdot) + Var(\hat{\varepsilon}_{ijt})$. Largest connected set is stated in terms of the fraction of worker-years. Source: LISA, RAMS.

B.3 Second stage regression for workers

In parallel to our analysis of firm-year pay policies, following the two-stage methodology in Alvarez et al. (2018), we project the estimated worker FE from our augmented AKM equation (1) onto observable worker characteristics. Specifically, we estimate the following second-stage regression for individual i in year t :

$$\hat{\alpha}_i = W_i\gamma + \omega_i, \quad (10)$$

where $\hat{\alpha}_i$ is the estimated first-stage worker fixed effect, W_i is a vector of observable worker characteristics, and ω_i is a worker-level error term. In estimating equation (10), our interest will lie in the coefficient estimate $\hat{\gamma}$ on worker-level attributes.

Two main findings of this worker-level second-stage regression are presented in Figure 15.

First, we find a strong relation between worker pay and education, suggesting that higher skill groups are remunerated through permanently higher pay in the labor market, regardless of their employer-year combination. Second, we find a weak relation between worker pay and average worker age, suggesting that cohort effects on pay are relatively muted.

Figure 15. Second stage results: Estimated worker pay versus worker characteristics

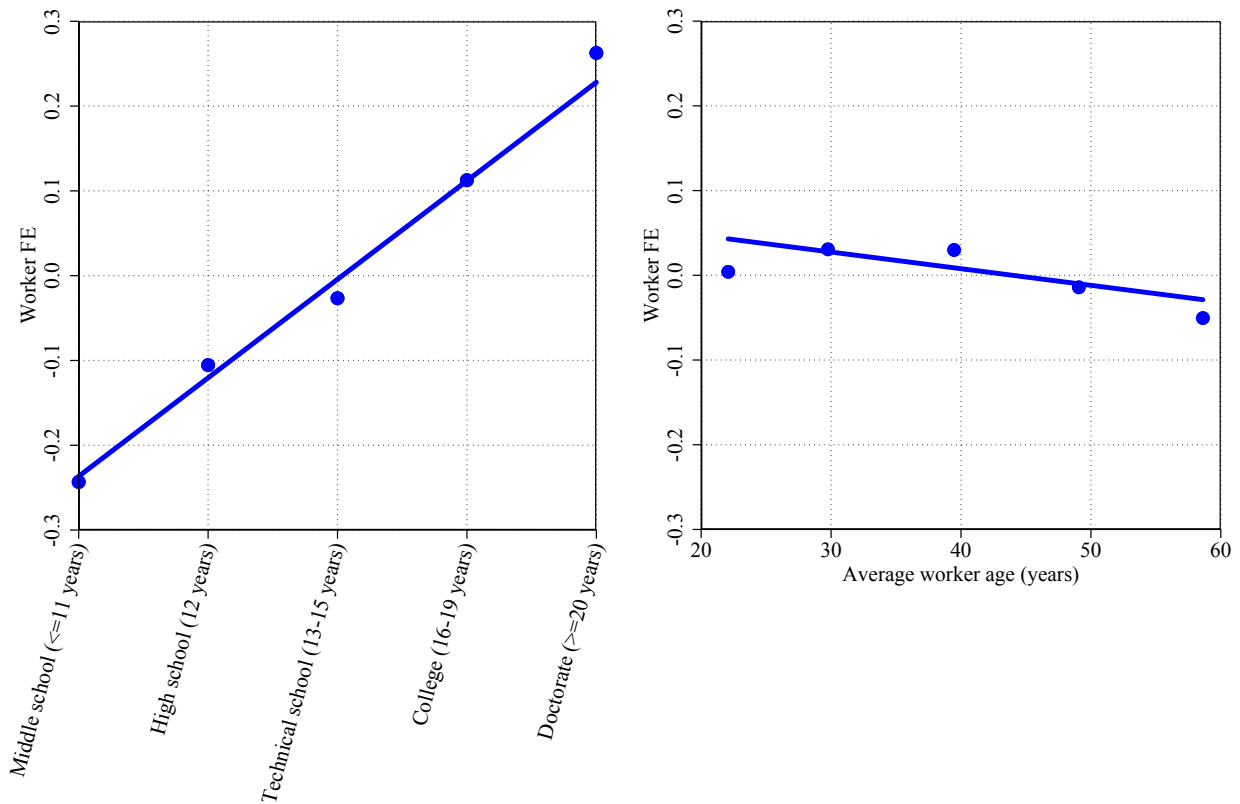

Note: Figure shows mean worker FE by education group (left) and for average worker age groups (right) based on firm-year FE specification in equation (1). Source: LISA, RAMS, FEK.

B.4 Further Details on Comparison of Firm Pay Measures

Figure 16. Comparison between firm FE, firm-year FE, and mean earnings (firm-year FE on x-axis)

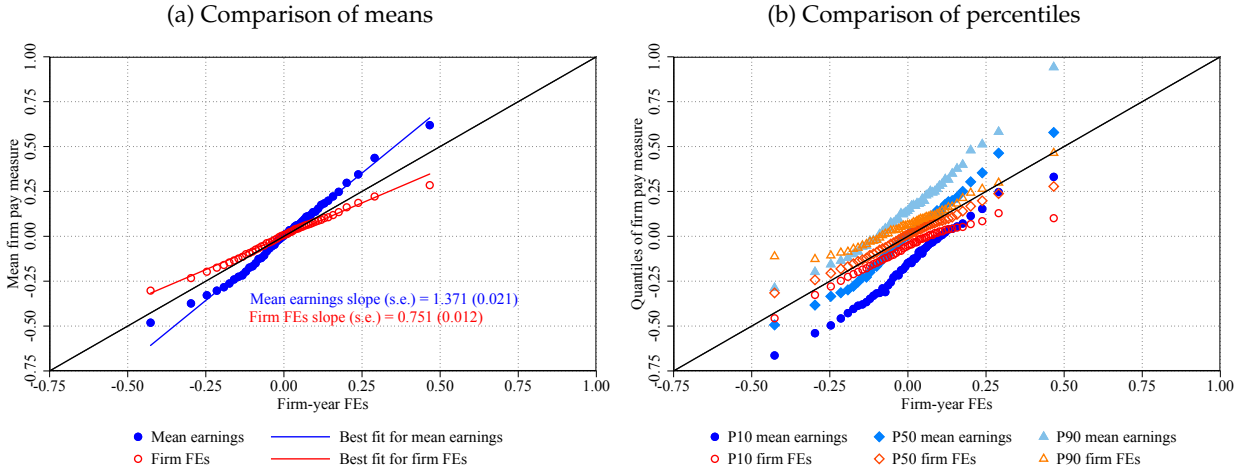

Note: Figure shows binned scatter plots of mean firm pay measures with linear best fit lines (panel (a)) and of various percentiles of the conditional distribution of firm pay measures (panel (b)) as a function of mean firm-year FE bins. Source: LISA, RAMS.

Figure 17. Comparison between firm FE, firm-year FE, and mean earnings (firm FE on x-axis)

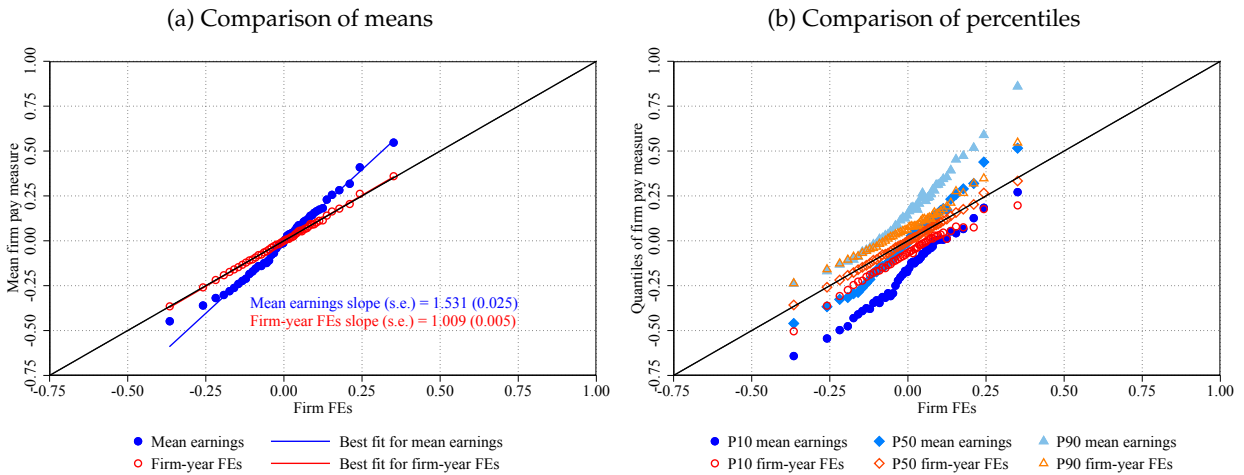

Note: Figure shows binned scatter plots of mean firm pay measures with linear best fit lines (panel (a)) and of various percentiles of the conditional distribution of firm pay measures (panel (b)) as a function of mean firm FE bins. Source: LISA, RAMS.

C Appendix: Firm Pay Dynamics

C.1 Further Details on Firm Pay Distribution over Time

Figure 18. Evolution of firm-year FE in an unbalanced and unweighted panel, 1986–2015

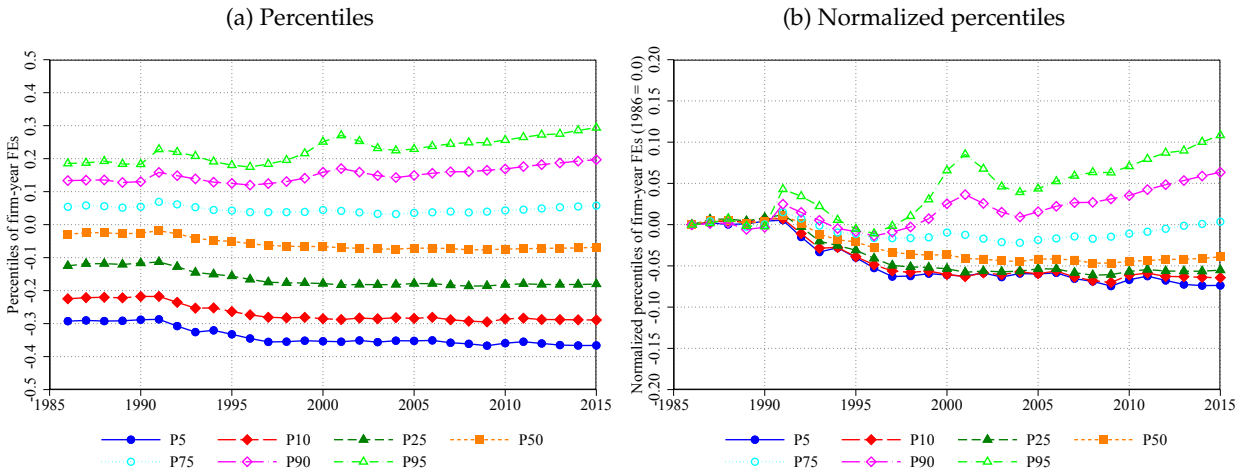

Note: Figure shows various percentiles of the distribution of firm-year FEs in levels (panel (a)) and relative to the year 1986 (panel (b)) for an unbalanced and unweighted panel of firms. Source: LISA, RAMS.

Figure 19. Evolution of firm-year FE in a balanced and weighted panel, 1986–2015

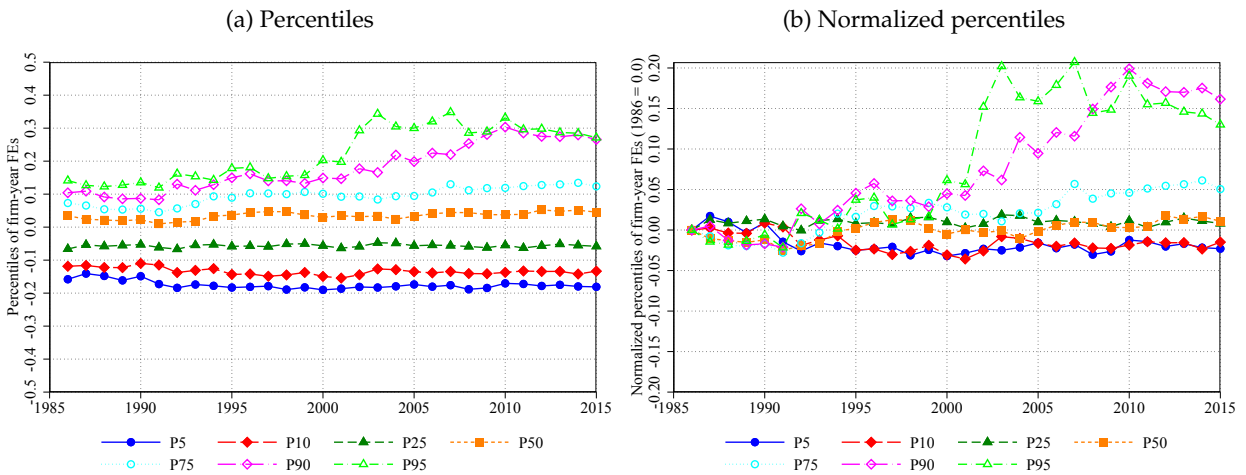

Note: Figure shows various percentiles of the distribution of firm-year FEs in levels (panel (a)) and relative to the year 1986 (panel (b)) for a balanced and employment-weighted panel of firms. Source: LISA, RAMS.

Figure 20. Evolution of firm-year FEs in a balanced and unweighted panel, 1986–2015

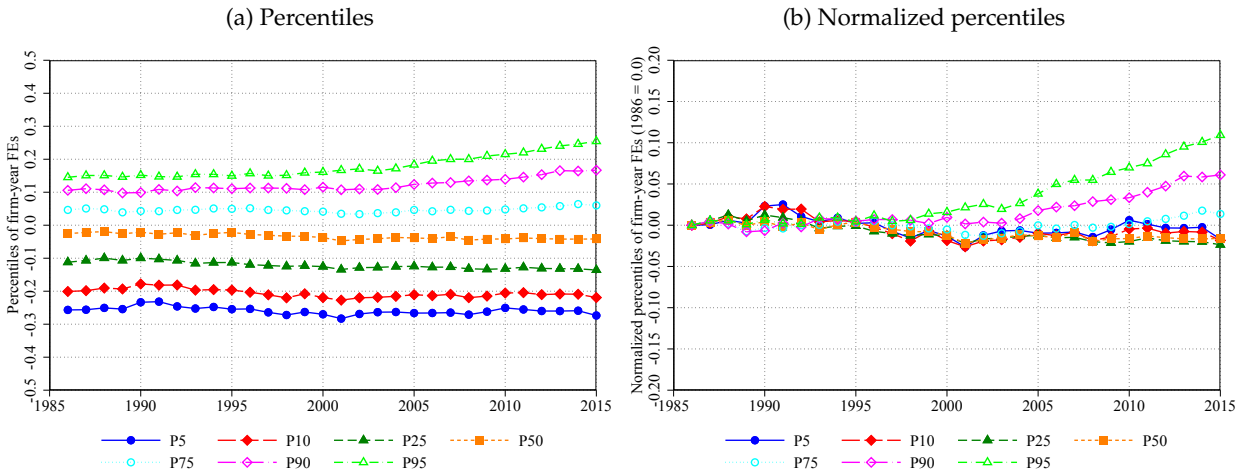

Note: Figure shows various percentiles of the distribution of firm-year FEs in levels (panel (a)) and relative to the year 1986 (panel (b)) for a balanced and unweighted panel of firms. Source: LISA, RAMS.

C.2 Further Details on Distribution of Changes in Firm Pay

Figure 21. Distribution of differences in firm-level mean earnings at various lag lengths

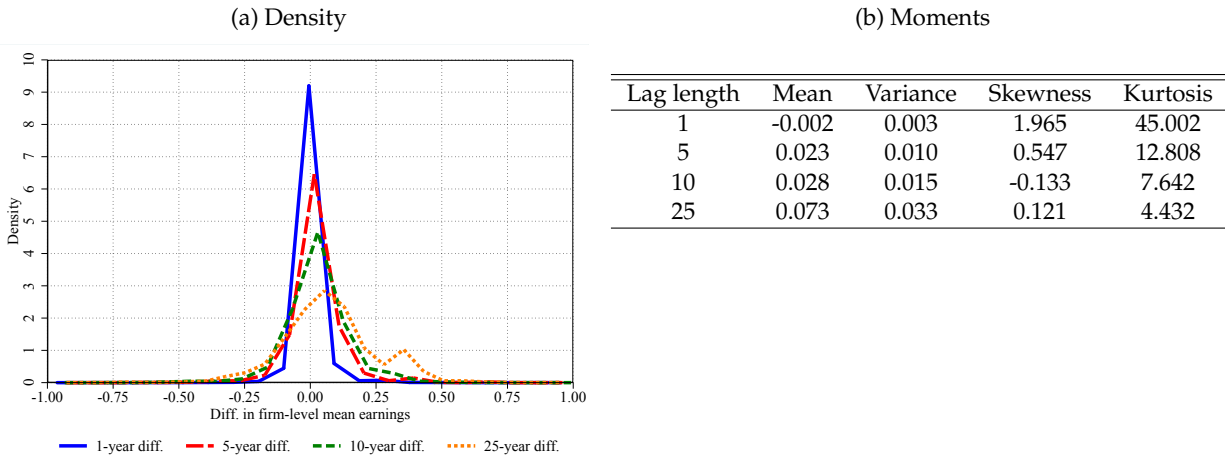

Note: Figure shows nonparametric Epanechnikov kernel density estimates of the distribution of the within-firm differences in firm-level mean earnings at various lag lengths in panel (a) and moments of the distribution at various lag lengths in panel (b). Source: LISA, RAMS.

C.3 Further Details on Firm Pay Mobility

Figure 22. Mean mobility in firm-level mean earnings

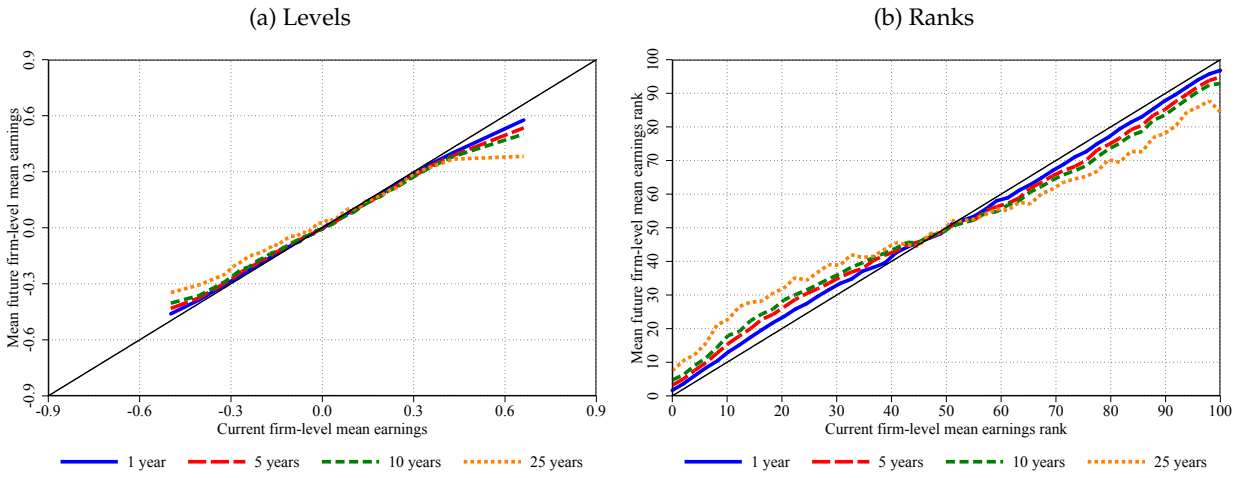

Note: Figure shows the mean future level (panel (a)) and percentile ranks (panel (b)) of firm-level mean earnings conditional on current firm-level mean earnings at various lag lengths. Source: LISA, RAMS.

Figure 23. Percentiles of mobility in firm-level mean earnings

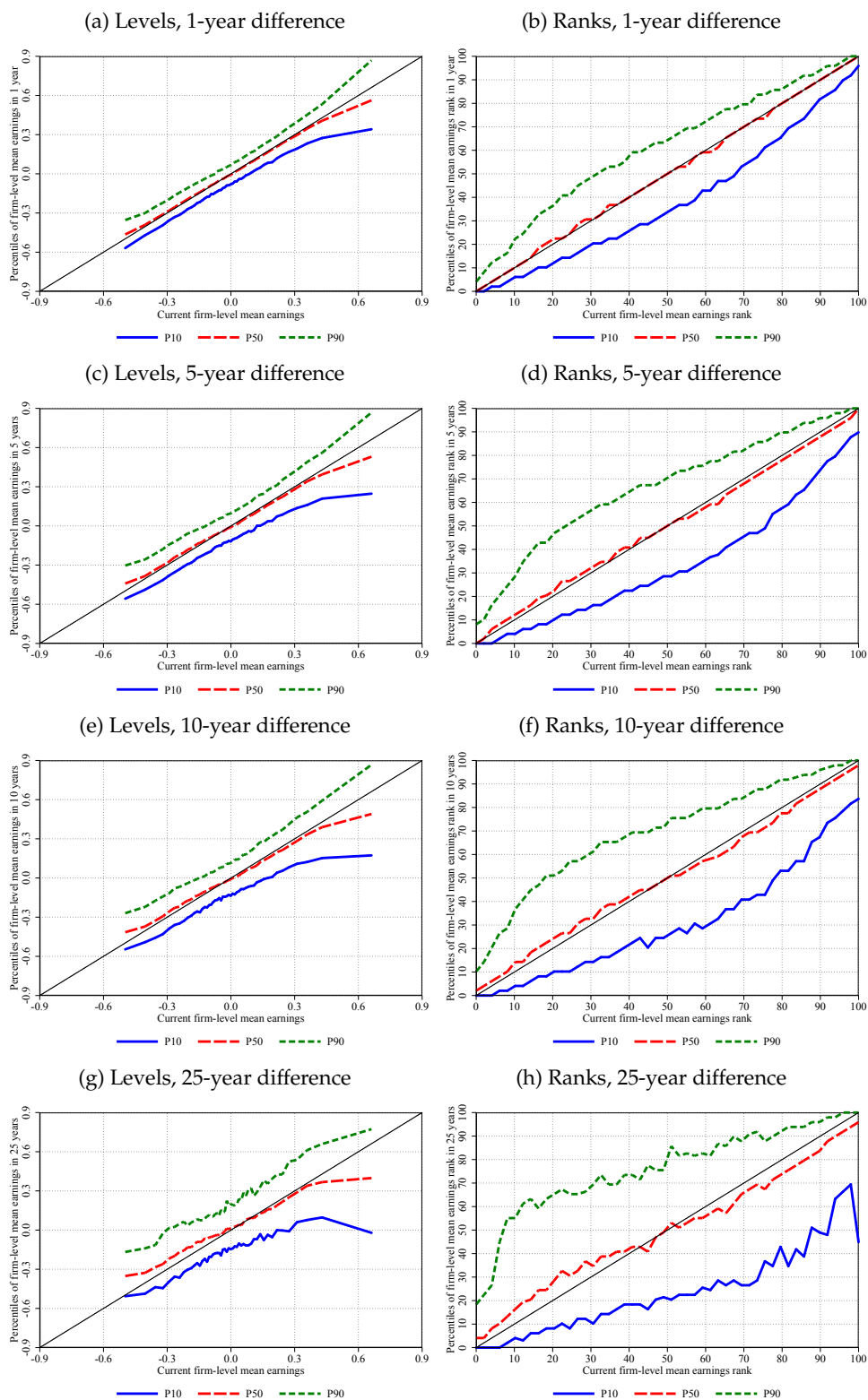

Note: Figure shows various percentiles of future levels (panels (a), (c), (e), and (g)) and percentile ranks (panels (b), (d), (f), and (h)) of the firm-level mean earnings distribution conditional on the current firm-year fixed effect at various lag lengths. Source: LISA, RAMS.

C.4 Further Details on Ex-Ante versus Ex-Post Firm Pay Heterogeneity

Further Details on Firm Pay Heterogeneity at Firm Entry.

Figure 24. Distribution of firm-year FEs at new firms versus all firms (no firm size threshold)

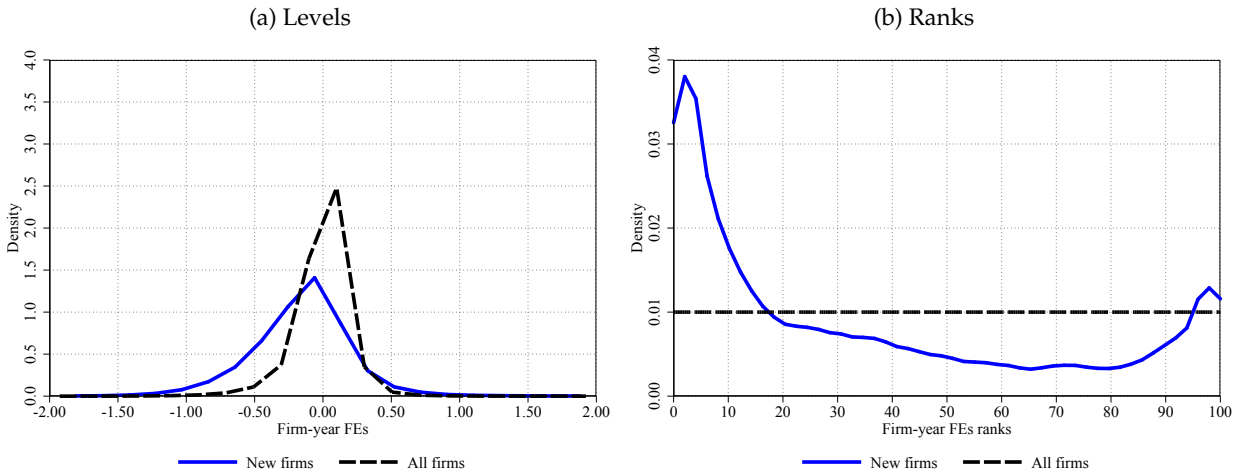

Note: Figure shows nonparametric Epanechnikov kernel density estimates of the distribution of firm-year FEs for new firms compared to all firms (a) and the distribution of firm-year FE population ranks for new firms compared to all firms (b) without a minimum firm size threshold. Source: LISA, RAMS.

Figure 25. Distribution of firm-year FEs by firm age

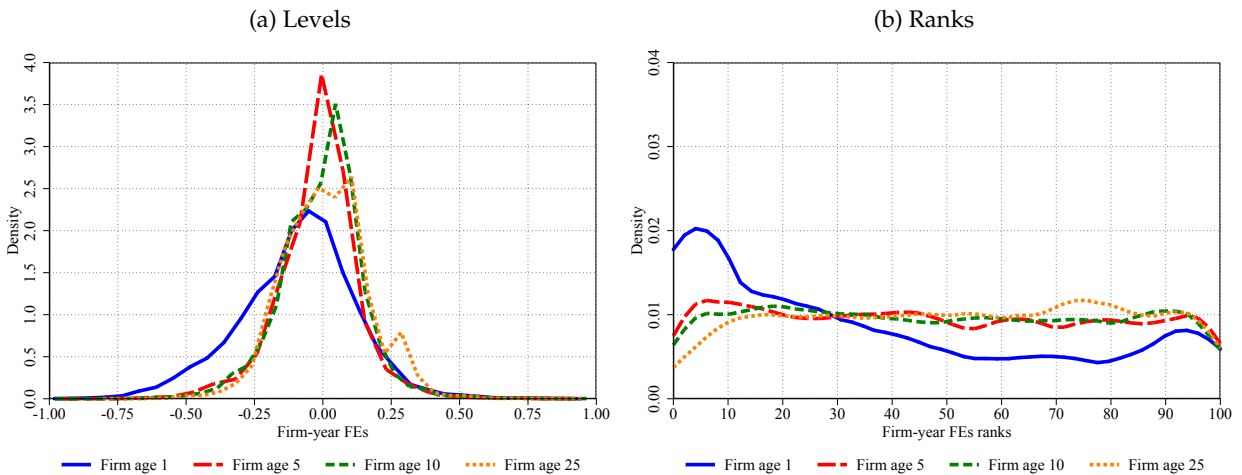

Note: Figure shows nonparametric Epanechnikov kernel density estimates of the distribution of firm-year FEs for new firms from various age groups (a) and the distribution of firm-year FE population ranks for new firms from various age groups (b). Source: LISA, RAMS.

Figure 26. Distribution of firm-year FEs by firm age (no firm size threshold)

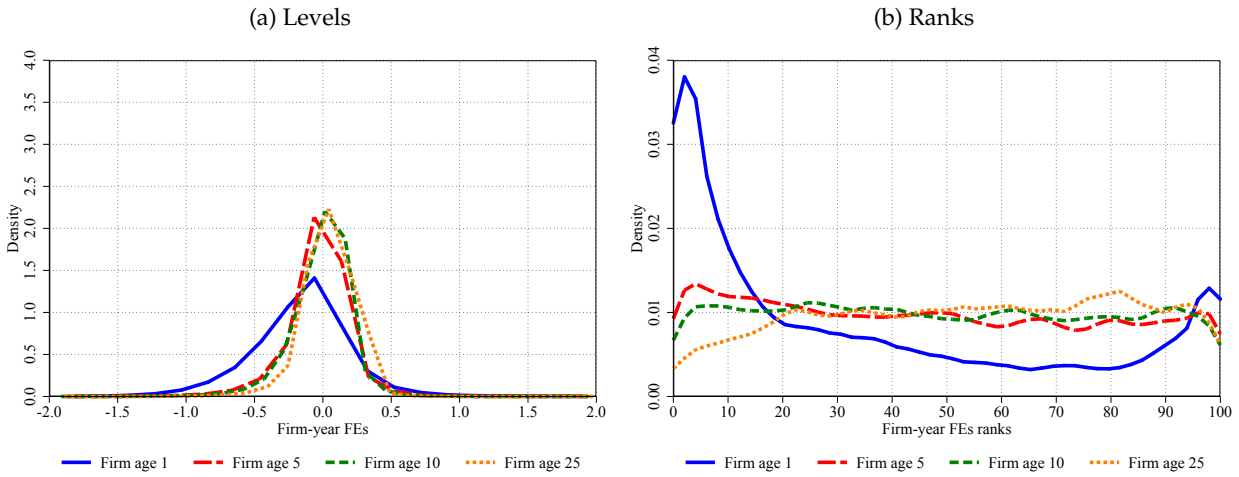

Note: Figure shows nonparametric Epanechnikov kernel density estimates of the distribution of firm-year FEs for new firms from various age groups (a) and the distribution of firm-year FE population ranks for new firms from various age groups (b). Source: LISA, RAMS.

Figure 27. Distribution of firm-year FEs by firm cohort (no firm size threshold)

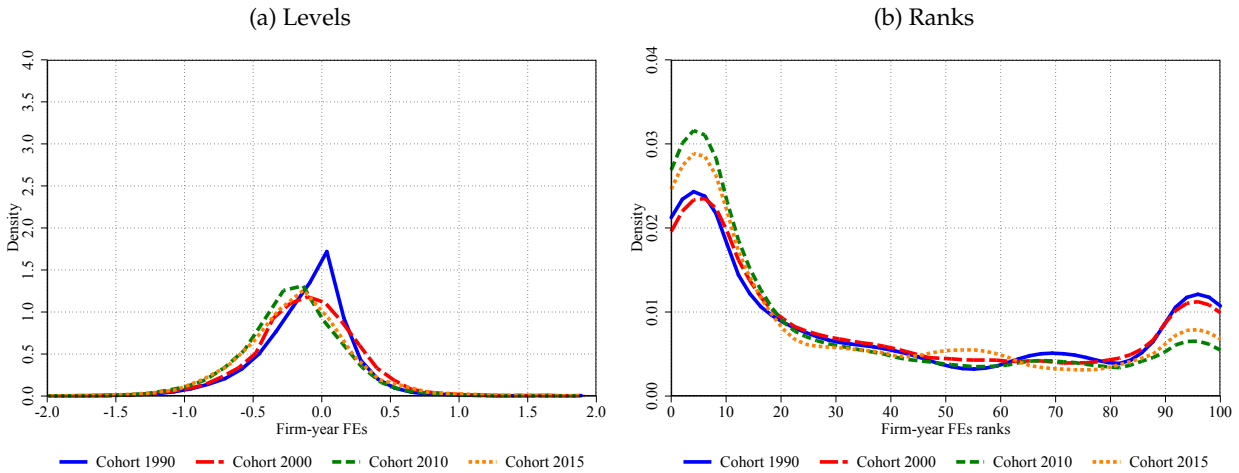

Note: Figure shows nonparametric Epanechnikov kernel density estimates of the distribution of firm-year FEs for new firms from various cohorts (a) and the distribution of firm-year FE population ranks for new firms from various cohorts (b). Source: LISA, RAMS.

Figure 28. HP-filtered cyclicity of mean firm-year FE of new cohort (no firm size threshold)

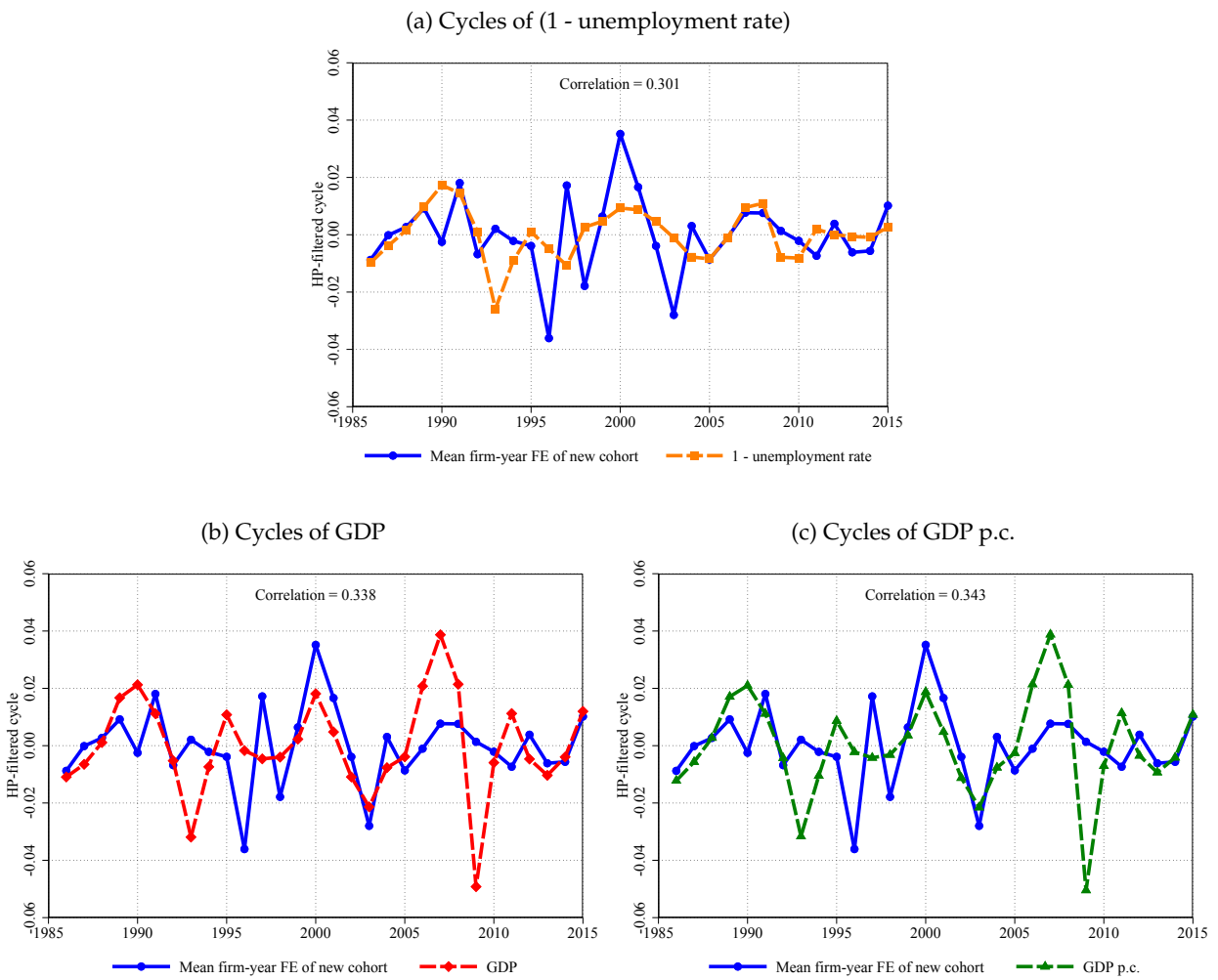

Note: Mean firm-year FE is relative to population of all firms, which is mean zero in each year. Cyclical components are extracted from the annual time series using an HP filter with smoothing parameter $\lambda = 6.25$, as recommended by Ravn and Uhlig (2002). Source: LISA, RAMS, IMF WEO.

Further Details on Statistical Model.

Figure 29. Global Identification Diagnostics: Minimum Distance Function

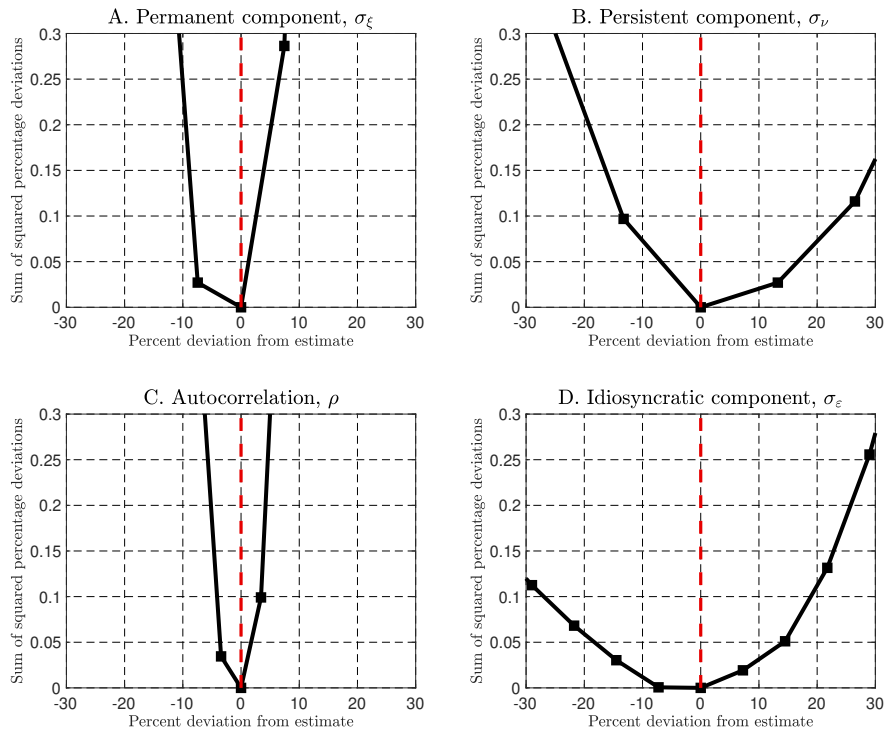

Note: Figure shows the GMM minimization problem's criterion function (black solid line) around the optimum parameter values (vertical red dashed line) for the standard deviation of the permanent component (top left), the standard deviation of the persistent component (top right), the autocorrelation (bottom left), and the standard deviation of the idiosyncratic component (bottom right).
Source: LISA, RAMS.