

Article

Estimating the Optimum Tilt Angles for South-Facing Surfaces in Palestine

Ramez Abdallah ¹, Adel Juaidi ^{1,*}, Salameh Abdel-Fattah ¹ and Francisco Manzano-Agugliaro ² 

¹ Mechanical Engineering Department, Faculty of Engineering & Information Technology, An-Najah National University, P.O. Box 7, 00970 Nablus, Palestine; ramezkhaldi@najah.edu (R.A.); salabdel@najah.edu (S.A.-F.)

² Department of Engineering, CEIA3, University of Almeria, 04120 Almeria, Spain; fmanzano@ual.es

* Correspondence: adel@najah.edu

Received: 7 December 2019; Accepted: 27 January 2020; Published: 1 February 2020



Abstract: The optimum tilt angle of solar panels or collectors is crucial when determining parameters that affect the performance of those panels. A mathematical model is used for determining the optimum tilt angle and for calculating the solar radiation on a south-facing surface on a daily, monthly, seasonal, semi-annual, and annual basis. Photovoltaic Geographical Information System (PVGIS) and Photovoltaic Software (PVWatts) is developed by the NREL (US National Renewable Energy Laboratory) are also used to calculate the optimum monthly, seasonal, semi-annual, and annual tilt angles and to compare these results with the results obtained from the mathematical model. The results are very similar. PVGIS and PVWatts are used to estimate the solar radiation on south-facing surfaces with different tilt angles. A case study of a mono-crystalline module with 5 kWP of peak power is used to find out the amount of increased energy (gains) obtained by adjusting the Photovoltaic (PV) tilt angles based on yearly, semi-annual, seasonal, and monthly tilt angles. The results show that monthly adjustments of the solar panels in the main Palestinian cities can generate about 17% more solar energy than the case of solar panels fixed on a horizontal surface. Seasonal and semi-annual adjustments can generate about 15% more energy (i.e., it is worth changing the solar panels 12 times a year (monthly) or at least 2 times a year (semi-annually). The yearly optimum tilt angle for most Palestinian cities is about 29°, which yields an increase of about 10% energy gain compared to a solar panel fixed on a horizontal surface.

Keywords: optimal tilt angle; PV system; solar photovoltaic; solar radiation; PVGIS; PVWatts; Palestine

1. Introduction

Solar energy plays a crucial role in the future of sustainable energy as an environmentally friendly source of energy. Solar panel use has gained acceptance nowadays to become part of our modern-day life. The situation of energy in Palestine is different from that of surrounding countries due to several reasons: a scarcity of natural resources, the political conditions in Palestine are unstable, the difficult financial situation, and the high density of the population [1]. Palestine's natural resources and mineral wealth are scarce; this scarcity includes traditional sources of energy, such as oil and gas deposits. The high prices of hydrocarbon fuels in Palestinian cities are equivalent to those prices found in the most expensive cities in the world [1]. In addition, Palestine imports 100% of its fossil fuel and 87% of its electricity from other countries [1].

Palestine desperately needs all kinds of energy for growing its weak economy. There is no access to electricity for all Palestinian people for the whole day [1]. Palestinians strongly seek to overcome this dilemma by finding alternative sources of conventional fuel [2]. As in the case of the civilized world, they have found alternative sources of energy through which they hope to reduce their dependence

on other countries. An example of this is the fuel crisis that the Gaza Strip experienced in mid-2013, which negatively affected the lives of people, especially in the health and transportation sectors; up to this time, Gaza Strip populations were living outside modern world era using primitive methods of mobility and lighting that disappeared a long time ago [2,3].

There is no doubt that the Palestinian tendency has shifted toward reliance on renewable sources of energy, which is consistent with the increasing global trends in the exploitation of alternative sources of energy. The trend in Palestine is concentrated in solar, biomass, wind, and geothermal energy [4]. The global trend is to find a clean, renewable, domestic sustainable energy source. This trend philosophy is increasing day by day, after significant damage caused by fossil fuels and their obvious risks to human health and the environment; toxic fumes and harmful gases from fossil fuel burning are a lingering health hazard endangering different forms of life on this planet. The most prominent environmental impact manifestations can be seen and felt right now, such as global warming, climate variability, ozone hole expansion, and acid rain, well as the frequent pollution of the seas by oil spills. The surge of oil prices is another driving force to find a replacement for conventional fossil fuels.

The Palestinians have succeeded to some extent in the exploitation of solar energy; they been using solar water heaters to heat water for domestic household uses and for limited industrial applications since the mid-seventies of the last century. The solar heater is a key component of every Palestinian home [5]. On the other hand, solar electricity generation remains limited due to research issues or limited activities of donors to help the population in disadvantaged areas. There are initial attempts at the exploitation of wind energy, as well as thermal energy. All these applications are still limited in the embryonic stage, with a promise of good potential [6,7].

1.1. Physical Characteristics of Palestine

Palestine, as it exists today, is formed from two separated land areas. The first is the West Bank with a total area of 5661 km², and the other is the Gaza Strip with a total area of 362 km² [8]. The West Bank is bordered to the north, west, and south by Israel and to the east by the Jordan River. It consists of eleven governorates: Jerusalem (East Jerusalem), Ramallah, Al-Bireh, Hebron, Nablus, Jenin, Tulkarm, Jericho, Tubas, Qalqiliya, Bethlehem, and Salfit. The Gaza Strip is located in the eastern Mediterranean Sea [8]. The Gaza Strip is bordered to the north and east by Israel, to the south by Egypt, and to the west by the Mediterranean Sea. It consists of five governorates: Rafah, Khan Yunis, North Gaza, Deir al Balah, and Gaza (as shown in the map in Figure 1).

Climate: Palestine has a Mediterranean climatic zone which has hot, long, dry summers and cool, short, wet winters [8]. However, the south of the Jordan Valley has a different climate zone and lies between the extreme desert conditions and dry steppe [8]. The climate within Palestine is affected by orographic effects, distance from the Mediterranean, altitude, and latitudinal position. Therefore, the climate of the West Bank can be divided into four main climatic zones: the Eastern Slopes, the Western Slopes, the Jordan Valley, and the Central Highlands. The climate of the West Bank, especially in the south, is affected by the vast nearby Arabian and the Negev deserts, especially during early summer and spring. Desert storms with hot winds full of dust and sand (locally known as Khamaseen winds) lead to increasing air temperatures and decreased humidity [8].

Temperature: The temperature of Palestine is comparatively high. The Jordan Valley and Jericho have the highest temperatures. The temperatures of the Jordan Valley are related inversely to altitude and decrease from south to north, with the highest temperature in the southern part at the Dead Sea. The Dead Sea is considered the lowest point on earth and is surrounded by a series of high mountains from both west and east, which create a natural greenhouse climate [8]. In summer, June, July, and August, the monthly average temperatures for the West Bank range from 20.8 °C to 30 °C. During winter months, December, January, and February, the monthly average temperatures in the West Bank range between 8.7 °C and 14.7 °C. The Gaza Strip lies between the semi-humid Mediterranean climate along the coast and the arid desert climate of the Sinai Peninsula. The monthly mean temperatures range from 13 °C in winter to 25 °C in summer [8].

Sunshine Duration: In Palestine, solar radiation varies from one city to another. June has the longest duration of sunlight, and December has the shortest duration of sunlight [8]. During the summer months, clear skies strengthen solar radiation, whereas during the winter, cloud cover reduces solar radiation [8].

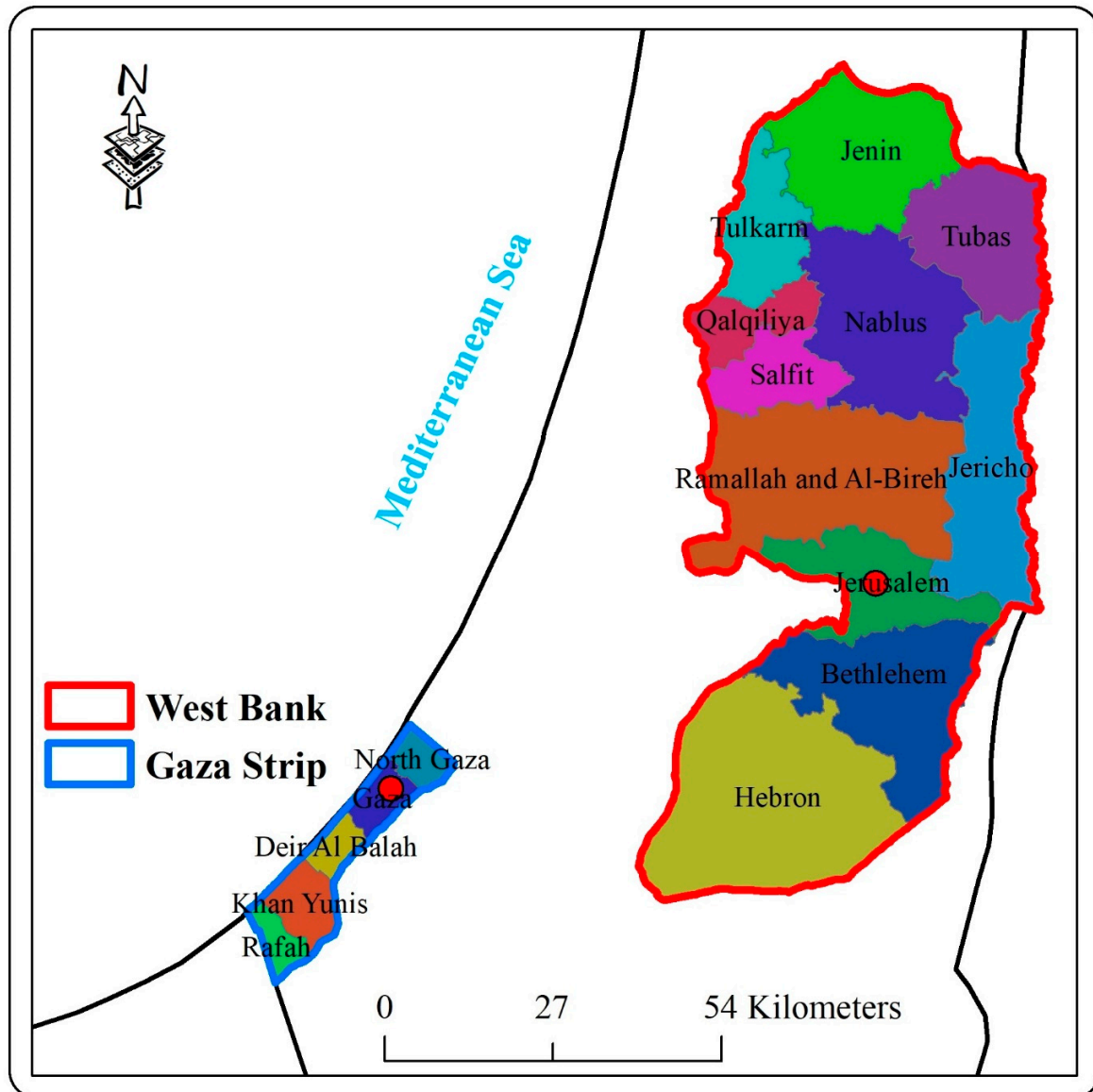

Figure 1. Map of the West Bank and Gaza Strip (Palestine).

1.2. The Situation of Electric Energy in Palestine and Net-Metering Regulations

The total electricity consumption for Palestine is 5137 GWh/year. About 87% is imported from the Israel Electric Corporation (IEC), while less than 8% is from the Palestine Electric Company. A small portion is imported from Jordan to supply Jericho in West Bank and from Egypt to supply Rafah in the Gaza Strip [1]. According to the Palestinian Central Bureau of Statistics (PCBS), more than 99.7% of the Palestinians in the West Bank and Gaza Strip are connected to the grid. For that reason, most of the solar PV in Palestine is an on-grid solar system [9].

The Palestinian Energy Authority (PEA) policy is to encourage the Palestinian people to utilize solar PV power to contribute to independency of Palestinian energy and support the Palestinian economy. To encourage solar PV energy, the PEA introduced the net-metering regulations.

The electricity generated by PV is supplied to the houses, where the grid serves as ‘electricity storage’. In the case where solar PV produces more energy than that consumed by the houses, then the excess electrical energy is transferred to the grid. On the other hand, when the house electricity consumption is higher than the production, the house uses electricity from the grid. If the injection energy is more than the consumption during the month, 75% of the excess energy is credited to the next month. The credits are valid for 36 months. In times of higher consumption than production, the balance has to be paid by the consumer [10].

2. Methodology

Palestine is one of the countries enclosed between latitudes 40 degrees north and 40 degrees south (the so-called sun-belt). Palestine has more than 300 sunny days per year at an average brightness of 8 hours per day, increasing in summer and decreasing in winter. Previous studies show that the average daily solar radiation in Palestine reaches 5.4 kWh/m², which is equivalent to an annual production of 1950 kWh of energy, which has enabled Palestine to be one of the best areas using solar energy, and the possibility of investing in it is economically feasible [5].

When installing photovoltaic cells in an area, one must first calculate solar radiation in this region to optimize installation layouts to maximize the generated electricity, and to calculate solar radiation first, we must recognize the so-called solar angles.

Solar Angles

Declination angle (δ): is the angle between the equatorial plane and the line that connects between the earth’s center and the sun’s center. The declination angle varies seasonally between 23.45 and -23.45 and is calculated from the following relationship.

$$\delta = -23.45 \cos\left((n + 10.5) \frac{360}{365}\right), \quad (1)$$

n = the day number, such that $n = 1$ on the 1st of January.

Latitude angle (θ): is the angle between the equator and the line passing through the earth’s center and a point on the earth’s surface; northern latitudes are positive, and southern latitudes are negative.

Hour angle (h): is the angle between the plane containing the axis of the earth and the zenith and the other plane containing the axis of the earth and a point on the Earth’s surface.

The altitude angle (α): is the angle between the horizontal and the rays of the sun. Therefore, the altitude angle for sunrise and sunset equals zero. The altitude angle (α) is calculated by [11]:

$$\sin \alpha = \sin \delta \sin \varnothing + \cos \delta \cos h \cos \varnothing. \quad (2)$$

Note that the hour angles at sunrise and sunset (h_s) have the same magnitude and can be calculated by substituting $\alpha = 0$ into the previous equation (Equation (2)) to obtained:

$$h_s = \cos^{-1}[-\tan(\varnothing) \tan(\delta)]. \quad (3)$$

The tilt angle (β): is the angle between the horizontal and the tilted surface.

The total solar radiation is the sum of the direct, diffuse, and reflected solar radiation. Firstly, direct radiation depends on the atmosphere’s thickness, the quantity of water vapor, and the level of pollution in the atmosphere. Secondly, diffuse solar radiation is defined as all the solar radiation that comes from the sky except for the part that comes directly from the sun. Therefore, it is difficult to calculate because it totally depends on highly variable cloudiness and atmospheric clarity. Finally, reflected radiation from buildings, cars, the ground, and streets must be calculated individually. For that reason, reflected radiation is usually neglected. In this paper, an “ASHRAE standard atmosphere” is assumed. This assumption will overestimate the solar radiation. On the other hand, this paper

studies the optimum tilt angle rather than the available radiation. The total radiation obtained by the "ASHRAE standard atmosphere" assumption will be more than the actual available radiation, but the optimum tilt angles to achieve maximum radiation from any tilted surface will be the same. At the end of this study, the results will be compared to previously published papers.

In the Northern Hemisphere, it is considered that optimum orientation is due south [12,13]. Moreover, in 2013, Jafarkazemi and Saadabadi [14] found that the optimum orientation for Abu Dhabi was due south. Also, in 2010, Pavlović, et al. [15] estimated the optimum orientation for Serbia to be due south. Finally, in 2018, Omar and Mahmoud [16] confirmed that the optimum orientation for Palestine is due south. Based on the previous studies, the present mathematical model considers the titled surfaces to be due south.

The daily total extraterrestrial radiation on a tilted surface with an angle surface β and facing south is [9]:

$$I_d = \frac{24}{\pi} I_o \left[1 + 0.034 \cos\left(\frac{2\pi n}{365}\right) \right] \times [\cos(\varnothing - \beta) \cos(\delta) \sin(h_s) + h_s \sin(\varnothing - \beta) \sin(\delta)]. \quad (4)$$

From Equation (4), for a particular day n to have an optimum tilt angle ($\beta_{op,d}$), the total radiation I_d must be derived with respect to the tilt angle (β) and equalized with the resulting derivative set to zero, i.e., $\frac{dI_d}{d\beta} = 0.0$. to obtain:

$$\beta_{op,d} = \varnothing - \tan^{-1} \left[\frac{h_s}{\sin(h_s)} \tan(\delta) \right]. \quad (5)$$

It could be concluded that adjusting the surface tilt angle every day is not practical, but it can be changed monthly or seasonally; the total radiation for a particular period can be obtained as:

$$I_p = \sum_{n=n_1}^{n=n_2} I_d, \quad (6)$$

where p is the particular period, n_1 and n_2 are the first and last days of a particular period, respectively. For obtaining the optimum tilt angle $\beta_{op,p}$ for a particular period (from n_1 to n_2), I_p must be derived with respect to the tilt angle (β) and equalized with the resulting derivative set to zero, i.e., $\frac{dI_p}{d\beta} = 0.0$ to obtain:

$$\beta_{op,p} = \varnothing - \tan^{-1} \left[\frac{\sum_{n=n_1}^{n=n_2} \frac{24}{\pi} I_o \left[1 + 0.034 \cos\left(\frac{2\pi n}{365}\right) \right] \sin(\delta) h_s}{\sum_{n=n_1}^{n=n_2} \frac{24}{\pi} I_o \left[1 + 0.034 \cos\left(\frac{2\pi n}{365}\right) \right] \cos(\delta) \sin(h_s)} \right]. \quad (7)$$

A MATLAB program (An-Najah National University Computer Labs.) was created to find the optimum tilt angle for any particular period using Equations (1)–(7). Using this program, the optimum tilt angle and total extraterrestrial radiation can be obtained for daily, monthly, seasonal, and yearly values. The major solar angles are shown in Figure 2a,b.

A comparison of the optimum tilt angle of the previous mathematical model was performed with the optimum tilt angle derived from the National Renewable Energy Laboratory (NREL) PVWatts program (NREL, 2017) [17] and PVGIS has been developed at the European Commission Joint Research Centre, at the JRC site in Ispra, Italy since 2001 [18]. The PVWatts Calculator is an online calculator that gives the amount of global radiation and the energy production of the PV using solar resource data for fixed locations throughout the world. The PVGIS gives the amount of global radiation and the energy production of the PV using the solar radiation data produced from satellite images. For the version of PVGIS used in this study, the satellite data used for the solar radiation estimates are from the METEOSAT satellites covering Europe, Africa, and most of Asia. Depending on satellite images, these images are captured every 15 minutes or 30 minutes [18]. Utilizing PVGIS, one image per hour

was used; this means that PVGIS can be used for any location regardless of the distance to a particular meteorological station.

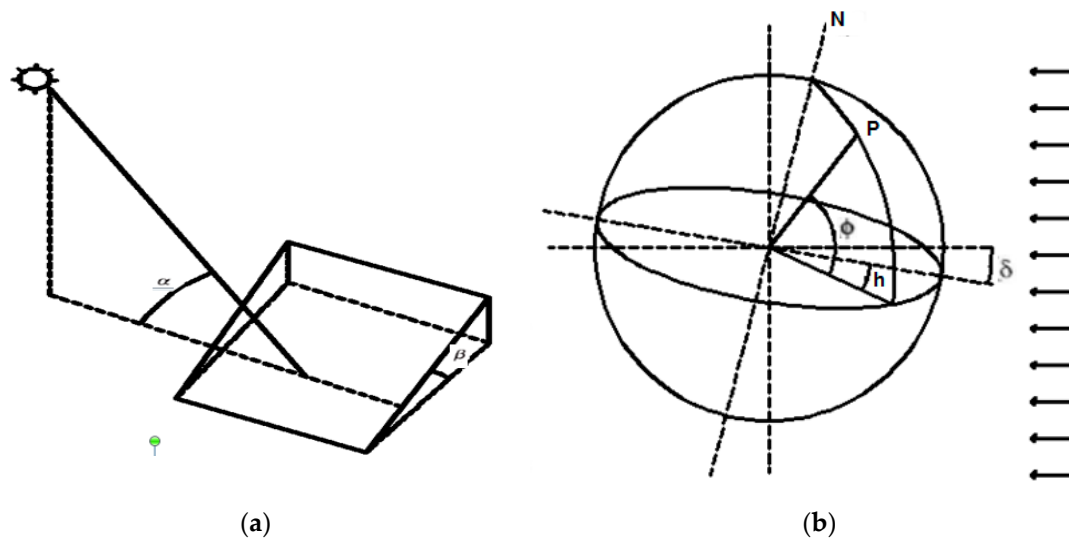

Figure 2. Major solar angles: (a) Tilt angle (β) and Altitude angle (α) (b) Declination angle (δ), Latitude angle (θ), and Hour angle (h).

PVWatts and PVGIS are used to calculate the solar radiation on a horizontal surface with several tilt angles. A case study of 5 kWp of peak power is used to demonstrate the importance of the optimum tilt angles.

3. Literature Review

With a constant orientation facing south, one of the most important factors that affects the performance of a solar panel or collector is its tilt angle since changing the tilt angle changes the amount of solar radiation received by the solar panel or collector.

The performance of solar equipment (i.e., solar collectors for water and air heating, power generation, photovoltaic systems, etc.), is closely related to the inclined angle from the surface that absorbs the light (i.e., with solar equipment placement plane) [19].

The maximum daily energy can be achieved using solar tracking systems. A mechanical device should be added to follow the direction of the sun on its daily sweep. These devices are expensive, need additional energy for operation, and are not always applicable [20,21]; therefore, it is often more practical to direct the surface at an optimum tilt angle, β . Moreover, according to the Palestinian Central Bureau of Statistics, there are no solar tracking projects in Palestine [9].

The optimum tilt angle must be changed daily, monthly, seasonally, semi-annually or annually to maximize the amount of solar radiation received by solar equipment [22].

Solar energy should be given more attention because it is environmentally friendly with no pollution and is a sustainable source of energy. The amount of solar radiation changes with the latitude of the location, the day number through the years, and time of a day. There are still lots of errors during the installation of photovoltaic (PV) panels; significant errors are made by companies and personnel. These errors are wrong PV cell selection, wrong installation spaces and orientation of the PV panels, and also wrong tilt angles [23]. Jiménez-Torres, et al. stated that information of the available solar resource in a particular location on a surface in any position (inclination and orientation) is essential [24]. Mousavi, et al. mentioned that the efficiency of a PV panel can be optimized if the panel is positioned in such a way that it receives the maximum amount of incident solar radiation [25]. Table 1 provides the optimal tilt angle results in different countries of the world.

Table 1. Optimal tilt angle results in different regions of the world.

Location	Tilt Angle (Optimum in Degree)	Latitude	Reference
Damascus	30.56°	33.5°	[26]
Northern Jordan	30° Average 10° Summer 50° Winter	32.5°	[27]
Austria	30°	47.5°	[28]
Germany	45°	51.2°	[28]
Tehran	35.7°	35.7°	[29]
Isfahan	32°	36.5°	[29]
Shiraz	29.4°	29.6°	[29]
Mashhad	36.2°	36.3°	[29]
Tabriz	38°	38.1°	[29]
Pristina	8.9° Summer 25.7° Spring 50.9° Autumn 62.1° Winter 34.7° Average	42.7°	[19]
Cyprus	20° Summer 50° Winter	35.1°	[23]
Montreal	37°	45.5°	[30]
Bordeaux	33°	44.8°	[30]
Cologne	32°	50.9°	[30]
Hong Kong	20°	22.4°	[30]
Rajko	24°	42.1°	[30]
Zahedan	26.70°	29.5°	[30]
Birjand	29.93°	32.9°	[31]
Shraz	25.88°	52.9°	[31]
Tabas	30.16°	33.6°	[31]
Yazd	29.05°	31.9°	[31]
Kerman	23.95°	36.7°	[31]
Assiut	27°	27.2°	[32]
Valencia	31°	39°	[33]
Darussalam	3.3°	4.5°	[34]
Beijing	39.2°	39.9°	[35]
Kunming	27.9°	24.9°	[35]
Shanghai	28°	31.2°	[35]
Guangzhou	22°	23.1°	[35]
Chengdu	23°	30.6°	[35]
Xi'an	30.1°	34.3°	[35]
Yinchuang	38.3°	38.5°	[35]
Shenyang	40.3°	41.8°	[35]
Izmir	0° June 61° December	38.4°	[36]

Table 1. Cont.

Location	Tilt Angle (Optimum in Degree)	Latitude	Reference
Gaza Strip	32.1°	31.5°	[37]
Damascus	33.7°	33.5°	[37]
Beirut	33.8°	33.9°	[37]
Tunis	35.2°	33.9°	[37]
Seville	36.6°	37.4°	[37]
Milan	41.8°	45.5°	[37]
Mu'tah	28.5°	31.7°	[11]
Sanya	−18.1° June 49.9° December	−11.5°	[38]
Shanghai	−7.6° June 61.4° December	31.2°	[38]
Zhengzhou	5.5° June 64.3° December	34.7°	[38]
Harbin	12.6° June 73.7° December	45.8°	[38]
Mohe	16.6° June 80.0° December	52.9°	[38]
Lhasa	−8.9° June 59.9° December	29.7°	[38]

4. Results and Discussion

Since more than 99.7% of the Palestinian people in the West Bank and Gaza Strip are connected to the grid and the majority of the PVs in Palestine are an on-grid solar system in which the grid serves as electricity storage [9], the optimum tilt angle is important to produce the maximum energy generation during the month regardless of the peak load time during the day. The advantages of on-grid PV solar systems include the benefits of getting rid of the difficulties and energy losses associated with energy storage and the peak load consumption vs. the maximum power generation from the PV system.

Considering that most Palestinian communities are connected to the grid and the electricity tariff is constant during the day, the maximum energy production during the year is a vital factor for PV applications. In the present study, the optimum tilt angle is calculated to achieve this maximum energy production.

The daily, monthly, seasonal, semi-annual, and annual optimum tilt angles are calculated using the mathematical model. Also, a monthly, seasonal, semi-annual, and annual optimum tilt angle is calculated for two Palestinian cities, Jerusalem in the West Bank and Gaza city in the Gaza Strip, using PVWatts and PVGIS.

According to PEA regulations, 5 kWp is the maximum allowed peak power PV for houses connected to the grid in Palestine. The annual energy consumption for most residential houses does not exceed 5 kWp PV. Therefore, most houses implement 5 kWp. Moreover, there are no specific standards or specifications for selecting PV modules, but all the PV modules in Palestine are a polycrystalline or monocrystalline type. For that reason, in the present study, 5 kWp will be taken as a case study.

4.1. Part One: Mathematical Model Results

4.1.1. Daily Optimum Tilt Angle

Equations (1), (3), (4), and (5) are used in the MATLAB program to calculate the daily optimum tilt angle $\beta_{opt,d}$ and the daily total extraterrestrial radiation for different latitudes and the main Palestinian

cities. The results obtained from the MATLAB program are tabulated for recommended average days of months in Table 2 for different latitude angles and in Table 3 for the main Palestinian cities and are plotted in Figure 3 for different latitude angles as well as in Figure 4 for Jerusalem and Gaza city. The results show that the daily optimum tilt angle $\beta_{opt,d}$ increases with the increasing latitude of the selected location, and it changes with the number of day which takes the form of a triangular cosine function. Moreover, the optimum daily angle $\beta_{opt,d}$ for 21 March is slightly more than the latitude of the location whereas $\beta_{opt,d}$ for 22 March is slightly less than the latitude of the location. On the other hand, the optimum daily angle $\beta_{opt,d}$ for 20 September is slightly less than the latitude of the location whereas $\beta_{opt,d}$ for 21 September is slightly more than the latitude of the location. The same results were obtained for the main Palestinian cities. Daily optimum tilt angles $\beta_{opt,d}$ for the Palestinian cities are plotted in Figure 3. It can be concluded that negative values for $\beta_{opt,d}$ for the main Palestinian cities were obtained for the time period from $n = 134$ to 210.

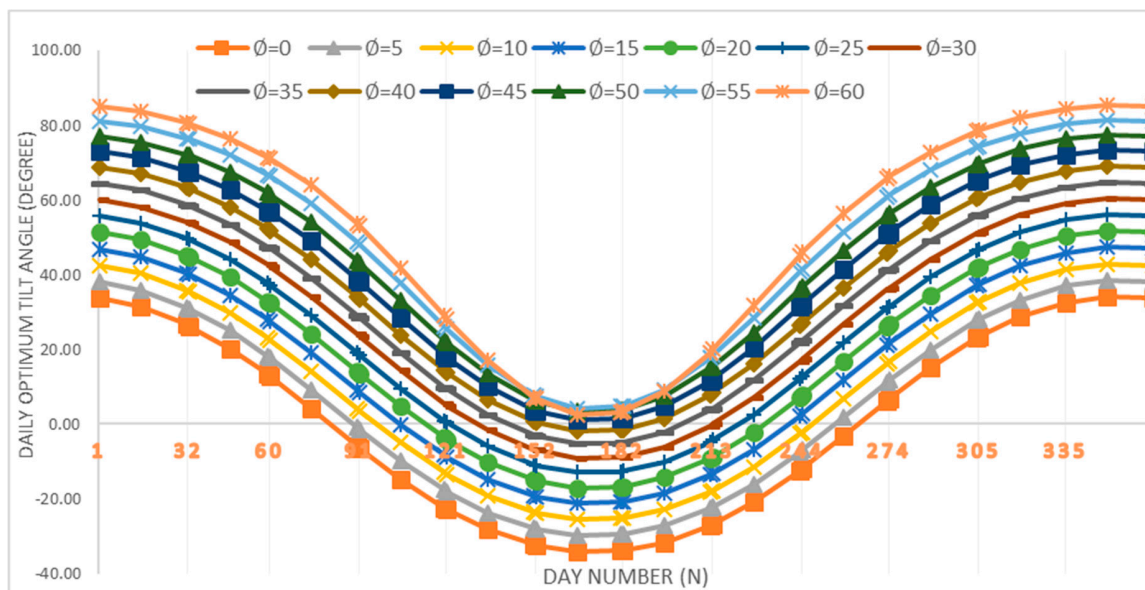

Figure 3. The daily optimum tilt angle $\beta_{opt,d}$ for different latitude angles.

4.1.2. Monthly Optimum Tilt Angle

Equations (1), (3), (4), (6), and (7) are used in the MATLAB program to calculate the monthly optimum tilt angle ($\beta_{opt,m}$) and the monthly total extraterrestrial radiation (I_m) for different latitude angles and for the main Palestinian cities. The results obtained from the MATLAB program are tabulated in Table 4 for different latitude angles and are plotted in Figure 5. It is important to mention that when the optimum monthly tilt angle $\beta_{opt,m}$ is negative for a particular month, then the monthly total extraterrestrial radiation for that month is recalculated by considering that the optimum monthly tilt angle $\beta_{opt,m}$ is equal to zero. The reason for that is to determine if it is worth designing a PV or solar collector with a negative tilt angle. The negative sign means that the solar panel or collector is north facing, while the positive sign means that the solar panel or collector is south facing. From Figure 4, it can be noted that the variation of the monthly optimum tilt angle can be described by a triangular cosine function. The results obtained for the main Palestinian cities are tabulated in Table 5. The $\beta_{opt,m}$ for Jerusalem is plotted in Figure 6. From Table 5 it can be concluded that $\beta_{opt,m}$ increases with increasing latitude angle. Moreover, for latitude 0, $\beta_{opt,m}$ has a negative value from April to September, while for latitudes 5, 10, and 15, $\beta_{opt,m}$ has a negative value from April to August. Also, for latitude 20, $\beta_{opt,m}$ has a negative value for May to August. Additionally, for latitudes 25 and 30, $\beta_{opt,m}$ has a negative value for May to July. For latitude 35, $\beta_{opt,m}$ has a negative value for June and July, and finally, for latitude 40, $\beta_{opt,m}$ has a negative value for only the month of June. The optimum tilt angle in March is slightly higher than the latitude but is slightly lower than the latitude in September.

Table 2. The daily optimum tilt angle $\beta_{opt,d}$ for recommended average days of months for different latitude angles.

Date	Day Number (n)	Latitude (°)												
		0	5	10	15	20	25	30	35	40	45	50	55	60
17 Jan.	17	30.92	35.39	39.88	44.37	48.86	53.34	57.80	62.23	66.61	70.94	75.19	79.34	83.33
16 Febr.	47	19.74	24.51	29.29	34.06	38.83	43.59	48.34	53.08	57.79	62.46	67.09	71.66	76.15
16 Mar.	75	3.64	8.63	13.62	18.61	23.60	28.59	33.58	38.57	43.56	48.55	53.53	58.51	63.48
15 April	105	-14.74	-9.87	-5.01	-0.16	4.69	9.52	14.33	19.11	23.85	28.54	33.15	37.64	41.92
15 May	135	-28.21	-23.67	-19.16	-14.68	-10.26	-5.90	-1.64	2.49	6.44	10.12	13.36	15.87	16.98
11 June	162	-33.83	-29.47	-25.15	-20.89	-16.71	-12.63	-8.69	-4.96	-1.51	1.50	3.81	4.86	3.32
17 July	198	-31.27	-26.83	-22.43	-18.07	-13.77	-9.56	-5.47	-1.54	2.15	5.47	8.23	10.00	9.80
16 Aug.	228	-20.48	-15.73	-10.99	-6.27	-1.58	3.09	7.71	12.27	16.74	21.10	25.27	29.15	32.50
15 Sept.	258	-3.32	1.67	6.66	11.66	16.65	21.64	26.63	31.62	36.61	41.60	46.58	51.56	56.54
15 Oct.	288	15.02	19.88	24.75	29.61	34.47	39.33	44.18	49.01	53.83	58.63	63.40	68.13	72.80
14 Nov.	318	28.37	32.92	37.48	42.04	46.60	51.15	55.68	60.19	64.65	69.06	73.41	77.65	81.76
10 Dec.	344	33.78	38.17	42.57	46.98	51.39	55.78	60.16	64.50	68.79	73.03	77.17	81.20	85.06

Table 3. The daily optimum tilt angle $\beta_{opt,d}$ for recommended average days of months for the main Palestinian cities.

Date	Day Number (n)	City								
		Jenin	Tulkarm	Nablus	Ramallah	Jerusalem	Hebron	Jerico	Gaza	Rafah
17 Jan.	17	59.98	59.85	59.77	59.49	59.38	59.46	59.16	59.16	58.95
16 Febr.	47	50.68	50.53	50.45	50.14	50.03	50.12	49.79	49.79	49.57
16 Mar.	75	36.04	35.89	35.80	35.48	35.36	35.45	35.11	35.11	34.87
15 April	105	16.68	16.54	16.45	16.15	16.03	16.12	15.79	15.79	15.56
15 May	135	0.41	0.29	0.21	-0.05	-0.15	-0.08	-0.36	-0.36	-0.56
11 June	162	-6.82	-6.94	-7.00	-7.25	-7.34	-7.27	-7.52	-7.52	-7.71
17 July	198	-3.51	-3.63	-3.70	-3.95	-4.05	-3.98	-4.25	-4.25	-4.44
16 Aug.	228	9.96	9.82	9.74	9.45	9.34	9.42	9.11	9.11	8.89
15 Sept.	258	29.09	28.94	28.85	28.53	28.41	28.50	28.16	28.16	27.92
15 Oct.	288	46.56	46.41	46.33	46.02	45.90	45.99	45.66	45.66	45.43
14 Nov.	318	57.90	57.77	57.69	57.40	57.29	57.37	57.06	57.06	56.85
10 Dec.	344	62.30	62.17	62.09	61.81	61.71	61.79	61.49	61.49	61.28



Figure 4. The daily optimum tilt angle $\beta_{opt,d}$ for Jerusalem (a) and Gaza City (b).

From Table 5, it can be concluded that for the main cities of Palestine, the monthly optimum tilt angle is between -7.0 (in June) to 62.0 (in December). Moreover, it can be concluded that for the main cities of Palestine, the optimum tilt angle for March is slightly higher than the latitude of the city ($\beta_{opt,m} = 35$), whereas for September it is slightly less than the latitude of the city ($\beta_{opt,m} = 29^\circ$). The yearly extraterrestrial radiation is calculated with $\beta = 0$ and $\beta = \beta_{opt}$ on a daily, monthly, seasonal, semi-annual, and annual basis. The tilt factor is defined as the ratio between the radiation on a tilted surface and the radiation on a horizontal surface in the same period. The tilt factor is calculated on a daily, monthly, seasonal, semi-annual, and annual basis, and the results are shown in Table 6. Moreover, the tilt factors for daily, monthly, seasonal, semi-annual, and annual optimum tilt angles for the main Palestinian cities are presented in Table 7. It can be concluded from Tables 6 and 7 that the tilt factor on a daily basis is almost the same as that on a monthly basis. This means that it worth changing the tilt angle monthly and there is no need to change it daily.

Table 4. The monthly optimum tilt angle $\beta_{opt,m}$ and extraterrestrial radiation I_m in kWh/m² for different latitudes.

Month	Latitude													
		0	5	10	15	20	25	30	35	40	45	50	55	60
January	$\beta_{opt,m}$	30.83	35.31	39.79	44.28	48.77	53.25	57.70	62.13	66.51	70.84	75.08	79.21	83.17
	I_m	363.69	361.52	359.03	356.17	352.82	348.86	344.07	338.15	330.63	320.73	307.07	287.01	254.55
February	$\beta_{opt,m}$	20.30	25.05	29.80	34.55	39.30	44.04	48.76	53.47	58.15	62.79	67.38	71.90	76.32
	I_m	310.38	309.81	309.11	308.27	307.24	305.99	304.45	302.51	300.01	296.71	292.17	285.62	275.49
March	$\beta_{opt,m}$	3.62	8.59	13.57	18.54	23.51	28.48	33.44	38.41	43.36	48.32	53.26	58.19	63.10
	I_m	326.49	326.48	326.45	326.40	326.33	326.25	326.13	325.98	325.77	325.48	325.08	324.50	323.59
April	$\beta_{opt,m}$	−14.83	−9.98	−5.14	−0.30	4.52	9.33	14.11	18.87	23.57	28.22	32.78	37.19	41.35
	I_m	316.49	316.67	316.79	316.83	316.79	316.66	316.41	316.01	315.38	314.44	312.99	310.74	307.03
I_m (negative values of $\beta_{opt,m}$ are considered zero)		305.95	311.88	315.51	316.82	316.79	316.66	316.41	316.01	315.38	314.44	312.99	310.74	307.03
May	$\beta_{opt,m}$	−28.21	−23.68	−19.18	−14.71	−10.29	−5.95	−1.70	2.42	6.35	10.00	13.21	15.66	16.63
	I_m	339.30	340.66	341.82	342.78	343.56	344.11	344.41	344.37	343.87	342.69	340.47	336.54	329.67
I_m (negative values of $\beta_{opt,m}$ are considered zero)		299.00	311.97	322.85	331.55	338.03	342.26	344.26	344.37	343.87	342.69	340.47	336.54	329.67
June	$\beta_{opt,m}$	−33.80	−29.45	−25.13	−20.87	−16.69	−12.61	−8.67	−4.93	−1.48	1.54	3.84	4.90	3.36
	I_m	335.61	337.94	340.02	341.89	343.54	344.98	346.18	347.08	347.59	347.56	346.75	344.86	341.86
I_m (negative values of $\beta_{opt,m}$ are considered zero)		278.87	294.28	307.83	319.46	329.08	336.67	342.22	345.79	347.47	347.56	346.75	344.86	341.86
July	$\beta_{opt,m}$	−31.17	−26.72	−22.32	−17.96	−13.66	−9.45	−5.36	−1.43	2.26	5.58	8.34	10.10	9.85
	I_m	341.46	343.31	344.93	346.34	347.54	348.52	349.23	349.61	349.54	348.82	347.13	343.89	338.27
I_m (negative values of $\beta_{opt,m}$ are considered zero)		292.18	306.63	319.09	329.47	337.71	343.79	347.71	349.50	349.54	348.82	347.13	343.89	338.27
August	$\beta_{opt,m}$	−20.23	−15.49	−10.76	−6.05	−1.36	3.29	7.90	12.45	16.91	21.24	25.38	29.21	32.49
	I_m	327.47	327.95	328.31	328.55	328.67	328.63	328.41	327.94	327.13	325.81	323.70	320.29	314.53
I_m (negative values of $\beta_{opt,m}$ are considered zero)		307.27	316.04	322.54	326.72	328.58	328.63	328.41	327.94	327.13	325.81	323.70	320.29	314.53
September	$\beta_{opt,m}$	−2.95	2.03	7.00	11.98	16.95	21.93	26.89	31.86	36.82	41.77	46.72	51.65	56.56
	I_m	310.24	310.24	310.23	310.21	310.17	310.11	310.04	309.93	309.79	309.58	309.29	308.85	308.16
I_m (negative values of $\beta_{opt,m}$ are considered zero)		309.83	310.24	310.23	310.21	310.17	310.11	310.04	309.93	309.79	309.58	309.29	308.85	308.16
October	$\beta_{opt,m}$	15.41	20.26	25.10	29.94	34.78	39.61	44.43	49.24	54.03	58.79	63.52	68.19	72.79
	I_m	333.11	332.82	332.44	331.96	331.36	330.62	329.70	328.52	326.98	324.94	322.12	318.04	311.76
November	$\beta_{opt,m}$	28.56	33.10	37.65	42.20	46.75	51.29	55.81	60.30	64.75	69.14	73.46	77.68	81.74
	I_m	344.87	343.21	341.30	339.07	336.46	333.34	329.56	324.87	318.91	311.06	300.26	284.49	259.38
December	$\beta_{opt,m}$	33.83	38.21	42.61	47.02	51.43	55.82	60.19	64.53	68.83	73.06	77.20	81.22	85.08
		370.09	367.20	363.94	360.22	355.91	350.83	344.73	337.21	327.66	315.07	297.63	271.71	228.61
Total		4019.18	4017.79	4014.36	4008.69	4000.40	3988.92	3973.31	3952.18	3923.26	3882.89	3824.65	3736.52	3592.91
Total I_m (negative values of $\beta_{opt,m}$ are considered zero)		3841.70	3892.07	3930.32	3956.31	3970.48	3974.02	3967.68	3950.78	3923.15	3882.89	3824.65	3736.52	3592.91

Table 5. The monthly optimum tilt angle $\beta_{opt,m}$ and extraterrestrial radiation I_m in kWh/m² for the main Palestinian cities.

Month	City									
		Jenin	Tulkarm	Nablus	Ramallah	Jerusalem	Jericho	Hebron	Ghaza	Rafah
January	$\beta_{opt,m}$	59.89	59.75	59.67	59.39	59.28	59.36	59.06	59.06	58.85
	I_m	341.32	341.50	341.60	341.97	342.11	342.01	342.40	342.40	342.67
February	$\beta_{opt,m}$	51.08	50.94	50.85	50.55	50.44	50.52	50.20	50.20	49.98
	I_m	303.55	303.61	303.65	303.77	303.81	303.78	303.90	303.90	303.99
March	$\beta_{opt,m}$	35.89	35.74	35.65	35.33	35.21	35.30	34.96	34.96	34.72
	I_m	314.66	314.65	314.66	314.64	314.63	314.64	314.62	314.62	314.60
April	$\beta_{opt,m}$	16.46	16.31	16.23	15.92	15.81	15.89	15.57	15.57	15.34
	I_m	316.24	316.25	316.25	316.28	316.29	316.28	316.31	316.31	316.32
May	$\beta_{opt,m}$	0.35	0.23	0.15	−0.11	−0.21	−0.14	−0.42	−0.42	−0.62
	I_m	344.44	344.44	344.44	344.44	344.44	344.44	344.44	344.44	344.44
I_m (negative values of $\beta_{opt,m}$ are considered zero)		344.44	344.44	344.44	344.44	344.44	344.44	344.43	344.43	344.42
June	$\beta_{opt,m}$	−6.80	−6.91	−6.98	−7.22	−7.31	−7.24	−7.50	−7.50	−7.68
	I_m	346.66	346.63	346.62	346.56	346.53	346.55	346.49	346.49	346.44
I_m (negative values of $\beta_{opt,m}$ are considered zero)		344.22	344.11	344.05	343.81	343.72	343.79	343.52	343.52	343.33
July	$\beta_{opt,m}$	−3.40	−3.52	−3.59	−3.84	−3.94	−3.87	−4.14	−4.14	−4.33
	I_m	349.47	349.45	349.45	349.42	349.41	349.42	349.39	349.39	349.37
I_m (negative values of $\beta_{opt,m}$ are considered zero)		348.85	348.80	348.76	348.63	348.58	348.62	348.48	348.48	348.37
August	$\beta_{opt,m}$	10.15	10.01	9.93	9.64	9.53	9.61	9.30	9.30	9.08
	I_m	328.22	328.23	328.24	328.27	328.28	328.27	328.30	328.30	328.32
September	$\beta_{opt,m}$	29.34	29.19	29.10	28.78	28.66	28.75	28.41	28.41	28.18
	I_m	320.26	320.26	320.27	320.27	320.27	320.27	320.28	320.28	320.28
October	$\beta_{opt,m}$	46.80	46.66	46.57	46.26	46.15	46.23	45.91	45.91	45.68
	I_m	329.15	329.19	329.21	329.28	329.31	329.29	329.37	329.37	329.42
November	$\beta_{opt,m}$	58.02	57.89	57.80	57.52	57.41	57.49	57.18	57.18	56.97
	I_m	327.39	327.52	327.61	327.90	328.01	327.93	328.23	328.23	328.45
December	$\beta_{opt,m}$	62.33	62.20	62.13	61.85	61.74	61.82	61.53	61.53	61.32
	I_m	341.24	341.46	341.60	342.07	342.24	342.11	342.60	342.60	342.95
Total		3962.59	3963.21	3963.58	3964.86	3965.34	3964.99	3966.32	3966.32	3967.24
Total (negative values of $\beta_{opt,m}$ are considered zero)		3959.54	3960.03	3960.33	3961.33	3961.69	3961.43	3962.44	3962.44	3963.12

Table 6. The tilt factor for the daily, monthly, seasonal, semi-annual, and annual optimum tilt angles for different latitudes.

		Latitude												
		0	5	10	15	20	25	30	35	40	45	50	55	60
$\beta = 0$	I	3653.77	3637.62	3596.30	3530.22	3440.05	3326.73	3191.50	3035.91	2861.94	2672.05	2469.50	2258.81	2047.02
$\beta_{opt,d}$	I	4027.36	4025.97	4022.56	4016.93	4008.71	3997.32	3981.83	3960.87	3932.20	3892.18	3834.50	3747.30	3605.51
	F	1.1022	1.1068	1.1185	1.1379	1.1653	1.2016	1.2476	1.3047	1.3740	1.4566	1.5527	1.6590	1.7613
$\beta_{opt,m}$	I	4019.18	4017.79	4014.36	4008.69	4000.40	3988.92	3973.31	3952.18	3923.26	3882.89	3824.65	3736.52	3592.91
	F	1.1000	1.1045	1.1162	1.1355	1.1629	1.1990	1.2450	1.3018	1.3708	1.4531	1.5488	1.6542	1.7552
$\beta_{opt,s}$	I	3958.60	3957.14	3953.53	3947.57	3938.80	3926.72	3910.22	3887.86	3857.20	3814.27	3752.10	3657.37	3501.03
	F	1.0834	1.0878	1.0993	1.1182	1.1450	1.1804	1.2252	1.2806	1.3478	1.4275	1.5194	1.6192	1.7103
$\beta_{opt,sa}$	I	3952.82	3951.37	3947.71	3941.62	3932.68	3920.26	3903.33	3880.34	3848.79	3804.52	3740.23	3641.86	3478.27
	F	1.0818	1.0863	1.0977	1.1165	1.1432	1.1784	1.2230	1.2781	1.3448	1.4238	1.5146	1.6123	1.6992
$\beta_{opt,y}$	I	3653.99	3652.54	3648.73	3642.33	3632.91	3619.77	3601.84	3577.44	3543.91	3496.82	3428.34	3323.42	3148.68
	F	1.0001	1.0041	1.0146	1.0318	1.0561	1.0881	1.1286	1.1784	1.2383	1.3087	1.3883	1.4713	1.5382

I: The yearly extraterrestrial radiation in kWh/m²; F: The tilt factor.

Table 7. The tilt factor for the daily, monthly, seasonal, semi-annual, and yearly optimum tilt angles for the main Palestinian cities.

		City								
		Jenin	Tulkarm	Nablus	Ramallah	Jerusalem	Jericho	Hebron	Gaza	Rafah
$\beta = 0$	I	3117.38	3122.04	3124.83	3134.68	3138.35	3135.60	3145.97	3145.97	3153.24
$\beta_{opt,d}$	I	3972.32	3972.94	3973.31	3974.61	3975.09	3974.73	3976.08	3976.08	3977.02
	F	1.2742	1.2725	1.2715	1.2679	1.2666	1.2676	1.2639	1.2639	1.2613
$\beta_{opt,m}$	I	3962.59	3963.21	3963.58	3964.86	3965.34	3964.99	3966.32	3966.32	3967.24
	F	1.2711	1.2694	1.2684	1.2648	1.2635	1.2645	1.2608	1.2608	1.2581
$\beta_{opt,s}$	I	3900.08	3900.74	3901.14	3902.22	3903.04	3902.66	3904.09	3904.09	3905.09
	F	1.2511	1.2494	1.2484	1.2449	1.2437	1.2446	1.2410	1.2410	1.2384
$\beta_{opt,sa}$	I	3892.90	3893.59	3893.99	3895.42	3895.95	3895.55	3897.04	3897.04	3898.06
	F	1.2488	1.2471	1.2461	1.2427	1.2414	1.2424	1.2387	1.2387	1.2362
$\beta_{opt,y}$	I	3590.777454	3591.50	3591.93	3593.44	3594.00	3593.58	3595.16	3595.16	3596.25
	F	1.1519	1.1504	1.1495	1.1464	1.1452	1.1461	1.1428	1.1428	1.1405

I: The yearly extraterrestrial radiation in kWh/m²; F: The tilt factor.

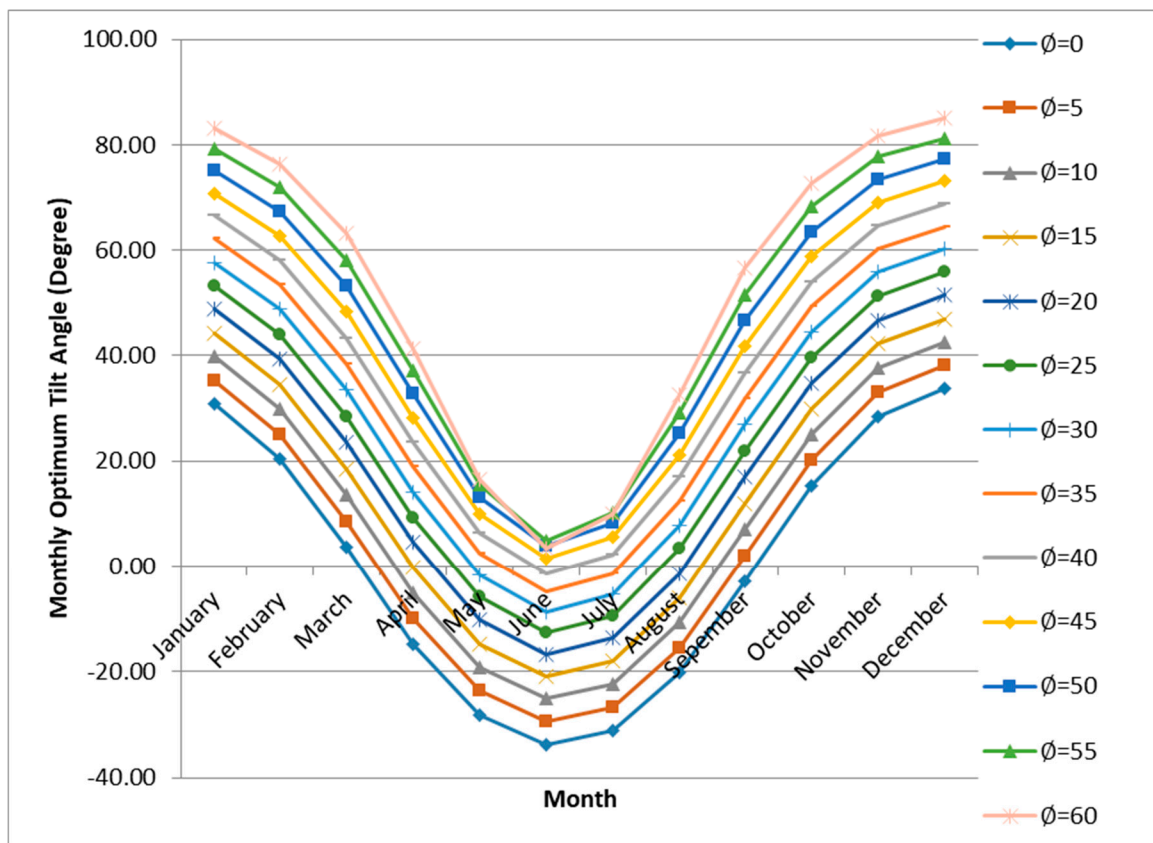

Figure 5. The monthly optimum tilt angle $\beta_{opt,m}$ for different latitudes.

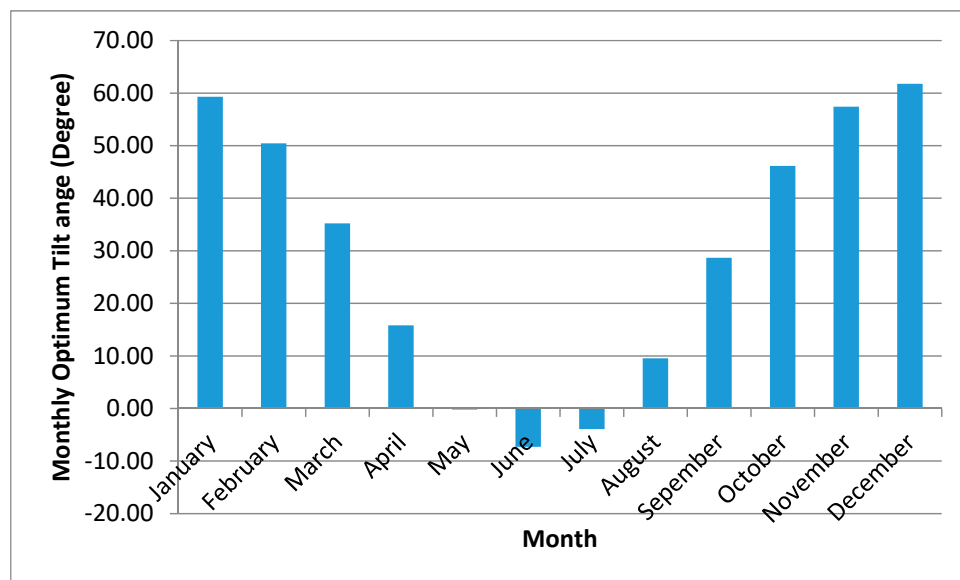

Figure 6. The monthly optimum tilt angle $\beta_{opt,m}$ for Jerusalem, Palestine.

4.1.3. Seasonal Optimum Tilt Angle

It is more practical to change the tilt angle quarterly rather than daily or monthly. Therefore, the tilt angle is changed once every three months. The Palestinian climate can be divided into four seasons: winter (December to February), spring (March to May), summer (June to August), and autumn (September to November). The seasonal optimum tilt angle and the seasonal total extraterrestrial radiation for different latitudes and for the main Palestinian cities are calculated. The seasonal variation

of optimum angle $\beta_{opt,s}$, and the seasonal total extraterrestrial radiation I_s for different latitude angles and for the main Palestinian cities are listed in Tables 8 and 9, respectively. Moreover, the seasonal variation of optimum angle $\beta_{opt,s}$ for different latitude angles and for Jerusalem are plotted in Figures 7 and 8, respectively. From Table 7, it can be shown that for most of the Palestinian cities, the solar radiation on a surface tilted by $\beta_{opt,s}$ is 25% more than the radiation falling on a horizontal surface ($\beta = 0$). Moreover, there is a decrease of less than 2% in the solar radiation on a surface tilted by the seasonal optimum tilt angle compared to a surface tilted by monthly optimum tilt angles for all the main Palestinian cities.

From Table 9, it could be concluded that the minimum and maximum solar radiation at a seasonally optimum tilt angle occurs in autumn and summer, respectively. For Jerusalem, the minimum and maximum radiation values are (947.13 kW h/m²) and (1016.15 kW h/m²), respectively.

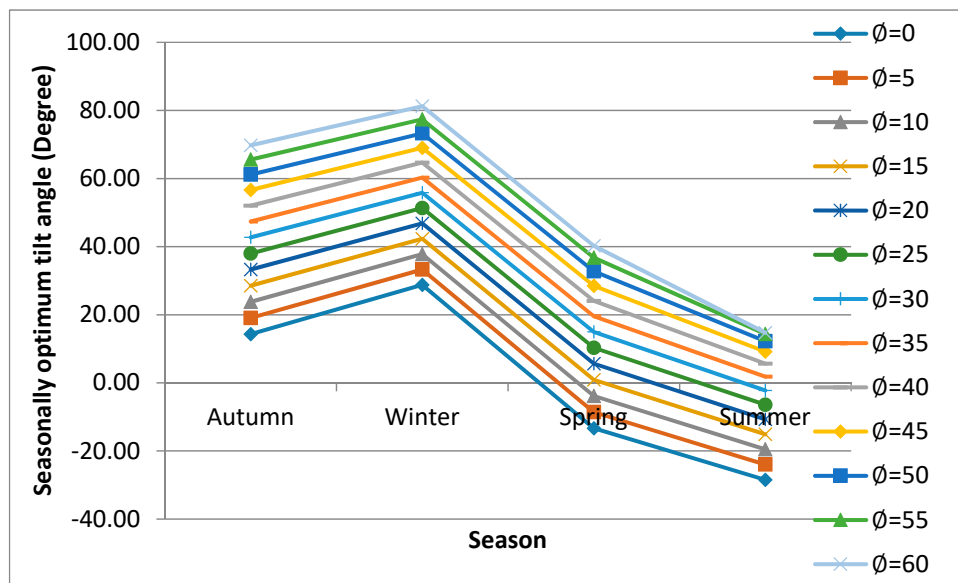

Figure 7. The seasonally optimum tilt angle $\beta_{opt,s}$ for different latitudes.

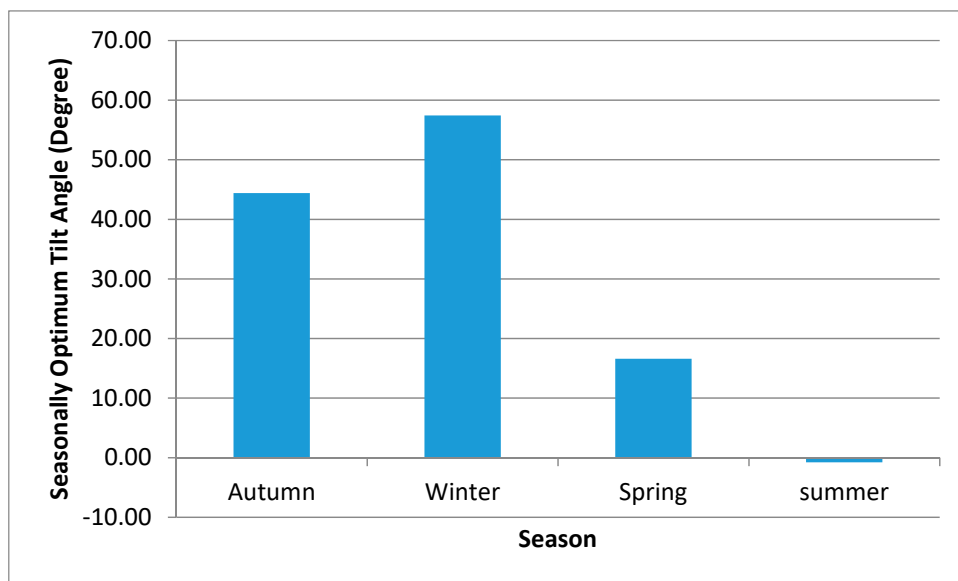

Figure 8. The seasonally optimum tilt angle $\beta_{opt,s}$ for Jerusalem, Palestine.

Table 8. The seasonally optimum tilt angles $\beta_{opt,s}$ and extraterrestrial radiation I_s in kWh/m² for different latitudes.

Season	Latitude													
		0	5	10	15	20	25	30	35	40	45	50	55	60
Autumn	$\beta_{opt,s}$	14.27	19.02	23.78	28.53	33.27	38.00	42.72	47.40	52.05	56.65	61.17	65.56	69.76
	I_s	963.57	962.33	960.72	958.67	956.11	952.89	948.83	943.63	936.81	927.61	914.72	895.64	865.08
Winter	$\beta_{opt,s}$	28.77	33.28	37.80	42.32	46.84	51.35	55.83	60.28	64.69	69.03	73.28	77.39	81.26
	I_s	1039.09	1033.75	1027.58	1020.41	1011.95	1001.94	989.75	974.63	955.33	929.81	894.47	842.27	756.98
Spring	$\beta_{opt,s}$	-13.34	-8.59	-3.84	0.90	5.62	10.31	14.96	19.56	24.09	28.50	32.76	36.74	40.22
	I_s	956.61	957.39	957.84	957.95	957.68	956.95	955.64	953.56	950.40	945.63	938.33	926.76	907.23
Is (negative values of $\beta_{opt,s}$ are considered zero)		930.78	946.66	955.70	957.95	957.68	956.95	955.64	953.56	950.40	945.63	938.33	926.76	907.23
Summer	$\beta_{opt,s}$	-28.49	-23.99	-19.52	-15.10	-10.73	-6.43	-2.24	1.81	5.65	9.18	12.20	14.35	14.72
	I_s	999.32	1003.66	1007.39	1010.53	1013.06	1014.93	1016.00	1016.04	1014.66	1011.22	1004.58	992.69	971.75
Is (negative values of $\beta_{opt,s}$ are considered zero)		878.32	916.95	949.46	975.65	995.37	1008.55	1015.22	1016.04	1014.66	1011.22	1004.58	992.69	971.75
Total		3958.60	3957.14	3953.53	3947.57	3938.80	3926.72	3910.22	3887.86	3857.20	3814.27	3752.10	3657.37	3501.03
Total (negative values of $\beta_{opt,s}$ are considered zero)		3811.76	3859.69	3893.46	3912.69	3921.11	3920.33	3909.45	3887.86	3857.20	3814.27	3752.10	3657.37	3501.03

Table 9. The seasonally optimum tilt angles $\beta_{opt,s}$ and extraterrestrial radiation I_s in kWh/m² for the main Palestinian cities.

Season	City									
		Jenin	Tulkarm	Nablus	Ramallah	Jerusalem	Jericho	Hebron	Gaza	Rafah
Autumn	$\beta_{opt,s}$	45.03	44.88	44.80	44.50	44.39	44.47	44.15	44.15	43.93
	I_s	946.44	946.59	946.68	947.01	947.13	947.04	947.38	947.38	947.61
Winter	$\beta_{opt,s}$	58.03	57.89	57.81	57.53	57.42	57.50	57.20	57.20	56.98
	I_s	982.74	983.19	983.46	984.10	984.76	984.50	985.48	985.48	986.17
Spring	$\beta_{opt,s}$	17.23	17.09	17.01	16.71	16.60	16.69	16.37	16.37	16.15
	I_s	954.73	954.79	954.83	954.96	955.00	954.97	955.10	955.10	955.19
summer	$\beta_{opt,s}$	-0.22	-0.34	-0.42	-0.68	-0.78	-0.70	-0.98	-0.98	-1.18
	I_s	1016.17	1016.16	1016.16	1016.15	1016.15	1016.15	1016.13	1016.13	1016.12
Is (negative values of $\beta_{opt,s}$ are considered zero)		1016.16	1016.15	1016.13	1016.08	1016.05	1016.07	1015.99	1015.99	1015.91
Total		3900.08	3900.74	3901.14	3902.22	3903.04	3902.66	3904.09	3904.09	3905.09
Total (negative values of $\beta_{opt,s}$ are considered zero)		3900.07	3900.72	3901.11	3902.15	3902.95	3902.58	3903.94	3903.94	3904.88

4.1.4. Semi-annually Optimum Tilt Angle

As mention above, some systems require a high efficiency of the solar system during winter. On the other hand, some systems require a high efficiency of the solar system during summer. Therefore, it is worth finding the semi-annual optimum tilt angle during the warm months and the cold months. The tilt angle is changed once in a period of six months. The warm period is from April to September while the cold period is from October to March. The semi-annual variation of optimum angle $\beta_{opt,sa}$ and the semi-annual total extraterrestrial radiation I_{sa} for different latitude angles and for the main Palestinian cities are listed in Tables 10 and 11.

The results presented in Tables 6 and 7 show that the total yearly radiation received by a surface tilted by $\beta_{opt,s}$ on a seasonal basis is almost the same as that received by a surface $\beta_{opt,sa}$ on a semi-annual basis.

4.1.5. Annually Optimum Tilt Angle

The yearly optimum tilt angles were calculated, and the yearly extraterrestrial radiation I_y gained by a surface tilted by the yearly optimum angle was calculated for different latitudes. The results are listed in Table 12. Similarly, for the main Palestinian cities, the results are listed in Table 13. Table 6 shows the tilt factor on a yearly basis. It could be noted that the increased solar energy on a surface tilted by a yearly optimum angle compared to the horizontal surface increases with increasing latitude of the location. The overall yearly increase of solar radiation is about 1.0% for the latitude of 10.0° , increasing up to 53% for the latitude of 60.0° .

From Table 7, it can be concluded that the increase in solar radiation for a surface tilted by a daily optimum angle relative to a surface tilted by a fixed yearly optimum angle is about 10.6% for most of the Palestinian cities, while the increase in solar radiation for a surface tilted by a monthly optimum angle is about 10.4%. This means that changing the angle each month gives approximately the same increase in solar radiation by changing it daily. Moreover, the increase in solar radiation for a surface tilted by a seasonally optimum angle relative to a surface tilted by a fixed yearly optimum angle is about 8.6% for most of the Palestinian cities, while the increase in solar radiation for a surface tilted by a semi-annually optimum tilt angle is about 8.4%. This means that changing the angle semi-annually gives approximately the same increase in solar radiation by changing it seasonally.

Finally, it can be shown that it is so important to tilt the collector or the panel with the optimum tilt angle. It is clear that for most Palestinian cities, the daily and monthly tilt angle energy gains reached 27% with respect to the horizontal surface, whereas the seasonal and semi-annual tilt angle energy gains reached 25%. Lastly, the energy gains for the yearly tilt angle were about 15% for most of the Palestinian cities.

4.2. Part Two: Results Based on PVWatts and PVGIS

Part one results showed a small variation between Palestinian cities by using either the optimum tilt angles as one approach or the amount of total radiation as the second approach. For that reason, two major cities in Palestine are selected; the first city is Jerusalem which is located in the West Bank and the other is Gaza city located in the Gaza Strip.

Jerusalem is located in the West Bank where there is a meteorological station; PVWatts depends on this station for global radiation. In Gaza city which is located in the Gaza Strip, the nearest meteorological station is Be'Er Sheva.

The reason for using PVWatts and PVGIS for this comparison is that PVWatts uses solar resource data collected from a ground station whereas PVGIS uses data produced from satellite images.

PVWatts does not estimate the optimum tilt angle, whereas PVGIS estimates only the yearly optimum tilt angle. Therefore, the optimum tilt angle for each city and particular time period is found by estimating PV outputs with various tilt angles for this particular period so the optimum tilt angle giving the maximum output is found.

Table 10. The semi-annual optimum tilt angle $\beta_{opt,sa}$ and extraterrestrial radiation I_{sa} in kWh/m² for different latitudes.

Period		Latitude												
		0	5	10	15	20	25	30	35	40	45	50	55	60
Warm period (April to September)	$\beta_{opt,sa}$	-22.26	-17.65	-13.05	-8.48	-3.95	0.52	4.93	9.23	13.40	17.34	20.95	23.97	25.82
	I_{sa}	1937.51	1942.25	1946.01	1948.80	1950.53	1951.05	1950.06	1947.10	1941.36	1931.50	1915.14	1887.75	1839.69
Isa (negative values of $\beta_{opt,sa}$ are considered zero)		1793.09	1850.84	1895.74	1927.47	1945.89	1951.05	1950.06	1947.10	1941.36	1931.50	1915.14	1887.75	1839.69
Cold period (October to March)	$\beta_{opt,sa}$	22.59	27.21	31.84	36.46	41.08	45.68	50.26	54.81	59.31	63.75	68.09	72.28	76.20
	I_{sa}	2015.31	2009.12	2001.70	1992.82	1982.15	1969.21	1953.27	1933.24	1907.43	1873.02	1825.09	1754.11	1638.58
Total		3952.82	3951.37	3947.71	3941.62	3932.68	3920.26	3903.33	3880.34	3848.79	3804.52	3740.23	3641.86	3478.27
Total (negative values of $\beta_{opt,sa}$ are considered zero)		3808.40	3859.96	3897.44	3920.29	3928.04	3920.26	3903.33	3880.34	3848.79	3804.52	3740.23	3641.86	3478.27

Table 11. The semi-annual optimum tilts angle $\beta_{opt,sa}$ and extraterrestrial radiation I_{sa} in kWh/m² for the main Palestinian cities.

Period		City								
		Jenin	Tulkarm	Nablus	Ramallah	Jerusalem	Jericho	Hebron	Gaza	Rafah
Warm period (April to September)	$\beta_{opt,sa}$	7.06	6.93	6.86	6.58	6.48	6.55	6.26	6.26	6.05
	I_{sa}	1948.89	1948.98	1949.03	1949.20	1949.27	1949.22	1949.40	1949.40	1949.51
Cold period (October to March)	$\beta_{opt,sa}$	52.51	52.37	52.29	52.00	51.89	51.97	51.66	51.66	51.44
	I_{sa}	1944.01	1944.61	1944.96	1946.22	1946.68	1946.33	1947.64	1947.64	1948.55
Total		3892.90	3893.59	3893.99	3895.42	3895.95	3895.55	3897.04	3897.04	3898.06

Table 12. The annual optimum tilt angle $\beta_{opt,y}$ and extraterrestrial radiation I_y in kWh/m² for a different latitude.

	Latitude												
	0	5	10	15	20	25	30	35	40	45	50	55	60
$\beta_{opt,y}$	0.63	5.18	9.73	14.25	18.75	23.21	27.62	31.94	36.14	40.17	43.92	47.18	49.45
I_y	3653.99	3652.54	3648.73	3642.33	3632.91	3619.77	3601.84	3577.44	3543.91	3496.82	3428.34	3323.42	3148.68

Table 13. The annual optimum tilt angle $\beta_{opt,y}$ and extraterrestrial radiation I_y in kWh/m² for the main Palestinian cities.

	City								
	Jenin	Tulkarm	Nablus	Ramallah	Jerusalem	Jericho	Hebron	Gaza	Rafah
$\beta_{opt,y}$	29.75	29.62	29.55	29.27	29.17	29.24	28.95	28.95	28.74
I_y	3590.78	3591.50	3591.93	3593.44	3594.00	3593.58	3595.16	3595.16	3596.25

The optimum tilt angles for two Palestinian cities, Jerusalem and Gaza city, are shown in Table 14 for the different time periods. Figures 9 and 10 show a comparison of monthly and seasonal optimum tilt angles for Jerusalem and Gaza using PVWatts and PVGIS with those calculated by the mathematical model. It is clear that the results are very close. This means that the mathematical model in part one gives accurate results for the optimum tilt angle.

Table 14. A comparison of monthly, seasonal, semi-annual, and yearly optimum tilt angles (degrees) for Jerusalem and Gaza City based on PVWatts and PVGIS with those calculated in the present work.

Period	Jerusalem			Gaza City		
	Mathematical Model	PVGIS	PVWatts	Mathematical Model	PVGIS	PVWatts
Yearly Optimum Tilt Angle						
	29	28	26	29	28	29
Semi-annual optimum tilt angle						
Warm period (April to September)	6	9	11	6	9	12
Cold period (October to March)	52	51	46	52	50	50
Seasonal optimum tilt angle						
Autumn	44	43	41	44	43	43
Winter	57	56	51	57	55	56
Spring	17	20	17	16	19	19
Summer	−1	3	7	−1	0	5
Monthly optimum tilt angle						
January	59	58	55	59	59	59
February	50	50	49	50	50	50
March	35	35	32	35	35	35
April	16	16	17	16	17	16
May	0	1	4	0	2	6
June	−7	0	0	−8	0	0
July	−4	0	2	−4	0	0
August	10	11	14	9	10	12
September	29	29	29	28	29	29
October	46	46	46	46	46	46
November	57	57	56	57	57	57
December	62	61	56	62	61	61

It worth mentioning that PVGIS and PVWatts do not estimate a negative tilt angle. This means the minimum tilt angle is zero (horizontal surface).

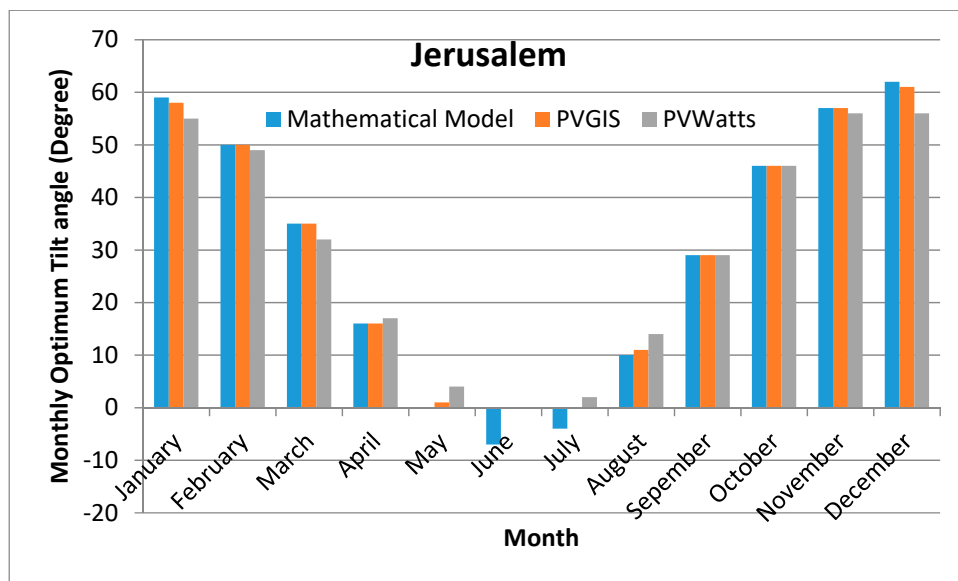

(a)

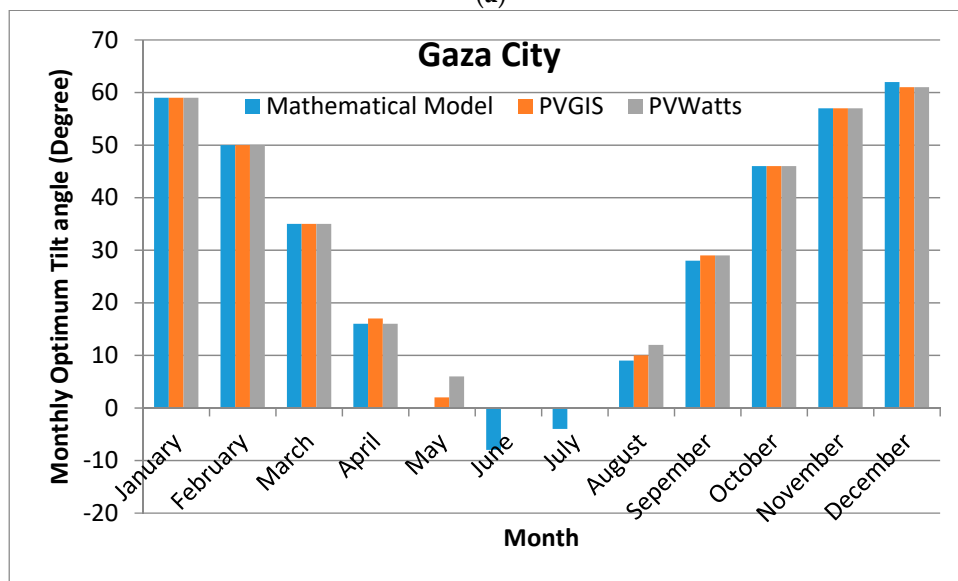

(b)

Figure 9. A comparison of monthly optimum tilt angles based on PVWatts and PVGIS with those calculated by the mathematical model: Jerusalem (a), Gaza City (b).

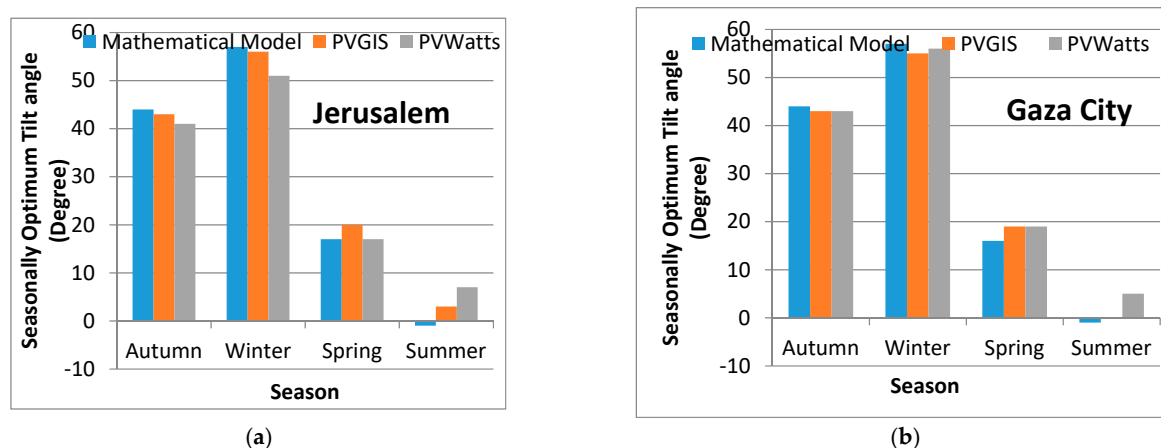

Figure 10. A comparison of seasonal optimum tilt angles based on PVWatts and PVGIS with those calculated by the mathematical model: Jerusalem (a), Gaza city (b).

5. Case Studies of two Palestinian Cities

To perform this study, the cities of Jerusalem and Gaza city have been selected. Jerusalem is located in the West Bank whereas Gaza city is located in the Gaza Strip.

PVGIS and PVWatts are used to calculate the energy generated in the two locations mentioned above for a photovoltaic composed of a monocrystalline silicon module with 5 kWp of peak power installed. The comparison is made with five configurations: a system with a PV in a horizontal position and annual, semi-annual, seasonal, and monthly optimum tilt angle positions. In this way, the differences and gains due to the optimal position can be quantitatively verified.

Firstly, PVGIS and PVWatts are used to obtain the monthly average global radiation for Jerusalem and Gaza. Tables 15 and 16 show the monthly average global radiation in Jerusalem and Gaza city for different tilt angles (β).

Table 15. The monthly average global radiation in Jerusalem for different tilt angles (β).

Months	Monthly Average Radiation (kWh/m ² /day) for Jerusalem											
	PVGIS						PVWatts					
	β (0°)	β (28°)	β (29°)	β (30°)	β (60°)	β (90°)	β (0°)	β (26°)	β (29°)	β (30°)	β (60°)	β (90°)
January	3.07	4.35	4.39	4.42	4.84	4.16	2.68	3.57	3.64	3.66	3.88	3.27
February	3.86	4.96	4.96	5.00	5.11	4.11	3.57	4.49	4.56	4.57	4.61	3.66
March	5.19	6.00	6.00	6.00	5.58	3.97	4.81	5.43	5.45	5.45	4.95	3.44
April	6.40	6.60	6.57	6.57	5.43	3.20	6.13	6.37	6.33	6.32	5.16	2.98
May	7.19	6.81	6.77	6.74	4.97	2.36	7.17	6.93	6.83	6.79	5.01	2.43
June	8.17	7.40	7.33	7.27	5.00	1.91	8.07	7.53	7.38	7.33	5.03	2.08
July	8.06	7.42	7.39	7.32	5.16	2.12	8.01	7.61	7.47	7.43	5.22	2.23
August	7.39	7.39	7.35	7.35	5.74	2.98	7.28	7.45	7.39	7.36	5.79	3.04
September	6.20	6.97	6.97	6.97	6.20	4.07	6.26	7.08	7.1	7.1	6.32	4.13
October	4.65	5.84	5.87	5.90	5.87	4.52	4.69	5.86	5.94	5.96	5.88	4.49
November	3.53	4.97	5.00	5.03	5.47	4.63	3.34	4.54	4.63	4.66	4.94	4.12
December	2.86	4.26	4.29	4.32	4.87	4.29	2.45	3.38	3.46	3.48	3.77	3.24
Annual Average	5.55	6.08	6.07	6.07	5.35	3.53	5.37	5.85	5.85	5.84	5.05	3.26

The maximum radiation value is reached in the horizontal PV in June for the two cities and using PVGIS and PVWatts, whereas the maximum monthly radiation for a PV tilted at an annual optimum tilt angle is achieved in July. It can be concluded that the annual average radiation (kWh/m²/day) for Gaza city is slightly higher than that for Jerusalem. Moreover, the annual average radiation (kWh/m²/day)

calculated by using PVGIS is (6.12) slightly higher than the annual average radiation (5.96) calculated using PVWatts.

Table 16. The monthly average global radiation in Gaza city for different tilt angles (β).

Months	Monthly Average Radiation (kWh/m ² /day) for Gaza city										
	PVGIS						PVWatts				
	β (0°)	β (28°)	β (29°)	β (30°)	β (60°)	β (90°)	β (0°)	β (29°)	β (30°)	β (60°)	β (90°)
January	3.02	4.29	4.32	4.35	4.77	4.10	3.05	4.53	4.57	5.04	4.34
February	3.96	5.11	5.14	5.18	5.29	4.25	3.72	4.93	4.96	5.07	4.04
March	5.32	6.19	6.19	6.19	5.77	4.06	4.97	5.8	5.81	5.37	3.76
April	6.53	6.77	6.73	6.73	5.53	3.22	6.19	6.4	6.39	5.21	3.01
May	7.29	6.90	6.87	6.84	5.03	2.33	7.08	6.74	6.7	4.93	2.39
June	8.07	7.30	7.23	7.20	4.90	1.86	7.84	7.11	7.06	4.85	2.04
July	7.94	7.32	7.26	7.23	5.06	2.07	7.55	7.00	6.95	4.93	2.2
August	7.32	7.32	7.29	7.26	5.68	2.92	7.03	7.06	7.03	5.51	2.92
September	6.17	6.90	6.93	6.93	6.17	4.03	5.84	6.58	6.58	5.84	3.82
October	4.81	6.10	6.13	6.13	6.13	4.71	4.56	5.89	5.91	5.91	4.54
November	3.50	4.97	5.00	5.03	5.47	4.63	3.63	5.08	5.11	5.44	4.54
December	2.89	4.32	4.39	4.42	4.97	4.35	2.84	4.43	4.47	5.05	4.44
Annual Average	5.57	6.12	6.12	6.12	5.40	3.55	5.36	5.96	5.96	5.26	3.50

It can be noticed that annual average radiation (kWh/m²/day) for a PV tilted at the yearly optimum tilt angle calculated by the mathematical model suggested in this study and the annual average radiation (kWh/m²/day) for a PV tilted at the yearly optimum tilt angle calculated by PVGIS and PVWatts is very similar. For example, the yearly optimum tilt angle calculated by the suggested mathematical model in this study for Jerusalem is 29° and that when using PVWatts is 26° as shown in Table 15. However, the annual average radiation is the same (5.85 kWh/m²/day) as shown in Table 16.

In another example, the yearly optimum tilt angle calculated by the suggested mathematical model in this study for Gaza is 29° and that when using PVGIS is 28° as shown in Table 16. However, the annual average radiation is the same (6.12 kWh/m²/day) as shown in Table 16.

For the city of Jerusalem and using PVGIS, it is observed that the annual average radiation on a horizontal plane is (5.55 kWh/m²/day) as shown in Table 15 while for 28° (PVGIS yearly optimum tilt angle), it is (6.08 kWh/m²/day) as shown in Table 15, and for 29° (yearly optimum tilt angle obtained from the mathematical model), it is (6.07 kWh/m²/day) as shown in Table 15. It can be concluded that increasing the tilt angle more than the optimal value also leads to a decrease in the annual average radiation, obtaining only (3.53 kWh/m²/day) as shown in Table 16 for a vertical plane β (90°).

For the city of Gaza and using PVWatts, it is observed that the annual average radiation on a horizontal plane is (5.36 kWh/m²/day) as shown in Table 16 while for 29° (the same yearly optimum tilt angle using PVWatts and the mathematical model), it is (5.96 kWh/m²/day) as shown in Table 16. For a vertical plane, it is only (3.5 kWh/m²/day) as shown in Table 16.

For a photovoltaic system with a peak power of (5 kWh) in Jerusalem, the following monthly values are calculated using PVGIS and PVWatts.

Tables 17 and 18 show the monthly energy generated in Jerusalem and Gaza city by a 5 kWh system.

Figures 11 and 12 show the monthly energy generated in Jerusalem and Gaza city by a 5 kWh system.

It can be concluded that the energy generated by a PV system fixed at a yearly optimum tilt angle is more than 10% higher than that for a horizontal PV system. Moreover, the energy generated by a PV system fixed at semi-annual tilt angle gives 15% more energy gain as shown in Table 19.

Table 17. Monthly energy generated by a 5 kWh system in Jerusalem.

Months	Monthly Energy Generated (kWh) For Jerusalem									
	PVGIS					PVWatts				
	$\beta = 0$	$\beta_{opt,y}$	$\beta_{opt,sa}$	$\beta_{opt,s}$	$\beta_{opt,m}$	$\beta = 0$	$\beta_{opt,y}$	$\beta_{opt,sa}$	$\beta_{opt,s}$	$\beta_{opt,m}$
January	382	553	612	614	617	339	457	496	498	498
February	431	556	584	580	584	410	517	540	539	540
March	632	726	708	712	730	602	676	663	663	679
April	732	751	752	758	758	721	746	746	751	751
May	832	782	830	810	833	844	813	847	838	848
June	896	804	881	893	896	918	853	909	915	918
July	908	832	899	907	908	933	883	931	935	935
August	841	837	856	848	857	845	861	869	864	872
September	697	776	738	761	776	706	793	759	784	795
October	548	689	709	713	713	557	692	718	718	718
November	413	592	651	640	653	393	534	580	573	582
December	352	539	611	616	617	306	426	469	473	474
Annual Sum	7664	8437	8831	8852	8942	7574	8251	8527	8551	8610
Percentage gain with respect to a horizontal plane (%)		10.1	15.2	15.5	16.7		8.9	12.6	12.9	13.7

Table 18. Monthly energy generated by a 5 kWh system in Gaza City.

Months	Monthly Energy Generated (kWh) for Gaza City									
	PVGIS					PVWatts				
	$\beta = 0$	$\beta_{opt,y}$	$\beta_{opt,sa}$	$\beta_{opt,s}$	$\beta_{opt,m}$	$\beta = 0$	$\beta_{opt,y}$	$\beta_{opt,sa}$	$\beta_{opt,s}$	$\beta_{opt,m}$
January	369	535	592	594	594	371	557	614	618	618
February	438	571	601	598	601	408	540	565	561	565
March	656	758	743	740	763	610	709	692	691	712
April	771	794	793	801	801	703	723	729	732	732
May	879	827	878	859	880	820	776	821	809	824
June	926	833	912	926	926	867	784	852	864	867
July	935	857	926	935	935	861	795	853	861	861
August	857	851	871	857	872	796	796	816	808	816
September	704	785	745	769	785	648	726	698	710	726
October	568	722	747	749	749	527	679	699	701	701
November	406	583	641	631	644	418	586	629	622	629
December	347	536	608	614	615	342	543	610	617	618
Annual Sum	7856	8652	9057	9073	9165	7371	8214	8578	8594	8669
Percentage gain with respect to a horizontal plane (%)		10.1	15.3	15.5	16.7		11.4	16.4	16.6	17.6

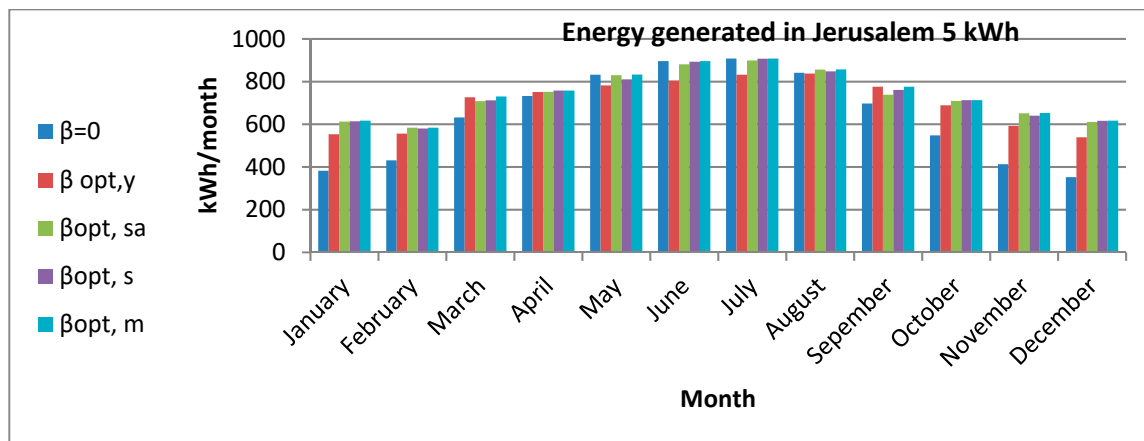

Figure 11. Monthly energy generated in Jerusalem by a 5 kWh system.

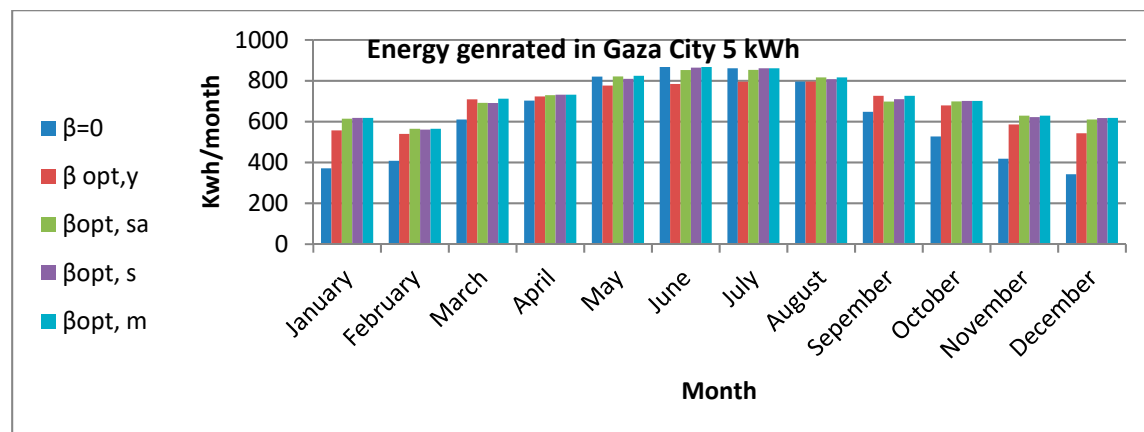

Figure 12. Monthly energy generated in Gaza city by a 5 kWh system.

It can be noted that a slight energy gain can be obtained by a seasonally optimum tilt angle compared to a semi-annual optimum tilt angle.

Changing the tilt angle 12 times through the year to obtain the monthly optimum tilt leads to about 17% energy gain with respect to a horizontal PV system as shown in Tables 17 and 18. This means that it is worth fixing the PV system at the yearly optimum tilt angle and changing the optimum tilt angle at least two times per year.

6. Comparison of the Present Work with Previously Published Papers

Firstly, a comparison of the present mathematical model was made with H. Darhmaoui and D. Lahjouji [37]. They used a mathematical model to estimate the solar radiation on a tilted surface at 35 sites in different countries of the Mediterranean region. They found the yearly optimum tilt angle for Gaza city to be 32° , whereas in the present mathematical model the value was 29° .

Secondly, a comparison of the present mathematical model with the models of Nijegorodor et al. [39] and P. Talebizadeh et al. [19] was made. Nijegorodor et al. and P. Talebizadeh et al. suggested monthly and yearly equations for calculating monthly and yearly optimum tilt angles. Monthly and yearly equations were used to estimate the optimum monthly and yearly tilt angles for Jerusalem, and a comparison of these angles with those obtained by the present mathematical model is given in Table 19 and is plotted in Figure 13. Results show that the yearly optimum tilt angles are very close while the monthly optimum tilt angle is slightly different.

Table 19. A comparison of monthly and yearly tilt angles for Jerusalem based on Nijegorodor et al. and P. Talebizadeh et al. with the values calculated in the present mathematical model.

Month		Present Mathematical Model	Nijegorodor et al. [39]	P. Talebizadeh et al. [31]
January	$\beta_{opt,m}$	59.28	57.28	56.10
February	$\beta_{opt,m}$	50.44	47.83	47.30
March	$\beta_{opt,m}$	35.21	35.78	31.59
April	$\beta_{opt,m}$	15.81	21.78	16.40
May	$\beta_{opt,m}$	-0.21	5.56	2.74
June	$\beta_{opt,m}$	-7.31	-6.35	-2.17
July	$\beta_{opt,m}$	-3.94	-1.72	0.16
August	$\beta_{opt,m}$	9.53	13.83	12.09
September	$\beta_{opt,m}$	28.66	29.78	28.70
October	$\beta_{opt,m}$	46.15	43.78	44.03
November	$\beta_{opt,m}$	57.41	54.56	54.89
December	$\beta_{opt,m}$	61.74	61.65	58.54
year	$\beta_{opt,m}$	29.17	30.31	28.83

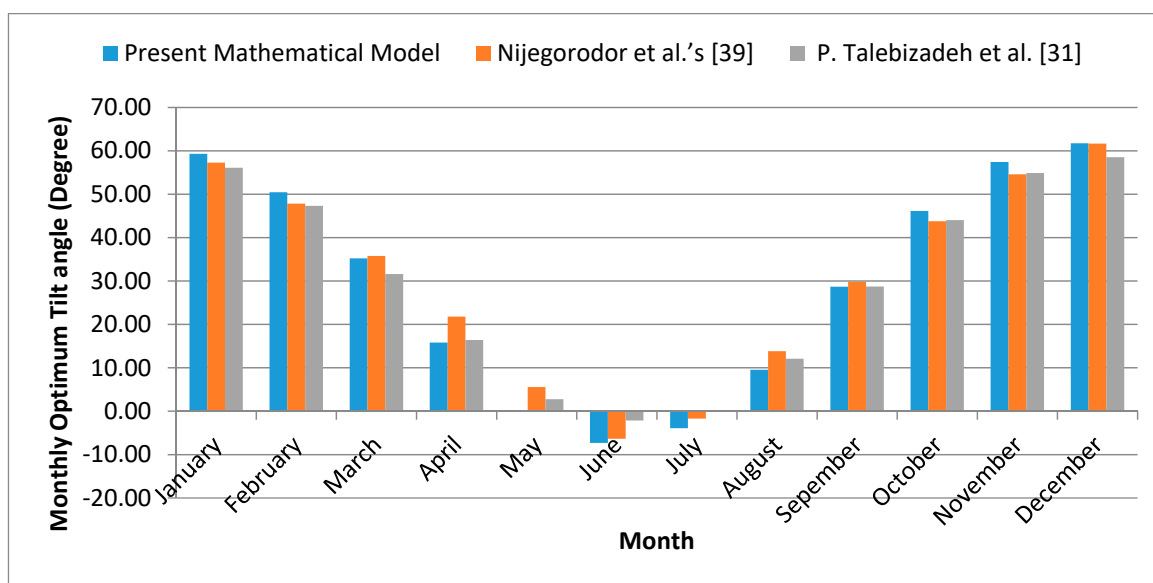

Figure 13. Comparison of monthly and yearly tilt angles for Jerusalem based on Nijegorodor et al [39]. and P. Talebizadeh et al [31], with values calculated in the present mathematical model.

7. Conclusions

It is clear that the suggested mathematical model gives accurate results for the optimum tilt angle compared to PVWatts and PVGIS. It is worth designing a solar panel or collector with a negative tilt angle for locations at latitudes from 0° to 30°. For all the Palestinian cities, there is no need to design a collector with a negative tilt angle. Compared to a horizontal surface, yearly, semi-annual, seasonal, and monthly adjustments of solar panels in the main Palestinian cities will generate approximately 10%, 15%, 15%, and 17% more energy, respectively, whereas compared to the fixed optimum yearly tilt angle, monthly adjustments of the solar panels in the main Palestinian cities can generate about 6% more energy. Seasonal and semi-annual adjustments can generate about 5% more solar energy. This shows that solar panels or collectors have to be adjusted monthly or semi-annually. For the

roof top-solar PV rated power (5 kWp) which was taken as a case study for the present work, it is convenient to change it semi-annually. Moreover, this proves the importance of an accurate tilt angle for the solar panels or collectors. If a supporting structure for the PV is well designed, then the solar PV can be easily adjusted in a limited time and can be performed by an unqualified person.

The daily optimum tilt angle for the main Palestinian cities ranges from -8.0° in June to 62° in December. The monthly optimum tilt angle for the main Palestinian cities throughout the year is between -7.0° in June and 62° in December. The seasonal optimum tilt angle for the main Palestinian cities throughout the year is between a minimum value of -1.0° in June and a maximum value of 58° in December. Moreover, the optimum tilt angle for autumn is more than the latitude of the city (44°) and for spring, less than the latitude of the city (17°). The semi-annual optimum tilt angle for the main Palestinian cities throughout the year is between 7.0° in the warm period (April to September) and 52° in the cold period (October to March).

The yearly average radiation in Jerusalem using PVGIS is ($5.55 \text{ kWh/m}^2/\text{day}$) based on a horizontal surface while using a panel tilted with a yearly optimum tilt angle, the value is ($6.08 \text{ kWh/m}^2/\text{day}$). The yearly average radiation in Jerusalem using PVWatts is ($5.37 \text{ kWh/m}^2/\text{day}$) based on a horizontal surface while using a panel tilted with a yearly optimum tilt angle, the value is ($5.85 \text{ kWh/m}^2/\text{day}$). The yearly average radiation in Gaza using PVGIS is ($5.57 \text{ kWh/m}^2/\text{day}$) based on a horizontal surface while using a panel tilting with a yearly optimum tilt angle, the value is ($6.12 \text{ kWh/m}^2/\text{day}$). The yearly average radiation in Jerusalem using PVWatts is ($5.36 \text{ kWh/m}^2/\text{day}$) based on a horizontal surface while using a panel tilted with a yearly optimum tilt angle, the value is ($5.96 \text{ kWh/m}^2/\text{day}$). It is clear that the PVGIS results are slightly higher than the PVWatts results for Palestinian cities.

The yearly optimum tilt angle for most Palestinian cities is about 29° . It can be concluded that the monthly optimum tilt angle for a particular month is approximately the average of the daily optimum tilt angle for the particular month, while the seasonal, semi-annual, and yearly optimum tilt angles are approximately the average monthly optimum tilt angle for that particular period.

Author Contributions: R.A., and A.J. conceived of the idea and wrote the article; A.J. and R.A. analyzed the data; R.A., A.J., and S.A.-F. wrote the paper. F.M.-A. supervised the research and revised the manuscript. All authors contributed to the structure and aims of the manuscript, paper drafting, editing, and review. All authors have read and approved the final manuscript.

Funding: This research received no external funding.

Acknowledgments: The authors would like to acknowledge the Palestinian Central Bureau of Statistics (Eng. Haitham Zeidan) and An Najah National University for facilitating this research.

Conflicts of Interest: The authors declare no conflict of interest.

Abbreviations

δ	Declination angle
n	The day number
θ	Latitude angle
h	Hour angle
α	The altitude angle
h_s	The hour angles at sunrise and sunset
β	The tilt angle
ASHRAE	American Society of Heating, Refrigerating and Air-Conditioning Engineers
I_d	Daily extraterrestrial radiation
I_p	Extraterrestrial radiation for a particular period
PV	Photovoltaic
$\beta_{opt,d}$	Daily optimum tilt angle
$\beta_{opt,m}$	Monthly optimum tilt angle
I_m	Monthly total extraterrestrial radiation
F	The tilt factor
$\beta_{opt,s}$	Seasonally optimum tilt angle

I_s	Seasonal extraterrestrial radiation
$\beta_{opt,sa}$	Semi-annual optimum angle
I_{sa}	Semi-annual extraterrestrial radiation
I_y	The yearly extra-terrestrial radiation
$\beta_{opt,y}$	The annual optimum tilt angle
PEA	Palestinian Energy Authority
PCBS	Palestinian Central Bureau of Statistics
NREL	National Renewable Energy Laboratory -USA

References

- Juaidi, A.; Montoya, F.G.; Ibrik, I.H.; Manzano-Agugliaro, F. An overview of renewable energy potential in Palestine. *Renew. Sust. Energ. Rev.* **2016**, *65*, 943–960. [CrossRef]
- Mohammed, M. (Palestine Investment Fund, Palestine). Palestine's Oil and Gas Resources: Prospects and Challenges. 2014. Available online: <http://thisweekinpalestine.com/wp-content/uploads/2014/07/Palestine%E2%80%99s-Oil-and-Gas.pdf> (accessed on 28 January 2020).
- European Joint Strategy in Support of Palestine. *Towards a Democratic and Accountable Palestinian state (2017–2020)—European Joint Programming*; European Union: Brussels, Belgium; p. 64. Available online: https://eeas.europa.eu/sites/eeas/files/final_-_european_joint_strategy_english.pdf (accessed on 28 January 2020).
- West Bank and Gaza Energy Efficiency Action Plan 2020–2030. Final Report, ACS19044; World Bank Group: Energy and Extractives. Energy Sector Management Program (ESMAP): Gaza, Palestine, 2016; p. 67. Available online: <http://documents.worldbank.org/curated/en/851371475046203328/pdf/ACS19044-REPLACEMENT-PUBLIC-FINAL-REPORT-P147961-WBGaza-Energy-Efficiency-Action-Plan.pdf> (accessed on 30 January 2020).
- Ibrik, I.H.; Mahmoud, M.M. Energy efficiency improvement procedures and audit results of electrical, thermal and solar applications in Palestine. *Energy Policy* **2005**, *33*, 651–658. [CrossRef]
- Hamed, T.A.; Flamm, H.; Azraq, M. Renewable energy in the Palestinian Territories: Opportunities and challenges. *Renew. Sust. Energ. Rev.* **2012**, *16*, 1082–1088. [CrossRef]
- Ismail, M.S.; Moghavvemi, M.; Mahlia, T.M.I. Design of an optimized photovoltaic and microturbine hybrid power system for a remote small community: Case study of Palestine. *Energy Convers. Manag.* **2013**, *75*, 271–281. [CrossRef]
- Status of The Environment in The State of Palestine 2015*; Applied Research Institute Jerusalem (ARIJ); Swiss Agency for Development and Cooperation SDC, 2015; p. 189. Available online: <http://www.arj.org/> (accessed on 28 January 2020).
- Palestinian Central Bureau of Statistics (PCBS). Available online: <http://www.pcbs.gov.ps/> (accessed on 28 January 2020).
- Palestinian National Plan 2011–13*; Energy Sector Strategy; Ministry of Planning and Administrative Development Palestine: Ramallah, Palestine, 2011. Available online: https://www.google.com/url?sa=t&rct=j&q=&esrc=s&source=web&cd=4&ved=2ahUKEwim8rWjtqjnAhXR4KQKHel6A10QFjADegQIAhAB&url=http%3A%2F%2Fwww.lacs.ps%2FdocumentsShow.aspx%3FATT_ID%3D4799&usg=AOvVaw0ih44V_42LHzdNHvQp57_1 (accessed on 30 January 2020).
- El-Kassaby, M.M. Monthly and daily optimum tilt angle for south facing solar collectors; theoretical model, experimental and empirical correlations. *Sol. Wind Technol.* **1998**, *5*, 589–596. [CrossRef]
- Duffie, J.A.; Beckman, W.A. *Solar Engineering of Thermal Processes*, 2nd ed.; John Wiley and Sons: New York, NY, USA, 1991; p. 919.
- Lunde, P.J. *Solar Thermal Engineering*; John Wiley and Sons: New York, NY, USA, 1980; p. 635.
- Jafarkazemi, F.; Saadabadi, S.A. Optimum tilt angle and orientation of solar surfaces in Abu Dhabi, UAE. *Renew. Energy* **2013**, *56*, 44–49. [CrossRef]
- Pavlović, T.; Pavlović, Z.; Pantić, L.; Kostić, L. Determining optimum tilt angles and orientations of photovoltaic panels in niš, Serbia. *Contemp. Mater. I* **2010**, 151–156. [CrossRef]
- Omar, M.A.; Mahmoud, M.M. Grid connected PV-home systems in Palestine: A review on technical performance, effects and economic feasibility. *Renew. Sust. Energy Rev.* **2018**, *82*, 2490–2497. [CrossRef]

17. National Renewable Energy Laboratory (NREL). PV Watts Calculator. Available online: <https://pvwatts.nrel.gov/> (accessed on 30 January 2020).
18. Photovoltaic Geographical Information System. European Commission. PVGIS. Available online: https://re.jrc.ec.europa.eu/pvg_tools/en/tools.html (accessed on 28 January 2020).
19. Berisha, X.; Zeqiri, A.; Meha, D. Solar Radiation—The Estimation of the Optimum Tilt Angles for South-Facing Surfaces in Pristina. *Preprints* **2017**, *13*. [[CrossRef](#)]
20. Racharla, S.; Rajan, K. Solar tracking system—A review. *Int. J. Sustain. Eng.* **2017**, *10*, 72–81.
21. Mousazadeh, H.; Keyhani, A.; Javadi, A.; Mobli, H.; Abrinia, K.; Sharifi, A. A review of principle and sun-tracking methods for maximizing solar systems output. *Renew. Sust. Energ. Rev.* **2009**, *13*, 1800–1818. [[CrossRef](#)]
22. Ahmad, M.J.; Tiwari, G.N. Optimization of tilt angle for solar collectors to receive maximum radiation. *Open Renew. Energy J.* **2009**, *2*, 19–24.
23. Abdulsalam, H.S.; Alibaba, H.Z. Optimum Tilt Angle for Photovoltaic Panels in Famagusta, Cyprus. *IJSSHR* **2019**, *7*, 29–35.
24. Jiménez-Torres, M.; Rus-Casas, C.; Lemus-Zúiga, L.; Hontoria, L. The Importance of Accurate Solar Data for Designing Solar Photovoltaic Systems—Case Studies in Spain. *Sustainability* **2017**, *9*, 247.
25. Mousavi Maleki, S.A.; Hizam, H.; Gomes, C. Estimation of hourly, daily and monthly global solar radiation on inclined surfaces: Models re-visited. *Energies* **2017**, *10*, 134. [[CrossRef](#)]
26. Skeiker, K. Optimum tilt angle and orientation for solar collectors in Syria. *Energy Convers. Manag.* **2009**, *50*, 2439–2448. [[CrossRef](#)]
27. Khasawneh, Q.A.; Damra, Q.A.; Salman, B.; Husni, O. Determining the Optimum Tilt Angle for Solar Applications in Northern Jordan. *JJMIE* **2015**, *9*, 187–193.
28. Hartner, M.; Ortner, A.; Hiesl, A.; Haas, R. East to west—The optimal tilt angle and orientation of photovoltaic panels from an electricity system perspective. *Appl. Energy* **2015**, *160*, 94–107. [[CrossRef](#)]
29. Safdarian, F.; Nazari, M.E. Optimal tilt angle and orientation for solar collectors in Iran. In Proceedings of the IEEE 10th International Symposium on Diagnostics for Electrical Machines, Power Electronics and Drives (SDEMPED), Guarda, Portugal, 1–4 September 2015; IEEE: Guarda, Portugal, 2015; pp. 494–500.
30. Jacobson, M.Z.; Jadhav, V. World estimates of PV optimal tilt angles and ratios of sunlight incident upon tilted and tracked PV panels relative to horizontal panels. *Sol. Energy* **2018**, *169*, 55–66. [[CrossRef](#)]
31. Talebizadeh, P.; Mehrabian, M.A.; Abdolzadeh, M. Determination of optimum slope angles of solar collectors based on new correlations. *Energy Sources Part A Recovery Util. Environ. Eff.* **2011**, *33*, 1567–1580. [[CrossRef](#)]
32. Morcos, V.H. Optimum tilt angle and orientation for solar collectors in Assiut, Egypt. *Renew. Energy* **1994**, *4*, 291–298. [[CrossRef](#)]
33. Hartley, L.E.; Martínez-Lozano, J.A.; Utrillas, M.P.; Tena, F.; Pedros, R. The optimisation of the angle of inclination of a solar collector to maximise the incident solar radiation. *Renew. Energy* **1999**, *17*, 291–309. [[CrossRef](#)]
34. Yakup, M.A.B.H.M.; Malik, A.Q. Optimum tilt angle and orientation for solar collector in Brunei Darussalam. *Renew. Energy* **2001**, *24*, 223–234. [[CrossRef](#)]
35. Tang, R.; Wu, T. Optimal tilt-angles for solar collectors used in China. *Appl. Energy* **2004**, *79*, 239–248. [[CrossRef](#)]
36. Ulgen, K. Optimum tilt angle for solar collectors. *Energy Sources Part A Recovery Util. Environ. Eff.* **2006**, *28*, 1171–1180. [[CrossRef](#)]
37. Darhmaoui, H.; Lahjouji, D. Latitude based model for tilt angle optimization for solar collectors in the Mediterranean region. *Energy Procedia* **2013**, *42*, 426–435. [[CrossRef](#)]
38. Guo, M.; Zang, H.; Gao, S.; Chen, T.; Xiao, J.; Cheng, L.; Sun, G. Optimal tilt angle and orientation of photovoltaic modules using HS algorithm in different climates of China. *Appl. Sci.* **2017**, *7*, 1028. [[CrossRef](#)]
39. Nijegorodov, N.; Devan, K.R.S.; Jain, P.K.; Carlsson, S. Atmospheric transmittance models and an analytical method to predict the optimum slope of an absorber plate, variously oriented at any latitude. *Renew. Energy* **1994**, *4*, 529–543. [[CrossRef](#)]

