

Thermal Conductivity of lipidic emulsions and its use for production and quality control.

P. Coppa* – G. Pasquali

Dept. of Mechanical Engineering, University of Rome "Tor Vergata"

ABSTRACT

Thermal conductivity of lipidic emulsions has been experimentally determined by the probe method. To this purpose a special probe has been designed and built in laboratory, with small diameter (0.6 mm) and a high length to diameter ratio (≈ 100). The temperature sensor of the probe (type T thermocouple) and the heater (Pt wire) were properly calibrated. Moreover, the probe performance has been tested by means of a pure liquid (glycerin) having well known thermal conductivity by literature. Differences of about 1.5% at ambient temperature in thermal conductivity values between literature and experiments were found.

On lipidic emulsions first thermal conductivity has been measured in the temperature range $10 \div 40^\circ\text{C}$, second the same property as a function of time at constant temperature (40°C), then the values after freezing at -15°C and reheating at 20°C ; and last the kinetics of degeneration. Results show a significant difference between thermal conductivity values of a new emulsion ($\approx 0.51 \text{ W/m K}$), compared with the creamed one ($\approx 0.62 \text{ W/m K}$), and the decayed one ($\approx 0.68 \text{ W/m K}$). It has also put into evidence why the frozen emulsion cannot be used for intravenous injection, i.e. viscosity increases because of breaking of the oil particles. Finally information about the kinetics of the degeneration process have been obtained. The uncertainty resulting from the calibration and tests justifies the possible use of the measurement technique for process control of production, and also for quality control in the clinical practice.

1. Introduction

Between the thermo physical properties of materials, thermal conductivity and thermal diffusivity (or thermal capacity) are responsible of the steady state and transient thermal behaviour, respectively. This is the reason why they play a key role in explaining thermal phenomena and in designing thermal devices. Besides, being these properties dependent on material chemical composition, treatment and resulting structure (porosity, size of void space, homogeneity, presence of fibres and their orientation), an accurate knowledge of their values can be used to judge the production process of goods or their quality. As an example, thermal conductivity of porous media (as bricks) can be used to evaluate their water content.

Thermal diffusivity and thermal conductivity can be measured independently or simultaneously, being their value joined by the relationship $\alpha = \frac{\lambda}{\rho \cdot c_p}$, both by transient or steady state methods. In the present work the

probe method [1-4] has been used and a special thermal conductivity probe (TCP) has been designed and built, particularly suited for measuring thermal conductivity of liquids.

The method is based on the line heat source theory, firstly suggested by Schleiermacher [1] in 1888 and later by Stalhane and Pyk in 1931 [2]. The theory of the propagation of heat from an infinite line source is handled in [3], while a practical use of this theory was carried out in 1949 by Van der Held and Van Drunen [4] for measuring thermal conductivity of liquids. The first probe utilizing the principle of the line heat source was probably the one described in 1954 by Hooper and Lepper [5], for measuring thermal conductivity of soils. In the following two decades, many investigators analysed the measurement theory of finite dimension probe and other successfully experimented with practical probes, different in design, geometry, materials and physical characteristics. Thermal properties of liquids, solids, soils, foods, porous materials, and even biological tissues [6] have been successfully measured. An extended review of the measuring techniques is reported in [7]. Measuring devices are also commercially available, e.g. by Hukseflux, Delft (The Netherlands) and by Decagon Devices Inc. (Pullman, Washington).

Both line heat source (bare wire) and thermal conductivity probe can be used to measure thermal conductivity, the first being more suitable for laboratory while the second for field tests. Even if the first method gives more accurate results, when the probe has a high length to diameter ratio (about 100 in the present case) the two kinds of techniques give quite similar values.

The probe method in the present work has been applied to determine thermal conductivity of lipidic emulsions. These drugs are generally intravenously injected to supply feeding to human bodies when it is naturally

* Via del Politecnico 1, 00133 Rome – ITALY - e-mail: coppa@uniroma2.it

impossible. Both thermal conductivity and specific heat of these drugs could give information on the heat removal from the body and the time of propagation, thus influencing the cold feeling by the patient. Besides, a precise determination of these properties could infer their integrity, stability and behaviour during the process of production and also for the quality control in the clinical practice.

Emulsions are heterogeneous mixtures constituted by two non miscible liquids, e.g. by liquids showing different electrical properties [8]. Generally emulsions are composed by a hydrophobic liquid (usually oil) and by a hydrophilic one (usually water), and can be defined O/W (oil in water) or W/O (water in oil) emulsions depending on which is the inner phase.

The stability of emulsions depends on the presence of a third substance (the surfactant), and can be influenced by the temperature and aging. A stable emulsion is formed by a very large number (up to 10^{16} in a liter for a 20% emulsion) of small spherical droplets of inner phase, with diameter of about 1 μm (again in a 20% emulsion) dispersed in the outer phase. Due to this characteristic, emulsions appear normally white, similarly to the milk.

Being the two principal components (water and oil) strongly different between them, thermal conductivity of emulsions is influenced by the percentage of the two substances, but not by the particle sizes until the mixture is uniform.

2. Experimental method and apparatus

The TCP has been designed and built in the Heat Transfer Laboratory of the University of Rome “Tor Vergata”. Fig. 1 presents a sketch of the probe and some details (section where the TC tip is located and handle). Special attention has been paid to avoid biases due to axial heat transfer and finite sizes of the sample [7, 9]: a ratio of almost 100 between the length of the probe and its diameter has been chosen to avoid axial flow, while a ratio of 80 between the diameter of the sample container and the probe diameter is used to guarantee the condition of infinite medium around the line source. The temperature is measured by a thin (0.1 mm) type T thermocouple in the centre of the probe, and the heater is a Pt wire whose resistance is continuously monitored during the tests as a four wire resistance. In the handle, links (welds) with thicker wires are provided for both TC and heater wires. A low viscosity epoxy resin is used to fill the inside of the stainless steel tube of the probe, to prevent localized sources of thermal resistance from the heater to the medium.

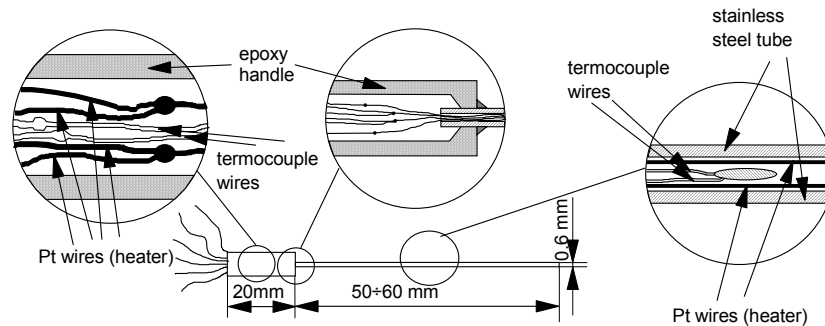

Figure 1 – Sketch of the Thermal Conductivity Probe.

Tests are carried out with the apparatus described in Fig. 2. The probe is inserted in the container with the sample and, at a defined time, the heater is fed at constant current. The increment of the temperature of the probe is recorded as a function of time, together with the temperature of the wall of the container.

According to the perfect line source model, the probe is describe as an infinitely long and infinitesimally thin heating source embedded in an infinite, homogeneous and isotropic medium. The exact solution of equation of heat propagation from the heater to the medium is given by the Jaeger equation [3]:

$$\vartheta(r, t) = \frac{q}{4\pi\lambda} \int_{r^2/4\alpha t}^{\infty} \frac{e^{-x}}{x} dx, \quad (1)$$

where ϑ is the temperature increment from an initial value, q the supplied power for unit length, λ the thermal conductivity of the medium, r the distance between the heater and the point where the increment of temperature is measured, t the time and α is the sample thermal diffusivity. A time series expansion of the integral leads to the well known equation

$$\vartheta(r, t) = \frac{q}{4\pi\lambda} \ln\left(\frac{4\alpha t}{r^2}\right) - C_E + \dots \quad (2)$$

valid for long times, with C_E the Euler constant. Being the temperature sensor (TC) just in the centre of the probe, eq. (2) cannot be directly applied, but a more complicated equation is derived from Jaeger [3], which takes into account the finite dimensions of the probe:

$$\mathcal{G}(t) = \frac{q}{4\pi\lambda} \left[\ln\left(\frac{4\alpha t}{b^2}\right) - \gamma + \frac{2\lambda}{bH} \right] + \dots \quad (3)$$

being \mathcal{G} now the temperature in the centre of the probe, b its radius, and γ and H constants related to the contact resistance, which for the described probe can be considered negligible. Also in this equation the temperature rise is linearly dependent on the logarithm of the time. Thermal conductivity λ is obtained by the slope of the linear regression between the measured temperature increase vs the logarithm of time. Thermal resistance between the probe and the medium, thermal diffusivity of the medium and Euler constant contribute mainly to the intercept of the regression line.

Getting accurate results needs a proper calibration of thermocouples and of Pt electric resistance. In principle the temperature could be measured also with the Pt wire, being a temperature dependent 4 wire resistance. But its values are affected by the part of wire in the handle (about 4%), which is more sensible to the thermal conductivity of the handle than of the medium.

Calibration was performed by comparing the detected voltage signals of the thermocouples and resistance of the Pt wire with the output of a reference thermometer (a PT25 previously calibrated). The calibration uncertainty was calculated from the standard uncertainty of the calibration data, as foreseen by the ITS90 [10], and resulted of about 0.03 °C for both thermocouples and Pt wire.

The probe performances were tested measuring the thermal conductivity of a pure liquid (glycerine), whose value was obtained by literature [11]. Differences in thermal conductivity less than 1.5% were found at ambient temperature between literature and experiments.

The apparatus used for measurements is shown in Fig.2. It is possible to recognize the probe (TCP), the container of sample and probe, the thermocouple on the wall of the container (TC), the thermostat to heat or cool a working fluid used to regulate the temperature in the medium and on the cover, the data acquisition system (DAS), the power supply, the shunt resistance to precisely evaluate the probe resistance.

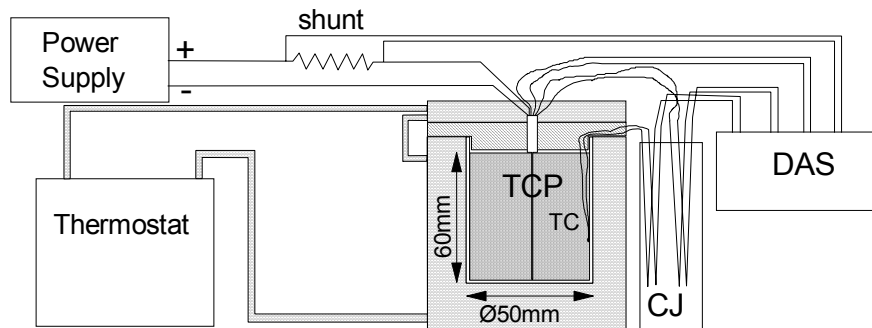

Figure 2 – Set-up of the experimental apparatus

3. Measurement procedure and data processing

- The probe and the material under test are brought to a defined temperature, waiting till both the thermocouple of the probe and the one on the wall show the same temperature.
- The current from the power supply is risen to a value depending on the material (from 0.05 A to 0.2 A), causing a temperature increase of about 2 °C.
- Voltage signal of thermocouples, voltage drop on shunt and probe are recorded.
- Data are processed with the described analytic model.
- These same data are plotted as a function of logarithm of time; in the range where the behaviour is considered linear, the slope p of the linear regression is calculated, and from it through eq. (3) the thermal

conductivity is deduced $\lambda = \frac{q}{4\pi p}$

The linear behaviour in a logarithmic plot is an index of the good behaviour of the probe and the absence of biases due to construction [7]. Moreover, the longer is the range of the linear behaviour, the more accurate is the determination of the thermal conductivity. The standard uncertainty of the measurement is derived from the standard uncertainty of the slope, which is the square root of one diagonal element of the covariance matrix of unknowns.

A typical test on lipidic emulsion is shown in fig. 3, where it is possible to see also the regression line in the linear range (3-70 s).

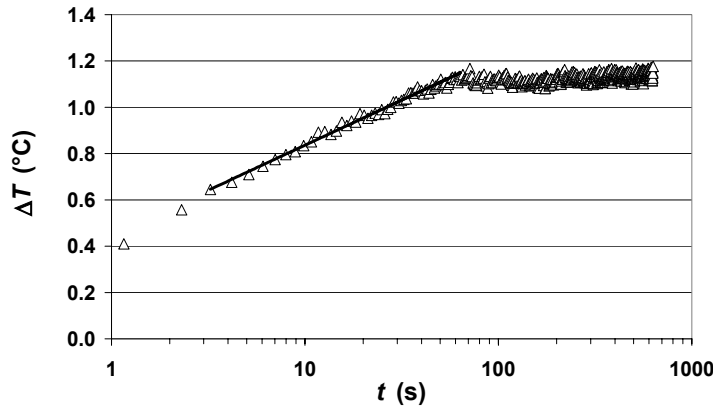

Figure 3 – Result of the test on lipid emulsion at 10°C.

4. Tests on lipidic emulsions

The following different tests have been carried out on the lipidic emulsion Intralipid 20% of Fresenius Kabi, containing 200 g of soya oil and 12g of egg phospholipid in 1 kg of water:

1. thermal conductivity in the range 10÷40 °C,
2. thermal conductivity as a function of time at constant temperature (aging),
3. thermal conductivity after freezing at -15°C and reheating at 20 °C (cold degeneration),
4. kinetics of thermal degeneration

4.1 Determination of thermal conductivity in the range 10÷40 °C

The results of the tests are shown in table 1.

As can be expected, thermal conductivity is a weighted average of the water and oil ones, i.e. 0.62 W/m K and 0.15 W/m K. Besides, a step change in values can be noted from 20°C to 30°C.

T (°C)	λ (W/m K)	σ_λ
10	0.486	0.002
20	0.489	0.003
30	0.518	0.003
40	0.523	0.005

Table 1 – Thermal conductivity of a lipidic emulsion as a function of time and its standard uncertainty as obtained by the linear regression on the experimental data.

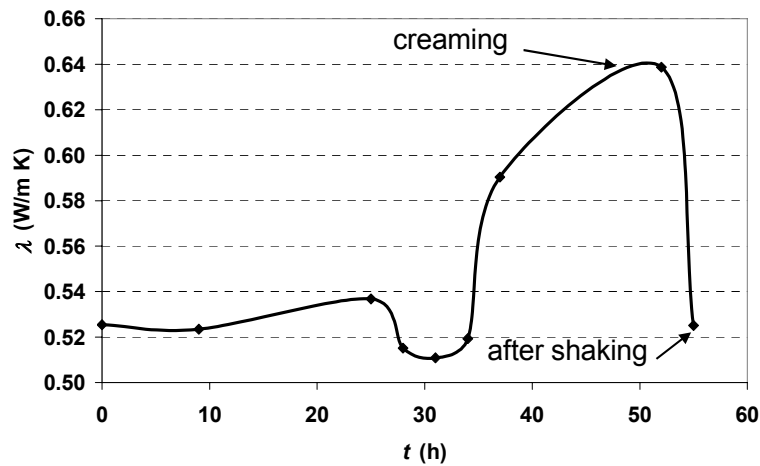

Figure 4:- Behaviour of the lipidic emulsion at constant temperature (40°C).

4.2 Thermal conductivity as a function of time at constant temperature

To test the behaviour of the emulsion in temperature, measurements have been carried out maintaining the emulsion at 40 °C for a long time (more than 2 days), and measuring λ every 3 hours. Results are reported in Fig.4. After 36 h a step change in thermal conductivity from 0.52 to 0.64 W/m K indicates a change in the nature of the substance. Visually examining the emulsion, it was possible to recognize a cream on the surface of the liquid; at the contrary the bulk of the emulsion didn't appear changed at the electronic microscope. So the change in thermal conductivity could be ascribed to the so called creaming, i.e. deposition of a layer of oil particles to the surfaces of the container. This effect can be reversed with shaking, and doesn't forbid the clinical use of the drug. The effect of recovering with shaking is also shown in Fig. 4.

4.3 Freezing and reheating

It is well known that lipidic emulsions must not be frozen, otherwise they result unusable. To test what happens freezing the emulsion, temperature was lowered to -15°C for some hours, and then reheated to 20 °C. No change was measured in thermal conductivity (≈ 0.51 W/m°C), but a difference in the beginning of convection was discovered, i.e. the time when the behaviour of data diverges from linear in the logarithm of time. This time was 25 s (Fig. 5) for the new emulsion and 200 s (Fig. 6) for the frozen one. This difference is clearly due to the viscosity of the sample, whose significant increase delays the beginning of convection. It is probably caused by the breaking of oil particles as a consequence of the formation of ice needles during freezing.

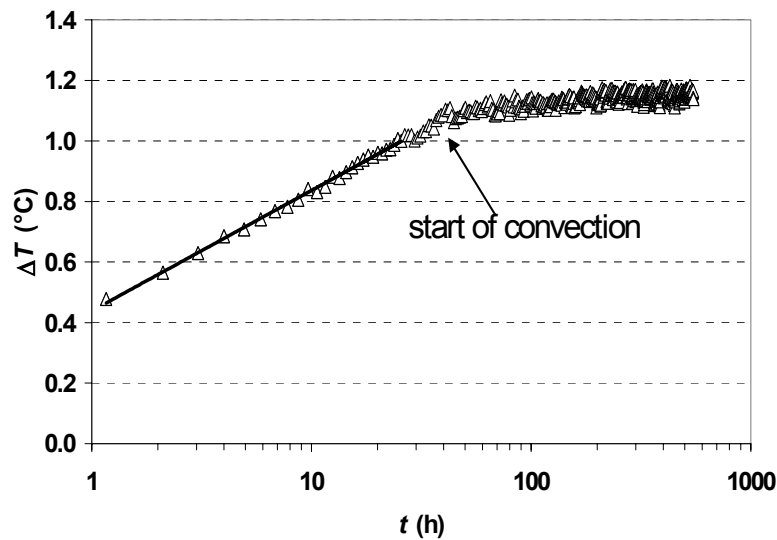

Figure 5:- Test result for the emulsion as supplied

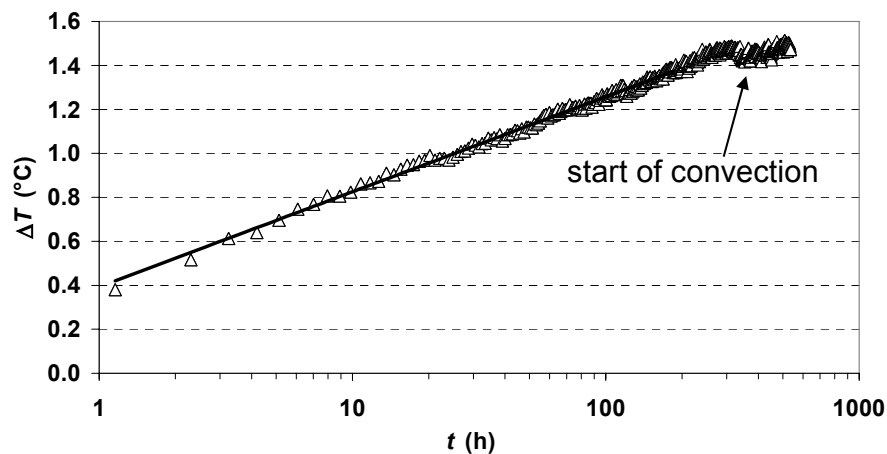

Figure 6.- Test result for the emulsion after frozen and reheated.

4.4 Kinetics of degeneration

The emulsion is considered completely degenerated when a total separation of the 2 liquids is present, with the formation of serum on the surface of yellow colour and unpleasant smell. According to the producer, degeneration occurs after 2 years at ambient temperature (20°C), and after 1 year at 40°C. In the present work degeneration has been studied at higher temperatures and shorter times, i.e. at 60, 70 and 80 °C. Measurements of degenerated emulsions led to values of about 0.68 W/m K. Degeneration time has been calculated from the time necessary to the emulsion to reach the above mentioned value (e.g. at 70°C this time is about 36 h, see Fig. 7). Fig. 8 shows the results of the degeneration kinetics, as logarithm of degeneration time versus temperature. The first two data are the ones provided by the producer.

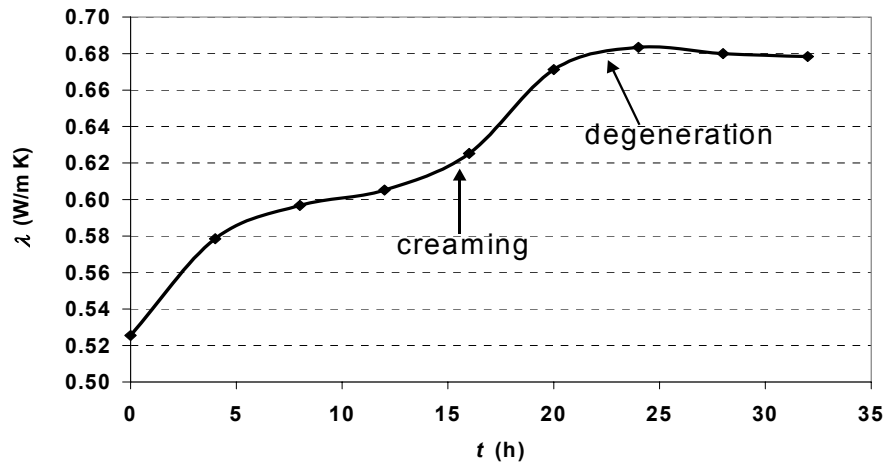

Figure 7.- Thermal conductivity versus time at 70°C.

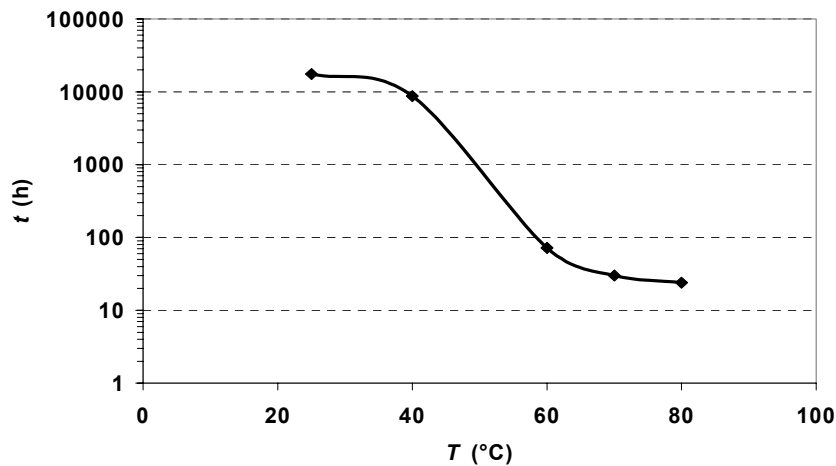

Figure. 8 – Kinetics of degeneration of the emulsion.

5 Uncertainty analysis

Thermal conductivity measurement is affected basically by two kinds of uncertainty. The first due to the uncertainties of the measured quantities, e.g. supplied current, electric resistance and length of the heater, probe temperature. The second derives from the possible difference between the assumed model and the real phenomenon of heat propagation from the probe to the sample.

5.1 Uncertainty propagation from measured quantities

The current coming from the power supply is constant within $1 \cdot 10^{-4}$, in relative value. During a test the resistance increases due to its temperature coefficient. Being the increase of temperature about 2 °C, a change in resistance of about $\pm 0.3\%$ was found. Probe length is evaluated from the probe resistance at 0°C (measured during calibration), the section of the wire (as supplied by the producer) and the electrical resistivity ρ , through the equation $R = \rho \cdot L / S$. Its uncertainty is calculated by the uncertainty propagation law from the ones of all these quantities. Uncertainty due to the temperature measurement is given by calibration, and can be considered

negligible. Uncertainty from the slope of the logarithmic plot is computed as previously described. All the above mentioned causes are resumed in table 2. Most of them are quite low.

Uncertainty cause	σ (%)
Current supplied by supply power	0.0011
Probe length	0.45
Slope regression curve	≈ 0.3
Measure of temperature	Negligible

Table 2. - Different causes of uncertainty due to measured quantities.

Total uncertainty is again calculated by the uncertainty propagation law, under the hypothesis of independency between different causes. Its values are reported in Table 3 as a function of temperature.

T (°C)	σ (W/m K)	%
10	0.0064	1.29
20	0.0078	1.56
30	0.0088	1.66
40	0.0105	2.01

Table 3. - Uncertainty due to measured quantities at different temperatures.

5.2 Uncertainty on the model

Hypotheses assumed in the model of processing experimental data can disagree from the physical behaviour. These assumptions are: finite dimensions of probe and sample, axial heat flow in the probe, contact resistance with the sample, anisotropy and non homogeneity of the sample, convection between probe and medium. Being necessarily the sizes of the sample finite, measurements must finish before the thermal wave reaches the sample border. This condition is controlled by the wall thermocouple, and generally only the probe data till the beginning of the increasing of the wall temperature are taken into account for data processing. An alternative way is to calculate the maximum test time given by Prelosvek and Uran [12]:

$$t_{\max} < 0.1 \frac{R_s^2}{\alpha} \quad (4)$$

where R_s is the sample radius and α the diffusivity. The obtained values are shown in table 4, and are about one half of the maximum time used in data processing.

Axial flow depends on the finite probe length. Bias due to this cause depends on sample thermal diffusivity, probe radius and length ratio, ratio between internal and external probe radius and ratio between sample and probe heat capacity. This bias has been computed according to Thomas and Ewen [13] for the presented tests, it is reported in table 4 (in absolute and relative value), and has been found completely negligible compared with other sources of uncertainty.

T (°C)	Finite sample size t_{\max} (min)	Axial heat flow	
		Bias	Relative uncertainty (%)
10	8.18	$-4.612 \cdot 10^{-9}$	0.017
20	7.19	$-4.487 \cdot 10^{-9}$	0.018
30	7.13	$-4.108 \cdot 10^{-9}$	0.017
40	7.57	$-4.332 \cdot 10^{-9}$	0.019

Table 4. - Maximum test time (due to finite sample size) and uncertainty due to axial heat flow

No contact resistance is considered between a liquid (sample) and a solid (probe), and emulsions are considered isotropic and homogeneous.

Conclusion

The modified Jaeger model has been applied to determine thermal conductivity of lipidic emulsions. The tests have shown a significant difference (compared to uncertainty) between the values of a new emulsion (≈ 0.51 W/m°C), after “creaming” (≈ 0.62 W/m°C) e after degeneration (≈ 0.68 W/m°C). The relative uncertainty of about 1.5 % justifies the use of the measurement to control quality in the clinical practice. After some time

creaming is formed on the emulsion. As the phenomenon is reversible, its effect can be cancelled by a mechanical shaking. In this case the measurement of thermal conductivity returns to the undamaged value. Degeneration takes place after a temperature dependent defined time. Even if it is recognizable by colour and smell, thermal conductivity measurement reveals the degeneration in advance. Freezing can be very dangerous for the increased viscosity and consequent risk of embolism. Even if the thermal conductivity of a frozen emulsion is equal to the undamaged one, measuring time (time till the behaviour of temperature increase is linear versus logarithm of time) changes significantly. Finally, also process control could fruitfully take advantage by this technique, that is easy to be applied on line during production process, and requires only few minutes.

REFERENCES

1. A.L.E.F. Schleiermacher, "Über die Wärmeleitung der Gase", *Ann. Phys. Chem.* **34**, 623, 1888
2. B. Stalhane and S. Pyk, "New method for determining the coefficients of thermal conductivity", *Tek. Tidskr* **61**, 389, 1931
3. H. S. Carslaw and J.C. Jaeger, *Conduction of Heat in Solids*, Oxford University Press, London, 1959
4. E.M.F. Van der Held and F.G. Van Drunen, "A method for measuring of thermal conductivity of liquids", *Physics* **15**, 865, 1949
5. F.C. Hopper and F.R. Lepper, "Transient heat flow apparatus for determination of thermal conductivities", *ASHVE Trans.* **56**, 309, 1950
6. Y. P. Zhang, X. G. Liang, Z. Wang and X. S. Ge, "A Method of Determining the Thermophysical Properties and Calorific Intensity of the Organ or Tissue of a Living Body", *Int. Jour. of Thermophysics*, **21**, pp.207-215, 2000.
- 7 A.E. Wechsler, "The Probe Method for Measuring Thermal Conductivity", in *Compendium of Thermophysical Property Measurement Methods*, vol **2**, *Recommended Measuring Techniques and Practices*, ed. K.D. Maglič, A. Cezairliyan, V.E. Peletsky, Plenum press, London, 1992
8. M. Nichelatti, *Topics on Diffusion in Emulsions*, World Scientifics, London, 1994
9. Gori F., Coppa P., "Experimental Measurements of Heat Transfer to Liquids in the Conduction-Convection Regime", ASME paper n. ESDA2002/ATF-044. *proc. of ESDA2002 (6th Biennial Conference on Engineering Systems Design and Analysis)*, Istanbul (Turkey), July 8-11, 2002
10. H. Preston Thomas, "The International Temperature Scale of 1990", *Metrologia*, **27**, pp. 3-10, 1990
11. E.R.G. Eckert and R.M. Drake, *Heat and Mass Transfer*, McGraw-Hill (New York), 1959.
12. P. Prelovsek and B. Uran, "Generalised Hot Wire Method for Thermal Conductivity Measurements", *The Institute of Physics*, 0022-3735/84/080674, pp. 674, 1984
13. H.R. Thomas and J. Ewen, "A Reappraisal of Measurement Errors Rising From the Use of a Thermal Conductivity Probe", *J. Heat Transfer* **108**, 705, 1986