



This is a postprint version of the following published document:

Ebrahimpouri, M., Rajo-Iglesias, E., Sipus, Z. y Quevedo-Teruel, O. (2018). Cost-Effective Gap Waveguide Technology Based on Glide-Symmetric Holey EBG Structures. *IEEE Transactions on Microwave Theory and Techniques*, 66 (2), pp. 927-934.

DOI: <https://doi.org/10.1109/TMTT.2017.2764091>

©2018 IEEE. Personal use of this material is permitted. Permission from IEEE must be obtained for all other uses, in any current or future media, including reprinting/republishing this material for advertising or promotional purposes, creating new collective works, for resale or redistribution to servers or lists, or reuse of any copyrighted component of this work in other works.

Cost-effective Gap Waveguide Technology Based on Glide-Symmetric Holey EBG Structures

Mahsa Ebrahimpouri, *Student Member, IEEE*, Eva Rajo Iglesias, *Senior Member, IEEE*, Zvonimir Sipus, *Senior Member, IEEE*, and Oscar Quevedo-Teruel, *Member, IEEE*

Abstract—We present a novel electromagnetic band-gap (EBG) structure, which can be used to manufacture low-cost waveguiding structures at high frequencies. The unit-cell of the proposed EBG consists of glide-symmetric holes in parallel plate waveguide (PPW). Using this unit-cell in groove gap waveguide technology has a number of advantages over pin-type EBG at high frequencies, such as acquiring higher accuracy because of larger periodicity as well as an easier and cheaper manufacturing process. The performance of the proposed wave-guiding structure is demonstrated using both a straight and a double 90° bent lines through simulation and measurement.

Index Terms—Glide symmetry, higher symmetries, gap waveguide technology.

I. INTRODUCTION

METALLIC waveguides are one of the earliest types of guiding structures implemented by electromagnetic engineers. They have been broadly employed since they have low losses and no leakage. Additionally, they can handle high power and have cross-talk free characteristics [1]. However, it is hard to manufacture waveguide components at higher frequencies [2], [3] and they are bulky at lower frequencies. In particular, it is important to ensure high-quality electrical contact between the waveguide plates since each gap between the adjacent layers causes extremely large transmission loss due to serious leakage (see e.g. [3] where the problem of the production of a waveguide feed-network is discussed). Furthermore, it is difficult to design complex circuitry in conventional metallic waveguides and to integrate active components into them.

In order to overcome these limitations at high frequencies, substrate integrated waveguides (SIW) were proposed in 1994 [4]. SIW structures are compact and have a low-cost manufacturing process. Additionally, in SIW, a complete circuitry can be integrated in one single plate. Nevertheless, the waves are guided inside a dielectric slab, which may impose a significant amount of losses, especially with the increase of the frequency. Furthermore, at very high frequencies, when the dimensions of the structure must be small, SIW requires very small

metallic vias with diminutive periodicity in order to minimize the leakage [5], thus increasing the difficulty and price of the manufacturing. Moreover, the power-handling capability is reduced compared to classical rectangular waveguide (RW) as they have a smaller cross section.

As an alternative to SIW, gap waveguide technology was proposed in 2009 [2], [6]. In gap waveguide technology, the waves are guided in air, reducing the losses with respect to SIW structures [7]. Additionally, these structures do not require metallic contacts between upper and lower plates, which is a relevant advantage in manufacturing process, and they can be used in packaging to reduce unwanted coupling, radiation losses and resonant mode influence [8]. Pin-type EBG [9] has been commonly used in gap waveguide technology to stop wave propagation in undesired areas [10]–[13]. Although gap waveguide technology has valuable properties at high frequencies, it requires the manufacturing of very thin and tall metallic pins that increases the cost of the designs and the difficulty of the manufacturing process. Recently, some attempts were made to reduce the price and difficulty of this manufacturing process. In [14], half-height pins are proposed to be used in gap waveguide technology. In this work, a shorter length of pins is employed, which makes fabrication of the pin surface easier. However, an accurate manufacturing process is still needed.

In this paper, we propose a novel cost-effective method to manufacture integrated waveguide structures at high frequencies. This method makes use of a truncated glide-symmetric holey EBG structure [15]. The proposed EBG structure is only made of holes, which makes the manufacturing process much easier with respect to the pins. The periodicity of the proposed unit cell is about 2.5 times bigger than the conventional pins at the same frequency, and the optimum depth of holes is shallower compared to the length of pins. Therefore, the method results in higher accuracy and a lower cost of manufacturing at high frequencies.

This paper is organized in five sections. In the second section, the structure of glide-symmetric holey EBG is introduced. In section III, the performance of the proposed waveguiding structure is investigated through straight, double 90° bent, and coupled waveguide lines. In section IV, the performance of the proposed method is validated through measurements of manufactured prototypes, and in section V, conclusions are drawn.

M. Ebrahimpouri and O. Quevedo-Teruel are with the Department of Electromagnetic Engineering, School of Electrical Engineering, KTH Royal Institute of Technology, SE-100 44, Sweden, e-mail: oscarqt@kth.se.

E. Rajo-Iglesias is with the Department of Signal Theory and Communication, University Carlos III of Madrid, 28911 Leganes (Madrid), Spain.

Z. Sipus is with the Faculty of Electrical Engineering and Computing, University of Zagreb, 10000 Zagreb, Croatia.

Manuscript received... ; revised September...

This work has been partially funded by Swedish STINT Postdoctoral Transition Grants programme PT2014-5813.

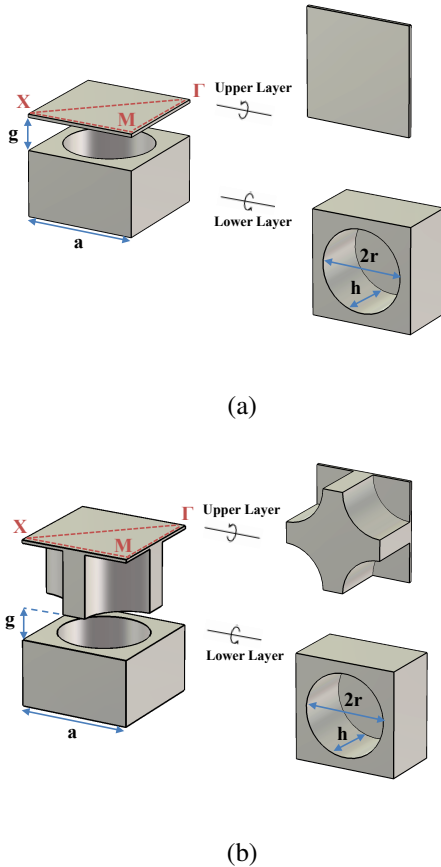

Fig. 1: Unit cells under study: (a) Holes only on one plate. (b) Glide-symmetric holes on both plates.

II. HOLEY GLIDE-SYMMETRIC EBG STRUCTURE

A glide-symmetric periodic structure is constructed through a translation and a mirroring. These structures, in their one-dimensional configuration, were extensively studied in the 60s through generalized Floquet theorem [16]. Two-dimensional glide-symmetric holey metasurfaces were introduced for the first time in [17]. In that work, the authors considered a parallel-plate waveguide (PPW) consisting of two periodic planar structures in which one periodic structure is obtained from another one by mirroring and translating it by half of the period in both planar directions. The non-dispersive characteristic of the first guiding mode was investigated to produce ultra-wide band planar lenses. More recently, the interesting property of these structures in removing frequency dependence of the first guiding mode was studied [18]–[20]. Another appealing property of glide-symmetric holey structure, which is that it acts as an EBG at higher frequencies, is discussed in [21].

Fig. 1 and Fig. 2 represent unit cells of two different periodic structures and their corresponding dispersion diagrams. As shown, in the case of holes on one single layer (Fig. 1(a)), there is a very narrow stop-band. This structure was previously introduced in [22], although only band-gap properties in one direction were employed. Moreover, since the stop-band is narrow, further studies have shown that when the diameter of the holes is small with respect to the periodicity, there is no full stop-band in the complete irreducible Brillouin zone.

Using glide-symmetric structures, as shown in Fig. 1(b), the stop-band becomes considerably wider, as observed in the dispersion diagram of Fig. 2(b). This unit-cell is composed of two plates, which have holes that are a half-unit cell translated in two directions. Identical grid of dense holes are used in both the upper and lower plate.

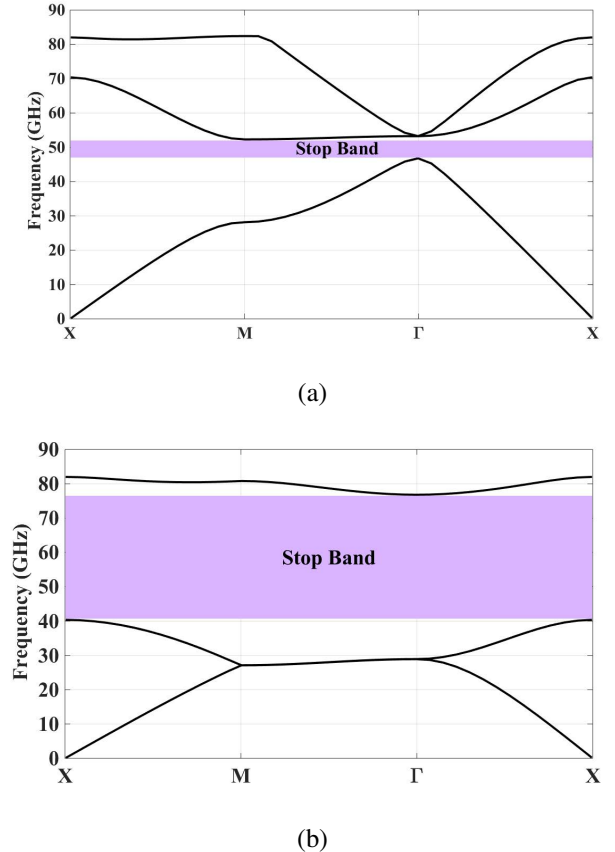

Fig. 2: Dispersion diagrams for the unit cells described in Fig. 1 with dimensions: $r = 1.4$ mm, $a = 5$ mm, $h = 2$ mm, and $g = 0.05$ mm. (a) Holes only on one plate. (b) Glide-symmetric holes on both plates.

In this work, the prototypes have been designed to operate in the U-band (40-60 GHz). The parameters of the periodic glide-symmetric holey structure have been optimized to maximize the bandwidth of the stop-band in U-band following the guidelines given in [15]. The obtained values are: $r = 1.4$ mm, $a = 5$ mm, $h = 2$ mm, with an air gap between the upper and lower plate of $g = 0.05$ mm. As studied in [15], the bandwidth of the bandgap increases when the air gap between plates becomes smaller. In gap waveguide technology, this gap is typically small enough to produce a large bandwidth of operation. The attained stop-band with the implemented dimensions goes from 40 GHz to 77 GHz. These dimensions will be employed in the rest of the paper to design different waveguide structures.

Following the studies presented in [2], the electric field attenuation in the lateral direction, as a function of the frequency is shown in Fig. 3. According to this figure, more than 60 dB attenuation can be achieved by two periods of the proposed EBG in the middle of the stop-band (Fig. 3(a)), while the

E-field is not attenuated outside the stop-band (Fig. 3(b)).

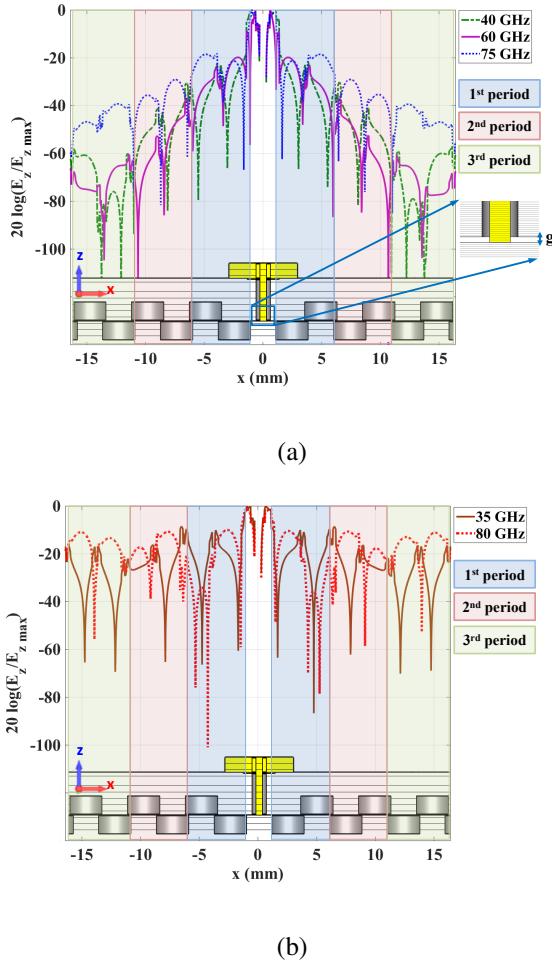

Fig. 3: Attenuation rate of the electric field in the proposed EBG structure for (a) frequencies inside the stop-band. (b) frequencies outside the stop-band. (stopband: 40 GHz- 77 GHz)

III. GLIDE-SYMMETRIC EBGs FOR WAVEGUIDES

For frequencies above 30 GHz, due to the small dimensions needed for waveguides, manufacturing hollow metallic waveguide structures can be difficult, especially for complicated circuits that cannot be easily manufactured in two parts [2]. The manufacturing process in this range of frequencies requires high accuracy and small perturbations in the walls create significant losses in hollow metallic waveguides.

One way to produce low-cost metallic waveguides at high frequency is to fabricate them in two parts and to use EBG structures at the side walls in order to prevent any leakage in the operating frequency band of the EBG (the working principle of the gap waveguides [23]), without requiring electrical contact between the two parts of the waveguide afterwards. Here, we investigate that technique. However, instead of using the conventional bed of nails, we make use of glide-symmetric holey metasurfaces. A standard RW (WR19), made from two metallic plates, is considered as the base waveguiding structure and a glide-symmetric holey EBG is

used at the side walls of the RW to reduce the leakage. If full contact is achieved between the upper and lower plate, the structure will resemble a perfect RW. However, in the practical implementation, it is hard to assess good plate flatness and to avoid screwing errors, which causes air gaps between the parts of the waveguide structure. The proposed glide-symmetric holey EBG reduces significantly the potential leakage created by those unpredictable gaps.

In this section, to validate the performance of the proposed waveguiding structure, a straight waveguide, a double 90° bent waveguide, and coupled waveguide lines are designed and investigated through simulations.

A. Straight Waveguide

In order to study the performance of the glide-symmetric holes, a 25 cm (around $42\lambda_0$ at 50 GHz) straight integrated waveguide made of aluminum is considered here. The dimensions of the waveguide correspond to WR19 (4.77 mm x 2.39 mm) for the U-band (40-60 GHz). A very long waveguide is chosen to increase the amount of losses and to reduce the uncertainties in the posterior measurement process.

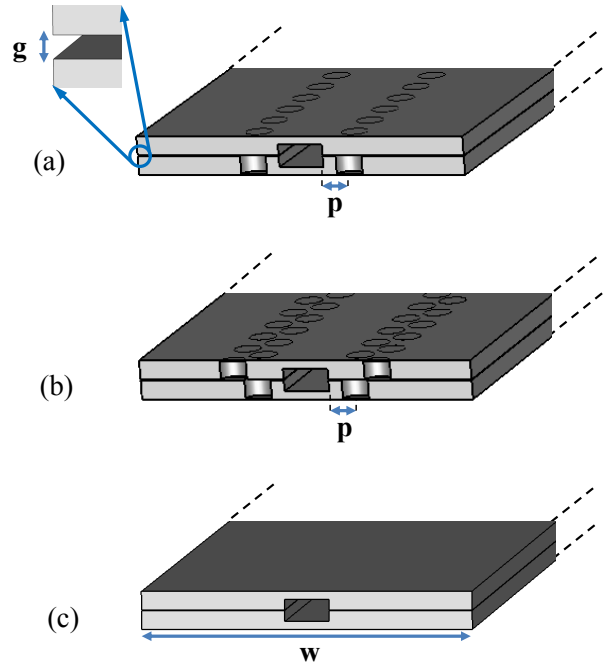

Fig. 4: RW made of two layers with an air gap in between: (a) One row of glide-symmetric holes at the location of gap. (b) Two rows of glide-symmetric holes at the location of gap. (c) No holey structure at the location of gap.

Three different waveguide structures with an air gap between the two waveguide parts are considered: the standard one and the ones with one row and two rows of glide-symmetric holey structure (as shown in Fig. 4). In these structures, the first row of holes is located at a distance $p = 2.8$ mm from the walls of the waveguides, which is essential to prevent reflections from holes, since a part of the lateral parallel plate waveguide contributes to transmission in the case of having an air gap. It should be noted that, in order to

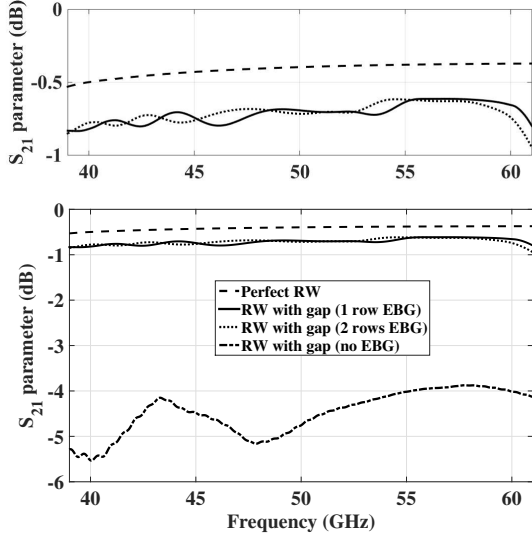

Fig. 5: Comparison of S_{21} parameters corresponding to the three waveguiding structures shown in Fig. 4, and a reference RW with no air gap.

accommodate the glide-symmetric holey structure at both sides of the waveguide, the unit-cell shown in Fig. 1 has been rotated 45 degrees and the half holes have been removed to prevent unwanted resonances. These structures will be compared with a standard shielded RW and a standard RW with an air gap at the side walls (Fig. 4 (c)). The gap on the side walls is kept at $g = 0.05$ mm following the examples in previous sections.

Fig. 5 contains a comparison of the calculated S-parameters of the four considered aluminum made waveguides. The S_{21} parameter of the RW with air gap and without holes is around -4 dB in the whole U-band. This demonstrates that small gaps in the waveguide walls excite parallel plate modes and, thus, create leakage. It must be noted the leakage amount grows when the size of the structure increases. The S_{21} parameters of the proposed waveguide structures with one and two rows of glide symmetric holes are very similar, in the range of -0.6 dB to -0.8 dB. Therefore, we can assume that only one row of the glide-symmetric holey structure provides acceptable shielding for a straight line. The S_{21} parameter of the both structures is close to the S_{21} parameter of a perfectly shielded RW made of aluminum, which falls in the range of -0.35 dB to -0.55 dB. It should be noted that these losses are due to the fact that aluminum is considered instead of a perfect electric conductor. In these simulations, the total width of the considered structures is $w = 35$ mm.

B. Double 90° Bent Waveguide

In order to demonstrate the shielding feasibility of the proposed method, an aluminum made waveguide with a double 90° bent is designed (see Fig. 6) and the calculated results are compared with a conventional RW. The length of this structure is $L = 28$ cm, which is approximately $47\lambda_0$ at 50 GHz, and the same gap between the two plates is considered as before. Additional studies demonstrate that for a bent line, at least two rows of the glide-symmetric holey EBG

structure at the location of the gap are required to ensure acceptable shielding. The comparison of the S-parameters of the considered structure and the double 90° bent aluminum ideal RW is represented in Fig. 7. The S_{21} parameter of the proposed EBG bent waveguide takes a value between -0.7 dB and -1.5 dB, whilst the S_{21} parameter of the bent aluminum ideal RW is between -0.4 dB and -0.7 dB in the U-band.

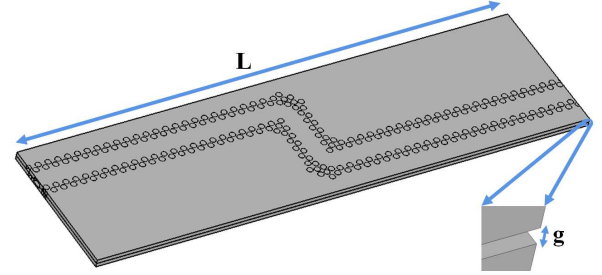

Fig. 6: Structure of a double 90° bent waveguide with two rows of glide-symmetric holey EBG at the location of the gap on side walls.

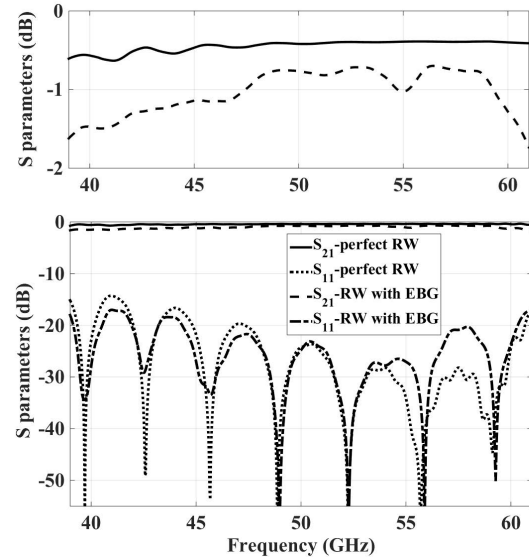

Fig. 7: Comparison of S_{21} parameters for a double 90° bent waveguide structure with glide-symmetric EBG and air gap, and RW without air gap.

The electric field distributions of a double 90° bent aluminum RW, an RW with an air gap of $g = 0.05$ mm, and an RW with the lateral glide-symmetric holey EBG at the location of the air gap are represented in Fig. 8. As discussed in Section III.A, and demonstrated in Fig. 8 (b), even a very small gap on side walls excites parallel plate modes and produces a significant leakage. However, by placing two rows of glide-symmetric holey EBG at side walls, we can have almost perfect transmission in the operation frequency range of the EBG structure that covers all the U-band.

C. Coupled Lines

Since the waveguides in the proposed technology are not completely shielded, we study here the cross-talk characteristic

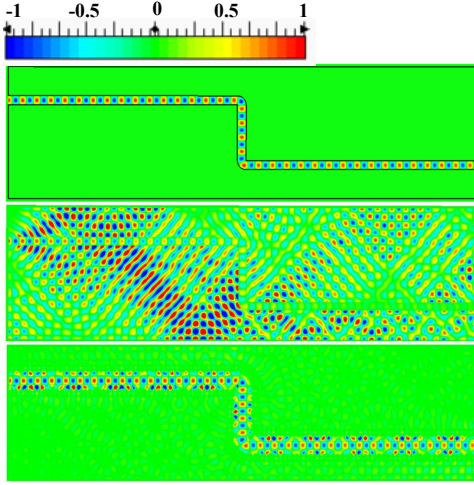

Fig. 8: Normalized electric field distribution of (a) a double 90° bent aluminum RW, (b) a waveguide with an air gap on the side walls, (c) the proposed waveguide structure with a glide-symmetric holey EBG.

between different waveguides sharing a common structure [24]. This cross-talk is analyzed in terms of mutual coupling of two waveguides placed side-to-side. Two structures, one with an air gap and another one with an air gap and one row of glide-symmetric holey EBG in between are considered (see Fig. 9). The distance between the two waveguides is $d = 4.7$ mm.

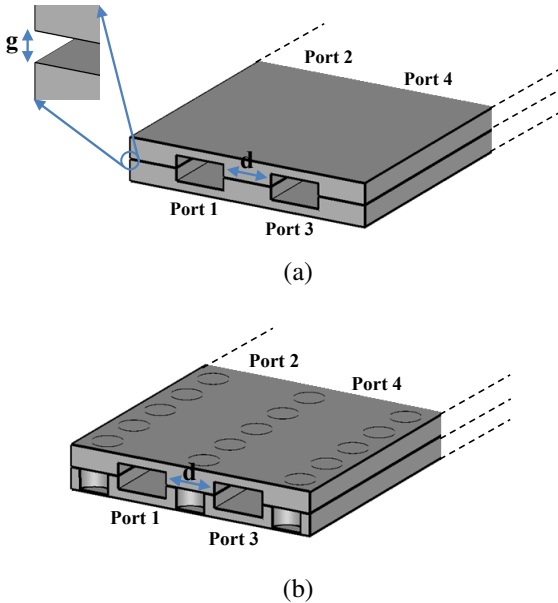

Fig. 9: Structure of the two waveguides placed side by side when: (a) an air gap is located on side walls. (b) one row of glide-symmetric holey EBG is placed at the location of gap.

The calculated S-parameters of the structure shown in Fig. 9 (a), with the air gap of $g=0.05$ mm, are represented in Fig. 10. These results demonstrate the conclusion drawn before regarding the fact that a small gap on the side walls of the waveguide excites parallel plate modes and reduces the transmission. By placing only one row of glide-symmetric holey

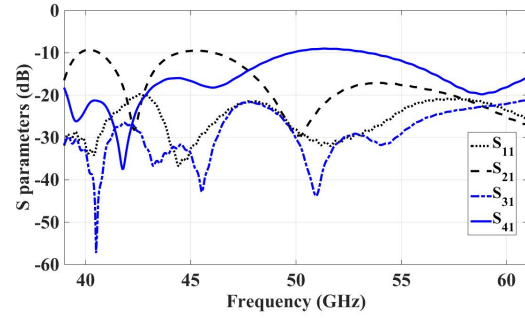
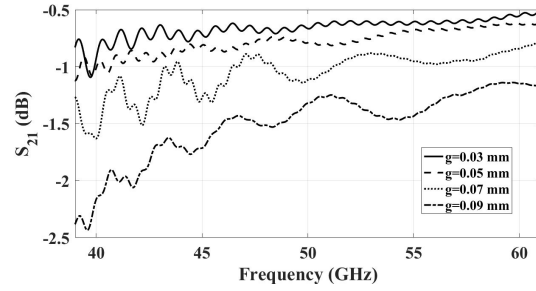
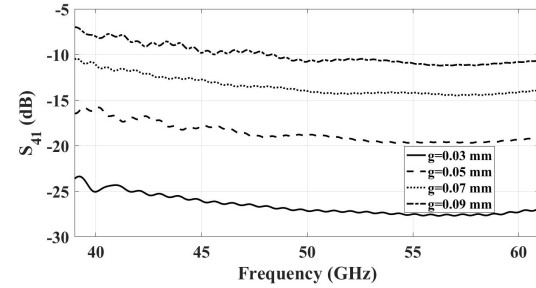

Fig. 10: S-parameters of the two waveguides placed side by side of Fig. 9 (a) when an air gap of 0.05 mm is located on the side walls.



(a)



(b)

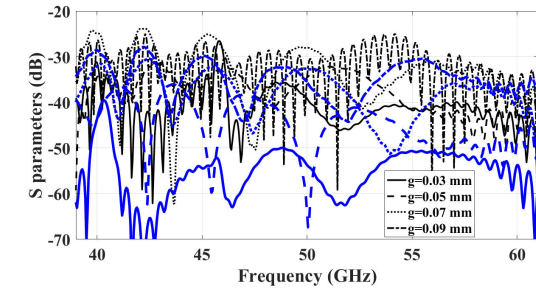

(c)

Fig. 11: S-parameters of the two waveguides placed side by side of Fig. 9 (b) when one row of glide-symmetric holey EBG is placed at the location of gap. (a) S_{21} . (b) S_{41} . (c) S_{11} and S_{31} parameters are shown with black and blue lines respectively.

EBG at the location of the gap, cross-talk free transmission is achieved up to a certain gap size, as demonstrated in Fig. 11. The parametric study on the size of air gap shows that S_{21} and S_{41} parameters remain above -1.5 dB and below -10 dB, respectively in whole working frequency range up to the air gap of $g=0.07$ mm. It should be noted the gap of 0.09 mm is electrically large, i.e. it is about 4% of the smaller side

of inner dimensions of the rectangular waveguide in U-band (4.7752 mm×2.3876 mm).

IV. EXPERIMENTAL RESULTS

In order to validate the performance of the proposed gap waveguide structure, two sets of integrated waveguides, one with the glide-symmetric holey EBG (Fig. 12) and one without EBG (Fig. 13), have been manufactured. These prototypes were manufactured in two pieces and joined together with screws to reduce manufacturing costs as discussed in previous sections.

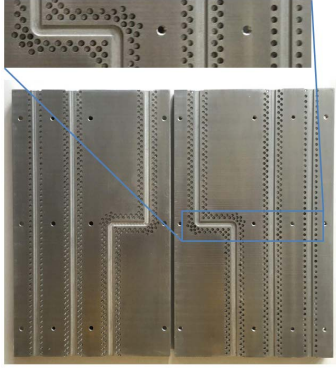

Fig. 12: Integrated circuit for verifying the performance of straight and double 90° bent waveguide lines with the proposed method. Glide-symmetric holey EBG is drilled at the location of the junction.

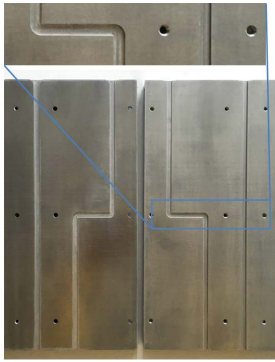

Fig. 13: Integrated circuit for verifying the performance of straight and double 90° bent waveguide lines. There is no EBG structure at the location of the junction.

Since the air gap produced by plate flatness tolerances and manufacturing errors cannot be measured in practice and it depends on the manufacturing technique and accuracy, in the simulations, a constant and well-defined gap size was considered. To produce a fair comparison, we have manufactured two identical prototypes with and without holes and compared with each other to distinguish the effect of glide-symmetric holey EBG at the location of gap. In order to have acceptable manufacturing tolerances, only one screw every 10 centimeters has been used to attach the two plates together. Two alignment pins have also been employed to ensure the relative position between upper and lower plates. The integrated waveguides have been excited using conventional transitions, since the dimensions of the manufactured rectangular waveguides are

standard ones. This is an advantage of the proposed waveguiding structure, since to design transitions to/from the proposed structure is not required.

The comparison of the measurement results of S-parameters corresponding to the integrated straight waveguides with and without EBG is presented in Fig. 14. The conclusions derived in the study via simulations are clearly validated here; the transmission level when the EBG structures is used is very high compared to the case without EBG.

Concerning the effect of the number of rows to be employed, Fig. 15 represents the comparison of S_{21} parameter of the two 25 cm straight aluminum made waveguides with one and two rows of the glide-symmetric holey EBG (the prototypes are shown in Fig. 12). Here again, the measurement result agrees well with the conclusion obtained in part A of section III that one row of glide-symmetric holey EBG provides similar results as two rows for straight versions.

Finally, the transmission levels using a 28 cm long aluminum made double 90° bent waveguide with and without the proposed EBG structure are represented in Fig. 16. According to these measurements, when we do not use the lateral EBG structure, the S_{21} parameter is below -10 dB in all the passband. To have an acceptable transmission, two rows of glide-symmetric holes at both sides of the integrated bent waveguide are needed as experimentally demonstrated in the same figure. It should be noted that the aluminum losses as well as losses created by the surface roughness of these long waveguides have considerable effect on the S-parameters.

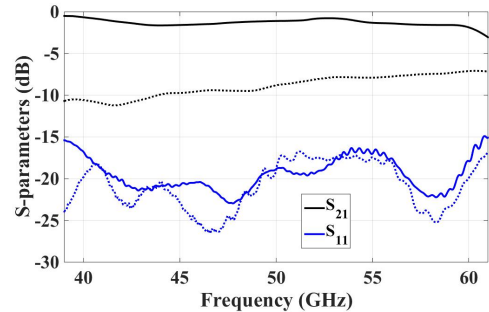

Fig. 14: Comparison of S-parameters corresponding to straight waveguides with and without glide-symmetric holey EBG at the location of the junction. Solid and dashed lines correspond to the cases with and without glide-symmetric holey EBG at the location of the junction, respectively.

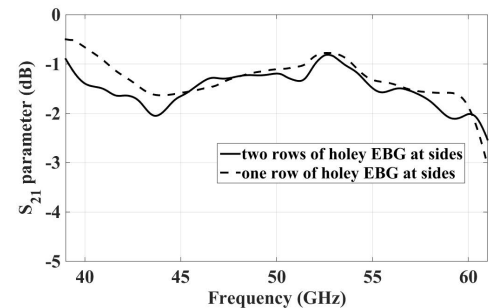

Fig. 15: Comparison of S_{21} parameter corresponding to the straight waveguide with one and two rows of glide-symmetric holey EBG at the sides.

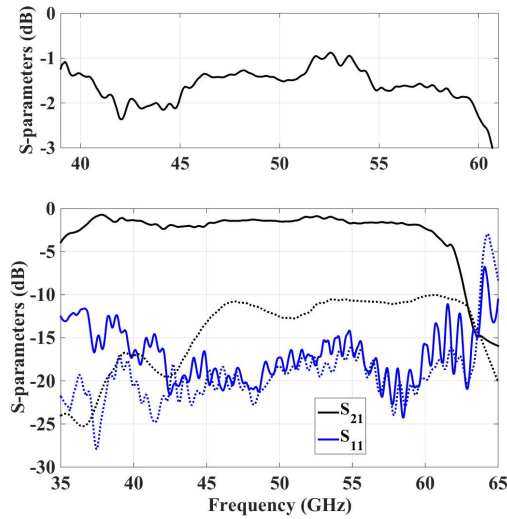

Fig. 16: Comparison of S-parameters corresponding to the double 90° bent waveguides with and without glide-symmetric holey EBG at the location of the junction. Solid and dashed lines correspond to the cases with and without glide-symmetric holey EBG at the location of the junction, respectively.

V. CONCLUSION

In this work, a cost-effective solution for manufacturing integrated metallic waveguides at high frequencies is presented. Using the proposed method, metallic waveguides at high frequencies can be manufactured in two parts and joined by screws. A glide-symmetric holey EBG structure at the location of the connection provides appropriate shielding. The proposed method is similar to groove gap waveguide technology in which pin-type EBGs were used to provide shielding. In all different methods of manufacturing such as EDM die sinking, molding and casting, and CNC milling, manufacturing glide-symmetric holey EBG is potentially cheaper and easier than pin-type EBG at the same operational frequency. The periodicity of our proposed structure is about 2.5 times larger than pins. Therefore, a lower accuracy for manufacturing may be employed. Our proposed method is suitable for mass production. For example, in the CNC milling case, drilling shallow holes is easier than drilling tall and thin pins. For making pins, one would need to drill grooves between the pins, which is more complicated, especially for non-regular distribution of pins. Moreover, if the pins are thin, they can easily break during the drilling process. In this paper, in order to demonstrate the feasibility of the proposed waveguiding structure, straight, double 90° bent, and coupled waveguides have been designed and simulated. The performance of the designed structures has been tested through measurement.

ACKNOWLEDGMENTS

The authors would like to show their gratitude for the supportive and encouraging comments of Prof. Per Simon Kildal on this work.

REFERENCES

[1] D. M. Pozar, *Microwave engineering*, ch. 3. John Wiley & Sons, 2012.

[2] P. S. Kildal, A. U. Zaman, E. Rajo-Iglesias, E. Alfonso, and A. Valero-Nogueira, "Design and experimental verification of ridge gap waveguide in bed of nails for parallel-plate mode suppression," *IET Microwaves, Antennas Propagation*, vol. 5, no. 3, pp. 262–270, 2011.

[3] G. L. Huang, S. G. Zhou, T. H. Chio, H. T. Hui, and T. S. Yeo, "A low profile and low sidelobe wideband slot antenna array fed by an amplitude-tapering waveguide feed-network," *IEEE Transactions on Antennas and Propagation*, vol. 63, no. 1, pp. 419–423, Jan 2015.

[4] F. Shigeaki, "Waveguide line (in Japanese)," Patent number 06-053 711, 02 25, 1994.

[5] D. Deslandes and K. Wu, "Design consideration and performance analysis of substrate integrated waveguide components," in *32nd European Microwave Conference*, Sept 2002, pp. 1–4.

[6] P. S. Kildal, E. Alfonso, A. Valero-Nogueira, and E. Rajo-Iglesias, "Local metamaterial-based waveguides in gaps between parallel metal plates," *IEEE Antennas and Wireless Propagation Letters*, vol. 8, pp. 84–87, 2009.

[7] A. A. Brazalez, E. Rajo-Iglesias, J. L. Vazquez-Roy, A. Vosoogh, and P. S. Kildal, "Design and validation of microstrip gap waveguides and their transitions to rectangular waveguide, for millimeter-wave applications," *IEEE Transactions on Microwave Theory and Techniques*, vol. 63, no. 12, pp. 4035–4050, 2015.

[8] A. U. Zaman, M. Alexanderson, T. Vukusic, and P. S. Kildal, "Gap waveguide PMC packaging for improved isolation of circuit components in high-frequency microwave modules," *IEEE Transactions on Components, Packaging and Manufacturing Technology*, vol. 4, no. 1, pp. 16–25, 2014.

[9] E. Rajo-Iglesias and P. S. Kildal, "Numerical studies of bandwidth of parallel-plate cut-off realised by a bed of nails, corrugations and mushroom-type electromagnetic bandgap for use in gap waveguides," *IET Microwaves, Antennas Propagation*, vol. 5, no. 3, pp. 282–289, 2011.

[10] A. Valero-Nogueira, M. Baquero, J. I. Herranz, J. Domenech, E. Alfonso, and A. Vila, "Gap waveguides using a suspended strip on a bed of nails," *IEEE Antennas and Wireless Propagation Letters*, vol. 10, pp. 1006–1009, 2011.

[11] A. U. Zaman, P. S. Kildal, and A. A. Kishk, "Narrow-band microwave filter using high-Q groove gap waveguide resonators with manufacturing flexibility and no sidewalls," *IEEE Transactions on Components, Packaging and Manufacturing Technology*, vol. 2, no. 11, pp. 1882–1889, Nov 2012.

[12] E. Pucci, A. U. Zaman, E. Rajo-Iglesias, P. S. Kildal, and A. Kishk, "Study of Q-factors of ridge and groove gap waveguide resonators," *IET Microwaves, Antennas Propagation*, vol. 7, no. 11, pp. 900–908, Aug 2013.

[13] A. U. Zaman and P. S. Kildal, "Wide-band slot antenna arrays with single-layer corporate-feed network in ridge gap waveguide technology," *IEEE Transactions on Antennas and Propagation*, vol. 62, no. 6, pp. 2992–3001, June 2014.

[14] F. Fan, J. Yang, and P. S. Kildal, "Half-height pins - a new pin form in gap waveguide for easy manufacturing," in *10th European Conference on Antennas and Propagation (EuCAP)*, Apr 2016, pp. 1–4.

[15] M. Ebrahimpouri, O. Quevedo-Teruel, and E. Rajo-Iglesias, "Design guidelines for gap waveguide technology based on glide-symmetric holey structures," *IEEE Microwave and Wireless Component Letters*, 2017.

[16] A. Hessel, M. H. Chen, R. C. M. Li, and A. A. Oliner, "Propagation in periodically loaded waveguides with higher symmetries," *Proceedings of the IEEE*, vol. 61, no. 2, pp. 183–195, Feb 1973.

[17] O. Quevedo-Teruel, M. Ebrahimpouri, and M. Ng Mou Kehn, "Ultrawideband metasurface lenses based on off-shifted opposite layers," *IEEE Antennas and Wireless Propagation Letters*, vol. 15, pp. 484–487, Dec 2016.

[18] G. Valerio, Z. Sipus, A. Grbic, and O. Quevedo-Teruel, "Accurate equivalent-circuit descriptions of thin glide-symmetric corrugated metasurfaces," *IEEE Transactions on Antennas and Propagation*, in press 2017.

[19] F. Ghasemifard, M. Norgren, and O. Quevedo-Teruel, "Dispersion analysis of two dimensional glide-symmetric corrugated metasurfaces using mode-matching technique," *submitted to IEEE Microwave and Wireless Component Letters*, 2017.

[20] O. Dahlberg, R. Mitchell-Thomas, and O. Quevedo-Teruel, "Reducing the dispersion of periodic structures with twist and polar glide symmetries," *submitted to Scientific Reports*, 2017.

[21] M. Ebrahimpouri, E. Rajo-Iglesias, Z. Sipus, and O. Quevedo-Teruel, "Low-cost metasurface using glide symmetry for integrated wave-

- uides,” in *10th European Conference on Antennas and Propagation (EuCAP)*, Apr 2016, pp. 1–2.
- [22] D. Dawn, Y. Ohashi, and T. Shimura, “A novel electromagnetic bandgap metal plate for parallel plate mode suppression in shielded structures,” *IEEE Microwave and Wireless Components Letters*, vol. 12, no. 5, pp. 166–168, 2002.
- [23] E. Rajo-Iglesias and P.-S. Kildal, “Groove gap waveguide: A rectangular waveguide between contactless metal plates enabled by parallel-plate cut-off,” in *Fourth European Conference on Antennas and Propagation (EuCAP)*, 2010, pp. 1–4.
- [24] M. Pasion, M. Bozzi, and L. Perregini, “Crosstalk in substrate integrated waveguides,” *IEEE Transactions on Electromagnetic Compatibility*, vol. 57, no. 1, pp. 80–86, 2015.