



This item was submitted to Loughborough's Institutional Repository (<https://dspace.lboro.ac.uk/>) by the author and is made available under the following Creative Commons Licence conditions.



**CC creative commons**  
COMMONS DEED

**Attribution-NonCommercial-NoDerivs 2.5**

**You are free:**

- to copy, distribute, display, and perform the work

**Under the following conditions:**

**BY:** **Attribution.** You must attribute the work in the manner specified by the author or licensor.

**Noncommercial.** You may not use this work for commercial purposes.

**No Derivative Works.** You may not alter, transform, or build upon this work.

- For any reuse or distribution, you must make clear to others the license terms of this work.
- Any of these conditions can be waived if you get permission from the copyright holder.

**Your fair use and other rights are in no way affected by the above.**

This is a human-readable summary of the [Legal Code \(the full license\)](#).

[Disclaimer](#) 

For the full text of this licence, please go to:  
<http://creativecommons.org/licenses/by-nc-nd/2.5/>

# Cost estimation for rapid manufacturing – laser sintering production for low to medium volumes

M Ruffo\*, C Tuck, and R Hague

Wolfson School of Mechanical and Manufacturing Engineering, Loughborough University, Leicestershire, UK

The manuscript was received on 25 November 2005 and was accepted after revision for publication on 2 May 2006.

DOI: 10.1243/09544054JEM517

**Abstract:** Rapid manufacturing (RM) is a modern production method based on layer by layer manufacturing directly from a three-dimensional computer-aided design model. The lack of tooling makes RM economically suitable for low and medium production volumes. A comparison with traditional manufacturing processes is important; in particular, cost comparison. Cost is usually the key point for decision making, with break-even points for different manufacturing technologies being the dominant information for decision makers. Cost models used for traditional production methodologies focus on material and labour costs, while modern automated manufacturing processes need cost models that are able to consider the high impact of investments and overheads. Previous work on laser sintering costing was developed in 2003. This current work presents advances and discussions on the limits of the previous work through direct comparison. A new cost model for laser sintering is then proposed. The model leads to graph profiles that are typical for layer-manufacturing processes. The evolution of cost models and the indirect cost significance in modern costing representation is shown finally.

**Keywords:** rapid prototyping, rapid manufacturing, cost model, low-volume manufacture, laser sintering

## 1 INTRODUCTION

With the arrival of additive manufacturing technologies, some traditional production methods could be replaced with technologies that are derived from existing rapid prototyping (RP) [1]. The main benefit of implementing these new technologies lies in the ease of passing from design to production, avoiding intermediate steps such as tool creation. If tooling can be removed from manufacturing, several advantages can be gained; namely, enabling the manufacture of low-volume products and increased design flexibility [2, 3].

The evolution of RP for the production of end-use parts is termed rapid manufacturing (RM) [4]. The basis of RM lies in the direct production of components from a three-dimensional computer-aided design (3D-CAD) model. The model is 'digitally' sliced into a distinct number of layers

and these layers are reconstructed into a physical form by the RM machine [5]. The main feature of current machines, although their *modus operandi* differs greatly, is that they are able to produce virtually any geometry without the need for tools. RP processes include stereolithography (SL), laser sintering (LS), fused deposition modelling (FDM) and three-dimensional printing (3DP) among others [6]. LS and SL systems are currently the most widely used for RM applications.

Though materials developments are still necessary for the more widespread use of RM, other limitations currently exist [7, 8], namely:

- (a) process speed;
- (b) dimensional accuracy;
- (c) surface finish;
- (d) repeatability.

All these problems are the subject of research on a global scale, although many manufacturers are today able to cope with the limitations of the current systems to their advantage.

\*Corresponding author: Wolfson School of Mechanical and Manufacturing Engineering, Loughborough University, Leicestershire LE11 3TU, UK. email: M.Ruffo@lboro.ac.uk

An important consideration for the uptake of RM is its cost effectiveness compared to classical production methods, among which injection moulding is significant for plastic products. In fact, if the future of RM is to be competitive with traditional processes, economic visibility will play a determining role, assuming that those technical limitations discussed earlier are overcome.

This paper aims to define and outline the thinking behind a cost model for RM and further develops this with a working model of a typical part being produced using an LS machine. The costing method should provide a transparent costing of the part for comparison with other manufacturing methods.

## 2 LITERATURE REVIEW

### 2.1 Costing in modern manufacturing

In a modern manufacturing environment, overhead costs are growing as manufacturers promote levels of automation and computerization, and thus, the cost distortion of traditional cost systems is significant [9]. For this reason, a gradual change of cost models is necessary. From the literature, the possible reasons for adopting new cost systems are [10]:

- traditional costing systems do not provide non-financial information, useful for manager's decision making;
- product costing is inaccurate;
- costing systems should encourage improvements;
- overhead costs are higher than labour costs.

The last point, in particular, is interesting for automated technologies introduced in modern industrial processes. In fact, the continuous increase

of automation and decrease of manual labour in manufacturing processes changes the product cost, thus increasing the importance of overheads.

### 2.2 Costing for RP and RM

Grimm [11] studied the hourly cost to run different RP machines and compared the results. He developed the tests with three 'typical' parts, but the definition of 'typical' as representative for production is arguable. The assumptions made by Grimm were interesting (such as percentage of the envelope capacity used, working hours, etc.), but suitable for an RP environment, while in the case of RM the scenario changes owing to simultaneous multiple parts building.

An RM cost study was developed in 2003 by Hopkinson and Dickens [12]. The authors calculated the cost of a part assuming that the machine was producing only copies of the same part and using a constant production time. Their model was used to calculate a first approximation break-even analysis with injection moulding (IM). LS manufacture was compared against IM techniques in order to find when RM was economically convenient. Figure 1 is a typical example of the results of the study conducted by the two authors.

The IM curve decreases because the initial cost of the mould is amortized across the production volume. The RM line is constant, supposing that all indirect costs are charged on every single part, dividing the total indirect cost for the number of parts produced (i.e. machine depreciation in 8 years). This model is a good approximation, but only valid where the RM method is making (a) copies of the same part; (b) relatively high production volumes.

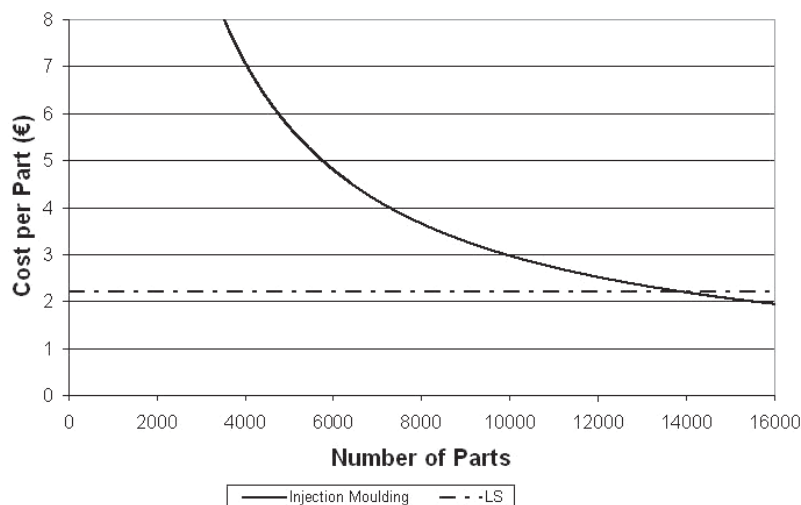

Fig. 1 Example of break-even analysis comparing LS with injection moulding (source: Hopkinson and Dickens [12])

The flexibility of additive techniques allows the production of more than one part at a time. In addition, the parts in production can be different from one another. For this reason it is possible to define RM as a *parallel* process, where different parts can be built contemporaneously. Also, if the production regards only copies of the same part, the graph of Fig. 1 is incorrect for lower production volumes. In fact, just as the IM process has to amortize the initial cost of the tool, the RM process needs to amortize the investment of buying the machine. Therefore, the RM production curve must have a deflection for low-volume production, taking into consideration the fixed time and cost described above.

It is the object of this study to find a relationship between a part and its cost in the case of LS manufacturing. It follows a production analysis of copies of the same part, which leads to a model, valid for both low- and high-volume production, expanding on the existing model of Hopkinson and Dickens [12]. A comparison between the old and the new model is then presented, detailing the main differences.

### 2.3 Cost-estimation techniques

There are some principal quantitative approaches to cost estimation for building the mathematical model [13, 14].

1. *Analogy-based techniques*. These are based on the concept of deriving an estimation from actual information regarding similar real products.
2. *Parametric models*. Here, the cost is expressed as an analytical function of a set of variables, usually called cost-estimation relationships (CERs) [15].
3. *Engineering approaches*. Here, the estimated cost is calculated in a very analytical way as the sum of its elementary components, constituted by the value of the resources used in each step of the production process. This approach can only be used when the characteristics of the processes are well defined.
4. There is also a different approach developed by Cavalieri *et al.* [16]. They studied the possibility of replacing a classic costing model with one based on an *artificial neural network*. The results obtained in a case study confirm the validity of this innovative method, giving results similar and sometimes better than classical approaches, but with the limitation of a reduced possibility of interpreting and modifying data.

The model presented in this paper is placed between the parametric model and the engineering approach, as the relationships found are

approximations based on statistics, although most of the data are defined.

Besides the mathematical model approaches, there are different methodologies to split costs to different sections of the model. During the study, several costing methodologies were approached, such as activity-based costing [17–20], total lifecycle costing [21], target costing [16], and full costing [21]. The model presented in this paper has been formulated in order to attribute the *full cost* of an RM organization. This includes all costs of plant and production, costs of administration, and costs of the necessary overheads.

### 3 EXPERIMENTAL METHOD – MODEL FORMULATION

The most common steps in cost modelling involve the determination of [22]:

- (a) the scope, i.e. costs are subdivided into different types, which have to be modelled;
- (b) the allocation base for (overhead) costs;
- (c) the cost functions, i.e. the relationships between product parameters and costs.

The methodology used in this paper is general and open to any additive manufacturing technique, although the particular case studied here regards an LS machine, the 3D-Systems Vanguard [23].

#### 3.1 Scope: activities involved with RM

Table 1 shows activities involved with RM and their definitions. These activities were confirmed during previous work by Wohlers and Grimm [24].

The different activity costs of Table 1 can be split into two categories: direct and indirect costs. In the model presented, only the activity ‘material’ was considered to be a direct cost. Labour and machine

**Table 1** Activities associated with RM

Activity	Definition
Material	Cost of material purchase
Software	Cost of software purchase and upgrades
Hardware	PC purchase and upgrade cost
Capital equipment depreciation	Depreciation cost of capital equipment (i.e. LS machine)
Labour	Labour cost for machine set-up and any required post-processing (introduced in annual salary)
Maintenance	Capital equipment maintenance costs per annum
Production overhead	Costs incurred due to production, energy, and floor space
Administration overhead	Costs incurred due to running the enterprise, administrative staff, office space, and consumables

maintenance, which could be seen as direct costs, were allocated indirectly as they are annual payees with regular contracts. Moreover, it was supposed that the technician is working full-time only on RM, setting up machines and cleaning parts; this is a conservative model because the entire salary is allocated to RM production instead of supposing the operator is working on different tasks.

### 3.2 Data included in the model

The costing data collected and used in the model are typical for an RP department. An important assumption was made about the productivity of the LS machine, which was estimated to work 100 hours/week for 50 weeks/year (utilization of 57 per cent). Contact with industrial partners on the DTI-funded Foresight Vehicle Project, under which this work was undertaken [25], confirmed the difficulty of increasing the utilization over 60 per cent. The indirect activities of Table 1 can be summarized into four categories. Table 2 shows the categories with the associated cost/build hour.

Table 3 includes a detailed breakdown of the indirect costs used in the model.

Costs quoted are in line with those of the project's industrial partners [25]. The only direct cost used in this model was the material purchase; Duraform PA [26] is the material selected for the case study and sold at around €58 per kg (UK 2005).

### 3.3 Allocation base for costs

The machine purchase absorption and other indirect costs were allocated to each individual product by

**Table 2** Main indirect, cost activities and hourly rate

Main activities	Cost/h (€)
Production labour/machine hour	7.99
Machine costs	14.78
Production overhead	5.90
Administrative overhead	0.41

**Table 3** Indirect costs details

<i>Production overhead</i>		<i>Production labour</i>	
	€		€
Yearly rent rate (per m <sup>2</sup> )	130.5	Technician annual salary + employer contributions	32 770 (+ 22%)
Building area (m <sup>2</sup> )	246.5		
Energy consumption/h	1.5	<i>Machine costs</i>	€
		Machine & breakout station purchase	362 500 + 24 360
<i>Administration overhead</i>	€	Purchase cost/year*	45 313 + 3045
Hardware purchase	2175	Maintenance/year	21 750
Software purchase	2175	Software purchase	7250
Hardware cost/year*	435	Hardware purchase	4350
Software cost/year*	435	Software cost/year*	1450
Consumables per year	1450	Cost of software upgrades/year	1450
		Hardware cost/year	870

\* Depreciation time for computer hardware and software is 5 years, for the RM machine purchase is 8 years

the time in which the machine takes to produce them. Machine set-up and cleaning, warming up, and cooling down phases imply times in which the machine is not building layers. However, they must be considered for cost allocation, as each new build needs these fixed times (equivalent to a fixed cost). A scheme of the entire conceptual model is shown in Figure 2.

### 3.4 Cost estimation relationships (CERs)

The cost of a build ( $Cost_B$ ) is the sum of the indirect cost associated with the time of building ( $t_B$ ) and the direct cost associated with the material used during manufacture ( $m_B$ )

$$Cost_B = Cost(t_B) + Cost(m_B) \quad (1)$$

where

$$Cost(m_B) = \frac{direct\_Cost}{mass\_unit} m_B \quad (2)$$

$$Cost(t_B) = \frac{\sum indirect\_Costs}{working\_time} t_B \quad (3)$$

The time and material used during the build ( $t_B$  and  $m_B$  respectively) are the main variables of the costing model. Time refers to how long the machine works for the build; part mass (or volume) is an index of the raw material used.

#### 3.4.1 Equations for material

The material used in this case was Duraform PA, which is in a powder form. The material that has not been sintered is, in theory, recyclable. However, recycled powder has suffered from a thermal treatment and its mechanical properties are modified from the virgin state. Therefore, recycle is possible but with limitations, and must never exceed 67 per cent of the total, as stated in the material manual [27]. Moreover, after a few recycles it is advisable to discard the old powder, operating with virgin powder once more.

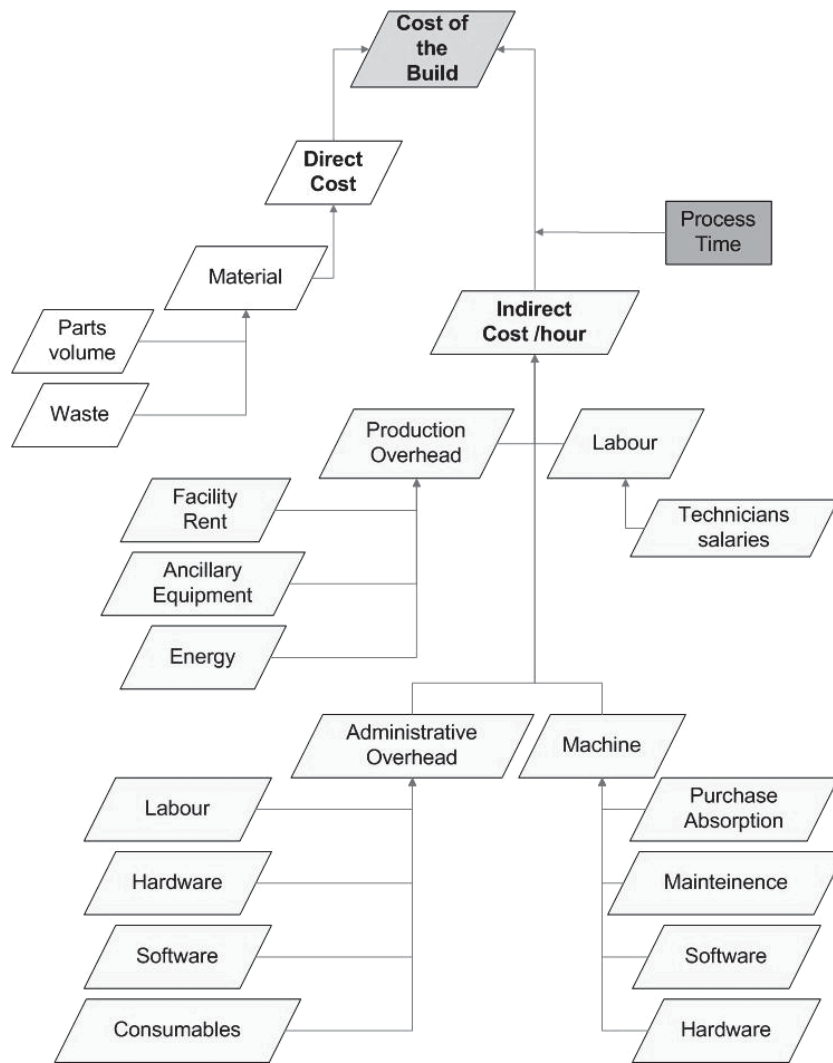

Fig. 2 Scheme of the costing model

The quantity of material sintered can be calculated if the density of the material ( $\rho = 0.6 \text{ g/cm}^3$  for Duraform PA [26]) and the volume of the build ( $V_B$ ) are known. In formulae

$$m_B = \rho * V_B \tag{4}$$

where

$$V_B = V_P * n_P \tag{5}$$

$V_B$  is the volume of the entire build, sum of the parts volume included in the production;  $V_P$  is the volume of a single part; and  $n_P$  is the total number of parts.

The number of parts that fit in a bed is described by the packing ratio ( $PR \in [0,1]$ ), which is defined as follows

$$PR = \frac{V_B}{V_{beds}} = \frac{V_P * n_P}{V_{beds}} \tag{6}$$

where  $V_{beds}$  is the total beds volume, which is the sum of the machine bed volumes required for the

planned production. The value of PR can vary: between zero, in the case of an empty bed (no production), and one, if the volume of the components equalizes the volume of the beds. The higher the packing ratio, the lower the waste in material and the production time per component, with a consequent cost saving.

The material used is the sum of the material sintered by the laser and the material lost during parts-cleaning or similar. Equation (4) was extended as

$$m_B = \rho * (V_B + W_B) \tag{7}$$

where  $W_B$  is the volume of the material wasted.

In this model the material wasted was calculated by setting a waste factor indicating the percentage of recycled powder

$$W_B = (V_{beds} - V_B) * \alpha \tag{8}$$

where  $\alpha \in [0,1]$  is the waste factor, depending on the manufacturer.

Grimm [7] affirms that the ratio of unsintered powder to part volume is always high (typically 10:1) and this leads to used powder that will never be claimed, with a stockpile of expensive unusable material as a consequence. Therefore, the powder recycle is set at 50 per cent as default, which seems to be the maximum value admissible, realistically.

### 3.4.2 Equations for time

There are three different times to calculate:

- time to laser scan the section and its border in order to sinter the powder ( $t_{xy}$ );
- time to add layers of powder (recoating time,  $t_z$ );
- time to heat the bed before scanning and to cool down slowly after scanning, adding layers of powder or just waiting time to reach the correct temperature ( $t_{HC}$ ).

The sum of the above-mentioned times is the total time necessary to complete a build ( $t_B$ ). In formulae

$$t_B = t_{xy} + t_z + t_{HC} \quad (9)$$

An empirical time estimator was developed by the current authors and it was used in this model to estimate all the times presented. In particular, the estimator was based on simulation results obtained with Build Setup ver3.4, which is the software driving the LS machine. This estimator did not consider directly the laser power and similar deep-technical variables, but these parameters were included in some macro parameters which assure an overestimation of the total production time. Estimation results were confirmed and validated by real builds. Both the software and the LS machine were used with the standard settings advised by the manufacturer for the sintering of the Duraform material; thus, the layer thickness was fixed to 0.1 mm. A detailed description of the time estimator can be found in Ruffo *et al.* [28].

### 3.4.3 Calculation tool

An Excel spreadsheet was designed for cost-estimation purposes. It is composed of:

- different sheets summarizing all the activities shown in Table 1 and relative costs;
- one sheet with the mathematical model presented;
- one sheet estimating build times;
- a sheet in which the main data (geometrical part variables and production volumes) are introduced and the results are shown;
- a visual basic application creating lists of cost data and drawing the relative graphs.

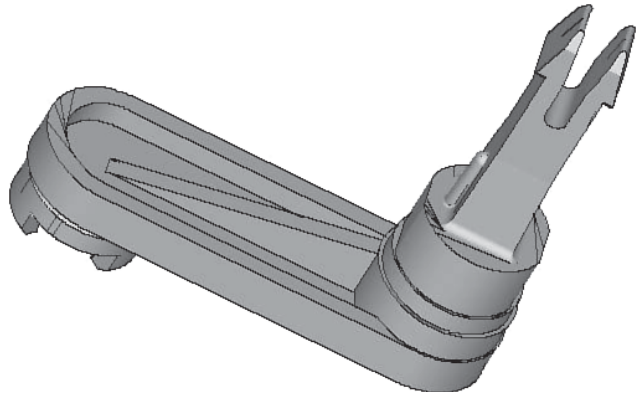

Fig. 3 Lever, the object of the study

## 4 RESULTS

The new costing model was used to calculate the production cost of the same part used in the previous study by Hopkinson and Dickens [12] – the lever shown in Fig. 3.

The resulting curve relating the cost/part with the production volume is shown in Fig. 4. A full machine bed envelope comprised 896 components, with each lever having a volume of 7106 mm<sup>3</sup>. The packing ratio intuitively varies with the number of components ‘nested’ in the build envelope, so each increment on the  $x$  axis corresponds to a different packing ratio. The optimum packing ratio was 0.12 for any full bed (896 components and multiples thereof).

Unlike the Hopkinson and Dickens study [12], which shows a constant cost for the LS parts, the curve has a deflection for *low production volumes* (less than 1500 parts in the case presented) and a change in the curve tendency whenever one of three following cases arise.

- It is necessary to use a new row in the  $x$  direction for the addition of a part (i.e. every 16 parts for the lever).
- It is necessary to add a new vertical layer for the addition of a part (i.e. every 128 parts for the lever).
- It is necessary to start a new bed for the addition of a part (i.e. every 896 parts for the lever).

Each of the three situations listed causes an increase of the manufacture time and the relative addition of indirect costs to the parts in production. For *high production volumes* the curve tends to stabilize. This happens because the indirect costs are split on a higher number of parts.

Both the initial transition and the final stabilized value of the curve depend upon:

- the *part size* – big parts quickly fill layers and machine beds, splitting the additional cost

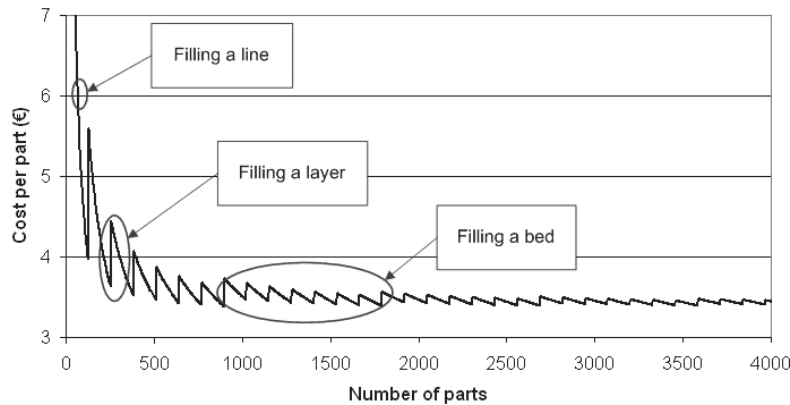

Fig. 4 Production curve for the lever (LS)

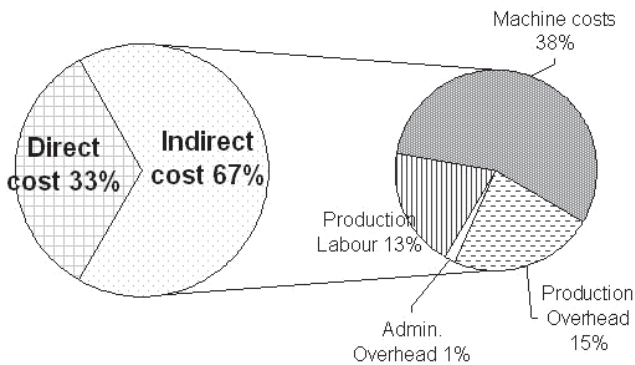

Fig. 5 Cost breakdown showing the weight of different activities on the total cost. Case of the lever in high volume production using LS (16 000 parts with a cost per part of €3.25)

between fewer parts; small parts allow a more fractionated assignment of indirect costs;

- (b) the *packing ratio* – it influences both build time and material waste, being a fundamental parameter for cost estimations.

Therefore, part size and packing ratio are drivers of the new model and, consequently, main factors to cost parts in RM.

Considering the case of high production volume, the cost per part of the lever calculated with the new model is €3.25. Figure 5 presents a breakdown of the lever cost evidencing the relevance of some activities in respect of others. Machine cost results are of particular importance for the economy of RM.

#### 4.1 Effect of different orientations on the part cost

The new model was also used to compare the manufacture of the same part built in different orientations. For example, Fig. 6 presents a manufacture simulation of a simple geometrical box built horizontally and vertically.

The investigation shows that setting parts flat is not always the economical best solution, as stated in previous studies [29]. In fact, for convenience, it is possible to switch between different configurations, depending on the number of parts produced and the relative packing ratio.

## 5 DISCUSSION

A comparison between the Hopkinson and Dickens model and the new RM cost model was developed, using the lever shown in Fig. 3. The comparison was based fairly on the production of the same part, using similar material and machine settings.

Figure 7 shows different production curves listed in temporal order of evolution; in particular:

- (a) the IM and Hopkinson and Dickens (HD) curves from the original model, dated 2003;
- (b) an RM curve obtained utilizing the new mathematical model, but driven by the assumptions used by Hopkinson and Dickens (RM2003);
- (c) an RM curve similar to the previous with the introduction of a 50 per cent material recycle (RM2003 R50);
- (d) an RM curve obtained by the new model and adopting a *full costing* system based on up-to-date data in 2005 (RM2005), which is the same Fig. 5, but converted in Euros, with an exchange rate £/€ = 1.45.

Table 4 presents a breakdown of the main assumptions used in the four cases above.

Figure 7 evidences different breakevens between IM and RM techniques for the different RM cost models utilized. The main differences in the graphs are:

- (a) the graphs marked as RM (indicating the new model) present a transition for low productions (below 4000 parts), which is missing in the HD curve;



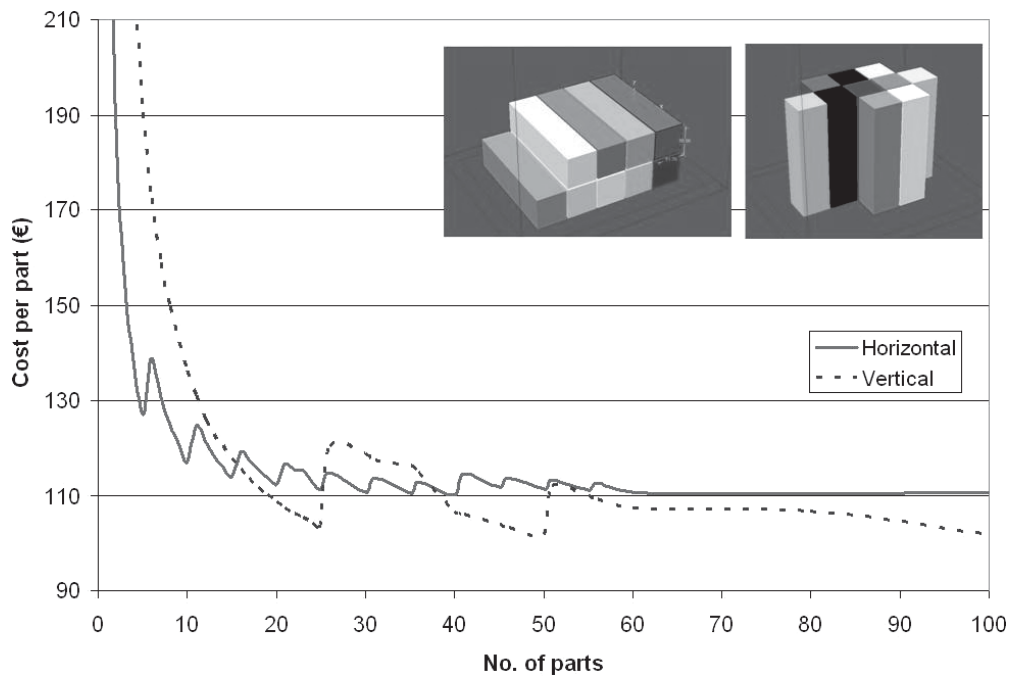

Fig. 6 Effect of different orientations on the cost

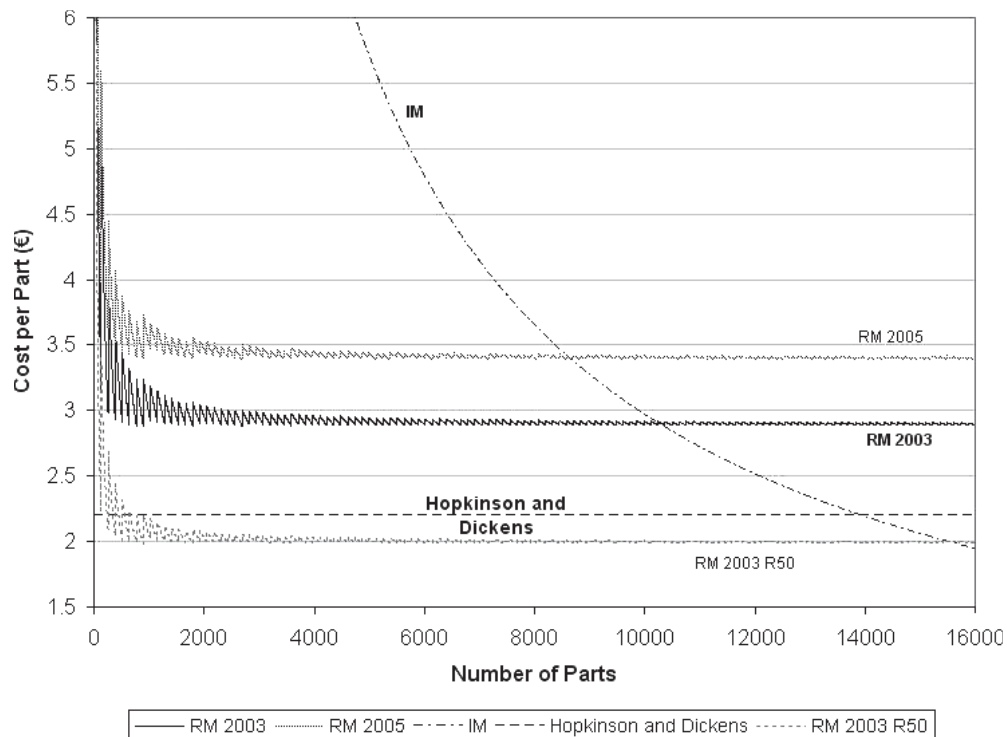

Fig. 7 Cost model comparison LS versus IM

(b) the stabilized value for higher production volumes (over 10 000 parts) is different for each model, as shown in Table 4.

The reasons for the discrepancies between the models (in particular the two temporal extremes

HD and RM2005) were analysed and a list of dissimilarities in the models is presented.

1. Hopkinson and Dickens schematized their model splitting the cost in three categories – machine, labour, and material – while the new model is

**Table 4** Main assumptions used in the different models

Activity	HD	RM2003	RM2003 R50	RM2005
Machine purchase (€)	340 000	340 000	340 000	375 000
Machine maintenance (year) (€)	30 450	30 450	30 450	22 500
Labour cost (€)	42.4 every 1056 parts	42.4 every 1056 parts	42.4 every 1056 parts	25 450 per year
Machine utilization %	90	90	90	57
Material cost (€)	54 / Kg	54 / Kg	54 / Kg	60 / Kg
Production and administration overheads	NO	NO	NO	YES
Recycle	NO	NO	50%	50%
Cost per part (building 1600 parts) (€)	2.20	2.76	1.86	3.36

based on more categories adopting a *full costing* system.

- Labour was considered by HD as a direct cost (8 labour hours every 1056 parts produced) while the new model adds the machine operator salary indirectly.
- The material recycle is not considered in the HD model.
- The machines used in the two models were similar but not the same; in particular, the HD machine was capable of producing 1056 parts/bed while the LS Vanguard used in the new model had a bed capacity of 896 parts
- The machine utilization set in HD was 90 per cent versus the more realistic 57 per cent of the new model, as explained previously.

The model comparison evidenced that Hopkinson and Dickens related the cost of RM mainly on material purchase. In fact, just considering the material recycle in the RM2003 model, LS production could appear very convenient (see curve RM2003 R50 in Fig. 7). In reality, LS is still an expensive process and the main reason is the initial investment of the machine purchase and its maintenance. Figure 8 shows the change in RM cost models during the last 2 years, from the HD model in which 74 per cent of the total cost was owing to material purchase, to the new model in which the importance of material cost is reduced to 33 per cent.

The machine cost, with its 38 per cent of the total (see Fig. 5), appears to be the main economical issue for RM. This result could be an indicator for the next generation of machines dedicated to layer manufacturing.

## 6 CONCLUSIONS

Owing to the continuous growth of overhead costs in modern manufacturing environments, the evolution of cost models is essential. In particular, RM consists of a series of new production processes that need to be evaluated economically and compared to different manufacturing systems.

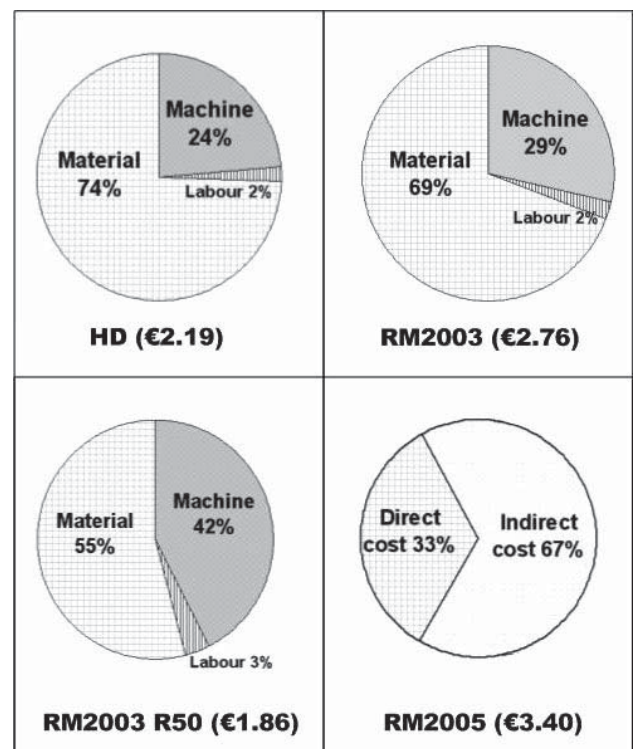

**Fig. 8** Pie charts showing the importance of cost categories for different models

Since 2003, the main method of cost estimation used by both academic and industrial users of LS was based on the HD model [12], which was inaccurate for very low production volumes and for different parts produced in parallel. The cost estimator presented in this paper is based on a 'full costing' concept and includes labour, material, machine absorption, production, and administrative overheads. The indirect costs were assigned to the components on a machine working-time basis. The main outcome achieved shows a curve relating the cost per part to the production volume. The curve has a saw tooth shape, owing to the filling of the machine bed-space. Specifically, if adding parts to a production set-up does not increase the number of layers (i.e. parts are added next to each other in the horizontal directions), the time and cost of the

build is efficient. In contrast, when a new part needs to be placed on a new layer, both time and cost for the build increase dramatically, owing to the enlarged build-height (which means additional layers for recoating). The same effect is present when the additional part causes the set-up of a new machine-bed.

The previous model, developed by Hopkinson and Dickens [12], was compared to the new model; firstly using the same assumptions made by the authors (purely to compare the mathematical model), then with the data up-to-date for 2005. The comparison evidenced an underestimation of the old model. The break-even point between RM and IM moved from 14 000 parts calculated by Hopkinson and Dickens in 2003, to 10 500 parts if the Hopkinson and Dickens assumptions are included in the new mathematical model, to 9000 parts obtained by the new estimator with data up-to-date for 2005.

A deeper analysis was conducted to ascertain the roots of the cost model evolution. Moving on a time-scale from the older to the current model, there was a significant increase in the indirect costs. The importance of the material cost was reduced from the 78 per cent (for the oldest model) to 33 per cent (for the latest model) of the total cost per part. Equally important, the machine investment and its maintenance played a significant role, passing from 24 per cent in the old model to 38 per cent of total costs in the model presented here. The study underlines the importance of keeping new technology cost models up-to-date, mainly because the high automation of processes moves costing relevance from labour and material to investments and overheads.

## REFERENCES

- 1 **Chua, C. K., Leong, K. F., and Lim, C. S.** *Rapid prototyping: principles and applications*. 2003 (World Scientific, Singapore).
- 2 **Mansour, S. and Hague, R.** Impact of rapid manufacturing on design for manufacture for injection moulding. *Proc. Instn Mech. Engrs, Part B: J. Engineering Manufacture*, 2003, **217**, 453–461.
- 3 **Hague, R., Mansour, S., and Saleh, N.** Material and design considerations for rapid manufacturing. *Int. J. Prod. Res.*, 2004, **42** (22), 4691–4708.
- 4 Plastic Machine and Auxiliaries online, Words of Wisdom: Rapid manufacturing on the horizon, <http://www.pma-magazine.com/articles/2003/October/4> [13 September 2005].
- 5 Anon rapid manufacturing – laser additive manufacturing. *Advanced Mater. Processes*, 2001, **159** (5), 32–36.
- 6 **Jacobs, P. F.** *Stereolithography and other RP&M techniques – from rapid prototyping to rapid tooling*, 1996 (ASME Press).
- 7 **Grimm, T.** *User's guide to rapid prototyping* (Rapid Prototyping Association of SME, Dearborn, Michigan) 2004.
- 8 **Wohlers, T.** *Wohlers Report 2004* (Wohlers Associates, Dearborn, Michigan).
- 9 **Brimson, J.** Activity accounting – an activity based costing approach, 1991 (John Wiley & Sons, New York, NY).
- 10 **Gunasekaran, A.** Design of activity-based costing in a small company: a case study. *Computers and Ind. Engng.* 1999, **37**, 413–416.
- 11 **Grimm, T.** *Rapid Prototyping benchmark*, 2003 (T. A. Grimm & Associates Inc.)
- 12 **Hopkinson, N. and Dickens, P.** Analysis of rapid manufacturing-using layer manufacturing processes for production. *Proc. I Mech. E Part C: J. Mechanical Engineering Science*, 2003, **217**.
- 13 **Bouaziz, Z., Ben Younes, J., and Zghal, A.** Methodology of machining costs evaluation for die and mould manufacturing. *J. Mater. Processing Technol.* 2004, **152**, 237–245.
- 14 **Brinke, E., Lutters, E., Streppel, T., and Kals, H.** Cost estimation architecture for integrated cost control based on information management. *Int. J. Computer Integrated Mfg.* 2004, **17** (6), 534–545.
- 15 NASA, *Parametric cost estimating handbook*, downloadable at <http://www.jsc.nasa.gov/bu2/pcehg.html> (accessed October 2005)
- 16 **Cavaliere, S., Maccarone, P., and Pinto, R.** Parametric vs. neural network models for the estimation of production costs: a case study in the automotive industry. *Int. J. Prod. Econ.*, 2004, **91**, 165–167.
- 17 **Gunasekaran, A.** Design of activity-based costing in a small company: a case study. *Computers and Ind. Engng.*, 1999, **37**, 413–416.
- 18 **Wen-Hsien, Tsai.** Activity-based costing model for joint products. In Proceedings of the 18th International Conference on Computers and industrial engineering, *Computers Ind. Engng.*, 1996, **31** (3/4), 725–729.
- 19 **Gunasekaran, A., McNeil, R., and Singh, D.** Activity-based management in a small company: a case study. *Production Planning and Control*, 2000, **11**(4), 391–399.
- 20 **Tumey, P. B. B.** COMMON CENTS – the ABC performance breakthrough, how to succeed with activity-based costing. *Cost technology*, 1992 (Hillsboro, Oregon).
- 21 **Atrill, P. and McLaney, E.** *Management accounting for non-specialists*, 1999 (Prentice-Hall Europe, London).
- 22 **Brinke, E.** *A cost estimation tool applied in the sheet metal domain*, 2002 (Ipskamp, Enschede, The Netherlands).
- 23 3D Systems website: [www.3dsystems.com](http://www.3dsystems.com), [19 January 2005].
- 24 **Wholers, T. and Grimm, T.** The real cost of RP. *Time Compression Technol.* 2002.
- 25 ManRM: Management, Organisation and Implementation of Rapid Manufacturing. Foresight vehicle research project developed at the Loughborough University and funded by the DTI.

- 26 Duraform PA description and material datasheet downloadable at: [http://www.3dsystems.com/products/datafiles/lasersintering/datasheets/DuraForm\\_uk.pdf](http://www.3dsystems.com/products/datafiles/lasersintering/datasheets/DuraForm_uk.pdf) [07 September 2005].
- 27 Guide to Duraform Materials, 3D Systems, May 2002, DCM 8002-10004-001.
- 28 **Ruffo, M., Tuck, C., and Hague, R.** An empirical laser sintering time estimator for Duraform PA. *Int. J. Prod. Res.*, accepted for publication, January 2006
- 29 **Choi, S. and Samevedam, S.** Modelling and optimisation of rapid prototyping. *Computers in Ind.*, 2002, **47**, 39-53.

RM2003		curve obtained by the new costing model using Hopkinson and Dickens assumptions
RM2003	R50	same as RM2003 with 50 percent recycled powder
RM2005		new model using up-to-date 2005 data
Subscripts		
B		build
beds		beds necessary to complete the build
HC		heat and cool phases
P		part
xy		scanning section in the x and y directions
z		recoating along z axis
t		time
V		volume
W		material waste
$\alpha$		waste factor
$\rho$		material density

APPENDIX

Notation

$Cost(\_)$	cost of (factor)
$m$	mass
$n_p$	number of parts
PR	packing ratio