

Geodesics on the Ellipsoid and Monodromy

Chris M. Davison, Holger R. Dullin*, Alexey V. Bolsinov

*Department of Mathematical Sciences, Loughborough University
Leicestershire, LE11 3TU, United Kingdom[†]*

16 February 2007

Abstract

After reviewing the properties of the geodesic flow on the three dimensional ellipsoid with distinct semi-axes, we investigate the three-dimensional ellipsoid with the two middle semi-axes being equal, corresponding to a Hamiltonian invariant under rotations. The system is Liouville-integrable, and symmetry reduction leads to a (singular) system on a two-dimensional ellipsoid with an additional potential and with a hard billiard wall inserted in the middle coordinate plane. We show that the regular part of the image of the energy momentum map is not simply connected and there is an isolated critical value for zero angular momentum. The singular fiber of the isolated singular value is a doubly pinched torus multiplied by a circle. This circle is not a group-orbit of the symmetry group, and thus analysis of this fiber is non-trivial. Finally we show that the system has a non-trivial monodromy, and consequently does not admit single valued globally smooth action variables.

1 Introduction

The geodesic flow on the ellipsoid is the classical example of a non-trivial separable and thus Liouville integrable Hamiltonian system. It is the prime example in Jacobi's "Vorlesungen über Dynamik" [10] and may be considered as his motivation to formulate the famous Jacobi inversion problem. Its modern treatment was revived by Moser [14], generalising to the n -ellipsoid and providing smooth integrals and the general solution in terms of θ -functions for the generic case of an n -ellipsoid with pair-wise distinct semi-axes. Further work inspired by Moser was carried out by Knörrer [11, 12]. Separation leads to a curve of genus n and the n actions are given by integrating a differential of second kind over a basis of real cycles. The generic torus corresponds to a non-degenerate

*HRD was supported in part by a Leverhulme Research Fellowship, and would like to thank CU Boulder for the hospitality

[†]email: c.m.davison@lboro.ac.uk, h.r.dullin@lboro.ac.uk, a.bolsinov@lboro.ac.uk

curve. Special motions correspond to degenerate curves. For two degrees of freedom the topology of the Liouville foliation was analysed in [1]. An excellent general approach to the topology of Stäckel systems, including geodesic flow on the ellipsoid with distinct semi-axes, was carried out by Zung [18]. This is the first paper where the singularities of the Liouville foliation were studied for geodesic flow on the ellipsoid. We extend his results to the degenerate case.

Surprisingly most of these results are not stable when the ellipsoid becomes degenerate, i.e. when some semi-axes coincide. The smooth integrals develop poles in this limit, the hyperelliptic curve changes, complete Abelian actions integrals change from 2nd kind to 3rd kind, and the topology of the critical values in the image of the energy-momentum map changes. Here we study these changes for the 3-ellipsoid. The most interesting result appears when the middle-axes coincide; the set of regular values of the energy-momentum map becomes non-simply connected. Duistermaat [5] realised that in this case global action variables might not exist. The torus-bundle over the regular values is non-trivial and has monodromy, which occurs as an obstruction to bundle triviality in a number of interesting integrable systems [15, 3, 16, 7]. The example treated in this paper shows that by making an integrable system simpler (i.e. more symmetric) it can become more complicated (i.e. have a non-trivial torus bundle).

In section 2 we review the topology of the foliation of the geodesic flow on the 3-ellipsoid with four distinct semi-axes. Most of this is well known, but the computation of the non-degeneracy of the critical points to our knowledge is new. Surprisingly there are two critical values of corank 1 that are degenerate. In section 3 the geodesic flow on the 3-ellipsoid with equal middle axes is reduced by the rotational symmetry to a system on the 2-ellipsoid with an additional potential. This regular reduction is only valid when the angular momentum is non-zero. The system is described using a Dirac bracket in \mathbb{R}^8 and the reduction map is a Poisson map that leads to a similar Dirac bracket in \mathbb{R}^6 . In section 4 a central lemma about the singular reduction with vanishing angular momentum is proved: The reduced phase space is a manifold with singularities that can be characterized as the geodesic flow on the 2-ellipsoid with a hard billiard wall inserted in the plane containing the umbilic points. Alternatively it can be viewed as the quotient of the geodesic flow on the 2-ellipsoid by a \mathbb{Z}_2 -group action. Using this lemma in section 5 the topology of the singular fibers of the Liouville foliation is found. In particular the preimage of the isolated singular value with vanishing angular momentum is found to be a doubly pinched torus multiplied by S^1 . In the final section the monodromy matrix is computed by considering explicit formulae for the action variables obtained by separating the reduced equations.

2 The geodesic flow on generic 3-ellipsoids

A 3-ellipsoid embedded in \mathbb{R}^4 with coordinates $x = (x_0, x_1, x_2, x_3)$ has the equation $\langle A^{-1}x, x \rangle = 1$ with the standard Euclidean scalar product \langle, \rangle and a positive definite matrix A . This quadratic form can always be diagonalised by an orthogonal transfor-

mation and the eigenvalues of A are denoted by $0 < \alpha_0 \leq \alpha_1 \leq \alpha_2 \leq \alpha_3$. Thus we may assume that A is diagonal and the standard form of the ellipsoid with semi-axis $\sqrt{\alpha_i}$ embedded in \mathbb{R}^4 is

$$C_1 = \frac{x_0^2}{\alpha_0} + \frac{x_1^2}{\alpha_1} + \frac{x_2^2}{\alpha_2} + \frac{x_3^2}{\alpha_3} - 1 = 0.$$

For the generic non-degenerate ellipsoid the semi-axes are distinct. The Lagrangian of a free particle with mass 1 is $L = \frac{1}{2}(\dot{x}_0^2 + \dot{x}_1^2 + \dot{x}_2^2 + \dot{x}_3^2)$. The equations of motion with Lagrange multiplier Λ enforcing the constraint $C_1 = 0$ are

$$\ddot{x} = -\Lambda A^{-1}x, \quad \Lambda = \frac{\langle A^{-1}\dot{x}, \dot{x} \rangle}{\langle A^{-1}x, A^{-1}x \rangle}. \quad (1)$$

A Hamiltonian description can be obtained by introducing momenta $y_i = \dot{x}_i$ and enforcing the constraint by replacing the standard symplectic structure $dx \wedge dy$ by a Dirac bracket. The Dirac bracket has as Casimirs the constraint for being on the ellipsoid $C_1 = 0$ and the constraint for its tangent space

$$C_2 = \frac{x_0 y_0}{\alpha_0} + \frac{x_1 y_1}{\alpha_1} + \frac{x_2 y_2}{\alpha_2} + \frac{x_3 y_3}{\alpha_3} = 0.$$

We also define the following notation

$$D = \frac{x_0^2}{\alpha_0^2} + \frac{x_1^2}{\alpha_1^2} + \frac{x_2^2}{\alpha_2^2} + \frac{x_3^2}{\alpha_3^2} = \frac{1}{2} \sum \frac{\partial C_1}{\partial x_i} \frac{\partial C_2}{\partial y_i}.$$

We can generalise the constraints C_1 and C_2 , and the factor D , for a $n - 1$ ellipsoid \mathcal{E} embedded in \mathbb{R}^n . Lifting to the cotangent bundle, we have coordinates $x = (x_0, \dots, x_{n-1})$ and conjugate momenta $y = (y_0, \dots, y_{n-1})$ for $T^*\mathcal{E}$ embedded in $T^*\mathbb{R}^n$. For this generic case the Dirac bracket with Casimirs C_1 and C_2 is given by

$$\{x_i, x_k\}_{2n} = 0, \quad \{x_i, y_k\}_{2n} = \delta_{ik} - \frac{x_i x_k}{D \alpha_i \alpha_k}, \quad \{y_i, y_k\}_{2n} = -\frac{x_i y_k - x_k y_i}{D \alpha_i \alpha_k}, \quad (2)$$

where the index of $2n$ on the bracket indicates the embedding space is $T^*\mathbb{R}^n$.

Returning to the three dimensional ellipsoid, the Hamiltonian is $H = \frac{1}{2}(y_0^2 + y_1^2 + y_2^2 + y_3^2)$ and the equations of motion are

$$\dot{x}_i = \{x_i, H\}_8, \quad \dot{y}_i = \{y_i, H\}_8, \quad i = 0, 1, 2, 3. \quad (3)$$

These equations are equivalent to (1). The Hamiltonian vector field generated by H is denoted by X_H .

The system is Liouville integrable with smooth global integrals (in the generic case of distinct semi-axes) first found by Uhlenbeck (see Moser [14])

$$F_i = y_i^2 + \sum_{j=1, j \neq i}^n \frac{(x_i y_j - x_j y_i)^2}{\alpha_i - \alpha_j}, \quad i = 0, \dots, 3. \quad (4)$$

On the symplectic leaf of the Dirac bracket given by $C_1 = C_2 = 0$ they are related by $\sum F_i/\alpha_i = 0$ and they have pair-wise vanishing brackets [14]. The integrals F_i are related to the Hamiltonian by $H = \frac{1}{2}(F_0 + F_1 + F_2 + F_3)$.

Ellipsoidal coordinates are local coordinates on the ellipsoid that separate the Hamiltonian. They are defined as the roots λ of $K(x, x; \lambda) = 1$ where

$$K(x, y; \lambda) = \sum \frac{x_i y_i}{\alpha_i - \lambda}.$$

The equations $K(x, x; \lambda_i) = 1$ are linear in x_i^2 and can be easily solved to give

$$x_i^2 = \frac{B(\alpha_i)}{A'(\alpha_i)}, \quad B(z) = \prod_{j=0}^3 (\lambda_j - z), \quad A(z) = \prod_{j=0}^3 (\alpha_j - z). \quad (5)$$

Here $A'(z)$ denotes the derivative of $A(z)$. Because of the position of the poles of K for fixed x the 4 roots satisfy

$$\lambda_0 \leq \alpha_0 \leq \lambda_1 \leq \alpha_1 \leq \lambda_2 \leq \alpha_2 \leq \lambda_3 \leq \alpha_3.$$

Fixing $\lambda_0 = 0$ gives a coordinate system $(\lambda_1, \lambda_2, \lambda_3)$ on the ellipsoid since $K(x, x; 0) - 1 = C_1$. The coordinate transformation to the new variables λ_i and their conjugate momenta p_i gives

$$H = 4 \sum_i \frac{1}{2} p_i^2 \frac{\prod_j (\alpha_j - \lambda_i)}{\prod_j' (\lambda_j - \lambda_i)}.$$

The primed product excludes the vanishing term with $j = i$. The geodesic flow on the ellipsoid $\lambda_0 = 0$ is described by the invariant subset given by $p_0 = \lambda_0 = 0$. The variables can be separated by using the van der Monde matrix $(\lambda_i^{j-1})_{ij}$ as a Stäckel matrix [9]. With separation constants s_i where $s_3 = 2h$ and $s_0 = 0$ the separated equations are

$$p_i^2 = -\frac{Q(\lambda_i)}{4A(\lambda_i)}, \quad Q(z) = 2hz^3 + s_2z^2 + s_1z + s_0. \quad (6)$$

The system separates on the hyperelliptic curve $w^2 = -Q(z)A(z)$ of degree 7, hence genus 3. The relation between F_i and the separation constants s_i is determined by the residues of the identity

$$\sum_{i=0}^3 \frac{F_i}{z - \alpha_i} = \frac{Q(z)}{A(z)}. \quad (7)$$

In particular $s_2 = -\sum_{cycl} f_0(a_1 + a_2 + a_3)$, $s_1 = \sum_{cycl} f_0(a_1 a_2 + a_1 a_3 + a_2 a_3)$, where f_i denotes a value of F_i .

The ellipsoidal coordinates λ_j only determine the squares of the x_j and thus have singularities when $x_j = 0$. Smoother coordinates ϕ_i on a covering torus designed so that their cotangent lift cancels the singularities given by $A(z)$ in (6) are defined by

$$\frac{d\phi_i}{d\lambda_i} = \frac{1}{2\sqrt{(-1)^i A(\lambda_i)}}, \quad \alpha_{i-1} \leq \lambda_i \leq \alpha_i, \quad i = 1, 2, 3. \quad (8)$$

This defines elliptic functions $\lambda_i(\phi_i)$ with modulus $k^2 = (\alpha_3 - \alpha_2)(\alpha_1 - \alpha_0)/((\alpha_3 - \alpha_1)(\alpha_2 - \alpha_0))$ given by the cross ratios of the semi-axes squared for $i = 1, 3$ and with complementary modulus $\sqrt{1 - k^2}$ for $i = 2$. The momenta conjugate to ϕ_i are denoted by \hat{p}_i . In this coordinate system the squares of the new momenta are smooth functions $\hat{p}_i^2 = (-1)^{i+1}Q(\lambda_i(\phi_i))$. The Hamiltonian H and the constants of motions from separation S_1, S_2 in these coordinates are

$$\begin{aligned} H &= \frac{\hat{p}_1^2}{2\lambda_1(\lambda_2 - \lambda_1)(\lambda_3 - \lambda_1)} + \frac{\hat{p}_2^2}{2\lambda_2(\lambda_2 - \lambda_1)(\lambda_3 - \lambda_2)} + \frac{\hat{p}_3^2}{2\lambda_3(\lambda_3 - \lambda_1)(\lambda_3 - \lambda_2)}, \\ S_1 &= \frac{\lambda_2\lambda_3\hat{p}_1^2}{\lambda_1(\lambda_2 - \lambda_1)(\lambda_3 - \lambda_1)} + \frac{\lambda_1\lambda_2\hat{p}_2^2}{\lambda_2(\lambda_2 - \lambda_1)(\lambda_3 - \lambda_2)} + \frac{\lambda_1\lambda_2\hat{p}_3^2}{\lambda_3(\lambda_3 - \lambda_1)(\lambda_3 - \lambda_2)}, \\ S_2 &= -\frac{(\lambda_2 + \lambda_3)\hat{p}_1^2}{\lambda_1(\lambda_2 - \lambda_1)(\lambda_3 - \lambda_1)} - \frac{(\lambda_1 + \lambda_3)\hat{p}_2^2}{\lambda_2(\lambda_2 - \lambda_1)(\lambda_3 - \lambda_2)} - \frac{(\lambda_1 + \lambda_2)\hat{p}_3^2}{\lambda_3(\lambda_3 - \lambda_1)(\lambda_3 - \lambda_2)}. \end{aligned}$$

In these formulas each λ_i represents the elliptic function $\lambda_i(\phi_i)$.

The (ϕ, \hat{p}) coordinate system still is not a global coordinate system on the cotangent bundle of the 3-ellipsoid (such global coordinates do not exist). It has singularities at the ‘‘umbilical curve’’¹ determined by $\lambda_1 = \lambda_2 = \alpha_1$ contained in the $x_1 = 0$ plane and $\lambda_2 = \lambda_3 = \alpha_2$ contained in the $x_2 = 0$ plane. Explicit formulas are obtained by inserting these conditions into (5), where λ_3 or λ_1 become the curve parameter, respectively. Hence the umbilic curves are coordinate lines on the respective sub-ellipsoid. The umbilic curves are thus 2 topological circles in the x_2 - x_3 -plane with $x_0 > 0$ or $x_0 < 0$ and 2 topological circles in the x_0 - x_1 -plane with $x_3 > 0$ or $x_3 < 0$. At these points in configuration space H and S_i are singular for arbitrary momenta and a different coordinate system needs to be used.

There are four 2-dimensional totally geodesic subflows obtained from setting $x_i = y_i = 0$. Similarly there are six 1-dimensional totally geodesic subflows obtained from setting $x_i = x_j = y_i = y_j = 0$ for each pair of indices with $i < j$. A 1-dimensional subflow is of course simply two periodic orbits. These six times two periodic orbits and the four subflows on 2-ellipsoids give the backbone of the bifurcation diagram, i.e. the critical values in the image of the energy-momentum map. These critical values are shown in figure 1.

Each separated equation $\hat{p}_i^2 - (-1)^{i+1}Q(\lambda_i(\phi_i)) = 0$ defines a curve in the phase portrait in the (ϕ_i, \hat{p}_i) plane. The critical points occur at $\hat{p}_i = 0$ and ϕ_i determined by $Q'(\lambda_i)\lambda_i' = 0$.

¹The term ‘‘umbilical curve’’ is used in analogy to the umbilic points on the two dimensional ellipsoid.

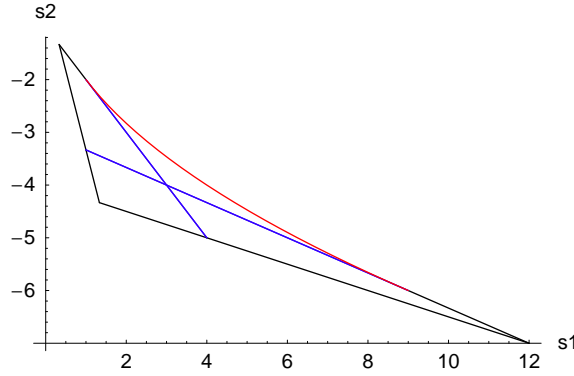

Figure 1: Bifurcation Diagram of the generic Ellipsoid with $\alpha_i = 1/3, 1, 3, 4$

Solutions are of two types: Either double roots of Q or critical points of the elliptic function λ_i . According to (8) critical points of $\lambda_i(\phi_i)$ occur exactly for $\lambda_i = \alpha_{i-1}$ or $\lambda_i = \alpha_i$. By (5) this implies that $x_{i-1} = 0$ or $x_i = 0$, respectively, and similarly for y_i from the cotangent lift of (8). These critical points therefore correspond to the geodesic subflows mentioned above. The image of the critical points $x_j = y_j = 0$ is given by a segment of the line in the s_1 - s_2 plane given by $Q(\alpha_j) = 0$, see figure 1. The other type of critical points occur for those values of s_1, s_2 for which there is a double root in $Q(z) = 2hz(z-d)^2$ with $\alpha_1 \leq d \leq \alpha_2$ so that $\lambda_2 = d$ is fixed for this motion. For d not at its boundary values these critical points are *not* contained in any geodesic subflow.

Finally we have to establish whether any point with x -coordinates in the umbilic curves is critical. The umbilic curves are contained in $x_1 = 0$ and $x_2 = 0$, respectively. The gradient of F_i vanishes on the subflow $x_i = y_i = 0$. This shows that points on the umbilic curve contained in $x_i = 0$ which have vanishing momentum $y_i = 0$ are indeed critical. But what about other momenta? If the momentum y_i is non-zero the corresponding geodesic will leave the plane $x_i = 0$. As soon as it is outside the sub-ellipsoid ellipsoidal coordinates are regular, and thus the geodesic is non-critical since the only critical points outside sub-ellipsoids are tori with fixed λ_2 with $\alpha_1 \leq \lambda_2 \leq \alpha_2$; but these tori have no point in common with the umbilic curve unless $\lambda_2 = \alpha_1$ or α_2 .

We have thus proved the well known result that the bifurcation diagram is obtained from collisions of roots of the hyperelliptic curve $w^2 = -Q(z)A(z)$. Subflows correspond to $Q(z)$ having a root that coincides with a root of $A(z)$. Hence the four sub-ellipsoids are given by the lines $Q(\alpha_j) = 0$ in the image of the energy momentum map (h, s_2, s_1) . For geodesic flows the energy can be fixed to $1/2$ without loss of generality, and thus the four lines in (s_1, s_2) space are the straight lines $\alpha_j^2 + s_2\alpha_j + s_1 = 0$, see figure 1. These four lines intersect in six points $(s_1, s_2) = (\alpha_j\alpha_k, -\alpha_j - \alpha_k)$, corresponding to periodic motion in the jk -plane. The other curved line of the bifurcation diagram is given by double roots in $Q(z) = z(z-d)^2$ such that $(s_1, s_2) = (d^2, -2d)$ where $\alpha_1 \leq d = \lambda_2 \leq \alpha_2$ attaching tangentially to the straight lines of intermediate slopes at the codimension two points $(\alpha_i^2, -2\alpha_i)$, $i = 1, 2$. The four disjoint regions of regular values have 2 or 4 tori in their preimage.

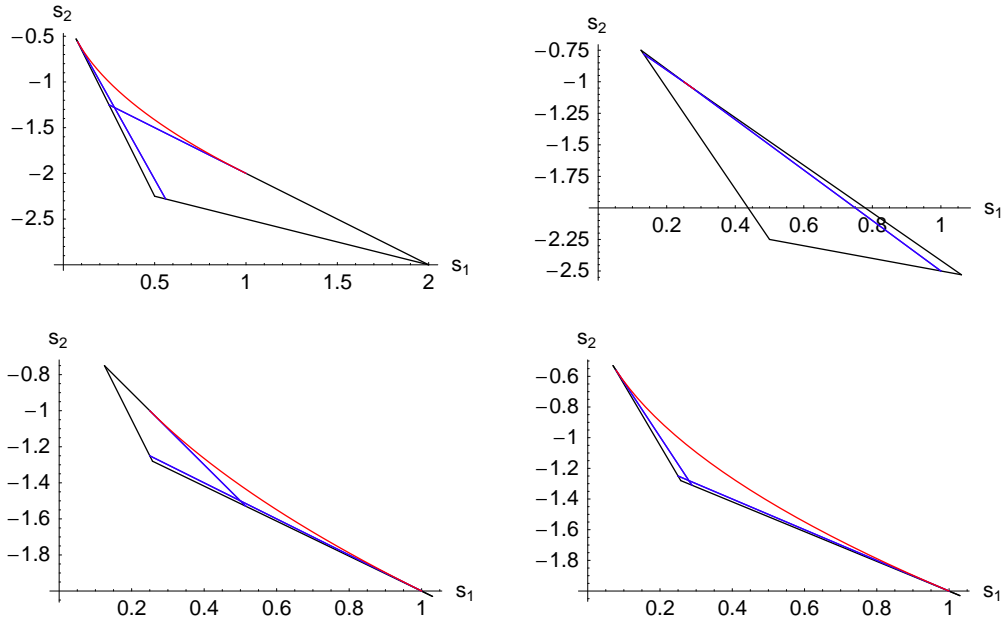

Figure 2: Bifurcation Diagram of almost degenerate Ellipsoids with $\alpha_i = (1/4, 1/4 + \varepsilon, 1, 2)$, $(1/4, 1/2, 1/2 + \varepsilon, 2)$, $(1/4, 1/2, 1, 1 + \varepsilon)$, $(1/4, 1/4 + \varepsilon, 1, 1 + \varepsilon)$, where $\varepsilon = 0.03$.

Finally it is important to establish the (non-)degeneracy and type [2] of the singular points in phase space. The gradient of F_i vanishes in the plane $x_i = y_i = 0$ since each term is quadratic and contains the vanishing terms. For non-degeneracy the spectrum of the Jacobian matrix of the flow of F_i , which is denoted by DX_{F_i} needs to be computed. When restricted to the plane $x_i = y_i = 0$ the only nonzero entries are in the x_i - y_i sub-block. This sub-block reads

$$\begin{pmatrix} -2K_i(x, y) & 2(K_i(x, x) - 1) \\ -2K_i(y, y) & 2K_i(x, y) \end{pmatrix} \quad \text{where} \quad K_i(x, y) = \sum_{k \neq i} \frac{x_k y_k}{\alpha_k - \alpha_i}. \quad (9)$$

Notice that $K_i(y, y)$ never vanishes when F_0 and F_3 ($i = 0, 3$) are considered. Otherwise not all terms of the same sign and $K_i(y, y)$ can vanish. Since this matrix is traceless the square of the eigenvalues is given by the negative determinant. This condition needs to be evaluated on a point of the singular fibre in question. Consider, say, F_1 . Then the point $x_0 = x_3 = 0$ is on all critical sets. Then $y_2 = 0$ since this point is at a maximum of x_2 on the sub-ellipsoid $x_0 = 0$; moreover $x_2 = \pm\sqrt{\alpha_2}$. At this point the diagonal terms vanish, and the eigenvalues vanish when $K_i(y, y)$ vanishes. For $F_1 = 0$ this occurs for the special momentum when $y_0^2 = 2h(a_0 - a_1)/(a_0 - a_3)$, and this is the point of tangency of the line $F_1 = 0$ with the curve of double roots in Q in the bifurcation diagram. All other points are non-degenerate. Similarly for F_2 . This shows that there are two degenerate singularities in the geodesic flow on the non-degenerate n -dimensional ellipsoid when $n = 3$. This is why the claim made in Theorem 2 of [18], that the geodesic flow on the ellipsoid with distinct semi-axes is strongly nondegenerate, is not true.

All critical points corresponding to $F_0 = 0$ and $F_3 = 0$ are non-degenerate since $K_i(y, y)$ cannot vanish. The type of the points (i.e. whether the eigenvalues are elliptic, hyperbolic, or focus-focus) is elliptic on $F_0 = 0$ and $F_3 = 0$, while it changes from elliptic to hyperbolic at the degenerate points on $F_1 = 0$ and $F_2 = 0$. This is where the straight line $F_1 = 0$ in figure 1 changes from being the outer boundary of the image of the momentum map to a line interior to the image; similarly for the line $F_2 = 0$.

The critical points with double roots $r_1 = r_2 = d$ are non-degenerate when they occur outside the umbilic curves. In that case the Jacobian matrix of the flow generated by the one degree of freedom system $\hat{p}_2^2 + Q(\lambda_2(\phi_2))$ is non-degenerate at $\lambda_2(\phi_2) = d$ since the 2nd derivative of Q simply gives $2d$, which is non-zero, and gives elliptic type.

The six corank two points given by the intersection of the lines $F_i = 0$ and $F_j = 0$ are non-degenerate. The above statements can now be specialised to the plane $x_i = x_j = y_i = y_j = 0$. This is a one degree of freedom geodesic flow on the ellipse. The points on this orbit can be easily parametrized and then the eigenvalues become $\lambda_i^2 = 8ha_i/(-(a_k - a_i)(a_l - a_i))$ where k, l are the other two indices distinct from i, j . These eigenvalues are real or pure imaginary. The linear combination $\alpha DX_{F_i} + \beta DX_{F_j}$ has eigenvalues $\alpha\lambda_i$ and $\beta\lambda_j$, which are different assuming $a_i \neq a_j$. The combinations that occur are elliptic-elliptic (indices 03, 01, 23), elliptic-hyperbolic (02, 13), and hyperbolic-hyperbolic (12).

The topology of the bifurcation diagram is always that of figure 1 as long as all the semi-axes of the ellipsoid are distinct. As a first attempt to understand the degenerate cases in figure 2 the bifurcation diagram is presented for four cases in which the semi-axes nearly coincide. From top left to bottom right the cases are close to equal smallest axes, equal middle axes, equal largest axes, and equal smallest and largest axes, also denoted by 211, 121, 112, and 22. It appears as if in the 121 and 22 case the image of the momentum map has only a single chamber, and in the 121-case the image is a triangle. We will see that this is not quite the correct answer. From the bifurcation diagrams it is clear, however, that the image of the symmetric subspace(s) which correspond to a number of collapsing lines needs to be analysed anew, while the results outside this preimage can be taken over.

3 Ellipsoid with equal middle axes

Consider the geodesic flow on a three ellipsoid with equal middle axes $\alpha_1 = \alpha_2$. The Casimirs C_1 and C_2 and the resulting Dirac bracket (2) and the Hamiltonian are the same as before. However, the integrals F_1 and F_2 are not defined any more, but the singular terms cancel in the sum $G = F_1 + F_2$. The other integrals F_0 and F_3 remain the same. The system is invariant under rotations in the (x_1, x_2) plane and its cotangent lift, i.e. simultaneous rotation in the (y_1, y_2) plane. This $SO(2)$ group action is

$$\Phi(x, y; \theta) = (\tilde{x}, \tilde{y}) \tag{10}$$

where

$$\begin{aligned}\tilde{x} &= (x_0, x_1 \cos \theta - x_2 \sin \theta, x_1 \sin \theta + x_2 \cos \theta, x_3) \\ \tilde{y} &= (y_0, y_1 \cos \theta - y_2 \sin \theta, y_1 \sin \theta + y_2 \cos \theta, y_3).\end{aligned}\tag{11}$$

The group action Φ is the flow generated by the angular momentum with respect to the symmetry axis, $J = x_1 y_2 - x_2 y_1$, which is a global action variable since it generates the periodic flow Φ .

Theorem 3.1. *Liouville Integrability. The Geodesic flow on the ellipsoid with equal middle axes is Liouville integrable. Constants of motion are the energy $H = \frac{1}{2}(y_0^2 + y_1^2 + y_2^2 + y_3^2)$, the angular momentum with respect to the symmetry axis, $J = x_1 y_2 - x_2 y_1$, and the third integral $G = F_1 + F_2$*

$$G = y_1^2 + y_2^2 + \frac{(x_0 y_1 - x_1 y_0)^2}{\alpha_1 - \alpha_0} + \frac{(x_0 y_2 - x_2 y_0)^2}{\alpha_1 - \alpha_0} + \frac{(x_1 y_3 - x_3 y_1)^2}{\alpha_1 - \alpha_3} + \frac{(x_2 y_3 - x_3 y_2)^2}{\alpha_1 - \alpha_3}\tag{12}$$

Proof. As in the generic case $2H = F_0 + G + F_3$. So G and H commute because the F_i commute in the generic case. In the limit $\alpha_2 \rightarrow \alpha_1$ the constant of motion $(\alpha_1 - \alpha_2)F_1$ becomes J^2 . Hence J^2 commutes with H and G , and therefore also J .

The constants of motion are not independent on the symplectic leaves of the Dirac bracket. Their relation is

$$\frac{F_0}{\alpha_0} + \frac{G}{\alpha_1} - \frac{J^2}{\alpha_1^2} + \frac{F_3}{\alpha_3} = 0,\tag{13}$$

which is a straightforward limit of the generic relation $\sum F_i/\alpha_i = 0$ using $F_1/\alpha_1 + F_2/\alpha_2 = G/\alpha_2 - F_1(\alpha_1 - \alpha_2)/(\alpha_1 \alpha_2)$.

H, J, G and the Casimirs C_1, C_2 are functionally independent almost everywhere on the level set $C_1 = C_2 = 0$: They are polynomial and independent e.g. at $x = (\sqrt{\alpha_0}, 0, 0, 0)$, $y = (0, 1, 0, 0)$. \square

The group action Φ has the invariants

$$\pi_1 = x_1^2 + x_2^2, \quad \pi_2 = y_1^2 + y_2^2, \quad \pi_3 = x_1 y_1 + x_2 y_2, \quad \pi_4 = x_1 y_2 - x_2 y_1,\tag{14}$$

related by $\pi_1 \pi_2 - \pi_3^2 - \pi_4^2 = 0$. The remaining variables x_0, x_3, y_0, y_3 are trivial invariants of Φ . The fixed points of Φ have $x_1 = x_2 = y_1 = y_2 = 0$. When $J = \pi_4 = j \neq 0$ the fixed points are not in $J^{-1}(j)$ and the reduction by the $SO(2)$ symmetry leads to a smooth reduced system on $J^{-1}(j)/SO(2)$:

Lemma 3.2. *A set of reduced coordinates $(\xi_0, \xi_1, \xi_2, \eta_0, \eta_1, \eta_2)$ is defined on the reduced phase space $P_j = J^{-1}(j)/SO(2)$ by the formulae*

$$\xi_0 = x_0, \quad \xi_1 = \sqrt{\pi_1}, \quad \xi_2 = x_3, \quad \eta_0 = y_0, \quad \eta_1 = \frac{\pi_3}{\sqrt{\pi_1}}, \quad \eta_2 = y_3.$$

The reduced coordinates satisfy the relations (2), which define the Dirac bracket in $\mathbb{R}^6[\xi, \eta]$. The mapping $R : \mathbb{R}^8[x, y] \rightarrow \mathbb{R}^6[\xi, \eta]$ is Poisson from \mathbb{R}^8 with $\{.,.\}_8$ to \mathbb{R}^6 with $\{.,.\}_6$ and the reduced system has reduced Hamiltonian

$$\hat{H} = \frac{1}{2}(\eta_0^2 + \eta_1^2 + \eta_2^2) + \frac{j^2}{2\xi_1^2}$$

and additional integral

$$\hat{G} = \eta_1^2 + \frac{(\xi_1\eta_0 - \xi_0\eta_1)^2}{\alpha_1 - \alpha_0} + \frac{(\xi_1\eta_2 - \xi_2\eta_1)^2}{\alpha_1 - \alpha_3} + \frac{j^2}{\xi_1^2} \left(1 + \frac{\xi_0^2}{\alpha_1 - \alpha_0} + \frac{\xi_3^2}{\alpha_1 - \alpha_3} \right).$$

Proof. Define a set of coordinates on $\mathbb{R}^6[\xi, \eta]$ as shown. The Poisson property of the map R , i.e. $\{f \circ R, g \circ R\}_8 = \{f, g\}_6 \circ R$ follows from direct computation of the basic brackets, e.g. $\{\xi_1, \xi_2\}_6 = \{\sqrt{x_1^2 + x_2^2}, x_3\}_8 = 0$, $\{\xi_1, \eta_2\}_6 = \{\sqrt{x_1^2 + x_2^2}, y_3\}_8 = -(x_1^2 x_3 + x_2^2 x_3)/(D\alpha_1\alpha_3\sqrt{x_1^2 + x_2^2}) = -\xi_1\xi_2/(D\alpha_1\alpha_3)$, etc. The reduced bracket $\{.,.\}_6$ has the Casimirs $\hat{C}_1 = \xi_0^2/\alpha_0 + \xi_1^2/\alpha_1 + \xi_3^2/\alpha_3 - 1$ and $\hat{C}_2 = \xi_0\eta_0/\alpha_0 + \xi_1\eta_1/\alpha_1 + \xi_2\eta_2/\alpha_2$. The relation between the invariants becomes $\xi_1^2\pi_2 - \eta_1^2\xi_1^2 - j^2 = 0$ and elimination of π_2 from the Hamiltonian leads to the above result. Similarly the integral G can first be written in terms of invariants π_i , $i = 1, 2, 3$, and then the elimination of π_i in addition using $\pi_1 = \xi_1^2$ and $\pi_3 = \eta_1\xi_1$ gives the result. \square

The reduced system is the ‘‘geodesic flow’’ on the 2-dimensional ellipsoid with semi-axes $\sqrt{\alpha_0}, \sqrt{\alpha_1}, \sqrt{\alpha_3}$ and an additional effective potential $j^2/2\xi_1^2$. By definition $\xi_1 > 0$, so that the reduced system for $|j| > 0$ has only the open half of the ellipsoid as configuration space. Since $|j| > 0$ the plane $\xi_1 = 0$ is dynamically not accessible because $\xi_1 = 0 \Rightarrow x_1 = x_2 = 0 \Rightarrow j = 0$. Clearly the coordinates x_0, x_3, y_0, y_3 can serve as local coordinates on the half-ellipsoid, see the singular reduction below. Alternatively ellipsoidal coordinates on the ξ -ellipsoid can be used to separate the variables.

To this end define a (singular) coordinate system on $\mathbb{R}^8[x_i, y_i]$ by

$$x_1 = \xi_1 \cos \theta, \quad x_2 = \xi_1 \sin \theta \tag{15}$$

where θ is the angle of rotation corresponding to the $SO(2)$ symmetry group action Φ . The 2-ellipsoid embedded in \mathbb{R}^3 is defined by $\hat{C}_1 = 0$. Coordinates $(\lambda_0, \lambda_1, \lambda_2)$ are then chosen as a confocal ellipsoidal coordinate system [14] in $\mathbb{R}^3[\xi]$, these being the roots z of

$$\frac{\xi_0^2}{\alpha_0 - z} + \frac{\xi_1^2}{\alpha_1 - z} + \frac{\xi_2^2}{\alpha_3 - z} = 1. \tag{16}$$

Constant λ_0 defines an ellipsoid, constant λ_1 a one-sheeted hyperboloid and constant λ_2 a two sheeted hyperboloid, where $\lambda_0 \leq \alpha_0 \leq \lambda_1 \leq \alpha_1 \leq \lambda_2 \leq \alpha_3$. Fixing $\lambda_0 = 0$ gives a set of generalised coordinates $(\lambda_1, \lambda_2, \theta)$ on the three ellipsoid with the middle two semi-axes equal. The conjugate momenta are denoted by (p_1, p_2, p_θ) , where p_θ is the angular momentum with respect to the symmetry axis, J , found earlier.

Lemma 3.3. *The Hamiltonian for the geodesic flow on the ellipsoid with equal middle axes in local symplectic coordinates $(\lambda_1, \lambda_2, \theta, p_1, p_2, p_\theta)$ reads*

$$H = -\frac{2(\alpha_0 - \lambda_1)(\alpha_1 - \lambda_1)(\alpha_3 - \lambda_1)}{\lambda_1(\lambda_2 - \lambda_1)}p_1^2 - \frac{2(\alpha_0 - \lambda_2)(\alpha_1 - \lambda_2)(\alpha_3 - \lambda_2)}{\lambda_2(\lambda_1 - \lambda_2)}p_2^2 + \frac{(\alpha_0 - \alpha_1)(\alpha_3 - \alpha_1)}{2\alpha_1(\lambda_1 - \alpha_1)(\lambda_2 - \alpha_1)}p_\theta^2.$$

The constants of motion are p_θ and

$$\tilde{G}_i = \frac{2(\alpha_0 - \lambda_i)(\alpha_1 - \lambda_i)(\alpha_3 - \lambda_i)}{\lambda_i}p_i^2 - h\lambda_i - \frac{(\alpha_0 - \alpha_1)(\alpha_3 - \alpha_1)}{2\alpha_1(\lambda_i - \alpha_1)}p_\theta^2$$

where $i = 1, 2$. The integrals G and \tilde{G}_i are related by

$$\tilde{G}_1 + \tilde{G}_2 = \frac{(\alpha_1 - \alpha_3)(\alpha_1 - \alpha_0)G}{\alpha_1} - 2\alpha_1 h + \frac{\alpha_1^2 - \alpha_0\alpha_3}{\alpha_1^2}p_\theta^2.$$

Proof. The Hamiltonian in local coordinates is found after performing a cotangent lift of the new coordinates, and then expressing the original Hamiltonian in terms of those coordinates. The Hamiltonian is separated simply by multiplication with $\lambda_2 - \lambda_1$ and rearranging to determine \tilde{G}_1 and \tilde{G}_2 . As a result of the separation the momenta p_i conjugate to λ_i can be expressed as

$$p_i^2 = -\frac{\tilde{Q}(\lambda_i)}{4A(\lambda_i)} \quad (17)$$

with \tilde{Q} being the analogue of Q in (6) given as

$$\frac{\tilde{Q}(z)}{z} = 2h(\alpha_1 - z)^2 + \frac{(\alpha_3 - \alpha_1)(\alpha_1 - \alpha_0)}{\alpha_1}(g(\alpha_1 - z) - j^2) + \frac{\alpha_0\alpha_3 - \alpha_1^2}{\alpha_1^2}j^2(\alpha_1 - z) \quad (18)$$

The relation between the constant of motion G and the separation constants \tilde{G}_i is derived by substituting the expressions for the original coordinates in terms of the new local coordinates into G , rearranging and expressing in partial fractions. \square

An analogue of the relation between the constants of motion for the generic 3-dimensional ellipsoid (7) is given by

$$\frac{F_0}{z - \alpha_0} + \frac{F_3}{z - \alpha_3} + \frac{G}{z - \alpha_1} + \frac{J^2}{(z - \alpha_1)^2} = \frac{\tilde{Q}(z)}{A(z)}.$$

The separating coordinate system is singular whenever λ_i equals α_k , hence whenever $\xi_k = 0$. When smooth elliptic coordinates ϕ_i are introduced the singularity at $x_1 = x_2 = 0$ remains, while those at $x_0 = 0$ and $x_3 = 0$ disappear. The umbilical points on the reduced ellipsoid $(x_0^2, x_3^2) = (\alpha_0(\alpha_1 - \alpha_0), \alpha_3(\alpha_3 - \alpha_1))/(\alpha_3 - \alpha_0)$ (corresponding to $\lambda_1 = \lambda_2 = \alpha_1$) are contained in the plane $\xi_1 = 0$.

Lemma 3.3 can be read as singular coordinates: for the full as for the reduced system.

4 Singular Reduction

The singular reduction for $j = 0$ leads to a reduced system on a non-smooth manifold. To understand its singularity let us consider as an aside the simple example of the $SO(2)$ action Φ on the cotangent bundle $T^*\mathbb{R}^2$ with coordinates (x_1, x_2, y_1, y_2) . We can define the angular momentum, invariants and reduction map in exactly the same way as we did for the case of geodesic flow on the ellipsoid. The reduction map π gives a reduced phase space given by the surface $\pi_1\pi_2 - \pi_3^2 = j^2$ embedded in $\mathbb{R}^3[\pi_1, \pi_2, \pi_3]$. This surface is a cone when $j = 0$ and smooth otherwise. Considering the inequalities $\pi_1 \geq 0, \pi_2 \geq 0$ the reduced phase space for $j = 0$ is half of a cone. An alternative description of this reduced phase space is obtained by first restricting to any invariant subspace of the x_1 - x_2 -plane, e.g. $x_2 = y_2 = 0$. The $SO(2)$ action Φ has a residual \mathbb{Z}_2 action on this plane since $\Phi(\pi)(x_1, y_1) = (-x_1, -y_1)$. Therefore the singular reduced phase space $\{\pi_1\pi_2 = \pi_3^2\} \subset \mathbb{R}^3$ can also be viewed as $\mathbb{R}^2[x_1, y_1]/\mathbb{Z}_2$. This is e.g. the half-plane $x_1 \geq 0$ with the boundary $y_1 = 0$ identified with itself by $(x_1, 0) \sim (-x_1, 0)$, which again gives a cone. The fixed point of the residual \mathbb{Z}_2 action $\Phi(\pi)$ is the origin $x_1 = y_1 = 0$ and it is the singular point of the reduced phase space. Yet another representation of the same reduced phase space is given by classical polar coordinates $x_1 = r \cos \theta, x_2 = r \sin \theta$, so that the reduced space is the half plane r, p_r with $r \geq 0$ and $p_r = (x_1 y_1 + x_2 y_2)/r$. From the above we see that for $j = 0$ the reduced space, however, is not a half-plane, but a cone, because of the identification $p_r \sim -p_r$ along the line $r = 0$.

The cone $\pi_1\pi_2 = \pi_3^2$ can be diagonalised as a quadratic form by $\pi_1 = u + v, \pi_2 = u - v$, and $\pi_3 = w$. Then the cone is parametrised by $u = r, v = r \sin \phi$, and $w = r \cos \phi$. In complex notation $z = r \exp i\phi$ the reduction map $\pi_1 = x^2, \pi_2 = y^2, \pi_3 = xy$ can then be written as $z = i(x - iy)^2/2$. Thus the mapping from $\mathbb{R}^2[x, y] \setminus (0, 0)$ to the cone without tip is a double cover. Therefore again the cone is equal to $\mathbb{R}^2/\mathbb{Z}_2$. Moreover the Poisson-structure on the cone given by $\{\pi_1, \pi_2\}_3 = 4\pi_3, \{\pi_1, \pi_3\}_3 = 2\pi_1, \{\pi_2, \pi_3\}_3 = -2\pi_2$, is mapped into the symplectic structure $\{\pi_1, \pi_2\}_3 = \{x^2, y^2\}_2 = 4xy = 4\pi_3$, similarly for the other brackets. Moreover, the reduction map is invariant under the \mathbb{Z}_2 symmetry action, and thus the symplectic structure on the plane passes down to the cone. A similar argument is valid in the case of geodesic flow on the ellipsoid:

Lemma 4.1. *For $j = 0$, the singular reduced phase space of the geodesic flow on the 3-ellipsoid with equal middle axes is the phase space of the geodesic flow on the 2-ellipsoid reduced by the \mathbb{Z}_2 action $S(\xi_0, \xi_1, \xi_2, \eta_0, \eta_1, \eta_2) = (\xi_0, -\xi_1, \xi_2, \eta_0, -\eta_1, \eta_2)$. Thus it is the geodesic flow on the 2-ellipsoid with a hard billiard wall inserted in the $\xi_1 = 0$ -plane.*

Proof. The $SO(2)$ group action Φ does not act freely and so we have to use singular reduction to analyse the reduced phase spaces. To do this we use invariant theory. The Casimirs for the system, expressed in terms of the invariants (14), are

$$\frac{x_0^2}{\alpha_0} + \frac{\pi_1}{\alpha_1} + \frac{x_3^2}{\alpha_3} = 1, \quad \frac{x_0 y_0}{\alpha_0} + \frac{\pi_3}{\alpha_1} + \frac{x_3 y_3}{\alpha_3} = 0. \quad (19)$$

Note that these equations are linear in the invariants. The Hamiltonian may be expressed in terms of the invariants as

$$H = \frac{1}{2} (y_0^2 + \pi_2 + y_3^2). \quad (20)$$

The reduced phase space is a subset of $\mathbb{R}^7[x_0, y_0, x_3, y_3, \pi_1, \pi_2, \pi_3]$. It is defined by the two Casimirs (19), the relation between the invariants $\pi_1\pi_2 - \pi_3^2 = j^2$ and the inequalities $\pi_1 \geq 0, \pi_2 \geq 0$. It carries the induced Poisson-structure. To describe this subset we first of all eliminate π_1 and π_3 using (19) to get

$$\alpha_1 \left(1 - \frac{x_0^2}{\alpha_0} - \frac{x_3^2}{\alpha_3} \right) \pi_2 - \alpha_1^2 \left(\frac{x_0 y_0}{\alpha_0} + \frac{x_3 y_3}{\alpha_3} \right)^2 = j^2. \quad (21)$$

This is a single equation in $\mathbb{R}^5[x_0, x_3, y_0, y_3, \pi_2]$ which defines a four dimensional object. Equating the gradient to zero, we find that the equation defines a smooth four dimensional manifold except when $j = 0$. This is the reduced phase space $P_j = J^{-1}(j)/SO(2)$. When $j = 0$ there is a singularity for $\pi_1 = \pi_2 = \pi_3 = 0$. The singular points are given by the phase space of the geodesic flow on the ellipse in the 03-plane, which is a cylinder. Thus the singular set of the reduced phase space is itself a symplectic manifold. This symplectic manifold is invariant under the flow of the reduced equations, but it is not fixed under it.

The geodesic flow on the 2-ellipsoid reduced by the \mathbb{Z}_2 action S is the billiard. Take as a fundamental region the half-ellipsoid with $\xi_1 \geq 0$. Then the action of S on the boundary $\xi_1 = 0$ simply flips the sign of η_1 , which can be viewed as the reflection on the plane $\xi_1 = 0$ with the rule ‘‘angle of incidence equals angle of reflection’’. Moreover, points $\xi_1 = \eta_1 = 0$ are fixed under S and correspond to orbits that are sliding along (or in) the billiard boundary $\xi_1 = 0$.

To establish the correspondence between the reduced space and the billiard consider the slice $x_2 = y_2 = 0$ through full phase space. This is a geodesic subflow, which is the geodesic flow on the 2-ellipsoid with semi-axes $\sqrt{\alpha_0}, \sqrt{\alpha_1}, \sqrt{\alpha_3}$, as described in lemma 3.2. Any motion with $j = 0$ can be reduced to a motion in this plane by some rotation $\Phi(\theta)$ with constant θ . So locally the flow on this 2-ellipsoid is the reduced system. Globally, however, we still have the residual \mathbb{Z}_2 action S , given by $\Phi(\pi)$, to reduce by.

The reduced bracket in \mathbb{R}^5 is the original Dirac bracket (2) between x_0, x_3, y_0, y_3 with the additional non-zero brackets with π_2 given by $\{y_i, \pi_2\} = 2x_i\pi_2/(\alpha_i\alpha_1 D)$. As in the trivial example above we now show that the mapping from the 2-ellipsoid minus a cylinder to the reduced phase space minus the singular set is a Poisson map. When the singular set is removed, (21) can be solved for π_2 . After elimination of π_2 only the original Dirac bracket between x_0, x_3, y_0, y_3 remains. For the description of the geodesic flow on the 2-ellipsoid we use the the variables ξ_0, ξ_1, ξ_2 and momenta η_0, η_1, η_2 which satisfy the Dirac bracket (2), without implying that they are obtained by regular reduction as in lemma 3.2. The mapping from the symplectic submanifold of $\mathbb{R}^6[\xi_0, \xi_1, \xi_2, \eta_0, \eta_1, \eta_2]$ obtained by fixing the Casimirs to $\mathbb{R}^4[x_0, x_3, y_0, y_3]$ (without any Casimirs) is simply the projection $x_0 = \xi_0, x_3 = \xi_2, y_0 = \eta_0, y_3 = \eta_2$, which preserves the Dirac bracket. However, this mapping is 2 : 1 since from the Casimirs only ξ_1^2 can be recovered, but not its sign.

The meaning of this construction is very simple. Because of the inequality $\pi_1 > 0$ the variables x_0, x_3 are restricted to the interior of the ellipse $\pi_1 = 0$. These variables are good local coordinates on the reduced phase space after the singularity (at $\pi_1 = 0$) is removed. From the point of view of the 2-ellipsoid this amounts to choosing local coordinates in configuration space as the projection of the point onto the $\xi_1 = 0$ plane. \square

As a result the regular reduction described in lemma 3.2 gives the right description even in the singular case, when the additional discrete quotient by the \mathbb{Z}_2 action S is included in the picture. In the regular case $j \neq 0$ the two halves of the ellipsoid that are identified by S are dynamically disconnected, because of the effective potential $j^2/2\xi_1^2$. However, when $j = 0$ the \mathbb{Z}_2 action is less trivial because its fixed set is now accessible to the dynamics, and this fact is crucial in order to obtain the correct singular fibres in the next section.

5 The Liouville foliation

We now wish to investigate the topology of the invariant level sets obtained by fixing the constants of motion. The energy momentum map is $\mathcal{EM} = (H, J, G) : M \rightarrow \mathbb{R}^3$. Since H for a geodesic flow is homogeneous in the momenta we can fix the energy to, say, h .

Theorem 5.1. *The image of the energy momentum map \mathcal{EM} for constant energy $H = h$ is the region in \mathbb{R}^2 bounded by the quadratic curves (see figure 3)*

$$g = \frac{2\alpha_1}{\alpha_1 - \alpha_3}h - \frac{\alpha_3}{\alpha_1(\alpha_1 - \alpha_3)}j^2, \quad g = \frac{2\alpha_1}{\alpha_1 - \alpha_0}h - \frac{\alpha_0}{\alpha_1(\alpha_1 - \alpha_0)}j^2. \quad (22)$$

Singular values of the energy momentum map are the boundary curves (elliptic), their intersections (elliptic-elliptic), and an isolated singularity at the origin $(j, g) = (0, 0)$ of focus-focus type.

Proof. As in the generic case critical points can occur on sub-ellipsoids. On $x_0 = y_0 = 0$ the integral $F_0 = 0$ and $\nabla F_0 = 0$, similarly for $x_3 = y_3 = 0$ and F_3 . In both cases the corresponding sub-ellipsoids are ellipsoids of revolution. The image of the critical points with $x_0 = y_0 = 0$ is found using the relation (13) to eliminate F_3 in $2H = F_0 + G + F_3$, which gives

$$2H = G - \alpha_3 \left(\frac{G}{\alpha_1} - \frac{J^2}{\alpha_1^2} \right),$$

and hence the first curve of critical values. A similar computation for critical points with $x_3 = y_3 = 0$ gives the other curve.

These points are non-degenerate because the Jacobian of the flow generated by F_0 restricted to the critical points $x_0 = y_0 = 0$ is given by (9). Evaluating this on the point $x_0 = x_1 = x_3 = 0, y_0 = y_2 = 0$ shows that the eigenvalues of this matrix never vanish and

are of elliptic type, and hence these critical points are non-degenerate. Similar arguments apply to the points $x_3 = y_3 = 0$. The two corank two points given by the intersection of the two curves are also non-degenerate, because the non-zero 2×2 blocks of the Jacobians are distinct, so that $\mu DX_{F_0} + \nu DX_{F_3}$ spans the Cartan subalgebra; the 4 eigenvalues (for any point on the critical circles given by $x_0 = x_3 = y_0 = y_3 = 0$) are $\pm 2i\mu\sqrt{2\alpha_0\hbar}/(\alpha_1 - \alpha_0)$ and $\pm 2i\nu\sqrt{2\alpha_3\hbar}/(\alpha_3 - \alpha_1)$. This orbit is a relative equilibrium, i.e. a circle in the x_1 - x_2 plane. The eigenvalues of DX_{F_0} and DX_{F_3} are elliptic, so at their intersection an orbit of elliptic-elliptic type is found.

Since for $x_i = y_i = 0$ the integrals $F_i = 0$ and also its gradient vanishes, $G = F_1 + F_2$ and its gradient clearly vanishes when $x_1 = x_2 = y_1 = y_2 = 0$. Considering the Casimirs the solutions set of $x_1 = x_2 = y_1 = y_2 = 0$ is a geodesic flow on the ellipse in the x_0 - x_3 plane. Fixing the energy two critical circles are obtained. On these critical points also $J = 0$ so that the origin in the image $(J, G) = (0, 0)$ is a critical value.

Moreover $\nabla J = 0$ as well, and the Jacobian of X_J has eigenvalues $\pm i$, since its flow Φ is a rotation. Finally $\mu DX_G + \nu DX_J$ spans the Cartan subalgebra; the 4 eigenvalues (for any point on the critical circles) are $\pm\mu\sqrt{8\alpha_1\hbar}/(\alpha_1 - \alpha_0)(\alpha_3 - \alpha_1) \pm i\nu$. These eigenvalues form a complex quadruplet, and hence the isolated critical point at the origin is of focus-focus type.

This establishes the existence, non-degeneracy, and type of all critical points. The bifurcation diagram is shown in figure 3 with an isolated singularity at the origin $(j, g) = (0, 0)$. The remaining part of the proof shows that there are no other critical points.

First of all the ellipsoidal coordinates from lemma 3.3 are used to establish that almost all other points are non-singular. These coordinates are non-singular outside any sub-ellipsoid $\xi_i = 0$. To find critical points in the region of phase space with ξ coordinates such that all $\xi_i \neq 0$ it is enough to compute the rank of the matrix $D(\tilde{G}_1, \tilde{G}_2, p_\theta)$, see lemma. 3.3. Since the variables are separated this implies $p_s = 0$ and $h2\alpha_1(\lambda_s - \alpha_1)^2 = -(\alpha_1 - \alpha_0)(\alpha_3 - \alpha_1)p_\theta^2$ which is impossible. Thus critical points are contained in the coordinate singularities $\xi_i = 0$.

It remains to check the pre-images in full phase space of the sub-ellipsoids $\xi_i = 0$ where the ellipsoidal coordinates are not defined. When $\eta_i = 0$ in addition to $\xi_i = 0$ then the point is critical, see above. Thus we need to show that all points with $\xi_i = 0$ but $\eta_i \neq 0$ are non-singular. The ellipsoid $x_0 = 0$ is a totally geodesic submanifold, i.e. when $y_0 = 0$ every orbit stays inside $x_0 = 0$. Conversely, when $y_0 \neq 0$ the orbit must leave the sub-ellipsoid $x_0 = 0$. Similar for $x_3 = 0$. In general an orbit with x in some sub-ellipsoid(s) but y not tangent to these sub-ellipsoids will leave them, and therefore will have all $x_k \neq 0$. But there ellipsoidal coordinates are regular, and therefore the original point is non-critical, since geodesic motion preserves non-criticality. When $\xi_1 = 0$ and hence $x_1 = x_2 = 0$ the condition $\eta_1 = 0$ is always satisfied by definition, but it does not specify y_1 and y_2 . But the previous argument applies again: if $(y_1, y_2) \neq (0, 0)$ then the geodesic will leave $x_1 = x_2 = 0$, and therefore the original point is not critical.

□

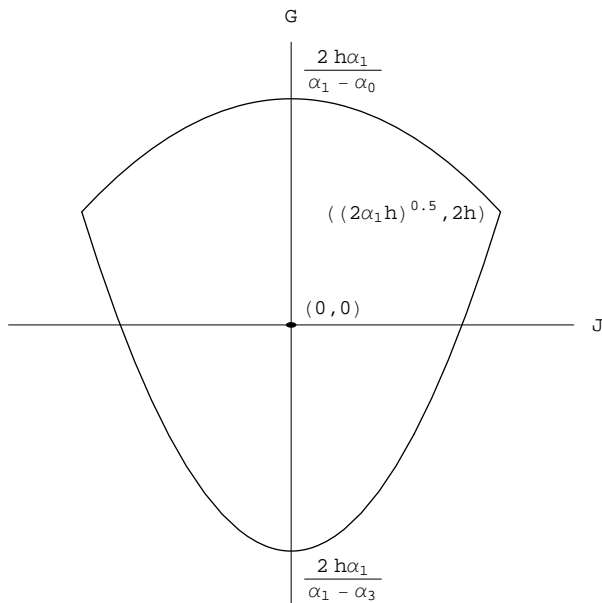

Figure 3: Bifurcation Diagram for the ellipsoid with axis $\alpha_0 < \alpha_1 = \alpha_2 < \alpha_3$.

The bifurcation diagram figure 3 can be considered as the square root of the diagram in figure 2 top right. The line $J = 0$ is where the lines $F_1 = 0$ and $F_2 = 0$ collapse. However, in the limit coming from the generic case the whole line would appear to be critical, since it is on the boundary of the image of the energy-momentum map. Recall that the limit of $F_2(\alpha_2 - \alpha_1)$ (or $F_1(\alpha_1 - \alpha_2)$) equals J^2 , but not J . Obviously J^2 is singular when $J = 0$, but J itself is not. Thus the square root of figure 2 top right gives figure 3. Upon this transition most of the critical points along the lines $F_1 = F_2 = 0$ disappear, except for the isolated critical point, which can be thought of as the remainder of the intersection of the two lines and the critical curve corresponding to the umbilic line $\lambda_1 = \lambda_2$ (in the generic system). Moreover the two corank 2 points at the corners of the triangle in figure 2 top right only have corank 1 after passing from J^2 to the “better” constant of motion J . Finally, the multiplicity of the regular T^3 changes from 2 to 1 for every regular point in the image.

The fibre of a regular value in the image of \mathcal{EM} is a T^3 by the Liouville-Arnold theorem. We now wish to find the fibres of the energy momentum map at the singular values in the bifurcation diagram, in particular at the isolated critical value.

Theorem 5.2. *The singular fibres over the boundary curves of the image of the energy momentum map at constant energy, with the exception of their intersections, are 2-tori T^2 . At each intersection point of the boundary curves the singular fibre is S^1 . The singular fibre over the isolated singularity at the origin is the direct product of S^1 and a doubly pinched torus T^2 .*

Proof. At the boundary of the image all singularities are of elliptic type, and hence the singular fibre is T^{3-r} where r is the corank of the singularity; $r = 1$ on the upper and

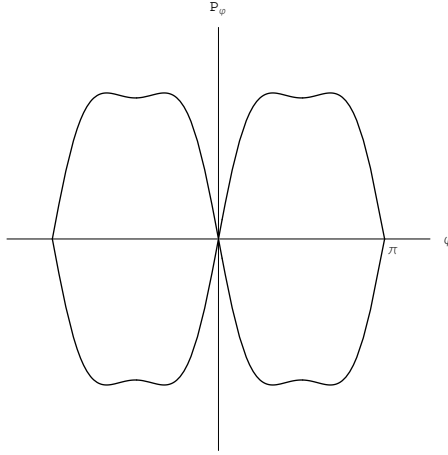

Figure 4: The intersection of the preimage of the isolated singular point $(j, g) = (0, 0)$ with the Poincaré section $x_3 = 0$ in reduced phase space. The separatrix is of type C_2 before quotient by \mathbb{Z}_2 .

lower curve and $r = 2$ at their intersection points.

The upper boundary with $F_0 = 0$ consists of all orbits in the geodesic flow on the ellipsoid of revolution defined by $x_0 = y_0 = 0$. Reduction maps each T^2 of this system to a relative periodic orbit. The isolated periodic orbit in the 12-plane of the geodesic flow on the ellipsoid of revolution corresponds to the extremal points with $J = \pm\sqrt{2\alpha_1\hbar}$. Reduction maps this relative equilibrium to the fixed point $\xi = (0, \sqrt{\alpha_1}, 0)$ on the middle-axis of the reduced ellipsoid. A similar statement holds for the lower boundary $F_3 = 0$. The isolated periodic orbit in the 12 plane is common to both ellipsoids of revolution.

The singular fibre for the isolated critical value at the origin of the bifurcation diagram contains two circles of critical points in the 03-plane, see above. The critical points are non-degenerate and of focus-focus type. From the general theory [18] it follows that it is an almost direct product of a pinched torus multiplied by S^1 . Since there are two circles of critical points in the singular fibre the number of pinches is 2.

The fibre over the isolated singularity is complicated as it is not of elliptic type and thus contains the non-critical points of the separatrix in addition to the two circles of singular points. By lemma 4.1 the reduced system for $j = 0$ is the geodesic flow on the 2-ellipsoid quotient by the \mathbb{Z}_2 action S . Ignoring the quotient the reduced singular fibre consists of the unstable isolated periodic orbits in the plane $\xi_1 = 0$ and their separatrix. In [2] it was shown that the topology of this singular fibre is $C_2 \times S^1$, where C_2 stands for two circles intersecting in two points. This can be seen from the Poincaré section $\xi_2 = 0$. Since $\xi_2 = \eta_2 = 0$ is an invariant subflow the boundary of the section with $\eta_2 \geq 0$ is an invariant set and it is the only place where the flow is not transverse to the section. In configuration space the section condition is the ellipse in the 01-plane, and it can be parametrised by an angle ϕ by $(\xi_0, \xi_1) = (\sqrt{\alpha_0} \cos \phi, \sqrt{\alpha_1} \sin \phi)$. The momentum p_ϕ conjugate to ϕ then gives the momenta as $(\eta_0, \eta_1) = (\sqrt{\alpha_0} \sin \phi, -\sqrt{\alpha_1} \cos \phi)p_\phi/d$ where $d = \alpha_0 \sin^2(\phi) + \alpha_1 \cos^2(\phi)$.

The reduced Hamiltonian can be solve for η_2 on the section and thus the integral G can be written as a function of (ϕ, p_ϕ) on the section:

$$2h \frac{\sin^2 \phi}{\alpha_3 - \alpha_1} = -g \frac{1}{\alpha_1} + \frac{p_\phi^2}{d^2} \left(\frac{d \sin^2 \phi}{\alpha_3 - \alpha_1} + \frac{1}{2} \left(\frac{\alpha_1 + \alpha_0}{\alpha_1 - \alpha_0} + \cos 2\phi \right) \right). \quad (23)$$

The singular fibre is $g = 0$ ($j = 0$ was already used in the singular reduction), and it defines two circles winding around the (ϕ, p_ϕ) cylinder intersecting at the points $(0, 0)$ and $(\pi, 0)$, which are critical points of g . This is the ‘‘atom’’ C_2 [2]. Now the quotient with respect to S has to be performed. In the new coordinates the action of S is $(\phi, p_\phi) \rightarrow (-\phi, -p_\phi)$, which fixes ξ_0 and η_0 , but flips the sign of ξ_1 and η_1 . This action has two fixed points $(0, 0)$, and $(\pi, 0)$, so that the fixed points of S coincide with the critical points of g . Reduction of the cylinder by the \mathbb{Z}_2 action gives the ‘‘canoe’’ [4], with two singular points. The two singular points are connected by two half-circles. This is C_2/\mathbb{Z}_2 , where \mathbb{Z}_2 acts by reflection such that the intersection points are fixed.

Since the reduced flow is transverse to the section on the singular fibre the complete reduced singular fibre is $(C_2/\mathbb{Z}_2) \times S^1$. The singular fibre in full phase space is found by letting Φ act on the preimage of this set under the reduction map. Since the singular circles are fixed under Φ they will remain singular circles, while every other point will be multiplied by S^1 . Exchanging the order of the operations, first acting with Φ on the preimage of C_2/\mathbb{Z}_2 gives a double pinched torus, which is then multiplied by S^1 . This S^1 action also has a generator, which is a second global smooth action, see below.

□

Following the approach suggested by Nguyen Tien Zung in [19], one can reformulate the last statement of Theorem 5.2 by saying that the singularity corresponding to the isolated singular point is the direct product of the standard 4-dimensional focus-focus singularity with 2 pinches and a non-singular system with 1 degree of freedom. This is a kind of ‘‘almost direct product’’ decomposition which can be found for any non-degenerate singularity (see [19]). The fact that in our case the product is ‘‘direct’’ seems to be a general property of focus type singularities (Nguyen Tien Zung, private communication).

6 Actions and Monodromy

We found that the equations for geodesic flow are Liouville-Arnold integrable, and so the fibre over a regular point is a T^3 . Let C_1, C_2, C_3 be a basis of cycles on this torus. Due to the fact that the variables can be separated as in lemma 3.3, natural cycles are

$$C_1 : d\lambda_1 = d\lambda_2 = 0, C_2 : d\theta = d\lambda_2 = 0, C_3 : d\theta = d\lambda_1 = 0. \quad (24)$$

The adjective ‘natural’ is used in the technical sense of [17], and simply means to consider the obvious choice given by coordinate lines of the separating coordinate systems. Natural

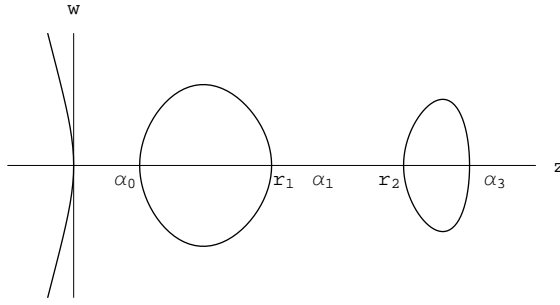

Figure 5: Real part of curve $w^2 = -z(z - \alpha_0)(z - r_1)(z - r_2)(z - \alpha_3)$ showing cycles.

though this may be, it will turn out that the corresponding actions are only continuous, but not smooth. The corresponding natural action variables are given by

$$I_1 = \frac{1}{2\pi} \oint_{C_1} p_\theta d\theta = p_\theta, \quad I_2 = \frac{m_2}{2\pi} \oint_{C_2} p_1 d\lambda_1, \quad I_3 = \frac{m_3}{2\pi} \oint_{C_3} p_2 d\lambda_2. \quad (25)$$

The first action is just the angular momentum with respect to the symmetry axis. The momentum p_i in the second and third actions is given in lemma 3.3, together with the polynomial \tilde{Q} in (18). The integer multipliers $m_2 = 2$ and $m_3 = 2$ arise due to the way in which the ellipsoidal coordinates are set up over the eight octants in \mathbb{R}^3 , see [8]. When I_2 (respectively I_3) is evaluated on the upper (respectively lower) boundary of the bifurcation diagram (Figure 3) the natural actions for the geodesic flow on the ellipsoid of revolution are found, see appendix.

The polynomial \tilde{Q} can be factored as $\tilde{Q}(z) = z(z - r_1)(z - r_2)$ where, in order to have real momenta p_1, p_2 ,

$$\alpha_0 \leq r_1 \leq \alpha_1 \leq r_2 \leq \alpha_3. \quad (26)$$

The integrals (25) are calculated on the hyperelliptic curve given by

$$w^2 = -\frac{A(z)\tilde{Q}(z)}{(z - \alpha_1)^2}. \quad (27)$$

The genus of this curve is one less than for a non-degenerate ellipsoid because the pole in A can be divided out. This is plotted in figure 5 and the cycles can be seen. Note that the part of the curve in the negative z range does not correspond to any real motion. Writing out the actions in full we have proved the following theorem

Lemma 6.1. *The actions of the geodesic flow on the three dimensional ellipsoid with equal middle axes are given by $I_1 = p_\theta$,*

$$I_2 = \frac{1}{\pi} \oint_{C_2} \frac{\tilde{Q}}{2(\alpha_1 - z)w} dz \quad \text{and} \quad I_3 = \frac{1}{\pi} \oint_{C_3} \frac{\tilde{Q}}{2(z - \alpha_1)w} dz. \quad (28)$$

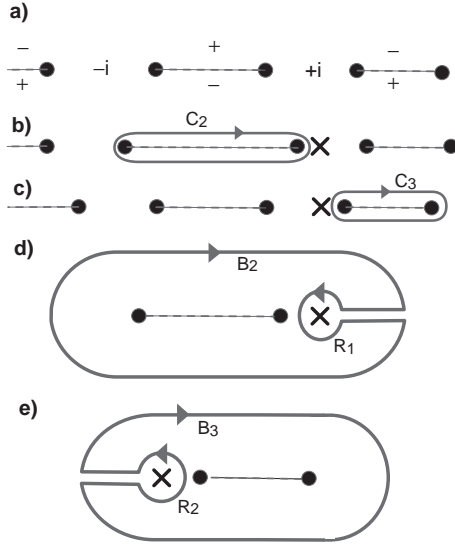

Figure 6: Complex plane $\mathbb{C}(s)$ and choice of branch cuts (a), integration paths for p_θ for $r_1 \rightarrow \alpha_1$ (b) and $r_2 \rightarrow \alpha_1$ (c). (d) and (e) show decomposition of C_2 for case (b) and C_3 for case (c).

Note that the constants of motion p_θ , h and g are implicit in the definition of $\tilde{Q}(z)$ given in (18). The integrand has a simple pole at α_1 and branch points at α_0 , α_3 , and at r_1 and r_2 for $p_\theta \neq 0$. The integrals are hyper-elliptic of genus 2 and third kind. The three natural actions I_1 , I_2 and I_3 are functions of p_θ , g and h . However, we will show that I_2 and I_3 are not differentiable at $p_\theta = 0$. The derivative of these actions with respect to p_θ is given by

$$\frac{\partial I_i}{\partial p_\theta} = -\frac{(\alpha_3 - \alpha_1)(\alpha_1 - \alpha_0)p_\theta}{2\pi\alpha_1} \oint_{C_i} \frac{z}{w(\alpha_1 - z)} dz \quad (29)$$

Figure 6 indicates the poles, branch points and integration paths. Note that as $p_\theta \rightarrow 0$, then we find that one of the branch points r_i tends to the pole at α_1 .

$$g < 0 \Rightarrow \lim_{p_\theta \rightarrow 0} r_2 = \alpha_1, \quad g > 0 \Rightarrow \lim_{p_\theta \rightarrow 0} r_1 = \alpha_1. \quad (30)$$

We follow the approach of Cushman [4] and Dullin [17] and deform the integration path so that the integral may be split up into three or two separate integrals depending upon which case is being considered. The integral around the branch points C_i is expanded into loops B_i around the poles and then the contributions from the poles R_1 , R_2 are subtracted.

$$\oint_{C_2} = \oint_{B_2} + \oint_{R_1}, \quad \oint_{C_3} = \oint_{B_3} + \oint_{R_2} \quad (31)$$

Now evaluating the residue of the integrand at the simple pole, we have

$$\text{Res}_{z=\alpha_1} \frac{z}{(z - \alpha_1)w} dz = \frac{\alpha_1}{2(\alpha_3 - \alpha_1)(\alpha_1 - \alpha_0)i|p_\theta|} \quad (32)$$

We then have for $g < 0$,

$$\lim_{p_\theta \rightarrow 0} \frac{\partial I_2}{\partial p_\theta} = 0, \quad \lim_{p_\theta \rightarrow 0^+} \frac{\partial I_3}{\partial p_\theta} = -1, \quad \lim_{p_\theta \rightarrow 0^-} \frac{\partial I_3}{\partial p_\theta} = 1 \quad (33)$$

and for $g > 0$,

$$\lim_{p_\theta \rightarrow 0^+} \frac{\partial I_2}{\partial p_\theta} = -1, \quad \lim_{p_\theta \rightarrow 0^-} \frac{\partial I_2}{\partial p_\theta} = 1, \quad \lim_{p_\theta \rightarrow 0} \frac{\partial I_3}{\partial p_\theta} = 0. \quad (34)$$

In other words we have

$$\lim_{p_\theta \rightarrow 0^-} \frac{\partial I_i}{\partial p_\theta} \neq \lim_{p_\theta \rightarrow 0^+} \frac{\partial I_i}{\partial p_\theta}, \quad i = 2, 3$$

Since I_2 and I_3 are even functions of p_θ , differentiability at 0 would imply that the derivative is zero at $p_\theta = 0$. But there is a discontinuity in the derivative here and so the natural actions are continuous but not differentiable at $p_\theta = 0$. By changing the basis of cycles locally smooth actions can be found, but they are then globally multi-valued. We describe this in the following manner.

Let the natural actions for positive p_θ be represented by $I_+ = (I_1, I_2, I_3)^t$, and those for negative p_θ by I_- . I_1 is odd and I_2, I_3 are even, hence

$$I_-(-p_\theta) = SI_+(p_\theta) \quad (35)$$

where $S = \text{diag}(-1, 1, 1)$. We then define unimodular matrices M_i such that I_+ and $M_i I_-$ join smoothly at $p_\theta = 0$. This smoothes the actions locally. For continuity on the line $p_\theta = 0$ it is necessary that below the isolated critical point

$$I_+ = M_1 I_- = M_1 S I_+ = M_1 I_+, \quad g > 0 \quad (36)$$

and above

$$I_+ = M_2 I_- = M_2 S I_+ = M_2 I_+, \quad g < 0 \quad (37)$$

Therefore $(0, I_2, I_3)^t$ is an eigenvector of M_i with eigenvalue 1 [6]. The eigenvector equations show that M_i must have the form

$$M_i = \begin{pmatrix} \delta_i & 0 & 0 \\ \kappa_i & 1 & 0 \\ \beta_i & 0 & 1 \end{pmatrix} \quad (38)$$

and since $M_i \in SL(3, \mathbb{Z})$ as it is unimodular, we must have $\delta_i = 1$.

Now note that $\frac{\partial I_3}{\partial p_\theta} = 0$ and $\frac{\partial I_2}{\partial p_\theta} = -\text{sgn}(p_\theta)$ for $g > 0$ and so we may find M_1 because here

$$M_1 \frac{\partial I_-}{\partial p_\theta} = \frac{\partial I_+}{\partial p_\theta} \quad (39)$$

which implies that $\kappa_1 = -2$ and $\beta_1 = 0$.

For $g < 0$ we have $\frac{\partial I_2}{\partial p_\theta} = 0$ and $\frac{\partial I_3}{\partial p_\theta} = -\text{sgn}(p_\theta)$ and by

$$M_2 \frac{\partial I_-}{\partial p_\theta} = \frac{\partial I_+}{\partial p_\theta} \quad (40)$$

we find that $\kappa_2 = 0$ and $\beta_2 = -2$.

The monodromy matrix M for a counter clockwise cycle around the origin $(p_\theta, g) = (0, 0)$ is given by $M = (M_2 S)^{-1} (M_1 S)$, which gives

$$M = \begin{pmatrix} 1 & 0 & 0 \\ 2 & 1 & 0 \\ -2 & 0 & 1 \end{pmatrix}. \quad (41)$$

By a final unimodular change of basis, defined by $TMT^{-1} = N$, where an appropriate choice of T is

$$T = \begin{pmatrix} 1 & 0 & 0 \\ 0 & -1 & -1 \\ 0 & 0 & -1 \end{pmatrix}, \quad (42)$$

we put the monodromy matrix into normal form and have proved the following theorem:

Theorem 6.2. *Monodromy. The geodesic flow on the ellipsoid with equal middle axes has a non-trivial monodromy. The monodromy matrix has normal form*

$$N = \begin{pmatrix} 1 & 0 & 0 \\ 0 & 1 & 0 \\ 2 & 0 & 1 \end{pmatrix}.$$

This result is consistent with the general theory of non-degenerate singularities of integrable systems developed in [13], [19], [20]. According to Nguyen Tien Zung [19], each non-degenerate singularity can topologically be presented as an almost direct product of “basic” singularities. In our case, this is just the direct product of the 4-dimensional focus-focus singularity with two pinched points and a non-singular system with one degree of freedom (see the last statement of theorem 5.2). It is easily seen that the monodromy matrix in such a situation is decomposed into two blocks: $\begin{pmatrix} 1 & 2 \\ 0 & 1 \end{pmatrix}$ which correspond to the focus-focus singularity with two pinches (see [13], [20]) and the trivial 1-dimensional block. Up to a change of basis, this is exactly the matrix from theorem 6.2.

A The geodesic flow on 2-ellipsoids

Here we briefly describe the well known classical situation of the 2-ellipsoid embedded in \mathbb{R}^3 . There are three critical periodic orbits obtained by intersecting the ellipsoid with

any coordinate plane $x_i = 0$, $i = 0, 1, 2$. The middle plane $x_1 = 0$ contains the four umbilic points defined by $\lambda_1 = \lambda_2 = \alpha_1$ where λ_i are (algebraic) elliptic coordinates on the ellipsoid. Introducing elliptic functions $\lambda_i(\phi_i)$ gives a double covering by a torus with coordinates ϕ_i branched over the umbilic points. To analyse any motion that hits the umbilic points these ellipsoidal covering coordinates cannot be used. It turns out that the only motion that ever crosses the umbilic points are the two unstable periodic orbits in the $x_1 = 0$ plane *and* their separatrices. The image of the momentum map for fixed energy is a line segment with three corank 1 non-degenerate critical values. The endpoints correspond to the stable orbits in the $x_0 = 0$ and $x_2 = 0$ plane. There is another critical value in the middle of the interval corresponding to the orbits in the plane $x_1 = 0$. The fibre of this point contains the two unstable orbits connected by a heteroclinic separatrix. The topology is that of two circles intersecting in two points multiplied by a circle. This can be seen by considering the Poincaré section $x_0 = 0$ with $\dot{x}_0 = y_0 \geq 0$ on the section. The boundary of the section $x_0 = y_0 = 0$ are itself geodesics, otherwise the flow is transverse to the section. The topology of the section with $\dot{x}_0 > 0$ is that of a finite cylinder, i.e. an annulus. The restriction of the second integral G to the surface of section and to constant energy gives a function with two minima (corresponding to the two geodesics in the x_2 -plane) and two saddles (corresponding to the two geodesics in the x_1 -plane). The separatrices intersect the section along two curves wrapping around the cylinder once and intersecting in two points, like $p_\phi = \pm \cos \phi$.

If two semi-axes are the same we obtain a prolate or oblate ellipsoid of revolution. For this system it is an elementary exercise to compute the non-trivial action. For the oblate case where the longer axes are equal, $\alpha_0 < \alpha_1 = \alpha_2$ the action is given by

$$I_l = \frac{1}{2\pi} \oint_{C_2} p_s ds \quad (43)$$

where

$$p_s^2 = \left(2h - \frac{\alpha_0}{\alpha_1(\alpha_0 - s^2)} J^2 \right) \frac{(\alpha_0^2 + (\alpha_1 - \alpha_0)s^2)}{\alpha_0(\alpha_0 - s^2)}. \quad (44)$$

The essential integral is a function of the ratio $\rho = \alpha_0/\alpha_1$ and the scaled angular momentum $\hat{j} = j/\sqrt{2h\alpha_1}$ only. Expressing I_l in Legendre normal form gives

$$\frac{1}{4} \frac{2\pi I_l}{\sqrt{2h\alpha_1}} = U \mathcal{E}(k) - \frac{\rho \hat{j}}{U} \Pi(\beta^2, k), \quad U^2 = 1 - \hat{j}^2(1 - \rho), \quad (45)$$

where \mathcal{E} and Π are Legendre's complete elliptic integrals of the second and third kind respectively and the modulus and parameter are

$$k^2 = 1 - \rho U^{-2}, \quad \beta^2 = k^2/1 - \rho. \quad (46)$$

For the oblate case $\rho > 1$ and thus $k^2 < 0$. Upon replacing U by iU the above formula for the action also holds in this case.

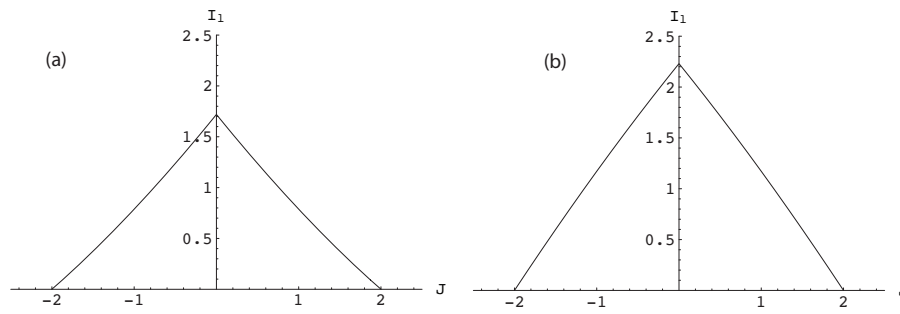

Figure 7: Actions for ellipsoids of revolution: (i) $\alpha_0 < \alpha_1 = \alpha_2$, (ii) $\alpha_1 = \alpha_2 < \alpha_3$, where $\alpha_0 = 1$, $\alpha_1 = 2$, $\alpha_3 = 4$, $h = 1$.

References

- [1] A. V. Bolsinov and A. T. Fomenko. Orbital classification of geodesic flows of two-dimensional ellipsoids. The Jacobi problem is orbitally equivalent to the integrable Euler case in the dynamics of a rigid body. *Funktsional. Anal. i Prilozhen.*, 29(3):1–15, 96, 1995.
- [2] A. V. Bolsinov and A. T. Fomenko. *Integrable Hamiltonian systems*. Chapman & Hall/CRC, Boca Raton, FL, 2004. Geometry, topology, classification, Translated from the 1999 Russian original.
- [3] R. H. Cushman and D. A. Sadvskii. Monodromy in the hydrogen atom in crossed fields. *Phys. D*, 142(1-2):166–196, 2000.
- [4] Richard H. Cushman and Larry M. Bates. *Global aspects of classical integrable systems*. Birkhäuser Verlag, Basel, 1997.
- [5] J. J. Duistermaat. On global action-angle coordinates. *Comm. Pure Appl. Math.*, 33(6):687–706, 1980.
- [6] H. R. Dullin, J. M. Robbins, H. Waalkens, S. C. Creagh, and G. Tanner. Maslov indices and monodromy. *J. Phys. A*, 38(24):L443–L447, 2005.
- [7] Holger R. Dullin, Andrea Giacobbe, and Richard H. Cushman. Monodromy in the resonant swing spring. *Phys. D*, 190(1-2):15–37, 2004.
- [8] Holger R. Dullin, Peter H. Richter, Alexander P. Veselov, and Holger Waalkens. Actions of the Neumann systems via Picard-Fuchs equations. *Phys. D*, 155(3-4):159–183, 2001.
- [9] Luther Pfahler Eisenhart. Separable systems of Stackel. *Ann. of Math. (2)*, 35(2):284–305, 1934.

- [10] Carl Gustav J. Jacobi. *Vorlesungen über Dynamik*. Gesammelte Werke, Supplement Band. Reimer, Berlin, 1884.
- [11] Horst Knörrer. Geodesics on the ellipsoid. *Invent. Math.*, 59(2):119–143, 1980.
- [12] Horst Knörrer. Geodesics on quadrics and a mechanical problem of C. Neumann. *J. Reine Angew. Math.*, 334:69–78, 1982.
- [13] V. S. Matveev. Integrable Hamiltonian systems with two degrees of freedom. Topological structure of saturated neighborhoods of points of focus-focus and saddle-saddle types. *Mat. Sb.*, 187(4):29–58, 1996.
- [14] J. Moser. Various aspects of integrable Hamiltonian systems. In *Dynamical systems (C.I.M.E. Summer School, Bressanone, 1978)*, volume 8 of *Progr. Math.*, pages 233–289. Birkhäuser Boston, Mass., 1980.
- [15] D. A. Sadovskii and B. I. Zhilinskiĭ. Monodromy, diabolic points, and angular momentum coupling. *Phys. Lett. A*, 256(4):235–244, 1999.
- [16] H. Waalkens, H. R. Dullin, and P. H. Richter. The problem of two fixed centers: bifurcations, actions, monodromy. *Physica D*, 196:265–310, 2004.
- [17] Holger Waalkens and Holger R. Dullin. Quantum monodromy in prolate ellipsoidal billiards. *Ann. Physics*, 295(1):81–112, 2002.
- [18] Nguyen Tien Zung. Singularities of integrable geodesic flows on multidimensional torus and sphere. *J. Geom. Phys.*, 18(2):147–162, 1996.
- [19] Nguyen Tien Zung. Symplectic topology of integrable Hamiltonian systems. I. Arnold-Liouville with singularities. *Compositio Math.*, 101(2):179–215, 1996.
- [20] Nguyen Tien Zung. A note on focus-focus singularities. *Differential Geom. Appl.*, 7(2):123–130, 1997.