

This item was submitted to Loughborough's Institutional Repository (<https://dspace.lboro.ac.uk/>) by the author and is made available under the following Creative Commons Licence conditions.



**CC creative commons**  
COMMONS DEED

**Attribution-NonCommercial-NoDerivs 2.5**

**You are free:**

- to copy, distribute, display, and perform the work

**Under the following conditions:**

**BY:** **Attribution.** You must attribute the work in the manner specified by the author or licensor.

**Noncommercial.** You may not use this work for commercial purposes.

**No Derivative Works.** You may not alter, transform, or build upon this work.

- For any reuse or distribution, you must make clear to others the license terms of this work.
- Any of these conditions can be waived if you get permission from the copyright holder.

**Your fair use and other rights are in no way affected by the above.**

This is a human-readable summary of the [Legal Code \(the full license\)](#).

[Disclaimer](#) 

For the full text of this licence, please go to:  
<http://creativecommons.org/licenses/by-nc-nd/2.5/>



World Health  
Organization

**WEDC**

# TECHNICAL NOTES ON DRINKING-WATER, SANITATION AND HYGIENE IN EMERGENCIES

**Series Editor: Bob Reed**

Illustrated by Rod Shaw and Ken Chatterton

- 1** Cleaning hand dug wells
- 2** Cleaning and rehabilitating boreholes
- 3** Cleaning and disinfecting water storage tanks and tankers
- 4** Rehabilitating small-scale piped water distribution systems
- 5** Emergency treatment of drinking-water at the point of use
- 6** Rehabilitating water treatment works after an emergency
- 7** Solid waste management in emergencies
- 8** Disposal of dead bodies in emergency conditions
- 9** How much water is needed in emergencies
- 10** Hygiene promotion in emergencies
- 11** Measuring chlorine levels in water supplies
- 12** Delivering safe water by tanker
- 13** Planning for excreta disposal in emergencies
- 14** Technical options for excreta disposal in emergencies
- 15** Cleaning wells after seawater flooding





# Cleaning hand-dug wells

**Flooding, earthquakes, civil unrest and other natural and man-made disasters often cause damage to hand-dug wells. This technical note sets out the actions needed to repair and rehabilitate a hand-dug well so that it can be returned to its former condition. The emergency repair and rehabilitation measures proposed are temporary and should be followed by measures for permanent rehabilitation.**

## Steps for cleaning

Figure 1.1 outlines a four-step approach to cleaning a wells after natural or man-made disasters. It is an emergency approach designed to rehabilitate wells so that they produce water of a similar quality to that supplied before the disaster (see Box 1.1).

Technical Note 15 gives further information on wells contaminated by seawater.

### Step 1: Inventory of existing wells

The disaster may have contaminated or damaged a large number of wells. The first step must be to select which wells should be repaired first. They are the ones that are used most and that are easiest to repair. The following actions should help you to make an informed selection.

- Meet with community leaders and ask them which wells serve each section of the community.
- Select the most commonly used wells as a source for drinking-water that provided a plentiful supply.
- Check there are no obvious sources of contamination from nearby latrines, ponds or surface water. Also map livestock areas (pig pens, cattle sheds, chicken coops) as potential sources of contamination by animal waste.
- Assess the type and extent of damage to the top of the well and the lining.
- Ask the community about the original depth of the well. Use this to estimate the amount of silt and debris in the well.
- Test the pump (if there is one) to see if it is still working. If not, determine the repairs necessary.
- Estimate the resources needed for repairs (personnel, equipment, time and materials).

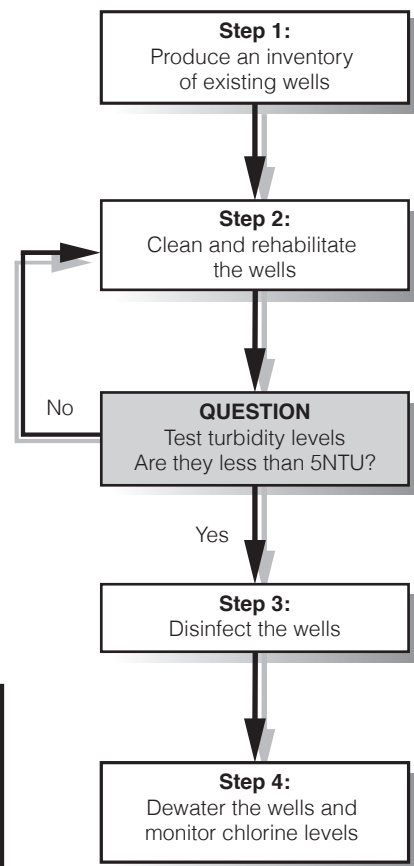


Figure 1.1. Steps for cleaning and disinfecting wells

### Box 1.1. Hand-dug wells water quality

Water taken from hand-dug wells is often of poor quality, mainly due to the poor construction of the above-ground elements and unhygienic methods of collecting water. The steps described here will not overcome these problems as they are designed to return the well to its original condition. Sources of further information on improving and upgrading wells are given on page 1.4.



## Step 2: Rehabilitation and cleaning of wells

The amount of rehabilitation and cleaning required will depend on the amount of damage caused by the disaster. Typically it will include the following steps:

1. Remove and repair/replace the pumping mechanism or lifting device.
2. Remove polluted water and debris from the well using either buckets or pumps. Special care must be taken when using a pump to remove water from wells contaminated with seawater. (See Technical Note 15 for more details.)
3. Repair/reline the well walls to reduce sub-surface contamination.
4. Clean the well lining using a brush and chlorinated water (see Box 1.2).
5. Place a 150mm layer of gravel in the base of the well to protect it from disturbance.
6. Seal the top of the well using a clay sanitary seal (Figure 1.2).
7. Construct a drainage apron and head wall around the well to prevent surface water, insects and rodents from entering the well. Provide a cover for the well.

### Check turbidity and pH

Following cleaning and repair, allow the water level in the well to return to its normal level. Measure the turbidity and pH levels to check whether chlorination will be effective. This can be done using a simple method described in Box 1.3.

Never chlorinate turbid water because suspended particles can protect micro-organisms. Table 1.1 (page 1.4) outlines the reasons why pH and turbidity are important and what can be done to ensure guideline levels are met.

If the turbidity of the well water is greater than 5NTU after the cleaning and rehabilitation stage, remove all water in the well once again.

### Box 1.2. Calculating the chlorine dosage for disinfecting a well using high strength calcium hypochlorite (HSCH)

#### Equipment

- 20 litre bucket
- HSCH chlorine granules or powder

#### Method

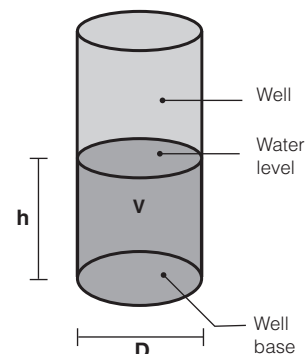
- Calculate the volume of water in the well using the formula:

$$V = \frac{\pi D^2 h}{4}$$

Where

- V = volume of water in the well (m<sup>3</sup>)
- D = diameter of the well (m)
- h = depth of water (m)
- π = 3.142

- Fill the bucket with clear water from the well.
- Add about 300g of HSCH and stir until dissolved.
- For every cubic metre (m<sup>3</sup>) of water in the well add 10 litres (half bucket) of the chlorine solution.
- Double the quantity of HSCH added if the solution is to be used for cleaning well linings or aprons.



**HSCH and bleach give off chlorine gas which is a serious health hazard. Try to clean the well lining from outside the well using a long-handled brush. If you must enter the well, wear full protective clothing and a breathing apparatus and provide a strong air flow inside the well to carry away the chlorine gas.**

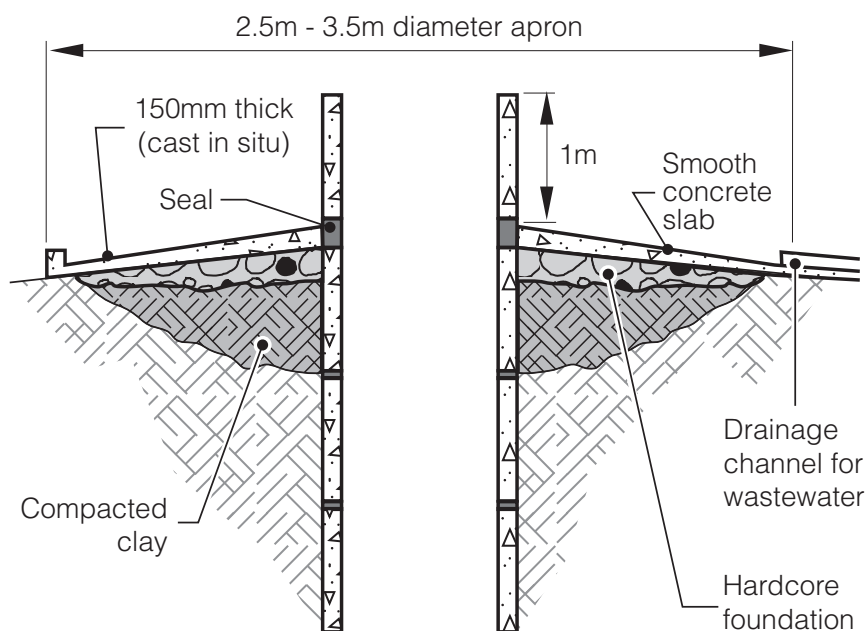


Figure 1.2. Sealing the top of a well

Allow the well to refill with water and test the turbidity levels again.

If the water is still turbid, it is probably due either to:

- the failure of the filter pack in the bottom and around the side of the well; or – more likely –
- to poor protection of the top of the well allowing surface water contamination.

Neither of these problems can be solved immediately. However, it is probably safe to allow the local community to begin using the well as the water quality should be at least as good as it was before the disaster.

### Step 3: Disinfection of the well

Before water is extracted from the well for consumption, disinfection is recommended to ensure well components are hygienically clean. Such disinfection will *not* provide residual protection and therefore measures to ensure safe collection, handling and storage at home are highly recommended. This may include use of household water treatment. Please see Note 5 for details.

Chlorine has the advantage of being widely available, simple to measure and use, and it dissolves easily in water. Its disadvantages are that it is a hazardous substance (to be stored and handled with care) and it is not effective against some pathogens (i.e. it will not remove *cryptosporidium*, a cyst that causes a considerable proportion of diarrhoeal disease worldwide).

The chlorine compound most commonly used is High Strength Calcium Hypochlorite (HSCH) in powder or granule form as it contains 60 – 80% chlorine. Also used is sodium hypochlorite in liquid bleach or bleaching powder form. Each chlorine compound has a different amount of usable chlorine depending on the quantity of time the product has been stored or exposed to the atmosphere and the way it is made. Box 1.2 outlines methods for

### Box 1.3. Measuring turbidity and the pH level of water

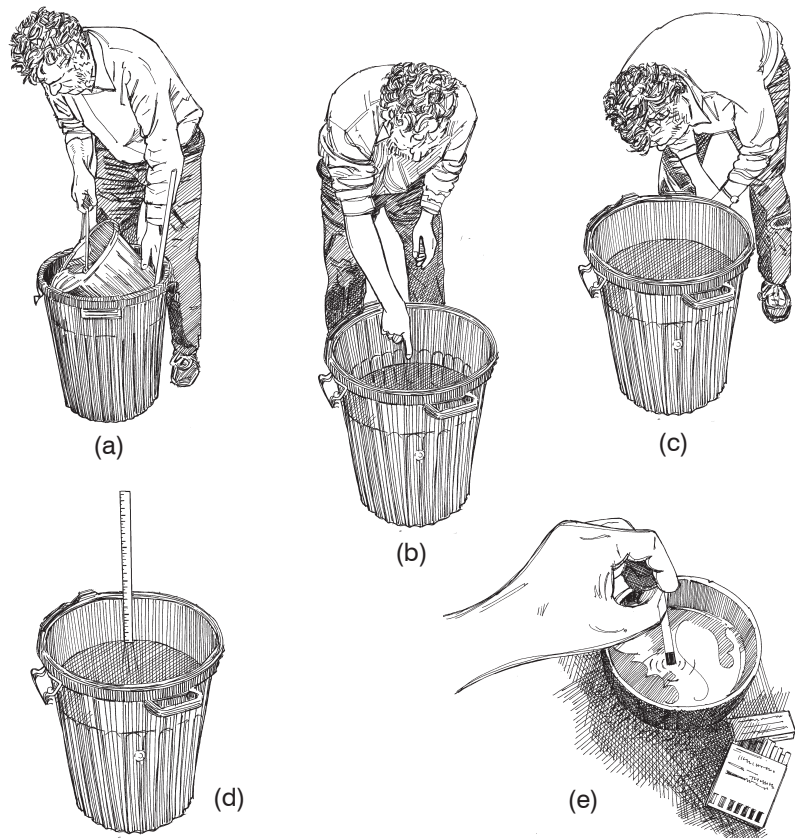
Turbidity is the cloudiness or haziness of a fluid caused by individual particles. The measurement of turbidity, therefore, is a key test of water quality. Specialist laboratory or field equipment (a nephelometer) is required to measure turbidity accurately in Nephelometric Turbidity Units (NTU). If you do not have access to such specialist equipment, then a reasonable NTU estimate can be made using locally available materials as shown below.

#### Equipment

- A clean container with a dark-coloured interior surface – such as an oil drum or a dustbin – and with a minimum depth of 50cm
- A bucket
- A dull brass or copper coin with an approximate diameter of 2.5cm
- A long measuring pole or steel tape measure

#### Method

1. Place the coin in the bottom of the container.
2. Gently add water drawn from the well a little at a time (a). At regular intervals, wait for the surface of the water to calm and check to see if the coin is still visible (b). When it can no longer be seen (c), measure the depth of the water (d).
  - If the depth of the water is *less than* 32cm, then the turbidity is likely to be *greater than* 20NTU.
  - If the depth of the water is between 32 and 50cm, then the turbidity is likely to be between 10 and 20NTU.
  - If the depth of the water is *greater than* 50cm, then the turbidity is likely to be *less than* 10NTU.
3. Measure the pH level of the water using pH paper strips (e).



# Cleaning hand-dug wells

calculating appropriate chlorine doses for HSCH granule chlorine. Stir the water in the well thoroughly with a long pole and then allow the water to stand for at least 30 minutes.

## Step 4: Dewater the well

Following the contact period, remove all water in the well using a pump or bucket. When the well has refilled, wait a further 30 minutes and measure the chlorine concentration. If the residual chlorine concentration is less than 0.5 mg/l it is likely that the well has been restored to its original condition. It does not mean, however, the water is safe for drinking. If the concentration is greater than 0.5mg/l, remove all the water from the well again and repeat the process.

Two issues need extra care when dewatering the wells:

- 1) water with high concentration of chlorine should not flow into streams or wetlands;
- 2) when dewatering on coastal areas salt water intrusion should be avoided (see Technical Note 15).

Table 1.1. Physico-chemical parameters

Parameter	WHO GDWQ*	Why?	Corrective action
pH	6-8	pH of 6.8-7.2 is required to reduce level of chlorine required.	If pH is less than 6 add hydrated lime (calcium hydroxide) to raise pH before chlorination
Turbidity	< 5NTU	High turbidity requires more chlorine to oxidise organic matter	Check the turbidity of the water entering the well through the walls and base.  Make sure there is no contamination from the surface.

\*WHO Guidelines for drinking water quality

**Do not allow anyone to use the well during the cleaning process.**

**The water will have a strong concentration of chlorine that will give it a bad taste and smell and could be dangerous.**



## Further information

CDC (Undated) *Disinfection of wells following an emergency*. Centre for Disease Control and Prevention. USA.  
<http://emergency.cdc.gov/disasters/wellsdisinfect.asp>

Collins, S. (2000) *Hand dug wells*. Series of Manuals on Drinking Water Supply Vol. 5.

Godfrey, S. (2003) 'Appropriate chlorination techniques for wells in Angola', *Waterlines*, Vol. 21, No. 5, pp 6-8, ITDG Publishing, UK.

OXFAM (Undated) *Repairing, cleaning and disinfection of hand dug wells*. [http://www.oxfam.org.uk/resources/downloads/emerg\\_manuals/draft\\_oxfam\\_tech\\_brief\\_wellcleaning.pdf](http://www.oxfam.org.uk/resources/downloads/emerg_manuals/draft_oxfam_tech_brief_wellcleaning.pdf)

SKAT: St Gallen <http://www.rwsn.ch/documentation/skatdocumentation.2005-11-14.6529097230/file>

WHO (2011) *WHO Guidelines for Drinking-water Quality*, 4th edition. World Health Organization, Geneva.

WHO (2013) 'How to measure residual chlorine in water'. Technical Note 11

WHO (2013) 'Cleaning wells after seawater flooding'. Technical Note 15



**World Health Organization**

Water, Sanitation, Hygiene and Health Unit  
 Avenue Appia 20  
 1211 Geneva 27  
 Switzerland

Telephone: + 41 22 791 2111  
 Telephone (direct): + 41 22 791 3555/3590  
 Fax (direct): + 41 22 791 4159  
 URL: [www.who.int/water\\_sanitation\\_health](http://www.who.int/water_sanitation_health)

Prepared for WHO by WEDC. Authors: Sam Godfrey and Bob Reed. Series Editor: Bob Reed.  
 Editorial contributions, design and illustrations by Rod Shaw  
 Line illustrations courtesy of WEDC / IFRC. Additional graphics by Ken Chatterton.

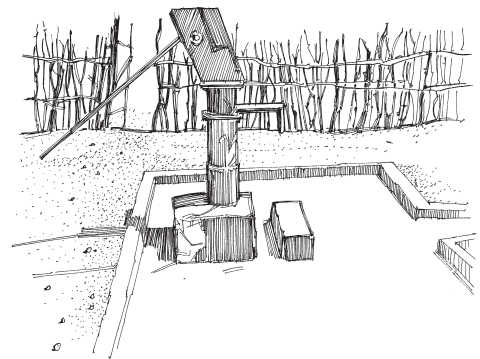
Water, Engineering and Development Centre Loughborough University Leicestershire LE11 3TU UK  
 T: +44 1509 222885 F: +44 1509 211079 E: [wedc@lboro.ac.uk](mailto:wedc@lboro.ac.uk) W: <http://wedc.lboro.ac.uk>





# Cleaning and rehabilitating boreholes

Boreholes are resistant to many forms of natural and man-made disasters. Although the components above ground may be damaged, the narrow opening at the top of the borehole often prevents contamination of the water source or damage to the pump components below ground. The main exception to this is damage caused by earthquakes, which can be greater below ground than what can be seen on the surface. This technical note sets out the actions required to repair and rehabilitate a borehole after any disaster.



## Driven and drilled boreholes

Boreholes fitted to handpumps fall into two categories pictured overleaf: *driven* (Figure 2.3) and *drilled* (Figure 2.4). In general, it is easier and cheaper to replace damaged driven boreholes than rehabilitate them. It is usually worth rehabilitating drilled boreholes, however, as they are much more expensive to install and require specialist drilling equipment. This note focuses, therefore, on drilled boreholes.

Additional care is needed in the rehabilitation of boreholes close to the sea or coastal swamps because of the possibility of seawater intrusion of the groundwater. Figure 2.1 outlines a three-stage approach to rehabilitating damaged drilled

boreholes. It is an emergency approach designed to produce water of a similar quality to that supplied before the disaster.

### Step 1: Assess the damage

- Meet with community leaders and ask them which handpumps serve each section of the community. Obtain any available records of the drilling of the borehole and the installation of the handpump, particularly concerning the materials used for lining the borehole, its overall depth and the depth to the screen.
- Select the handpumps that are most commonly used as a source of drinking-water, provided a plentiful supply before the emergency and are likely to be easiest to repair.

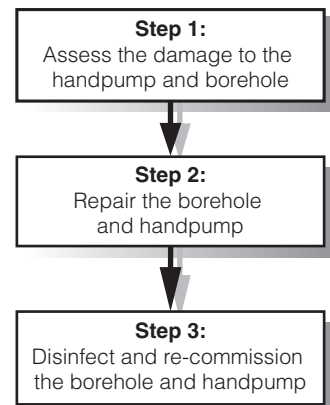


Figure 2.1. Steps for cleaning and disinfecting boreholes

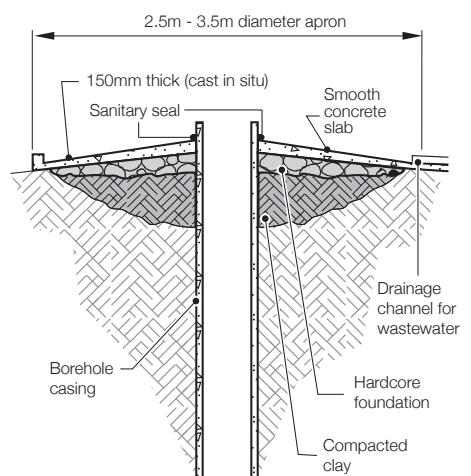


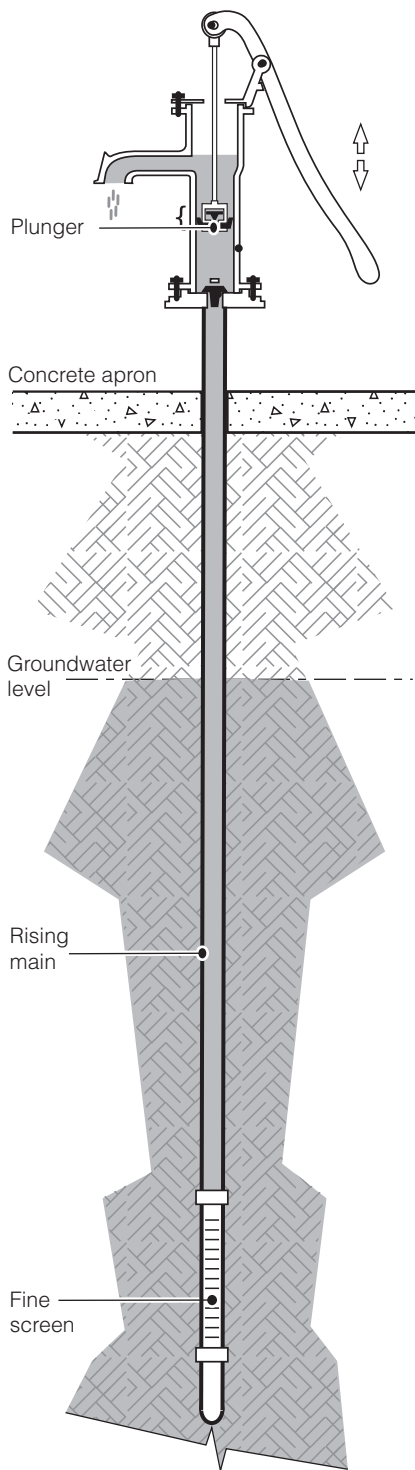
Figure 2.2. A sanitary seal and well apron (see Box 2.1)

### Box 2.1. Boreholes: water quality

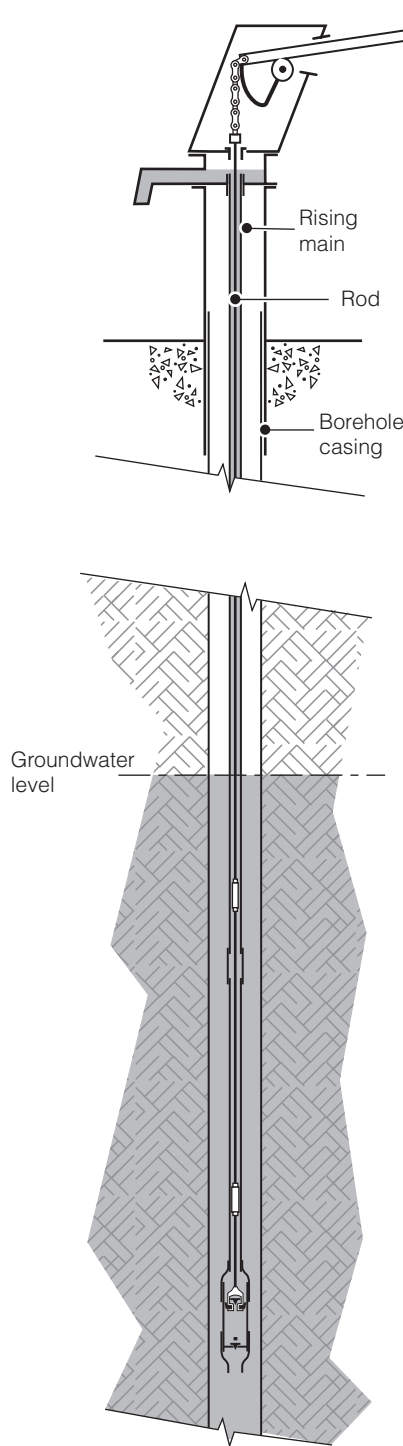
In general, groundwater contains no or low levels of harmful pathogens but it can be polluted with naturally occurring chemicals. Unfortunately, the quality of water drawn from handpumps fitted to boreholes is variable. Contamination can be caused by poor sanitary protection at the top of the borehole. The installation of a sanitary seal and a well apron can dramatically reduce contamination from the ground surface (Figure 2.2). Sources of further information about improving and upgrading boreholes are given on page 2.4.



## Cleaning and rehabilitating boreholes

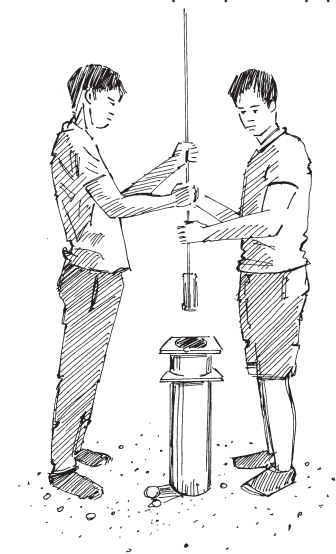


**Figure 2.3.**  
Direct action pump on a driven borehole



**Figure 2.4.**  
A deep-well pump on a drilled borehole

- In urban areas, check for possible contamination or pollution of the groundwater. Damaged septic tanks, leaks in industrial installations and fractured sewers may all be sources of contamination or pollution seeping into the ground. At the least suspicion of contamination or pollution, abandon the rehabilitation and seek specialist advice.
- Assess the type and extent of damage to the top of the well. This includes damage to the pump, its connection to the riser pipe and borehole casing, the sanitary seal and the well apron.
- Remove the handpump and riser pipe from the borehole (Figure 2.5). Check for damage or blockage with silt.
- Check the water level in the borehole. Ask the community what the water depth was before the disaster. Earthquakes, in particular, can cause a major change in groundwater levels. A significant lowering of the water level may require the riser pipe to be extended or, in the worst case, the abandonment of the borehole.
- Check for damage to the borehole casing and screen. Examine the pump riser pipe as



**Figure 2.5.** Removing the riser pipe

### Box 2.2. Jetting boreholes

The silt at the bottom of the well can often be dislodged by a strong jet of water. Set up a system similar to that shown in Figure 2.6. The water jet will suspend the silt in the water flow and carry it to the surface as the water fills the hole. Continue pumping until the water flowing out of the top of the well is clear. From time to time you may have to lower the hose further into the borehole so that it remains close to the silt layer.

it is extracted. If it is difficult to remove or has obvious signs of damage it is likely that the lining has been damaged. Borehole lining repair is difficult. For immediate improvement of the situation, stop the assessment and investigate alternative sources.

- Estimate the amount of silt and debris in the borehole. Examine the bottom of the pump riser pipe to see if it is covered in silt. A clean pipe indicates that any silt that may have entered the borehole is lying below the bottom of the riser pipe.
- Dismantle the pump and riser pipe to check for damage and worn parts.
- Estimate resources needed for repairs (personnel, equipment, time and materials).

## Step 2: Repair the borehole and handpump

1. Flush the sediment from the borehole. There are a number of ways of doing this but the simplest method is jetting (see Box 2.2, page 2.2). Other methods are possible but require specialist skills and equipment.
2. Check the top of the borehole casing for damage. If it is bent or twisted it will not be possible to install the pump correctly. You may have to cut away the damaged portion of the casing and weld a new piece into place.
3. Repair any damage to the pump and riser pipe. Take the opportunity to replace worn parts.
4. Re-assemble the pump and reinstall the borehole components. Check that



Figure 2.7. Checking the water for silt

the pump is working, the water produced is clear of silt (Figure 2.7) and the flow rate is acceptable. If the water still contains silt, remove the pump and flush out the borehole again. If, after two flushes, the borehole is still producing silty water, the borehole screen is probably damaged and no further attempt at repair should be made.

5. Repair the clay sanitary seal at the top of the borehole and the drainage apron around the borehole to prevent surface contamination of the groundwater (Figure 2.2, page 2.1).

## Step 3: Disinfect and recommission the borehole and handpump

Following rehabilitation, the borehole and all components must be disinfected to ensure a clean water supply. Operate the handpump for about an hour to remove any groundwater contamination caused by the disaster or the jetting process.

The most common method of disinfection is chlorination. The chlorine compound most commonly used is high-strength calcium hypochlorite (HSCH) in powder or granular form which contains 60 to 80% available chlorine. Sodium hypochlorite in liquid bleach form is also used but this only contains about 5% available chlorine. Box 2.3, page 2.4 outlines a method for disinfecting a borehole using HSCH.

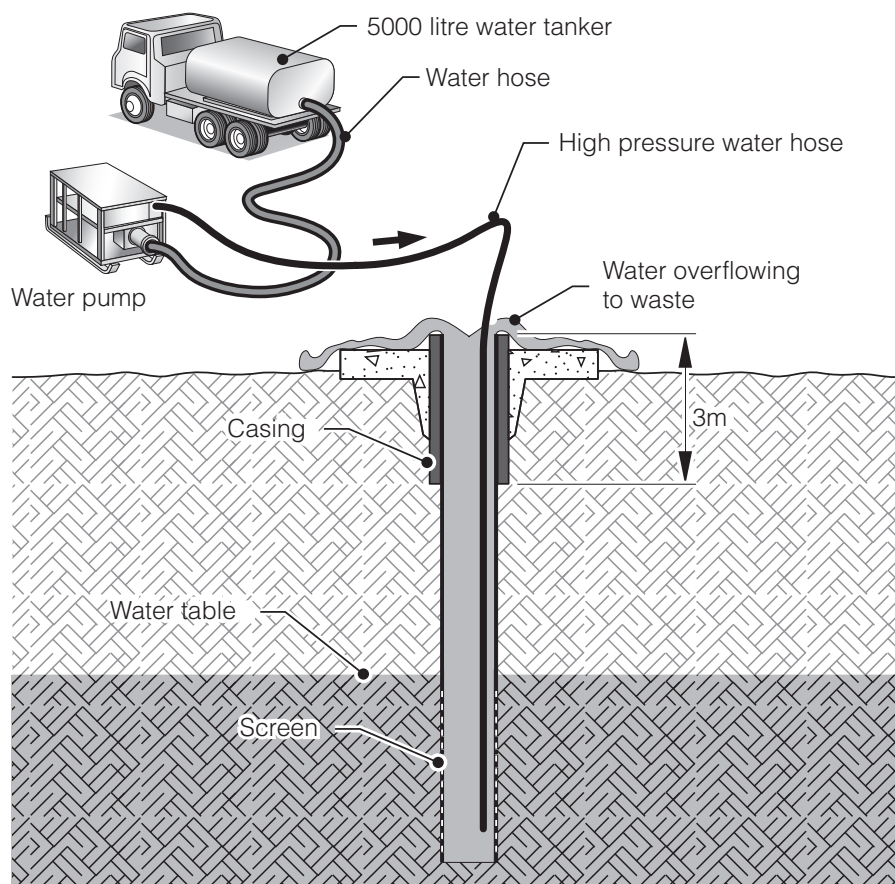


Figure 2.6. Flushing out a borehole by 'jetting'

Pour the chlorine liquid into the borehole (you may have to remove part of the pump to do this). Replace the pump and operate it until chlorine can be smelled in the outflow.

Allow the water to stand in the borehole for 12 to 24 hours and then operate the pump until all the chlorinated liquid has been removed. If you have a chlorine test kit you can check the chlorine concentration in the water.

Alternatively, pump the water until it no longer smells of chlorine. Technical Note 11 gives more details on testing for chlorine.

Disinfection will *not* provide residual protection and therefore measures to ensure safe collection, handling and storage at home are highly recommended. This may include use of household water treatment. Please see Note 5 for details.

**DANGER: HSCH and bleach give off chlorine gas which is a serious health hazard. Always add chlorine compounds to water rather than water to chlorine. Work in an area with a good flow of air to take away the chlorine fumes. Wear protective clothes, especially face and eye masks and gloves. Do not allow anyone to use the handpump during the cleaning process.**

## Box 2.3. Calculating the chlorine dosage for disinfecting a borehole using high-strength calcium hypochlorite (HSCH)

### Equipment

- 20 litre bucket
- HSCH chlorine granules or powder

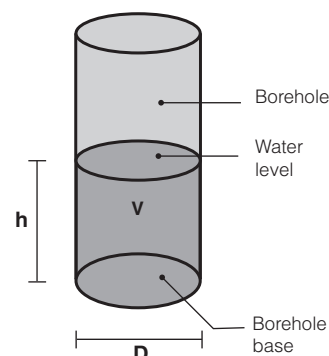
### Method

- Calculate the volume of water in the borehole using the formula:

$$V = \frac{\pi D^2 h}{4}$$

Where

- V = volume of water in the borehole (m<sup>3</sup>)
- D = diameter of the borehole (m)
- h = depth of water (m)
- π = 3.142



- Multiply the answer by 1000 to convert the answer to litres
- Divide the volume of water (in litres) in the borehole by the volume of the bucket to establish how many buckets of disinfectant will be needed to replace the total volume of the water in the borehole.
- Fill the bucket with clear water
- Add 1g of HSCH powder and stir until dissolved (0.5g for every 10 litres in the bucket)
- Pour the disinfectant into the borehole
- Make up sufficient buckets of disinfectant to replace the total volume of water in the borehole.

## Further information

- Godfrey, S. and Ball, P. (2003) 'Making Boreholes Work: Rehabilitation strategies from Angola', *29th WEDC Conference Proceedings*, WEDC, Loughborough, UK.
- Ball, P. (1999) *Drilled Wells*, SKAT Publications, Switzerland.
- EPA (2006) *Private Drinking Water Wells: What to do after the flood*, <http://water.epa.gov/drink/info/well/whatdo.cfm>
- Agriculture and Agri-food Canada (Undated) *Water Well Disinfection Using the Simple Chlorine Method*, Water Stewardship Information Series. British Columbia. [http://www.env.gov.bc.ca/wsd/plan\\_protect\\_sustain/groundwater/wells/factsheets/PFRA\\_simple\\_chlorification.pdf](http://www.env.gov.bc.ca/wsd/plan_protect_sustain/groundwater/wells/factsheets/PFRA_simple_chlorification.pdf)
- Skinner, B. H. (2003) *Small-scale Water Supply: A Review of Technologies*. Practical Action Publishing, Rugby, UK



**World Health Organization**

Water, Sanitation,  
Hygiene and Health Unit  
Avenue Appia 20  
1211 Geneva 27  
Switzerland

Telephone: + 41 22 791 2111  
Telephone (direct): + 41 22 791 3555/3590  
Fax (direct): + 41 22 791 4159  
URL: [www.who.int/water\\_sanitation\\_health](http://www.who.int/water_sanitation_health)

Prepared for WHO by WEDC. Authors: Sam Godfrey and Bob Reed. Series Editor: Bob Reed.

Editorial contributions, design and illustrations by Rod Shaw

Line illustrations courtesy of WEDC / IFRC. Additional graphics by Ken Chatterton.

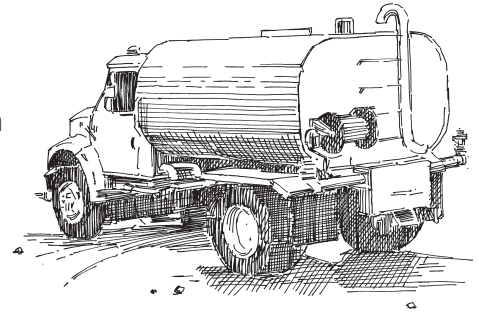
Water, Engineering and Development Centre Loughborough University Leicestershire LE11 3TU UK  
T: +44 1509 222885 F: +44 1509 211079 E: [wedc@lboro.ac.uk](mailto:wedc@lboro.ac.uk) W: <http://wedc.lboro.ac.uk>

**WEDC**



# Cleaning and disinfecting water storage tanks and tankers

In an emergency situation, it is often necessary to quickly provide a basic water supply for the affected population. This may be because the normal systems of supply have been damaged or destroyed. The most common, immediate solution is to hire vehicles and tanks that have been used for other purposes or to retrieve collapsible tanks from an emergency store. In either case, they must be cleaned and disinfected before being used. This technical note outlines a four-step approach to cleaning and disinfecting water tanks and tankers.



## Procedural steps

In the case of an emergency, it is an acceptable practice to disinfect tanks that are polluted or not in use so that drinking-water can be transported and stored safely. Figure 3.1 presents the four-step approach to cleaning and disinfecting water tanks.

**Note:** Large quantities of clean water will be required to clean and treat tanks before they can be used to transport or store water.

### Step 1: Select the tanks to use

Tanks should be selected based on three considerations: normal use; ease of cleaning and water storage hygiene.

Selected tanks should only have been used for holding food-grade liquids, for example, milk, cooking oils, fruit juices, wines and spirits or vinegar. Tanks previously used for holding non food-grade liquids such as fuel and sewage should *not* be used. Tanks that previously held water but have been out of use for

some time must also be cleaned and disinfected as described below under Steps 2 and 3.

Tanks must be easy to clean. This means they must be accessible for cleaning and have no sharp corners that may hold dirt and so prevent the removal of food deposits.

Water will only remain clean if stored safely. Tanks must therefore be covered and fitted with an access point with a lockable lid.

### Step 2: Cleaning

#### Empty the tank

Open the outlet valve or tap and drain out any remaining liquid. Collect the liquids so that they can be safely disposed of (see Step 4).

In the case of tankers, outlet valves are usually located at the back so parking it on a slope will help to ensure that all the liquid can be discharged (see Figure 3.2 overleaf).

Permanent storage tanks are usually fitted with a washout valve that draws liquid from the base. Use this, rather than the normal outlet valve, for emptying.

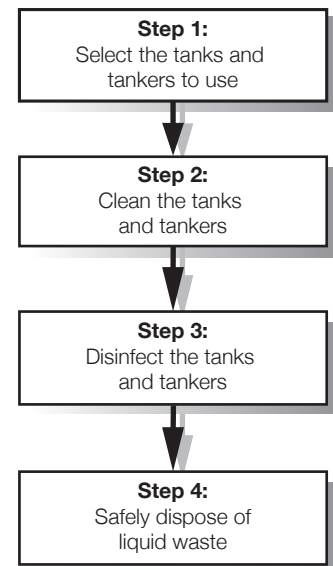
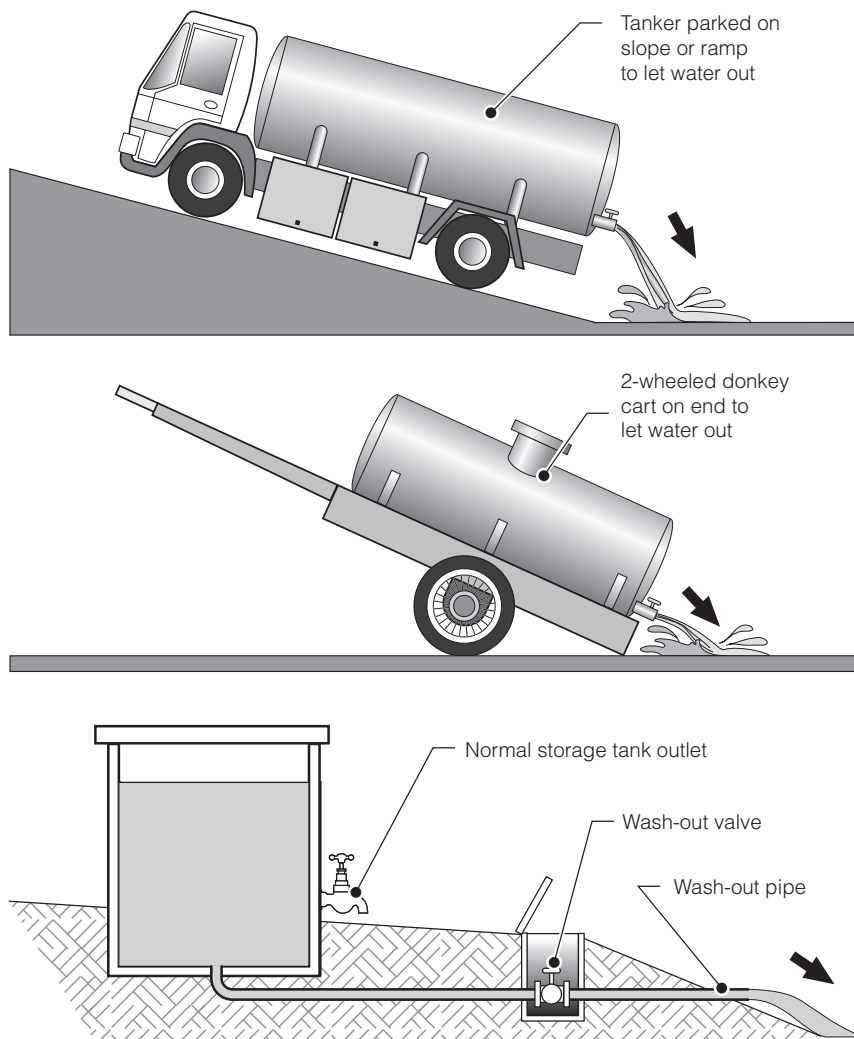


Figure 3.1. Steps for cleaning and disinfecting water tanks and tankers

### Scrub the internal surfaces of the tank

Use a mixture of detergent and hot water (household laundry soap powder will do) to scrub and clean all internal surfaces of the tank. This can be done with a stiff brush or a high pressure jet. Attaching the brush to a long pole may make it possible to clean the tank without entering it (Figure 3.3).





**Figure 3.2.**  
Discharging liquids from tanks and tankers

Take special care to clean corners and joints so that no small amounts of the original liquid remain. Even minute amounts of some liquids can give the water a bad taste and people will refuse to drink it. Leave the outlet valve open while cleaning and collect the liquid for safe disposal.

### Wash and flush the tank

This is most easily done with a high pressure hose pipe or water jet but if they are not available the tank can be filled with (preferably hot) water and left to stand for a few hours. Drain all the water from the tank and collect for safe disposal as before. Continue flushing the tank until there are no longer traces of detergent in the water.

#### Important note:

Tank cleaning should take place in open areas away from houses to avoid possible health problems resulting from the disposal of the wastewater.

### Clean hoses

The hoses, pumps and pipes used for filling and emptying the tank must also be cleaned. Flush a mixture of hot water and detergent through the pipes and pump to remove deposits and other waste material.

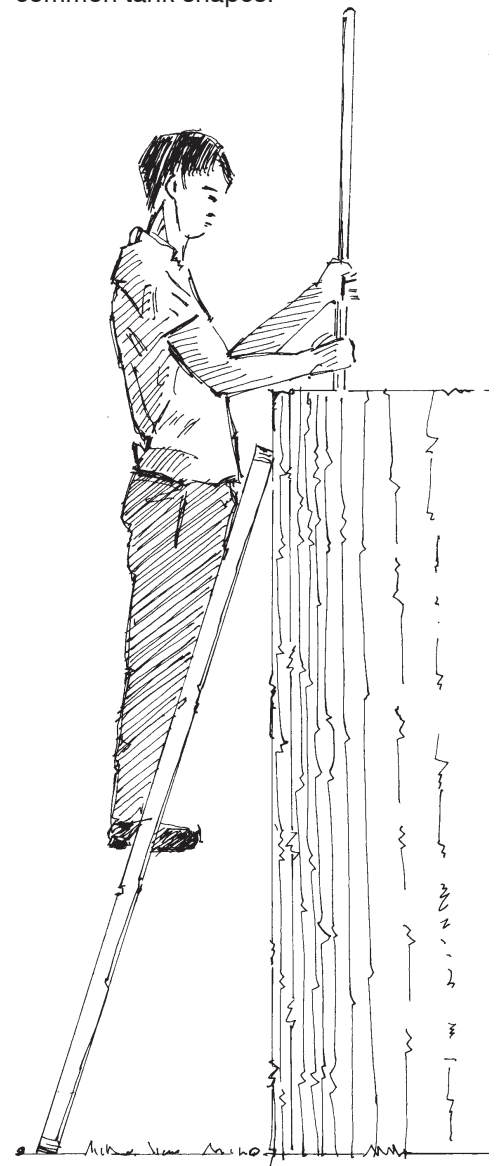
Once cleaned, flush the system with clean water to remove the detergent.

### Step 3: Disinfection

The most common way of disinfecting a water tank is by chlorination. Chlorine is delivered in a variety of ways but the most common is high-strength calcium hypochlorite (HSCH), which, when mixed with water, liberates 60 to 80% of its volume as chlorine.

### Calculate the volume of the tank

The amount of chlorine needed to disinfect the water tank will depend on its volume. Box 3.1 describes how to calculate the volume of common tank shapes.



**Figure 3.3.**  
Cleaning the inside of a tank with a brush

## Add the disinfectant

Fill the tank a quarter full with clean water. Sprinkle 80 grams of granular HSCH into the tank for every 1000 litres total capacity of the tank. Fill the tank completely with clean water, close the lid and leave to stand for 24 hours.

If the tank is required for use urgently, double the quantity of chlorine added to the tank. This will reduce the time of disinfection from 24 to 8 hours.

## Disinfecting the hoses and pump

If the tank is fitted with a pump, connect the hoses so that water is drawn from and returned to the tank (Figure 3.4).

With the tank full of water and disinfectant, start the pump so that the mixture passes through the hoses and pump. Run the pump for about an hour. Repeat this procedure with the tank full of clean water.

If no pump is fitted, use some of the disinfectant from the tank and gently fill the hoses to full capacity. You will have to block one end of the hose and fill it from the other end. Allow to stand for 24 hours.

Empty out the disinfectant and connect the hoses to the tank outlet so that when the clean water in the tank is discharged it passes through the hoses. The hoses are now ready for use.

## Prepare for use

Completely empty the tank and carefully dispose of the disinfecting water as it will contain a high concentration of chlorine. Fill the tank with drinking-water, allow to stand for about 30 minutes then empty the tank again. The tank is now ready for use.

**Figure 3.4.** (Right) Recirculating chlorinated water to disinfect the pump and hoses

### Box 3.1. Calculating the volume of a tank

Storage tanks are commonly one of three shapes, rectangular, cylindrical or oval. If the tank is another shape, approximate its volume by using the formula that most nearly fits the shape.

#### Rectangular ground storage tanks

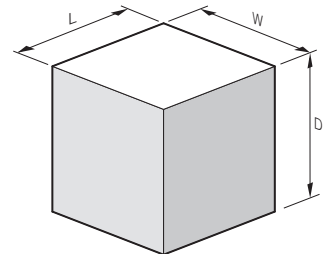
$$\text{Volume (litres)} = L \times W \times D \times 1000$$

Where

D = depth of the tank (m)

W = width of the tank (m)

L = length of the tank (m)



#### Cylindrical ground storage tanks

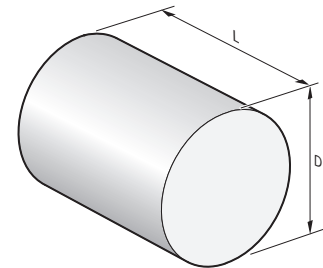
$$\text{Volume (litres)} = \frac{\pi D^2 L}{4} \times 1000$$

Where

D = diameter of the tank (m)

L = length of tank (m)

$\pi$  = 3.142



#### Oval water tankers

$$\text{Volume (litres)} = (\pi \times (D + W)^2 / 16) \times L \times 1000$$

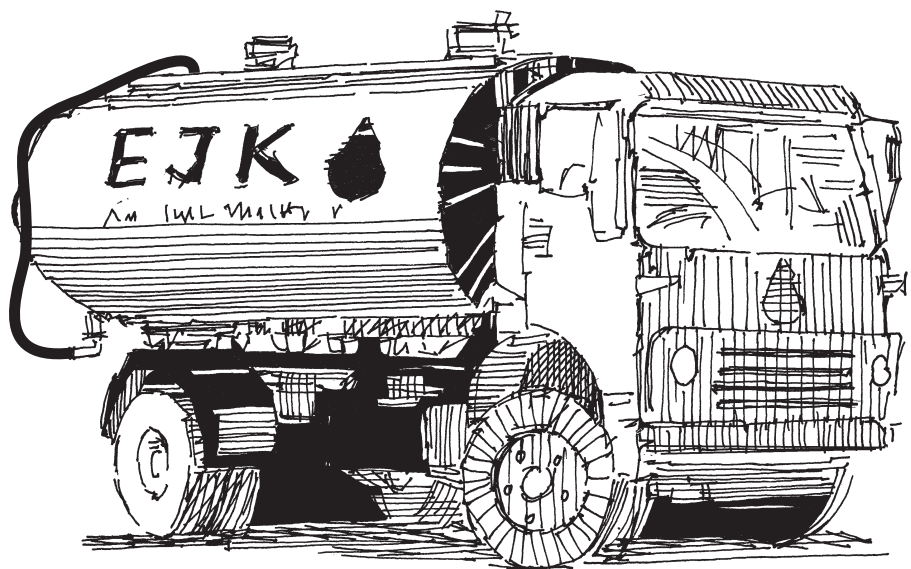
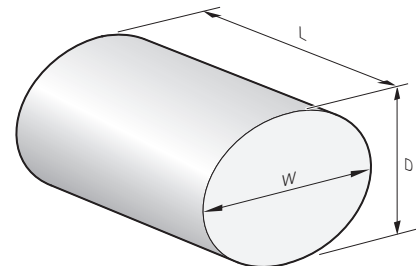
Where

D = depth of the tank (m)

W = width of the tank (m)

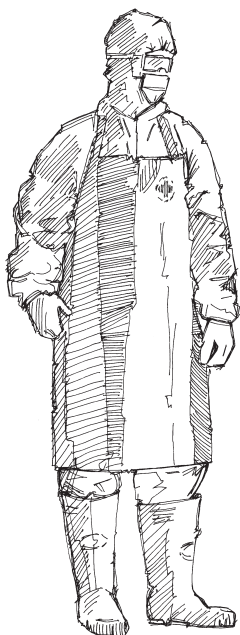
L = length of the tank (m)

$\pi$  = 3.142

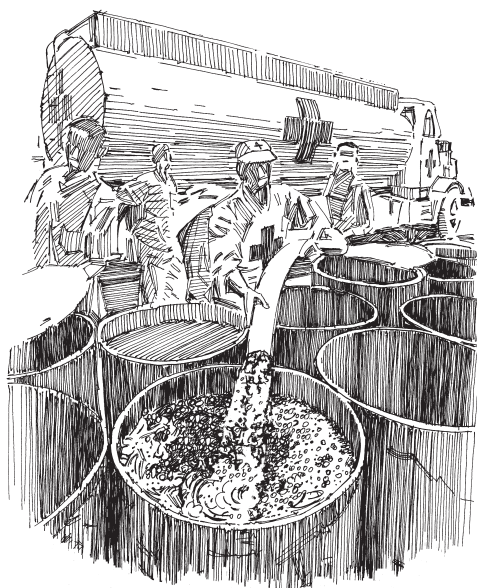


## Step 4: Safely dispose of liquid waste

Care must be taken when disposing of all liquids used for cleaning and disinfecting the tanks. Sudden discharge of water will cause localized erosion or flooding. Make sure the water follows a channel to its final disposal point.



**Figure 3.5.**  
Wearing protective clothing for cleaning



**Figure 3.6.**  
Delivering safe water from a water tanker

Liquid waste should not be disposed of in rivers and ponds as the organic materials and high chlorine levels may kill fish and plant life. Wastewater should be disposed of to a sewer network, carried in tankers to a sewage treatment plant or placed in a septic tank that overflows into an underground soakage system.

### Box 3.2. Additional health and safety issues

Gaining access and working inside a water tank can be difficult and dangerous. There is often only a small access hatch on the top of the tanker through which to climb in and out. Cleaners should be aware that some liquid held in tanks can give off hazardous gases which may remain even when the liquid has been removed. The liquids may also pose physical hazards such as slippery surfaces. Corrosive liquids can cause burns.

Always blow fresh air into the tank for a period before allowing a person to enter. The cleaner should wear protective clothing, including gloves, boots, a hat and glasses (Figure 3.5). Make sure someone remains outside the tank, next to the access hatch all the time in case the cleaner has an accident. The availability of gas masks and portable ventilators would be an advantage.

## Further information

Davis, J. and Lambert, R. (2002) *Engineering and Emergencies: A practical guide to fieldworkers*, 2nd Edition, Practical Action Publishing, UK.

Massachusetts Department of Environmental Protection (Undated) *Procedures for Emergency Tank Truck Bulk Water Haulage*. <http://www.mass.gov/dep/water/drinking/blkwfct.doc>

Louisiana Department of Health and Hospitals (Undated) *Instructions for Emergency Tank Truck Bulk Water Hauling in Louisiana*. <http://www.dhh.louisiana.gov/offices/publications/pubs-204/Bulk%20Water%20Hauling%20Instructions.pdf>



**World Health Organization**

Water, Sanitation,  
Hygiene and Health Unit  
Avenue Appia 20  
1211 Geneva 27  
Switzerland

Telephone: + 41 22 791 2111  
Telephone (direct): + 41 22 791 3555/3590  
Fax (direct): + 41 22 791 4159  
URL: [www.who.int/water\\_sanitation\\_health](http://www.who.int/water_sanitation_health)

Prepared for WHO by WEDC. Authors: Sam Godfrey and Bob Reed. Series Editor: Bob Reed.

Editorial contributions, design and illustrations by Rod Shaw

Line illustrations courtesy of WEDC / IFRC. Additional graphics by Ken Chatterton.

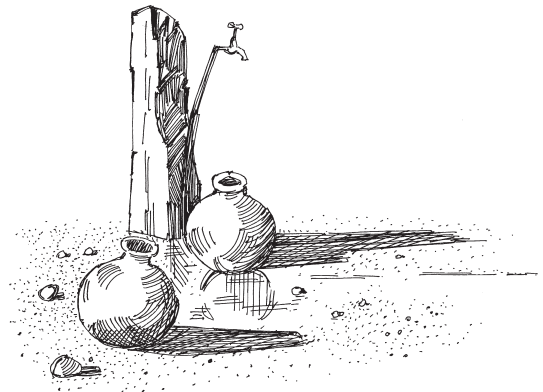
Water, Engineering and Development Centre Loughborough University Leicestershire LE11 3TU UK  
T: +44 1509 222885 F: +44 1509 211079 E: [wedc@lboro.ac.uk](mailto:wedc@lboro.ac.uk) W: <http://wedc.lboro.ac.uk>

**WEDC**



# Rehabilitating small-scale piped water distribution systems

The damage caused by natural disasters to networks for piped drinking-water distribution can be widespread and extensive. It can range from minor breaks to complete loss of whole sections of the system. A systematic survey of the entire network is the only way of identifying the true extent of the damage. This may not be possible in an emergency where the priority is to re-instate a basic level of supply. This technical note examines these priorities and the process of rehabilitating small-scale piped water distribution systems.



## Steps of rehabilitation

The first priority is to repair major breakages in the system. This will allow the re-instatement of a supply but with the knowledge that much of the water entering the network will be lost through breaks not yet fixed. Once the emergency supply is in place, work can begin to identify and repair smaller breaks. Figure 4.1 shows the steps for repairing major breaks in pipe networks.

### Step 1: Assess the extent of the damage

Identify local staff with knowledge of the distribution system as their involvement in the rehabilitation will make the job much easier. Obtain any available drawings of the distribution network layout, including information about the size of pipes and positions of fittings such as valves and washouts. At the very least, obtain a plan of the community showing main roads and important buildings. For many parts of the world, suitable maps can be freely downloaded from the Internet. Inspect the whole of the piped network and mark on the plans the positions of all major damage, its nature (for instance whether it is a broken valve, a fractured pipe, a lost pipe section) as well as the type

of pipe affected (see Figure 4.3). Focus on visible damage. It is likely that there will be damage underground but this can be dealt with later. Check the local stores to see if there are enough spare pipes and fittings of the correct size, and materials and equipment to begin the repairs. If not, order these immediately.

### Step 2: Keep consumers informed

It is important to keep water users informed about what is happening and how you propose to deal with the situation (Figure 4.2). Let them know which sections of the network are affected, what you intend to do and when, and what they should do to protect their health and safety. Communication is an on-going responsibility and regular updates should be provided.



Figure 4.2. Keep the consumers informed

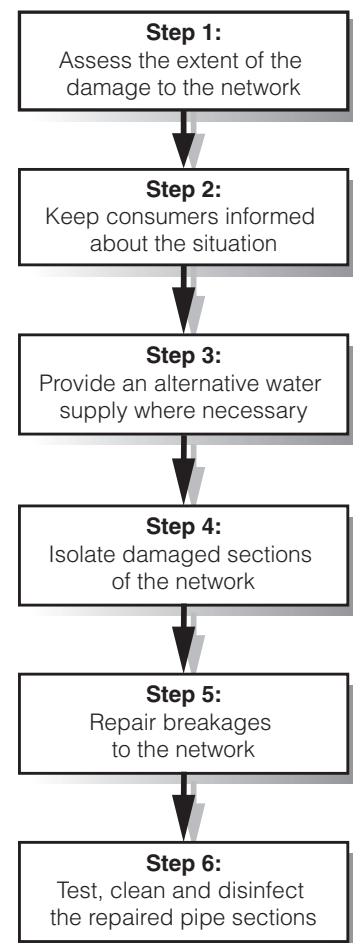
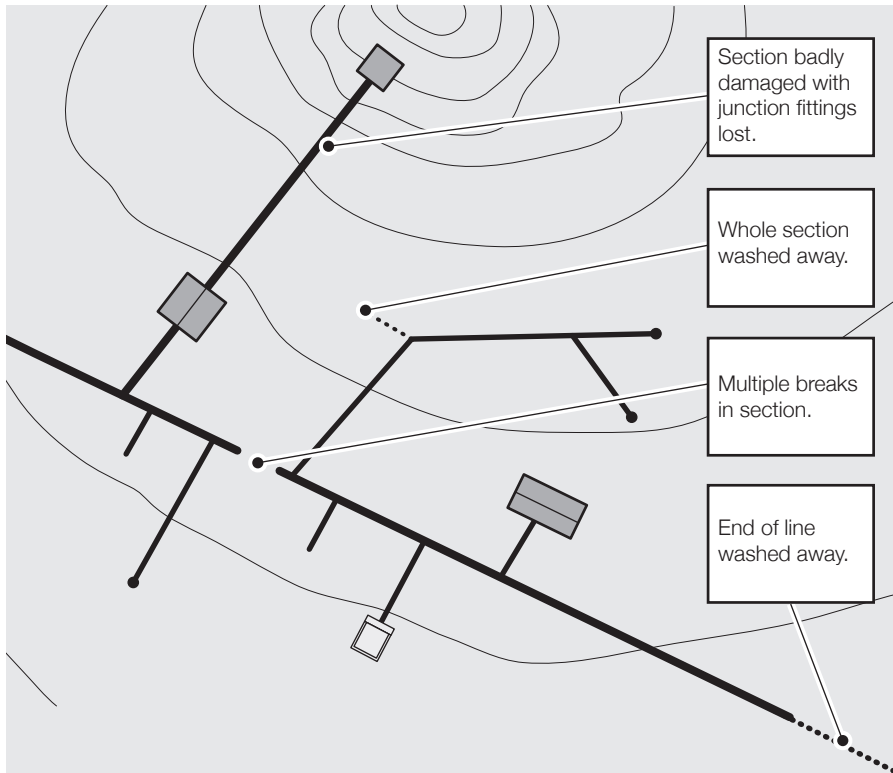


Figure 4.1. Steps for rehabilitating a small-scale piped water distribution system



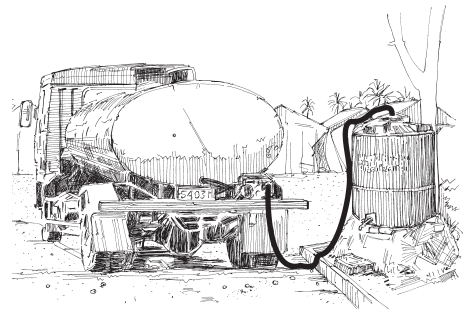
# Rehabilitating small-scale piped water distribution systems



**Figure 4.3.**  
Map of a piped distribution network with a record of damage

## Step 3: Provide an alternative water supply

If damage to the network is major, and repairs will take more than a few hours, an alternative supply must be provided. This could take the form of bottled drinking water, water delivered directly by tanker (Figure 4.5), and water tankers delivering to temporary storage tanks. Combine this with advice about local sources of water (such as springs or wells) which might be used for other, non-drinking purposes.



**Figure 4.5.**  
Provide an alternative water supply

Provide information about simple household water treatment options and the availability of chemicals to disinfect local sources.

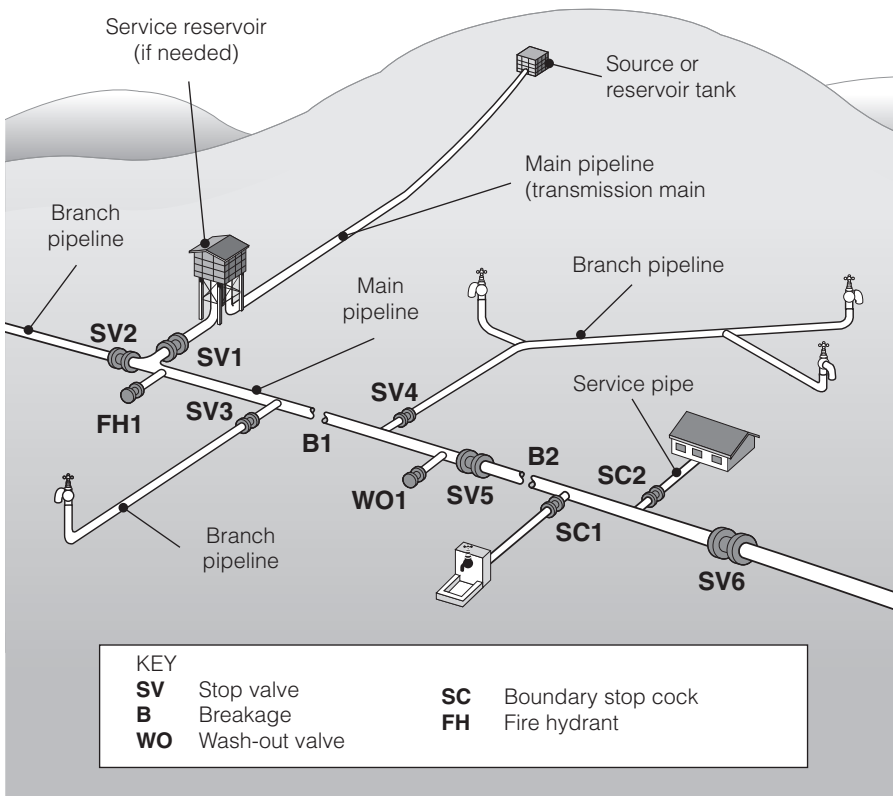
In all cases, water users must be informed about what is being done and how they can use the temporary system effectively.

## Step 4: Isolate damaged sections of the network

The affected area or areas should be isolated from the rest of the distribution network. This will reduce water wastage and allow a supply to continue to unaffected areas. Isolation is usually undertaken using control valves. If they are not available, or cannot be traced, new valves will have to be installed.

## Step 5: Repair breakages

Start at, or near, a source of supply and work outwards into the distribution system. Repair the pipeline in a stepped manner. For example, referring to Figure 4.4,



**Figure 4.4.**  
Repair the pipeline in a planned and stepped manner

start with the section between the source and the service reservoir.

Follow this repair by rehabilitating the main pipeline from SV1 to SV5, making sure to close valves SV2, 3 and 4 and any service connections first. Select a pipeline section that can be easily isolated by existing stop valves, of say 500 to 1000m apart.

Arrange to install washout valves (such as WO1), and fire hydrants (such as FH1) if none can be traced in the selected section.

Before starting any repair work:

- Locate other underground utilities at work in the area, and liaise with their maintenance departments, if necessary.
- Route traffic away from the work area.

Excavate and expose the broken sections of the pipelines. Protect the repair crew from trench collapse. This is normally not a problem with small diameter pipes but if the ground is very loose protect them by shoring the work area as illustrated in Figure 4.6.

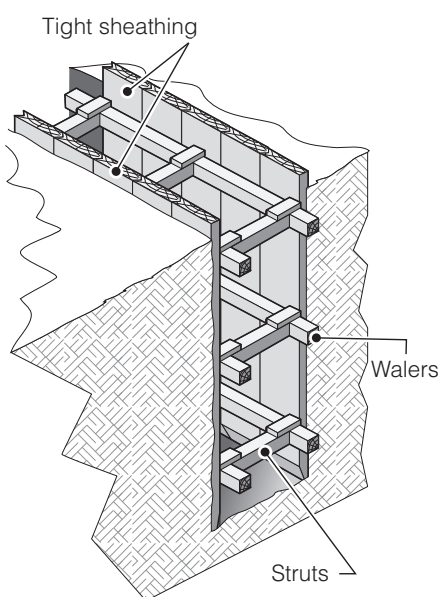


Figure 4.6. Shoring the work area

Use simple methods of repair that will take the shortest time to restore services.

Examples of simple methods:

- The damaged section may be replaced by use of repair pipe clamps, as shown in Figure 4.7.
- Repair of cracks and breaks in steel pipes by welding.
- If there are multiple breaks, it may be quicker and easier to replace the whole section with a new pipe. A temporary pipe run above ground is satisfactory for an emergency supply.

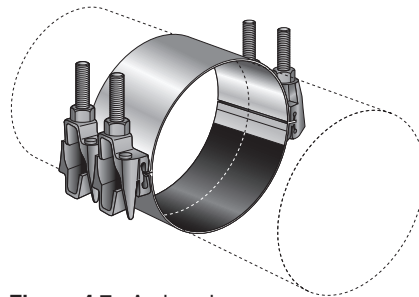


Figure 4.7. A pipe clamp

Replace pipe support structures such as concrete anchorage and thrust blocks, if necessary.

Backfill around the pipe with selected material such as dry sand or washed stone (Figure 4.8). The remainder of the excavation can be filled with the excavated soil. Leave the pipe joints exposed so that they can be observed during water pressure testing.



Figure 4.8. Backfilling

## Step 6: Test, clean and disinfect the repaired pipe sections

### Pipe testing

Partly open the upstream isolation valve and the downstream washout to fill the repaired pipeline section with water.

Once full, increase the pressure in the pipe by at least 50%. This is achieved by:

- closing the upstream valve and downstream washout;
- connecting a water pump between a water tanker and the upstream fire hydrant; and
- switching on the water pump and maintaining the high pressure for at least 4 hours.

Observe the pipe joints for leaks and repair if necessary. Check the amount of water being pumped from the tanker into the pipeline and compare with the figures given in Table 4.1. If the leakage is greater than recommended, it indicates other major leaks in the section. Sources of further information about ways of searching for hidden leaks are provided on page 4.4.

### Cleaning

Connect a full tanker of clean water, via a water pump, to the upstream fire hydrant or washout for the section of pipe you are working on. Confirm the pump can deliver the quantity of water and pressure required to flush and clean the pipe.

Table 4.1. Allowable leakage from pipes

Pipe diameter (mm)	Normal allowable leakage (litres/day/1000m)	Emergency allowable leakage (litres/day/1000m)
50	165	330
75	250	500
100	330	660
150	500	1000

Source: California State University (1994)

# ▶ Rehabilitating small-scale piped water distribution systems

Table 4.2 gives guidelines for adequate velocities and flow.

Open the hydrant connected to the pump and tanker. Turn on the pump. Gradually open the downstream washout valve until the flow rate reaches the required level. Pump until the water coming out of the washout is completely clean but not less than the time suggested in Table 4.2.

Direct flushing water away from traffic, pedestrians and private plots. Avoid erosion damage to streets, lawns and yards by use of tarpaulins and lead-off discharge devices. Avoid flooding which can cause traffic congestion. When the water coming out of the pipe is clean, slowly close the washout valve before turning off the water pump.

## Disinfection

Calculate the volume of water required to fill the section of pipe using Table 4.3. Acquire tankers of volume equal to, or higher than, the calculated volume of the pipe. As the tankers are being filled with clean water add 80g of High Strength Calcium Hypochlorite (HSCH) granules for every 1000

**Table 4.2.** Velocity and flow required for flushing

Pipe diameter (mm)	Velocity required (m/s)	Flow required (litres/sec)	Minimum flushing time for a 1000m pipe (mins)
50	1.3	2.7	770
75	1.6	7.2	625
100	1.8	15.0	555
150	2.2	41.0	455

Source: Adapted from Institution of Water Engineers and Scientists (1984)

litres. (See Technical Note 3 for further information about the chlorination of tankers.)

Connect the water tanker to the upstream fire hydrant. Open the valves between the tanker and the pipe. Gradually open the down stream washout so that the chlorinated water replaces the clean water in the pipe (it may be necessary to pump water into the pipe).

Continue feeding water into the pipeline until chlorine can be strongly smelt in the water coming out of the washout. Close the washout valve but leave the inlet valves open so that chlorinated water can still enter to replace leakage. Leave the pipeline for 24 hours.

Disconnect the water tanker and open the upstream isolating valve.

Gradually open the downstream washout and monitor the water coming out until it no longer smells strongly of chlorine.

The pipe can then be returned to service.

**Table 4.3.** Quantity of water required to fill pipes of different diameters

Pipe diameter (mm)	Approximate water volume per 1000m of pipe (litres)
50	1,960
75	4,420
100	7,850
150	17,670

## Further information

California State University, Sacramento School of Engineering (1994), *Water Distribution System Operation and Maintenance*, 3rd ed., California State University, Sacramento Foundation, USA.

Bhardwaj V (Undated) Technical Brief – *Repairing Line Breaks*. National Drinking Water Clearing House. [http://www.nesc.wvu.edu/ndwc/articles/OT/SP04/TechBrief\\_LineBreaks.pdf](http://www.nesc.wvu.edu/ndwc/articles/OT/SP04/TechBrief_LineBreaks.pdf)

AWWA (1999) *Water Distribution Operator Training Manual*. American Water Works Association, 2nd ed. Denver, Colorado. USA

Male, J. Walski, T.M. (1991) *Water Distribution Systems: A Troubleshooting Manual*. 2nd ed. Chelsea, MI Lewis Publishers, Inc, USA

IWES (1982) *Water Practice Manual 3: Water Supply and Sanitation in Developing Countries*, IWES London



**World Health Organization**

Water, Sanitation, Hygiene and Health Unit  
Avenue Appia 20  
1211 Geneva 27  
Switzerland

Telephone: + 41 22 791 2111  
Telephone (direct): + 41 22 791 3555/3590  
Fax (direct): + 41 22 791 4159  
URL: [www.who.int/water\\_sanitation\\_health](http://www.who.int/water_sanitation_health)

Prepared for WHO by WEDC. Authors: Sam Kayaga and Bob Reed. Series Editor: Bob Reed.

Editorial contributions, design and illustrations by Rod Shaw

Line illustrations courtesy of WEDC / IFRC. Additional graphics by Ken Chatterton.

Water, Engineering and Development Centre Loughborough University Leicestershire LE11 3TU UK  
T: +44 1509 222885 F: +44 1509 211079 E: [wedc@lboro.ac.uk](mailto:wedc@lboro.ac.uk) W: <http://wedc.lboro.ac.uk>





# Emergency treatment of drinking-water at the point of use

Normally, drinking water supplies need to be treated during and after an emergency to make them safe and acceptable to the user. Treatment at the point of use is generally quicker and less expensive to implement than a centralized system, but it can be more difficult to manage. Only water used for drinking and preparing food needs to be treated. Nevertheless, this still amounts to about five litres per person per day. This technical note describes some of the most common and simple treatment options suitable for use during an emergency.



## Pre-treatment

There are a wide variety of technologies for treating water at the point of use. The methods described below will remove physical and microbiological pollution, but not chemical contamination.

Water treatment can make drinking-water that is unsafe at the source or drinking-water that becomes contaminated during handling and storage safer. There are a number of different methods and the preferred method or combination of methods depends on a number of factors such as source water quality, including turbidity or number of suspended particles in the water, availability of different methods and supply chains, user preferences and cost.

## Aeration

Aeration brings water into close contact with air which increases the oxygen content of the water.

This will:

- remove volatile substances such as hydrogen sulphide and methane which affect taste and odour;
- reduce the carbon dioxide content of the water; and

- oxidize dissolved minerals such as iron and manganese so that they can be removed by sedimentation and filtration.

Water can be aerated in a number of ways. One simple method for householders is to rapidly shake a container part-full of water for about five minutes (Figure 5.1), leave it standing for a further 30 minutes to allow any suspended particles to settle.

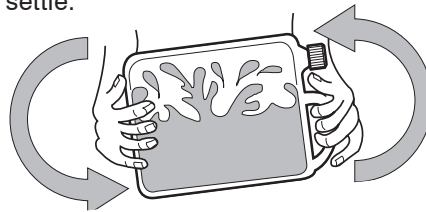


Figure 5.1.  
Aeration by vigorously shaking water

## Storage and settlement

If water is turbid it can be allowed to 'stand and settle' to remove larger particles. However, even after settling, water should be treated with a proven method to ensure it is safe to drink. Additionally, the suspended solids and some of the pathogens will settle to the bottom of the container, removing further risk. Storage for two days reduces contamination further still, and also

reduces the number of organisms which act as intermediate hosts for diseases such as Guinea worm infection (dracunculiasis).

## Filtration

A filter removes contamination by physically blocking particles while letting the water pass through.

### Membrane filters

Membrane filters operate using similar removal mechanisms as other filters and can be highly efficacious in removing even smaller organisms such as viruses. The manufacturer's instructions on use should be adhered to as often such filters require regular cleaning.

### Sand filters

Household filters may be assembled inside clay, metal or plastic containers. The vessels are filled with layers of sand and gravel and pipework arranged to force the water to flow upwards or downwards through the filter. Figure 5.4 shows a simple upward rapid flow filter.

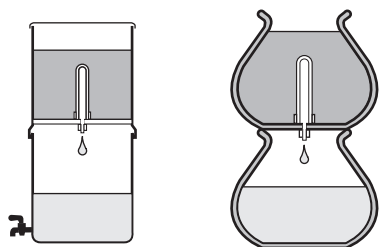
### Ceramic filters

Water passes slowly through a ceramic or 'candle' filter (Figure 5.3). In this process, suspended particles are mechanically filtered from the water. Some filters, for

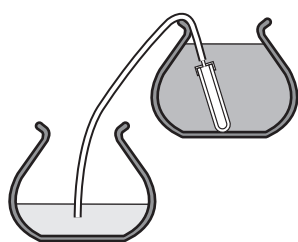


example, are impregnated with silver which acts as a disinfectant and kills bacteria, removing the need for boiling the water after filtration.

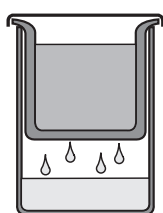
Ceramic filters can be manufactured locally, but are also mass-produced. They have a long storage life so can be stored in preparation for future emergencies.



(a) Manufactured unit (b) Candle with jars



(c) Using candle with siphon



(d) Porous jar

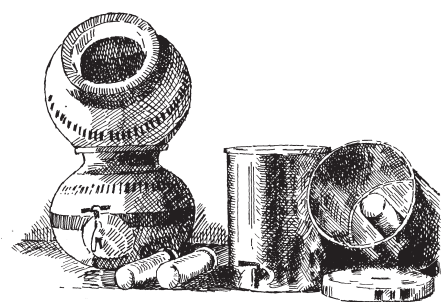


Figure 5.3. Ceramic or 'candle' filters

Impurities retained by the surface of the candle need to be brushed off under running water at regular intervals.

## Disinfection

Disinfection destroys all harmful organisms present in the water, making it safe to drink.

## Boiling

Boiling is a very effective method of disinfecting water, but it is energy consuming. The water should be brought to a 'rolling' boil. Apart from the high cost of the energy involved in boiling, the other disadvantage is the change in taste of the water. This can be improved by aeration, by vigorously shaking the water in a sealed container after it has cooled.

## Chemical disinfection

Many chemicals can disinfect water but the most commonly-used is chlorine. With appropriate dosing, chlorine will kill most viruses and bacteria, but some species of protozoa (notably *cryptosporidium*) are resistant to chlorine. There are several different sources of chlorine for home use; in liquid, powder and tablet form. They vary in size and strength (i.e. in how much chlorine they contain) so different quantities are required depending on the formulation. Always follow the manufacturer's instructions for use. To prevent misuse, clear instructions must be given to all users (see Figure 5.5).

**Chlorine compounds should not be given out to users outside of the container they are supplied in by the manufacturer. People cannot tell how much of the product to use or how to use it simply by looking at it!**

## Solar disinfection (SODIS)

Ultra-violet rays from the sun will destroy harmful organisms present in the water.

Fill transparent one- or two-litre plastic containers with clear water

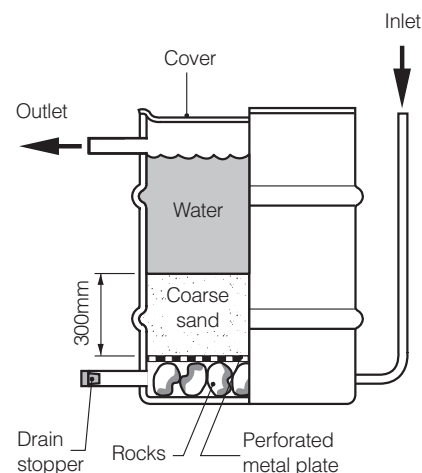


Figure 5.4. A simple upward, rapid flow filter

and expose them to direct sunlight. The length of time needed for inactivation of pathogens will vary depending on the transparency of the container, intensity of sunlight, and clarity of the water. In areas near the equator, on a sunny day 24 hours is likely sufficient or 48 hours for a cloudy day. Devices are now available which can be attached to the bottles to indicate when sufficient temperatures have been reached for inactivation. (Figure 5.6),

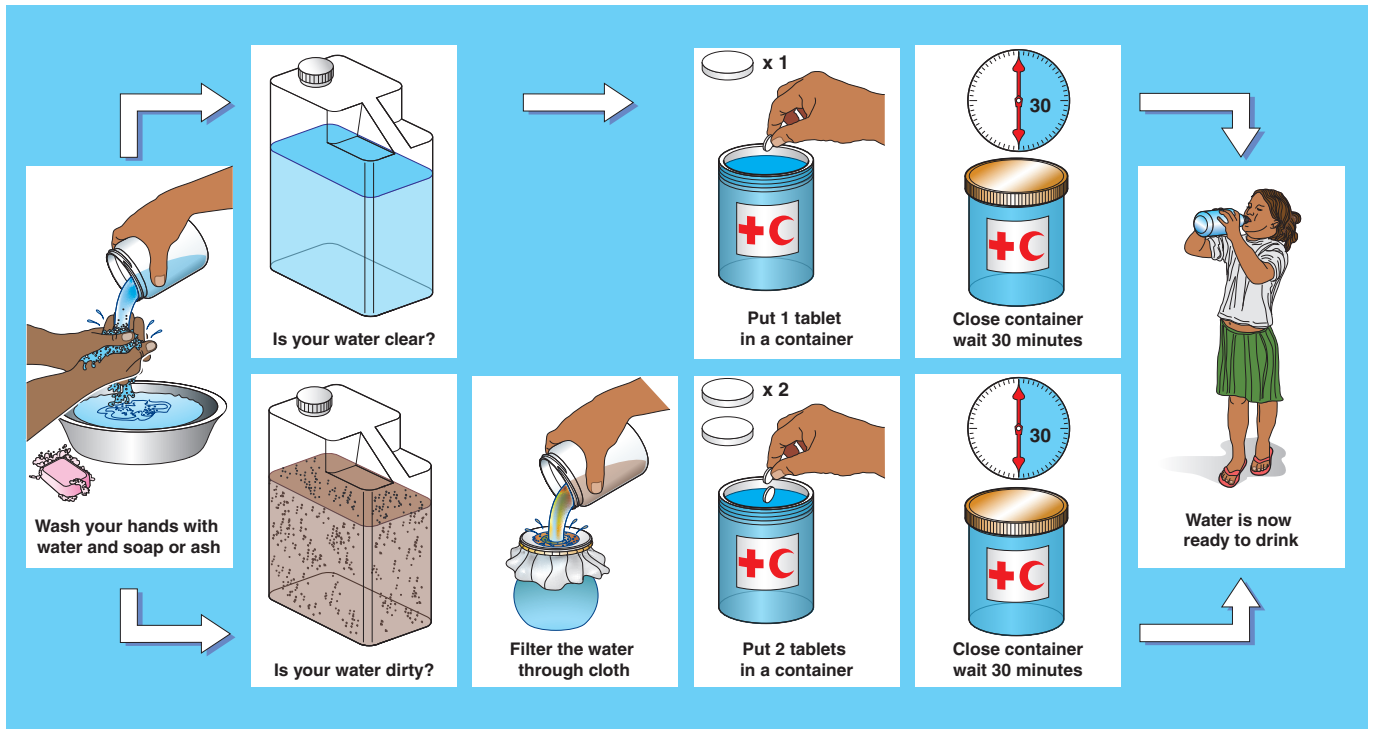
Cool the water and shake vigorously before use.

## Combined treatment systems

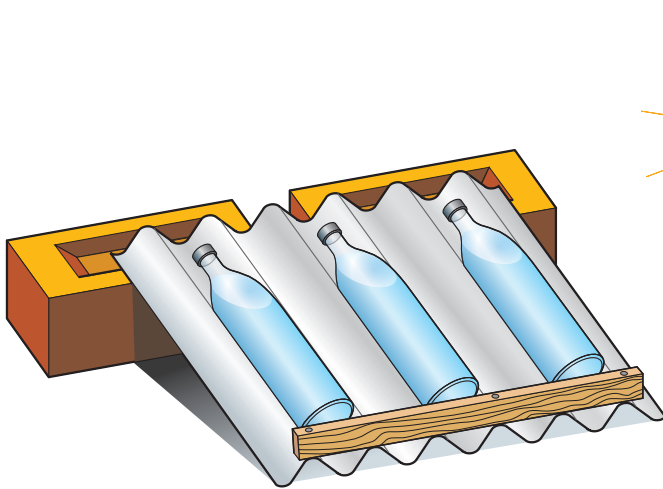
A few large companies have developed compounds that both remove suspended particles and disinfect the water. One such compound contains a chemical that helps suspended particles join to make larger, heavier ones that will settle to the bottom of the container. It also contains chlorine that disinfects the water after settlement has occurred.

## Training on use of technology

Successful emergency programs provide an effective treatment method with which the affected population is already familiar, and adequately invest in developing culturally appropriate materials and approaches to support correct use of the selected method(s).



**Figure 5.5.** How to treat water with chlorine tablets (adapted from IFRC, Geneva) \* The required number of chlorine tablets depends on size of container and % of active chlorine in tablets. Before dosing consult with manufacturer's instructions.



**Figure 5.6.** Solar disinfection (SODIS)



**Figure 5.7.** Tap fitted to a water bucket

## Looking after clean water

There is no point in treating water if it becomes contaminated again afterwards. The storage and use of treated water is just as important as the treatment process.

### Water storage

Water should be stored in clean, covered containers and kept in a cool dark place. Wide-necked containers such as a bucket fitted with a tight fitting lid are the best as they are easy to clean between uses.

Contamination can also occur as the water is taken out of the storage container. Hands and utensils may come into contact with the water so it is important to encourage users to wash their hands with soap before handling drinking water; and to fit a tap to the storage container so that water can be poured directly into a cup or bowl (Figure 5.7).

### Hygiene promotion

The benefit of providing safe drinking-water will be lost if users do not know *how* they will benefit.

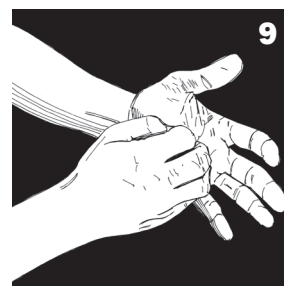
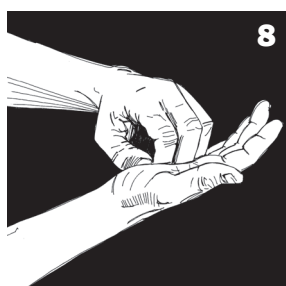
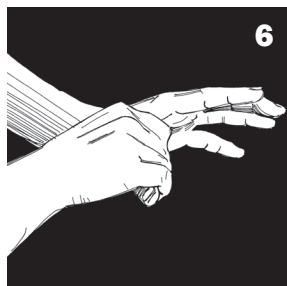
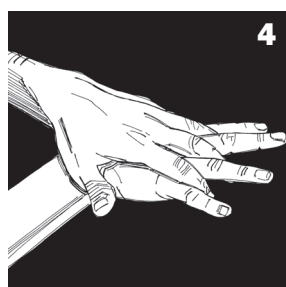
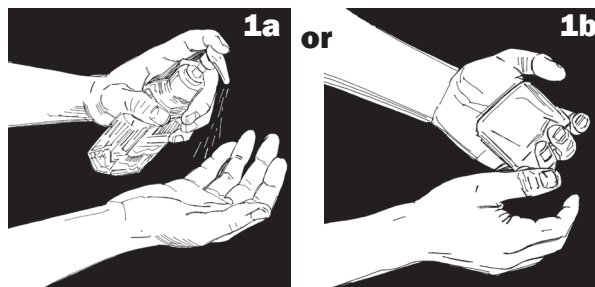
Changing unhygienic behaviour is just as important as the provision of clean water. Emergencies can provide a good opportunity to introduce new hygienic practices. As users settle into a new environment, they are more likely to accept changes to their normal behaviour. For water supply and sanitation, the most important practice to change relates to handwashing. Don't assume everyone knows how to wash their hands properly. Show them.

## Emergency treatment of drinking-water at the point of use

### Box 5.1. Handwashing

Everyone should wash their hands with soap and water:

- 1) after defecation;
- 2) before preparing food;
- 3) before eating food, breastfeeding or feeding children; and
- 4) after cleaning a child's feces.



### Further information

CEHA (2004) *Guide to the promotion of drinking-water disinfection in emergencies* [http://www.emro.who.int/ceha/pdf/DrinkingWater\\_Disinfection\\_En.pdf](http://www.emro.who.int/ceha/pdf/DrinkingWater_Disinfection_En.pdf)  
Centers for Disease Control and Prevention. Fact sheets on HWTS methods. <http://www.cdc.gov/safewater/household-water.html>  
IFRC (2008) *Household water treatment and safe storage in emergencies* <http://www.ifrc.org/Docs/pubs/disasters/resources/responding-disasters/142100-hwt-en.pdf>  
Shaw, Rod (ed.) (1999) *Running Water: More technical briefs on health, water and sanitation*, ITDG, UK.

Smet, J. & Wijk, C. van (eds) (2002) *Small community water supplies* Chapter 19. Disinfection, IRC Technical Paper 40, IRC: Delft [http://www.irc.nl/content/download/128541/351015/file/TP40\\_19%20Disinfection.pdf](http://www.irc.nl/content/download/128541/351015/file/TP40_19%20Disinfection.pdf)  
SODIS (Undated) *How do I use SODIS?* <http://www.sodis.ch/Text2002/T-Howdoesitwork.htm>  
United States Agency for International Development. Environmental health topics: Household water treatment. [http://www.ehproject.org/eh/eh\\_topics.html](http://www.ehproject.org/eh/eh_topics.html)  
WHO/UNICEF International Network on Household Water Treatment and Safe Storage. [http://www.who.int/household\\_water/resources/en/](http://www.who.int/household_water/resources/en/)



**World Health Organization**

Water, Sanitation,  
Hygiene and Health Unit  
Avenue Appia 20  
1211 Geneva 27  
Switzerland

Telephone: + 41 22 791 2111  
Telephone (direct): + 41 22 791 3555/3590  
Fax (direct): + 41 22 791 4159  
URL: [www.who.int/water\\_sanitation\\_health](http://www.who.int/water_sanitation_health)

Prepared for WHO by WEDC. Authors: Sam Kayaga and Bob Reed. Series Editor: Bob Reed.  
Editorial contributions, design and illustrations by Rod Shaw  
Line illustrations courtesy of WEDC / IFRC. Additional graphics by Ken Chatterton.

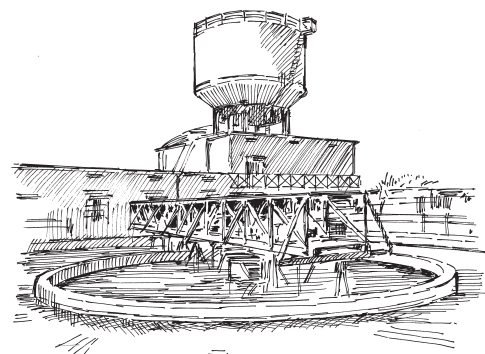
Water, Engineering and Development Centre Loughborough University Leicestershire LE11 3TU UK  
T: +44 1509 222885 F: +44 1509 211079 E: [wedc@lboro.ac.uk](mailto:wedc@lboro.ac.uk) W: <http://wedc.lboro.ac.uk>

**WEDC**



# Rehabilitating water treatment works after an emergency

In urban areas, the population may be entirely reliant on the public water supply system for their drinking-water. Modern water treatment works rely on the inputs of skilled operators as well as supplies of chemicals, electricity and machinery. A disaster can cause extensive damage to the works leading to a reduced or even a total loss of output. This technical note identifies the first steps to take towards rehabilitating a water treatment works after an emergency. Details of the rehabilitation of smaller systems are given in Technical Note 4.



## Steps for rehabilitation

In an emergency, the primary goal of rehabilitating a water treatment works is to maximize the quantity of water produced. This is followed by the gradual, step-by-step improvement in water quality. Most water treatment works are connected to a piped distribution system. This, too, needs to be rehabilitated if the treated water is to reach the consumer. Details of the rehabilitation of distribution systems are given in Technical Note 4.

## Assess the situation

### Identify key workers

Identify local water treatment operators who understand the system. They can provide knowledge of the works and the sources of supply. Often, however, operators do not fully understand the treatment process, so try to identify professional engineers, scientists and managers who do. Note that you may have to pay operators and managers if the emergency has interrupted their salary payments.

### Understand the process

In order to rehabilitate the water treatment plant it is important to

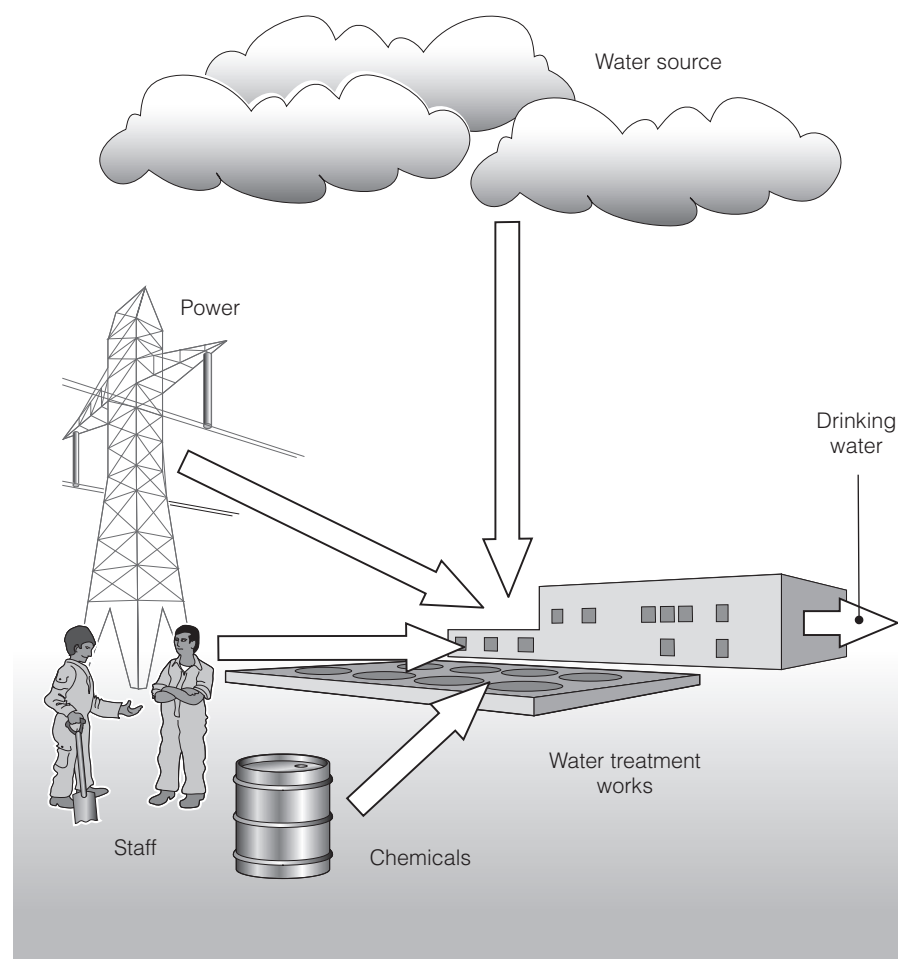


Figure 6.1. Modern water treatment works rely on the inputs of skilled operators as well as supplies of chemicals, electricity and machinery that functions reliably



understand how it works. Individual plants will vary in design, but most are based on a sequence of processes that fit together to improve the quality of water in incremental steps. Figure 6.3 shows the principal processes. Not all processes shown will operate in every case. In some cases the order in which they take place will differ.

### Assess the condition of the plant

The condition of each plant component will need to be assessed. Identify which components are working, which could be repaired and which will have to be replaced. Repair and renovation is generally quicker than replacement, particularly if skilled workers are available locally. Be aware that damaged components may not necessarily be related to the disaster. Chronic underfunding and lack of skilled workers is a common problem in the water industry, so treatment plants frequently do not function correctly, not only during emergencies.

### Decide what to do first

The first requirement is to get water into the distribution system quickly. Water quantity (rather than quality) provides the main health and social benefits during an emergency. Treatment, therefore, can be limited in the first instance, but ensure that the water is free of gross contaminants that may block or damage pipes and pumps.

### Preventing pollution

The first step in improving water quality is to reduce the need for treatment by minimizing the level of pollution at source. Providing environmental sanitation services (such as the management and disposal of excreta, solid waste and rainwater), controlling erosion, reducing agricultural pollution and restricting direct public access to the water source can reduce the amount of contaminants that have to be removed from the water (Figure 6.2). In many cases, restoring a sewage

collection and treatment system may be a greater priority than completely rehabilitating the water treatment works.

### Staged rehabilitation

The priority for treatment works rehabilitation is shown in Figure 6.4 overleaf. If, however, the water is relatively clear, chlorination can be introduced at an earlier stage. This may involve the installation of temporary pipelines to bypass damaged sections of the plant. If major components of the works such as storage reservoirs and sedimentation tanks are badly damaged, their repair or replacement will be expensive and take a long time. During the emergency phase they should be replaced with temporary equipment such as portable storage tanks.

### Pumps and power

Pumps (and the motors that drive them) are essential components of many treatment works. They have a variety of uses such as raising water from the intake into the works, between different elements in the works, or for adding and mixing chemicals. It will be essential to the overall operation of the works that they function well, so their rehabilitation must be a priority. Replacement parts may take time

to be delivered, so ask an engineer to make an early assessment of the state of the pumps.

Power is also essential and an additional priority. If the mains supply is not working, install mobile generators.

### Works operation

As soon as components of the treatment works have been re-commissioned, their operation will need to be sustained. This will include:

- **Monitoring:** The quality and quantity of water being produced by the works should be measured regularly to check whether everything is working correctly and that the output meets minimum standards (see the Sphere Guidelines for minimum standards for emergency water supplies). Simple test kits are available for measuring basic parameters of water quality. Sources of further information are given on page 6.4.
- **Chemicals:** Modern treatment works rely on the addition of chemicals to aid the treatment process. These include *alum* to help settlement, *lime* for

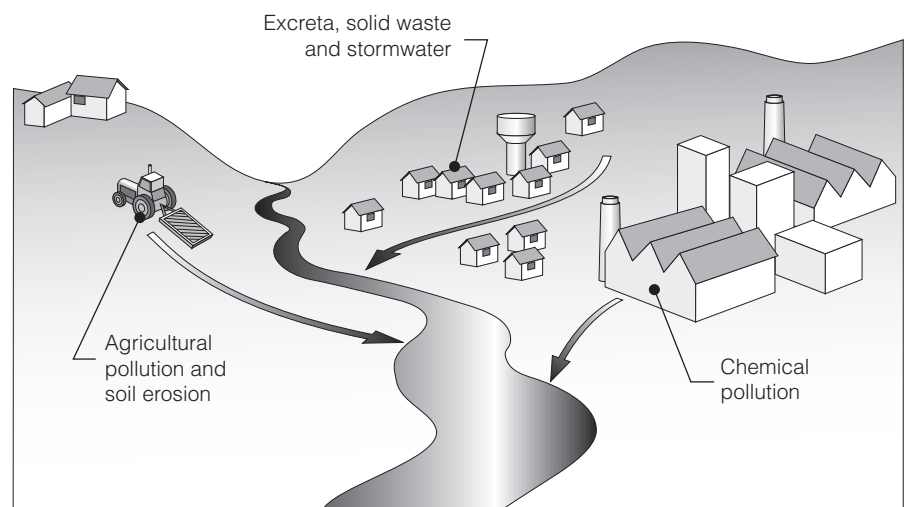
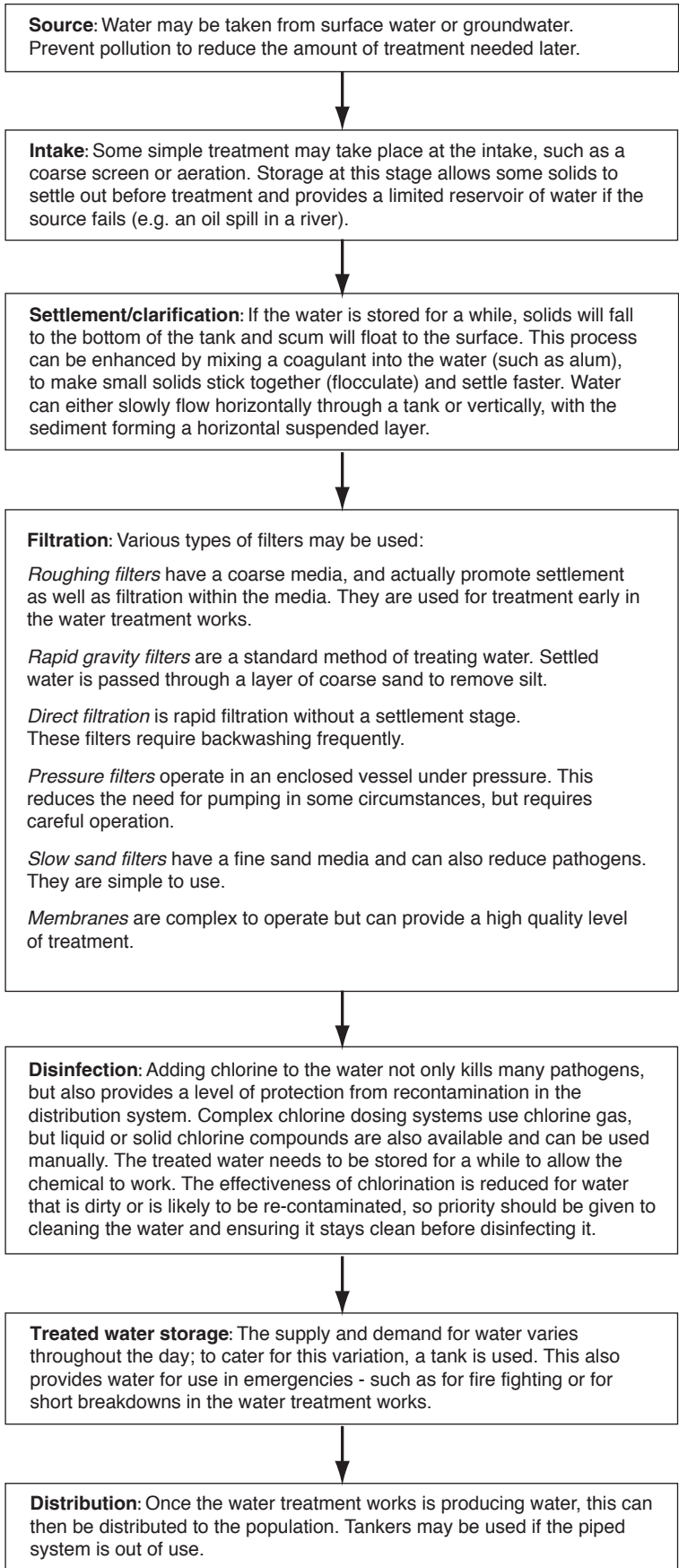
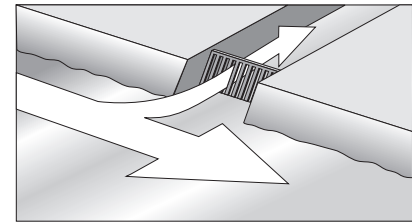


Figure 6.2. Preventing pollution upstream as shown will reduce the need for treatment

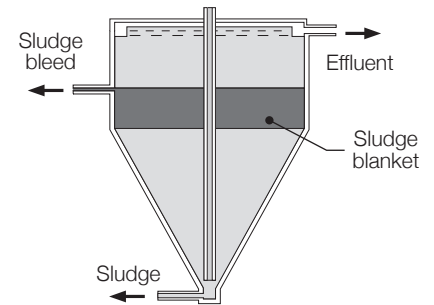
# Rehabilitating water treatment works after an emergency



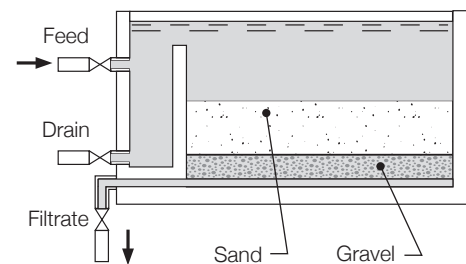
Intake



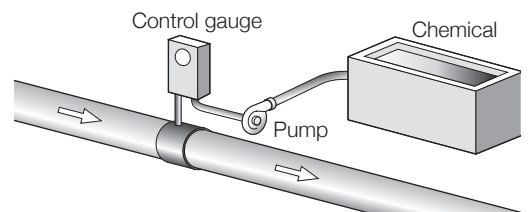
Sedimentation



Filtration



Disinfection



Storage

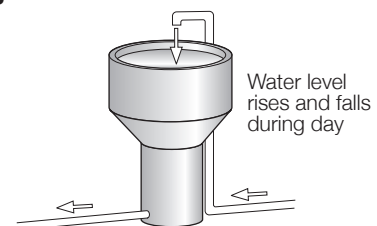


Figure 6.3. Overview of a water treatment and supply system

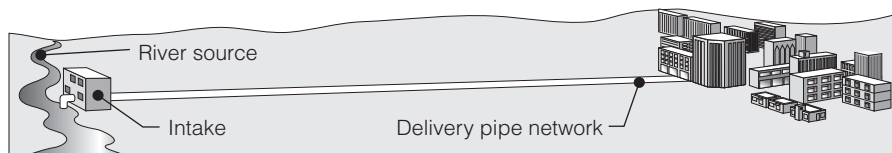
# Rehabilitating water treatment works after an emergency

adjusting the pH of the water and *chlorine* for disinfection. It may take a long time to replenish supplies so the need for chemicals should be identified and suppliers contacted as soon as possible. A reduced level of treatment can be provided if chemicals are in short supply, using point of use disinfection where it is most needed, such as in hospitals and schools.

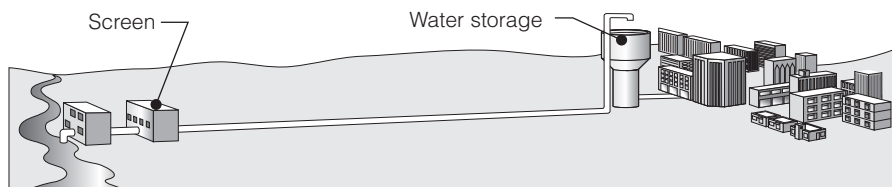
- **Maintenance:** This includes manual tasks, such as cleaning screens, removing settled sludge and lubricating pumps. The filters will become clogged with solids. Pipes will need to be checked for leaks.

## Public information

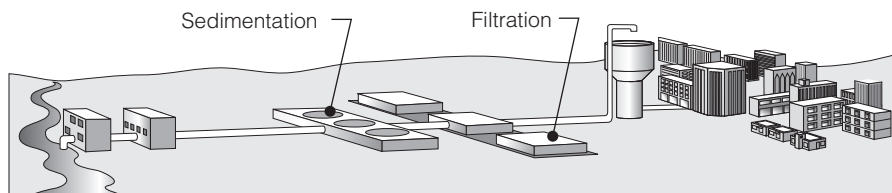
The public should be kept informed of developments. This will ease concerns about water availability and help to reduce wastage, particularly if the public can help identify leaks in the distribution system.



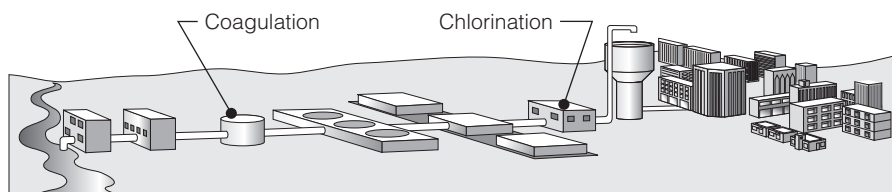
**Water intake and delivery pipe network**



**Primary screening**



**Sedimentation and filtration**



**Coagulation and chlorination**

**Figure 6.4. Water treatment in stages**

## Further information

Le Chevallier, M.W. and Au, K.K. (2004) *Water Treatment and Pathogen Control: Process efficiency in achieving safe drinking water*, WHO/IWA Publishing at: [http://www.who.int/water\\_sanitation\\_health/dwq/9241562552/en/index.html](http://www.who.int/water_sanitation_health/dwq/9241562552/en/index.html)

Twort, A.C. et al. (2000) *Water Supply*, 5th ed. Arnold with IWA Publishing: London  
Sphere (2004). *Humanitarian Charter and Minimum Standards in Disaster Response*, The Sphere Project: Geneva, Switzerland (Distributed worldwide by Oxfam GB) <http://www.sphereproject.org/>



**World Health Organization**

Water, Sanitation,  
Hygiene and Health Unit  
Avenue Appia 20  
1211 Geneva 27  
Switzerland

Telephone: + 41 22 791 2111  
Telephone (direct): + 41 22 791 3555/3590  
Fax (direct): + 41 22 791 4159  
URL: [www.who.int/water\\_sanitation\\_health](http://www.who.int/water_sanitation_health)

Prepared for WHO by WEDC. Authors: Brian Reed and Bob Reed. Series Editor: Bob Reed.

Editorial contributions, design and illustrations by Rod Shaw

Line illustrations courtesy of WEDC / IFRC. Additional graphics by Ken Chatterton.

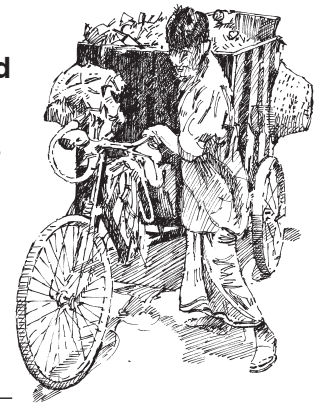
Water, Engineering and Development Centre Loughborough University Leicestershire LE11 3TU UK  
T: +44 1509 222885 F: +44 1509 211079 E: [wedc@lboro.ac.uk](mailto:wedc@lboro.ac.uk) W: <http://wedc.lboro.ac.uk>





# Solid waste management in emergencies

The safe disposal of solid waste is critical for public health, and is especially true during an emergency. Not only will existing collection and disposal systems be disrupted, but there will be extra waste caused by the emergency itself. Initially, for camps of displaced people or refugees and similar new sites, there will be no arrangements in place at all. If solid waste is not dealt with quickly, serious health risks will develop which will further demoralize the community already traumatized by the emergency. This technical note highlights the key issues to consider in managing solid waste during and shortly after a disaster.

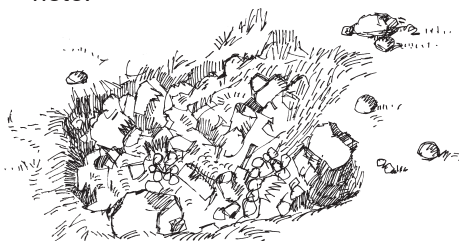


## What is solid waste?

In this technical note, the term 'solid waste' is used to include all non-liquid wastes generated by human activity and a range of solid waste material resulting from the disaster, such as:

- general domestic garbage such as food waste, ash and packaging materials;
- human faeces disposed of in garbage;
- emergency waste such as plastic water bottles and packaging from other emergency supplies;
- rubble resulting from the disaster;
- mud and slurry deposited by the natural disaster; and
- fallen trees and rocks obstructing transport and communications.

Other specialist wastes, such as medical waste from hospitals and toxic waste from industry, will also need to be dealt with urgently, but they are not covered by this technical note.



There could also be a large number of dead bodies to dispose of during and after an emergency (see Technical Note 8).

## The objective of managing solid waste

The Sphere standards state that people should be able to live in an environment that is uncontaminated

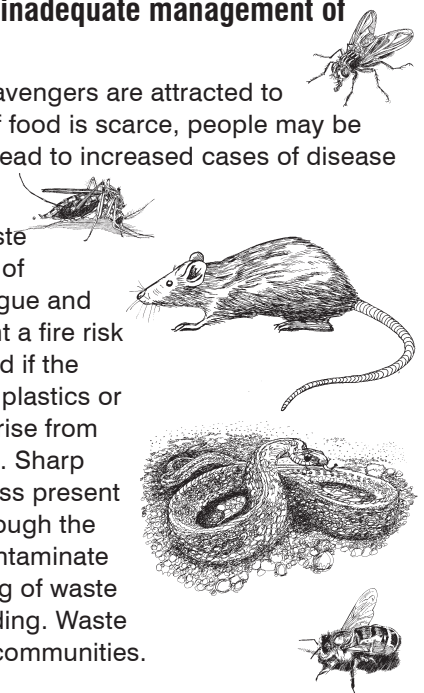
by solid waste, including medical waste, and have the means to dispose of their domestic waste conveniently and effectively.

In addition to this objective there is also the need to make the environment safe and provide access for people and services in the area.

### Box 7.1. Health risks related to the inadequate management of solid waste

Flies, rats, dogs, snakes and other scavengers are attracted to garbage, particularly in hot climates. If food is scarce, people may be forced to scavenge as well which will lead to increased cases of disease (e.g. dysentery).

Pools of rainwater associated with waste collection will propagate the breeding of mosquitoes that transmit malaria, dengue and yellow fever. Heaps of garbage present a fire risk and smoke can also be a health hazard if the burning waste contains items such as plastics or chemicals. Breathing difficulties can arise from the fungi that develop on garbage tips. Sharp items such as needles and broken glass present a further hazard to people walking through the area. Garbage washed by rain can contaminate water supplies. Indiscriminate dumping of waste can block water courses causing flooding. Waste is unsightly and lowers the morale of communities.





## Assessment

It is important to assess the issues and priorities before beginning work. Consider the following:

### Waste streams

- What types and volumes of wastes are there and how much is being produced each day?
- How is waste currently disposed of (if at all)?
- Who (if anyone) is responsible for waste collection and disposal and what resources do they have?
- What is the quantity and what are the types of waste that have been produced by the disaster, and where are they situated?

### Waste problems

- Are the current waste disposal systems coping with the volume of waste?
- Are there any hazardous wastes that require special attention (such as medical waste)?
- Can the organizations responsible for waste collection cope with the demand?
- Are steps being taken to deal with the wastes produced by the disaster? Are these sufficient?
- Are there suitable disposal facilities for all wastes being produced?

## Disposal of waste caused by a disaster

Disasters such as floods, earthquakes and hurricanes (cyclones) can produce large quantities of rubble. This will be a danger to people, block access roads, conceal trapped persons and block drainage channels. It will also hinder the access of other emergency services (Figure 7.1).

Once all survivors have been released from the rubble (they can survive for up to seven days), its removal and the demolition of dangerous structures should be a priority. If there is no approved waste disposal site near by, the

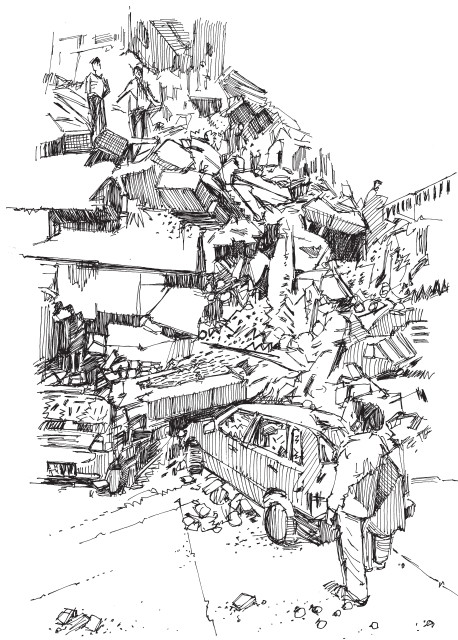


Figure 7.1. Disasters can produce large quantities of rubble

wastes can be piled, in the short term, on areas of waste land. Not all rubble is waste. Items such as zinc roofing sheets, furniture and bricks can be reused. If possible sort the rubble as it is being removed, storing reusable materials separately from the rest of the waste. Waste piles can be a serious fire risk so provide a security fence to keep out the public and ban the use of all naked flames, including cigarettes.

### Work with the community

People affected by major disasters are badly traumatized. Giving them a task to perform can help them overcome the trauma. Employ neighbourhood groups to clean up their areas. This will bring money into the communities and strengthen their links with their areas. Introduce a rotation system so that all families in the community can benefit.

### Protect the workforce

The workforce should be protected from physical injury by the provision of masks, overalls, gloves and boots (Figure 7.2). They should be vaccinated against common diseases such as tetanus.

Consult local health services for advice on vaccination.

## Domestic waste

A major disaster will not stop people producing garbage but the content may change. If people have stayed close to their homes it is best to support the use of traditional practices. In rural areas this is likely to be burial, either within the family compound or in shared neighbourhood pits.

Most urban areas will have had some form of communal collection system prior to the emergency. It may be necessary to set one up and support it financially, by supplying vehicles and by employing personnel. When recruiting people, hire from the local community.

### Collection and transport

In the early stages of an emergency, provide communal storage bins (Figure 7.3). As the situation stabilizes, the number of bins can be gradually increased to the density there was before the disaster. Immediately after a disaster, a 100 litre container will serve 200 people. This drops to 50 people per container in the long term.

The type of transport used for moving the garbage from bins to its final point of disposal depends on the quantity of waste produced, the distance over which it has to be transported and available local resources. Box 7.2 illustrates some of the common vehicles used.

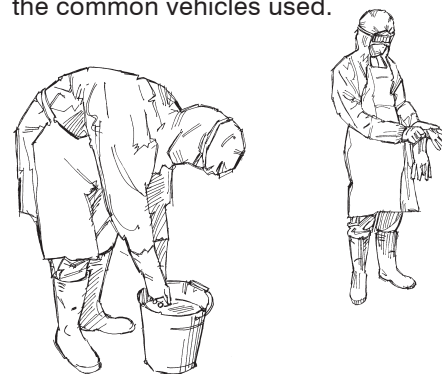


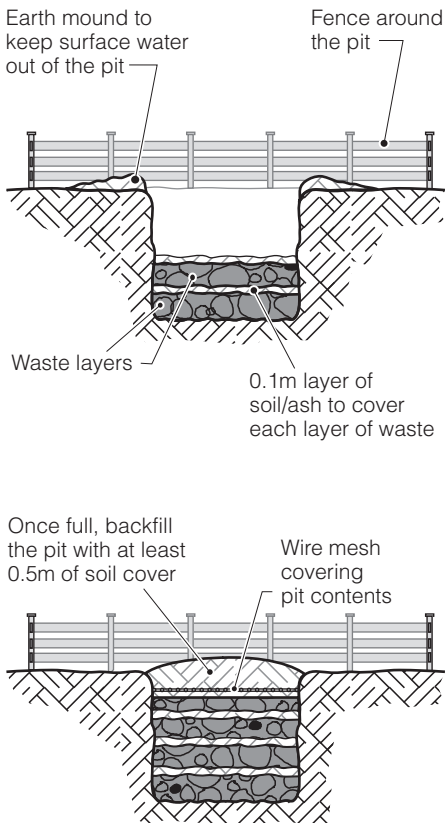
Figure 7.2. Provide the workforce with protective clothing

## Disposal

Existing urban areas will almost certainly have established waste disposal sites. Use these if possible. If they cannot be used, set up temporary disposal sites such as communal pits similar to the type shown in Figure 7.4.



**Figure 7.3.** Provide communal storage bins for domestic waste in the early stages of an emergency



**Figure 7.4.** A communal pit

## Camps

For low-density refugee camps, the best waste disposal option is the family solid waste pit similar to those used in rural communities. If the plot size is too small for family

pits, treat the camp like an urban area by using communal pits or larger disposal sites away from the camp.

### Box 7.2 Solid waste collection and transportation

When selecting a suitable vehicle for transportation of waste, the waste generation rates and densities need to be considered along with the areas they need to access, such as narrow alleys or uneven paths, and the distance between collection and disposal points.



## Other important issues

### Community issues

It is useful and important to consult potential users of a waste management system before and during its design, construction and use. This is particularly true for a displaced community as some

people may not be accustomed to using a communal system.

### Recycling

Recycling should be encouraged and managed properly as it provides a local source of income and reduces the amount of waste for disposal.



Figure 7.6. Involving professional staff

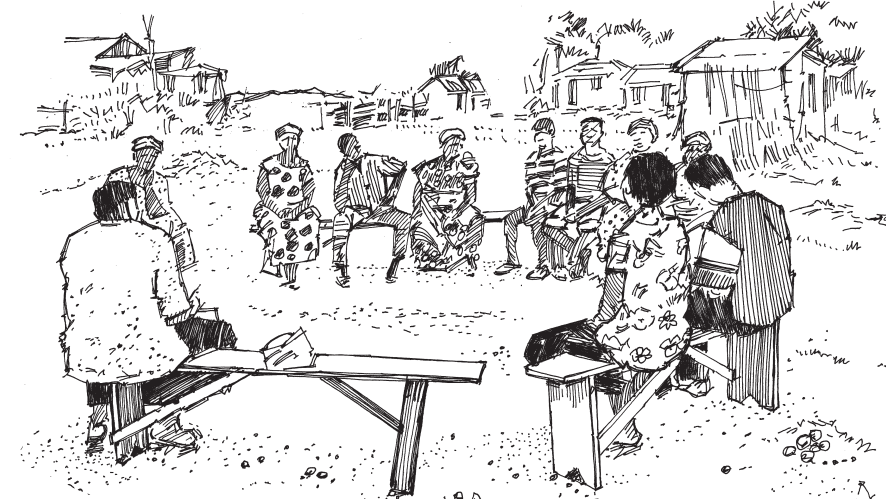


Figure 7.5. Consulting with the community

### Other disposal methods

Disposal systems such as composting, incineration and sanitary landfill can be considered once the situation has stabilized. They are unlikely to be a first phase emergency response activity.

### Management

The key to effective solid waste collection and disposal is good management. It is often necessary to support local institutions with funds and professional staff to enable them to meet their responsibilities.

## Further information

Harvey, P., Baghri, S and Reed, R. A. (2002) *Emergency Sanitation: Assessment and Programme Design*, WEDC, Loughborough, UK.

OXFAM (2008) 'Domestic and Refugee Camp Waste Management Collection and Disposal' *Technical Briefing Note 15*. Oxfam UK.

<http://policy-practice.oxfam.org.uk/publications/domestic-and-refugee-camp-waste-management-collection-and-disposal-126686>

OXFAM (2008) 'Composting of Organic Materials and Recycling' *Technical Briefing Note 16*. Oxfam UK.

<http://policy-practice.oxfam.org.uk/publications/composting-of-organic-materials-and-recycling-126187>

OXFAM (2008) 'Large Scale Environmental Clean up Campaigns' *Technical Briefing Note 17*. Oxfam UK.

<http://policy-practice.oxfam.org.uk/publications/large-scale-environmental-clean-up-campaigns-126688>

OXFAM (2008) 'Handling and Storage of Hazardous wastes' *Technical Briefing Note 18*. Oxfam UK.

<http://policy-practice.oxfam.org.uk/publications/handling-and-storage-of-hazardous-wastes-126687>

Sphere (2011). *Humanitarian Charter and Minimum Standards in Disaster Response*, The Sphere Project: Geneva, Switzerland (Distributed worldwide by Oxfam GB) <http://www.sphereproject.org/>

Wisner, B. and Adams, J. (2002) *Environmental Health in Emergencies and Disasters*. WHO Geneva.

[http://www.who.int/water\\_sanitation\\_health/emergencies/emergencies2002/en/index.html](http://www.who.int/water_sanitation_health/emergencies/emergencies2002/en/index.html)



**World Health Organization**

Water, Sanitation,  
Hygiene and Health Unit  
Avenue Appia 20  
1211 Geneva 27  
Switzerland

Telephone: + 41 22 791 2111  
Telephone (direct): + 41 22 791 3555/3590  
Fax (direct): + 41 22 791 4159  
URL: [www.who.int/water\\_sanitation\\_health](http://www.who.int/water_sanitation_health)

Prepared for WHO by WEDC. Authors: Jonathan Rouse and Bob Reed. Series Editor: Bob Reed.

Editorial contributions, design and illustrations by Rod Shaw

Line illustrations courtesy of WEDC / IFRC. Additional graphics by Ken Chatterton.

Water, Engineering and Development Centre Loughborough University Leicestershire LE11 3TU UK  
T: +44 1509 222885 F: +44 1509 211079 E: [wedc@lboro.ac.uk](mailto:wedc@lboro.ac.uk) W: <http://wedc.lboro.ac.uk>

**WEDC**





# Disposal of dead bodies in emergency conditions

Dealing with the dead is one of the most difficult aspects of a disaster response. This is not so much due to health-related risks, which tend to be negligible, but to the psychological, social and political impact of the trauma. This technical note outlines the health implications of dealing with mass fatalities and priority actions that need to be considered when planning for the collection and disposal of the dead.

## Health risks from mass fatalities

Contrary to common belief, there is no medical evidence to suggest that large numbers of dead bodies, in themselves, cause disease or epidemics. Human remains originating from traumatic events (natural disasters, accidents or warfare) do not represent a health hazard. The only situation where there is a health risk is when communicable disease has been the cause of the fatalities.

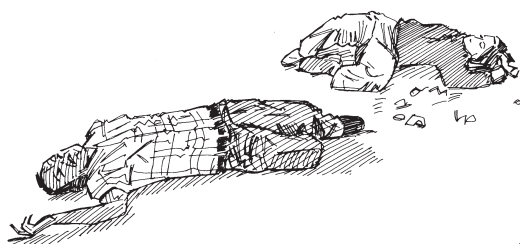


Figure 8.1. The loss of loved ones

This technical note focuses on the priority tasks for dealing with dead bodies not caused by medical epidemics.

Much of the information given in this note is drawn on Morgan et al. (2006). It is strongly recommended that, if you are likely to be involved in the disposal of dead bodies, you should consult this text first.

## Priority tasks

Beyond injury, the primary health concern for survivors of a disaster is the psychological trauma of the loss of loved ones and of witnessing death on a large scale (Figure 8.1). For this reason it is important to proceed with the collection of dead bodies as soon as possible, but it is not necessary or advisable to hurry their disposal.



## Deal with the living first

In all cases, priority should be given to the living. Search and rescue should not be held up because of concerns about the dead, nor should health care resources (e.g. ambulances and hospital beds) be used to deal with them.



## Protect the workforce

Body recovery often takes place spontaneously by groups from the surviving community, volunteers, and search and rescue teams. Recovery teams should wear protective equipment such as gloves and boots. They should also be encouraged to wash their hands with soap after handling dead bodies.



Recovery teams also face risks from working in dangerous environments. Try to vaccinate workers against tetanus and ensure first aid and medical treatment is available in case of injury (Figure 8.2).



Figure 8.2. A first aid kit

## Disposal of dead bodies in emergency conditions

The handling of large numbers of dead bodies can have a serious impact on the mental health of members of the recovery team. The effects can take a variety of forms and may occur immediately after the event or much later. Health services must be prepared for this and deal with it as and when it arises (Figure 8.3).



Figure 8.3. Caring for the recovery team

### Body recovery

Bodies should be recovered as quickly as possible, but without interrupting other activities aimed at helping survivors. Rapid recovery aids identification and reduces the psychological effects on survivors. Bodies should be placed in body bags. If these are not available, use plastic sheets, shrouds, or other locally-available materials. Separate body parts such as arms or legs should be treated as individual bodies. Do not try to match severed parts at the disaster site.



Figure 8.4. Wrapped bodies

Personal belongings should be kept with the body. They will aid identification and may have legal and psychological implications for survivors.

Keep details of the place and date when the body was found, using a form similar to that shown in Box 8.1.

Give the body a unique reference number, copy it on to waterproof labels and attach these to both the body and its container. Labels should not be removed until the body has been collected by relatives.

### Temporary storage of dead bodies

In warm climates, a body will begin to decompose within 12 to 48 hours. If possible, keep the body under refrigeration between 2°C and 4°C, at least until it has been formally identified. A refrigerated transport container used by shipping companies can store up to 50 bodies. Where this is not possible, temporary burial is the next-best option. Dig a trench 1.5m deep, at least 200m from any water source and at least 2m above the water table. Lay the bodies in a single layer leaving 0.4m between each (Figure 8.5). Clearly mark the position of each body at ground level with its unique identification number.

### Identification and release

As bodies decompose quickly, especially in warm climates, they

should be identified as soon after recovery as possible. Make a photographic record of the body (Box 8.2). Clean the body sufficiently to allow key features to be visible and make sure the identifying label is visible in each photograph. Leave clothing on the body and store it with all belongings. Complete an identification form such as that in Annex 1 of Morgan (2006).

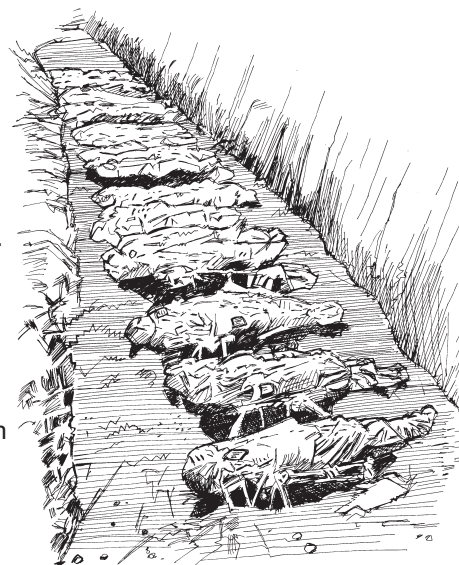


Figure 8.5. Preparing for temporary burial

### Box 8.1. Unique reference numbering for dead bodies

Each body or body part *must* have a unique reference number. The following is recommended.

**PLACE + RECOVERY TEAM/PERSON + BODY COUNT**

For example:

**Colonia San Juan - Team A-001**

or:

**Chiang Mai Hospital - P. Sribanditmongkol-001**

**PLACE:** Where possible, all bodies should be assigned a unique reference number indicating place of recovery. If recovery place is unknown, use instead the place where the body was taken for identification/storage.

**RECOVERY TEAM/PERSON:** Person or team numbering the body.

**BODY COUNT:** A sequential count of bodies at each site (e.g., 001 = body number one).

**Note:** Details about where and when the body was found and the person/organization who found it should also be recorded on the Dead Bodies Identification Form.

Source: Morgan et al. (2006)

Identifying a loved one from amongst a mass of dead bodies is extremely distressing. Try to minimize emotional stress. First, use good quality photographs as the preliminary phase of the identification process. Visual identification is the simplest method, but not always the most reliable, particularly if the body is disfigured or has begun to decompose. Always cross-check identification by using personal belongings or special identifying marks.

Bodies that are severely disfigured or have decomposed may have to be identified by scientific methods such as DNA testing or referral to dental records.

Bodies should only be released to relatives once a formal identification has been made. A formal handover document (such as a death certificate) should be provided. Keep a record of the people collecting the bodies of their relatives.

**Long-term storage and disposal**  
Only in rare cases can the mass disposal of unidentified dead bodies be justified (Figure 8.6).

**It is a basic human right for a deceased person to be identified, issued with a death certificate and disposed of in accordance with local customs. Failure to do so causes distress to relatives and can lead to long-term mental health problems.**



Figure 8.6. Mass disposal of dead bodies

## Box 8.2. Minimum photograph set required for visual identification

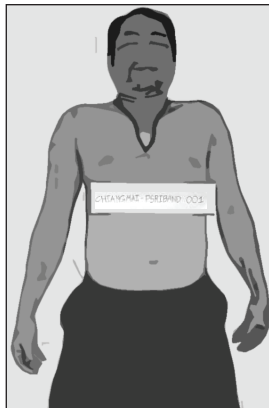
Face



Whole body



Upper body



Lower body



All identified bodies should be released to relatives for final disposal.

Long-term storage will be required for bodies that are unclaimed. Burial is the preferred method as other methods destroy the evidence for future identification.

Bodies should be buried 1.5 to 3.0m deep in marked graves and following local customs and traditions. Communal graves should only be used in the case of an extreme disaster.

The minimum distance from water sources is shown in Table 8.1.

**Remember, a body must be buried with its unique reference number attached to it and to the container.**

## Support for relatives

The dead and bereaved should be respected at all times. It is a priority for affected families to know the fate of their loved ones. A sympathetic and caring approach is necessary. Take note of cultural and religious needs, but give honest and accurate information about the circumstances of death, even if this appears to cause further grief.

Table 8.1. Minimum distances to water sources

Number of bodies	Distance from water source
4 or less	200m
5 to 60	250m
60 or more	350m
120 bodies per 100m <sup>2</sup>	350m

Note: The bottom of grave should be at least 2.0m above the groundwater table.



## Dealing with public health emergencies

Public health emergencies causing mass fatalities are relatively rare, but when they do occur extreme care must be taken when handling the dead because of the risk of cross-infection. Table 8.2 lists the diseases for which infection from dead bodies is possible. The measures required to prevent infection vary according to each disease, but in general:

- mortuary staff should wear protective gloves, masks, boots and overalls;
- mortuaries must be kept cool and well ventilated;
- ritual cleaning and preparation of the body should be avoided;
- bodies should be sealed in water-tight body bags and relatives prevented from touching them; and
- burial should take place close to the point of death, and the number of people present should be restricted.



## Missing persons

During an emergency, family members can become separated. Missing persons should be considered to be alive unless there is evidence to suggest otherwise. Alongside measures for dealing with the collection and disposal of the dead, there should be measures in place to enable families to discover the whereabouts of their relatives. Further information about missing persons is available from the International Red Cross and Red Crescent Movement at [www.icrc.org](http://www.icrc.org)



Figure 8.8. Looking for information about loved ones

Table 8.2. Preventative measures to reduce the risk of infection from dead bodies

Disease	Use PPE (1)	Use body bag	Allow viewing	Allow embalming	
Cholera	Yes	Yes	Yes	Yes (2)	
Viral haemorrhagic fever (3)	Hantavirus	No	No	Yes	Yes
	Ebola / Marburg	Yes	Yes	Yes	No
	Crimean-Congo Haemorrhagic fever	Yes	Yes	Yes	Yes (with full PPE)
	Lassa fever / arena viruses	Yes	Yes	Yes	Yes (with full PPE)
	Rift Valley fever	No	No	Yes	Yes (with full PPE)
Dengue	No	No	Yes	Yes	
Influenza	Yes	No	Yes (with mask / goggles)	Yes	

(1) Personal Protective Equipment such as goggles/visor/face shield, gloves, medical mask, boots, coverall/gown, apron  
 (2) Disinfect the body e.g. with 0.5% chlorine solution (3) Blood-borne transmission: tissues, vomit, blood

Figure 8.7. (Left) Handling the dead with extreme care

## Further information

Morgan, O., Morris, T. B. and Van Alphen, D.(ed.) (2006) *Management of Dead Bodies after Disasters: A Field Manual for First Responders*. Pan American Health Organization (PAHO), USA. <http://www.paho.org/english/dd/ped/DeadBodiesFieldManual.pdf>

Pan American Health Organization (PAHO) (2004) 'Management of Dead Bodies in Disaster Situations',

in *Disaster Newsletter*, Disaster Manuals and Guideline Series No 5. PAHO, USA. <http://www.paho.org/english/dd/ped/DeadBodiesBook.pdf>

WHO, 2004. Cholera outbreak: assessing the outbreak response and improving preparedness. World Health Organization, Geneva. <http://apps.who.int/iris/handle/10665/43017>



**World Health Organization**

Water, Sanitation, Hygiene and Health Unit  
 Avenue Appia 20  
 1211 Geneva 27  
 Switzerland

Telephone: + 41 22 791 2111  
 Telephone (direct): + 41 22 791 3555/3590  
 Fax (direct): + 41 22 791 4159  
 URL: [www.who.int/water\\_sanitation\\_health](http://www.who.int/water_sanitation_health)

Prepared for WHO by WEDC. Authors: Julie Fisher and Bob Reed. Series Editor: Bob Reed.

Editorial contributions, design and illustrations by Rod Shaw

Line illustrations courtesy of WEDC / IFRC. Additional graphics by Ken Chatterton.

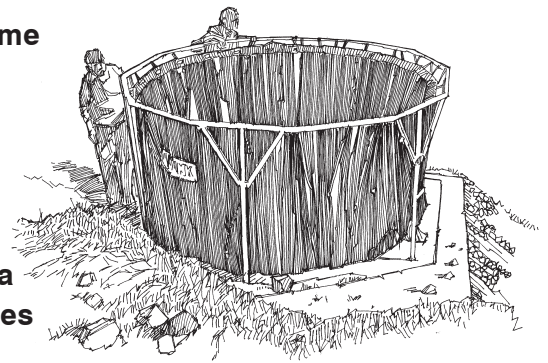
Water, Engineering and Development Centre Loughborough University Leicestershire LE11 3TU UK  
 T: +44 1509 222885 F: +44 1509 211079 E: [wedc@lboro.ac.uk](mailto:wedc@lboro.ac.uk) W: <http://wedc.lboro.ac.uk>





# How much water is needed in emergencies

Water is essential for life, health and human dignity. In extreme emergency situations, there may not be sufficient water available to meet basic needs and in these cases, supplying a minimum level of safe drinking-water for survival is of critical importance. Insufficient water and the consumption of contaminated water are usually the first and main causes of ill health to affect displaced populations during and after a disaster. This technical note considers the minimum quantities of water that are required for survival in emergencies.



## Factors affecting water requirements

The amount of water required to support life and health in an emergency varies with climate, the general state of health of the people affected and their level of physical fitness. Of equal importance in deciding how much water is needed are the expectations people have. A poor rural community may have far lower expectations concerning the quantity of water that is essential for life than people used to living in a wealthy urban environment. As a result, the poorer community is likely to consume less.

## The Sphere Standards

Attempts have been made in the past to define minimum water quantities required in emergencies. In 2004, a cluster of relief agencies developed the document entitled *Sphere Humanitarian Charter and Minimum Standards in Disaster Response* which set standards for the minimum level of services people affected by an emergency should receive. For water supply, it states that all people should “have safe and equitable access to sufficient quantity of water for drinking, cooking and personal and

domestic hygiene” and that public water points should be “sufficiently close to households to enable use of the minimum water requirement”.

Most major relief agencies and their donors have accepted the Sphere Standards as the foundation for acceptable relief services. Sphere also describes *indicators* which relate to the delivery of the standards, including water quantity standards. Indicators are not binding like the standards; rather, they are suggestions of what might be a *reasonable interpretation* of the standards.

This technical note uses the Sphere indicators for guidance.

Carefully consider your local situation to be sure that they are appropriate for the conditions you are dealing with.

## How much water does an individual use?

People use water for a wide variety of activities. Some of these are more important than others. Having a few litres of water to drink each day, for example, is more important than having water for personal hygiene or laundry, but people will still want and need to wash for the prevention of skin diseases and meeting other physiological needs. Other uses of water have health and other benefits but decrease in urgency as Figure 9.1 demonstrates.

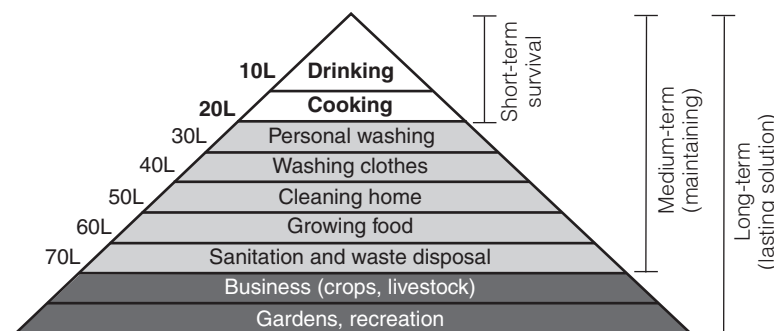


Figure 9.1. Hierarchy of water requirements (after Maslow's hierarchy of needs)



# ▶ How much water is needed in emergencies

## Priorities for water

People do not always have predictable needs. In some cultures, the need to wash sanitary towels or to wash hands and feet before prayer may be perceived to be more important than other water uses. Talk to people to understand their priorities. People may also have quite specific needs concerning the use of water for anal cleansing.

Women and men may have different priorities. Women may be concerned about basic household water requirements and water to wash during menstruation, whilst men may have concerns about livestock. In the assessment, waste spillage and leaks also need to be taken into consideration.

The Sphere Standards suggest a basic survival-level water requirement to use as a starting point for calculating demand (see Table 9.1). However, research indicates that 20 liters per capita per day is the minimum quantity of safe water required to realise minimum essential levels for health and hygiene. Therefore, efforts should be made to incrementally secure this amount for each individual.

## Water sources and quality

People do not have to get all their water from a single source. They may be provided with bottled



Figure 9.2. Water does not have to be of the same quality for all uses

Table 9.1. Simplified table of water requirements for survival (per person)

Type of need	Quantity	Comments
Survival (drinking and food)	2.5 to 3 lpd	Depends on climate and individual physiology
Basic hygiene practices	2 to 6 lpd	Depends on social and cultural norms
Basic cooking needs	3 to 6 lpd	Depends on food type, social and cultural norms
<b>Total</b>	<b>7.5 to 15 lpd</b>	lpd: Litres per day

Source: Adapted from Sphere. Also see WHO, 2011. *Guidelines for drinking-water quality, 4th edition*. World Health Organization, Geneva. [http://www.who.int/water\\_sanitation\\_health/publications/2011/dwq\\_chapters/en/index.html](http://www.who.int/water_sanitation_health/publications/2011/dwq_chapters/en/index.html)

drinking-water, but use water from a stream to wash their clothes.

As demand for water increases, generally the quality required for each use can be reduced. Water for cleaning a floor does not have to be of the same quality as drinking-water and water for growing subsistence crops can be of a lower quality still.

## Sanitation and water requirement

The type of sanitation provided has a big impact on water requirement. Water-borne types of sanitation, such as flush toilets, require a large volume of water (up to 7L per person per use).

Pit latrines, or simple pour-flush toilets (Figure 9.3) have a much lower water requirement.

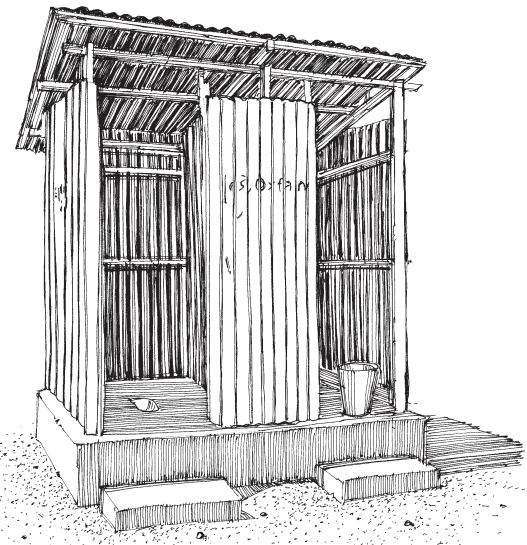


Figure 9.3. Pour-flush pit latrines

## Accessibility

Even if plenty of water is provided, there may be other limits to its use, such as the time taken for people to travel and queue to collect it. If it takes more than 30 minutes to collect water, the amount they will collect will reduce (see Figure 9.4).

Providing washing and laundry facilities near the water points reduces the need to transport water.

### Box 9.1. Minimum provision of domestic water containers

Two vessels 10-20L for collecting water plus one 20L vessel for water storage, (narrow necks and covers) per 5 person household.

**Sphere (2004) suggests that in emergencies the maximum distance from any household to a water point be 500 metres and the maximum waiting time to collect water be 15 minutes.**

## Water for non-domestic use

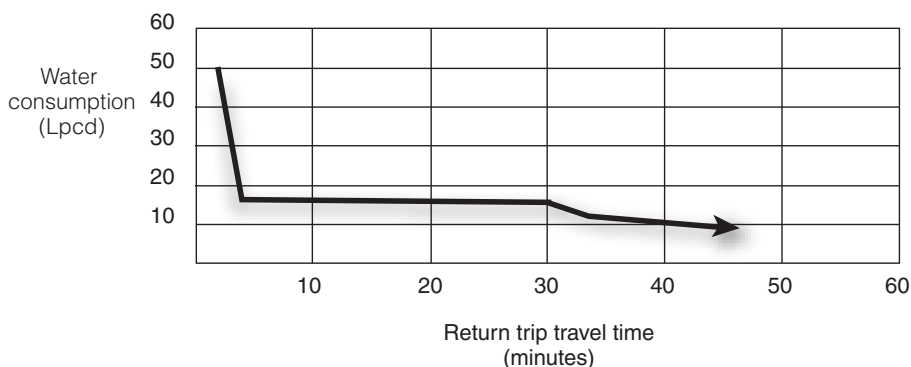
Water is essential for many other services provided in emergencies, especially health care. Affected communities may also want to use water for religious activities and agriculture. Users, not providers, decide how they will use a scarce supply of water. If people consider their livestock to be more important than doing the laundry, then they will distribute the available water accordingly. Ensure that there is enough water to meet people's priority needs with enough left over to meet the priorities related to effectively managing the emergency! Table 9.2 suggests minimum water quantities for non-domestic uses.

## Step-by-step improvements

In the first phase of an emergency, it may not be possible to meet all the water needs of the community. A staged-approach should be adopted with initial efforts focused on meeting survival needs (Figure 9.5). The service can be gradually be improved with time as resources allow (see Table 9.3).



**Figure 9.5.** Meeting survival needs



**Figure 9.4.** Relationship between water collection journey time and domestic consumption

**Table 9.2.** Guidelines for minimum emergency water quantities for non-domestic use

Use	Guideline quantity
Health centres and hospitals	5 litres/out-patient; 40-60 litres/in-patient/day. Additional quantities may be needed for laundry equipment, flushing toilets, etc.
Cholera centres	60 litres/patient/day; 15 litres/carer/day
Therapeutic feeding centres	30 litres/in-patient/day; 15 litres/carer/day
Operating theatre/maternity	100 litres / intervention
SARS isolation	100 litres / isolation
Viral Haemorrhagic Fever isolation	300-400 litres / isolation
Schools	3 litres/pupil/day for drinking and hand washing (use for toilets not included: see below)
Mosques	2-5 litres/person/day for washing and drinking
Public toilets	1-2 litres/user/day for hand washing; 2-8 litres/cubicle/day for toilet cleaning
All flushing toilets	20-40 litres/user/day for conventional flushing toilets connected to a sewer; 3-5 litres/user/day for pour-flush toilets
Livestock/day	Cattle, horses, mules: 20-30 litres per head; goats, sheep, pigs: 10-20 litres per head, Chickens: 10-20 litres per 100
Vegetable gardens	3-6 litres per square metre per day

Source: Adapted from Sphere

**Table 9.3.** Suggested quantities of water, and distances of water points from shelters at different stages of an emergency response

Time – from initial intervention	Quantity of water (litres/person/day)	Maximum distance from shelters to water points (km)
2 weeks to 1 month	5	1
1 to 3 months	10	1
3 to 6 months	15 (+)	0.5

Source: Adapted from Sphere. Also see WHO, 2008. *Essential environmental health standards in health care*. World Health Organization, Geneva. [http://www.who.int/water\\_sanitation\\_health/hygiene/settings/ehs\\_hc/en/](http://www.who.int/water_sanitation_health/hygiene/settings/ehs_hc/en/)

## Calculating water demand

A large number of assumptions have to be made to calculate the total water requirements in an emergency. Often, basic information is not available and the situation changes very quickly. Box 9.2 shows how total water demand can be estimated and the types of assumption that have to be made. Remember, it is only an estimate! Demand can be much higher or lower than estimated, so allow as much flexibility as possible in the amount of water you can actually provide.

## Ensuring supply has an impact

Providing water does not always mean it will have the desired impact on, for example, the protection of health. Look at the entire water supply system and identify weak points. Providing more water to a tap stand will not necessarily increase consumption if it is too far away, or if people do not have enough water containers. Providing more water may cause drainage problems if there are no facilities for disposing of sullage. Regularly check how much water people are actually using; when and where are they using it; and how they are using it.

### Box 9.2. A sample calculation

How much water is needed for a camp of 5,000 displaced people (including 1,000 primary school age children), 25 relief agency staff, and 75 cows?

The camp has a mosque and a small health centre without patient facilities. Each family has been provided with a pit latrine and most people use water for anal cleansing. A feeding centre is currently provided but is expected to close once the health of the population has stabilized. A primary school will be constructed at a later stage.

#### Decisions

- Water for crops will not be provided.
- Staff will be resident during the initial stages of the emergency but will be able to travel into the camp at a later date and are not normally included in this calculation.
- Assume 10% wastage from spills, leaks and waste.

#### Phase 1: Survival supply (litres)

Domestic use:	5,000 x 7.5	=	37,500
Feeding centre (small children estimated number):	500 x 30	=	15,000
Carers:	500 x 15	=	7,500
Relief staff:	25 x 30	=	750
Health centre : (assume 250 visits per day):	250 x 5	=	1,250
Mosque (assume all adults visit daily):	3,000 x 2	=	6,000
Cattle:	75 x 20	=	1,500
<i>Total</i> :		=	<i>69,500</i>
Add 10% leakage:		=	6,950
Approximate litres per day:		=	76,450

#### Phase 2: Long-term solution (litres)

Domestic use (assume population remains static):	5,000 x 15	=	75,000
Staff office (daily office use only):	25 x 5	=	125
School:	1,000 x 3	=	3,000
Health centre:	250 x 5	=	1,250
Mosque:	3,000 x 5	=	15,000
Cattle (allow for some growth in numbers):	100 x 30	=	3,000
<i>Total</i>		=	<i>97,375</i>
Add 10% leakage		=	9,737
Approximate litres per day:		=	107,112

## Further information

House, Sarah and Reed, Bob (2000) *Emergency Water*

Sources: *Guidelines for selection and treatment*, WEDC, Loughborough University, UK.  
<http://wedc.lboro.ac.uk/publications/>

The Sphere Project (2004) *Humanitarian Charter and*

*Minimum Standards in Disaster Response*. The Sphere Project: Geneva, Switzerland.  
<http://www.sphereproject.org>

U.S. Agency for International Development, Bureau for Humanitarian Response, Office of Foreign Disaster Assistance (OFDA) (1998) *Field Operations Guide for Disaster Assessment and Response*

[http://www.usaid.gov/our\\_work/humanitarian\\_assistance/disaster\\_assistance/resources/index.html#fog](http://www.usaid.gov/our_work/humanitarian_assistance/disaster_assistance/resources/index.html#fog)



**World Health Organization**

Water, Sanitation, Hygiene and Health Unit  
 Avenue Appia 20  
 1211 Geneva 27  
 Switzerland

Telephone: + 41 22 791 2111  
 Telephone (direct): + 41 22 791 3555/3590  
 Fax (direct): + 41 22 791 4159  
 URL: [www.who.int/water\\_sanitation\\_health](http://www.who.int/water_sanitation_health)

Prepared for WHO by WEDC. Authors: Brian Reed and Bob Reed. Series Editor: Bob Reed.

Editorial contributions, design and illustrations by Rod Shaw

Line illustrations courtesy of WEDC / IFRC. Additional graphics by Ken Chatterton.

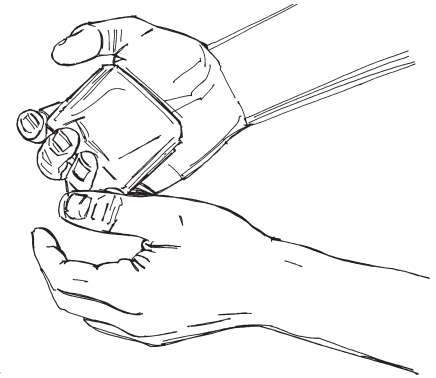
Water, Engineering and Development Centre Loughborough University Leicestershire LE11 3TU UK  
 T: +44 1509 222885 F: +44 1509 211079 E: [wedc@lboro.ac.uk](mailto:wedc@lboro.ac.uk) W: <http://wedc.lboro.ac.uk>

**WEDC**



# Hygiene promotion in emergencies

Communities affected by a disaster often lack basic water and sanitation facilities. They are likely to be traumatized and vulnerable to disease. Disruption of familiar practices or the relocation to new environments can result in a deterioration in existing hygiene behaviours. This, in turn, will contribute to an increased risk of disease transmission and epidemics. This technical note explains why hygiene promotion is important in emergencies and describes how to carry it out.



## Preventing the spread of disease

Effective hygiene promotion is widely accepted to be one of the most valuable tools to reduce the burden of diarrhoeal diseases after a disaster. Hygiene promotion is, nevertheless, given significantly less emphasis than other water supply and sanitation initiatives.

Hygiene promotion is a general term used to cover a range of strategies aimed to improve people's hygiene behaviour and so prevent the spread of disease. This note focuses on behaviour related to water supply and sanitation.

By creating a series of barriers to infection, hygiene behaviour has a critical influence on the transmission of water- and sanitation-related diseases as shown in Figure 10.2.

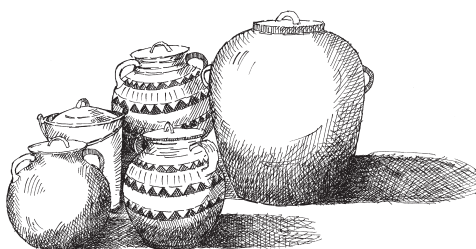


Figure 10.1. Covered water pots

The most important practices to target are:

- the appropriate use and maintenance of sanitation facilities;
- the safe disposal of faeces;
- handwashing after defecation and before food preparation (see Figure 10.3 overleaf);
- use and proper storage of safe drinking-water (see Figure 10.1); and
- the control of flies, mosquitoes and other disease vectors



## Minimum standards

Sphere sets out minimum standards for hygiene promotion in emergencies with a strong emphasis on community mobilization and participation. They state that all facilities and resources provided should reflect the vulnerabilities, needs and preferences of the affected population and that users should be involved in the management and maintenance of hygiene facilities where appropriate.

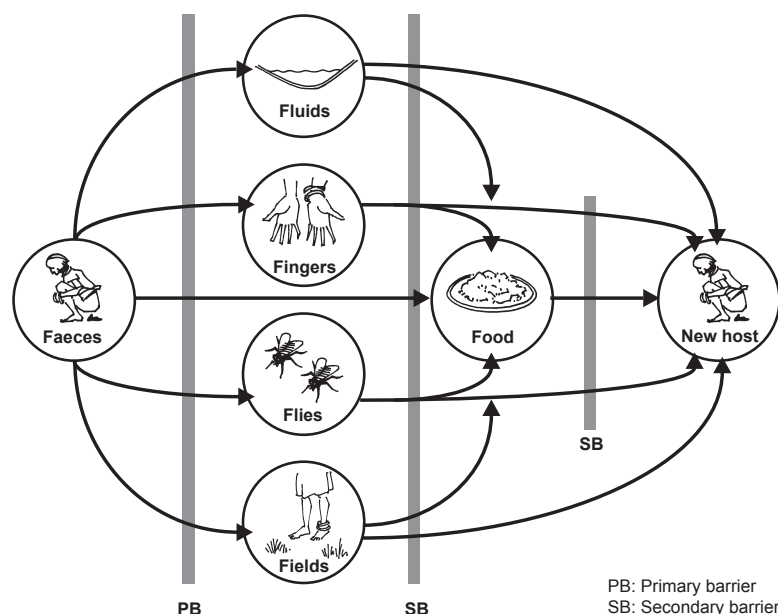


Figure 10.2. Hygiene barriers to the transmission of disease from faeces



## How to wash hands thoroughly

Hands should be washed with soap and under water for at least 20 seconds. Special attention needs to be paid to germs that may be trapped under nails and in crevices. The arrows in the pictures below show the direction of movement of the hands.

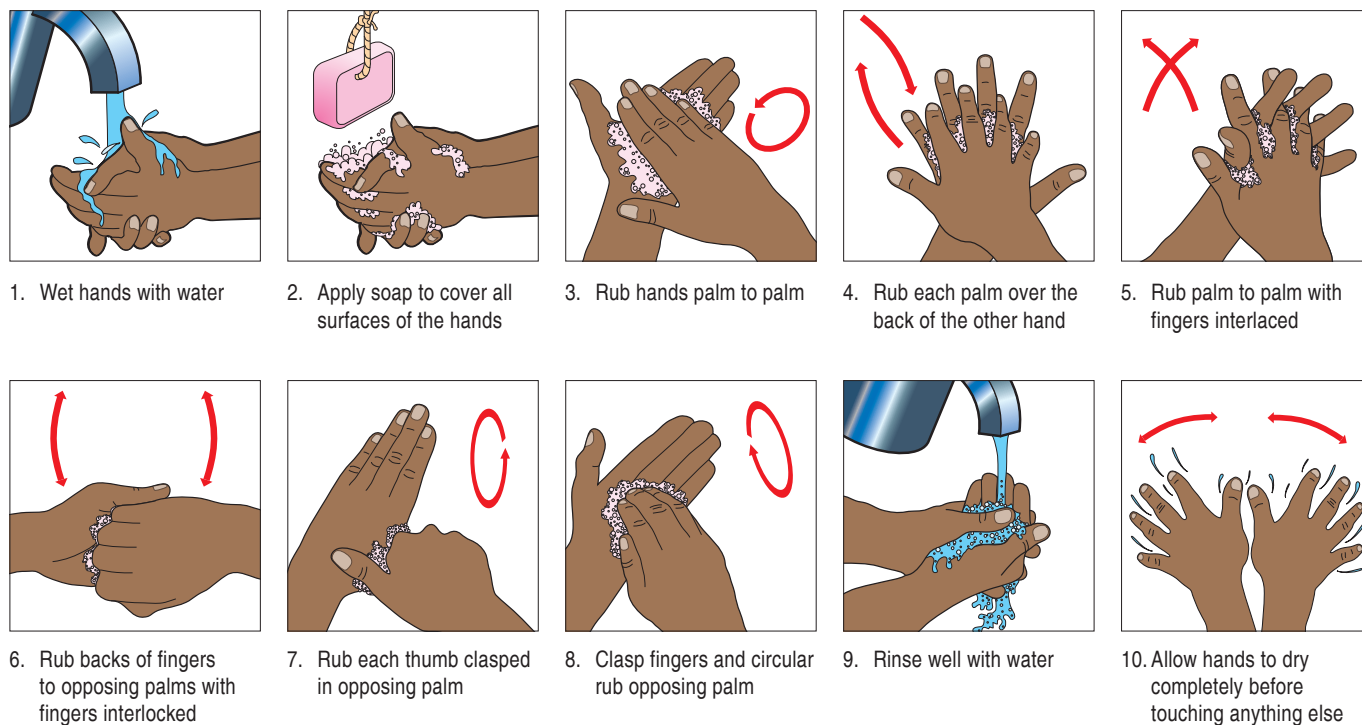


Figure 10.3. How to wash hands thoroughly

## Principles of hygiene promotion

- 1. Target a small number of risk-reduction practices.** Target the behaviours most likely to directly reduce the spread of disease first. These are likely to include handwashing with soap and safe disposal of faeces.
- 2. Target specific audiences.** Identify the community groups that have the largest influence on the changes you wish to promote and target your promotion activities at them.
- 3. Identify the motives for changed behaviour.** People often change hygiene practices for reasons not directly related to health, such as a wish to gain respect from neighbours, or personal pride.
- 4. Use positive hygiene messages.** People learn best and can listen for longer if they are entertained and can laugh. Frightening people will stop them listening to you.
- 5. Identify the best way to communicate.** Traditional and existing channels of communication are easier to use and are usually more effective than setting up new ones.
- 6. Use a cost-effective mix of communication channels.** Using several methods of communicating with your audience reinforces the message and improves acceptance. However, there will be a trade-off to consider between the cost of using multiple channels and the overall effectiveness of the campaign.
- 7. Carefully plan, execute, monitor and evaluate.** Effective hygiene promotion is community-specific. Programmes must be designed to meet the needs of a particular community. This can only be achieved through careful planning, monitoring and evaluation of activities.

## Planning hygiene promotion

### Initial assessment

A rapid assessment is important for the development of the promotion campaign and to appraise improvements achieved. The key questions to be answered by the assessment are shown in Box 10.1. In the first phase of an emergency a rapid assessment is all that can be undertaken. This may consist

## Box 10.1. Key questions for a rapid hygiene assessment

- What are the most widespread risk behaviours in the community?
- How many in the community show these risk behaviours and who are they?
- Which risk behaviours can be altered?
- Who uses safe practices and what motivates and influences their use?
- What communication channels are available and which are reliable for promoting hygiene?
- What facilities or materials do people need in order to engage in safe practices?
- How much time, money or effort are people willing to contribute to have access to those facilities/materials?
- Where will those facilities/materials be available?
- How will the availability of these facilities/materials be communicated to people?

## Box 10.2. Essential skills and knowledge required by facilitators

- Knowledge of health problems related to sanitation in emergency situations and appropriate prevention strategies.
- Understanding of traditional beliefs and practices.
- Knowledge of hygiene promotion methods targeted at adults and children.
- Understanding of basic health messages and their limitations.
- Knowledge of the appropriate use of songs, drama, puppet shows.
- Understanding of gender issues.
- Knowledge of how to target various groups and especially vulnerable groups within the affected area.
- Communication skills.
- Monitoring and evaluation skills.

of mapping the community to show the location of important features such as water sources, latrines and community facilities, an exploratory walk through the area and some focus group discussions with representatives of the affected community and representatives of key organizations.

### Planning the promotion campaign

The main steps in developing a campaign are the following:

- **Set a goal.** The goal will usually be to improve the quality of life (or to reduce the loss of life).
- **Identify hygiene problems.** These should have been identified by your initial assessment.
- **Identify key behaviours linked to the problems.** These could relate to activities such as handwashing or excreta disposal but could equally be related to a poor understanding of technology, or wrong attitudes to gender issues or the environment.
- **Determine the cause of the problems.** The more accurately the causes can be identified the easier it will be to target the campaign.
- **Prioritize actions.** Decide which problems to target first. This will depend on balancing the priorities for improving health with available resources.
- **Develop a strategy.** Decide which methods and tools you intend to use (see below).

## Facilitators

Sphere suggests that there should be one hygiene promotion facilitator for every 1000 affected people. This number should be doubled during the early stages of an emergency response. There will not be sufficient time to recruit and train dedicated facilitators for the immediate phase of an emergency, but much can be done with volunteers identified through pre-existing organizations such as faith-based groups, health care workers or extension workers. If possible, use facilitators from within the affected community as they will better understand the local difficulties and be accepted by the community.

Facilitators must be trained (see Figure 10.4). Box 10.2 lists the topics that should be included in training, but they do not have to be covered all at once. Start with basic training in promotion techniques and provide short, regular programmes to gradually upgrade their skills.



Figure 10.4. Training of facilitators

## Promotion tools and communication methods

- **Radio broadcasts.** An effective method of reaching a large number of people quickly. They should be brief, informative and entertaining with a memorable slogan or tune (jingle). Use a mix of voices in the form of a drama or interview.
- **Public address systems.** These can be used instead of radio broadcasts if the area to

be covered is small or radios are unavailable. Use loudspeakers in key locations or a mobile system attached to a slow-moving vehicle.

- **Posters.** Posters can be quickly and easily prepared, preferably in collaboration with the community. The main message should be displayed in the pictures, backed up by a few simple words in the local language. Test posters by showing them to members of the targeted community, checking whether they understand the message (see Figure 10.5).
- **Drama and street theatre.** Drama is a powerful way of getting messages across. A simple story with exaggerated characters and plenty of audience participation is ideal.



Figure 10.5. Testing a poster for children

- **Puppet shows and games.** Puppet shows and games are an excellent form of communication when the target group is children. Highly interactive entertainment is likely to be most effective.
- **Slide, film and video presentations.** If appropriate visual materials and facilities to show them are readily available they can reach a large audience in a short time. Their impact can be enhanced by subsequent group discussions highlighting key points conveyed.
- **Focus group discussions.** A guided group discussion can improve understanding of current behaviour patterns and the reasons behind them (see Box 10.3).
- **One-to-one discussions and home visits.** This is a time consuming option but very effective where skilled facilitators are used. They can work with individual families to develop specific practices to suit individual needs.

### Other practical actions

There is little point in persuading people to change their hygiene behaviour without the required tools and materials. A water supply, basic sanitation, handwashing facilities with soap and food storage containers are all necessary before new hygiene practices can be adopted.

#### Box 10.3. PHAST

PHAST (Participatory Hygiene and Sanitation Transformation) employs a range of tools to help communities understand the need for behaviour change and to act upon it.

PHAST is primarily a development approach but it has been used successfully in emergencies where communities have remained together.

See below for sources of further information.

### Further information

Harvey P., Baghri, S. and Reed, R.A. (2002) *Emergency Sanitation: Assessment and programme design*, WEDC, Loughborough University, UK.

Ferron, S., Morgan, J. and O'Reilly, M. (2007) *Hygiene Promotion: a practical guide for relief and development*, Practical Action, Rugby, UK.

Boot, M. and Caircross, S. (1993) *Actions Speak: the study of hygiene behaviour in water and sanitation projects*, IRC/LSHTM, London.

Action Centre La Faim (2005) *Water sanitation and hygiene*

*for populations at risk* – Chapter 15. Hermann Editeurs Des Sciences et des Arts, Paris ISBN 2 7056 6499 8  
Sphere (2004) *Humanitarian Charter and Minimum Standards in Disaster Response*. The Sphere Project: Geneva, Switzerland (Distributed worldwide by Oxfam GB) <http://www.sphereproject.org/>

Wood, S., Sawyer, R. and Simpson-Hebert, M. (1998) *PHAST Step-by-step Guide: A participatory approach for the control of diarrhoeal disease*, WHO, Geneva. [http://www.who.int/water\\_sanitation\\_health/hygiene/envsan/phastep/](http://www.who.int/water_sanitation_health/hygiene/envsan/phastep/)



**World Health Organization**

Water, Sanitation,  
Hygiene and Health Unit  
Avenue Appia 20  
1211 Geneva 27  
Switzerland

Telephone: + 41 22 791 2111  
Telephone (direct): + 41 22 791 3555/3590  
Fax (direct): + 41 22 791 4159  
URL: [www.who.int/water\\_sanitation\\_health](http://www.who.int/water_sanitation_health)

Prepared for WHO by WEDC. Authors: Frank Odhiambo and Bob Reed. Series Editor: Bob Reed.

Editorial contributions, design and illustrations by Rod Shaw

Line illustrations courtesy of WEDC / IFRC. Additional graphics by Ken Chatterton.

Water, Engineering and Development Centre Loughborough University Leicestershire LE11 3TU UK  
T: +44 1509 222885 F: +44 1509 211079 E: [wedc@lboro.ac.uk](mailto:wedc@lboro.ac.uk) W: <http://wedc.lboro.ac.uk>

**WEDC**



# Measuring chlorine levels in water supplies

As the quality of water can be seriously affected by a disaster or an emergency, it is best practice to disinfect all emergency water supplies. The most common way of disinfecting is with chlorine. This technical note explains why disinfection is important, why chlorine is used, how it works, how to test for its presence and where and when to test.



## Why should emergency water supplies be disinfected?

When disaster strikes a stable community with access to drinking-water of a certain quality, their situation changes:

- Disasters often damage existing water supplies leading to contamination or further contamination of the supply.
- People sometimes have to move to new locations and are forced to drink water from new sources for which they have no natural immunity to its contamination.
- Disasters frequently affect people's physical and psychological health, making them more susceptible to infection and disease.

It is important, therefore, that all people affected by a disaster are provided with access to safe drinking-water. There is a wide variety of methods for improving the quality of drinking-water, many of which are discussed in Technical Notes 4 and 5. Most of these treatment processes are designed to prepare the water for disinfection, which is the final stage in the treatment process.

## What is disinfection?

Many of the diseases that affect traumatized communities are caused by micro-organisms carried in drinking-water. Hence the reference to water-borne diseases. Disinfection is the process of destroying these organisms to prevent infection. There are a number of methods of disinfecting water, but chlorination is by far the most common. Table 11.1 lists the advantages and disadvantages of using chlorine for disinfection.

## How does chlorine work?

When chlorine is added to water, it destroys the membrane of many microorganisms and kills them. However, it is ineffective against some cysts, such as *cryptosporidium*, which are resistant to chlorine disinfection

due in part to their thick outer wall. The process only works, however, if the chlorine comes into direct contact with the organisms. If the water contains silt, the bacteria that reside within it may not be reached by the chlorine. Chlorine disinfects water but does not purify it: there are some contaminants it cannot remove (see Box 11.1 overleaf).

Chlorine takes time to kill organisms. At temperatures of 18°C and above, the chlorine should be in contact with the water for at least 30 minutes. If the water is colder then the contact time must be increased.

It is normal, therefore, to add chlorine to water as it enters a storage tank or a long delivery pipeline to give the chemical time to perform its disinfecting action before it reaches the consumer.

Table 11.1. Advantages and disadvantages of using chlorine as a disinfectant

Advantages	Disadvantages
It comes in several forms: powder, granules, tablets, liquid and gas.	It is a powerful oxidizing agent which must be handled with care and breathing chlorine fumes must be avoided.
It is usually readily available in one form or another and relatively inexpensive.	It does not effectively penetrate silt and organic particles suspended in the water.
It dissolves easily in water.	It can give an unpleasant taste if slightly overdosed, which can dissuade people from using the supply.
It provides residual disinfection (see Box 11.2).	Its effectiveness against some organisms requires higher concentrations of chlorine and longer contact times.
It is effective against a wide range of disease-causing micro-organisms.	Is ineffective in removing cryptosporidium and where this pathogen is a concern other methods should be used in combination with chlorine (i.e. filtration).

Source: Adapted from Davis and Lambert (2002)



## Box 11.1. Chlorine is not a perfect solution

Although chlorine does not destroy all micro-organisms, it is still considered to be the most effective emergency disinfectant available because the vast majority of organisms are destroyed. Chlorine will not remove chemical contaminants from the water. Chemical contamination is more difficult to remove and requires specialist knowledge and equipment.

## Box 11.2. Residual protection

Most disinfection methods kill micro-organisms effectively but do not provide any protection against recontamination further along the supply system.

Chlorine has the advantage of being both an effective disinfectant and its residual can protect the supply downstream from the disinfection point.

The turbidity and the acidity (pH) of the water have a significant effect on the efficiency of chlorine as a disinfectant. The turbidity should be < 5NTU and the pH level between 7.2 and 6.8. See Technical Note 1 for advice on how to change the pH level of water and measure turbidity.

Consult the references given under "Further information" page 11.4 on how to add chlorine to water.

## Chlorine residual

When chlorine is added to water, it will attack organic matter and attempt to destroy it. If enough chlorine is added, some will remain in the water after all possible organisms have been destroyed. What is left is called *free chlorine* (Figure 11.1). Free chlorine will remain in the water until it too dissipates or is used to destroy new contamination.

So if water is tested and found to contain some free chlorine, it proves that the most dangerous organisms in the water have been removed and it is likely to be safe to drink. This process is called *measuring the chlorine residual* (see Figure 11.2).

## Testing for chlorine residual

The quickest and simplest method for testing for chlorine residual is the dpd (diethyl paraphenylene diamine) indicator test, using a comparator. A tablet of dpd is added to a sample of water, colouring it red. The strength of colour is measured against standard colours on a chart to determine the chlorine concentration. The stronger the colour, the higher the concentration of chlorine in the water.

Several kits for analysing the chlorine residual in water, such as the one illustrated in Figure 11.2, are available commercially. The kits are small and portable.

## When and where to test water

Continuous chlorination is most commonly used in piped water supplies. Regular chlorination of other water supplies is difficult and usually reserved for disinfection after repair and maintenance. It is common to test for chlorine residual at the following points:

- Just after the chlorine has been added to the water to check that the chlorination process is working.
- At the outlet of the consumer nearest to the chlorination point to check that residual chlorine levels are within acceptable levels.
- At the furthest points in the network where residual chlorine levels are likely to be at their lowest. If chlorine levels are found to be below minimum levels (see Box 11.3) it might be necessary to add more chlorine at an intermediate point in the network.

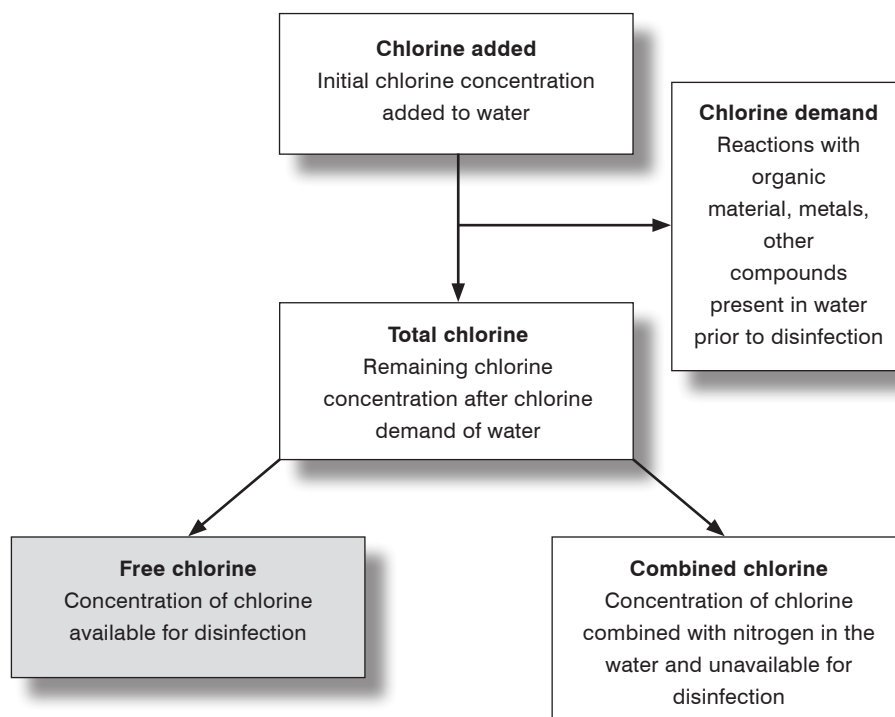
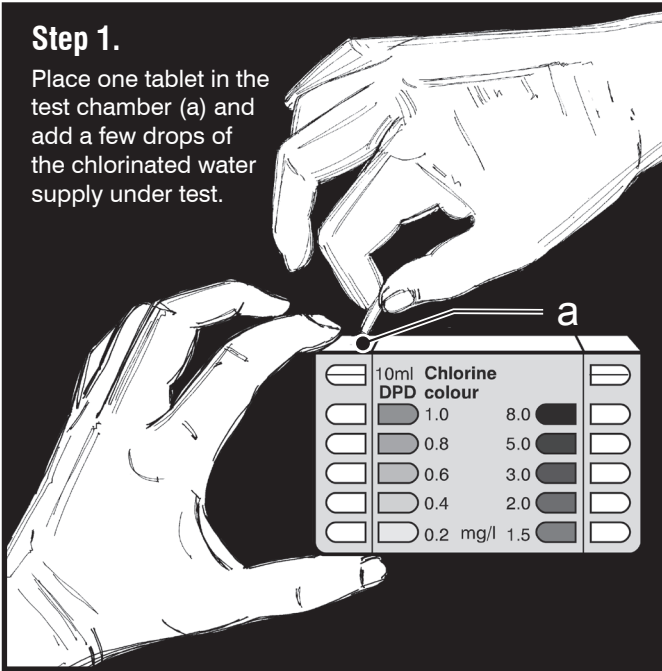


Figure 11.1. Chlorine addition

Source: Adapted from *Chlorine Residual Testing Fact Sheet*, CDC SWS Project.

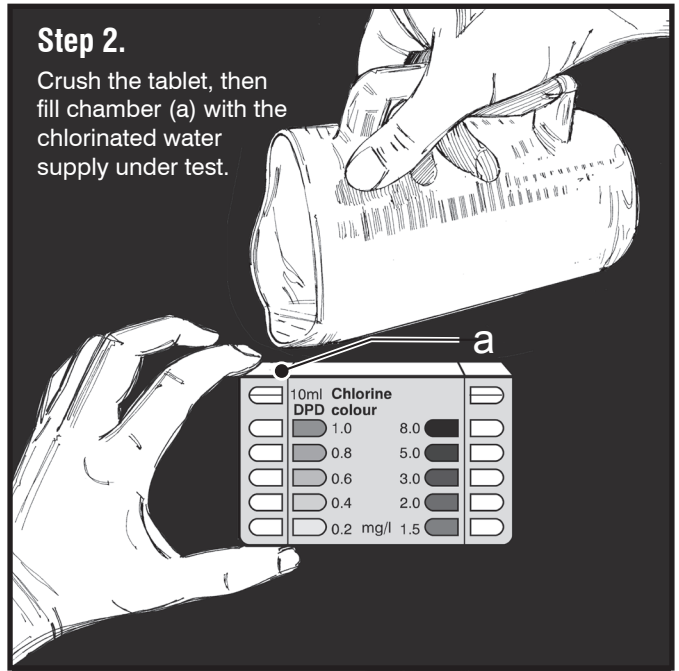
## Step 1.

Place one tablet in the test chamber (a) and add a few drops of the chlorinated water supply under test.



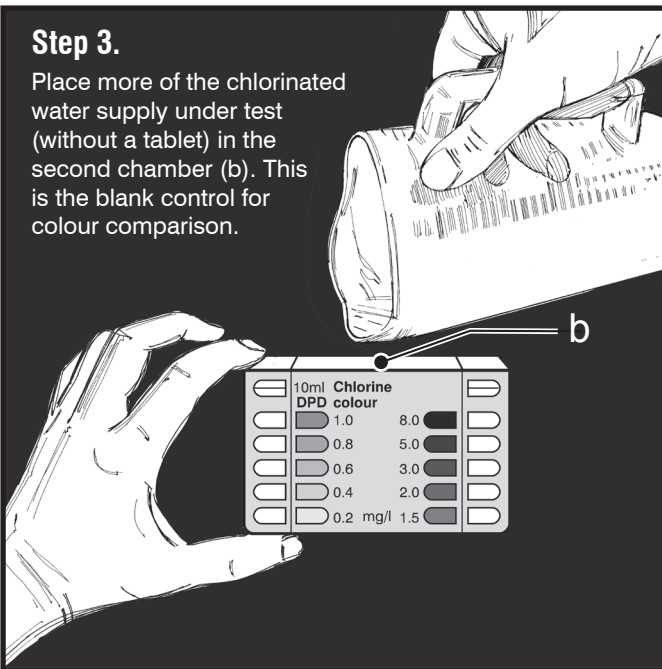
## Step 2.

Crush the tablet, then fill chamber (a) with the chlorinated water supply under test.



## Step 3.

Place more of the chlorinated water supply under test (without a tablet) in the second chamber (b). This is the blank control for colour comparison.



## Step 4.

The level of residual chlorine (R) in mg of chlorine per litre (mg/l) is determined by comparing the colour of the water supply under test in chamber (a) with the tablet added with the standard colours on the vessel (chamber (b)). Note that chamber (c) would be used if a higher chlorine residual is to be used.

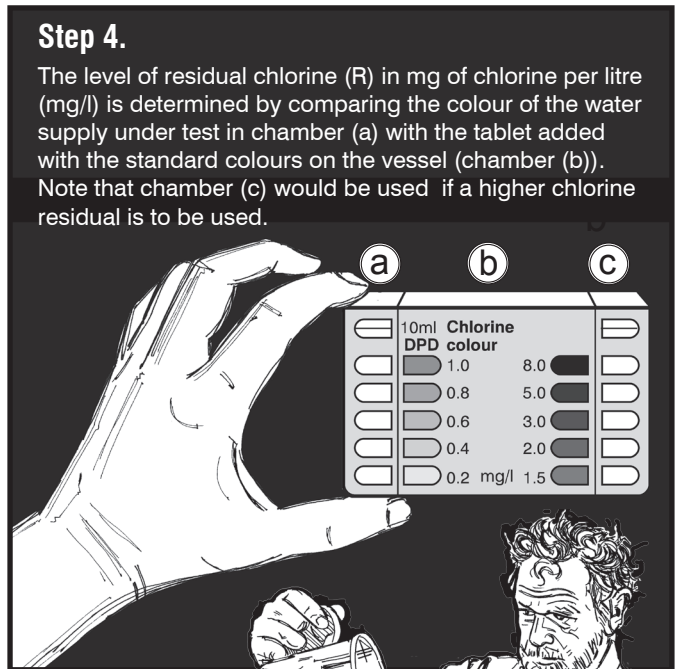
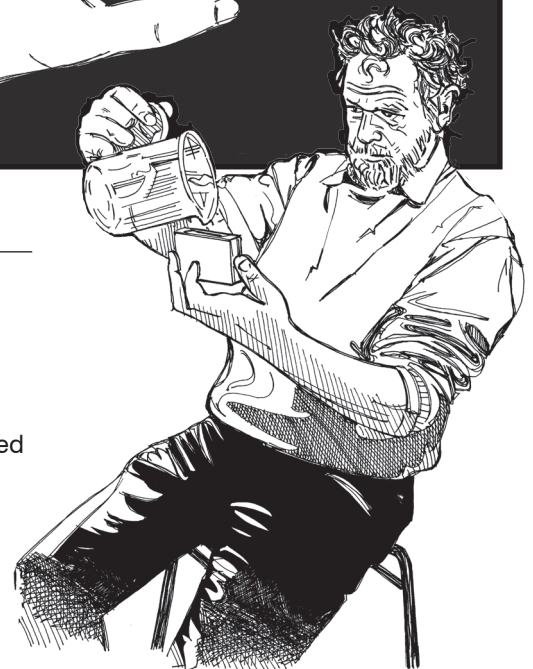


Figure 11.2. Steps in determining the chlorine residual in water using a comparator

The amount of chlorine residual changes during the day and night. Assuming the pipe network is under pressure all the time (see Box 11.4) there will tend to be more residual chlorine in the system during the day than at night. This is because the water stays in the system for longer at night (when demand is lower) and so there is more opportunity for the water to become

contaminated which reduces the residual chlorine through disinfection of the contaminants.

Chlorine residual should be checked regularly. If the system is new or has been rehabilitated then check daily until you are sure that the chlorination process is working properly. After that, check at least once a week.



### Box 11.3. Recommended residual chlorine levels

The higher the residual chlorine levels in the supply, the better and longer the chemical will be able to protect the system from contamination. However, high levels of chlorine make the water smell and give it a bad taste, which will discourage people from drinking it.

For normal domestic use, residual chlorine levels at the point where the consumer collects water should be between 0.2 and 0.5 mg/l. The higher level will be close to the disinfection point and the lower level at the far extremities of the supply network.



### Box 11.4. Chlorination and intermittent supplies

There is no point in chlorinating pipe networks if the water supply is intermittent. All pipe systems leak and when the water supply is switched off, the pressure will drop and contaminated water will enter the system through the breaks in the pipe wall. No level of residual chlorine acceptable to consumers will be able to deal with such high levels of contamination. All intermittent water supplies should be assumed to be contaminated and measures taken to disinfect water at the point of use.

### A chlorination checklist

- Chlorine needs at least 30 minutes contact time with water to disinfect it. The best time to apply chlorine is after any other treatment process, and before storage and use.
- Never apply chlorine before slow sand filtration or any other biological process, as the chlorine will kill off the bacteria which assist treatment, making the treatment ineffective.
- Never add any solid form of chlorine directly to a water supply, as it will not mix and dissolve. Always make up as a paste first, mixing the chlorine compound with a little water.
- Disinfection is only one defence against disease. Every effort should be made to protect water sources from contamination, and to prevent subsequent contamination during collection and storage.
- The correct procedure for applying a disinfectant to water should be strictly adhered to, and water supplies should be monitored regularly to ensure that they are free from bacteria. Otherwise, people may be misled to believe that the water is safe to drink when, in fact, it is hazardous to do so.
- The optimum chlorine residual in a small, communal water supply is in the range of 0.2 to 0.5mg/l.

### Further information

WHO (2011) *Guidelines for drinking water quality*, 4th ed., WHO, Geneva. [http://www.who.int/water\\_sanitation\\_health/publications/2011/dwq\\_guidelines/en/](http://www.who.int/water_sanitation_health/publications/2011/dwq_guidelines/en/)

Davis J, Lambert R. (2002) *Engineering in Emergencies* 2nd edition, chapter 13. ITDG UK.

Centers for Disease Control and Prevention. *Chlorine residual testing fact sheet*. CDC SWS Project (Undated). [http://www.cdc.gov/safewater/publications\\_pages/chlorineresidual.pdf](http://www.cdc.gov/safewater/publications_pages/chlorineresidual.pdf)

Action Contre La Faim (2005) *Water sanitation and hygiene for populations at risk*, chapter 11. Hermann Editeurs Des Sciences et des Arts, Paris ISBN 2 7056 6499 8



**World Health Organization**

Water, Sanitation,  
Hygiene and Health Unit  
Avenue Appia 20  
1211 Geneva 27  
Switzerland

Telephone: + 41 22 791 2111  
Telephone (direct): + 41 22 791 3555/3590  
Fax (direct): + 41 22 791 4159  
URL: [www.who.int/water\\_sanitation\\_health](http://www.who.int/water_sanitation_health)

Prepared for WHO by WEDC. Author and Series Editor: Bob Reed.

Editorial contributions, design and illustrations by Rod Shaw

Line illustrations courtesy of WEDC / IFRC. Additional graphics by Ken Chatterton.

Water, Engineering and Development Centre Loughborough University Leicestershire LE11 3TU UK  
T: +44 1509 222885 F: +44 1509 211079 E: [wedc@lboro.ac.uk](mailto:wedc@lboro.ac.uk) W: <http://wedc.lboro.ac.uk>

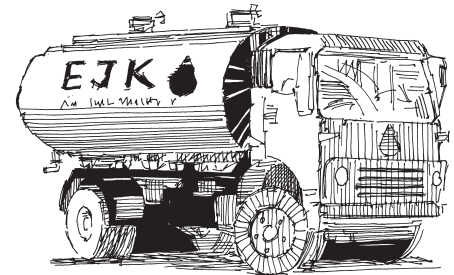
**WEDC**





# Delivering safe water by tanker

Water tankering (also known as water trucking) can be a rapid means of transporting water to areas in need during the initial phase of an emergency. Tankering operations, however, are expensive and relatively time-consuming to administer. This technical note considers key issues relating to the effective and efficient use of tankers during an emergency.



## Types of tanker

Water can be carried in a variety of different containers, some specifically designed for the task and others fabricated to meet an urgent need (see Figures 12.1 and 12.2).

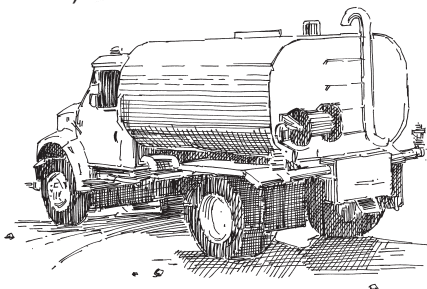


Figure 12.1. A purpose-built tanker

If possible, try to use specially designed water tankers. They will be safer and more reliable. Temporary tankers made from flat bed trucks with portable storage tanks attached can be dangerous if the tank is not securely fastened. The delivery of bottled water may be a short term option, but it is expensive and inefficient. It also produces a major solid waste problem resulting from empty, discarded water bottles.

## Logistics

The number of tankers needed to supply the required quantity of water during an emergency will depend on a variety of factors. In Box 12.1 an

example calculation for the number of tankers required is presented.

Other logistical factors to consider include:

- **Fuel.** Regular supplies are essential. Consider setting up a storage tank if supplies are unreliable.
- **Drivers.** Vehicles are likely to be more reliable if operated by an experienced driver. Always test driving skills before employing drivers and consider providing advanced driving training if necessary.
- **Spare parts.** All vehicles need maintenance and in emergencies this is even more important. Consider purchasing spares in bulk.
- **Maintenance staff.** In remote areas, it may be difficult to find skilled vehicle maintenance staff. You may have to bring them in from elsewhere.

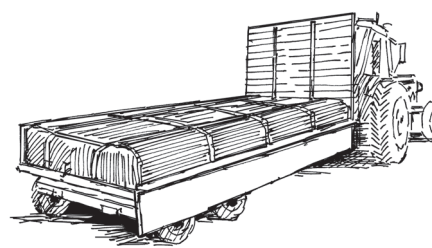


Figure 12.2. An improvised tanker

## Tanker management

Tankering operations can be managed in-house or contracted out. In either case, good planning and supervision will help operations run smoothly.

When contracting out, consider the following:

- Base contract fees on the quantity and quality of water delivered not on operating time.
- Agree on a method for appraising contractor performance.
- Clarify responsibility for consumables such as the provision of fuel, insurance, maintenance, the wages of drivers, etc.

Where tankering operations are run in-house, attention should be given to basic fleet management including vehicle maintenance, fuel supply and the availability of standby vehicles. Driver management can be a particularly difficult task. Drivers may be unreliable and untrustworthy. Always monitor their driving skills and regularly check their record book and compare it with records from fuel suppliers and delivery records. Frequent spot checks are useful, particularly at the start of a tankering programme.



## Operation

### Equipment

Water tanks should be made of stainless steel or other material suitable for the storage of drinking water. The tank should have an access port preferably large enough for a person to enter for cleaning purposes. The access must be covered with a dust-proof lockable cover. There should also be an air-vent with an outlet that is screened to prevent dust, insects, birds and other vermin entering the tank.

Most tankers are fitted with water pumps to speed up loading and

unloading. They should be regularly checked as part of the general vehicle maintenance programme to see if they are operating efficiently. The vehicle may need a safe storage container for fuel for the water pump.

Hoses and related couplings should be stored in a sealed container to protect them from contamination. Vehicles should be equipped with a chlorine testing kit and the driver trained in how to use it.

### Cleaning

Water tanks, and when applicable, pumps must be cleaned before they

## Box 12.2. Tanker record book

The book should record:

- Date
- Driver's name
- Start and finish time
- Start mileage
- Location, time and mileage at point of filling
- Location, time and mileage at point of emptying
- Quantity of water delivered
- Rest periods
- Fuel quantity, date added and mileage
- Maintenance dates
- Signature of customer receiving the water
- Signature of person supplying the water

## Box 12.1. Calculating tankering requirements

A community affected by an earthquake requires 200,000 litres of water a day to be tankered. The water is to be collected from a borehole 10km from the community. Estimate the number of tankers that will be required to deliver the quantity of water required.

### Assumptions

- The capacity of each tanker is 5,000 litres.
- Poor road conditions and old equipment means most vehicles will need to be checked every week and require maintenance about every three weeks.
- A weekly vehicle service takes about 120 minutes.
- A three-weekly vehicle service takes a day.
- Each tanker can work 14 hours per day using two drivers.

### Activity times

Filling the tanker:	20 minutes
Travel time from borehole to community:	30 minutes
Offloading time for tanker:	20 minutes
Return travel time:	30 minutes
Net turnaround time:	100 minutes
Add 30% for unforeseen activities:	30 minutes
Gross turnaround time:	130 minutes

### Calculations

The number of trips each tanker can make a day is:

$$14 \times 60 / 130 = 6.5 \text{ (say 6)}$$

The total volume of water carried by each tanker a day is:

$$5,000 \times 6 = 30,000 \text{ litres}$$

Therefore the number of tankers required to deliver sufficient water is:

$$200,000 / 30,000 = 6.7 \text{ (say 7 tankers)}$$

Assume the weekly service can be fitted in with normal working and has no large-scale effect on water delivery.

The three-weekly service requires the truck to be off the road for at least a day. Allow an extra truck to replace the one being serviced.

So the total number of trucks required is 8.

are used, after major maintenance and at least every three months. Details of cleaning methods are given in Technical Note 3.

## Chlorination

Water in a tanker should be chlorinated to prevent the build-up of organic matter in the tank and to ensure the water delivered is safe to drink. Chlorination usually takes place as the tank is filled with water.

The amount of chlorine to be added will depend on the quality of the water, but sufficient should be added to leave a residual amount of 0.5 mg/l. See Technical Note 11 for more details.

Chlorine levels should also be checked before the water is discharged. If chlorine levels have dropped below 0.2 mg/l, extra chlorine should be added.

## Record-keeping

Each tanker should be provided with a book to record its operation. This will help with the future planning of tankering operations and for checking the efficiency of the vehicle and its drivers. Box 12.2 lists the types of information that should be recorded.

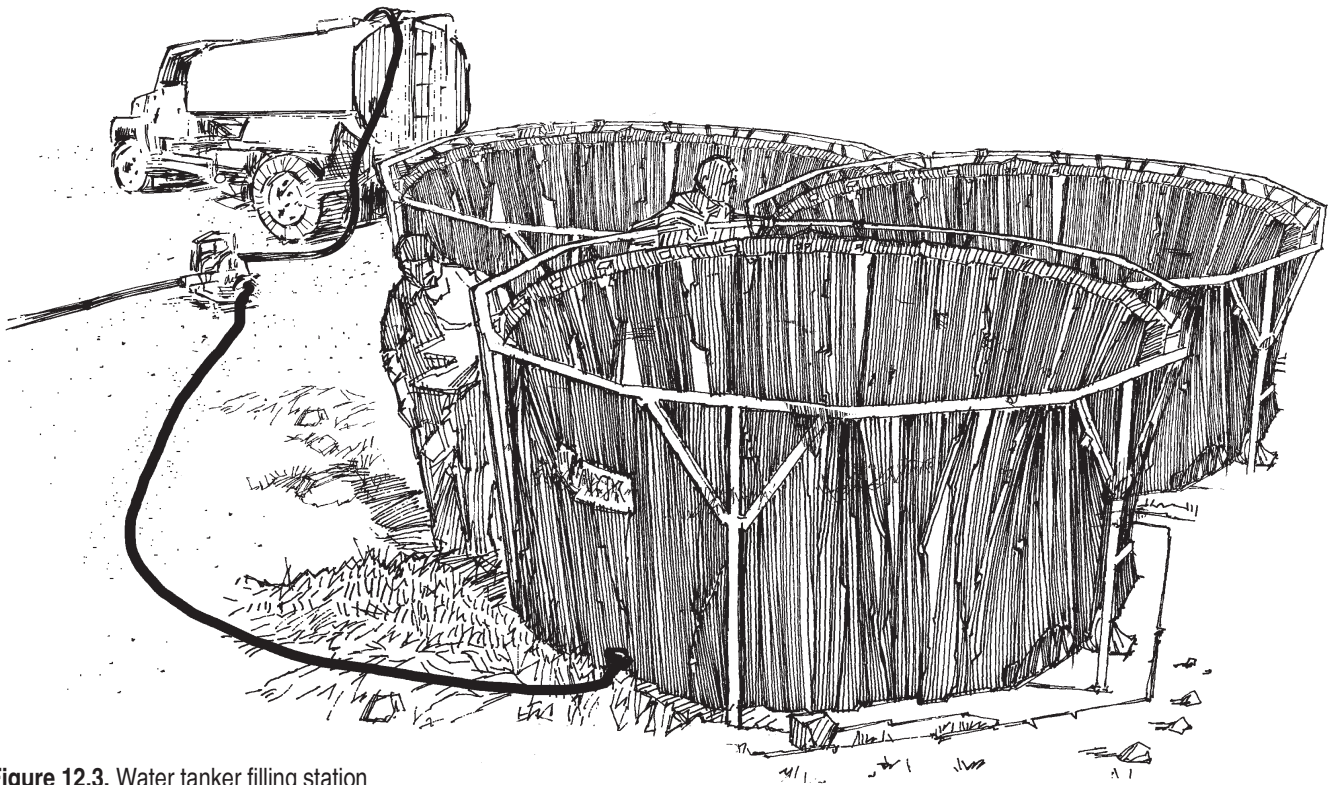


Figure 12.3. Water tanker filling station



Figure 12.4. Road damage caused by water tankers

### Other considerations

#### Filling points

Try to use filling points close to the delivery point. Check that the source has sufficient quantity for your needs and the water quality is acceptable. If the tankering process is expected to last some time, set up a dedicated water filling point (Figure 12.3). Lots of water will be spilt during the filling process so provide good drainage.

#### Access roads

Water tankers are heavy vehicles and can quickly damage poorly constructed roads (see Figure 12.4 on the previous page). Make an assessment of the roads before starting to use them and reinforce them if necessary.

#### Delivery points

Tankering is much more efficient if water can be off-loaded to storage tanks rather than allowing people to collect their water directly from the tanker (Figure 12.5). A storage tank connected to communal tap stands is a common method to use.

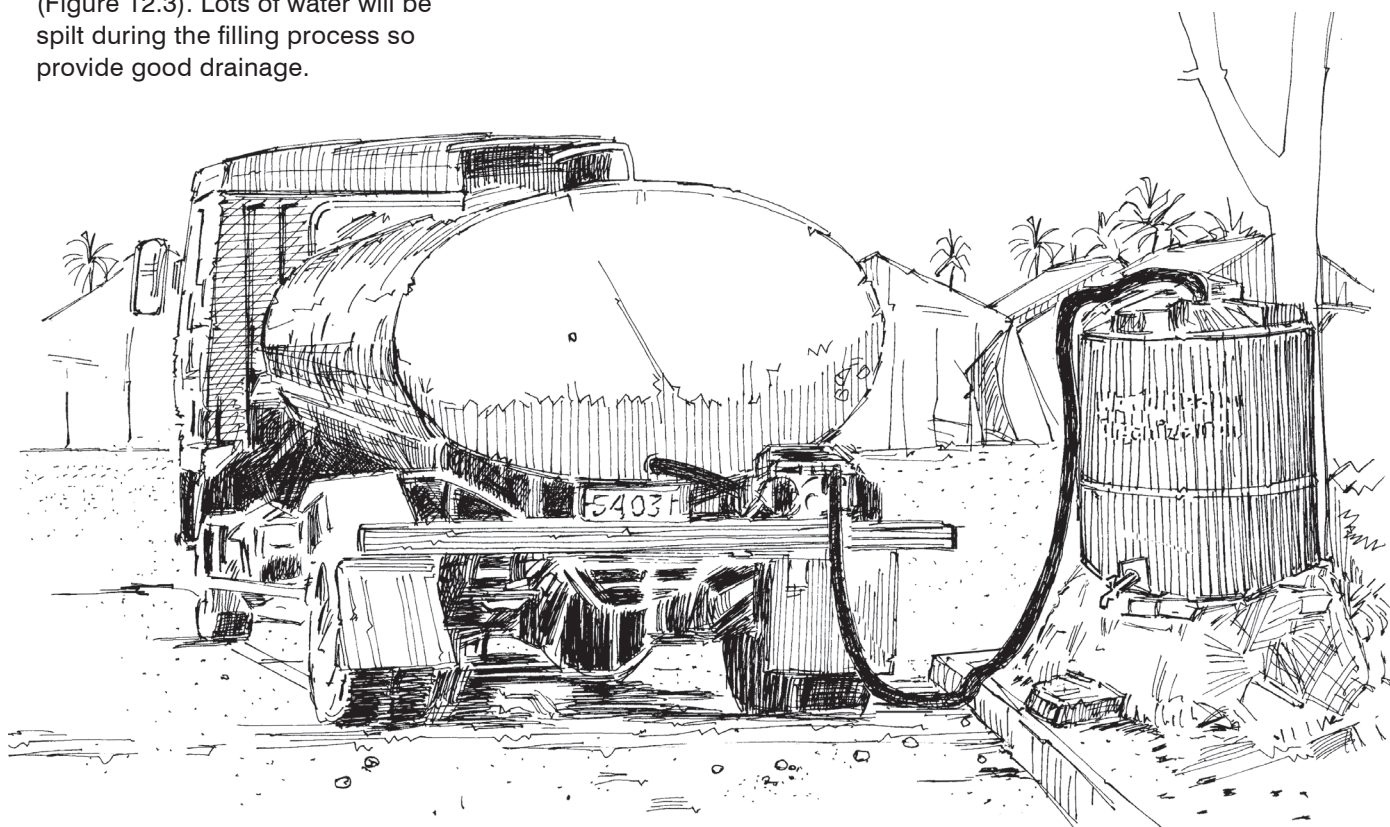


Figure 12.5. Simple storage and distribution point supplied by water tanker.

#### Further information

Davis, J. and Lambert, R. (2002) *Engineering in Emergencies A practical guide for relief workers*, 2nd edition, ITDG Publishing, UK.

Potable Water Hauler Guidelines, <http://www.hamilton.ca/NR/rdonlyres/3C2443DF-80FA-4708-8486-5F6935246FD1/0/Apr10PH06012WaterHaulerInspectionProgram.pdf>



**World Health Organization**

Water, Sanitation,  
Hygiene and Health Unit  
Avenue Appia 20  
1211 Geneva 27  
Switzerland

Telephone: + 41 22 791 2111  
Telephone (direct): + 41 22 791 3555/3590  
Fax (direct): + 41 22 791 4159  
URL: [www.who.int/water\\_sanitation\\_health](http://www.who.int/water_sanitation_health)

Prepared for WHO by WEDC. Author and Series Editor: Bob Reed.  
Editorial contributions, design and illustrations by Rod Shaw  
Line illustrations courtesy of WEDC / IFRC. Additional graphics by Ken Chatterton.

Water, Engineering and Development Centre Loughborough University Leicestershire LE11 3TU UK  
T: +44 1509 222885 F: +44 1509 211079 E: [wedc@lboro.ac.uk](mailto:wedc@lboro.ac.uk) W: <http://wedc.lboro.ac.uk>

**WEDC**





# Planning for excreta disposal in emergencies

The pressure to help people immediately after a disaster often leads to actions starting before they have been properly planned. Experience shows that this results in a waste of resources and in poor service delivery; it seldom leaves long-term benefits for the affected community. Among other issues, this is the case for emergency disposal. This Technical Note is a guide to the *planning process* of excreta disposal during the first two phases of an emergency. Technical options are presented in Technical Note 14.



## Phases in an emergency

There are three phases in an emergency:

- Immediate emergency
- Stabilization
- Recovery

### Immediate emergency

In this phase, mortality rates can be high and there may be a risk of a major epidemic. The phase usually lasts for the emergency period and a few weeks beyond. The main objective for an excreta disposal programme is to minimize contamination related to high-risk practices and reduce exposure and faecal-oral disease transmission. Interventions are usually rapid and designed for the short term.

### Stabilization

During this period more sustainable interventions can be implemented for longer-term use. Typically, community structures are re-established and death rates start to fall. However, the risk of epidemics may still be high. This phase can last from several months to many years, depending on the complexity of the emergency.

## Stages in planning

Figure 13.1 shows the main stages for planning emergency excreta disposal. A common complaint about planning processes is that they take too long, but this is not necessarily the case as Figure 13.1 suggests. The figure shows the approximate time required for each stage for an affected population of about 10,000.

### Rapid assessment

Interventions are only necessary if there is an expressed and measurable real need for them. This stage aims to rapidly collect and analyse key information to assess if an intervention is indeed necessary.

### Data collection

The data required to assess the problems and needs of the affected population must be collected quickly but in sufficient detail to provide enough information for analysis. In Box 13.1 a checklist of twenty key questions is presented, to be answered in order to complete the assessment procedure. Information thus collected will support informed decision-making on the further course of action.

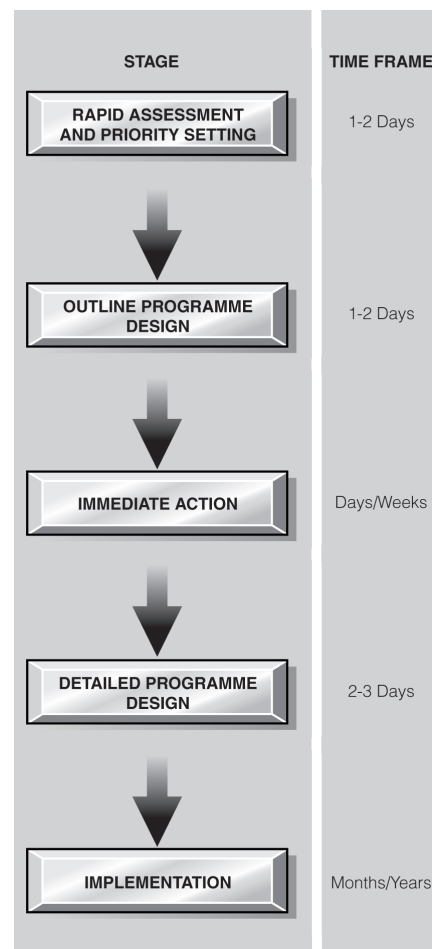


Figure 13.1. Stages in emergency sanitation programme design



The usefulness of the information collected will depend as much on how it is collected as on the quality of the questions asked. Even under normal circumstances, the information presented cannot always be trusted. In the chaotic circumstances of an emergency there is even more reason to doubt the validity of information provided.

Follow the principles listed in Box 13.2 to ensure that the data you produce are as accurate as possible.

### Community participation

Like any other people, those affected by an emergency have views and opinions. There is no reason to treat them any differently than other communities – except to make allowances for the trauma they have experienced.

Involving communities in the planning and design process is beneficial to their recovery as it promotes self-respect and

### Box 13.1. Twenty questions for rapid assessment

1. What is the estimated population and what is the population density?
2. What is the crude mortality rate (number of deaths per 10,000 people per day) and what are the main causes of mortality and morbidity?
3. What are the current beliefs and traditions concerning excreta disposal, especially regarding women and children's excreta? (Do men and women or all family members share latrines, can women be seen walking to a latrine, do children use potties, is children's excreta thought to be safe?)
4. What are the prevailing practices for anal cleansing? Are water or cleansing materials available?
5. Is soap available?
6. Are there any existing sanitation facilities? If so are they useable and used, are they sufficient and are they operating successfully? Can they be extended or adapted? Do all groups have equal access to these facilities?
7. Are the current defecation practices a threat to health? If so, how?
8. What is the current level of awareness of sanitation-related public health risks?
9. Are there any health promotion activities taking place?
10. What health promotion media are available/accessible to the affected population?
11. Are men, women and children prepared to use defecation fields, communal latrines or family latrines? Are disabled people and the elderly able to use these facilities?
12. Is there sufficient space for defecation fields or pit latrines?
13. What is the topography and drainage pattern of the area?
14. What is the depth and permeability of the soil, and can it be dug easily by hand?
15. What is the level of the groundwater table?
16. What local materials are available for constructing latrines?
17. Are there any people familiar with the construction of latrines?
18. How do women deal with menstruation? Are there materials or facilities they need for this?
19. When does the seasonal rainfall occur?
20. Whose role is it normally to construct, pay for, maintain and clean a latrine (men, women or both)?

Source: Adapted from Harvey et al., 2006

### Box 13.2. Data collection principles

The main things to remember when collecting data about an emergency are:

- Collect data from as many sources as possible to reduce bias and inaccuracies.
- Be aware of local political and social structures so as not to raise unrealistic expectations.
- Consider the effects of the data you collect on your decisions.
- Keep good records of what you have learned and from whom.
- Remember that situations change rapidly in an emergency and things may not be the same tomorrow as they are today.
- Hire a good interpreter if you are working with people who speak a different language to your own.

continued self-reliance. The affected community should be involved as soon as the decision to intervene has been made.

### Who should get involved?

External organizations should only get involved if the affected institutions and population are unable to deal with the situation themselves and if the health of the population is getting (or is likely to get) worse (Figure 13.2). Tables 13.1 and 13.2 present health data that will assist in deciding whether or not to intervene.

### Sphere Guidelines

Once a decision has been made to intervene the next step is to decide what to do. In emergencies, the normal methods of making decisions about which facilities to provide do not apply. Instead, a

**Table 13.1.** Suggested maximum infection rates for displaced people

Disease	Incidence rate (in cases/10,000/week)
Diarrhoeal diseases total	60
Acute watery diarrhoea	50
Bloody diarrhoea	20
Cholera	In some countries cholera is classified as 'acute watery diarrhoea' and if this is the case should be acted upon as if it were cholera

Source: After de Veer (1998)

**Table 13.2.** Crude mortality rates in emergencies

Crude mortality rate (CMR) Deaths/10,000/week	Severity of emergency
Up to 3.5	'Normal' or non-emergency rate
More than 3.5 and less than 7	Stable and under control
7 to 14	Serious situation
15 to 35	Emergency / Out of control
More than 35	Catastrophic

Source: After Davis & Lambert (2002)

**Table 13.3.** Indicators for minimum service levels for excreta disposal

Indicator	Immediate emergency	Stabilization phase
Coverage	50 people per latrine cubicle	20 people per cubicle
	The ratio of female to male cubicles should be 3:1	
Location	Less than 50m one way walking distance	Less than 25m one way walking distance
	At least 6m from a dwelling	At least 6m from a dwelling
Privacy and security	Doors should be lockable from the inside Latrines to be illuminated at night where necessary Provision made for the washing and drying of menstruation cloths where necessary	
Hygiene	Handwashing facilities with soap to be supplied near to all toilets Appropriate materials for anal cleansing to be provided	
Vulnerable groups	Adequate latrines should be accessible to disabled people, the elderly, the chronically sick and children	

Source: Based on Sphere (2004)

set of internationally-recognised standards are used to ensure that the services provided to people in distress are broadly the same around the world. Table 13.3 sets out indicators for emergency excreta disposal. A comparison of existing facilities with those presented in Table 13.3 will indicate whether any additional work needs to be done and whether it is urgent.

## Outline design

This stage develops an outline plan for what should be done, when and how. The plan contains sufficient

information for senior officials to decide whether action should be taken and to allocate resources. The design should include the following sections:

- **Goal:** The ultimate aim of all the interventions in the emergency (i.e. sustaining life and protecting health). This will usually be stated in an organization's charter.
- **Purpose:** What will be achieved by the proposed intervention (e.g. access to and use of hygienic latrines by the whole population).

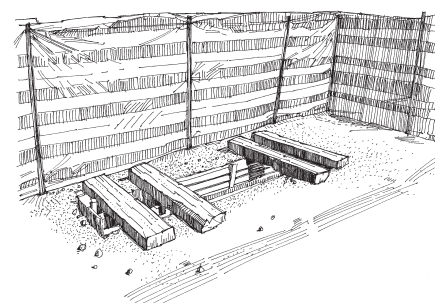


**Figure 13.2.** The worsening health of the population is a reason for external organizations to get involved

- **Outputs:** What the actions will actually produce, such as a number of latrines constructed, the maintenance system established, or the changes in hygiene practices brought about.
- **Activities:** The actions carried out to achieve the outputs, such as purchasing materials, training staff, discussions with the community etc., with a timetable.
- **Inputs:** The resources needed to complete the work, namely: money, tools, equipment, materials and labour.

## Immediate action

At times, the health threat is so great that something must be done immediately to prevent widespread disease and death. Immediate actions will be targeted at providing a quick response to an urgent situation (Figure 13.3), while time is dedicated to consider, design and approve a more sustainable solution (the outline design).



**Figure 13.3.** A simple trench latrine: an immediate action to an urgent situation

# ▶ Planning for excreta disposal in emergencies

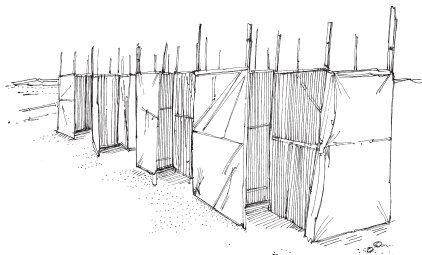
## Detailed plan

Once the outline design has been approved, a detailed activity plan must be drawn up prior to implementation. This process is the same as for any other sanitation project except that it must remain flexible in case the emergency situation changes or worsens. Figure 13.4 shows an example of an action plan for waste management improvements at a medical centre.

## Implementation

Following detailed design, the implementation of the longer-term programme can commence. This should include specifications, implementation and management for:

- construction;
- hygiene promotion;
- operation and maintenance;
- contingency planning (what to do if a major change happens); and
- monitoring and evaluation.



Area/time frame	Action	Facilitator
<b>Waste management at medical centres</b>		
Immediate	<ul style="list-style-type: none"> <li>■ Provide uniform and labelled plastic containers with lids for medical waste.</li> <li>■ Provide uniform and labelled plastic bins for general waste.</li> <li>■ Collect small plastic medicine containers, glue lids on, make slots, and label for disposal of sharps.</li> <li>■ Provide uniform and labelled plastic bins for disposal of glassware.</li> <li>■ Fill existing pit near health post and dig new pit with cover approx. 50m from health post and OPD.</li> <li>■ Construct sealed sharps pit with restrictive entrance for disposal of sharps containers and glassware only.</li> <li>■ Dispose of existing sharps containers in pit.</li> <li>■ Locate burner next to general pit and use for medical waste (excluding sharps) only.</li> <li>■ Train all health staff in new procedures</li> <li>■ Train cleaning staff in importance of collection, transportation and disposal procedures.</li> </ul>	<ul style="list-style-type: none"> <li>■ MSF Sanitation and Health teams</li> </ul>
Long-term	<ul style="list-style-type: none"> <li>■ Monitor use and seal and replace pit for general waste and pit for sharps when required.</li> <li>■ Monitor and manage use of placenta burial ground to ensure adequate burial and systematic use of area.</li> <li>■ Monitor consistency of and advise on waste management procedures at all medical facilities (IPD, OPD and CTC).</li> </ul>	<ul style="list-style-type: none"> <li>■ MSF Sanitation team</li> </ul>

Activity	Week starting							
	26/3	2/4	9/4	16/4	23/4	30/4	7/5	14/5
Excavate general waste pit		MSF Sanitation						
Construct sharps pit		MSF Sanitation						
Install burner		MSF Sanitation						
Fill and cover old pit		MSF Sanitation						
Train staff in final disposal			MSF Sanitation					
Provide bins and containers				MSF Logistics/Health				
Train health and cleaning staff					MSF Health			
Monitor systems			MSF Sanitation					

**Figure 13.4.** Action plan for waste management improvements at a medical centre undertaken by Médecins Sans Frontières (MSF)

## Further information

Harvey, P., Baghri, S. and Reed (2002) *Emergency Sanitation: Assessment and programme design*, WEDC, Loughborough University, UK.

SPHERE (2004) *Humanitarian Charter and Minimum Standards in Disaster Response*. The Sphere Project: Geneva, Switzerland (Distributed worldwide by Oxfam GB) <http://www.sphereproject.org/>

Harvey, P. (2007) *Excreta disposal in emergencies – a*

*field manual*. WEDC, Loughborough University, UK <http://wedc.lboro.ac.uk/publications/>

Ferron, S., Morgan, J. and O'Reilly, M. (2007) *Hygiene Promotion: a practical guide for relief and development*, Practical Action, Rugby, UK.

*Potable Water Hauler Guidelines*, <http://www.hamilton.ca/NR/rdonlyres/3C2443DF-80FA-4708-8486-5F6935246FD1/0/Apr10PH06012WaterHaulerInspectionProgram.pdf>



**World Health Organization**

Water, Sanitation, Hygiene and Health Unit  
Avenue Appia 20  
1211 Geneva 27  
Switzerland

Telephone: + 41 22 791 2111  
Telephone (direct): + 41 22 791 3555/3590  
Fax (direct): + 41 22 791 4159  
URL: [www.who.int/water\\_sanitation\\_health](http://www.who.int/water_sanitation_health)

Prepared for WHO by WEDC. Author and Series Editor: Bob Reed.

Editorial contributions, design and illustrations by Rod Shaw

Line illustrations courtesy of WEDC / IFRC. Additional graphics by Ken Chatterton.

Water, Engineering and Development Centre Loughborough University Leicestershire LE11 3TU UK  
T: +44 1509 222885 F: +44 1509 211079 E: [wedc@lboro.ac.uk](mailto:wedc@lboro.ac.uk) W: <http://wedc.lboro.ac.uk>





# Technical options for excreta disposal in emergencies

Sanitation is the efficient disposal of excreta, urine, refuse, and sillage. Initially, indiscriminate defecation is usually the main health hazard in refugee camps. This technical note outlines ways in which excreta and urine can be managed during the early stages of an emergency, while long-term solutions are devised. (See Technical Note 7 for guidance on managing solid waste.) The technical options for emergency excreta disposal are limited and simple. If they are to work, however, they must be properly managed and be understood and supported by the community.



## Immediate measures

The immediate tasks after a disaster are as follows:

- **Obtain the services of a good translator.** Effective sanitation provision has more to do with views and opinions of the user population than the technology. It is very important to have a good relationship with users, and that requires the skills of a competent translator.
- **Consult with all interested parties** including representatives of the affected population, aid agencies and government officials.
- **Survey the site** to gather information on existing sanitation facilities (if any), the site layout, population clusters, topography, ground conditions, and available construction materials.
- **Prevent indiscriminate defecation.** Especially prevent defecation in areas likely to contaminate the food chain or water supplies.
- **Select areas where defecation may safely be allowed.**

## Managing open defecation

People affected by a disaster still need to defecate! They will attempt to follow traditional practices, but if that is not possible they will defecate wherever they can. Your first task is to prevent excreta contaminating water supplies or the food chain, so you must prevent defecation in areas such as:

- **the banks of rivers, streams, or ponds** which may be used as a water source (and if water is to be abstracted from shallow wells, then it is important to ensure that these wells are situated upstream of the defecation areas); or
- **agricultural land** planted with crops, particularly if the crops are soon to be handled or harvested for human consumption.



Figure 14.1. Prevent open defecation in areas planted with crops

Keeping people away from specific areas is not easy, particularly where traditional habits make such practices common. It may be necessary to construct a physical barrier, such as a fence, or to set up patrols to keep people away. This approach can only be very temporary. Move as quickly as possible to provide appropriate excreta disposal facilities and encourage people to use them.

## Defecation fields

These should be located so that they are easily reached by the community but do not pollute water supplies or sources of food. It is better to provide a number of small fields equally spread around the affected population as this will reduce the walking distance for most users. It will also allow for flexibility of operation and the separation of men and boys from women and girls.

The defecation field should be screened and divided into small strips so that a different strip can be used each day. The area of the field farthest from the community should be used first, so that people do not have to walk across contaminated



ground to reach the designated area (Figure 14.2). They can be improved by digging shallow trenches along the centre of each strip and piling the excavated soil to one side. Users are encouraged to defecate in the trench and then cover their waste with the soil piled beside it.

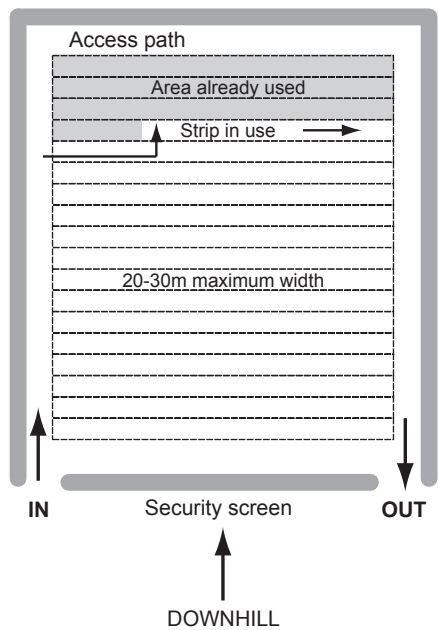


Figure 14.2. Plan of a defecation field

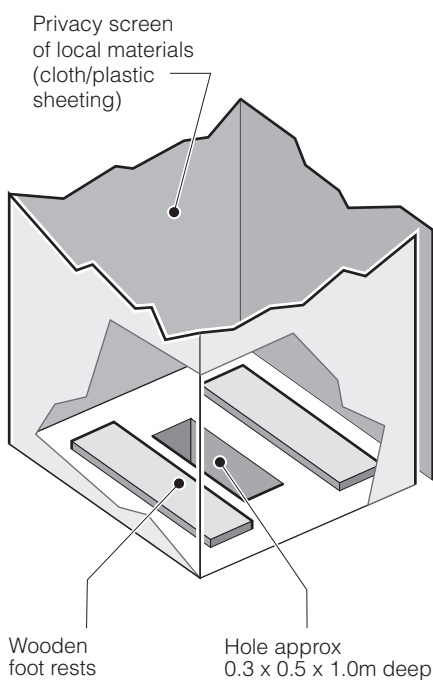


Figure 14.3. A shallow family latrine

Defecation fields have a short life and are difficult to manage. They should be replaced with more sustainable solutions as soon as possible.

### Shallow family latrines

Providing each family with its own latrine has many advantages. However in certain areas, sharing of latrines among relatives living in several households, has proven effective in protecting health and maximizes use of scarce resources. In the first few days of an emergency, this can be a simple structure such as shown in Figure 14.3. A key advantage is that providing the affected community with tools to build and maintain the latrines is practically the only input required.

If family latrines are not possible (for example, because of the lack of space) then some form of communal latrines will have to be provided.

### Shallow trench latrines

Trenches around 0.2m to 0.3m wide, 1.5m deep and 4.0m long are surrounded by a temporary screen (Figure 14.4). Users defecate by squatting across the trench. After use, users cover their faeces with some of the soil dug out of the

trench using the spade provided. If the ground is wet or soft, a piece of wood can be laid along each side of the trench. Some trenches should be dug narrower so that they can be used by small children and the elderly.

Shallow trench latrines can quickly become smelly, especially in hot and humid climates. All faeces must be covered at least once a day and trenches closed when the contents reach 0.3m from the ground surface.

### Deep trench latrines

A trench 0.8m to 0.9m wide, 6.0m long and at least 2.0m deep is covered by a wooden or plastic floor and divided into six cubicles (Figure 14.5). The top 0.5m of the trench walls should be lined with plastic sheeting for ease of cleaning and to prevent the sides from collapsing. The cubicles and privacy screen can be made of plastic sheeting on a light wooden frame. A roof can be provided if necessary. A drainage ditch should be dug around the latrine to divert surface water.

Each day the contents of the trench are covered by a layer of soil approximately 0.1m deep. This will reduce the smell and prevent flies from breeding in the trench.

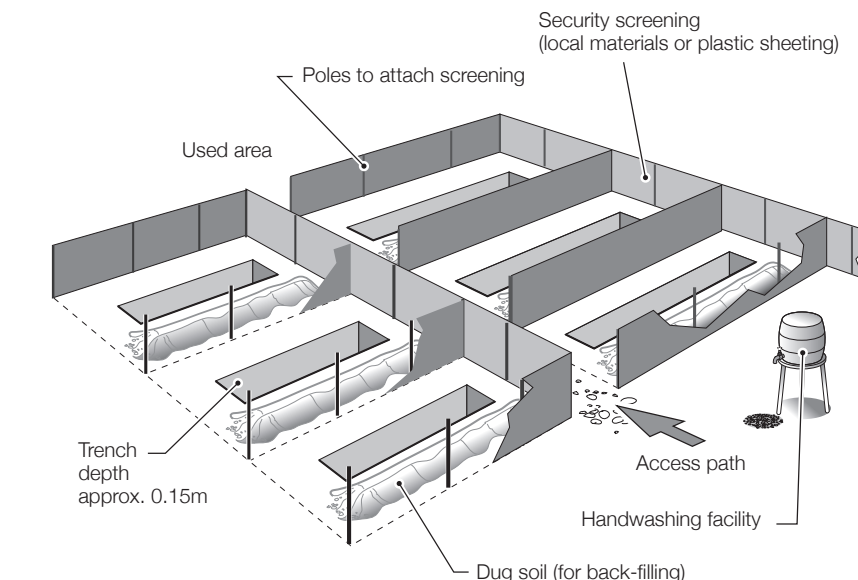
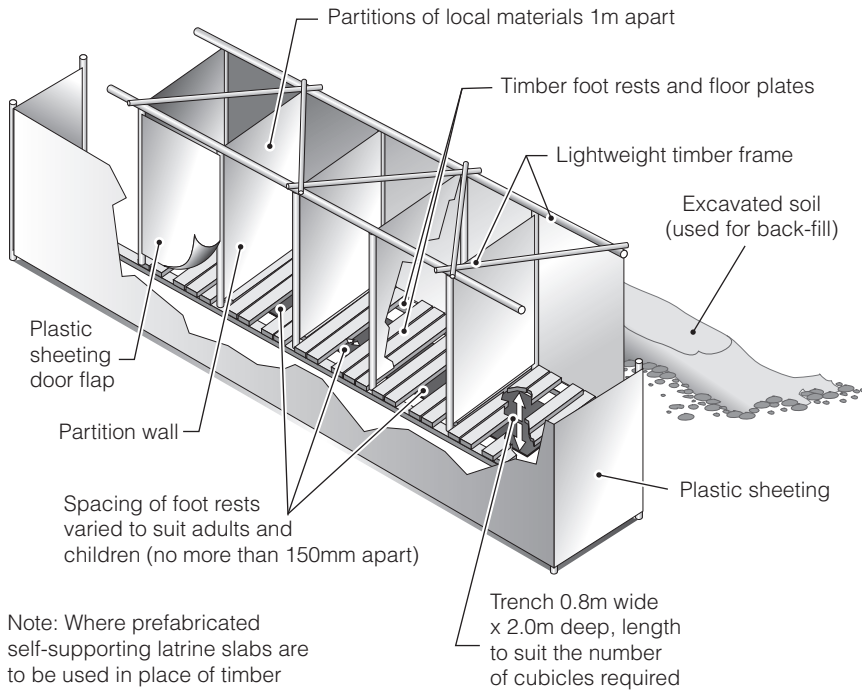


Figure 14.4. Trench defecation fields



Note: Where prefabricated self-supporting latrine slabs are to be used in place of timber cubicle sizes may need to be adjusted to fit slab width (e.g. 0.8m)

**Figure 14.5.** Deep trench latrines

When the bottom of the trench has risen to within 0.3m of the surface, the trench is filled with soil and the latrine is closed.

A trench latrine system is very labour-intensive and requires constant supervision. Not only must the contents of each latrine be covered each day, but new latrines must be prepared, old ones filled in, and regularly-used latrines must be cleaned. Close supervision is essential. A poorly-maintained latrine will quickly become offensive to the community and will not be used.

## Making use of existing facilities

In urban areas, it may be possible to make use of existing facilities such as sewers, public toilets, bucket latrines, or stormwater drains. Temporary latrines, such as the one shown in Figure 14.6, can be constructed over a sewer or drain. Additional water may be required to carry the wastes through the system.

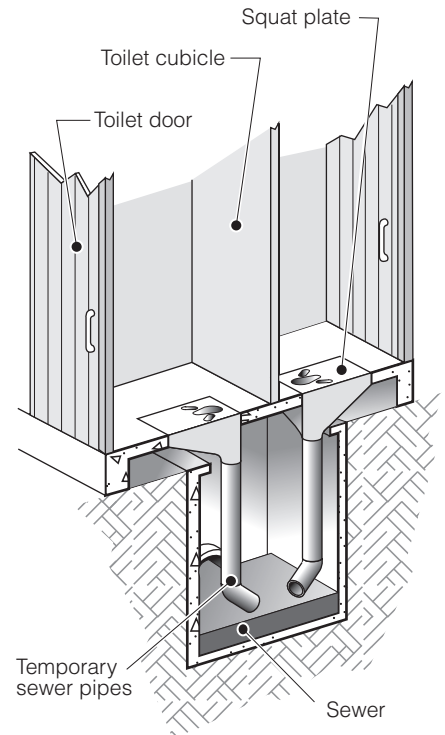
## Mobile latrine blocks

In Europe and North America, mobile latrine blocks are common. Typically, these contain a number of toilet cubicles, sometimes provided with urinals and handwashing facilities. A tank is provided for clean water and another to collect waste. The waste tank is emptied using a portable vacuum tanker.

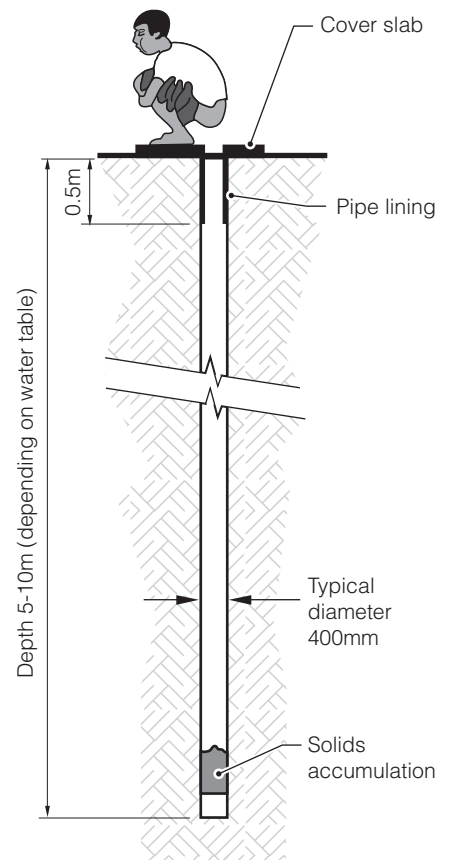
The deployment of mobile latrine blocks is not limited to industrialized countries. Provision for the ultimate disposal of the waste must, however, be part of their deployment.

## Borehole latrines

In areas with deep soil, many borehole latrines can be built in a short time using hand augers. The holes are usually 0.3m to 0.5m in diameter and 2.0m to 5.0m deep (Figure 14.7). The top of each hole is lined with a pipe, and two pieces of wood are provided for footrests. Borehole latrines should be closed when the contents are 0.5m from the surface.



**Figure 14.6.** Temporary toilet over a sewer



Note: Some soil conditions may require a pipe lining greater than 0.5m

**Figure 14.7.** A borehole latrine

## Packet and plastic bags

If the affected population is on the move, or if it is not possible to construct any form of latrine (such as in a flooded area), a simple plastic bag may be the only disposal option. The bags should be strong, water-tight and have a sealable top. Users should defecate directly into the bag and then seal it. The bags need to be collected regularly and taken away for burial. Biodegradable bags are preferred for their limited impact on the environment.

## Chemical toilets

Portable chemical toilets have been used in emergencies in South and Central America. Typically, they are light-weight portable cubicles fitted with toilet seats with sealed holding tanks below. To reduce the smell, the tank is partially-filled with chemicals before use. The holding tank must be emptied regularly.

## Overhung latrines

If no other options are available, overhung latrines are an option in flood situations as long as water is flowing. A simple wooden structure, either built over the water (Figure 14.8) or floating on the water, allows users to defecate directly into the flowing water. This is rarely a major health problem as the volumes of water involved are large. Attention should be given to whether or not there are agriculture fields

nearby or use of the flowing water as a drinking-water source. In both instances overhung latrines may increase human health risks.

## Raised latrines

If the ground is rocky or the water table is high, many of the options described will be unsuitable because they depend on deep pits. An alternative is to raise the pit above ground level (Figure 14.9).

The walls of the pit can be extended above ground level using local materials such as wood, bamboo or stone. The lining is then surrounded by a bank of soil to prevent it collapsing and to support the toilet cubicle. In practice, it is normally only possible to raise latrines about 1 to 1.5m above ground level. Higher latrines are rarely acceptable to users.

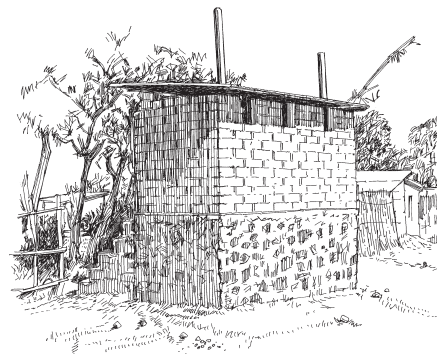


Figure 14.9. A raised latrine

## Long-term solutions

Most of the options in this note are only temporary. As soon as it becomes obvious that the community is likely to remain in their new location for any length of time then longer-term solutions should be sought. In most cases, some form of on-site sanitation will be most appropriate. Details of the design and construction of longer-term options are given in the references below.

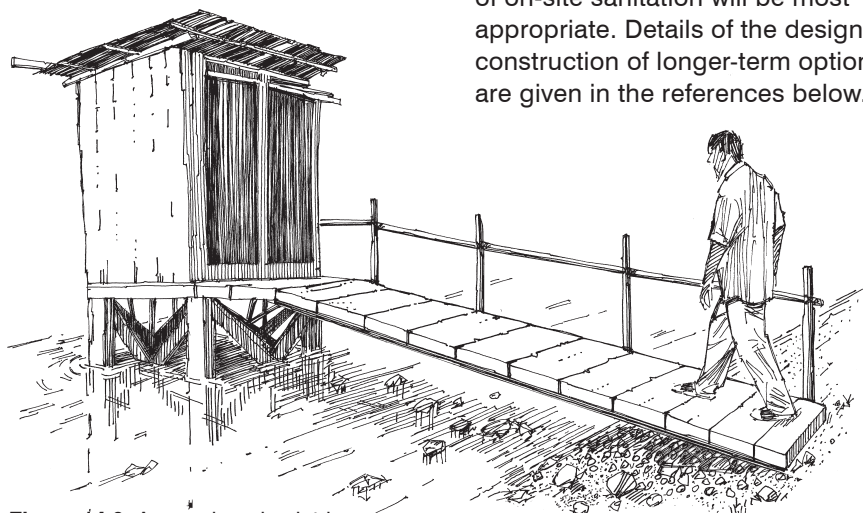


Figure 14.8. An overhanging latrine

## Further information

Harvey, P., Baghri, S. and Reed (2002) *Emergency Sanitation: Assessment and programme design*, WEDC, Loughborough University, UK.

Harvey, P. (2007) *Excreta disposal in emergencies – a field manual*. WEDC, Loughborough University, UK <http://wedc.lboro.ac.uk/publications/>



**World Health Organization**

Water, Sanitation,  
Hygiene and Health Unit  
Avenue Appia 20  
1211 Geneva 27  
Switzerland

Telephone: + 41 22 791 2111  
Telephone (direct): + 41 22 791 3555/3590  
Fax (direct): + 41 22 791 4159  
URL: [www.who.int/water\\_sanitation\\_health](http://www.who.int/water_sanitation_health)

Prepared for WHO by WEDC. Author and Series Editor: Bob Reed.  
Editorial contributions, design and illustrations by Rod Shaw  
Line illustrations courtesy of WEDC / IFRC. Additional graphics by Ken Chatterton.

Water, Engineering and Development Centre Loughborough University Leicestershire LE11 3TU UK  
T: +44 1509 222885 F: +44 1509 211079 E: [wedc@lboro.ac.uk](mailto:wedc@lboro.ac.uk) W: <http://wedc.lboro.ac.uk>







# Cleaning wells after seawater flooding

Many people living in coastal regions rely on shallow groundwater for their water supply. Seawater flooding after a severe storm or tsunami can damage wells and contaminate the groundwater. This technical note provides advice for rehabilitating wells in such circumstances. It should be used in conjunction with Technical Note 1 which provides general information about rehabilitating wells after a disaster.

## Rehabilitation and cleaning of wells

The aims of cleaning shallow open domestic wells after a natural saltwater flooding event are to:

- facilitate provision of safe unpolluted water for drinking and other domestic purposes;
- minimize the potential for irreversible damage to the coastal aquifer;
- minimize the potential for saltwater intrusion (drawing saltwater into the well); and
- minimize the collapse or destruction of the well.

Figure 15.1 outlines a simple three-step procedure for cleaning and rehabilitating saltwater-contaminated shallow open wells in emergencies.

### Step 1: Removing debris and excess salinity

As soon as possible after the flooding event the following actions should be taken:

1. Remove debris, waste and polluted water pools close to the well (Figure 15.2).

2. If the well has been damaged, and shows cracks in the walls or apron or if it has been undermined by erosion, the well should be abandoned, replaced, or rehabilitated (Figure 15.3).
3. Remove floating debris inside the well manually, using a sieve or bucket (Figure 15.4).
4. Use a sludge pump to remove sludge and loose sediment that has accumulated at the bottom of the well.

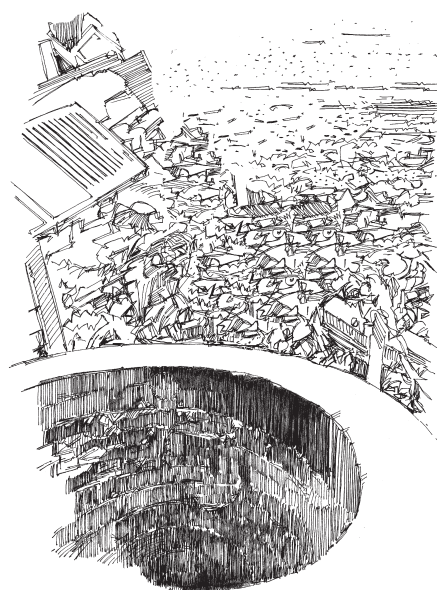


Figure 15.2. Remove debris and waste close to the well

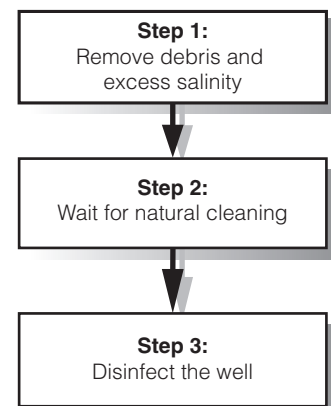
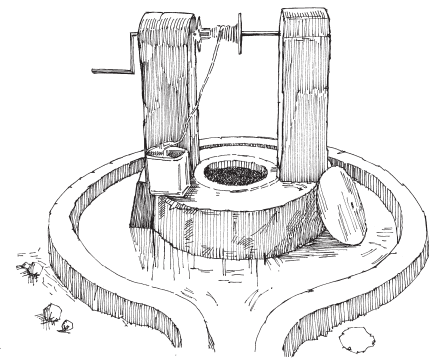


Figure 15.1. Steps for cleaning a saltwater-contaminated well

The well should not be pumped out repeatedly in an attempt to lower the salinity.

If the well smells of oil or petrol or has a greasy film or shine on the surface, the well should not be used.

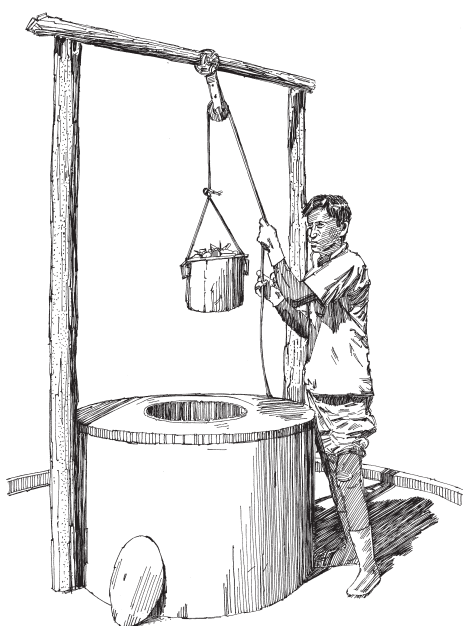
5. Calculate the volume of water in the well (Box 15.1). Slowly remove the water using a pump or bucket (Box 15.2) taking care not to pump so quickly that the well empties. Pumped water should be discharged to



the sea, or alternatively into a nearby river or stream. Construct a drainage canal downstream of other freshwater wells to avoid recirculation of the contaminated water. At this point, the well water may become unclear for up to a day, after which the well water can be used for household purposes, *but not for drinking*.



**Figure 15.3.**  
A damaged well, showing cracks in the walls



**Figure 15.4.**  
Removing debris using the bucket

### Step 2: Natural cleaning

Leave the well without further intensive pumping until the salinity drops to a level acceptable for drinking. This level should be based on the judgement and preference of the community and not on strict water quality standards.

The period required for natural restoration of freshwater conditions may be long, depending on rainfall conditions and subsurface characteristics. It could be as long as one to two years.

In the interim period, the well may be used for domestic purposes, such as washing and cleaning, but other sources of water for drinking should be sought.

### Step 3: Disinfection

When the salinity of the well water has reached tolerable levels for drinking, the well should be disinfected.

WHO endorses the disinfection of drinking water in emergency situations. There are various ways of doing this but the most common is chlorination as it leaves a residual disinfectant in the water.

Chlorine has the advantage of being widely available, simple to measure and use, and it dissolves easily in water. Its disadvantages are that it is a hazardous substance (to be handled with care) and that at commonly applied concentrations it is not effective against all pathogens (e.g. cysts and viruses).

The chlorine compound most commonly used is high-strength calcium hypochlorite (HSCH) in powder or granular form as it contains 60 to 80% chlorine. Also used is sodium hypochlorite in liquid bleach or bleaching powder form. Each chlorine compound has a different amount of usable chlorine depending on the quantity of time the product has been stored

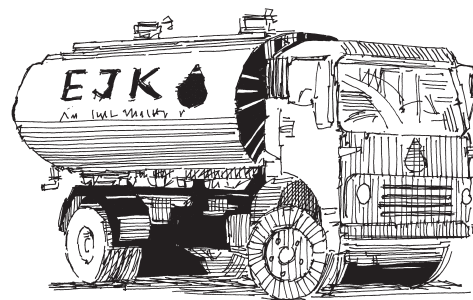
or exposed to the atmosphere and the way it is made. Technical Note 1, Box 1.2 outlines methods for calculating appropriate chlorine doses for HSCH granule chlorine. Stir the water in the well thoroughly with a long pole and then allow the water to stand for at least 30 minutes. Further details on chlorination are given in Technical Note 11.

### Precautions

Repeated chlorination of wells should be avoided as chlorine residual may contaminate the aquifer and present health problems, such as skin rashes when the water is used for bathing. Permanent disinfection of the well water cannot be guaranteed by chlorination because a background source of contamination may exist in the surrounding groundwater.

### Use of alternative drinking-water sources

It is important to consider carefully the switch from using a well to other drinking-water sources during a flooding event. It may be a better solution to have people use slightly saline but disinfected well water rather than freshwater from unprotected sources. It is important to convey the message to consumers that salinity is not a threat to health if the taste is tolerable. In the short-term, freshwater can be imported by tanker (Figure 15.5) whilst care is taken to properly and consistently disinfect an alternative water supply.



**Figure 15.5.**  
Water tankering (see Note 12)

## Protection of groundwater

After seawater flooding, it is important to avoid further saltwater intrusion into freshwater sources. Some simple precautions include the following:

- Wells that were clear but are becoming salty should be pumped less or abandoned temporarily. Freshwater should be sought from neighbouring wells that are clear.
- Intensive pumping should be avoided as it may cause the well to become saline. Similarly, new high-production wells should be dug away from the coast and other sources of pollution.
- Deep wells (greater than 5m deep) and wells pumped with motorized pumps should be regularly monitored for salinity as they stand a greater risk of pollution from saline water.
- Existing wells should not be deepened and new deep wells (over 10m) should not be dug in coastal areas with the intention to draw freshwater from an underlying aquifer.
- Stagnant water bodies close to the wells should be kept clean of debris. If pollution is suspected from, for example, the observation of an oil film on the surface of the water, then the water should be drained to the sea.
- In other cases, stagnant water should not be drained in an attempt to remove the salt. Rather, channel rainwater to depressions in order to increase the flushing and cleaning of the groundwater.
- In some parts of the world, certain anopheline mosquito vectors of malaria prefer to breed in brackish water. The assumption that standing brackish water poses no malaria risks is therefore incorrect.

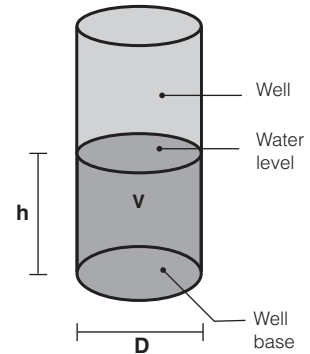
### Box 15.1. Calculating the volume of water in the well

Calculate the volume of water in the well using the formula:

$$V = \frac{\pi D^2 h}{4}$$

Where

- V = volume of water in the well (m<sup>3</sup>)  
 D = diameter of the well (m)  
 h = depth of water (m)  
 π = 3.142



### Box 15.2. Over-pumping of well

When a coastal area is flooded, wells and surroundings are penetrated by saltwater. Pumping out a well alone does not solve the problem, as saltwater is also present in the soil and aquifers below. The best and quickest remedy for restoring the well to its previous condition is natural flushing from rainfall and from freshwater infiltration into the ground from natural or constructed freshwater ponds, dams or other retained sources of rainwater.

Excessive pumping (more than the total volume of water in the well) exacerbates the salinity problem by slowing down natural rehabilitation. It also wastes time, human resources and energy.

### Box 15.3. Health aspects of salinity in drinking water

Salt in drinking-water is not a risk to human health at the level that people normally find it acceptable to drink. As such, there are no health-based guidelines or standards to adhere to. What is acceptable to the community depends very much on individual tastes and habits. A well, therefore, may be used for non-drinking purposes such as washing (below left) and later for drinking-water when people find the taste acceptable (below right).





Figure 15.6. Devastation of the 2006 Asian Tsunami in Sri Lanka left many wells contaminated with saltwater

### Further information

Goswami, R.R. and T.P. Clement (2007) *Technical details of the SEAWAT model simulation results used to develop well cleaning guidelines*, Technical Summary Report. Department of Civil Engineering, Auburn University.

Villholth, K.G. (2007) 'Tsunami impacts on groundwater and water supply in eastern Sri Lanka', *Waterlines*. 26(1).

WHO (2013) 'Cleaning and disinfecting wells in emergencies'. Technical Note 1.



**World Health  
Organization**

Water, Sanitation,  
Hygiene and Health Unit  
Avenue Appia 20  
1211 Geneva 27  
Switzerland

Telephone: + 41 22 791 2111  
Telephone (direct): + 41 22 791 3555/3590  
Fax (direct): + 41 22 791 4159  
URL: [www.who.int/water\\_sanitation\\_health](http://www.who.int/water_sanitation_health)

Prepared for WHO by WEDC. Author: Karen Villholth, IWMI (International Water Management Institute)  
Series Editor: Bob Reed. Editorial contributions, design and illustrations by Rod Shaw  
Line illustrations courtesy of WEDC / IFRC. Additional graphics by Ken Chatterton.



Water, Engineering and Development Centre Loughborough University Leicestershire LE11 3TU UK  
T: +44 1509 222885 F: +44 1509 211079 E: [wedc@lboro.ac.uk](mailto:wedc@lboro.ac.uk) W: <http://wedc.lboro.ac.uk>









**World Health  
Organization**

Water, Sanitation,  
Hygiene and Health Unit  
Avenue Appia 20  
1211 Geneva 27  
Switzerland

Telephone: + 41 22 791 2111  
Telephone (direct): + 41 22 791 3555/3590  
Fax (direct): + 41 22 791 4159  
Email Coordinator: bosr@who.int  
URL: [www.who.int/water\\_sanitation\\_health](http://www.who.int/water_sanitation_health)

**These four page highly-illustrated notes have been prepared by WEDC for the World Health Organization to assist those working immediately or shortly after an emergency to plan appropriate responses to the urgent and medium-term water and sanitation needs of affected populations.**

**The notes are relevant to a wide range of emergency situations, including both natural and conflict-induced disasters. They are suitable for field technicians, engineers and hygiene promoters, as well as staff from agency headquarters.**

**They are also available as pdf and html files designed for hand-held electronic devices. Visit the WEDC website at <http://wedc.lboro.ac.uk/>**



Prepared for WHO by WEDC. Author and Series Editor: Bob Reed.  
Editorial contributions, design and illustrations by Rod Shaw  
Line illustrations courtesy of WEDC / IFRC. Additional graphics by Ken Chatterton.

Water, Engineering and Development Centre Loughborough University Leicestershire LE11 3TU UK  
T: +44 1509 222885 F: +44 1509 211079 E: [wedc@lboro.ac.uk](mailto:wedc@lboro.ac.uk) W: <http://wedc.lboro.ac.uk>

Second edition: September 3013

ISBN: 978-1-84380-152-8

© World Health Organization 2013. All rights reserved. All reasonable precautions have been taken by the World Health Organization to verify the information contained in this publication. However, the published material is being distributed without warranty of any kind, either expressed or implied. The responsibility for the interpretation and use of the material lies with the reader. In no event shall the World Health Organization be liable for damages arising from its use.