

This item was submitted to Loughborough University as a PhD thesis by the author and is made available in the Institutional Repository (<https://dspace.lboro.ac.uk/>) under the following Creative Commons Licence conditions.



**CC creative commons**  
COMMONS DEED

**Attribution-NonCommercial-NoDerivs 2.5**

**You are free:**

- to copy, distribute, display, and perform the work

**Under the following conditions:**

 **Attribution.** You must attribute the work in the manner specified by the author or licensor.

 **Noncommercial.** You may not use this work for commercial purposes.

 **No Derivative Works.** You may not alter, transform, or build upon this work.

- For any reuse or distribution, you must make clear to others the license terms of this work.
- Any of these conditions can be waived if you get permission from the copyright holder.

**Your fair use and other rights are in no way affected by the above.**

This is a human-readable summary of the [Legal Code \(the full license\)](#).

[Disclaimer](#) 

For the full text of this licence, please go to:  
<http://creativecommons.org/licenses/by-nc-nd/2.5/>

# Design and Performance of Precast Concrete Structures

---

**Gary Robinson**

---

---

**Hanson Structherm  
Bent Lane Road,  
Meltham,  
Huddersfield.  
HD9 4AP**

**Centre for Innovative and Collaborative  
Construction Engineering  
School of Civil & Building Engineering  
Loughborough University  
Loughborough  
Leicestershire, LE11 3TU**



# **DESIGN AND PERFORMANCE OF PRECAST CONCRETE STRUCTURES**

By  
Gary Robinson

A dissertation thesis submitted in partial fulfilment of the requirements for the award of the degree Doctor of Engineering (EngD), at Loughborough University

January 2014

**© by Gary Robinson 2014**

Hanson Structerm  
Bent Lane Road,  
Meltham,  
Huddersfield.  
HD9 4AP

Centre for Innovative and Collaborative Construction  
Engineering  
School of Civil & Building Engineering  
Loughborough University  
Loughborough  
Leicestershire, LE11 3TU



## ACKNOWLEDGEMENTS

A project of this nature involves a great number of people, and as such I am sure I will not capture them all in this short section. Firstly, the author would like to express his sincere gratitude to his two academic supervisors, Professor Simon Austin and Dr Alessandro Palmeri for their patience, expertise, time, effort, advice, unwavering support and encouragement throughout the duration of the research.

A great deal of thanks is also due to Julian Taylor and Giles Atkinson of Hanson Structerm for their technical input, encouragement as well as their necessary (but always constructive) criticism. Dr John Cotton of Hanson Precast is deserving of significant gratitude for his role in allowing us to complete the research project, as well as the company itself for its financial support. The financial assistance provided by the Engineering and Physical Sciences Research Council (EPSRC) is also gratefully acknowledged.

The technical staff of the Sir Frank Gibb and CERAM structural testing laboratories also helped and inputted enormously, as did all of the support staff associated with the Centre for Innovative and Collaborative Engineering (CICE). Neil Parkes, Mike Smeeton and Sara Cowin require special mention for their efforts and support.

The complete support of my parents, Sandra and Philip Robinson, has been a constant source of strength throughout this research project as it has been throughout my education and career as a whole. The greatest thanks though must go to my wonderful wife Eve, for without her unwavering support and understanding I would have given up a long time ago.

Finally this is for my daughter Nell, whose arrival has spurred me to complete the work and whom I hope one day can stand on my shoulders, as I have stood on the shoulders of all of those aforementioned.

## **ABSTRACT**

A precast concrete structural system offers many advantages over in-situ casting. For example, greater control over the quality of materials and workmanship, improved health and safety (with casting carried out at ground level rather than at height) and cost efficiency (with standard forms continually re-used) are all realised through the off-site production of structural elements. As a result, a large body of research has been conducted into their performance, with many national codes of practice also devoting specific sections to design and detailing. However, contemporary design practice has been shown to not always correctly reflect the findings of published experimental studies.

Concrete technology is continually evolving, as is the industry's knowledge of how to model and predict the behaviour of the resulting structural components. Using such understanding to design and justify the more efficient, cost-effective or flexible manufacture of precast components can offer a key commercial advantage to a precast manufacturer. In this context, the numerical and experimental investigations undertaken as part of this study have been specifically focussed on quantifying the advantages of utilising beneficial alternatives. Specifically the research has looked at improvements in concrete mixes, lightweight aggregates and reinforcing strategies, for precast structural elements required to transfer loads both vertically and horizontally. However, because of the non-standard solutions considered, different approaches have been used to demonstrate their suitability.

Towards this goal, an alternative assessment strategy was devised for slender precast concrete panels with central reinforcement. The procedure was found to lead to design capacities that are in good agreement with actual experimental findings and should thus result in future manufacturing efficiency. The method can also be used for alternative concrete types and reinforcement layouts.

Fresh and early-age material characteristics of self-compacting concrete mixes with a partial or complete replacement of traditional gravel and sand constituents with lightweight alternatives were investigated. This was done to demonstrate the feasibility of their use for the manufacture of large scale structural components, with clear benefits in terms of lifting and transportation.

A computational 'push-down' procedure was utilised to demonstrate the potential unsuitability of current tying regulations for avoiding a progressive collapse event in precast framed structures. The findings are considered to be of particular significance for these structures due to the segmental nature of the construction and the associated inherent lack of structural continuity.

## **KEY WORDS**

Precast Concrete; Design Assisted by Testing; Fibre Hinge; Robustness; SPFA

## **PREFACE**

The research presented in this thesis was commenced in 2009 and completed in 2013 in partial fulfilment of the requirements of the Engineering Doctorate (EngD) at the Centre for Innovative and Collaborative Engineering (CICE), Loughborough University. The research was conducted in an industrial context and was sponsored by building product manufacturer Hanson, with the Research Engineer (RE) based in the Hanson-Structherm subsidiary.

The EngD is examined on the basis of a discourse supported by a minimum of three peer reviewed publications and technical reports. Two published journal papers and two peer-reviewed conference papers (authored by the candidate and the accredited supervisors) are included in Section 6 of this document.

Because the research has both an industrial and academic focus the thesis has been written so that the discourse can be read as a stand-alone document in order to provide an overview of the key findings and implications of each research aspect. However, continual references are also made to each of the papers throughout the discourse (linking their contents into the overall theme of the project) to provide further data, analysis and comment to the general subject areas discussed.



## USED ACRONYMS / ABBREVIATIONS

DAT	Design Assisted by Testing
D-Region	Discontinuity Region
EngD	Engineering Doctorate
FEM	Finite Element Method
FoG	Floor over Garage (Precast Floor Slab Component)
GSA	General Services Administration (US Regulatory Body)
MIG	Metal Inert Gas
PFA	Pulverised Fly Ash
RC	Reinforced Concrete
RE	Research Engineer
SFR	Steel Fibre Reinforcement
SPFA	Sintered Pulverised Fly Ash
STM	Strut-and-Tie Model

## NOMENCLATURE

$b =$  least-squares parameter accounting for variables omitted in theoretical mechanical model in DAT procedure.

$e =$  eccentricity of the load measured at right angles to plane of the wall

$e' = e - (t/6) + (M_{CR}/P_E) =$  equivalent eccentricity parameter

$f_c =$  compressive cylinder strength of concrete

$f_{ct} =$  tensile strength of concrete

$f_{sw} =$  flexural cracking strength of concrete

$k_{d,n} =$  design fractile factor

$m =$  mean value of test samples

$n =$  number of test samples

$s =$  standard deviation of test samples

$r_{te} =$  experimental capacity for the  $i^{th}$  test in DAT procedure

$r_{ti} =$  theoretical resistance determined using the measured parameters  $X$  for specimen  $i$

$t =$  thickness of precast structural element

$t_c =$  standard t-distribution

$E_c =$  modulus of elasticity of concrete

$H =$  effective height of the RC wall panel

$L =$  effective length of precast structural element

$N =$  externally applied axial force

$M_{CR} =$  flexural cracking moment of the wall section without any axial force

$M_0 =$  nominal out-of-plane member moment capacity

$M_{xx} =$  Bending moment (kN/m) about major axis of precast component

$M_{yy} =$  Bending moment (kN/m) about minor axis of precast component

$P_E =$  Euler buckling load

$\delta' =$  lateral deflection at critical section of wall panel

$\lambda = H/t =$  panel element slenderness

$\rho =$  reinforcement ratio in precast concrete element

$\theta = \arctan(b) =$  the angle that the least squares regression line forms with horizontal axis

---

## TABLE OF CONTENTS

<b>Acknowledgements</b> .....	<b>i</b>
<b>Abstract</b> .....	<b>ii</b>
<b>Preface</b> .....	<b>iii</b>
<b>Used Acronyms / Abbreviations</b> .....	<b>iv</b>
<b>Nomenclature</b> .....	<b>iv</b>
<b>Table of Contents</b> .....	<b>v</b>
<b>List of Figures</b> .....	<b>vii</b>
<b>List of Tables</b> .....	<b>ix</b>
<b>List of Papers</b> .....	<b>x</b>
<b>1 Introduction</b> .....	<b>11</b>
1.1 Background to the Reseach.....	11
1.2 The Industrial Sponsor.....	14
1.3 Need for the Research.....	14
<b>2 Aim and Objectives</b> .....	<b>20</b>
2.1 Background.....	20
2.2 Aim.....	21
2.3 Research Objectives.....	21
2.4 Justification of the Objectives.....	23
<b>3 Methodology</b> .....	<b>30</b>
3.1 Methodological Considerations.....	30
3.2 Methodology Development.....	32
3.3 Methods.....	38
<b>4 Research Undertaken</b> .....	<b>41</b>
4.1 Objective 1: Design Methodologies for RC Panels.....	41
4.2 Objective 2: Design and Adoption of Un-Confined Reinforcement Configurations ...	45
4.3 Objective 3: Alternative Aggregate Materials.....	48
4.4 Objective 4: Suitability and Improvement of Robustness Methods.....	51
<b>5 Findings and Implications</b> .....	<b>54</b>
5.1 The Key Findings of the Research.....	54
5.2 Contribution to Existing Theory and Practice.....	59
5.3 Implications/Impact on the Sponsor.....	63
5.4 Implications/Impact on Wider Industry.....	64
5.5 Recommendations for Industry/Further Research.....	66
5.6 Critical Evaluation of the Research.....	68
<b>6 The Papers</b> .....	<b>70</b>
6.1 Paper J1.....	70
6.2 Paper J2.....	105
6.3 Paper C1.....	134
6.4 Paper C2.....	153
<b>7 References</b> .....	<b>170</b>

---



---

## LIST OF FIGURES

Figure 1.1	Disproportionate Collapse of Precast Cross-wall Structures: Ronan Point (1968) and Large UK Panel Structure during Demolition (CROSS 2000) .....	13
Figure 1.2	Precast ‘Dapped-End’ Beam and Lintel Elements in Cross-Wall Construction .....	15
Figure 1.3	Automated Welded Mesh Manufacture at Hanson Manufacturing Facility, Hoveringham.....	16
Figure 1.4	Large Scale Precast Flooring Units and Significance of Transport and Cranage Considerations in Precast Buildings .....	17
Figure 2.1	Research Process Flow Diagram.....	22
Figure 2.2	Unconfined Welded Mesh Reinforcement Configurations for Precast Panel and Lintel Components.....	23
Figure 2.3	Brittle Failure Modes Observed Experimentally for Precast Panel and Lintel Samples .....	24
Figure 2.4	Sintered Pulverised Fly Ash (SPFA) Aggregate and Maccaferri FF3 Wirand Steel Fibres .....	26
Figure 3.1	Indicative Models for Reinforcement in Half Joints (CEN 2004) .....	35
Figure 4.1	Comparison of Code Methods for Design Axial Strength with Experimental Capacities .....	41
Figure 4.2	Experimental Set-up for RC Panels: (a) Test Rig Elevation; (b) Section; (c) Pin Joint Detail (Robinson et al 2013-Paper J1).....	42
Figure 4.3	Panel Buckling Failure: (a) Unconfined Central Welded Mesh; (b) Welded Mesh with a 50kg/m <sup>3</sup> SFRC Content.....	43
Figure 4.4	Key Aspects of the Lumped Plasticity Analysis: (a) Computational Idealisation of Experimental Set-Up; (b) Reinforcement Layout and Fibre Hinge Idealisation of Wall Panel Cross Section; (c) Resulting Compressive Stress Block; (d) Resulting Moment Rotation Response of Fibre (Robinson et al 2013- Paper J1) .....	44
Figure 4.5	Confined ‘Cage’ Reinforcement Configuration for Precast Beam Samples ....	48
Figure 4.6	Structural Sections, Connection Designs and Computational Equivalents (Robinson et al 2013- Paper C2).....	53

Figure 5.1	Comparison between Theoretical and Experimental Results: Alternative Computational Design Approach (Robinson et al 2013- Paper J1).....	55
Figure 5.2	Experimental Load-Deflection Curves for Panels with Varying Eccentric Load and Use of SFR (Robinson et al 2012- Paper C1).....	56
Figure 5.3	Crack Patterns and Failure: (a) Cage; (b) Fibre Mesh; (c) Mesh Only .....	57
Figure 5.4	Cube and Span Normalised Load-Displacement Curves .....	57
Figure 5.5	Push-Down Load-Displacement Relationships of Model Structures (Robinson et al 2013- Paper C2) .....	59
Figure 5.6	Alternative Panel Capacity Curve Developed from the Lumped Plasticity Idealisation with the DAT Procedure (Robinson et al 2013-Paper J1).....	60
Figure 5.7	FEM Strain Progression Superimposed on Tested Lintel (Argyle 2011).....	65
Figure 5.8	Full Scale Rubberised Concrete Lintel and Evolution of Strain Captured by Imagery Analysis (Martin and Godfrey 2013)..	66

**LIST OF TABLES**

Table 3.1	Quantitative vs. Qualitative Research Strategies (Bryman 2008).....	31
Table 3.2	Design Fractile Factors for $V_x$ Unknown (CEN 2002).....	33

## LIST OF PAPERS

The following papers, included in Section 6, have been produced in partial fulfilment of the award requirements of the Engineering Doctorate during the course of the research.

- **JOURNAL PAPERS:**

### PAPER J1

Robinson, G.P., Palmeri, A., Austin, S.A., 2013. **Design Methodologies for One Way Spanning Eccentrically Loaded Minimally or Centrally Reinforced Pre-Cast RC Panels.** *Journal of Engineering Structures*, 56(2013): 1945-1956, doi.org/10.1016/j.engstruct.2013.07.041

### PAPER J2

Robinson, G.P., Austin, S.A., Palmeri, A., 2013. **Adoption of Artificial Lightweight Aggregate in Precast Manufacture.** *Magazine of Concrete Research*, 65(19): 1173-1186, doi.org/10.1680/mac.13.00112

- **CONFERENCE PAPERS:**

### PAPER C1

Robinson, G.P., Palmeri, A., Austin, S.A., 2012. **Influence of Steel Fibres, Used in Conjunction with Unconfined Rebar Configurations, on the Structural Performance of Precast Elements.** In: *Proceedings of 8<sup>th</sup> RILEM International Symposium on Fibre Reinforced Concrete-Challenges and Opportunities*, 19-21 September, Guimaraes, Portugal

### PAPER C2

Robinson, G.P., Palmeri, A., Austin, S.A., 2013. **Appropriateness of Current Regulatory Requirements for Ensuring the Robustness of Precast Concrete Building Typologies.** In: *Proceedings of 5<sup>th</sup> ICE International Conference on Forensic Engineering*, 16-17 April, London, UK

- **OTHER PAPERS PRODUCED IN THE COURSE OF THE STUDY BUT NOT INCLUDED IN THE DISCOURSE:**

### PAPER C3

Robinson, G.P., Palmeri, A., Austin, S.A., 2011. **Implications of EC2 on the Design of Simply Supported Precast RC Panels Under Eccentric Axial Load.** In: *Proceedings of fib Symposium on Concrete Engineering for Excellence and Efficiency*, 8-10 June, Prague, Czech Republic

### PAPER C4

Robinson, G.P., Palmeri, A., Austin, S.A., 2011. **Tension Softening Effects on the Buckling Behaviour of Slender Concrete Wall Panels.** In: *Proceedings of ISEC-6 Modern Methods and Advances in Structural Engineering and Construction*, 21-26 June, Zurich, Switzerland

# **1 INTRODUCTION**

This chapter provides a short introduction to the general subject area. The context of the research in the UK precast industry is described and the Industrial Sponsor (Hanson Structherm) is introduced. It is intended that this section places into context all subsequent chapters of the thesis highlighting the aim, objectives, justification, as well as the scope of the research.

## **1.1 BACKGROUND TO THE RESEARCH**

Research and development in Hanson-Structherm is aimed at improving performance, efficiency and the effective evolution of pre-fabricated construction systems towards providing the company with a commercial advantage.

It is recognised in the sponsoring organisation that improved performance in regards to each of these aspects can be achieved through an on-going review and questioning of existing design, manufacturing and construction practices. Thus, the work aims to highlight any potential for improved efficiency, identifying opportunities where it would be possible (and beneficial) to undertake or apply aspects of contemporary research, material science or other relevant best-practices to current design, manufacturing or installation processes. It remains necessary however to ensure that the appropriate regulatory approvals and satisfactory performance can always be demonstrated so that the structural products can be incorporated into construction projects.

### **1.1.1 Novel or Non-Standard Design, Materials and Manufacturing Methods**

Despite continued progress in concrete technology and manufacturing techniques, it is debatable whether the UK precast concrete industry has effectively utilised and incorporated the resulting knowledge. Therefore the sponsoring company wanted to examine if contemporary research could be better used or augmented to develop structural elements or alternative products that are more efficient, cost-effective or flexible (in the sense of meeting a non-conventional/ aspirational performance or design requirement).

The company believed that the non-standard concrete mixes, reinforcement bar layouts or design methods represented an opportunity to realise improved efficiencies relative to the existing design



techniques or manufacturing practice. The focus of this EngD research has therefore been on developing methods of enabling the design engineer to specify, quantify and justify any benefits relating to the alternative concretes, aggregates, cements, additives or reinforcements (in a code compliant design). The research looked to develop analytical methods and design rules that would allow the engineer to use unconventional concrete mixes and reinforcement strategies to improve the performance or efficiency of existing designs. Adopting unconfined re-bar configurations and sustainable alternative aggregates, for precast beam, panel and solid slab components were identified (during the course of the research) as offering the company the opportunity to achieve this research aspiration.

### **1.1.2 Critical Evaluation and Improvement of Existing Design Methods**

In aspiring to justify any such enhanced structural performance, it is equally important to ensure that available regulatory guidance allows engineers to take advantage of the latest analytical techniques, computational tools and experimental data. Otherwise the applicability or commercial ‘viability’ of the research becomes limited, as any improvements or efficiencies cannot be realised in actual structures. That is to say, it is important to ensure design codes are contemporary and flexible enough to allow for innovative and progressive design.

A better understanding of the suitability of existing design codes and methodologies thus becomes important. The question of their applicability consequentially became a focus of this work, particularly when adopting non-standard materials, reinforcement or loading conditions in the detailing or manufacture of precast components. It was also found that this critical evaluation process turned out to be a mechanism in itself, which allowed the organisation to identify and exploit opportunities to improve structural efficiency. This research output was perhaps not anticipated at the outset of the project. Specifically, the research investigated slender RC wall panels and notched beams incorporating halving joints (see Section 1.3).

As part of the review conducted into key regulatory design constraints pertaining to precast structures, it became apparent that the requirements associated with ensuring that the final building is ‘robust’ enough to resist a progressive collapse event presents an ongoing

---

technical and commercial challenge to the UK precast industry.

The phenomenon of progressive collapse can be visualised as the failure of a house of cards, where structural damage propagates beyond the locality of the initial damage and to an extent disproportionate to the original cause. The need to consider and mitigate for the risk of such collapse is often seen to be a greater imperative in the design and detailing of pre-cast concrete structures, than in equivalent reinforced concrete (RC) or steel frames (IStructE 2010). This is likely due to the segmental nature of precast construction and the associated inherent lack of structural continuity at joint locations. The structural collapse of Ronan Point in 1968 and a similar precast cross-wall panel structure (during demolition) in 2000 starkly presents the potential risks of the construction type (Figure 1.1).



**Figure 1.1** Disproportionate Collapse of Precast Cross-wall Structures: Ronan Point (1968) and Large UK Panel Structure during Demolition (CROSS 2000)

The early part of the research identified that if a suitable quantitative method to assess structural robustness could be adapted to suit the various structural elements, connections and forms of a precast frame, it would better allow the engineer to evaluate the suitability of the design to meet regulations. More significantly, it would do this in a way that was auditable and which would allow the designer to measure the performance of his/her precast building relative to alternative forms of construction. It would also allow them to change, improve and optimise the design accordingly. Whether such a method currently exists has been questioned (Starossek and Haberland 2008), with the applicability of any such method to precast structural systems being another key question. An investigation into a procedure that more definitively demonstrated the suitability of precast buildings to clients and checking engineers, was consequentially viewed (by Hanson-Struetherm) to offer a clear commercial benefit and thus warrant a research effort.

## **1.2 THE INDUSTRIAL SPONSOR**

Hanson-Structherm has provided precast concrete solutions to the construction industry for over 25 years (Structherm 2010). The company has technical expertise in the manufacture and supply of innovative building solutions, having established key technical ability developing their proprietary pre-cast concrete cross-wall building products (i.e. 'Fast-build'). The company became part of the Hanson Heidelberg Cement group in 2008, with the integration offering the Structherm engineering team an additional range of manufacturing, testing and design resources.

The current technical capability and market position of the Hanson-Structherm brand is recognised to be derivative of the company's historical focus on ensuring the evolution of the precast components and systems that it sells. The company therefore remains committed to making sure that its precast structural solutions remain in line with industry best practice, in regards to their design, manufacture, transportation and installation. The organisation is also keen to better understand what opportunities exist for the future development of their products, with a specific focus on how the new production facilities, manufacturing techniques and other technical resources now (or becoming) available in the market can be utilised to achieve this.

## **1.3 NEED FOR THE RESEARCH**

It could be seen *prima facie* that the scope for new research into the performance of precast concrete components may be limited due to the maturity of the precast concrete industry, particularly with regards to design and manufacturing methods. A wealth of research material also exists relating to concrete technology. However, this section aims to identify and justify the need for the specific investigations undertaken, particularly in an industrial context.

Each facet of the work was associated with reviewing current practice against novel or non-standard alternatives to identify commercial opportunities or efficiencies. This was in line with the applied nature and commercial focus indicative of the EngD qualification. Further, any analytical, computational or experimental work found to be necessary also had to be designed and conducted in a manner that meant the findings would be applicable and transferrable to contemporary processes in the UK precast industry.

One such opportunity was identified relating to low-rise precast cross-wall structures, where horizontal floor loading is often transferred by using **precast T-beams or lintels** around a penetration (or fenestration). Figure 1.2 illustrates the typical bearing details of the elements and how these relate to the wall panels as part of a precast cross-wall building typology. The end projection results in a reduction in the construction depth required, with this detail often referred to as a ‘dapped-end’ or ‘halving joint’.

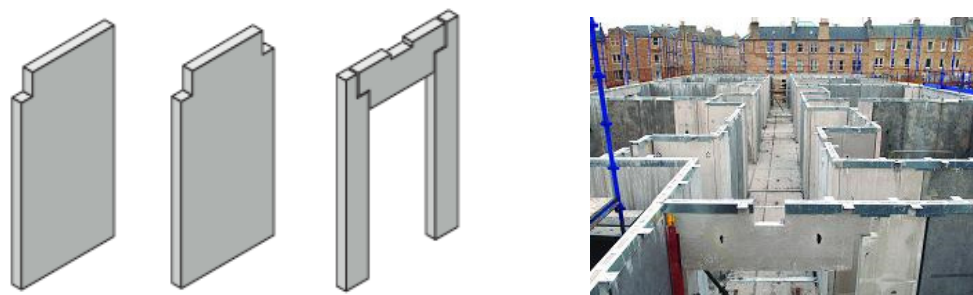

**Figure 1.2** Precast ‘Dapped-End’ Beam and Lintel Elements in Cross-Wall Construction

Welded mesh reinforcement (see Figure 1.3) offers the sponsoring organisation savings in the manufacture of the element over traditional shear links, because of the reduced complexity and timescales that may be possible. That is, welded mesh can be more cost-effectively manufactured using automated machinery (relative to a tied re-bar layout). However, the behaviour and performance of beams with this alternative re-bar layout needs to be quantified relative to other solutions that provide ‘confinement’. Any necessary variations then also need to be correctly identified and captured in an alternative design procedure. This research deliverable is also applicable to any change in behaviour that may be associated with the concrete types/mixes so that the alternative design can be realised.

A second component where an unconfined re-bar configuration may be exploited is in **vertical panels**. For pre-cast ‘tilt-up’ or ‘cross-wall’ precast construction typologies, the reinforced concrete (RC) wall panels provide the fundamental vertical load-carrying system (Figure 1.2). However, minimum reinforcement requirements are frequently adopted for pre-cast concrete elements, with this steel often centrally placed for reasons associated with manufacture and durability. Again, the ability to demonstrate the structural suitability of wall panels adopting

a welded-mesh configuration is of significant commercial significance because of the associated benefits to component manufacture.



**Figure 1.3** Automated Welded Mesh Manufacture at Hanson Manufacturing Facility, Hoveringham

However, previous research (Crozier and Sanjayan 1997) has questioned (and this research has confirmed, Robinson et al 2011b), the applicability of certain current design methods in such instances. This is because the resulting structural response and failure mode of such wall elements is fundamentally different to those experienced by more heavily reinforced panels. Design methods are available to the American ACI 318-08 (2008), Australian AS 3600-09 (2010) and European EC2 (2004) design codes, which also allow the detailing of these elements using simplified and empirically (or semi-empirically) derived equations (Wight and MacGregor 2009). Such equations cannot, however, correctly account for the material and geometric non-linearity in the buckling failure of slender RC elements under eccentrically applied loads, because of their inherent simplicity (De Falco and Lucchesi 2002). Hence large safety factors have to be adopted by the codes to ensure these complexities do not affect the ‘reliability’ of the resulting designs, i.e. the probability of failure is below the acceptable design threshold. Numerous studies demonstrate that these equations, as a result, underestimate panel capacities significantly when compared to those achieved by experimentation (Doh and Fragomeni 2005; Fragomeni et al 1994).

Part of the research focus therefore needed to establish whether it was possible to justify more structurally efficient slender precast RC walls, which would be more in line with existing published data, or whether an alternative design methodology is required. The ability of the existing methods (or any alternatives proposed) to assess wall elements taking into account the concrete mix design, reinforcement strategy or more onerous load cases (so as to improve the

‘performance’ of the element) is also important for the business case and aligns well with the research focus outlined in Section 1.1.

Another key structural component in a precast cross-wall building is the **solid slab flooring** unit (Figure 1.4). Their fabrication, transportation and installation results in significant challenges and consequentially costs to a precast manufacturer because of the size and weight. The ability to design and manufacture lighter structural units therefore offers a commercial advantage. For example, a greater number of units could be transported per delivery vehicle, larger units could be lifted for a given crane capacity and this would also consequentially result in a reduction in the number and cost of the required structural joints. With these commercial advantages in mind therefore, aspects of the presented research were driven by an industrial focus in regards to the possibility of incorporating alternative lightweight aggregate materials in solid precast structural floor units.

It is worth emphasising that, due to commercial pressures, structural precast components are often de-moulded, lifted and transported after only a short period of curing (12-24 hours). What this means in reality is that it is the concrete strength at this earlier stage of curing, rather than the anticipated in-situ loads that determine the concrete mix design for precast manufacture. Establishing and quantifying the likely effect that such alternative materials (and their respective mix designs) will have in terms of the fresh and early age concrete properties is therefore an important aspect of any feasibility assessment.



**Figure 1.4** Large Scale Precast Flooring Units and Significance of Transport and Craneage Considerations in Precast Buildings.

As detailed in Section 1.1, the scope of the research and development programme requires any improved efficiencies or resulting products to meet regulatory and code requirements. Because of this, a complementary research study into the **assessment of the robustness of**

**precast framed structures** became apparent, in addition to those looking at improving the structural performance of specific components. With an on-going drive towards ever greater structural optimisation in building components, the resulting structures will then tend to lack the inherent additional capacity (and subsequent robustness this provides) of structures designed using the more conservative techniques and design codes we are trying to supersede. Because of this, the structural response to abnormal loadings or damage will become of ever greater significance in a precast building's design development. Therefore the industry's knowledge and ability to quantify and design for such requirements became part of this body of work. Further, the critical evaluation of how existing design and assessment methods are used has already been stated to provide a mechanism through which improved structural performance may be achieved (for the design of slender RC panel element, Section 1.1.2). By critically investigating current robustness design practices against the opportunities presented by alternative techniques, a similar deliverable was anticipated.

Robustness can be defined as: *'the structural ability to survive the event of local failure'* (Wibowo and Lau 2009) or as an: *'insensitivity to local collapse'* Starossek (2007). Alternatively, Knoll and Vogel (2005) attempt to provide an overarching mathematical representation, suggesting a robust structure is one where:

$$\text{Residual Capacity} \geq \text{Residual Demand}$$

However, Knoll and Vogel (2005) recognise that because there are many mechanisms by which local collapse in a given building construction may propagate, the robustness of a structural system becomes very much a matter of context. The appropriate consideration and application of the term *'capacity'*, in the equation above, is highly dependent on the abnormal event which has occurred, with the critical property preventing collapse potentially relating to a variety (and combination) of structural and material properties.

Beeby (1999) was one of the earliest to highlight the need for a method to quantify a building's robustness. He argued that many engineers have a qualitative appreciation of what robustness is, and awareness in regards to the engineering measures and practices that can be adopted to reduce risk of disproportionate failure. These include: selection of structural forms with a low sensitivity to disproportionate collapse; ensuring the structure is tied; and the need

to provide for sufficient ductility in the structural elements and joints. However, Beeby went on to discuss that, although many engineers inherently understand the need to prevent against disproportionate collapse, they lack the analytical tools, assessment methods, appropriate metrics and explicit design guidance to ensure the risk can be quantified and therefore mitigated during the design development.

The industrial partner agreed with this view, identifying that very little guidance exists relating to how ‘robust’ a typical pre-cast concrete cross-wall structure is required to be and whether the current statutory requirements are met by contemporary design and detailing practices. There is also little evidence to support the widely held industry view that pre-cast concrete construction is in some way less robust than an in-situ or steel alternatives (IStructE 2010). Disunity is also perceived in existing literature in regards to the most appropriate methods for assessing and ensuring a building’s resistance to a progressive collapse failure typology (Starossek and Haberland 2008). Whether current best practice or alternative methodologies offer any advantages in a modern structural design office was therefore deemed worthy of further research.



## **2 AIM AND OBJECTIVES**

### **2.1 BACKGROUND**

The overarching research aim (see Section 2.2), specifically focuses on improving the performance of precast concrete structural components and building systems. The term ‘performance’ in the context of this research should be taken to be associated with improved structural capacity, design or manufacturing efficiency, more effective project delivery, component flexibility, the ease of installation, improved sustainability or any consequential growth in terms of sales or market share. It was also a requirement that any aspects of improved performance were to be realised in precast structures that will meet regulatory requirements and certification (Section 1.1).

By critically reviewing existing processes, practices and their associated regulations or constraints, it was possible to identify and quantify opportunities where alternative materials, manufacturing techniques or ancillary components could provide the required improved performances. The process of then evaluating how these alternatives could be justified as part of existing regulatory guidance subsequently required the research team to assess whether the current analytical methods, computational techniques and design equations could be adapted to accommodate the novel or non-standard design aspect under consideration.

The four research objectives, detailed in Section 2.3, evolved in response to this research position. Each is associated with a specific commercial risk or opportunity to the sponsoring organisation, with a potential for improved performance identified in all instances. The objectives were set to provide the practical and theoretical framework for the main research studies and were subsequently realised through associated research tasks (Section 4), with the findings and any associated deliverables/publications informing further research where applicable. All tasks, their relationships, resulting publications and how each relates to the specified objectives, are illustrated by the research process flow diagram (Figure 2.1). This also shows the dependencies, sequencing and any overlap between the research tasks and their outputs.

## **2.2 AIM**

*“To improve the performance of pre-cast cross-wall structural systems, through the effective evolution of current design and manufacturing practice.”*

## **2.3 RESEARCH OBJECTIVES**

### **Objective 1: Design Methodologies for RC panels**

To assess the suitability of current design methods pertaining to precast concrete wall panels resisting eccentric axial loading and, if necessary, to identify and demonstrate the validity of alternative methods which may improve the structural efficiency of these elements.

### **Objective 2: Design and Adoption of Un-Confined Reinforcement Configurations**

To evaluate the implications (in terms of structural performance and design) of adopting un-confined reinforcement configurations in precast concrete components, particularly structural elements that resist failure in buckling or shear.

### **Objective 3: Alternative Aggregate Materials in Precast Concrete Mix Design**

To assess the technical feasibility and implications of incorporating alternative aggregate and sand replacements in solid precast structural flooring elements, with respect to the structural design, manufacture or installation of the elements.

### **Objective 4: Suitability and Improvement of Robustness Methods**

To evaluate current disproportionate collapse assessment and design methodologies as they relate to precast concrete building typologies and quantify any potential benefits or risks that may exist when adopting such methods.

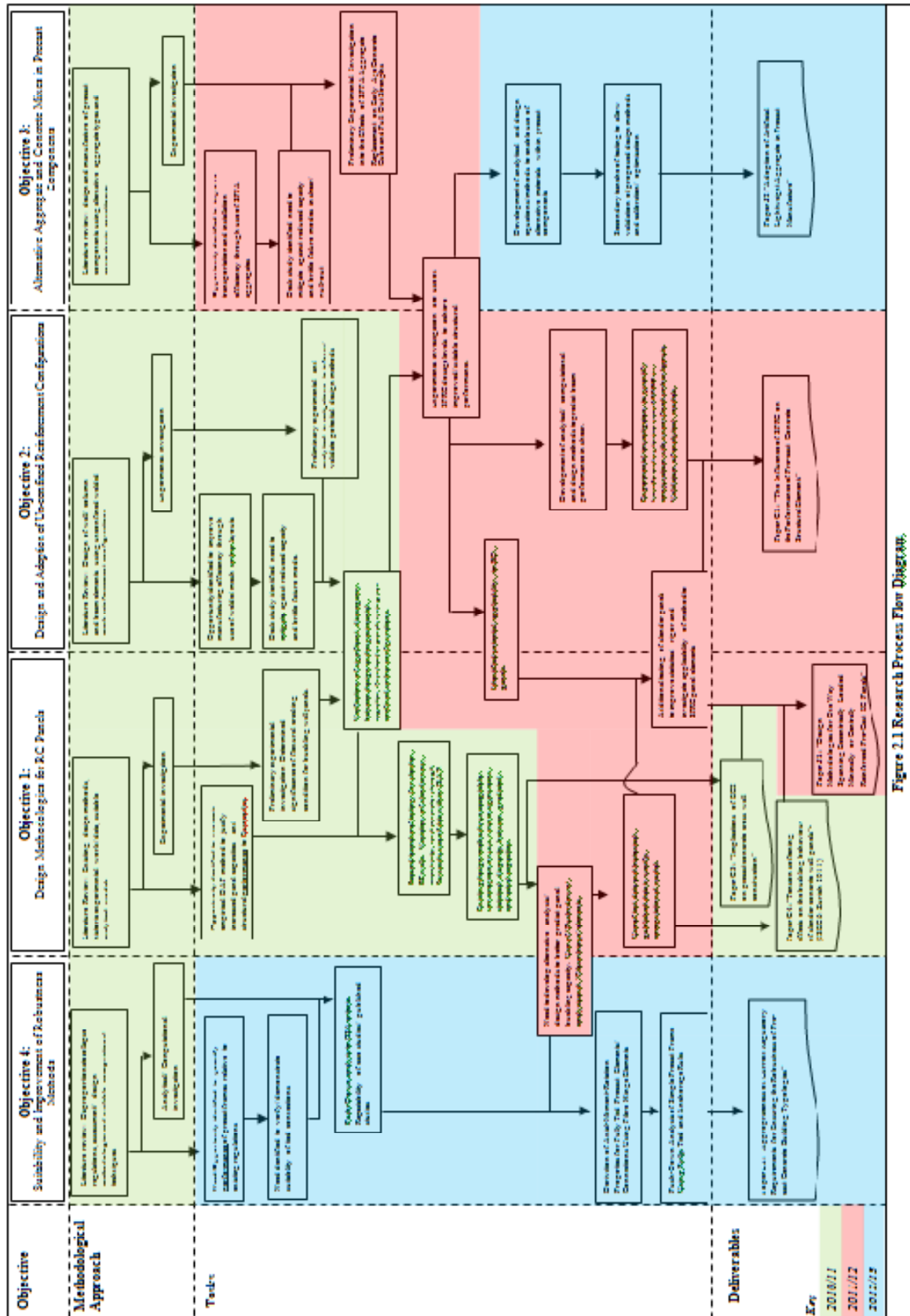

Figure 2.1 Research Process Flow Diagram.

## 2.4 JUSTIFICATION OF THE OBJECTIVES

This section aims to justify each of the objectives defined in Section 2.3. It will summarise the key aspects of the existing literature, technical guidance and any preliminary desk or experimental studies, which led the research team to identify that an opportunity and research need jointly existed. The sections also highlight how the existing publications and test data influenced and caused changes to and any evolution of the research and development.

### 2.4.1 Welded Mesh Reinforcement Configurations (*Objectives 1 and 2*)

As explained in Section 1.3, a centrally placed welded reinforcement configuration (see Figure 2.2) will allow cost savings in regards to the precast manufacture of both vertical and horizontal elements (*Objective 2*). However, its use has been limited historically because of a lack of design guidance for both panel and beam elements. For example, experimental and analytical studies by Crozier and Sanjayan (1997), confirmed by this research (Robinson et al, 2011b), have raised concerns with respect to the applicability of the current widely-adopted ‘equivalent’ column design method for RC wall panels adopting minimal and centrally placed reinforcement. Additionally, Doh and Fragomeni (2005) showed the current simplified design equations to be excessively conservative in respect to panels with slenderness in excess of  $\lambda = 25$  (*Objective 1*). The term ‘slenderness’ refers here to the ratio of the effective length of the wall panel to its thickness, where  $\lambda = H/t$ .

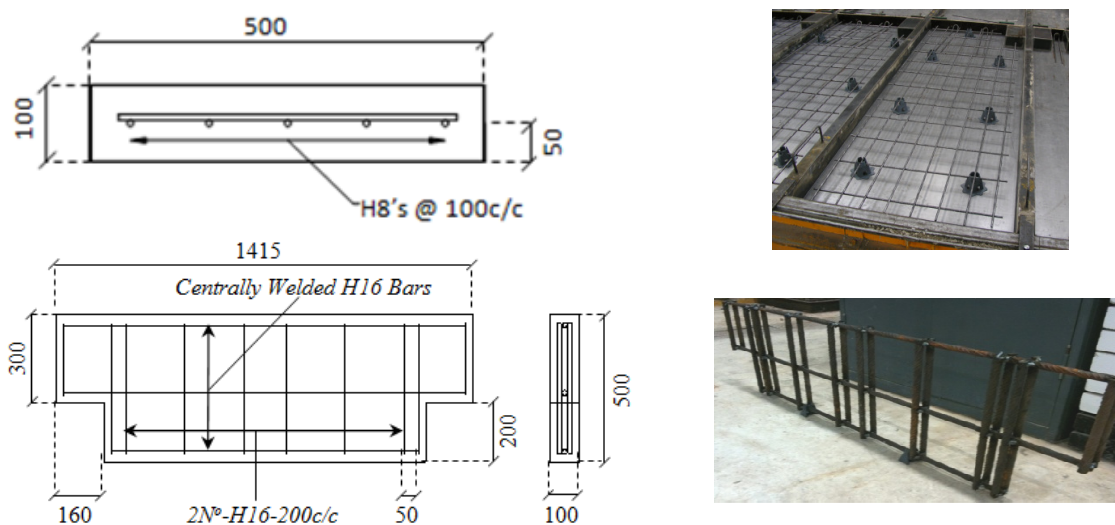

**Figure 2.2 Unconfined Welded Mesh Reinforcement Configurations for Precast Panel and Lintel Components**

One potential alternative design strategy, identified through specific provisions in EC0 (CEN 2002), enables the engineer to achieve a (code compliant) design for non-standard structural components and/or to overcome the limitations of existing design rules. The Design Assisted by Testing (DAT) procedure is based on a combination of testing and calculation and exploits probabilistic considerations to ensure that appropriate factors of safety are applied to predictions of structural capacity (*Objective 1*). These factors can be determined directly from experimental work, as long as the number of tests is sufficient for a meaningful statistical interpretation (Gulvanessian et al 2002). In the case of slender RC panels with minimum/central reinforcement, however, the preliminary testing undertaken (Robinson et al 2011b) found that, because a large and systematic conservatism existed between experimentally observed capacities and the current design procedures, these methods cannot provide a design, or ‘resistance’ function for the DAT procedure. Consequently, an alternative theoretical model or design method, which more appropriately reflects actual buckling capacity, is required (*Objective 1*).

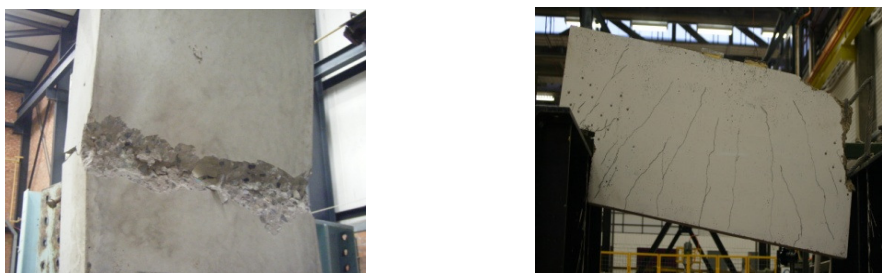

**Figure 2.3 Brittle Failure Modes Observed Experimentally for Precast Panel and Lintel Samples**

Additionally, there is the potential for a brittle failure mode (Figure 2.3) to result with precast elements adopting the welded mesh reinforcement proposed (Lu et al 2003; Robinson et al 2011a). Initial investigations suggested however, that alternative concrete mixes and reinforcing strategies could induce a more ductile response. As a result, it should then be possible to justify the adoption of the unconfined layouts as part of future design and manufacturing practice. However, the existing design expressions (for wall panel elements) currently take no account of either the quantity or the distribution of longitudinal reinforcement, with any modification to the concrete material model also not accommodated. Because of this, the ability of the design engineer to investigate improving structural performance (to mitigate a brittle failure mechanism or otherwise) through alternative concrete types or reinforcement strategies is restricted (*Objective 2*).

The inclusion of steel fibre reinforcement (SFR) in the concrete matrix was identified as one potential strategy for ameliorating the failure mode in centrally and minimally reinforced RC panels. This is because SFR (Figure 2.4) concrete mixes have been shown to result in a number of improvements in the mechanical performance of concrete, relating to aspects such as: a delay in micro-crack propagation to a macroscopic scale, the hindrance of macroscopic crack development and an improved structural ductility (Abrishami and Mitchell 1997). It was found that few resources or research studies aid in the design of slender panel elements, where there is a combination of SFR and longitudinal reinforcement (Figure 2.2). Furthermore, no coverage was found in existing regulatory codes. The need for an alternative design methodology again became apparent, with the ability to allow for non-standard concrete mixes and reinforcement layouts again relevant. To incorporate this extension to the original scope however, further experimental and computational works were necessary to aid the verification and calibration of the alternative technique (*Objective 2*).

The investigations of alternative mesh layouts in precast beam elements were focussed on better understanding the effect such configurations would have on the behaviour and capacity of the resulting discontinuity regions or ‘D-regions’ in the halving joints. The abrupt change in the cross section (see Figure 2.2) of the reinforced concrete member at the dapped end causes discontinuities in the flow of the internal forces. These D-regions cannot be analysed through beam theory and classical sectional analysis, with the inadequate (and inconsistent) treatment of such details using ‘past experience’ or ‘good practice’ design methods being cited as the cause for the historical poor performance and even failure of some structural components (Schlaich et al 1987). The design of D-regions can however (for confined reinforcement configurations) be accommodated using a strut and tie model (STM), as proposed by the work of Schlaich et al (1987) and Schlaich and Schafer (1991) (*Objective 2*).

A distinct research strand thus became necessary because (to the best of our knowledge) the appropriateness of adopting STM methods to design structural elements using unconfined reinforcement layouts has not previously been investigated. Research was required to understand: the appropriateness of this analytical method to this design situation, the way in which the procedure needs be modified to allow for the incorporation of the alternative design aspects and the need for an additional safety factor as part of the design procedure. Further,

the nature of STM is such that it is sensitive to changes in dimensions and loading conditions (Schlaich and Schafer 1991). As a result it is important to verify (and to a certain extent calibrate) any analytical models developed through experimentation.

#### **2.4.2 Alternative Aggregate Materials in Precast Slab Components (*Objective 3*)**

The testing and development associated with the 3<sup>rd</sup> objective was focussed on improving efficiency in the manufacture and installation of structural precast components. The sponsoring organisation highlighted that the weight and perceived environmental impact of precast construction systems are often reasons for clients and their design teams to use alternative structural solutions (Mays and Barnes 1991). The development of more sustainable lightweight components therefore had a strong business case.

The incorporation of sintered pulverised fuel ash (SPFA) in solid slab precast flooring units was identified as a potential technical solution, because it is an industrial waste product (Figure 2.4) and can significantly reduced density (Kockal and Ozturan 2011). For a complete replacement of the coarse material, the resulting lightweight concrete has a dried density in the range of  $1700\text{-}1900\text{ kg/m}^3$ . By incorporating SPFA as a fine/sand replacement, a further reduction in concrete density to  $1500\text{-}1600\text{ kg/m}^3$  is achievable. Kockal and Ozturan (2011) showed that despite the replacement it remains possible to obtain similarly high strength grades ( $60\text{ N/mm}^2$ ). These high strength but lightweight concretes therefore offer clear benefits to the precast industry, where an improved strength to weight ratio is advantageous for the lifting and transportation of the manufactured units (Al-Khaiat and Haque 1998). Other advantages are also associated with sustainability, reduced thermal conductivity and improved acoustic performance for the resulting density (Mays and Barnes 1991).



**Figure 2.4 Sintered Pulverised Fly Ash (SPFA) Aggregate and Maccaferri FF3 Wirand Steel Fibres**

A review of technical literature revealed that, although the effects of using lightweight aggregate and sand products have been the subject of numerous studies (Kayali 2008) in relation to the 28 day (and later) stages of strength development, a better understanding is needed of the fresh and early-age properties of such concretes (Wu et al 2009). The term ‘fresh concrete’ refers to the material state where all components are fully mixed but the strength has not yet developed. That is, the concrete is still workable and plastic. ‘Early age’ properties are those (within this research) following 15-24 hours of curing.

In this context, an experimental study was required of alternative mix designs, considering both the partial and complete replacement of the existing natural, normal-weight sand and aggregate materials. As precast elements are stripped and transported within a day of casting, it leads to a requirement for a relatively (to site cast) high strength at 12-24 hours. In turn, this is inevitably associated with an excess of concrete strength after a full period of strength development, which is then effectively not utilised over the element’s design life. Further, achieving a high early-age concrete strength is also often a key design parameter in precast design in order to mitigate possible damage or failure to the resulting components occurring during their handling (e.g. cracking or failure of lifting anchors). Whether existing design methods and equations were suitable (or could be appropriately modified) for concrete following a shorter period of curing was therefore an important question.

#### **2.4.3 Ensuring Robustness of Precast Buildings (*Objective 4*)**

The UK, US and European design regulations (ODPM 2004, ACI 2008, CEN 2006) all contain specific provisions addressing the need to design against disproportionate collapse. These have similar procedures by which the buildings are classified based upon their intended use, size and the level of risk that any potential structural collapse may present to the public. This process of building classification defines the appropriate level of structural robustness that must be achieved following the design, detailing and construction processes. However, the subsequent definition of the required structural performance tends to be highly qualitative, aspirational and subjective in nature in all of these regulatory guidance documents. They require the design engineer to achieve approval by demonstrating that their design and detailing philosophy is in line with one of their ‘approved’ design strategies. By doing this however, there is no requirement for the engineer to explicitly assess measure or justify the



resulting structural performance of the construction. There is only a need to demonstrate a compliance with the adopted strategy.

Perhaps the most commonly adopted method is where the engineer ensures that the structural elements and any resulting joints detailed are in line with the prescriptive 'tying force' provisions provided by the codes. The philosophy is based on the assumption that such details will improve the redundancy of the structure, avoiding propagation by providing alternative load paths. This is deemed acceptable however, without a subsequent need to demonstrate or justify these mechanisms by explicit calculation or computational assessment. Izzudin et al (2008) questioned the approach, querying whether the tying provisions defined allow for the true structural actions that such elements and joints will be required to resist following a partial building collapse. Given the period during which they were developed (following the Ronan point collapse in 1968) and the simplicity of the resulting equations, it is unlikely the expressions developed were intended to account for the complex dynamic and non-linear effects induced in reality. The lack of any compulsory regulation requiring the engineer to demonstrate that the adopted construction details are ductile enough to allow for the resulting large deformations induced, is perhaps the starkest indication that current design expressions do not rigorously consider realistic performance requirements for buildings exposed to accidental load conditions.

Alexander (2004) also questioned current approaches, arguing that for certain structural typologies the philosophy of ensuring structural redundancy via the provision of joint continuity may contribute to, rather than prevent a progressive collapse event. His work argues that in the event of the loss of structural stability, excessive tying may have the effect of 'dragging' out or down elements above or below the region in which the member has been removed or destroyed, questioning the blanket insistence on continuous vertical ties. This 'pull down' phenomenon was observed on an experimental concrete panel high rise block constructed and tested by the Building Research Establishment (HMSO 1968). However, no further detailed experimentation, modelling or quantification of this effect appears to have been subsequently conducted. Additionally, there is little understanding of which building types, layouts or details might be most susceptible to its realisation.

This research therefore asserts that stipulating tying provisions should be questioned. However, Starossek (2007) questions whether alternative assessment and design procedure currently exist and are acceptable. Where such methodologies have been presented (Izzuddin et al 2008; Kim et al 2009), currently they appear to lack the appropriate detailed information, data, experimental verification and necessary calibration, which would allow them to be applied in the design development process (Starossek and Haberland 2008). The sponsoring company considered this lack of current industry knowledge to be even more acute in relation to precast structures.

The procedure devised for the design of the slender precast RC panels involves a ‘push-down’ computational assessment, adopting a lumped plasticity idealisation (Section 4.1.4). This is a widely adopted model, particularly in earthquake engineering (push-over in this case) but also more recently as part of robustness assessment (Kim et al 2009). It allows the determination of the ultimate performance of a structural system by increasing step-by-step the load multiplier until failure. It was hypothesised that if the technique could predict the plastic behaviour ( $N-M_{xx}-M_{yy}$ ) of the RC panel elements, it should also be possible to apply the techniques to precast frames, their elements and connections to demonstrate a structure’s ability to meet international building regulations. Such work builds on previous investigations by Lee et al (2011) and Choi and Kim (2011) in relation to steel and RC frame respectively.

### **3 METHODOLOGY**

The purpose of this chapter is to examine the research methods available for this study. A review of research methodology is followed by a statement of the adopted methods, their applicability and benefits. The research strategy is presented to explain how the methods selected are suited to achieving the research aim. The specific methods adopted are then described and justified with reference to how they meet the research objectives (Section 2.3). These relationships are also illustrated in Figure 2.1.

#### **3.1 METHODOLOGICAL CONSIDERATIONS**

Research can be classified using a scale, which at one end is ‘pure’ and at the other is ‘applied’ (Fellows and Liu 2005). Pure research is concerned with the discovery of theories or laws of nature and the development of knowledge (inductive) whereas applied research concentrates on the end uses of knowledge and its subsequent practical application (deductive in nature). As is clear from the objectives, the research work was of a predominantly applied nature. That is, little emphasis has been placed on solving abstract problems, with the research aiming to have a direct influence on the UK precast industry through the investigation of how modern materials, manufacturing technologies and computational or design techniques can be more widely and efficiently utilised as part of industry ‘best practice’.

Two modes of enquiry are typically reflected in research, these are the ‘Quantitative’ and ‘Qualitative’ approaches. This research is entirely of a quantitative type, driven by the nature and objectives of the investigative work and deliverables anticipated by the industrial partner. This approach, often modelled on the positivist paradigm, seeks the gathering of factual data through quantifiable means, in order to address research problems, such that the amount of variations in phenomena can be tested and measured (Fellows and Liu 2005; Kumar 2005). The quantitative methodology focuses on testing hypothesis or theories by using statistically measurable variables, to obtain results that clearly determine the validity or otherwise of a hypothesis (Naoum 2006). This approach has thus been devised to better understand how non-standard strategies can be successfully incorporated in precast structures and their components.

Because of the intended end application of the research, the work (and test data associated) was designed with a view toward obtaining regulatory compliance. Therefore it was implicit that the

methods, materials and details of an ‘experimental’ research approach had to be validated through physical testing. This in turn, provided an opportunity for the design methods and products developed to be calibrated and optimised.

Due to the maturity of the research topic, the resulting investigative work is predominantly deductive in nature. This is especially the case for the research and testing work pertaining to the structural performance of the precast wall, beam and slab elements. Essentially, the research team sought to prove the appropriateness of design, analytical and computational techniques to enable novel or non standard materials or manufacturing processes. This was done by establishing, evaluating and verifying the structural and material properties, as well as the ability of analytical and computational procedures to capture the observed behaviour of the proposed non-standard application or design variation. The quantitative research type also defines both the epistemological and ontological orientation of the research set, as highlighted by Table 3.1 (Bryman 2008).

	<b>Quantitative</b>	<b>Qualitative</b>
<b>Principal orientation to the role of theory in relation to research</b>	Deductive; testing of theory	Inductive; generation of theory
<b>Epistemological orientation</b>	Natural science model, in particular positivism	Interpretivism
<b>Ontological orientation</b>	Objectivism	Constructionism

**Table 3.1 Quantitative vs. Qualitative Research Strategies (Bryman, 2008)**

It could be argued however, that the investigation in regards to the computational robustness assessment (Section 4.4) was partially inductive in nature. That is, a small sample of structural typologies and possible precast connections were considered, with the findings subsequently used to comment upon the suitability of ‘tied’ precast structures and the associated joint details in general.

## **3.2 METHODOLOGY DEVELOPMENT**

### **3.2.1 Objective 1: Design Methods for RC panels**

The need for a more accurate prediction of panel buckling capacity was identified when an attempt was made to use existing design methods in conjunction with experimental evidences, as a way to justify higher design values of panels using the European DAT method, and it was found that such methods were unsuitable. An alternative computational strategy was therefore proposed in order to achieve a truer representation of the system's non-linearity and therefore provide an improved quantification of the panel's capacity.

A lumped plasticity idealisation was identified as a viable computational tool. This is a non-linear fibre hinge used as part of a 'push-down' loading iteration to determine the behaviour of the component up to (and also beyond failure). This approach differed from those in previous studies. Doh (2002), adopted a finite difference approach to validate a full FEM model of the walls. However utilising a higher level FEM package (ANSYS) required more processing power, with only a quarter of the panel modelled so that the analysis could be run in a reasonable amount of time. Further, a large degree of specialist knowledge and experience is required with such software. This research sought a method applicable in a standard design office. The lumped-plasticity approach, which can be run on a consumer-grade laptop, was deemed a more appropriate tool.

A 'lumped-plasticity' idealisation was appropriate for predicting the failure capacity of the panel elements, because of the known and localised position of element failure consistently identified and observed in the literature, as well as in preliminary experimental tests conducted as part of this study. By using a non-linear 'fibre-hinge' element at the known location of maximum moment, (i.e. at the critical section of the RC panel), the entire inelasticity of the element is concentrated at this location. The length of the fibre hinge (the plastic region in the precast element) was based on experimentally validated data provided by Pangiotakos and Fardis (2001).

It is argued that the computational method presented will be more effective in simulating the buckling response of the slender walls relative to the existing design methods, because it will account for non-linear material and geometric effects (Section 2.4.1). This hypothesis and the

resulting predictions of structural performance are therefore validated against experimentally measured parameters, with predictions of panel capacity using this computational assessment then compared against equivalent capacities derived from current (code compliant) design methods, as well as the actual experimental data.

As detailed, the European (CEN 2002) code allows alternative design methods to be used, in conjunction with actual experimental observations. For the DAT method to be used though, the proposed design technique must be capable of closely predicting capacities relative to available empirical data. If this is the case, the alternative design practice should then achieve a more efficient design of similar RC wall members.

The DAT method (CEN 2002) defines the resulting design strength ( $\tilde{r}_d$ ) as a value that represents the 1% fractile for an infinite number of tests. In more traditional studies, where the population variance is unknown, the confidence interval is determined by a statistical mechanism such as the Student t-distribution ( $t_c$ ), i.e.  $m \pm \frac{t_c \cdot s}{\sqrt{n}}$ , where  $m$  is the mean capacity,  $s$  the standard deviation and  $n$  the sample size. This provides a useful analogy in fact, where the  $k_n$  fractile adopted (see Paper J1, Section 6.1) should be considered the equivalent of  $\frac{t_c}{\sqrt{n}}$ .

In the study undertaken, the coefficient of variation ( $V_x$ ) is unknown, with previous test data (Doh and Fragomeni 2005; Pillai and Parthasarathy 1977) also incorporated in the analysis (where similar properties can be demonstrated to exist) to provide 22 data points.

N <sup>o</sup> of tests $n$	1	2	3	4	5	6	8	10	20	30	$\infty$
$k_{\tilde{a}n}$ for $V_x$ unknown	-	-	-	11.4	7.85	6.36	5.07	4.51	3.64	3.44	3.04

**Table 3.2 Design Fractile Factors for  $V_x$  Unknown (CEN, 2002)**

Potential computational sensitivity of the adopted material model was also investigated, specifically the tension softening branch of the unconfined concrete material response (Mander 1988) and the influence of longer term creep effects. A study was also necessary to

demonstrate that no statistically significant relationship existed between design variables in the lumped plasticity representation and the model error (Paper J1, Figure 10).

### 3.2.2 Objective 2: Design of Un-Confined Reinforcement Configurations

Two structural elements have been considered as part of this research objective (Figure 1.2). Namely, simply spanning RC panels subjected to an eccentric axial load (buckling failure) and short spanning lintel elements adopting a halving-joint detail (shear failure).

Provisional testing of slender RC wall panels, as part of this research (Section 4.1.2), demonstrated that the adoption of single, centrally placed or minimum reinforcement configurations in RC wall elements (subject to an eccentric axial load), results in a sudden brittle failure mechanism. The research also showed the ‘flexural cracking’ response of the slender RC wall elements to be critical in determining the resulting buckling behaviour and ultimate failure load of the panel. This is opposed to the more conventional assumption that the element’s capacity and response can be found by consideration of the component’s ultimate flexural capacity (Sanjayan et al 1997).

The term flexural cracking is used here to describe the situation where the concrete section at the critical location cracks in flexure and the resulting concentrated loss of stiffness, (combined with the lack of influential tension steel) controls the resulting structural behaviour and ultimate stability of the panel much more than would occur with doubly reinforced panels, where  $\rho = A_s/lt \geq 1\%$  (Kripanarayanan 1977). Hence, the axial capacity of the RC wall element becomes dependent on the element’s flexural stiffness up to and post cracking. Consequently, appropriate account needs to be taken of the contribution of the concrete acting in both the tension and compression stress block as part of the design of the element. Furthermore, this flexural cracking response has been shown to control the behaviour and capacity of centrally reinforced panel elements adopting unconfined rebar configurations, up to a steel ratio of  $\rho = A_s/lt = 3\%$  (Pillai and Parthasarathy 1977).

The controlling failure mechanism of the identified RC wall elements will therefore, in part, be influenced by the formation and subsequent progression of flexural cracks in the concrete at the panel’s critical section. It follows that if the behaviour of such cracks is significant

when determining the structural response, the incorporation of steel fibre reinforcement should influence the resulting behaviour and hence ultimate capacity (see Section 2.4.1). The experimental testing therefore aimed to quantify the anticipated increase in structural capacity and ductility of wall panels made from an SFR concrete.

The second part of the experimental investigations focused on the design of precast lintels/beams with dapped ends. The European code prescribes two alternate STMs and reinforcement provisions for the detailing of halving joints (Figure 3.1). Theoretically, either of these models can be used depending on the reinforcement provision. They can also be combined, as suggested by Schlaich and Schafer (1991). The model on the left is similar to the example provided by ACI Subcommittee 445-1 (2002) with the diagonal strut from top of the main vertical tie back down into the beam. However, disagreement currently exists in respect to whether this model provides an accurate reflection of the crack propagation from the re-entrant corner, as the compressive strut should prevent this occurring. The experimental program of this research was devised to establish whether this model would accurately reflect the behaviour of samples from the crack propagation observations, and hence its suitability for the design of dapped end members to EC2. In addition, the experimental results were also used to evaluate the applicability of the models currently prescribed in the codes for the design of precast samples adopting welded mesh reinforcement, with or without the inclusion of SFR.

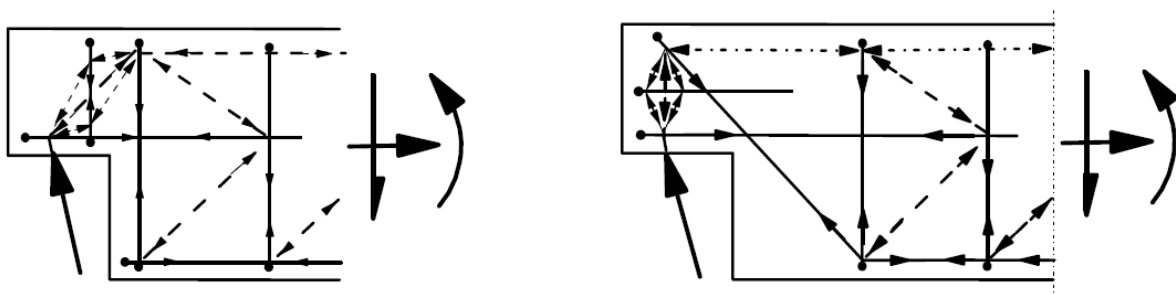

Figure 3.1 Indicative Models for Reinforcement in Half Joint (CEN 2004)



### 3.2.3 Objective 3: Alternative Aggregate Materials in Precast Concrete Mix Design

European standard design guidance (CEN 2004) explains how the material properties of lightweight concretes should be modified when designing structural elements. However, there is a lack of experimental evidence supporting the suitability of these generic expressions to correctly capture the behaviour of SPFA mixes, and more specifically the validity of using values of concrete cylinder strength ( $f_c$ ) to predict the tensile splitting ( $f_{ct}$ ) or for predicting the pull-out capacity of an anchor. It was also of interest to establish whether published empirical relationships reflect the behaviour of lightweight concretes made with SPFA, with the Elastic Modulus ( $E_c$ ) the characteristic most significantly affected in this instance.

The experimental campaign focussed on the high-strength, high-flow concrete mixes commonly adopted in the precast industry, examining the mechanical properties directly relevant to the manufacture of structural units, namely: concrete flow, compressive strength, modulus of rupture, Young's modulus and pull-out shear capacity. Historical research identified that the inclusion of SPFA leads to a reduced structural capacity and stiffness (Shimazaki et al 1994). These studies considered SPFA concretes relative to normal weight control samples following 28 days of strength development. Because of the reduced performance suggested, relative to the control sample, this study also aimed to establish if steel fibre reinforcement (SFR) potentially offered a solution through which any loss of performance may be corrected for. This is a strategy suggested in the literature for other concrete mixes and applications (Hsu and Hsu 1994; Kayali and Haque 2003) and fitted in well as part of the research project as a whole, alongside the incorporation of SFR in precast panel and lintel components (see Section 2.4.1).

### 3.2.4 Objective 4: Suitability and Improvement of Robustness Methods

The major international design codes demonstrate the robustness of buildings through any one of four potential design approaches. These include meeting prescriptive 'tying force' or alternative 'anchorage' provisions (Section 2.4.3). It should be noted, that clauses pertaining to anchored connections are only relevant to the UK and European regulations for class 2A and 2Lower buildings respectively. Alternatively the engineer may achieve compliance by

---

ensuring that either the 'Notional Member Removal' or 'Key Element' provisions have instead been met.

Most pertinent to this study are the assessment methods that can be adopted as part of a notional member design. This requires the engineer to demonstrate that following the loss of any vertical load bearing member, the remaining structural components will have sufficient 'capacity' to transfer any resulting actions, through the establishment of alternative load paths. The term capacity is taken to refer to the critical property preventing structural collapse and may therefore relate to element strength, deformability, ductility, stability or stiffness. The provision however, is applied using conventional design checks despite authors such as Izzudin et al (2008) having questioned this approach. That is, this too simplistic a representation fails to correctly account for the nonlinear geometric and material effects induced.

However, if such complexities could be appropriately incorporated, the notional column procedure does provide the required performance based assessment. That is, studies such as those by Kim et al (2009) and Lee et al (2011), demonstrate the procedure allows for a more appropriate consideration of the progressive collapse phenomenon by assessing the plastic response of the structure to pseudo-dynamic loading. The engineer therefore becomes able to better assess the actual capacity of the structural system. The study undertaken as part of this research programme asserts that, because no robustness performance metric is currently defined in the design regulations, and because a building designed using any of the available design approaches can be considered to be robust, it must therefore be the case that a building designed using any one of the possible design strategies will achieve a minimum 'adequate' robustness or level of performance. That is, a building designed using the prescriptive tie or anchorage rules should be able to sustain the actions imposed on it under an assessment conducted to meet the notional column removal provisions. This therefore presents an opportunity to assess the adequacy of current tying and effective anchorage rules for ensuring the insensitivity of typical precast concrete building to a progressive collapse.

This was done through a non-linear push down computational study, with such assessments having historically been shown to be suitable for robustness assessment and design against disproportional collapse (Kim et al 2009, Lee et al 2011). The study by Marjanishvili and

Agnew (2006) compared the various available analytical procedures (linear-elastic static, nonlinear static, linear elastic dynamic and non-linear dynamic). They concluded that the 'push-down' procedure (nonlinear static) provided an effective simulation of building collapse, if appropriate pseudo-dynamic load factors are adopted, and for buildings where dynamic behaviour patterns can be intuitively identified.

It was deemed that a non-linear static approach was the most suitable for use and application in a structural design office and consequently was considered to be most in line with the objectives of this EngD research project. Less specialist knowledge and software is required when considered against a non-linear dynamic assessment. The improvements in modelling efficiency, which Marjanishvili and Agnew (2006) showed to result when adopting a non-linear dynamic compared to a non-linear push-down, were therefore considered not to be significant enough when compared to the other advantages offered by the chosen procedure.

The non-linear push-down analysis was also found to be capable of investigating both the joint details and the building's susceptibility to any secondary effects that may compound the advancement of a progressive collapse. For example, the computational model would allow an engineer to see if the collapsing portion of the building had the effect of pulling down, or imparting an otherwise detrimental load case to, the majority of the structure. In this way the procedure allowed us to investigate and evaluate the key concerns (Section 2.4.3) associated with tied and anchored precast buildings in a quantifiable and auditable manner.

### **3.3 METHODS**

A research method is considered a technique for collecting data (Bryman and Bell 2007). The primary research methods employed in this study are discussed in detail below.

#### **3.3.1 Literature Review**

Literature review plays a significant role in research, as it provides the basis for justifying the research questions and developing research designs. In addition, it informs how data is collected and analysed (Bryman and Bell 2007). The literature review stage of this study enabled the RE to place the project in the context of the current views and debates on the subject matter. This study involved an initial general review of literature and further review at

the start of each phase throughout the project (see Figure 2.1). The initial literature review involved an examination of current challenges, restrictions, best practice and innovations in the precast industry to highlight areas (e.g. products, practice, and manufacturing techniques) where an improved performance may be realised. Subsequent review allowed the RE to better understand any limitations associated with the assessment and design of precast structures to the major international design codes. Work intended to highlight and quantify the potential for any structural efficiency and optimisation that may exist from previous analytical and experimental studies, as well as to inform any necessary future programme of testing and analytical investigation. Findings from the literature review have been detailed in Section 2.4, as well as in the published papers (Section 6), with the key references cited in them.

### **3.3.2 Experimentation**

A logical structure for the quantitative research process has been outlined by Bryman (2008) as: *Theory, Hypothesis, Observations, Data Analysis and Findings*. This process has been used as a basis for this research, with guidance on the design of the experiments from Lewis-Beck (1993). The methodology used has taken into account: *variables, measurement errors, reliability, validity, control and generalisability*, which have been highlighted as key failings of past experimental quantitative research (Lewis-Beck 1993).

Section 4 details the experimental programmes conducted as part of this study. It was necessary to carry out both small-scale testing, to better understand material characteristics and behaviours, as well as trials on full scale structural components. Preliminary testing was also used extensively in order to establish if further investigation was warranted. That is, whether the potential improved performance or efficiency suggested by the desk study could be realised. These tests were also used to inform the experimental practice going forward. Ease of experimental set-up, methods of data capture and issues associated with safe working could for example be established, reviewed and improved upon if necessary.

Some experimental methods employed were in accordance with UK or European codes of practice. These methods were often associated with establishing material characteristics, behaviours and properties (e.g. concrete cube or cylinder strength). Further, certain aspects of structural performance (e.g. the pull-out capacity of cast in lifting anchors) were established through the application of standard testing equipment and procedures. In contrast, bespoke

procedures and set-ups had to be considered, for the testing associated with establishing the behaviour of the full scale precast components. Towards this, the literature reviews and preliminary testing conducted were used to inform the ways in which the test methods could be used to provide the necessary information. Novel data collection methods were also developed to improve the experimental data collection in certain circumstances (Section 5.4). In conjunction with physical experimental work, a number of numerical investigations were also necessary. The work consisted of developing computational and analytical representations of the experimental set-up. The research team were then able to use the test data to validate the numerical procedures trialled. This in turn should allow such methods to be used in the design development of precast components and structures in the future.

### **3.3.3 Statistical Analysis**

Statistical analysis involves the interpretation of data, normally in numerical form aimed at summarising and describing the data collected (descriptive statistics). Techniques can also be used to investigate patterns in the data in order to draw conclusions about the population under study with due consideration to the uncertainty and randomness in observations referred to as inferential statistics (Fellow and Liu 2003). Statistical analyses conducted as part of this study are detailed in Section 4.

### **3.3.4 Sensitivity Analysis**

A number of investigations to assess the sensitivity of the experimental data and the computational and analytical representations were also important. This involved the introduction of appropriate variation to the adopted testing arrangements, analytical models, material properties, structural geometry or loading conditions. Work was aimed at evaluating the resulting effect on a final design consideration and thus provides information in regards to its suitability.

## 4 RESEARCH UNDERTAKEN

### 4.1 OBJECTIVE 1: DESIGN METHODOLOGIES FOR RC PANELS

#### 4.1.1 Task 1(1) Investigation into the Suitability of Existing Methods for Minimally or Centrally Reinforced Panel Elements

A literature review investigated the existing experimental, analytical and computational research into slender RC panels subjected to an eccentric axial load, and the principles associated with the development of the current design equations and methodologies. Additionally a desk study focussed on the implications of the European design codes, as they apply to the design and manufacture of the same panels, with the work considering the pertinent differences in design aspects between EC2 and the other major international codes.

The evidences collected demonstrated that EC2, ACI-318 and AS-3600 do not provide a suitable method for predicting the buckling capacity of minimally or centrally reinforced concrete panels (Robinson et al 2011b). For example, Figure 4.1 illustrates that to each of the major design codes (and for the two distinct design methods available) an RC wall panel will have zero capacity when  $\lambda = 30$ . This is despite Fragomeni et al (1994), Crozier and Sanjayan (1997) and Doh and Fragomeni (2005) demonstrating this is not true. In addition, evidence collected as part of the desk study questioned the applicability of the equivalent column methodology due to the dominant tension-softening response of the wall types considered (Robinson et al 2011a).

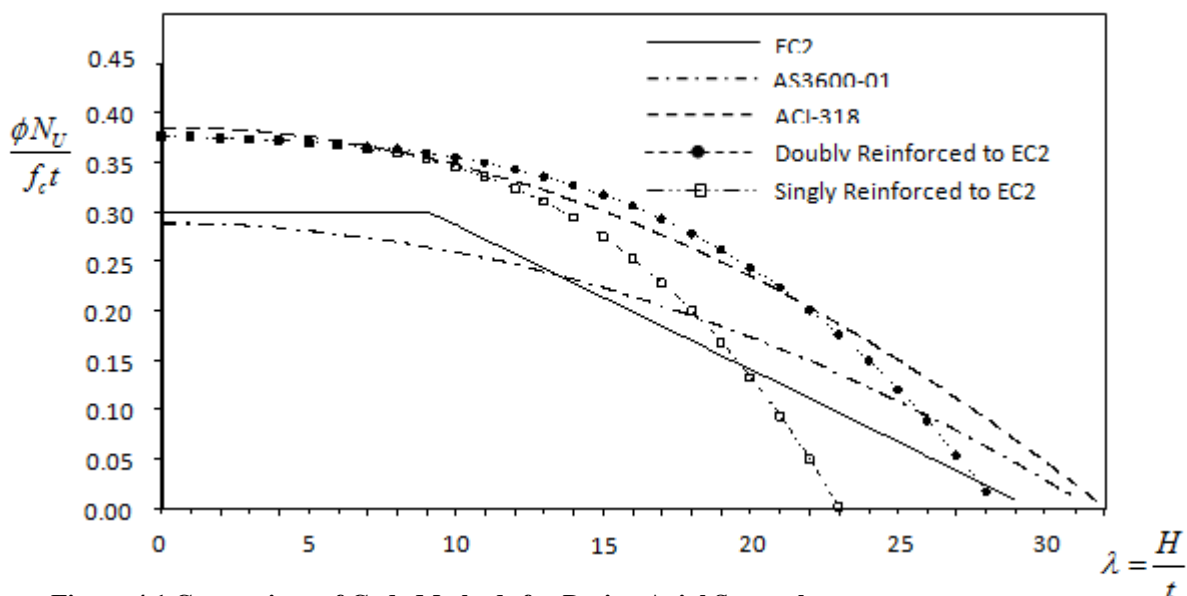

Figure 4.1 Comparison of Code Methods for Design Axial Strength

#### 4.1.2 Task 1(2) Preliminary Experimental Works to Establish Buckling Behaviour

Six  $L = 500$  mm wide and  $t = 100$  mm thick pre-cast concrete panels of varying height and slenderness ( $\lambda$  between 25 and 30) were axially loaded, with a range of eccentricities also adopted to reflect common construction and design cases. An overview of the experimental arrangement is illustrated in Figure 4.2, with the reinforcement layout adopted also illustrated within Figure 4.4 (b). As another research task was to assess the sensitivity of a panel's buckling capacity to the element becoming cracked at its critical section, six of the panels were axially loaded in a pre-cracked condition, with the fissure induced in flexure, prior to loading

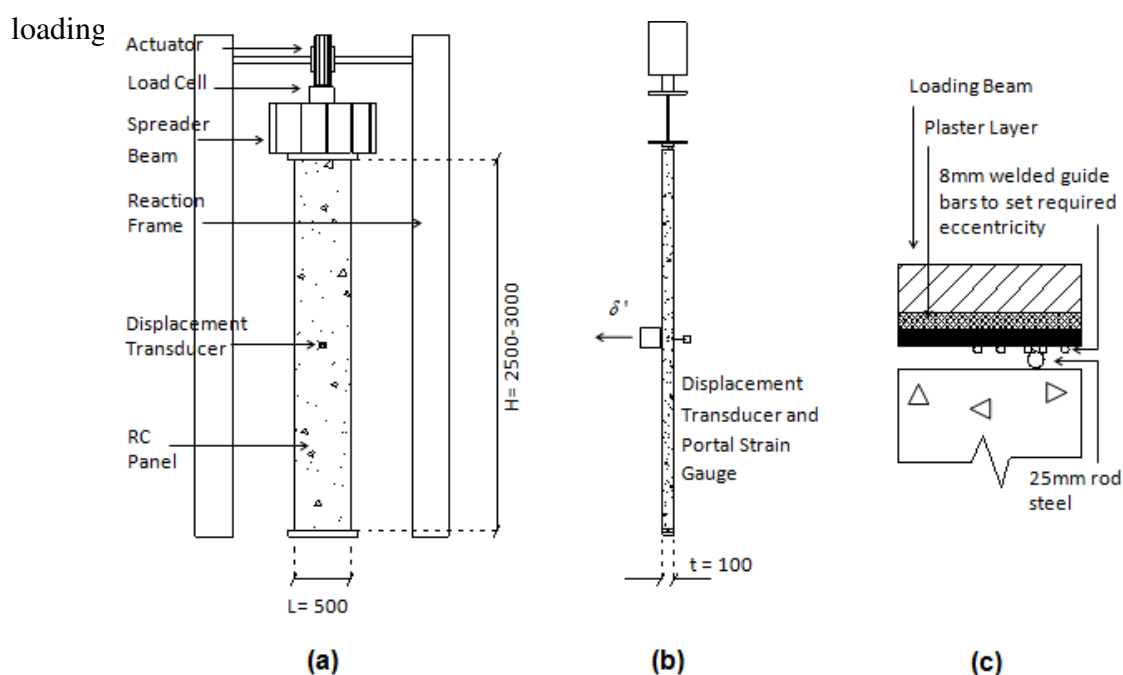

Figure 4.2 Experimental Set-up for RC Panels: (a) Test Rig Elevation; (b) Section; (c) Pin Joint Detail (Robinson et al 2013-Paper J1)

#### 4.1.3 Task 1(3) Investigations into the Potential Application of the Design Assisted by Testing (DAT) Methodology

This initial experimental testing conducted demonstrated that the ultimate capacity of the panels (as expected) far exceeded the predictions of both simplified code equations and equivalent column methodology as enabled in EC2 (Robinson et al 2011a).

Experimental findings thus supported past research, and confirmed that simplified design equations provide overly conservative estimates of slender RC panel capacity. The term ‘capacity’ is used here to describe the load at which the panel fails in buckling due to the application of an eccentrically applied axial load. More importantly, the testing campaign also demonstrated that the axial capacity of centrally reinforced elements is effectively independent of the flexural tensile strength of the concrete, as similar capacities were experimentally observed for panels in the cracked and un-cracked initial condition. That is, six panels were cracked in a three-point bending arrangement through the entire section of the panel element prior to loading the element axially. In this way the tensile contribution of these panels can be negated. This is one of the key findings of this testing, as it allows us to conclude that the contribution due to the concrete’s post-cracked behaviour (specifically the response of the compressive stress block) is crucial in determining the element’s capacity. That is the ‘flexural cracking’ response can be considered as dominant (Section 3.2.2). The observed failure typology also supports this finding, with a compressive spalling seen, along with extensive flexural cracking for both the cracked and un-cracked initial conditions (Figure 4.3).



**Figure 4.3 Panel Buckling Failure: (a) Unconfined Central Welded Mesh; (b) Welded Mesh with a  $50\text{kg/m}^3$  SFRC Content**

Moving from the above considerations, the investigation then examined whether the experimental results obtained from the testing programme could be used to derive a more representative design curve by application of the DAT method. Findings (Section 5.1) suggested that because a large and systematic conservatism appears to exist between experimentally observed capacities and the current design procedures, the existing methods may not be able to provide a design, or ‘resistance’ function for the DAT procedure. An alternative approach would therefore be required to predict ultimate capacity of the elements.



#### 4.1.4 Task 1(4) Development of an Alternative Computational Method

In addition to addressing the need for RC panel design to account for the ‘flexural cracking’ buckling response of centrally or minimally reinforced panels, any alternative methodology adopted/ developed also had to enable the design engineer to quantify the effect of adopting non-standard concrete mixes and reinforcements on the buckling behaviour and capacity of the panels. An alternative, non-linear, computational representation of the buckling response of a one way spanning slender RC panel was identified as a possible solution. The work aimed to evaluate whether such a model could better assess and more correctly account for the geometrical and material non-linearity associated with the failure typology.

For the structural problem in hand, the entire inelasticity of the element can be concentrated at a single position through a non-linear fibre ‘hinge’ (Paper J1 Section 6.1). This is considered valid since the location of maximum moment (and thus the critical section for the span) is known (see Figure 4.4(a)). In this representation, the element’s cross-section is subdivided into a number of elementary layers or fibres (SAP2000 2010), to which the appropriate material properties are then assigned (see Figure 4.4(c)).

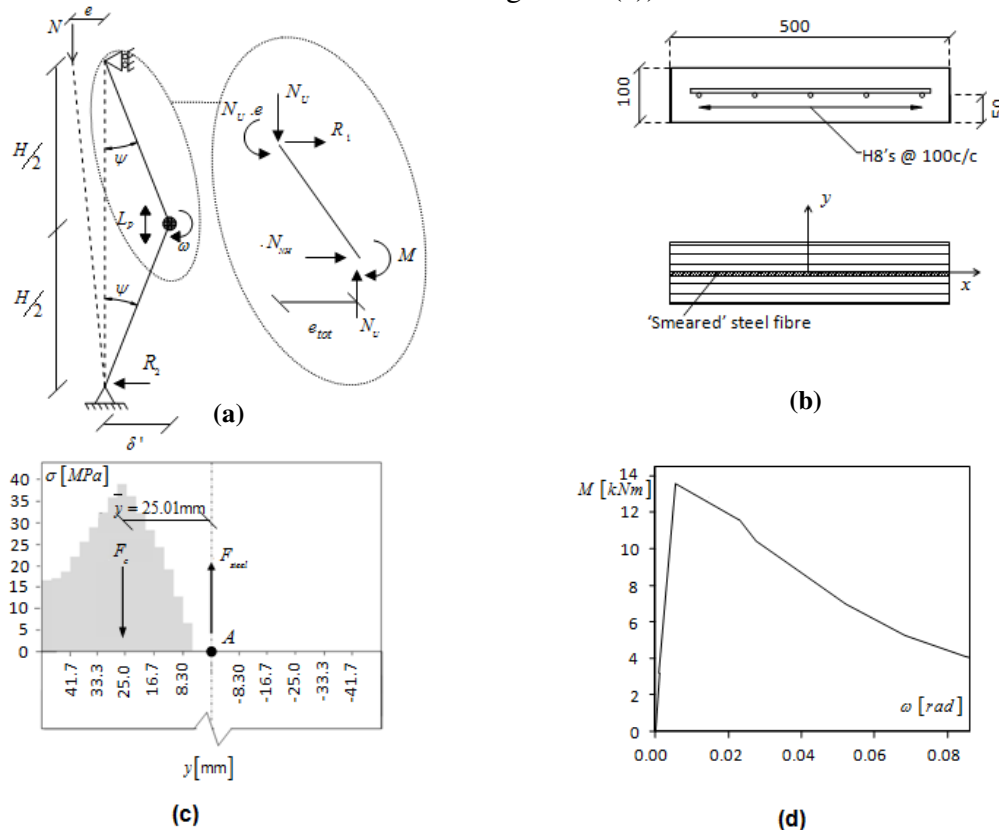

**Figure 4.4 Key Aspects of the Lumped Plasticity Analysis: (a) Computational Idealisation of Experimental Set-Up; (b) Reinforcement Layout and Fibre Hinge Idealisation of Wall Panel Cross Section; (c) Resulting Compressive Stress Block; (d) Resulting Moment Rotation Response of Fibre Hinge (Robinson et al 2013-Paper J1)**

The non-linear moment-curvature relationship of the fibre hinge can then be determined (Figure 4.4(d)) for a range of axial loads assuming plane cross sections. Importantly, the concrete material model can be easily modified if the performance of other concrete types, such as high-strength concrete or fibre reinforced mixes, has to be accounted for. Because a displacement-controlled non-linear push-down analysis is adopted, it is also possible to assess the resulting deformations and strains induced in the fibre hinge incrementally up until (and also beyond) the ultimate failure load.

To validate the proposed method a greater degree of experimental data was required, with the extent of the further testing (16 panels) detailed as part of journal Paper J1 (Section 6.1). The numerical outputs from the computational idealisation (in terms of deflection and strain relating to the ‘tensile’ face of the buckling panel) were then compared against the actual experimental data to investigate whether the adopted computational strategy was capable of accurately capturing the true structural behaviour of the RC wall elements. It was also possible to quantify any improved correlation between experimental data,  $r_{e,i}$ , and the theoretical prediction of buckling capacity  $r_{t,i}$ , in order to assess the appropriateness of the alternative method to be used in conjunction with the DAT procedure. This assessment is conducted through consideration of the angular coefficient  $b$  of the regression line for the proposed approach. The check is done by considering the least-squares best fit to the slope  $b$  between  $r_t$  and  $r_e$  (see Journal Paper J1, Section 6.1). If the corresponding angle with the horizontal axis ( $\theta = \arctan(b)$ ) was shown to have an acceptable fit to the ideal value ( $\theta = 0.785$ ) the test data could thus be used to develop a design capacity curve.

## **4.2 OBJECTIVE 2: DESIGN AND ADOPTION OF UN-CONFINED REINFORCEMENT CONFIGURATIONS**

### **4.2.1 Task 2(1) Investigation into Achieving More Suitable Ductile Failure in Panels**

As discussed in Section 4.1, it can be demonstrated that the capacity of wall panels adopting centrally placed welded mesh re-bar in an unconfined configuration, is dominated by the post-cracked behaviour of the panel and in particular the response of the compressive stress block. However, the failure mode observed (within preliminary testing) when this unconfined re-bar configuration is adopted is of a sudden and brittle nature (Robinson et al 2011a), with the concrete

within the compressive zone locally spalling (Figure 4.3). The spalled region however, emanates distinctly from the flexural cracking progressing from the tension zone of the concrete section. The zone Pilot testing, investigating the use of unconfined configurations in precast lintels (Argyle et al 2011) demonstrated another sudden and catastrophic failure of the concrete.

The potential utilisation of SFR as a means of inducing a more ductile failure mechanism in the precast element (see Section 2.4.1) became apparent as part of the literature review conducted. However, experimental testing was deemed necessary due to a lack of existing data and published design guidance relating to precast elements adopting a hybrid of welded mesh reinforcement and an SFR content.

### **4.2.2 Task 2(2) Investigation into Achieving More Suitable Ductile Failure in Panels**

The testing relating to precast wall panels was designed to investigate whether and how the application of an SFR concrete mix influences the resulting structural response and capacity of such panels. If any benefit could be derived however, the development, justification and validation of a possible design procedure would also be necessary for the alternative precast wall components to be considered to be code compliant and adopted as part of an actual precast building. Because of this, the potential application of the computational procedure developed as part of Task 1(2) for this alternative panel design case was also investigated. This was done as it was believed that the computational procedure developed would be able to account for the non-linear material response of the fibre concrete. The experimental data was also used to evaluate the appropriateness of assumptions made in the computational idealisation, such as the length of the plastic hinge adopted (Paper C1, Section 6.3).

Eight 500mm wide, 100mm thick and 3000mm tall panel elements were cast adopting C40/50 grade concrete mix (500kg/m<sup>3</sup> CEMI, 840kg/m<sup>3</sup> Gravel<20mm, 900kg/m<sup>3</sup> Sand<4mm, 0.8% Super-plasticizer, w/c=0.36, Flow=650-700mm). Four of the samples were reinforced solely using a single, centrally placed layer of mesh reinforcement to form the unconfined reinforcement configuration illustrated in Figure 4.4(b). The four additional panels tested adopted an identical reinforcement configuration to that illustrated although, in these cases, additional steel fibre content (50kg/m<sup>3</sup>) was also incorporated. In this way, the potential for any improved performance through such a hybrid reinforcing strategy could be quantified. The double hooked end fibres used

were 50mm long, 0.75mm in diameter, had an aspect ratio of 67 and a tensile strength greater than  $1100\text{N/mm}^2$  (Figure 2.4).

The eight panel elements were then axially tested using the experimental setup illustrated in Figure 4.2. The testing rig used for the experiments was capable of applying a load of 4000kN, with the loading beam designed to ensure the transmission of a uniformly distributed load across the top of each panel at eccentricities of 17mm ( $t/6$ ) and 33mm ( $t/3$ ). The smaller of the adopted eccentricities was chosen to reflect the maximum load off-set allowed for in the major international design regulations ( $t/6$ ) investigated (CEN 2004; ACI 2008). The larger eccentricity ( $t/3$ ) was also incorporated to investigate if using SFR in conjunction with un-confined longitudinal reinforcing steel could potentially offer an engineer the opportunity to justify such panel elements for resisting a more demanding load case.

#### **4.2.3 Task 2(3) Investigations into Un-confined Reinforcement Configurations in Shear**

Additional experimental work focused on beam samples in which a centrally placed, unconfined and welded reinforcement mesh was used. The testing was aimed at increasing the understanding of the shear behaviour and capacity of the D-regions (Section 1.3). Further samples used a percentage of steel fibre content, in conjunction with the welded re-bar configuration, to establish any improved performance possible through adopting a hybrid reinforcing strategy. The structural testing also aided in the development and verification of an analytical STM, capable of accounting for such a non-traditional reinforcement strategy.

The geometry of the specimens tested and the welded mesh reinforcement layout adopted are illustrated in Figure 2.2 with greater detail also provided in Paper C1 (Section 6.3). Specimens adopting a confined shear ‘cage’ reinforcement were also manufactured and tested (see Figure 4.5), to provide a control sample and so that the performance of the welded mesh can be directly compared to an industry standard reinforcement design. Because the objective of the experimental program was to study the behaviour of the D-Region of the precast lintel component, a member length of 1415mm was adopted so as to ensure that the region controlling the element’s capacity was that under investigation. All reinforcing bars used in the manufacture of the samples were 16mm in diameter, with a cover of 25mm maintained throughout. The bars were MIG welded, with all anchorage forces and requirements

appropriate to the resulting welds calculated in line with the relevant EC2 (CEN 2004) provisions.

Four samples were cast and tested for each variation of reinforcement configuration. Strains were measured using LVDT gauges, with demec pips used to check the readings (up to first cracking). Strain progression was also measured using photogrammetric techniques, which provided a further validation to the readings (Section 5.4). The data collected allowed the research team to establish how altering certain variables, to do with the concrete mix and reinforcement strategies, affected the behaviour and ultimate shear capacity of the dapped end relative to the confined control. How such behaviour could be captured and predicted in the analytical models and design procedures developed was also investigated.

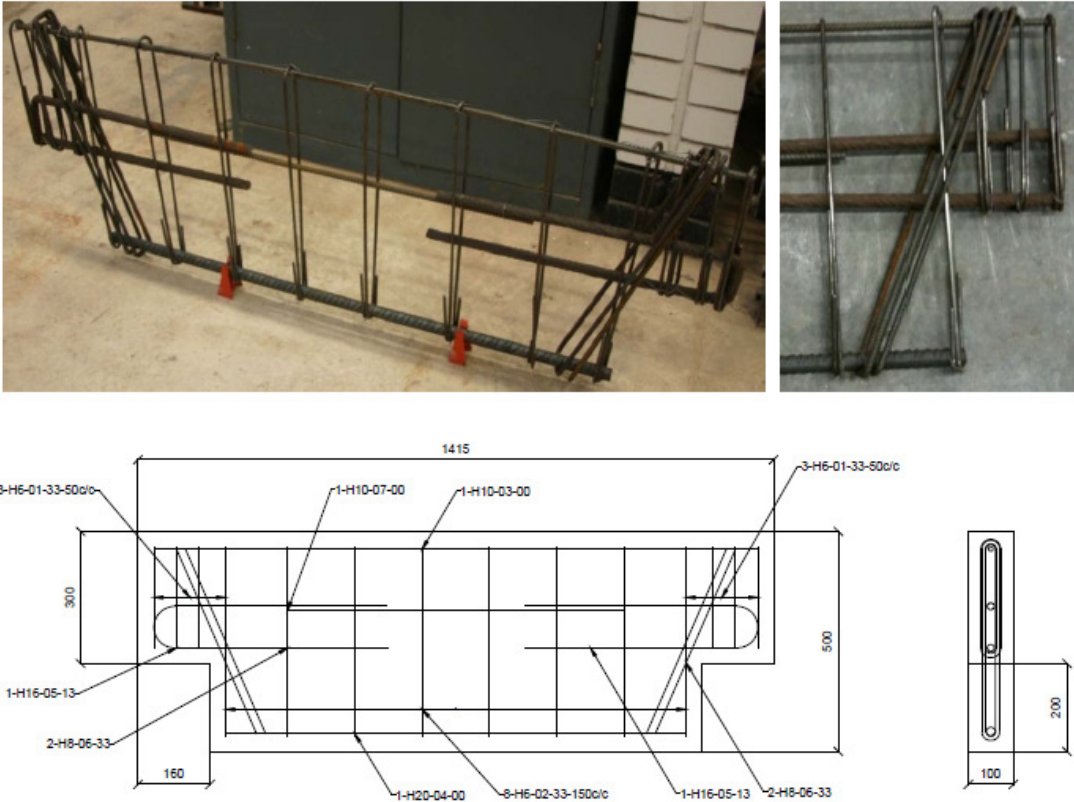

Figure 4.5 Confined ‘Cage’ Reinforcement Configuration for Precast Beam Samples.

### 4.3 OBJECTIVE 3: ALTERNATIVE AGGREGATE MATERIALS

#### 4.3.1 Task 3(1) Lightweight Floor Slab Element

A structural design was developed for the proposed lightweight slab element, with a technical feasibility assessment also conducted to identify any necessary modifications required to the manufacturing process to account for the SPFA aggregate and sand materials. It was found that the effects of using lightweight aggregate and sand products have been the subject of numerous previous studies and can therefore be considered to be well known in relation to the 28 day (and later) stages of strength development. However, despite such properties being particularly significant in the manufacture of precast units (see Section 2.4.2), it was also found that there appears to be a lack of data available in relation to the behaviour of lightweight concretes both in the fresh concrete state and the early-age stages of the hardened concrete's strength development. Therefore the sponsoring organisation lacked the necessary data to properly assess the impacts that adopting such alternative materials will have on the existing manufacturing, lifting, transportation and installation processes, as well as the structural performance of the element.

#### **4.3.2 Task 3(2) Material Testing**

An experimental study (see Journal Paper J2, Section 6.2) was therefore deemed necessary, with a specific focus given to the high-strength, high-flow concrete mixes commonly adopted in the precast industry. The study allowed the effects of wholly or partly incorporating such alternative aggregate and sand types (in relation to early age properties) to be quantified, with the application of material and small scale structural testing allowing properties such as concrete flow, compressive strength, modulus of rupture, Young's modulus and pull-out shear capacity to be determined. Such information subsequently enabled the feasibility of these mixes to be assessed and optimised, towards incorporation in the larger scale slab element.

The early age pull-out strength of commonly utilised lifting anchors in the SPFA concretes was also tested. This was because it was felt important to understand (from an operational stand-point) whether the capacities of the chosen anchor type will be similar in the new concretes relative to those currently adopted (i.e. the control mix in the testing programme). Therefore standard industry testing was carried out so that a design value for the pull-out load of the adopted lifting anchor could be determined, in line with regulatory requirements. Journal Paper J2 (Section 6.2), details the testing undertaken and the values determined for the required design variables.

Six 100mm cube samples were cast for each period of curing (i.e. at 24 hours, 7 and 28 days) and for each of the eight mixes, giving a total of 144 (6x3x8) cubes. Further, six 150x500mm cylinder samples were cast per mix, so as to determine the early age Young's modulus of the relevant concretes as part of a non-destructive test, with these same samples then subsequently used to derive values of the indirect tensile strength ( $f_{cr}$ ) from a split cylinder test. Forty-eight (6x8) 100x100x500mm beam samples were also cast to determine the flexural indirect tensile strength ( $f_{sw}$ ). That is 6 beam samples were tested in a four point bending arrangement for each of the eight postulated mixes. Three further 500x600x100mm slab elements were additionally manufactured for mix types A, E and F (see Paper J2-Section 6.2), to investigate the pull-out behaviour of the selected anchor type. The testing sample sizes, concerning the determination of material properties and anchor pull out performance, were chosen to comply with the relevant regulatory guidance. That is, as advised in BS EN 12390 (BSI 2009) and TR 15728 (CEN 2008) respectively.

### **4.3.3 Task 3(3) Concrete Mix Design to Establish Comparable Performance to Control**

The experimental study progressed to also consider the practicalities and benefits of adopting a quantity of steel fibre reinforcement in conjunction with the self-compacting SPFA concrete mix. This was done when it was established that the introduction of lightweight materials led to a reduction in performance, with respect to any of the chosen structural performance metrics. The additional testing aimed to determine whether this secondary reinforcement was able to improve the early age material properties of the concrete (specifically the pull-out shear capacity of lifting anchors) such that the engineer was able to obtain a comparable material performance. Because steel fibre reinforcement is commonly employed in the manufacture of precast structural units, and because existing literature suggests that this reinforcement type provides a measure through which the loss of the observed performance may be corrected for, a material testing programme was undertaken to quantify its effects. Findings of these experimental works were also incorporated as part of Journal Paper J2 (Section 6.2).

---

## **4.4 OBJECTIVE 4: SUITABILITY AND IMPROVEMENT OF ROBUSTNESS METHODS**

### **4.4.1 Task 4(1) Investigation into the Suitability of Existing Disproportionate Collapse Tying Provisions**

As detailed in Section 2.4.3, the existing literature identified that an industry need exists for an assessment methodology, which allows for the performance of a precast structure subject to a structural damage event to be quantified. One potential method identified (Section 3.2.4) was through a non-linear 'push-down' computational assessment, with the method also having previously been successfully adapted for the robustness assessment of both steel and RC building typologies (Kim et al 2009; Choi and Kim 2011). Although the computational technique can therefore be considered to be a suitable tool for performance-based design, no such similar analysis appears to have yet been conducted for common precast building types.

The exact computational procedure used was that defined by the General Services Administration (GSA 2010) regulations. That is, a stepwise increase in the amplitude of applied vertical loads is applied until the maximum specified load is reached or a collapse is observed (Marjanishvili and Agnew 2006). Although the 'push-down' method cannot capture the instantaneous dynamic effects associated with aspects such as column loss events or debris loading for example, studies (Izzuddin et al 2008; Marjanishvili and Agnew 2006) have shown that the application of factored 'equivalent' pseudo-static load cases can acceptably allow for these actions and effects.

The assessment was used as part of this research to establish the suitability (or otherwise) of existing code specified 'tying' and 'anchorage' force provisions (Section 2.4.3). The adopted analysis models have been designed to represent a precast framed structure with a 7.5×7.5 m structural grid and a floor to floor height of 3.8m. Models representing a 'tied' frame design for buildings of two, four and ten storeys were analysed. Alternative models adopting effectively anchored connections were also considered for the two and four storey frames, with the elevations for the analysed buildings detailed in conference Paper C2 (Section 6.4).



The proposed non-linear, static robustness assessment procedure is of course highly dependent on the adopted representation of the plastic properties of each component, as well as their connections (Inel and Ozmen 2006). That is, our understanding of the ultimate inelastic deformation capacities of the components detailed in terms of their geometric and mechanical characteristics should be captured. The required non-linear load-deformation relationships have previously (Kim et al 2009; Lee et al 2011) been based, on those values published in seismic design guidance, such as ASCE 41-06 (2007). However, these values do not account for the effect of significant variations in the axial forces applied to the components. Such forces and variation, will though be much more critical in a progressive collapse simulation, as they will significantly affect (in potentially both a beneficial and detrimental manner) the rotational behaviours (and thus capacities) of the elements and connections.

Therefore, a much more effective method of capturing the structural behaviour of the RC elements was considered to be through ‘fibre-hinge’ elements (Figure 4.4), in a manner similar to that adopted when modelling the buckling failure of minimally reinforced precast simply wall panels (Section 4.1.4). In this way it is possible to determine an effective representation of the non-linear moment-curvature relationship for the structural component, also accounting for the proportion of axial load applied. The non-linear load deformation characteristics derived were also validated against relevant experimentally derived values (Panagiotakos and Fardis 2001). The associated structural behaviour was then incorporated in the computational models as non-linear ‘hinge’ elements that are specified at the locations where the applied lateral and gravity loads are considered to produce maximum effects. That is the plasticity of the structural components (modelled as an N-M hinge) is assumed to be lumped at the centre and ends of the beam and column elements (Paper C2, Section 6.4). Such an analytical element allows the interaction and combined effects of the axial load and moment to be captured within the 2D frame.

The adequacy of current tying and effective anchorage rules could thus be assessed in a quantifiable manner (in line with the methodology detailed in Section 3.2.4). The computational study forms the major basis for conference Paper C2 (Section 6.4). As can be seen from this paper the work highlights the need for current design and detailing practice to

take more appropriate account of the nonlinear response of the components and joints incorporated in multi-storey buildings

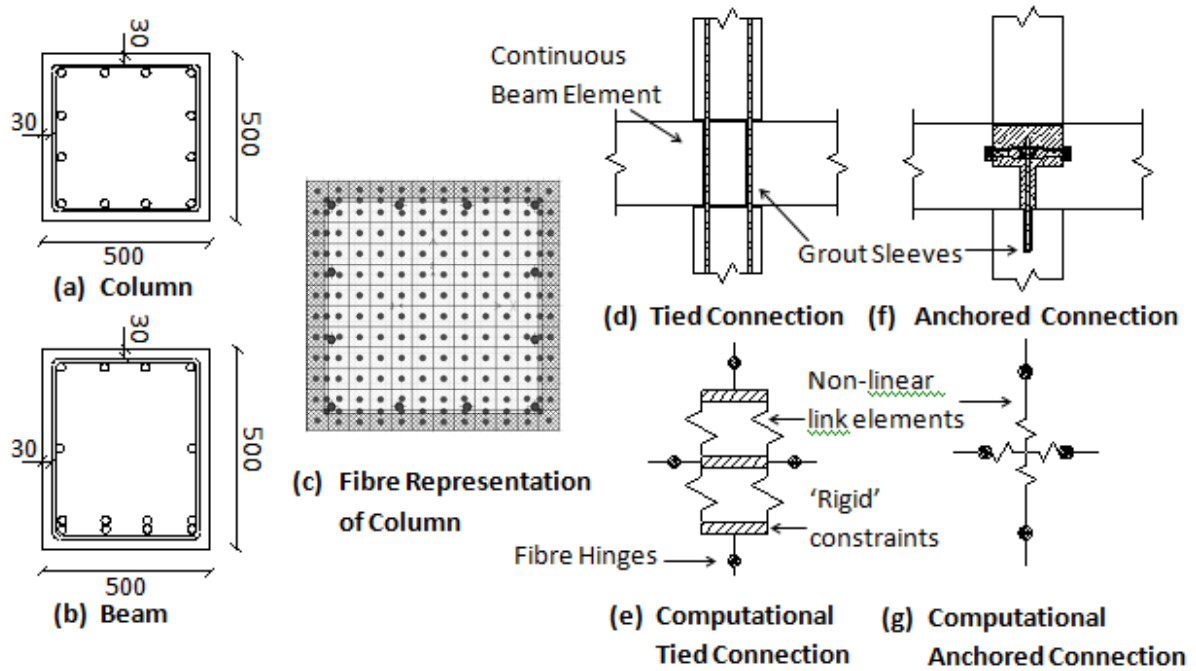

Figure 4.6 Structural Sections, Connection Designs and Computational Equivalents (Robinson et al 2013-Paper C2)

## 5 FINDINGS AND IMPLICATIONS

This chapter presents the key conclusions from the research, along with its impact on the research sponsor and the wider construction industry. The research process and its outcome are then critically evaluated following which recommendations are put forth for areas of future research.

### 5.1 THE KEY FINDINGS OF THE RESEARCH

#### 5.1.1 Objective 1: Design Methodologies for RC Panels

The experimental findings were found to confirm that simplified design equations provide overly conservative estimates of slender RC panel capacity (see Table 2, Paper J1). The testing campaign also demonstrated that the axial capacity of centrally reinforced elements is effectively independent of the flexural tensile strength of the concrete, as similar capacities were experimentally observed for panels in the cracked or un-cracked initial condition. This result therefore questions the validity of the expression presented by Sanjayan et al (1997), who proposed to evaluate the axial load capacity  $N_U$  of a slender RC wall as:

$$N_U = \frac{1}{e'}(M_{CR} - M_0)$$

where  $e' = e - (t/6) + (M_{CR}/P_E)$  provides an equivalent eccentricity in order to account for the variation in panel's flexural stiffness up to and post cracking, while  $M_{CR} = f_{ct} L t^2 / 6$  is the flexural moment required to cause the panel to crack.

The investigation then examined whether the experimental results obtained from the testing programme could be used to derive a more representative design curve by application of the DAT method. It was shown that the proposed lumped-plasticity computational modelling, with a single fibre hinge at the critical mid-span location, is able to capture the buckling failure of slender RC panels, much more than the existing design procedures (see Paper J1, Section 6.1), with the method also seen to consistently slightly underestimate the actual panel buckling capacity within a range of 3-13%.

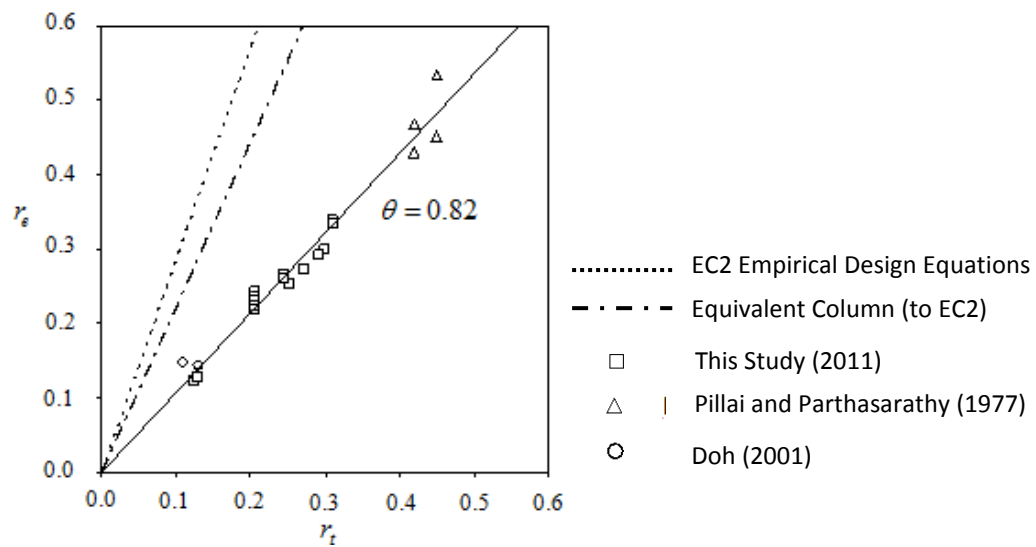

**Figure 5.1 Comparison between Theoretical and Experimental Results: Alternative Computational Design Approach (Robinson et al 2013-Paper J1)**

Figure 5.1 illustrates the improvement in design methodology in predicting the buckling capacity of the RC wall panel. The corresponding angle with the horizontal axis is  $\theta = \arctan(b) = 0.82$  (see Figure 5.1), which has a much better fit to the ideal value ( $\theta = 0.785$ ) compared to the correlation achieved with the EC2 empirical design equation (dotted line) or equivalent column methodology (dash-dot line). The condition  $b > 1$  also confirms that the proposed computational model is conservative (i.e. the theoretical resistances tend, on average, to be slightly less than the corresponding experimental capacities). It could be concluded therefore that the lumped plasticity representation can be used in the DAT procedure to develop a possible alternative design capacity curve (see Section 5.2.1).

### 5.1.2 Objective 2: Design and Adoption of Unconfined Reinforcement Configurations

The lumped plasticity idealisation and fibre-hinge elements was also shown to provide a good correlation with the experimental data relating to the singly and centrally reinforced panels adopting SFR concrete mix alternatives (see Paper C1, Section 6.3). This was an important finding, as it demonstrated the ability of the method to account for variation of the concrete material model adopted.

The introduction of the 50kg/m<sup>3</sup> SFR content was also shown to increase the axial buckling capacity of precast RC wall panels adopting an unconfined welded mesh re-bar configuration. In addition, the ductility up to structural failure was demonstrated for load eccentricities of e=t/6 and e=t/3 (Figure 5.2). Moreover, an improved (and more acceptable) failure mechanism was observed, when compared to the sudden, brittle failure seen in the control samples (Figure 4.3).

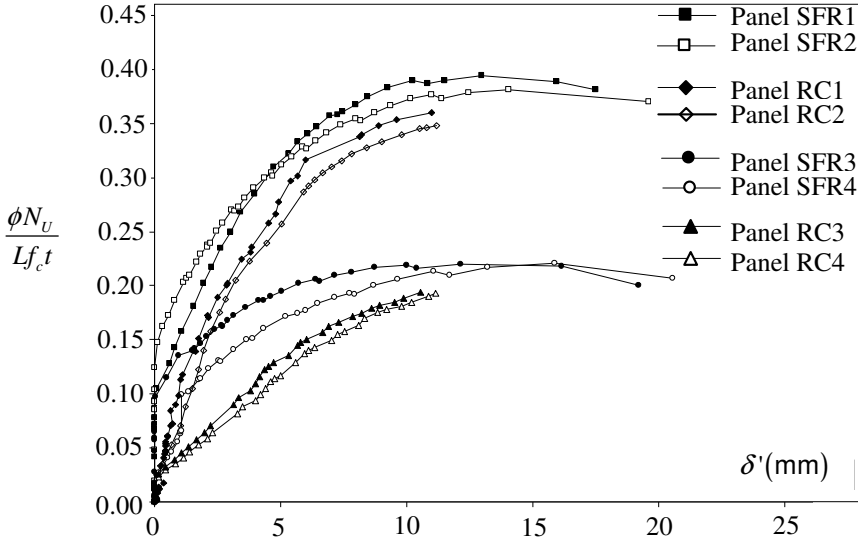

**Figure 5.2 Experimental Load-Deflection Curves for Panels with Varying Eccentric Load and Use of SFR (Robinson et al 2012-Paper C1)**

With respect to the lintels with dapped ends, it was again demonstrated that the introduction of SFR leads to increased capacity and ductility (Figure 5.4). This is believed to be because the fibres act to control cracking at the re-entrant corner, inducing a greater degree of flexural action prior to failure. During testing of the lintel elements, which only adopted the centrally placed welded mesh (i.e. no SFR content), the first crack occurred at the re-entrant corner of the dapped end. This was quickly followed by flexural cracking at the mid-span. As loading was increased the mid-span flexural cracking was seen to propagate at a greater rate than that at the re-entrant corners in a similar behaviour to that also observed when the confined control samples were loaded (i.e. those adopting a more traditional ‘cage’ reinforcement). Unlike the more traditional cage elements however, the mesh-only exhibited a greater propagation of tensile cracking along the diagonal compressive strut. This propagated upwards towards and subsequently along the beams top face as shown in Figure 5.3 (c).

The mesh-only samples failed when the cracking from the re-entrant corner reached the top face of the beam. This caused a shear failure with the concrete forming the dap spalling away post failure, leaving the reinforcement exposed. It was observed that plastic hinges had formed in the longitudinal steel of the mesh, adjacent to the welded vertical bars (Figure 5.3(c)) and therefore indicated the potential failure mechanism for the beam. The more ductile behaviour observed in the steel, that is the steel yielding and deforming plastically in an ‘under-reinforced’ manner, suggested that a more promising mode of failure could be justified than has been previously achieved for similar sections using a confined concrete.

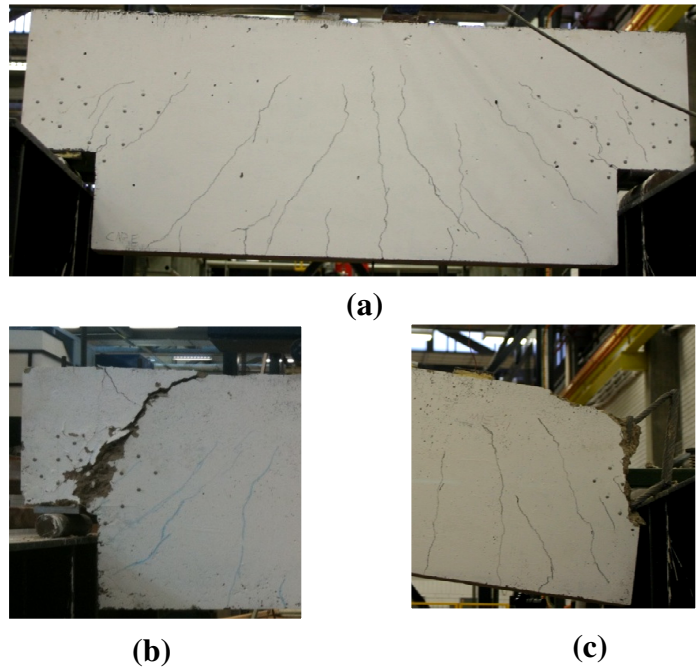

Figure 5.3 Crack Patterns and Failure: (a) Cage; (b) Fibre Mesh; (c) Mesh Only

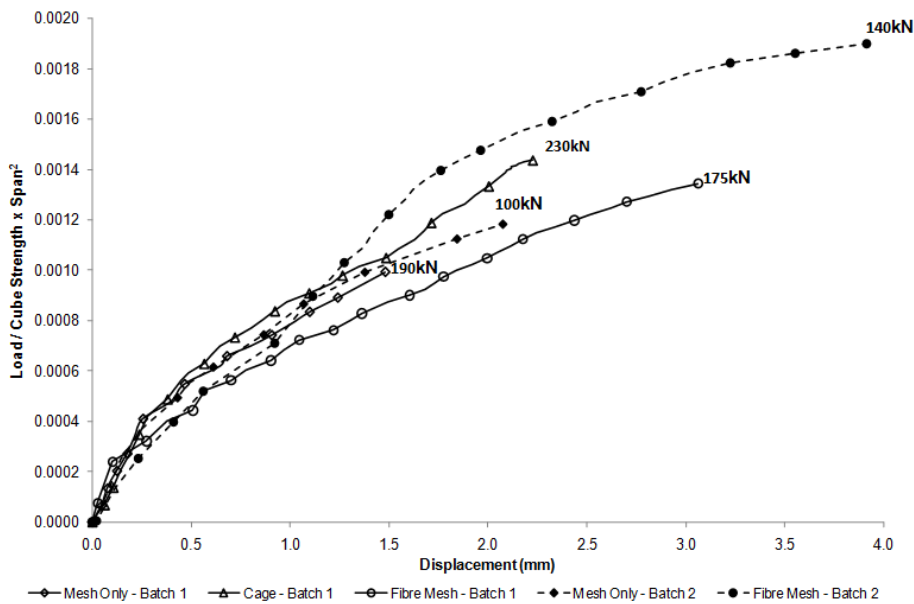

Figure 5.4 Cube and Span Normalised Load-Displacement Curves

### **5.1.3 Objective 3: Alternative Aggregate Materials in Precast Concrete Design**

The inclusion of hook-ended steel fibres ( $50 \text{ kg/m}^3$ ) was again found to significantly enhance the mechanical and structural performance in precast elements. The pull-out shear capacity of the anchors in the SPFA concrete type was shown to increase by 63% on average (Paper J2-Section 6.2), with the failure mechanism changing in nature from a pull-out cone to a more flexural failure. This manifested in a “two-way” slab failure in the small scale slabs tested. It was shown therefore that the SFRC content improves the 24 hour pull-out capacity of SPFA concretes to a similar extent as that observed in normal weight concretes (Ding and Kusterle 1999). It is unlikely that such a failure mechanism would occur however, in a large scale slab element. It is important therefore that further study establishes whether the same scale of improvement is seen for the same fixings cast within larger scale structural elements.

Investigations of SPFA aggregate and sand material in precast slab elements additionally indicated that the design equations for calculating compressive and tensile strengths in the European standard may underestimate the behaviours of these concretes at early ages (Paper J2, Section 6.2). It was found that, whilst the introduction of this aggregate replacement led to a reduction of up to 15% in concrete strength at 28 days, the 24 hour strength only reduced by up to 4.2% for concretes with an equivalent cement content. This is because the earlier age strength is less significantly dominated by the failure of the SPFA aggregate, which is responsible for the reduced concrete strengths following longer periods of curing.

It was therefore seen that the trends currently proposed by UK concrete research organisations for predicting the compressive strength of SPFA concrete mixes, relative to the resulting concrete density are probably not applicable for concretes following shorter periods of curing. It was also demonstrated that the strength variation following 1 day of curing, for the SPFA aggregate investigated were less pronounced than those suggested in historical research (Wasserman and Bentur 1996).

### **5.1.4 Objective 4: Suitability and Improvement of Robustness Methods**

The response of the chosen precast building typologies to the nonlinear static push-down analyses conducted is presented in Figures 5.5 (a) and (b) for the column loss event at the centre and corner of the building’s end bay respectively. The plots show the load factor

against the imposed deflection at the location at which the column has been removed. In this study, the load factor refers to a measure of performance utilised as part of similar investigations considering the non-linear push-down assessment of multi-storey buildings (Kim et al 2009; Lee et al 2011; Marjanishvili and Agnew 2006). The metric essentially quantifies what proportion of the load case the ‘collapse-arrested’ structure can transmit to the foundations through the alternative load path, defined as:

$$\text{Load Factor} = \frac{\text{Equivalent Applied Load}}{\text{Total 'Linear Static' Load}}$$

Because the maximum strength of the structures in each case does not exceed a load factor of 1.0 none of the structural typologies considered would satisfy the recommendations of the GSA (2010) guidelines.

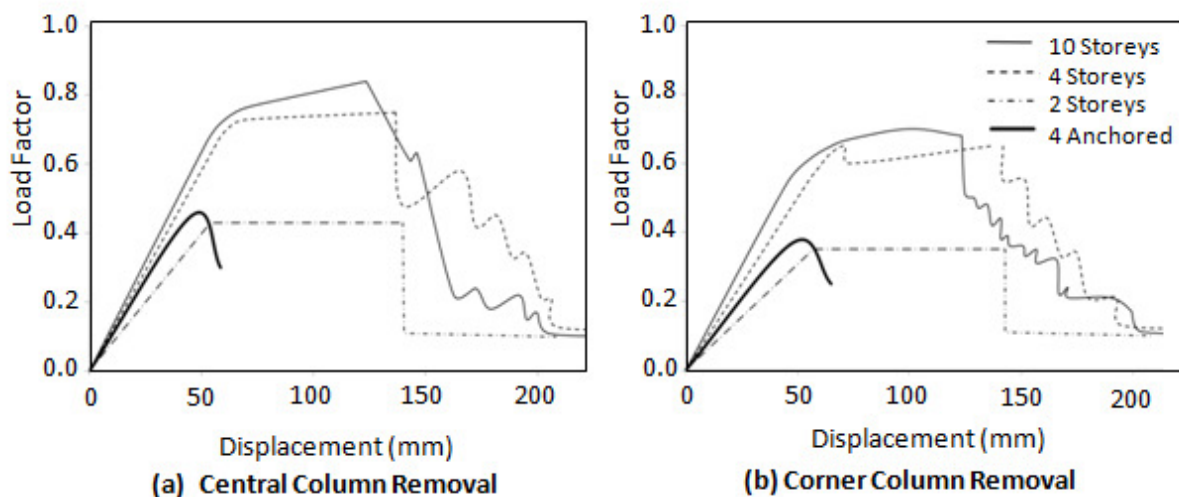

Figure 5.5 Push-Down Load-Displacement Relationships of Model Structures (Robinson et al 2013- Paper C2)

## 5.2 CONTRIBUTION TO EXISTING THEORY AND PRACTICE

### 5.2.1 Objective 1: Design Methodologies for RC Panels

The research has demonstrated the potential of a semi-empirical semi-probabilistic DAT (Design Assisted by Testing) methodology, enabled in the European design code, to derive more representative design values. In order to use this procedure, an alternative resistance



function has been devised, utilising a lumped-plasticity computational model with a non-linear fibre hinge at the position of the panel’s critical section. This approach was shown to represent effectively the structural response of slender RC panels, with a very good correlation between numerical and experimental values of the structural resistance (see Paper J1, Section 6.1). Further, this agreement was achieved using a relatively simple computational model, with all analysis run on a standard, consumer-grade laptop.

The design curve so obtained (see Figure 5.6) shows an increased structural capacity for slender elements, which better reflects the experimental data and can therefore result in more structurally efficient RC panels.

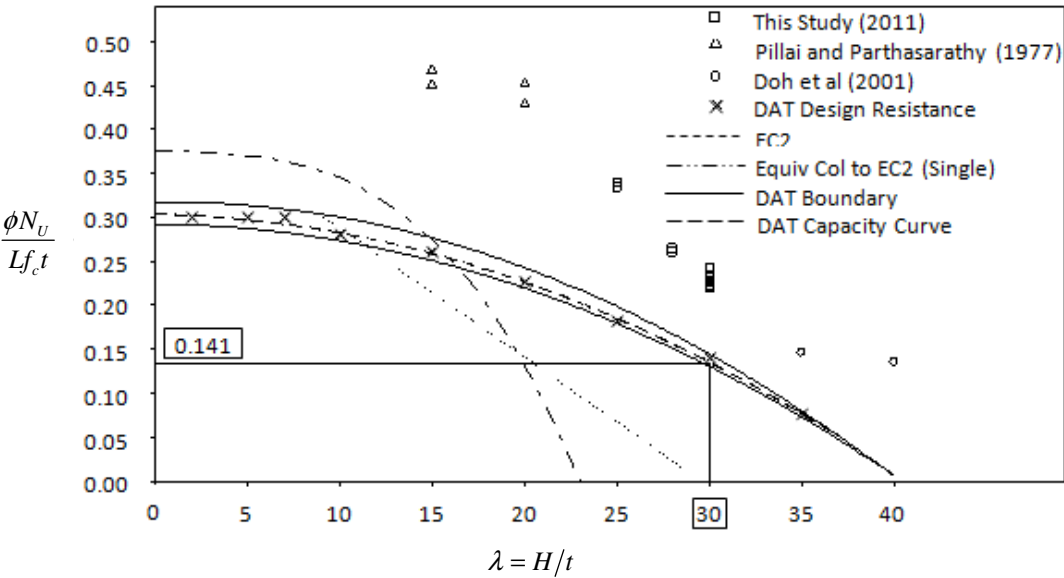

Figure 5.6 Alternative Panel Capacity Curve Developed from the Lumped Plasticity Idealisation with the DAT Procedure ( $e=t/6$ ) (Robinson et al 2013- Paper J1)

**5.2.2 Objective 2: Design and Adoption of Unconfined Reinforcement Configurations**

Moreover, the fibre-hinge modelling procedure therefore also potentially provides practising engineers with an effective design tool, which is also easily adaptable to situations with non-standard concrete mixes. Paper C1 (Section 6.3) further demonstrates the suitability of the computational technique to enable the design of panels adopting a hybrid reinforcing strategy. The lumped plasticity model is also shown to allow the panels to be assessed with regards to resisting eccentric loads beyond that currently permitted in the existing design codes ( $e = t/3$ ).

The investigations conducted have also developed and validated a Strut-and-Tie Model (STM) for the design of halving joint details in the precast beam elements, where an unconfined steel reinforcement layout is adopted. The analytical model was found (see Paper C1, Section 6.3) to overestimate the actual capacity. That is, the findings suggest that a modification (or safety) factor should additionally be applied to the analytical ‘strut’ element to account for the brittle nature of the unconfined concrete. In contrast however, when a 50kg/m<sup>3</sup> dosage of double-end hook SFR was introduced in the mix, the STM design method could be justified, with the experimental values this time indicating that a beneficial modification factor is warranted.

Further, it is concluded that the crack pattern observed (Figure 5.3) for all of the samples tested, i.e. the resulting propagation of tensile cracking from the re-entrant corner, is in conflict with the STM proposed by EC2 Section 10.9.4.6, as the diagonal compressive strut crosses this cracked region. In particular, it should be noted that the mesh-only and fibre-mesh samples exhibited extensive crack propagation in this region leading directly to the failure. This confirms the arguments of Wight and MacGregor (2009), the ACI Subcommittee 445-1 (2002) and FIP Recommendations (1999) highlighted in Section 3.2.2, which have all questioned the validity of this published model.

### **5.2.3 Objective 3: Alternative Aggregate Materials in Precast Concrete Design**

Establishing the early age properties of SPFA concrete mixes, has a direct implication in the design of precast structural elements. That is, the specification of a normal weight concrete mix is often determined through the need to achieve high early age strength (Section 2.4.2). This additionally leads to an excess capacity in the component at full concrete strength. Because the testing has shown similar 1 day strengths to have been achieved in lightweight SCC concrete mixes, and because the strength will be reduced following a full period of curing (because of aggregate shearing failure), the SPFA concretes appear to provide the precast industry with a means to achieve a suitable early-age concrete strength, but also have a resulting capacity closer to that required in the design.

It was also concluded that because the observed deviation in SPFA samples relating to indirect concrete tensile strength ( $f_{ct}$ ) at 24 hours was less pronounced than that seen after a

full period of curing, the introduction of a beneficial modification factor may be applicable in current European design regulations (CEN 2004) for design cases where a shorter period of strength development has occurred. Such a factor would consequentially allow for the improved design of elements against early age cracking and deflection.

### **5.2.4 Objective 4: Suitability and Improvement of Robustness Methods**

Precast frames, whose joints were designed according to regulations for fully tied or anchored connections, were evaluated according to the notional column procedure using a non-linear push-down technique (Section 3.2.4). For the precast framed structures considered, none were found to meet the GSA (2010) robustness performance regulations. All of the two and four storey structures investigated could also be classified as 'susceptible' to progressive collapse, according to the performance metric proposed by Marjanishvili and Agnew (2006). However, none of the buildings considered showed any indication that a secondary, detrimental 'pull down' effect due to the ties would induce or hasten the collapse sequence.

The study demonstrated that the computational push-down methodology previously adopted for steel (Kim et al 2009) and RC framed buildings (Choi and Kim 2011) can also be applied to precast framed structures. The analysis allowed the performance of the precast frames to be quantified, relative to an industry standard metric, with commonly adopted tied and anchored details shown to be unsuitable to prevent the collapse of the structures following a column loss to the centre or corner of the building. The work adds further support to previous studies, which question the use of prescriptive tying details to meet robustness requirements (Izzudin et al 2008).

### **5.3 IMPLICATIONS/IMPACT ON THE SPONSOR**

The EngD research has had a direct impact on Hanson Structherm in terms of changes to the design and manufacturing processes adopted. It has also influenced the development of new precast products/components and the means by which such innovation can be demonstrated to meet design and building code regulations. These implications are summarised below:

- The feasibility of adopting a centrally placed welded mesh reinforcement configuration was demonstrated for both precast panel and lintel elements. Design methods and capacity equations to the European design codes (CEN 2004) were established and can be included in any future submissions towards regulatory approval for the components.
- The use of the Design Assisted by Testing methodology, in conjunction with structural testing, to develop design methods and gain regulatory approval for new products, materials or ancillary components has been established. The procedure will therefore form part of new development and product innovation projects in the future.
- The effects of SPFA aggregate and sand materials (as well as their use in conjunction with a quantity of SFRC) on the workability, early age material properties and 28 day characteristic strengths have been quantified. The applicability and potential modifications to existing design equations has also been assessed. The test data has fed directly into the development of a lightweight direct decoration precast slab component and an alternative Floor over Garage (FoG) slab unit. For the span required, because of the reduced self weight of the FoG unit, a comparable structural thickness can be achieved in an SPFA reinforced slab and a non-SPFA pre-stressed component. This is of commercial significance to Hanson-Structherm.
- An SFRC content was shown to improve significantly the pull-out shear capacity of industry standard lifting anchors in precast slab components. This had a direct impact on the health and safety procedures at the Hanson precast facilities as it was necessary to identify any risk associated with the alternative SPFA materials in the casting, lifting and transportation process (under UK Construction Design Management (CDM) regulations). It was shown though, by using SFR concrete (as well as the reduced dead-weight) any health and safety risks have been mitigated.

- Further, because of the testing undertaken a higher safe working load of lifting anchors could be justified in precast elements. This means that potentially larger components could be lifted without the need for a more costly cast-in anchor.
- The research work associated with the design of RC wall panel elements will mean that higher design capacities can be justified and demonstrated to the European design regulations (CEN 2004). In addition, more extreme load eccentricities can also be assessed (see Paper C1, Section 6.3). The increased flexibility of the lumped plasticity computational approach will also mean that the wall panel elements can be utilised for a greater variety of design situations and as part of for more architecturally challenging structures. This should therefore lead to improved sales of precast panel elements.

#### **5.4 IMPLICATIONS/IMPACT ON WIDER INDUSTRY**

The majority of the aspects of the research project, which will influence both the wider precast concrete industry, have already been effectively captured in Sections 5.1-5.3. However, the testing undertaken, the experimental procedures developed and the computational techniques employed have also influenced numerous other research projects, which in their own right have the potential to lead to improved structural performance.

Specifically, Argyle et al (2011) looked at developing FEM models that would improve the accuracy and efficiency with which the design engineer could establish STM models for halving joints adopting both confined and un-confined reinforcement configurations. The experimental data could be used to validate the principal stress directions, crack propagations and capacities outputted from the computational model. The non-linear FEM in this way would be very beneficial to design engineers because establishing a suitable STM is often a difficult and (because of the iteration and validation required) time consuming process.

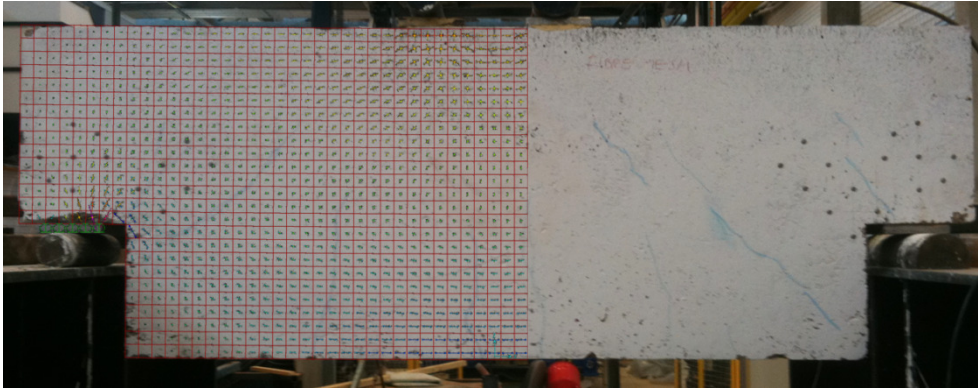

**Figure 5.7 FEM Strain Progression Superimposed on Tested Lintel (Argyle 2011)**

Martin and Godfrey (2012) also used the experimental design, testing procedures and analytical models developed (as part of this EngD project) to investigate the structural behaviour of rubberised concrete mixes in shear. They adopted a similar methodological approach to that detailed in Paper C1 (Section 6.1) when attempting to derive a modification factor to apply to the compressive strut (in the resulting STM) to account for the alternative material behaviour of the rubberised concrete. They also investigated varying SFR contents in an attempt to counteract the brittle failure mechanism.

The test samples and experimental procedure was also used to trial an imagery-based data collection and analysis procedure. Having recorded, and subsequently, calculated the displacements of a number of placed targets (Figure 5.8), the strain in each ‘subset’ of four targets could be calculated using the shape function method described by Chandrupatla and Belegundu (2002). Strain components in two directions and shear could also be calculated for each subset, with the principal direction of strain then found. Because the results from the high number of measurement points can be considered comparable to full-field measurement (Schmidt et al 2003), the information produced, such as strain gradients, aids research and product development. This is because the method will be able to reduce the number of samples and prototypes tested in a laboratory. Specific to this application, the techniques should enable the STM to be postulated and validated more expediently.

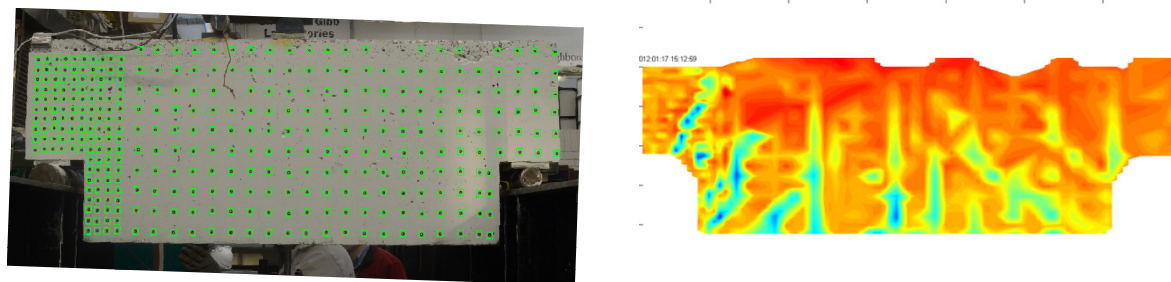

**Figure 5.8 Full Scale Rubberised Concrete Lintel and Evolution of Strain Captured by Imagery Analysis (Martin and Godfrey 2013)**

The research and testing data associated with the pull-out capacity of lifting anchors in early age concrete (both SPFA and normal weight) is to be used by the aggregate manufacturer Lytag as part of future technical guidance, with the Precast Flooring Association (PFA) to use the findings in future design literature. The Structural Precast Association (SPA) technical committee also used the findings of Paper C2 (see Section 6.4) as part of a technical review into robustness design and detailing practice.

## **5.5 RECOMMENDATIONS FOR INDUSTRY/FURTHER RESEARCH**

### **5.5.1 Objective 1: Design Methodologies for RC Panels**

Lumped plasticity idealisation and fibre-hinge elements were shown to provide a good correlation with the experimental data relating to the singly and centrally reinforced panels adopting both traditional and SFR concrete mix alternatives. However, the computational method was found to be less effective in the presence of steel fibres as secondary reinforcement (see Paper C1, Section 6.3), suggesting that further testing is required in order to calibrate the ‘length’ of the fibre hinge that should be adopted in the analysis. It is likely therefore that similar experimental calibration would also be required if the method is to be used for the design of panels adopting other alternative concrete mixes (e.g. High Strength (HSC), SPFA or rubberised concrete).

The nature of the DAT procedure also means that the larger the amount of test data that exists, the more appropriate the resulting design curve becomes. It is recommended therefore that more similar testing is therefore conducted towards achieving further structural efficiency in precast RC wall components

### **5.5.2 Objective 2: Design and Adoption of Unconfined Reinforcement Configurations**

The research and testing conducted has worked towards demonstrating the validity of adopting STM analytical models for the design of halving joints. Specifically it has provided data and evaluated the suitability of potential analytical models for precast lintels adopting unconfined reinforcement configurations. The work also established that a beneficial modification factor may be valid in such analytical representations where the specific SFR concrete mixes are adopted. However, a greater degree of further testing would be required in order to demonstrate and quantify what the value of such a beneficial factor should be. Further, how and if the coefficient should change if the geometry of the element and quantity of steel fibre reinforcement is varied should also be investigated.

It should also be possible to justify the design of these elements using the DAT procedure, with the STM analytical representation providing the theoretical prediction of the element capacity ( $r_t$ ). Such an exercise would require a greater amount of experimental data to appropriately meet the requirements and be incorporated in the statistical procedures.

### **5.5.3 Objective 3: Alternative Aggregate Materials in Precast Concrete Design**

A degree of further testing and research, specifically focussed on the pull-out resistances of lifting anchors in SPFA concretes (following a short period of curing), would be a great benefit to the precast industry. From the testing undertaken as part of this research programme, reduced pull-out capacities were observed in SPFA concrete mixes, relative to the control concrete. The data suggests that a reduction factor in the region of 20-30% would be appropriate when specifying fixings or anchors of this nature into the lightweight concretes (Paper J2-Section 6.2). The current European standards however, require modification factors that reduce the design capacity by up to 70%. These regulations therefore appear to be very conservative when designing for the pull-out shear failure of lifting anchors in these concretes. It is recommended therefore that more extensive testing should be undertaken to justify a more appropriate modification factor.

The current experimental programme demonstrated that an SFR dosage ( $50\text{kg/m}^3$ ) significantly influenced the shear capacity of concrete in the early stages of strength development for both normal and lightweight (SPFA) concrete variations. However, the



derivation of a modification factor, which could then be applied in the design process, to allow an engineer to benefit from the SFR content in SPFA concrete mixes, would require further research due to the variable nature of this hybrid concrete. A greater amount of data associated with potential variations in anchor size, anchor type, base reinforcement mesh, SFRC dosage and concrete strength would additionally be of great use to a specifying engineer.

#### **5.5.4 Objective 4: Suitability and Improvement of Robustness Methods**

It was concluded that the resulting behaviour observed and ‘performance’ of the tied structures considered as part of Paper C4 (see Section 6.4) is directly related to and significantly affected by the chosen tying detail. However, a larger amount of investigation would be required into how significantly the nature of the precast tied connection affects the resulting building performance before any firm conclusions in regards to the suitability of the current design methodologies and detailing rules can be drawn. Therefore further computational assessment needs to be conducted, in which connection and element designs are varied so as to assess the effect of adopting various tying details and the resulting sensitivity of the building’s performance to a column loss event.

In addition, the study (as part of this research) also provides no indication of the manner in which the measured robustness of the structure will change in response to variations in the building’s span length, storey height or plan shape. The effect of utilising and modelling for segmental and flexible floor diaphragms (e.g. pre-stressed hollow-core floor units) is also currently unknown. In addition, analogous investigation of the performance of alternative precast cross wall construction typologies would also be of great significance to ensuring the suitable design of robust precast building typologies in the future.

## **5.6 CRITICAL EVALUATION OF THE RESEARCH**

With regard to the methodology, physical experimentation could not be avoided. It was essential that the computational and analytical models developed were validated and justified by direct comparison with test data. The sample size adopted in the investigations relating to the buckling failure of minimally and centrally reinforced precast wall panels was in line with

the requirements of the DAT procedure (see Section 3.2.1). The sensitivity and statistical analyses conducted further demonstrated the appropriateness of the adopted sample size.

Such rigorous statistical consideration and analysis, with regards to any sensitivity of the proposed computational and analytical models, was perhaps not applied to the research relating to the effect of SFR content on the buckling and shear capacities of the precast components. Specifically only the material model proposed by Al-Ta'an and Ezzadeen (1995) was considered.

No large scale testing of the SPFA concrete mixes developed and investigated was undertaken. Such testing is however, specifically appropriate (and necessary going forward) because the findings of this research are intended to be directly applied to the design and manufacture of full scale slab elements. Additionally, no physical experimentation or complex FEM analyses were utilised as part of the research to validate the joint behaviours or capacities suggested by the non-linear push-down computational assessment.

## 6 THE PAPERS

### 6.1 PAPER J1

Full Reference –

Robinson, G.P., Palmeri, A., Austin, S.A., 2013. **Design Methodologies for One Way Spanning Eccentrically Loaded Minimally or Centrally Reinforced Pre-Cast RC Panels.** *Journal of Engineering Structures*, 56(2013), 1945 <http://dx.doi.org/10.1016/j.engstruct.2013.07.041>

Abstract –

This paper examines and evaluates design methodologies applicable to pre-cast reinforced concrete (RC) panels subjected to eccentric axial load. Theoretical capacities derived from existing regulatory guidance are compared against those determined from experimental investigations, showing that slender RC walls have load capacities significantly higher than the estimates based on current design equations.

A simple computational procedure incorporating lumped plasticity is presented and experimentally validated. It is shown that by utilising a non-linear hinge at the critical cross section, it is possible to effectively simulate the buckling response of the slender walls considered with a modest computational effort. The proposed design strategy emerges as a viable alternative to traditional methodologies by being able to capture the main effects of geometrical and material nonlinearities. It is therefore suggested that this approach, used in conjunction with a probabilistic, semi-empirical design procedure, will lead to design capacities more representative of actual experimental findings.

Keywords – Pre-cast concrete, buckling, Design Assisted by Testing (DAT), lumped plasticity, fibre-hinge model

Paper type – Article

## 1 INTRODUCTION

Reinforced concrete (RC) panels serve as key structural members for many common building forms. Within pre-cast ‘tilt-up’ or ‘cross-wall’ construction typologies for example, such panels provide the fundamental vertical load-carrying system. As a result, many codes of practice devote specific sections to the design and detailing of these elements. The American ACI 318-05 [1], Australian AS 3600-09 [2] and European EC2 [3] design codes all allow using simplified and empirically (or semi-empirically) derived equations [4]. However, because of their inherent simplicity, such equations cannot correctly account for the material and geometric non-linearity in the buckling failure of slender RC elements under eccentrically applied loads [5]. Therefore, large safety factors are adopted, and numerous studies have subsequently demonstrated that these equations significantly underestimate panel capacities when compared to those achieved by experimentation [6,7].

A possible alternative design methodology, also enabled within all of the structural design codes referenced, is to consider the RC panel element as an ‘equivalent column’, with the appropriate axial-moment interaction equations. However, minimum reinforcement requirements are frequently adopted for pre-cast concrete elements within cross-wall construction, and this steel is also often centrally placed for factors associated with manufacture and durability. Previous studies [8, 9] have suggested, that because the resulting structural response and failure mode of such elements is fundamentally different to those experienced by more heavily reinforced panels, the applicability of the equivalent column method in such instances is questionable.

In order to provide a way to design non-standard structural components and/or to overcome the limitations of existing design rules, the Eurocodes (through specific provisions within EC0 [10]) enable an alternative strategy based on a combination of testing and calculation. This Design Assisted by Testing (DAT) procedure exploits probabilistic considerations to ensure that appropriate factors of safety are applied to predictions of structural capacity. These factors can be directly determined from experimental work conducted as long as the number of tests available is sufficient for a meaningful statistical interpretation [11]. In the case of slender RC panels with minimum/central reinforcement, however, recent research [12] has found that, because a large and systematic conservatism exists between experimentally

observed capacities and the current design procedures, these methods cannot provide a design, or ‘resistance’ function for the DAT procedure. Consequently, an alternative theoretical model, which more appropriately reflects actual buckling capacity, is required.

In this paper, the use of a ‘lumped plasticity’ model is proposed in order to achieve a truer representation of the system’s non-linearity, and therefore deliver more accurate predictions of the failure capacity of the wall elements. By using a non-linear ‘fibre-hinge’ element at the known location of maximum moment, the entire inelasticity of the element can be concentrated at this location. It is shown that because this computational method accounts for non-linear material and geometric effects, it is in fact more effective in simulating the buckling response of the slender walls relative to the existing design methods. This has been validated (and the resulting improvement quantified) by comparing the predictions of panel capacity against actual experimental data (partly collected through full-scale tests carried out as part of this study and partly using those available within existing literature). Given the improved agreement with the empirical evidences, the paper demonstrates the suitability of adopting such a design procedure for the problem in hand, also presenting the resulting design curve and providing conclusions regarding its application in practice.

## 2 CURRENT DESIGN METHODS

The aim of this section is to briefly review the design procedures suggested in the existing regulatory guidance, which in turn will allow (in the second part of the paper) the quantification of the improved effectiveness of the proposed design strategy for slender, centrally reinforced precast concrete panels.

### 2.1 Simplified Design Capacity Expressions

In order to enable direct comparison between the American (ACI 318-05), Australian (AS 3600-09) and European (EC2) building codes, the relevant design expressions have been rearranged, as part of Table 1, in the form of the dimensionless design axial strength ratio [7,8,13]. In these expressions,  $F_c = f_c A_c$  is the compressive force within the stress block, and  $N_U$  is the ultimate value of the axial force applied with eccentricity  $e = t/6$ .

The design capacities from each of the specified equations are plotted in Figure 1 as a function of the slenderness ratio  $\lambda = H/t$ . It is apparent that the European code (thick solid line) deals with the slenderness of axially loaded members in a manner different to the American (dashed line) and Australian (dot-dashed line) codes, which incorporate parabolic expressions to account for the curvature of the section and the modified line of action of the eccentric load. In contrast, EC2 accounts for the secondary moments by applying a concentrated, notional, horizontal load ( $F_{NH}$ ) at the point of maximum moment in the panel. In this way, the European code adopts a triangular curvature distribution, which leads to a second linear (rather than parabolic) term, and reduces significantly the design capacities for slender elements.

For comparison purposes, Figure 1 also shows the design capacities for both doubly (filled circles) and centrally reinforced (empty squares) panel elements using the equivalent column methodology. Specifically the method of ‘Nominal Curvature’ is utilised as suggested by the European code (more details are provided in Section 2.3), adopting the minimum reinforcement ratio specified, such that:

$$\rho = \frac{A_s/L}{t} \leq 0.3\% , \quad (1)$$

in which  $A_s/L$  is the cross-sectional area of reinforcement per unit length of the panel.

What Figure 1 reveals is that by adopting the equivalent column design methodology for doubly, yet minimally reinforced, panel elements one can obtain enhanced capacities for structural elements up to a slenderness of  $\lambda \leq 27$ . However, a much steeper falling branch is seen for centrally reinforced panel elements, due to the small effective depth of the reinforcement within the panel.

## 2.2 Limitations of Existing Simplified Design Equations

The current, code-compliant, simplified equations allow no account to be taken of either the quantity or distribution of longitudinal reinforcement, nor modifications of the concrete stress block if needed (e.g. for non-standard concretes such as, steel fibre reinforced or alternative sustainable concrete mixes). Moreover, these methods cannot account for the inherent non-

linearity associated with the buckling failure of slender RC panels, or design situations where the axial load may be applied outside the section's middle third.

Further, as can be seen from Figure 1, the major international design codes currently restrict slenderness ratios of RC panels to  $\lambda < 30$  despite numerous studies having presented and demonstrated the applicability of design equations associated with the capacity of very slender ( $30 \leq \lambda \leq 50$ ) one way spanning RC panels [13].

### **2.3 Suitability of Equivalent Column Design**

*Prima facie*, the equivalent column methodology would seem to address the main limitations identified above, by allowing consideration of material non-linearity and strain compatibility. However, in the case of the minimally or centrally reinforced panels, contemporary research [13,14,15] challenges the applicability of this design procedure.

The failure of an equivalent column is considered to occur when the moment induced at the critical section of the panel element exceeds the 'flexural capacity' of the element at this location. Kripanarayanan [15] however, has demonstrated that reinforcement amounts of  $\rho = 0.75\%$  to  $1.0\%$  are needed for the reinforcement to affect the failure loads of slender walls. Subsequent test data, investigating singly reinforced RC panels adopting reinforcement ratios up to  $3\%$  [16] have also shown that the effect of increasing the amount of centrally placed reinforcement on the panel's capacity is negligible, even above the  $\rho = 1\%$  level determined for doubly reinforced panels.

What these findings prove is that the structural performance of such panels depends mainly on the 'flexural cracking' response of the element, i.e. when the concrete section at the critical location cracks in flexure the resulting concentrated loss of stiffness, combined with the lack of influential tension steel, controls the ultimate stability of the panel much more than would occur with doubly reinforced panels where  $\rho \geq 1\%$ . As a consequence, the ultimate axial capacity of the RC wall element becomes dependent on the post-cracked flexural stiffness of the cross-section, and appropriate account must be taken of the contribution of the concrete acting within both the tension and compression zone. It follows that the code-compliant equivalent column procedure should not be used for the design of centrally and/or minimally reinforced panels, as their resulting axial capacity would primarily depend on the stiffness of

the un-cracked panel section and the tensile strength of the concrete in flexure. Further, a moment magnifier should also be applied, depending on the ratio of applied axial load to the theoretical buckling resistance of the panel, in a manner identical to that considered by Sanjayan [16]. He proposed to evaluate the axial load capacity  $N_U$  of a slender RC wall as:

$$N_U = \frac{1}{e'} (M_{CR} - M_0), \quad (2)$$

where  $e' = e - (t/6) + (M_{CR}/P_E)$  provides an equivalent eccentricity in order to account for the variation in panel's flexural stiffness up to and post cracking, while  $M_{CR} = f_{ct} L t^2 / 6$  is the flexural moment required to cause the panel to crack.

The important question arising from Eq. (2) is whether it is in fact the flexural strength of the concrete acting within the tension zone of the RC panel that dominates the resulting capacity of the panel; or is it instead the true response of the concrete's compression block. In this regard, a certain degree of conjecture has been identified within existing literature ([9], [10]).

### 3 DESIGN ASSISTED BY TESTING (DAT)

The evidence thus far presented allows us to conclude that current, commonly adopted design procedures for the load capacity of centrally and/or minimally reinforced concrete walls appear over-conservative, restrictive and limited in regards to their design application. However, the European code [4] offers a potential alternative design procedure based on a combination of testing and calculation. This design methodology, which has been explored in recent studies [17,18], potentially allows experimental data to be utilised to enable a more realistic code-compliant estimation of the ultimate axial capacity of slender RC panels.

In an attempt to assess the applicability of this Design Assisted by Testing (DAT) method to the problem under consideration, a programme of experimental investigation was conducted.

#### 3.1 Test Panels and Experimental Setup

Sixteen  $L = 500$  mm wide and  $t = 100$  mm thick pre-cast concrete panels of varying height and slenderness ( $\lambda$  between 25 and 30), were axially loaded, with a range of eccentricities also adopted to reflect common construction and design cases. Table 2 provides a summary of the test samples prepared, with an overview of the experimental arrangement utilised also



illustrated within Figure 2. The centrally placed, welded mesh, reinforcement layout adopted for all of the panels is also presented in Figure 5. The testing rig had a capacity of 4,000 kN with the loading beam designed to ensure the transmission of a uniformly distributed load across the top of each panel at eccentricities of 0, 5 mm ( $t/20$ ), 17 mm ( $t/6$ ) and 33 mm ( $t/3$ ). The top and bottom hinged support condition, illustrated within Figure 2(c), was simulated by placing a 25 mm high-strength steel rod on a 50 mm thick steel bearing plate. Displacement transducers recorded out-of-plane displacements ( $\delta'$ ) at the centre of the panel and strain readings, with respect to the tension face of the buckling panel, were also taken with a digital portal gauge at the known critical section (Figure 2(b)).

Because another experimental objective was to assess the sensitivity of a panel's buckling capacity to the element becoming cracked at its critical section, six of the panels were axially loaded in a pre-cracked condition, with the fissure induced in flexure, prior to loading.

### 3.2 Experimental Findings and Use in DAT

Table 2 summarises the load capacities obtained for each of the tests undertaken. As can be seen, the ultimate capacity of the panels (sixth column) far exceeded the predictions of both simplified code equations (seventh column) and equivalent column methodology (eighth column) as enabled within EC2. This is not surprising, as Figure 1 shows that for a panel slenderness of  $\lambda = 30$  all the commonly adopted methodologies would predict a load carrying capacity approaching (or equal to) zero

Our experimental findings thus support past research, and confirm that simplified design equations provide overly conservative estimates of slender RC panel capacity. More importantly, this testing campaign also demonstrates that the axial capacity of centrally reinforced elements is effectively independent of the flexural tensile strength of the concrete, as similar capacities have been experimentally observed for panels in the cracked (C) or uncracked (U) initial condition. This is one of the key findings of this testing, as it allows us to conclude that the contribution due to the concrete's post-cracked behaviour (specifically the response of the compressive stress block) is crucial in determining the element's capacity. The observed failure typology also supports this finding, with a compressive spalling (Figure

3(a)) observed, along with extensive flexural cracking for both cracked and un-cracked initial conditions (Figure 3(b)).

Moving from the above considerations, the investigation then examined whether the experimental results obtained from the testing programme could be used to derive a more representative design curve by application of the DAT method. The procedure consists of seven distinct steps [11]:

- Firstly, a suitable theoretical resistance model is required to predict the capacity of the element (step (i)).
- The theoretical model has to be validated against experimental data, through measurements of the relevant variables within the tests (step (ii)).
- Statistical techniques are then used to ‘fine-tune’ the prediction capability of the theoretical model [18] (step (iii)).
- The definition of a semi-probabilistic capacity curve can then be progressed as long as the residual model error ( $\delta$ ) is correctly quantified and incorporated (step (iv)).
- The design value of the capacity model (Figure 11) is consequentially obtainable (step vi) following the estimation of its mean and variance (step v), based upon the assumption of a normal or log-normal distribution, the validity of which has to be checked (step vii).

### 3.3 Theoretical Resistance Model for the DAT Procedure

The DAT procedure method, as detailed above, relies on the availability of a satisfactory theoretical capacity model able to represent the most significant aspects of the structural behaviour relating to the component under consideration (step (i)). The resistance function can be mathematically expressed as:

$$r_t = g_r(\mathbf{X}) , \quad (3)$$

where  $g_r$  is the theoretical model, which depends on the array  $\mathbf{X}$  collecting all the basic variables influencing the structural capacity. In the present study, such variables may include

the compressive ( $f_c$ ) and tensile capacities ( $f_{ct}$ ) of the concrete, the geometrical parameters ( $\lambda$ ,  $L$  and  $H$ ) as well as the reinforcement ratio ( $\rho$ ) and its arrangement. All of these variables were, of course, captured by the experimental programme undertaken (step (ii)). One must also ensure, however that the adopted theoretical resistance function,  $r_t$ , provides an acceptable correlation with the experimental resistance data,  $r_e$ , so as to be considered suitable for use within the derivation of the sought design capacity (step (iii)). This check can be done by considering the least-squares best fit to the slope  $b$  between  $r_t$  and  $r_e$ , i.e. by minimising the following quadratic expression:

$$S(b) = \sum_{i=1}^n (r_{e,i} - b g_{rt}(\mathbf{X}_i))^2, \quad (4)$$

where  $r_{e,i}$  and  $r_{t,i} = g_{rt}(\mathbf{X}_i)$  constitute the  $i$ th pair of an experimental value and theoretical prediction. The condition  $dS/db = 0$  allows computing the optimal value of the angular coefficient  $b$ :

$$b = \frac{\sum_{i=1}^n r_{e,i} r_{t,i}}{\sum_{i=1}^n r_{t,i}^2} = \tan(\theta), \quad (5)$$

$\theta = \arctan(b)$  being the angle that the regression line forms with the horizontal axis (Figure 4).

In a first stage, we considered the case in which the theoretical model of Eq. (3) is provided by the empirical design equation (Table 1, last row) and the equivalent column method (Eq. (2)) within EC2. Figures 4(a) and (b) illustrate that such procedures provide a poor correlation when compared to our experimental results, as well as other published test capacities [9,13,15]. Indeed, both theoretical models result in a least-squares best fit which is significantly divergent from the recommended of  $\theta = \pi/4 \cong 0.785$  (i.e. one-to-one slope), being  $\theta = 1.23$  for the simplified/empirical design equation (dashed line, top-left graph) and  $\theta = 1.15$  for the equivalent column design (dot-dashed line, top-right graph). It can also be seen that the discrepancy of results can be greater than 40%, which has been suggested as an acceptable limit within the technical literature [18].

## 4 COMPUTATIONAL AND EXPERIMENTAL VERIFICATION

### 4.1 Lumped Plasticity Modelling

The results presented in the previous section highlight the need for a new and more efficient design procedure (for inclusion as part of step (i)) if minimally and/or centrally reinforced panels are to be designed using the DAT method.

One such potential procedure has been devised as part of this study through the application of the lumped plasticity idealisation. This is a widely adopted model, particularly utilised in earthquake engineering and robustness assessment, to determine the ultimate performance of a structural system by increasing step by step the load multiplier until failure (push-over or push-down analysis). For the structural problem in hand, the entire inelasticity of the element has been concentrated at a single position by the use of a non-linear fibre ‘hinge’, since the location of maximum moment (and thus the critical section for the span) is known (see Figure 5(a)). In this representation, the element’s cross-section is subdivided into a number of elementary layers or fibres [19], to which the appropriate material properties are then assigned (see Figure 5(b)). The non-linear moment-curvature relationship of the fibre hinge can then be determined for a range of axial loads assuming plane cross sections. Figure 5(d) illustrates the moment-rotation behaviour computed for an un-cracked panel section loaded at an eccentricity of  $e = t/6$ , while Figure 5(c) shows a typical distribution of the compressive stress  $\sigma$  along the panel’s depth at the critical location.

In the proposed computational model, the rotation  $\omega$  experienced by the fibre hinge is evaluated under the assumption of a uniform curvature  $\kappa$  over the adopted length  $L_p$  of the plastic element, i.e.  $\omega = \kappa L_p$ . In this study, because of the mesh reinforcement layouts commonly detailed for minimally as well as centrally reinforced panels (Figure 5(b)), the length of the plastic hinge and the material model were selected to reflect the lack of ductility observed experimentally for the unconfined concrete at the critical cross section [20,21]. Accordingly, the hinge lengths adopted were computed from the expression proposed (and experimentally validated) by Panagiotakos and Fardis [22] for unconfined RC panels and column elements subjected to monotonic loading:

$$L_p = 0.18L_s + 0.021d_b f_y , \quad (6)$$

where  $L_s = H/2$  is the shear span of the member,  $d_b = t/2$  (for the panels considered as part of this study) is the effective depth of the longitudinal reinforcement and  $f_y$  is the yield strength of that reinforcement.

For validation purposes, simple equilibrium equations are used within Appendix A to check the results of the numerical analysis.

#### 4.2 Experimental Validation of the Computational Model

As can be seen from Table 2, the ultimate load capacities predicted by the proposed computational method with lumped plasticity (last column) compare very well to those experimentally observed (sixth column), with the method also seen to consistently slightly underestimate the actual panel buckling capacity within a range of 3-13%.

In our analyses, the three-parameter concrete material model initially proposed by Mander [23] and illustrated within Figure 6(a) was adopted for the stress-strain constitutive law  $\sigma_c(\varepsilon_c)$  of the unconfined concrete, where:

$$\sigma_c = f_c \frac{v \left( \frac{\varepsilon_c}{\varepsilon_{co}} \right)}{(v-1) + \left( \frac{\varepsilon_c}{\varepsilon_{co}} \right)^v}, \quad (6)$$

where  $v > 1$  is a dimensionless shape parameter to be evaluated through the empirical relationship [25,26]:

$$v = 1 + 0.4 \times 10^{-3} f_c. \quad (6)$$

Importantly, the concrete material model can be easily modified if the performance of other concrete types, such as high-strength concrete and fibre reinforced mixes, has to be accounted for.

Because a displacement-controlled non-linear push-down analysis is adopted, it is possible to assess the resulting deformations and strains induced within the fibre hinge incrementally up until (and also beyond) the ultimate failure load. These numerical outputs in terms of deflection and strain, relating to the ‘tensile’ face of the buckling panel (Figure 2(b)), have been plotted (thick lines) against the actual experimental data (symbols) in order to investigate whether the adopted computational strategy accurately captures the true structural behaviour

of the RC wall elements. The computationally predicted behaviour appears to closely represent that observed within testing, although the lumped plasticity computational model tends to underestimate the deformation of the element at failure (Figures 7 and 8). The almost linear elastic nature of the load-strain plots also correctly captures of the relatively brittle failure mechanism observed (Figure 3).

### 4.3 Sensitivity Analyses

The sensitivity of the proposed method to variations in the constitutive law (see Eqs. (7) and (8)) adopted for the unconfined concrete was also investigated. Specifically, the study focussed on the effect of the softening branch and long-term deformations.

In a first stage, two alternative representations of the stress-strain relationship for unconfined concrete, illustrated within Figures 6(b) and (c), were adopted to re-analyse the wall panels. The behaviour illustrated within Figure 6(b) is based on the modified Kent-Park [24] model proposed by Scott et al. [25], in which pre-peak and post-peak behaviour are given by:

$$\sigma_c = K f_c \times \begin{cases} \frac{2\varepsilon_c}{0.002K} - \left(\frac{\varepsilon_c}{0.002K}\right)^2, & \varepsilon_c \leq 0.002K; \\ 1 - Z_m(\varepsilon_c - 0.002K), & \varepsilon_c \geq 0.002K, \end{cases} \quad (7)$$

where  $K = 1$  for the unconfined case under consideration, and the dimensionless parameter  $Z_m$  controlling the post-peak slope can be evaluated as:

$$Z_m = \frac{0.5}{\frac{3 + 0.29 f_c}{145 f_c - 1,000} - 0.002K} \quad (8)$$

in which the compressive strength of the concrete  $f_c$  must be expressed in MPa.

The second alternative considered, illustrated within Figure 6(c), was to discount the tension-softening branch completely from the adopted Mander's representation of the material behaviour. The predicted panel capacities varied between 2 and 5%, which demonstrates that the proposed fibre-hinge modelling for the centrally reinforced concrete section is largely insensitive to such variations in the unconfined stress-strain model.

A second stage assessed the effects of the creep on the long-term response of the RC wall panel by appropriately modifying the material model adopted for the unconfined concrete.

Creep in concrete is a complex phenomenon, which may depend on ambient humidity, size of the element, the mix of constituents, the strength of the material when stressed as well as the magnitude and duration of the applied loads [26]. Despite this inherent complexity, the ultimate creep strain can be effectively computed by factoring the observed elastic strain by a creep coefficient such that:

$$\varepsilon_{c,\infty} = \varphi_{(\infty,T_0)} \left( \frac{\sigma_c}{E_c} \right), \quad (9)$$

In our investigations, creep effects were evaluated according to the procedure detailed within EC2, assuming: i) relative humidity of 50% (consistent with an indoor environment); ii) class R, rapid strength gain mix design, containing a negligible amount of GGBS (Ground Granulated Blast Slag), for the C40/50 concrete utilised for the test panels; iii) thickness of the walls  $t = 100$  mm; and iv) age of the concrete when loaded  $T_0 = 28$  days. The creep coefficient so computed is  $\varphi_{(\infty,T_0)} = 2.1$ , which is in line with observed strains stated within literary guidance [27]. Figure 6(d) shows the modified constitutive law for the unconfined concrete, in which for the same value of the stress  $\sigma_c$ , the strain  $\varepsilon_c = \varepsilon_{c,\infty}$  has been increased by the creep coefficient. However, the original value for acceptable strain deformation has been maintained, and this results in the failure of the panel occurring within the rising linear branch of the stress-strain relationship. By allowing for the effects of creep in this way, a reduction in the predicted panel capacities of 20% is observed. Because of the significance of these time-dependent affects, the proposed modified-material model should be adopted within the lumped plasticity representation (or a further factor should be applied retrospectively to the panel capacities derived) before the method is used in the determination of actual design predictions.

## 5 STRUCTURAL CAPACITY VIA DAT

### 5.1 Probabilistic Model for the Structural Resistance

It has already been shown (see Table 2) that the proposed lumped-plasticity computationally modelling, with a single fibre hinge at the critical mid-span location, is able to capture effectively the buckling failure of slender RC panels, much more than the existing design procedures. To quantify the improved correlation between experimental data,  $r_{e,i}$ , and theoretical prediction,  $r_{t,i} = g(\mathbf{X}_i)$ , Eq. (5) was used to evaluate the angular coefficient  $b$  of the regression line for the proposed approach (see step (iii) of the procedure, as summarised in Section 3.2). A value  $b = 1.07$  was found using the whole set of  $n = 22$  data points (16 points from our experimental work, shown in Table 2, and 6 points from previously published studies). The corresponding angle with the horizontal axis is  $\theta = \arctan(b) = 0.82$  (see Figure 4(c)), which has a much better fit to the ideal value ( $\theta = 0.785$ ) compared to the correlation achieved with the EC2 empirical design equation (Figure 4(a)) or equivalent column methodology (Figure 4(b)). The condition  $b > 1$  confirms that the proposed computational model is conservative (i.e. the theoretical resistances tend, on average, to be slightly less than the corresponding experimental capacities).

However, the fact that the resulting least-squares best fit does not equal the  $\pi/4 = 0.785$  ideal means that the proposed theoretical function does not provide an exact and complete representation of the failure mechanism of the structural members under investigation. Within the DAT context, therefore, the angular coefficient  $b$  can be interpreted as a statistically-based correction parameter which fine-tunes the theoretical predictions to match, on average, the experimental data. This correction, whose effectiveness increases with the number of data points, eliminates the systematic sources of inaccuracy, due for instance to secondary phenomena not captured and/or included within the chosen theoretical model. Once the least-squares regression coefficient  $b$  has been applied to the theoretical predictions, working now within a probabilistic framework, the residual discrepancy still remaining for the  $i$ th data point can be modelled as the generic realisation  $\delta_i$  of a random variable  $\delta$  with unitary mean value  $\bar{\delta} = 1$  and standard deviation  $\sigma_\delta$  (step (iv) of the procedure). Therefore, the probabilistic model of the structural resistance becomes:



$$r = b r_t \delta , \quad (10)$$

while the  $i$ th sample of the model error  $\delta$  is given by:

$$\delta_i = \frac{r_{e,i}}{b r_{t,i}} . \quad (11)$$

Either a Gaussian [28] or Log-Normal distribution can be adopted to describe the random variable  $\delta$ . Theoretically speaking, the latter seems more appropriate, as  $\delta$  cannot be negative (see Eq. (11)). However, in practice, the Gaussian model could be a viable alternative, particularly if the standard deviation  $\sigma_\delta$  is small. The data points relating to the residual errors between the theoretical and experimental values have been used to assess the goodness-of-fit for both potential probabilistic distributions. Figure 9 compares the empirical Cumulative Distribution Function (CDF)  $\Phi_\Delta(\delta)$  obtained from the experimental data points (filled diamonds) with the ideal CDF  $F_\Delta(\delta)$  of both Gaussian (solid line) and Log-Normal (dashed line) random variables having the same mean value and standard deviation of the available experiments, that is:

$$\mu_\Delta = \frac{1}{n} \sum_{i=1}^n \delta_i = 1.0053; \quad \sigma_\Delta = \sqrt{\frac{1}{n-1} \sum_{i=1}^n (\delta_i - \mu_\Delta)^2} = 0.0346 . \quad (12)$$

It can be seen that both theoretical models can be used to describe the model error  $\delta$ . The one-sample Kolmogorov-Smirnov test [28] was used to confirm the goodness-of-fit for both probabilistic distributions (in line with step (vii) of the DAT procedure, as detailed in section 6.2) and very similar values of the test statistic for the  $n = 22$  data points were obtained, meaning that more samples would therefore be needed in order to select the most appropriate distribution.

An implicit assumption made while introducing Eq. (10) is that the model error  $\delta$  is independent of the theoretical prediction  $r_t = g_n(\mathbf{X})$ . Among the  $j$  basic design variables collected by the array  $\mathbf{X} = \{X_1, X_2, \dots, X_j\}$ , the compressive strength of the concrete,  $X_1 = f_c$ , and the relative eccentricity of the load,  $X_2 = e/t$ , are deemed to play the most important roles within our set of data. It is necessary therefore to prove that these quantities are actually uncorrelated to the observed model error. In order to do this, the corresponding scatter plots

for the available data points have been reported within Figure 10, which does not show any significant statistical pattern and therefore confirms our assumption.

This is an important finding, as it means that however the engineer chooses to account for the effects of possible deviations in material properties, geometry of the structural element and position of the load, the resistance function provided by the proposed computational model remains valid.

## 5.2 Effects of the Basic Design Variables

In order to be applicable in practice, the final resistance function developed through the application of the DAT method must account for any scatter directly associated with the basic design variables identified within Eq. (3), e.g. those relating to material strength. Because of the limited number of tests, our sample may not be fully representative of the behaviour of the population in relation to the basic variables that control the structural response of the element. The DAT method, as formulated within the European code EC0 [11], allows for incorporating such additional sources of uncertainty through the use of a Coefficient of Variation (CoV)  $V_{X,i}$  for each of the  $j$  basic design variables, whose statistical description must be preliminarily pursued. According to EC0, the CoV of the resistance,  $V_R$ , can be estimated by combining the CoVs of all the random/uncertain variables contributing to the structural response, that is:

$$V_R \cong \sqrt{(V_\Delta^2 + 1) \left[ \prod_{i=1}^j (V_{X,i}^2 + 1) \right]} - 1, \quad (13)$$

where  $V_\Delta = \sigma_\Delta / \mu_\Delta$  is the CoV of the model error  $\delta$ . From the expression above, one can demonstrate that the CoV of the theoretical resistance,  $V_{R,t}$ , is given by:

$$V_{R,t} \cong \sqrt{\frac{V_R^2 - V_\Delta^2}{V_\Delta^2 + 1}}, \quad (14)$$

which, for moderate level of uncertainty pertaining to the basic design variables in the problem in hand, can be approximated as:

$$V_{R,t} \cong \sqrt{\sum_{i=1}^j V_{X,i}^2}. \quad (15)$$

Assuming implicitly a Log-Normal model for the distribution of the structural resistance, the European EC0 allows evaluating the design value of such quantity through the expression (step (vi) of the procedure):

$$r_d = b g_{rt}(\bar{\mathbf{X}}) \exp(-k_{d,\infty} \alpha_{R,t} Q_{R,t} - k_{d,n} \alpha_{\Delta} Q_{\Delta} - 0.5 Q_R^2), \quad (16)$$

where  $\bar{r}_t = g_{rt}(\bar{\mathbf{X}})$  is the deterministic value of the resistance when the basic design variables  $X_1, X_2, \dots, X_j$  take their respective mean values;  $Q_{R,t} = \sqrt{\ln(V_{R,t}^2 + 1)}$ ,  $Q_{\Delta} = \sqrt{\ln(V_{\Delta}^2 + 1)}$  and  $Q_R = \sqrt{\ln(V_R^2 + 1)}$  are dimensionless measures of the statistical dispersion affecting the random variables  $r_t$ ,  $\delta$  and  $r$ ;  $\alpha_{R,t} = Q_{R,t}/Q_R$  and  $\alpha_{\Delta} = Q_{\Delta}/Q_R$  are dimensionless weight factors, while  $k_{d,n}$  is the pertinent design fractile factor for  $n$  samples and  $k_{d,\infty}$  is its limit as  $n$  tends to  $+\infty$ . To be consistent with the EC0 provisions, it can be assumed  $k_{d,n} = 3.64$  for  $n = 22$  [11] and  $k_{d,\infty} = 3.04$  (which in turn is very close to the fractile factor  $k_p = 3.09$  for a Gaussian random variable and a probability of non-exceedance  $p = 0.001$ ).

### 5.3 Use within Structural Design

Eq. (16) was applied for different values of the structural slenderness  $\lambda = H/t$ , that is  $\lambda = 2, 5, 7, 10, 15, 20, 25, 30, 35$  and assuming  $e = t/6$  as design value of the load eccentricity and  $V_{X,1} = 0.127$  and  $V_{X,2} = 0.135$  as CoVs for the basic design variables  $X_1 = f_c$  (material randomness) and  $X_2 = e/t$  (geometrical uncertainty), respectively. The nine data points  $\{\lambda_i, \tilde{r}_{d,i}\}$  so obtained (Figure 11, Crosses) have been approximated with the following best-fit quadratic expression:

$$\tilde{r}_d = \frac{1}{2} \left[ \frac{10}{e} - \frac{\lambda}{100e} - 4 \times 10^{-4} \lambda^2 \right], \quad (17)$$

where  $\tilde{r}_{d,i} = r_{d,i}/(f_c L t)$  is the normalised structural capacity of the panel.

Figure 11 illustrates the resulting curve (thick dashed line), which clearly gives a more representative and less conservative prediction of actual panel capacity for slender panels when compared to those derived using existing design techniques, still provides an adequate

margin of safety. By way of example, for a panel of slenderness  $\lambda = 30$  one can derive a normalised design value of  $N_u/bf_c t = 0.141$  (Figure 11). Taking  $\phi = 1$  and substituting the appropriate values for panels tested as part of this study, a design axial capacity of 254kN is obtained. While this figure is still much lower than those observed in testing (Table 2), it is more suitable than the alternative code-compliant designs, all of which would predict a design capacity of zero. Importantly, partial safety for both materials and actions should be applied in a practical design situation.

A sensitivity study was also undertaken to investigate the influence of reducing the number of experimental data points available to the design engineer. Further analyses were performed using the top or bottom 50% of panel test capacities at each value of slenderness (best and worst cases). The resulting boundaries (thin solid lines) are also illustrated on Figure 11, and appear to be very close to the proposed resistance curve. This therefore demonstrates the robustness of the proposed approach against the number of samples available for the application of the DAT procedure.

## 6 CONCLUSIONS AND RECOMMENDATIONS

The appropriateness of existing design methods for pre-cast slender RC panels has been assessed. The experimental investigations demonstrate a significant conservatism when designing slender pre-cast RC wall panels to current design codes. This results from the inability of the simplified analytical models to account for the true non-linear behaviour when such an element is subjected to an eccentric axial load.

The research has demonstrated the potential of a semi-empirical semi-probabilistic DAT (Design Assisted by Testing) methodology, enabled within the European design code, to derive more representative design values. In order to use this procedure, an alternative resistance function has been devised, utilising a lumped-plasticity computational model with a non-linear fibre hinge at the position of the panel's critical section. This approach was shown to effectively represent the structural response of slender RC panels, with a very good correlation between numerical and experimental values of the structural resistance. Further, this agreement was achieved using a relatively simple computational model, with all analysis

run on a standard, consumer-grade laptop. The proposed design method is therefore suitable, provided that it incorporates the statistical analysis required by the DAT procedure.

The design curve so obtained shows an increased structural capacity for slender elements, which better reflects the experimental data and can therefore result in more structurally efficient RC panels. Moreover, the fibre-hinge modelling potentially provides practicing engineers with an effective design tool, which is also easily adaptable to situations with non-standard concrete mixes.

### Appendix A. Static Equilibrium and Free Body Analysis at Panel Failure

By way of example, let us consider the simply-supported RC panel with  $H = 3,000$  mm and  $e = t/6 = 16.7$  mm, corresponding to the thick dashed curve in Figure 7, where the ultimate values of axial force and transverse displacement are  $N_U = 531$  kN (resistance value at failure) and  $\delta' = 9.0$  mm, respectively. Looking now at the stress distribution along the depth of the critical section, depicted within Figure 5(c), one can observe that the central steel reinforcement is in tension at failure, being  $F_{steel} = 17$  kN. It follows that the resultant concrete force at failure is  $F_c = N_U - (-F_{steel}) = 548$  kN, which is proportional to the area of the concrete stress diagram shown in Figure 5(c), that is:

$$F_c = \sum_i \sigma_{c,i} A_{c,i} = 548 \text{ kN}, \quad (\text{A.18})$$

where  $A_{c,i}$  is the area of the  $i^{th}$  concrete fibre considered in the model,  $\sigma_{c,i}$  is the corresponding stress given by the non-linear static analysis and the summation involves all the fibres in compression. The centroid of the stress diagram also allows the determination of the exact position where the resultant concrete force is applied:

$$\bar{y} = \frac{1}{F_c} \sum_i \sigma_{c,i} A_{c,i} y_i = 24.78 \text{ mm}, \quad (\text{A.19})$$

as illustrated in Figure 5(c), and since the steel reinforcement is centrally placed, the internal moment at failure is given by:

$$M_{int} = F_c \bar{y} = 13.58 \text{ kNm}. \quad (\text{A.20})$$

To take into account the effects of any accidental eccentricity that may affect the stability of the panel, a notional horizontal force  $F_{NH}$  has been also applied at mid-span (see Figure 5(a)), whose magnitude is assumed to be proportional to the sought ultimate axial capacity:

$$F_{NH} = \psi N_U , \quad (\text{A.20})$$

where:

$$\psi = \max \left\{ \frac{1}{100}, \frac{t/3}{H} \right\} = 0.0111. \quad (\text{A.21})$$

If we now consider the global equilibrium of the panel, the horizontal reactions forces  $R_1$  (at top support) and  $R_2$  (at the base) must be 0.03 kN and 5.87 kN respectively.

Finally, if we examine the free body diagram of the top part of the panel, also included as part of Figure 5(a), the externally applied moment at the point of buckling failure ( $M$ ) can be evaluated as (taking moments about the central steel fibre at mid-span position, i.e. point A within Figure 5(c)):

$$M = N_U (e + \delta') + R_1 \frac{H}{2} = 531 \times (0.0167 + 0.0090) - (0.03 \times 1.5) = 13.58 \text{ kNm} \quad (\text{A.22})$$

This is (as expected) equal to the corresponding value derived as part of Eq. (A.20), which is dictated by the moment rotation plot included as part of Figure 5(d), and which was generated by consideration of the structural cross section and appropriate material models.

## References

- [1] American Concrete Institute, ACI 318-05. Building code requirements for structural concrete and commentary. Farmington Hills; 2005.
- [2] Standard Association of Australia, AS 3600-2009, Concrete structures amendment 1-2010. Sydney; 2010.
- [3] Comité Européen de Normalisation, EN 1992-1-1. Eurocode 2 design of concrete structures part 1-1 general rules and rules for buildings. Brussels; 2004.
- [4] Wight JK, Macgregor JG, Reinforced Concrete Mechanics and Design. 5th Ed. San Jose: Pearson Education International; 2009.
- [5] De Falco A, Lucchesi M. Stability of columns with no tension strength and bounded compressive strength and deformability. *International Journal of Solids and Structures*. 2002; 39(25): 6191-6210.
- [6] Doh JH, Fragomeni S. Evaluation of experimental work on concrete walls in one-way and two-way action. *Australian Journal of Structural Engineering*. 2005; 6(1): 103-115.
- [7] Fragomeni S, Mendis AM, Grayson WR. Review of reinforced concrete wall design Formulas. *ACI Structural Journal*. 1994; 91(5): 521-529.
- [8] Crozier DA, Sanjayan JG. Slender reinforced concrete panel research. In: *Proceedings of 18<sup>th</sup> Biennial Conference on Concrete*. 1997: 347-353.
- [9] Robinson GP, Palmeri A, Austin SA. Tension softening effects on the buckling behaviour of slender concrete wall panels. In: *Proceedings of ISEC-6 on Modern Methods and Advances in Structural Engineering and Construction*. 2011: 715-720.
- [10] Comité Européen de Normalisation, EN 1990. Eurocode 0 basis of structural design. Brussels; 2002.
- [11] Gulvanessian M, Calgaro JA, Holicky M, Designer's Guide to EN1990 Eurocode: Basis of Structural Design. London: Thomas Telford Publishing; 2002.
- [12] Robinson GP, Palmeri A, Austin SA. Implications of EC2 on the design of simply supported precast RC panels under eccentric axial load. In: *Proceedings of fib Symposium on Concrete Engineering for Excellence and Efficiency*. 2011: 123-127.
- [13] Doh JH, Fragomeni S, Loo YC. Strength tests on slender reinforced concrete walls in one and two way action. In: *Proceedings of EASEC8 on Structural Engineering and Construction*; 2001: 1302.
- [14] Kripanarayanan KM. Interesting aspects of the empirical wall design equation. *ACI Structural Journal*. 1977; 74(5): 204-207.
- [15] Pillai SU, Parthasarathy CV. Ultimate strength and design of concrete walls. *Journal of Building and Environment*. 1977; 12(1): 25-29.
- [16] Sanjayan JG, Crozier DA, Cheuk JG. Tension softening effects on the buckling behaviour of slender concrete wall panels. In: *Proceeding of 5<sup>th</sup> International Conference on Concrete Engineering and Technology*. 1997: 132-149.
- [17] Monti G, Alessandri S, Santini S. Design by testing: A procedure for the statistical determination of capacity models. *Journal of Construction and Building Materials*. 2009; 23(2009): 1487-1494.
- [18] Dubina D. Structural analysis and design by testing of cold-formed steel structures. *Journal of Thin Walled Structures*. 2008; 46(2008): 741-764.
- [19] CSI SAP 2000 v-14, Integrated Finite Element and Design of Structures Analysis Reference Manual, *Computers and Structures Inc*, Berkley (2010)
- [20] Inel M, Ozmen HB. Effects of plastic hinge properties in nonlinear analysis of reinforced concrete buildings. *Journal of Engineering Structures*. 2006; 28(2006): 1494-1502.

- [21] Tsai WT. Uniaxial compression stress-strain relation of concrete. *Journal of Structural Engineering*. 1988; 114(9): 2133-2136.
- [22] Panagiotakos TB, Fardis MN. Deformations of reinforced concrete members at yielding and ultimate. *ACI Structural Journal*. 2001; 98(2): 135-148.
- [23] Mander JB, Priestley MJN, Park R. Theoretical stress-strain model of confined concrete. *Journal of Structural Engineering*. 1988; 114(8): 1804-1826.
- [24] Kent DC, Park R. Flexural members with confined concrete. *Journal of the Structural Division, ASCE* 1971; 97(ST7): 1969-1990.
- [25] Scott BD, Park R, Priestly MJN. Stress-strain behaviour of concrete confined by overlapping hoops at low and high strain rates. *Journal of the American Concrete Institute*. 1982; 79: 13-27.
- [26] Bamforth P, Chisholm D, Gibbs J, Harrison T. *Properties of concrete for use in Eurocode 2*. 1st Ed. Surrey: The Concrete Centre; 2008.
- [27] Gilbert RI. *Time effects in concrete structures*. 1st Ed. Amsterdam: Elsevier Science; 1988.



Figure 1

Normalised panel capacity design curves according to simplified design equations of international codes ( $\epsilon = t/6$ ;  $\phi = 0.6$  or  $0.7$ ) and the 'equivalent column' methodology in EC2 ( $\rho = A_s/Lt < 0.3\%$ ).

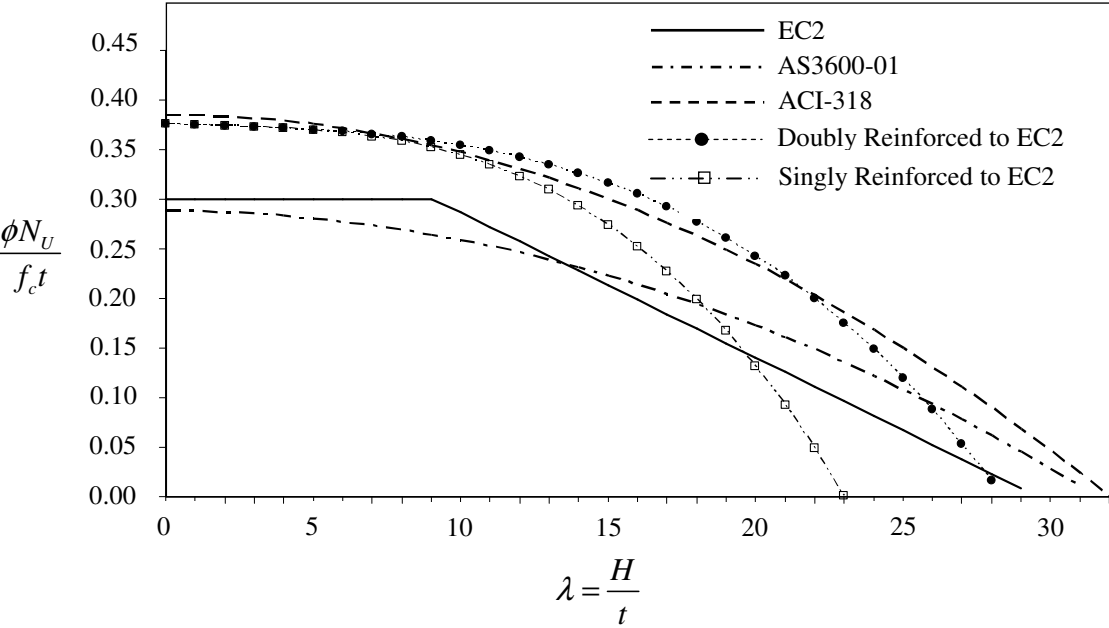
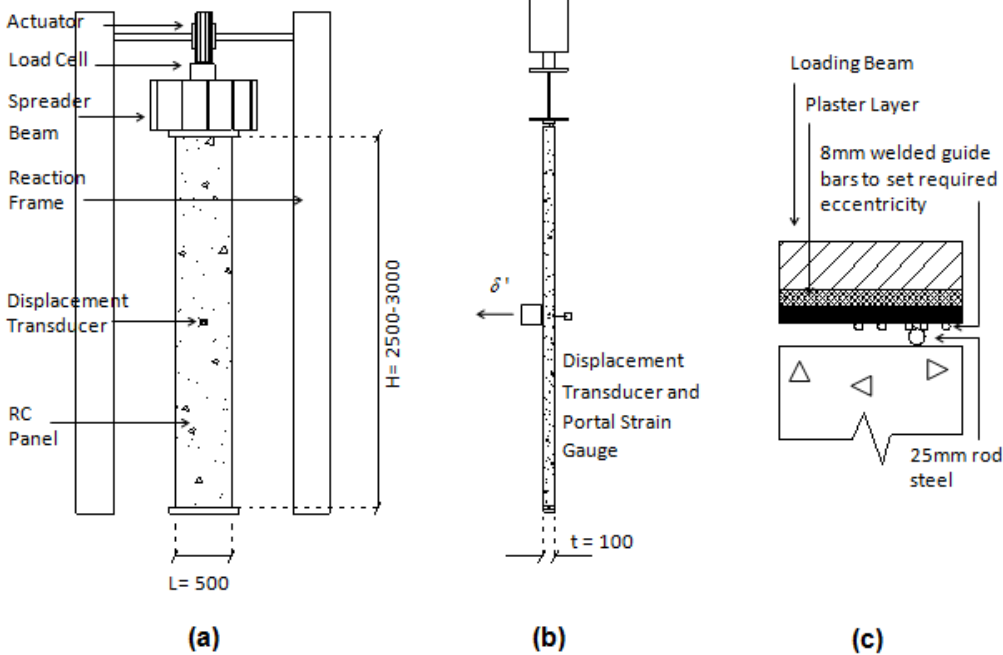

Figure 2

Experimental set-up: Test rig elevation (a); Test rig section (b); Pin joint loading detail (c)



**Figure 3**

Brittle failure observed in both pre-cracked and un-cracked RC panel elements



**(a)**



**(b)**

**Figure 6.3** Brittle failure observed in both pre-cracked and un-cracked RC panel elements

**Figure 4**

Comparison between theoretical and experimental results: Simplified design equation to EC2

(a); Equivalent column design method to EC2 (b); Alternative computational design approach

(c)

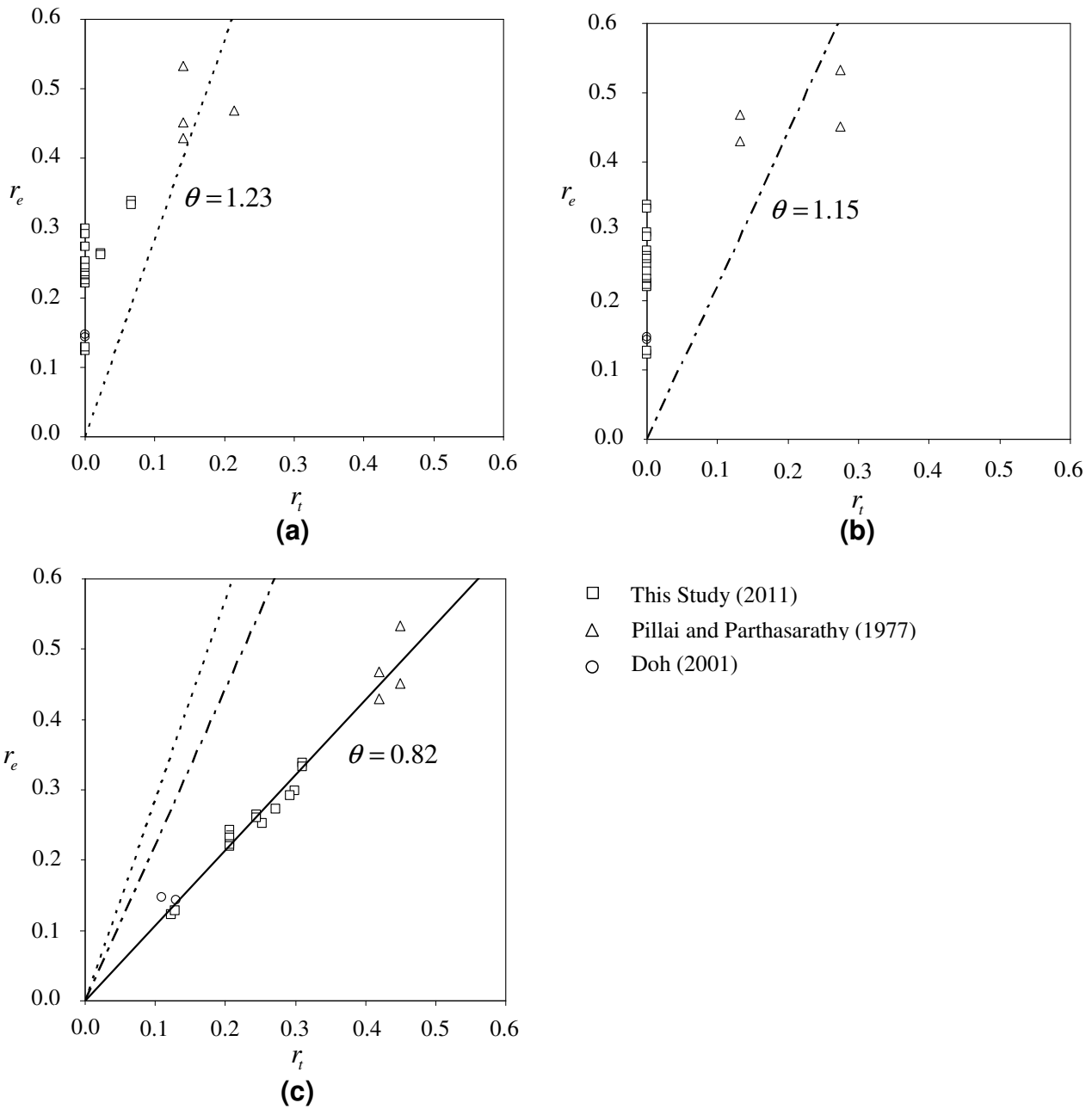

**Figure 5**

Key aspects of the lumped plasticity analysis: Computational idealisation of experimental set-up (a); Reinforcement layout and fibre hinge idealisation of wall panel cross section (b); Resulting compressive stress block (c); Resulting moment rotation response of fibre hinge (d)

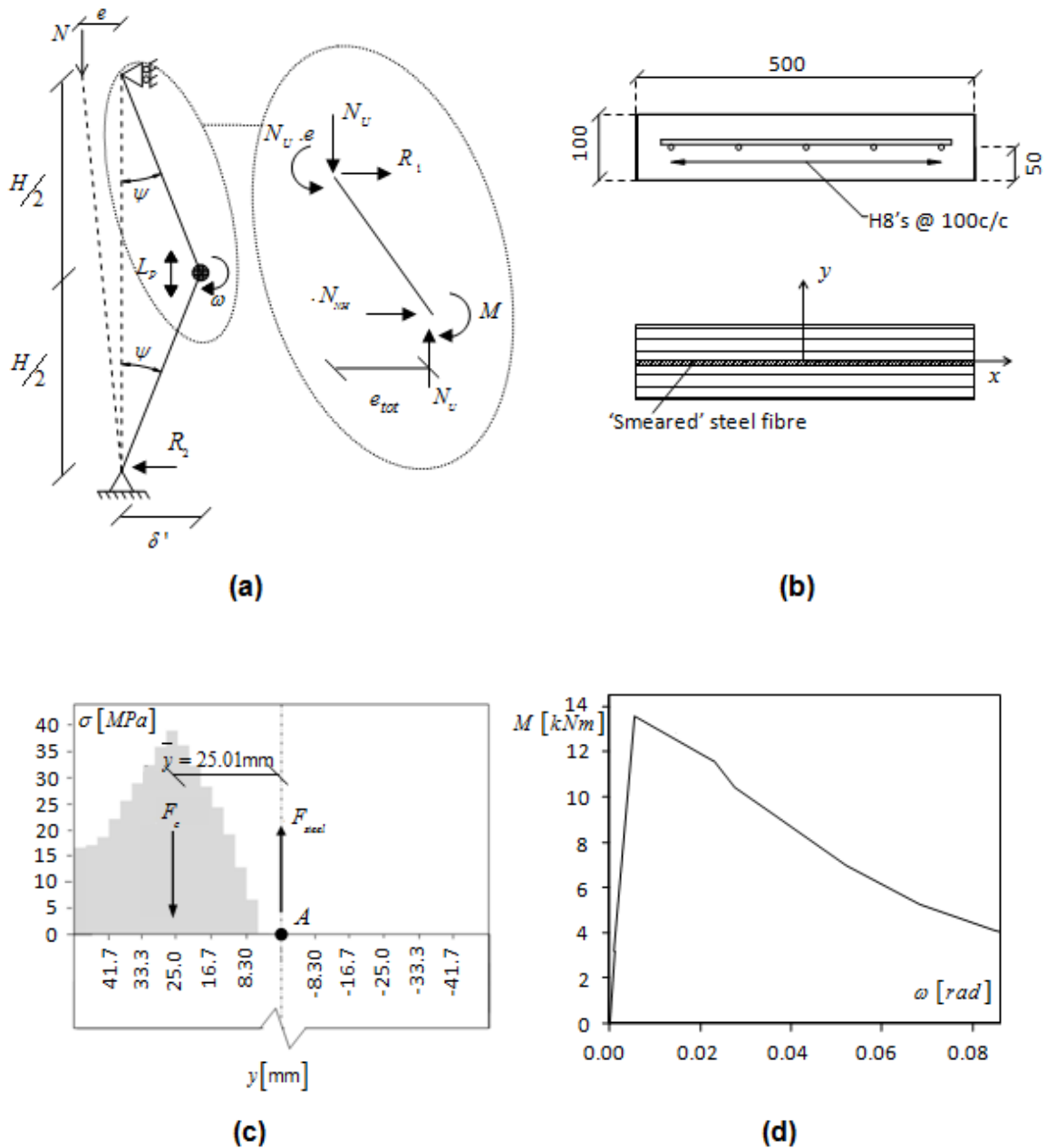
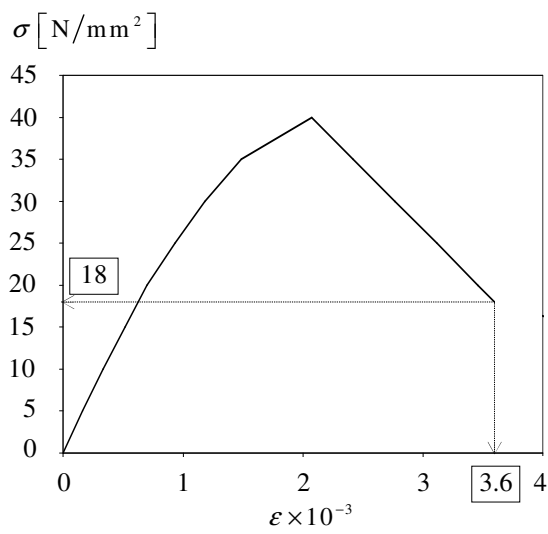
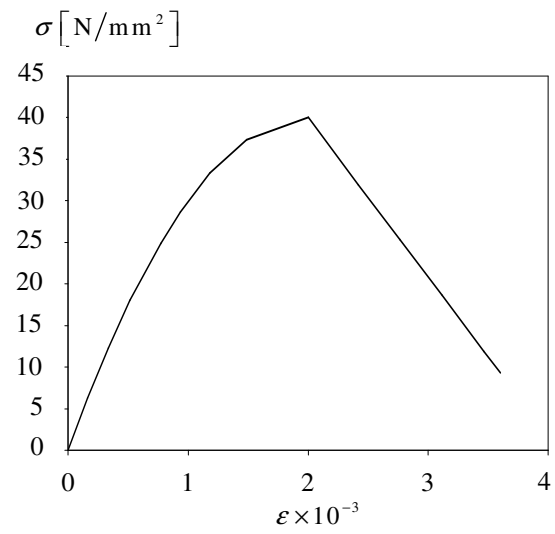

Figure 6

Material models adopted within computational analysis: Mander [24] (a); Park-Kent [25] (b); Mander with modification to tension softening branch (c); Accounting for time-dependant 'creep' effects (d)



(a)



(b)

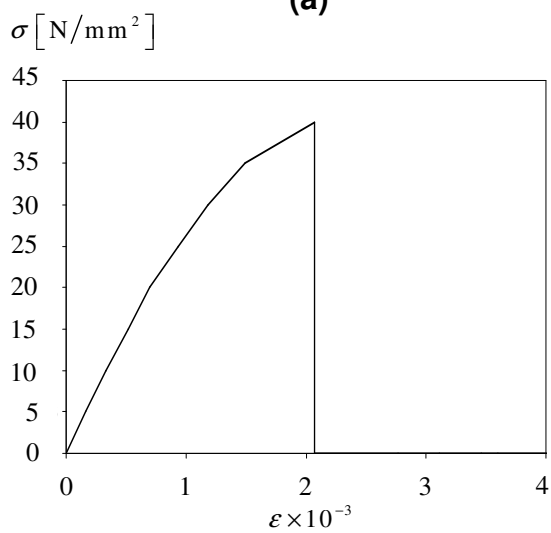

(c)

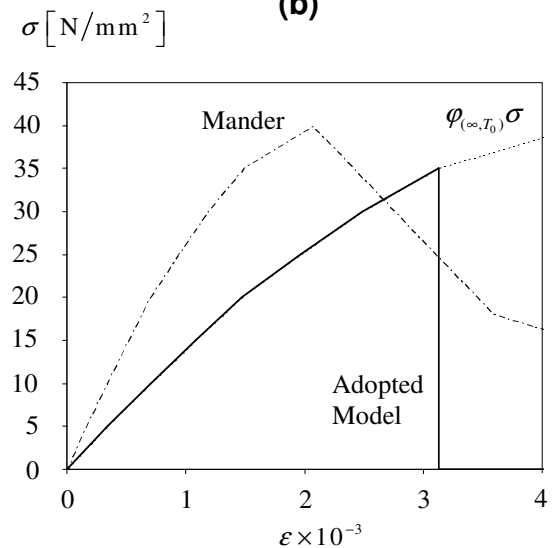

(d)

Figure 7

Experimental and computational load-deflection curves for panels with varying eccentric loads

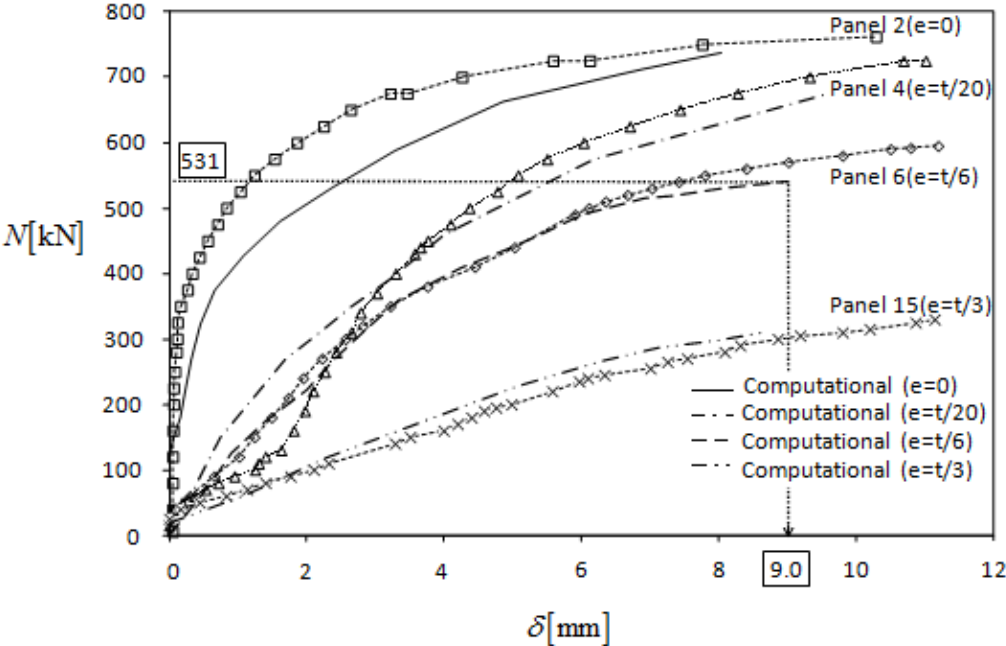

**Figure 8**

Experimental and computational strain plots for the outer fibre in tension for panels with varying eccentric loads

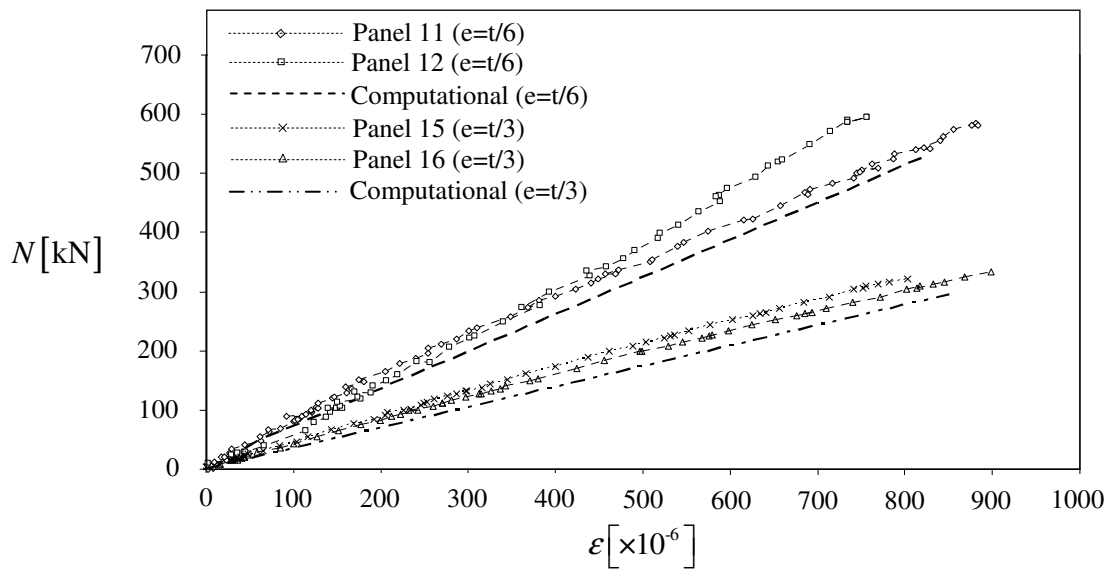
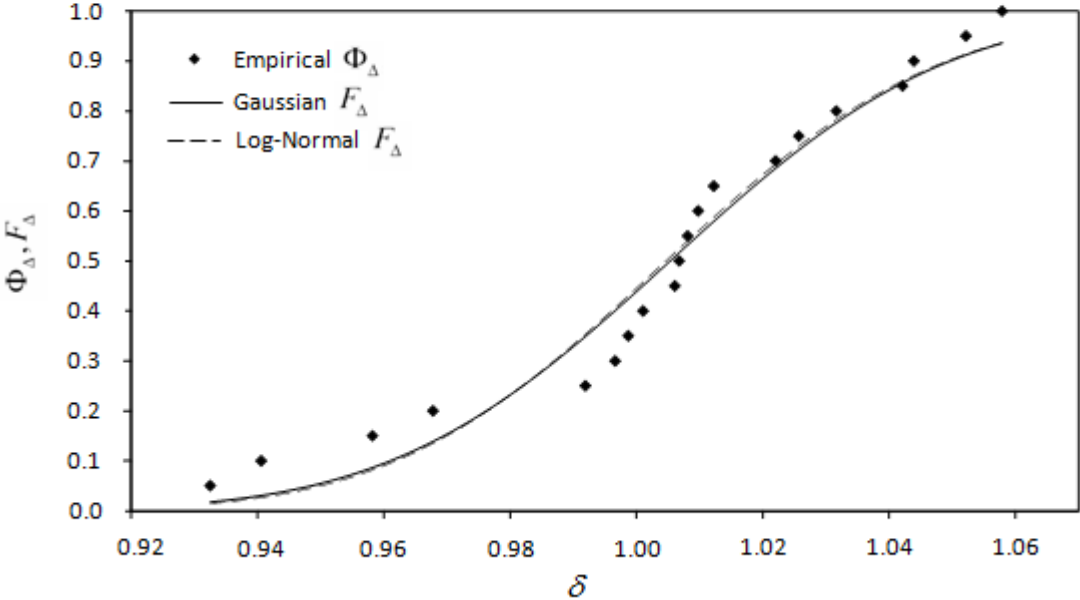



Figure 9

Statistical check of error properties. Cumulative distribution of the model error ( $\delta$ )





**Figure 11**

Alternative panel capacity curve developed from the use of the lumped plasticity idealisation with the DAT procedure ( $\epsilon = t/6$ )

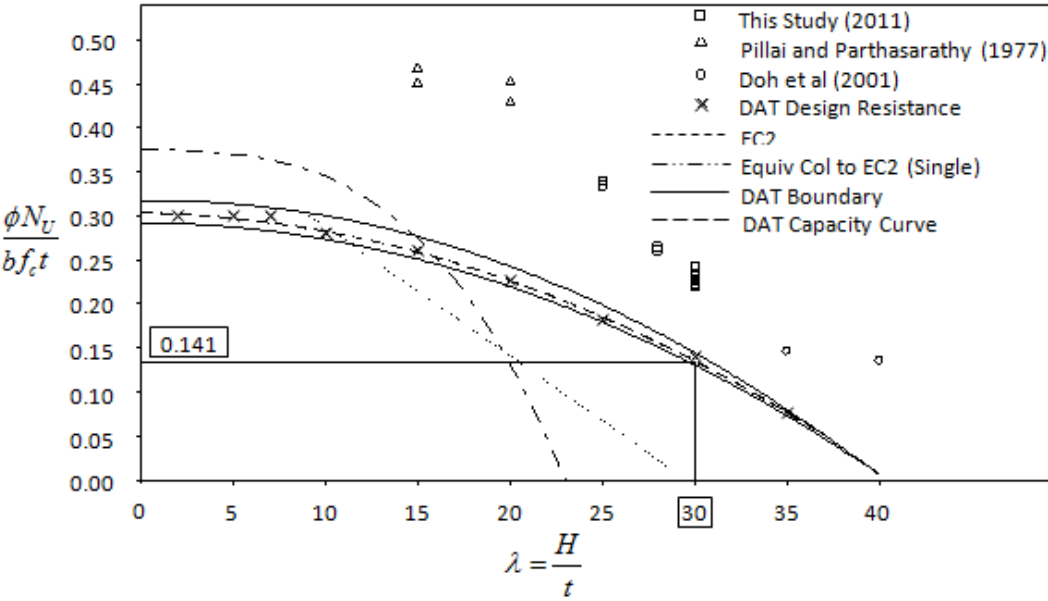

**Table 1**

Design expressions for simply supported one spanning RC panels to the major international codes ( $e = t/6$ ;  $\phi = 0.6$  or  $0.7$ )

Building Code	Design Expression
ACI 318-05 [1]	$\frac{\phi N_u}{F_c} = 0.385 \left[ 1 - \frac{\lambda^2}{1,024} \right]$
AS 3600-01 [2]	$\frac{\phi N_u}{F_c} = 0.288 \left[ 1 - \frac{\lambda^2}{1,000} \right]$
EN 1992-1-1 [3]	$\frac{N_u}{F_c} = 0.57 [0.76 - 0.026\lambda] \leq 0.83 - \frac{\lambda}{400}$

**Table 2**

Experimentally observed and predicted failure capacities

Panel N°	Slenderness ( $\lambda$ )	$f'_c$ (N/mm <sup>2</sup> )	$e$ (mm)	C (Cracked) or U (Un-cracked)	$N_u$ (kN)			
					Test	EC2 Simp Eq	EC2 Eqv Col	Lumped Plasticity
1	30	52.2	0	C	781	0	0	737.5
2	30	52.2	0	C	762	0	0	737.5
3	30	53.2	5	C	672	0	0	675
4	30	53.2	5	C	725	0	0	675
5	30	49.1	17	C	595	0	0	517
6	30	49.1	17	C	557	0	0	517
7	25	51.5	17	U	871	24.35	0	803
8	25	51.5	17	U	858	23.93	0	803
9	28	52.4	17	U	692	6.96	0	643
10	28	52.4	17	U	683	7.07	0	643
11	30	51.6	17	U	582	0	0	531
12	30	51.6	17	U	597	0	0	531
13	30	51.6	17	U	572	0	0	531
14	30	51.6	17	U	568	0	0	531
15	30	52.4	33	U	322	0	0	302
16	30	52.4	33	U	336	0	0	302

## 6.2 PAPER J2

Full Reference –

Robinson, G.P., Austin, S.A., Palmeri, A., 2013. **Adoption of Artificial Lightweight Aggregate in Precast Manufacture.** *Magazine of Concrete Research*, 65(19): 1-13, <http://dx.doi.org/10.1680/mac.13.00112>

Abstract –

This study investigates the incorporation of lightweight SPFA (sintered pulverised fuel ash) as a partial/complete replacement for natural sand and aggregates within full-scale precast elements. It focuses on SCC (self-compacting concrete) mixes after short periods of strength development, because of the lack of published experimental data for these concrete types and their significance in offsite manufacture. Aggregate failure means the use of SPFA reduces concrete capacity, particularly in shear and pull-out, and such reductions may be more prominent at an earlier stage of curing. These were investigated alongside the incorporation of steel fibres that may provide some compensation.

The variation in the compressive strength obtained was less significant (3-5%), following 24 hours of curing, than at 28 days (15%). A similar trend was observed across the range of densities and in the tensile and flexural strength tests, with a slightly increased workability also observed in the lightweight mixes. Similar testing of SFRC samples, with a  $50\text{kg}/\text{m}^3$  fibre content, challenges the appropriateness of current code design equations. More efficient element design may thus be possible for precast components where such design cases are prevalent. A 63% average increase in pull-out shear capacity also suggests an improved lifting capacity could be justified within precast elements.

Keywords – Concrete Technology and Manufacture, Research and Development, Strength and Testing of Materials

Paper type – Article

## 1 INTRODUCTION

An established by-product of coal-fired power generation, sintered pulverised fuel ash (SPFA) lightweight aggregate is formed by heating the previously pelletised PFA material to a temperature of around  $1100^{\circ}C$ . This process results in a hard, honeycombed and spherically shaped aggregate, suitable for inclusion within normal and high strength concretes (Mays, 2010). The size of such commercially available aggregate varies from a maximum dimension of 14mm to an equivalent fine aggregate ( $< 4\text{mm}$ ).

For a complete replacement of the coarse material, the resulting lightweight concrete has a dried density in the range of  $1700\text{-}1900\text{ kg/m}^3$ . By also incorporating SPFA as a fine/sand replacement, a further reduction in concrete density to  $1500\text{-}1600\text{ kg/m}^3$  is achievable, though it remains possible to obtain similarly high strength grades ( $60\text{ N/mm}^2$ ) (Kockal and Ozturan, 2011). Such high strength, lightweight concretes potentially offer benefits to the precast industry, where an improved strength to weight ratio is advantageous for the lifting and transportation of the manufactured units (Al-Khaiat and Haque, 1998). Other advantages are also associated with: sustainability, reduced thermal conductivity and improved acoustic performance for the resulting density (Mays and Barnes, 2010).

### 1.1 Research Significance and Objectives

The study was part of an assessment into the feasibility of incorporating SPFA lightweight aggregate materials within the manufacture of larger scale structural components, such as precast slab and panel elements. The review of technical literature (carried out in conjunction with an appraisal of the needs of contemporary precast manufacturers) revealed that, although the effects of using lightweight aggregate and sand products have been the subject of numerous studies (Kockal and Ozturan, 2011; Tomosawa, 1996; Kayali, 2008) in relation to the 28 day (and later) stages of strength development, a better understanding is needed of the fresh and early-age properties of such concretes (Wu et al., 2009). In this context, experimental data is required for alternative mix designs, considering both the partial and complete replacement of the existing heavy-weight sand and aggregate materials.

More specifically, it was found that, although European standard design guidance exists (EN-1992-1, 2004) with regards to how the material properties of generic lightweight concretes should be modified within the design of structural elements, it is still necessary to establish whether the concretes with SPFA replacement materials follow the trends and behaviours suggested by the existing design equations. This is because, to the best of our knowledge, an experimental verification has not yet been undertaken to demonstrate the suitability of the existing EN1992 (2004) equations when using values of  $f_c$  (for example) to predict the tensile splitting ( $f_{ct}$ ) or pull-out capacity of an anchor in the resulting concrete for the specific artificial SPFA aggregates considered, following only a 24 hour curing period.

Further, establishing whether the currently suggested trends, for concretes of varying density, account for the behaviour of lightweight concretes formed through the partial replacement of traditional aggregate with SPFA is also of interest, with the Elastic Modulus ( $E_c$ ) perhaps the characteristic most significantly affected in this instance.

Consequently, an experimental campaign was undertaken, focussing on the high-strength, high-flow concrete mixes commonly adopted within the precast industry, looking at the mechanical properties that are directly relevant to the manufacture of structural units such as: concrete flow, compressive strength, modulus of rupture, Young's modulus and pull-out shear capacity.

It is worth emphasising that, due to commercial pressures, structural precast components are often de-moulded, lifted and transported after only a short period of curing (12-24 hours). What this means in reality is that it is the concrete strength at this earlier stage of curing, rather than the anticipated in-situ loads that determine the concrete mix design for precast manufacture. This leads to a higher requirement for strength at 12-24 hours that is inevitably associated with a resulting excess of concrete strength after a full period of strength development, which is then effectively wasted over the element's design life. Further, achieving a high early-age concrete strength is also often a key design parameter in precast design in order to mitigate possible damage to the resulting components occurring during their handling.

One example of such early-age damage is the potential failure of the concrete occurring around any cast-in lifting bolts or fixing elements. Such a failure can happen in the unit during its transportation through the formation of a pull-out cone or other shearing



mechanism, and becomes a critical design consideration in terms of safety. Achieving high concrete strengths mitigates against such failure occurring, as well as against the risk of excessive deflection and the resultant cracking of certain precast elements. Because of such design issues, coupled with the fact that the inclusion of SPFA aggregate has been found to lead to a reduced concrete performance (Shimazaki et al., 1994), this study has also investigated the possibility of using steel fibre reinforcement (SFR) as a solution through which the loss of performance may be corrected for. This is a strategy suggested within the existing literature for other concrete mixes and applications (Hsu and Hsu, 1994; Kayali and Haque, 2003; Balaguru and Ramakrishnan, 1987). In the following, the technical background of the study is detailed, so to highlight current gaps in the field and justify the adopted experimental methodology.

### **1.2 Effect of Lightweight Aggregate Replacements on Early Age Concrete Strength**

Studies focussing on fully cured concretes have shown that the strength of lightweight aggregate (LWA) concretes is highly dependent upon the strength of the aggregate type incorporated. This is essentially because the shear strength of the LWA controls the failure of the concrete matrix, and therefore becomes the weak link in the system (Sarkar et al., 1992). However, a lack of data exists on the effects of the inclusion of the SPFA replacement materials after shorter curing periods. Further, Wasserman and Bentur (1996) demonstrated that observed differences in concrete strength capacity following shorter periods of strength development cannot always be quantified by consideration of the differences in the aggregate strength. Their study showed that these variations can also be attributable to physical and chemical processes which occur at the interfacial transition zone (ITZ) of the lightweight aggregates and the cement paste, with the physical process of ‘densification’ pertinently being demonstrated to have a significant (around 20%) influence on the measured early-age (1 day) concrete strength. In spite of this key finding no other published studies have attempted to quantify the significance of these effects, as they are dictated by the mix constituents selected.

### **1.3 Effect of SPFA Materials on Fresh Properties**

Numerous studies have been published in recent years on the use of lightweight aggregates in the production of SCC (Wu et al., 2009; Lo et al., 2007; Choi et al., 2006), with the majority focussing on the observed workability and rheological properties of the concretes (Topcu and Uygunoglu, 2010). It has been shown that the self-consolidating action acts to prevent the upward movement of the lightweight aggregates (LWA) and therefore the associated segregation (Topcu and Uygunoglu, 2010).

Khalai and Haque (2003) proved that both coarse and fine lightweight replacement materials can lead to a 32% reduction in fresh unit weight, with a slight increase in workability also observed for the SPFA concretes. Moreover, in studies focused on SCC constitutions (Wu et al. 2009; Wasserman and Bentur, 1996), slightly increased workabilities have been revealed for instances in which the 28-day concrete strength rather than the total water content is kept constant. That is, those in which the higher absorption of the SPFA aggregate type is correctly allowed for. However, the number and variations within the chosen mixes investigated by these studies is limited, with the partial replacement of normal with SPFA aggregate not considered.

### **1.4 Effect of SPFA Materials on Anchor Pull-out Strength**

The second part of our study specifically focuses on the pull-out failure of a 2.5 tonne capacity shear head lifting anchor (Figure 1(a)), as this fixing is representative of the current practices and needs within the precast industry. Due to the absence of any studies of these anchor types in SPFA concretes, it has been necessary to consider studies of analogous break-out cone failure modes, such as the pull-out of reinforcement bars of a similar size/diameter to the lifting bolts under consideration (Hassan et al., 2010; Sancak e al., 2011). Sancak et al (2011) demonstrated that a reduction in pull-out capacity of up to 20% can be observed when lightweight aggregate replacement materials are used as a complete substitute within an SCC concrete mix. In addition the variation in aggregate type adopted was also proven to change the failure type observed (Sancak et al., 2011), with a splitting mode, rather than the anticipated shear cone, recorded in the samples where the weaker aggregate type was incorporated. However, this reduced capacity and change in failure mode were observed in

concretes using a natural rather than artificial aggregate type, with the testing also undertaken once the concrete had achieved full strength. It was deemed important therefore to establish whether similar phenomenon would be observed in SPFA concretes following only a 24 hour curing period, as well as whether design equations suggested within available regulatory guidance are appropriate.

### **1.5 The Effect of Introducing SFR within SPFA Concrete Mixes**

As discussed in Section 1.1, establishing the ability of a steel fibre dosage to sufficiently correct for the reduction in material characteristic strengths, often observed in SPFA aggregate concretes, is a key objective of the investigation. Although a number of studies (Gau et al., 1997; Libre et al., 2011) have found the effect of steel fibre inclusion to have a beneficial effect on the mechanical properties of lightweight concretes at a later stage of strength development, data with respect to its effect on concretes cured for periods of less than three days is extremely limited.

However, the ability of this reinforcement type to significantly improve the early age characteristics of more standard, normal-weight high-strength concretes, has already been identified and demonstrated by studies, such as that by Ding and Kusterle (1999). Their work investigated the effect of using various steel fibre dosages ( $20\text{-}60\text{ kg/m}^3$ ) on the concrete's resulting compressive strength and punching resistance at the early age time intervals of 10, 18, 30 and 48 hours. This study is of particular interest, with a shear failure directly relevant (although inverted) to the expected anchor failure type. The work demonstrated that the inclusion of SFR had the ability to greatly increase the observed shear capacity of the resulting concrete elements investigated, following only short curing periods, with the steel fibre content working effectively as shear reinforcement. Because of these findings, testing to establish whether a similar effect could be observed in SPFA lightweight concretes was undertaken.

---

## 2 MATERIAL AND METHODS

### 2.1 Material Used

The binder was Portland Cement (CEM IIA/A-LL 42.5N), in compliance with the requirements of BS EN 197-1, having a fineness of  $505 \text{ m}^2/\text{kg}$  and a density of  $3.15 \text{ g}/\text{cm}^3$ . The super-plasticiser was a polycarboxylate ether, with a specific gravity of 1.1% and a solids content of 20%. If specified within the mix, the natural river sand had a specific gravity, fineness modulus and water absorption by weight of 2.62%, 2.15% and 3.79% respectively. The normal weight coarse aggregate had an oven dried particle density of  $2.6 \text{ Mg}/\text{m}^3$ , a water absorption percentage of 0.8 and a drying shrinkage of 0.026% in accordance with BS EN 1097-6.

The chemical composition of the SPFA fine and coarse materials are defined within Table 1, along with a number of key physical characteristics of these constituents, all of which conform to the requirements of BS EN 13055-1. The coarse aggregate (4/14mm) replacement material had a declared oven dry loose density of  $710 \text{ kg}/\text{m}^3$ , a particle density of  $1.31 \text{ Mg}/\text{m}^3$  and an aggregate crushing strength of  $6.5 \text{ N}/\text{mm}^2$ . An oven dried loose density of  $900 \text{ kg}/\text{m}^3$  is declared for the sand replacement SPFA (0/4mm), with the particle density again  $1.31 \text{ Mg}/\text{m}^3$ . The hooked end steel fibres incorporated as part of the relevant mixes were: 50mm long, 0.75mm in diameter, with an aspect ratio of 67mm and a tensile strength greater than  $1100 \text{ N}/\text{mm}^2$ . The traditional reinforcing bars incorporated as part of the slab elements (see Figure 1(d)) had a yield stress of  $500 \text{ N}/\text{mm}^2$  and a grade B ductility to appropriate European standard (BS EN 10080).

### 2.1 Mix Proportions

Eight SCC mix designs (based upon those currently adopted by a leading UK precast manufacturer for wall, slab and culvert elements) were developed and prepared in order to determine the effects of incorporating various proportions of SPFA replacement lightweight aggregate and fine materials on the resulting one day properties of the concrete. The constituents and proportions relevant to each of these eight mixes are shown in Table 2. Relatively high cement contents ( $500 \text{ kg}/\text{m}^3$ ) were included within the SCC mixes as a way to

minimise the segregation potential of the flowing concrete. As can be seen, the SPFA coarse aggregate is varied from 0-100% within mixes A (control mix) to D when used in conjunction with a standard sand material. Further, the implications of utilising a complete SPFA replacement concrete mix was also investigated within test mixes E and G, with the cement content also varied between the two compositions in this instance.

Mixes F and H are those in which a  $50\text{kg}/\text{m}^3$  content of steel fibre reinforcement is additionally incorporated, so as to quantify their effects on lightweight mixes using both coarse and fine SPFA replacements. The steel fibre dosage level was chosen based upon the findings and recommendations of previous studies. Gau et al (1997) identified a content of 2% by volume to represent a limit, in relation to the effectiveness of the steel fibre reinforcement in improving the compressive strength of high strength concrete mixes, with minimal improvements observed beyond this volume fraction. In addition, the ability to ensure the effective compaction of the mix, as well as a suitable dispersion of fibres, was also stated to become difficult above this limit. A SFRC dosage level of  $50\text{kg}/\text{m}^3$  was therefore selected, with this quantity thus also allowing for a direct comparison with previous studies conducted in normal weight concretes (Ding and Kusterle, 1999).

### **2.2 Production and Testing Procedures**

All normal and artificial lightweight aggregates were oven dried before mixing, so as to allow for the water proportion within the mix to be more closely controlled. Batch sizes varied from  $0.01\text{-}0.09\text{m}^3$  depending on the type and number of samples to be cast. Initially, the cementitious material and sand fines were premixed for a period of five minutes, with the coarse aggregate and relevant steel fibre content then added prior to a subsequent mixing period. Finally, the correct water and superplastizer contents were added during 3-5 minutes of further mixing before the test specimens were cast within the steel moulds.

Because of the high fluidity of the SCC mixes designed, a slump flow (in accordance with BS EN 12350) was adopted by spreading horizontally the collapsed slump concrete in two orthogonal directions  $D_1 \times D_2$ . Figure 2(a) illustrates the testing apparatus, consisting of a normal slump cone and a plastic plate (or flow board) of dimension  $1000 \times 1000$  mm that is

---

marked with a circle of diameter 500mm so that the  $t_{500}$  parameter (i.e. the time required for the concrete mix to reach a diameter of 500mm) could be determined.

In addition, a series of L-box tests were also conducted in order to further quantify the fluidity of the lightweight self-compacting mixes, as well as assess their ability to flow around steel bars. The test apparatus consisted of a vertical chimney section and a horizontal channel, into which the concrete mix is allowed to flow as shown within Figure 2(b). The ratio of the level of the self-compacting concrete in the chimney and channel sections ( $h_2/h_1$ ) as well as the time it takes for the concrete to reach 400mm from the steel bars ( $t_{400}$ ), were additionally measured to provide a metric relating to concrete workability. Again this testing was undertaken in line with BS EN 12350.

Six 100mm cube samples were cast for each period of curing (i.e. at 24 hours, 7 and 28 days) and for each of the eight mixes, giving a total of 144 (6x3x8) cubes. Further, six 150x500mm cylinder samples were cast per mix, so as to determine the early age Young's modulus of the relevant concretes as part of a non-destructive test, with these same samples then subsequently used to derive values of the indirect tensile strength  $f_{ct}$  from a split cylinder test. Forty-eight (6x8) 100x100x500mm flexural beam samples were also cast to determine the flexural indirect tensile strength ( $f_{sv}$ ), with three further 500x600x100mm slab elements manufactured for (mix types A, E and F), to investigate the pull-out behaviour of the selected anchor type (see Figure 1).

After casting, all the specimens were covered and stored in the laboratory environment, with each of the specimens de-moulded after 15 hours of casting. The samples tested within 24 hours of casting were cured in the laboratory environment (typically  $15 \pm 2^\circ C$ ) after de-moulding but those tested for their 7 and 28-day properties were stored in a water tank maintained at  $21 \pm 2^\circ C$ .

The density of each of the samples was determined prior to any further testing using procedures in agreement with BS EN 12390-7. The compressive strength ( $f_c$ ) of the samples was determined from 100mm cube samples in accordance with BS EN 12390 part 3. The indirect tensile strength from the cylindrical samples was tested in accordance with BS EN 12390 part 6 whilst the flexural strength was determined in accordance with BS EN 12390 part 5. Prior to carrying out the destructive split cylinder testing, the same samples were used

to establish the modulus of elasticity ( $E_c$ ) of each concrete mix following 24 hours of curing. This was achieved by axially loading each test specimen within a compression rig. The secant modulus was calculated based on the value of stress corresponding to 40% of the previously determined ultimate concrete strength and the corresponding longitudinal strains observed at this load in accordance with available UK technical guidance (Bamforth et al., 2008).

Additional experimentation was also carried out to establish the pull-out shear capacity achieved by a spherical-head lifting anchor (Figure 1(a)), which has an admissible lifting force of 25kN. Pull out trials, in accordance with CEN TR 15728 (2008), were then conducted on 600x600x150mm test slabs that were reinforced with grade 500B, 12mm high-yield bars at 100mm centres in two orthogonal directions (see Figure 2(d)). These slab specimens were then simply supported on their four edges by a rigid metallic frame, with a 100mm effective bearing (Figure 2(d)). The load could then be applied axially through the lifting anchor and the connection shackle (see Figure 2(c)), with the rate of deformation at midpoint controlled by the load cell to be 1.5 mm/min to comply with the testing regulation (TR15728, 2008).

## **3 RESULTS**

### **3.1 Fresh Properties**

Table 3 details the resulting fresh properties of the SPFA SCC mixes investigated, whose inspection suggests that a slight increase in workability occurs for each increase of coarse lightweight percentage. These findings are in line with those of previous studies (Wu et al., 2009; Wasserman and Bentur, 1996; Lo et al., 2007; Choi et al., 2006), where such behaviour is explained by the fact that the lighter weight particles within the suspended matrix may be more greatly affected by the super-plasticising agent. The results of this study also appear to demonstrate that a similar effect is still realised in mixes using a combination of normal and light weight aggregates, which (based upon the literature review undertaken) had not previously been established.

The observed behaviour may also partly be attributed to the increased roundness of the industrially manufactured SPFA aggregate, compared to the traditionally adopted gravel types, with the variation between the assumed and actual rate of water absorption in the SPFA aggregate also being another potential cause. That is, any difference or error between these

two values would mean that more water is present in the system that is not absorbed by aggregate. While resulting in an increased workability, such variation in water content may also contribute towards the reduced strengths seen in this and previous studies for SPFA lightweight mix designs (EUROLIGHTCON, 2004; Lydon, 2001).

Table 3 also shows a more significant increase in mix workability when the fine lightweight replacement material is included. These results validate the experimental findings of previous studies, such as that by Lo et al (2007) who hypothesised that the rounded shape of such industrially-manufactured fine PFA particles improves the flowing and passing ability of the concrete relative to the more angular particles occurring within natural sand.

Further, whilst an increased workability was also observed for mix G, significant decreases were seen for the concrete mixes F and H (Table 2). For mix G, where the cement content is reduced, the resultant fresh concrete is acting as would be expected according to the appropriate fluid model, as demonstrated by Banfill (1994). In this model, a larger cement content acts to increase the yield stress and plastic viscosity of the resulting Bingham fluid. By contrast, the reduction of flow and passing ability observed within mixes F and H is attributable to the presence of the SFR content. The quantity of fibre was observed to impede the flow of the SCC, particularly within the L-Box test, with the reduced passing ability of such mixes also evident from Figure 3, where a good linear correlation exists between the observed values of  $t_{400}$  and  $t_{500}$  workability parameters, with only mixes F and H significantly diverging from the observed trend.

### **3.2 Density and Compressive Strength**

From Table 4 it is evident that a maximum 31% reduction in air-dried concrete density ( $1,568 \text{ kg/m}^3$  compared to  $2,196 \text{ kg/m}^3$  of the control mix) can be achieved with a complete replacement of coarse and fine constituents. Other aggregate blends had densities between these values depending on the percentage of lightweight aggregate and cement contents included (Table 2). Such densities compare well with those found within previous studies and technical literature. For example, Bungey and Madandoust (1994) achieved an average density of  $1789 \text{ kg/m}^3$  with a mix design that replaced both aggregate and fines with SPFA equivalents and  $1971 \text{ kg/m}^3$  with one that only replaced the aggregate, with research more



directly applicable to SCC mixes (Kockal and Ozturan, 2011) also documenting density ranges of 1560-1960  $kg/m^3$  for industrially applicable SPFA concrete mixes.

The values of compressive strength  $f_c$  in Table 4 are the mean values of the six cube samples. The coefficients of variation of the plain concretes were in the range of 3.3-5.2%, with the larger variations (7.1-8.9%) observed for the FRC mixes F and H, as expected given the higher variability of this type of material. It can be seen from Figure 4(a) that the variation of concrete strength with density, which in this case is associated with the percentage of replacement material incorporated, is more significant following 7 and 28 days ( $\approx 15\%$ ) of strength development, with a much smaller increase (4-5%) apparent after 24 hours.

The results, with respect to earlier age strength therefore do not follow the trend presented by UK concrete research organisations (Concrete Centre, 2006; Daly, 1999) that suggest that for a C40/50 grade mix, the concrete strength varies with density in accordance with the expression:

$$f_c = 0.06\rho - 1 \times 10^{-5} \rho^2 - 15 \quad (23)$$

This expression is represented by the dashed curves plotted as part of Figure 4(a), with the constant adjusted to allow for the expected reduction in concrete grade/strength associated with normal weight concretes following the stated periods of curing.

These findings also appear, *prima facie*, to contradict those of Wasserman and Bentur (1996), who reported a reduction in the compressive strength of SPFA mixes (prepared with an aggregate blend of 51% lightweight aggregate and 49% graded normal weight fines, at an effective w/c ratio of 0.4) by up to 20% after 24 hours of curing, relative to a control mix. This variation was deemed to occur because the strength development of the paste was thought to be more critical for early-age samples than those which have gained full strength, in which case aggregate shear failure dominates. However, and as previously identified (Section 1.2), additional physical and chemical processes were also investigated and believed to contribute to the more significant variation in early age concrete strength observed by Wasserman and Bentur (1996).

For example, their study did not focus on the pelletised SPFA aggregates but on replacement PFA materials which had been modified through non-standard chemical, physical or heat treatment processes. It appears therefore that it was because of these aggregate manufacturing

---

processes that the interfacial reactions between the cement matrix and artificial aggregate were seen to have a more significant influence on the early-age properties of the concretes. It can also be hypothesised that the additional pozzolanic reactions observed previously (Wasserman and Bentur, 1996) did not occur within the 28 day timescale considered, (or at least not to an extent that is sufficient to influence the strength). The reason could be that the PFA material is not sufficiently fine to act as an additional cementitious binder and/or more time is necessary for the reactions to occur.

Figures 4(a) and 4(b)) reveal a more prominent divergence in concrete strength relative to the SPFA content occurs at the latter ages of 7 and 28 days. This can be quantified of course if we consider the coefficient of variation for the samples across mixes A-E at the chosen time intervals. By way of example, the CoV increases from 4.1% to 8.1% between 1 and 7 days of curing. This is because early-age concrete strength is significantly dependent on the rate of strength development in the cement paste (Wasserman and Bentur, 1996), which is primarily a function of the cement content and water-cement ratio. Because a similar water to binder proportion was purposefully maintained for each of the SCC mixes investigated, the limited variations observed would be expected. This is opposed however, to the 7 and 28 day samples in which the shearing capacity of the aggregate becomes more critical, with a roughly linear relationship now observed between  $f_c$  and the percentage of SPFA replacement material incorporated. It is also apparent from Table 4 that, while the high cement contents of the SPFA concrete mixes still provide the early stage strengths necessary to avoid issues during stripping, lifting and transportation procedures, it does not result in excessive concrete strengths being realised and underutilised in service, as is typical of concrete mixes used in the precast industry.

If we now consider those mixes incorporating an additional  $50 \text{ kg/m}^3$  steel fibre content (F and H) in comparison to their non-SFRC equivalents (E and G), only a very small increase in 24 hour compressive strength occurred (1.6-2.8%). These findings are in line with those of Ding and Kusterle (1999), which did not show any significant trend relating to the ability of the steel fibres (using contents in the range of  $40\text{-}60 \text{ kg/m}^3$ ) to improve the compressive strength of normal weight concretes with curing periods of less than 24 hours. This is perhaps owing to the fact that although the failure of the compressive sample essentially results from tensile and tensile-shear effects, which the SFR content should abate, it is likely that the failure of the

cube samples is actually initiated by tensile strains and micro-crack formation within the lightweight aggregate itself. The subsequent bond-cracking will then occur at the aggregate paste interface, with the macro-scale cleavage cracking thus being able to initiate and propagate in a manner that is largely independent of the need for the cracks to propagate through the cement matrix. It is therefore less likely to be influenced by the ability of the SFR to control cracking within this region. Table 4 also shows the mixes with SFR to have a larger variation than the non-SFR equivalent mixes, as expected given the obvious variability of the resulting composite. Table 4 also highlights the significant impact of the reduced cement content incorporated as part of mix G.

### 3.3 Splitting Tensile and Flexural Strength

The inclusion of steel fibres was found to increase the 24 hour average flexural and split cylinder capacities significantly (19.5% and 21.2% for  $f_{ct}$  and  $f_{sw}$ , respectively). This trend is in agreement with previous studies (Gau et al., 1997), in which the inclusion of the steel fibres is shown to improve these mechanical properties in lightweight concretes, albeit at a later stage of strength development. No experimental data was found as part of the literature review that could demonstrate whether a similar scale of improved capacity is seen after shorter periods of curing in SPFA mixes.

Gau et al (1997) considered a lightweight aggregate mix with similar cement ( $515\text{-}520\text{ kg/m}^3$ ) and fibre contents ( $47\text{ kg/m}^3$ ) to those reported. However, a much more prominent improvement in the flexural and split cylinder strengths was demonstrated once the concrete had developed a full strength, with increases of 34% and 38% observed for the split cylinder and flexural strengths respectively. The less prominent improvement in concrete capacity (relative to historical data (Gau et al., 1997)) is believed to be related to the shorter curing period, resulting in a reduced bond between fibres and cement matrix. Importantly, the nature of the stress development for split cylinder and flexural samples means that the initial micro-cracking within the lightweight aggregate does not control the resultant failure in the same way (or to a similar extent) that it does within compressive cube samples, since the cleavage cracking in these samples initiates and progresses within the cement paste matrix. Because of this, the presence of the steel fibres becomes more influential, and therefore more

significantly impacts the flexural and split cylinder capacities. On the other hand, very little variation was seen within the early-age tensile splitting and flexural values for the non-SFR LWA concrete alternatives (B-E) relative to the control mix (A), with the exception being the 15% reduction observed within samples cast using mix G. This reduction however, is more likely associated with the reduced cement content rather than the presence of the SPFA materials.

It is worth emphasising here that the tensile strength of a concrete mix is important within the design procedure for precast elements as it is a necessary variable for the calculation of the minimum reinforcement areas to control cracking and also re-bar anchorage lengths. The European design standard (EN 1992-1, 2004) recognises that the tensile strength of LWA concrete ( $f_{lcm}$ ) needs to be modified in comparison with a normal weight concrete ( $f_{cm}$ ) of the same strength class, and the following equation is suggested:

$$f_{lcm} = f_{cm} \left( 0.4 + 0.6 \frac{\rho}{2200} \right) \quad (24)$$

Where  $\rho$  is the oven dried density ( $kg/m^3$ ) of the resulting concrete.

However, this equation has been developed for concretes following full periods of curing and where the reduction in density is achieved through a 100% replacement of a homogeneous aggregate type. Despite this, Figure 4(c) shows Eq.(2) (dotted lines) to provide a suitable conservative prediction of tensile strength for both the 1 day and 28 day curing times, in relation to both this and previous experimental campaigns (EUROLIGHTCON, 2004; Clarke, 1987; Walraven and Stroband, 1995). The observed variation at 1 day is again much smaller in relation to the control sample, suggesting that a beneficial modification factor may be appropriate within the design of precast concrete elements when deriving the value of  $f_{lcm}$  to be used in design, following shorter periods of strength development.

The inclusion of the SPFA aggregate however, does appear to influence the failure type observed within the test samples. As can be seen (Figure 5(c)), instead of a clean and distinct fracture surface being observed between the two parts of the cylinder, a less conventional shear failure through the artificial sintered aggregate occurred and this mode of failure became more prominent as the SPFA aggregate and fine content was increased. Table 4 also reveals an increasing coefficient of variation within the tested samples as the SPFA content was increased.

### 3.4 Modulus of Elasticity

The elastic modulus of the LWA samples was observed to reduce by up to 26.3% of the control sample, in a manner that appears to be proportional to the percentage of normal weight aggregate replaced. The European design standard (EN 1992-1, 2004) allows for the incorporation of light weight aggregate by modifying the design value for the elastic modulus ( $E_{lcm}$ ) relative to that of a normal weight aggregate according to the equation:

$$E_{lcm} = E_{cm} \left( \frac{\rho}{2200} \right)^2 \quad (25)$$

As can be seen from Figure 4(d), Eq.(3) (dotted lines) appears to provide a conservative estimate of the elastic modulus achieved with SPFA LWA concretes. However, the results obtained following only 24 hours of curing do appear to more significantly deviate from the proposed trend than that seen from previous studies (EUROLIGHTCON, 2004; Lydon, 2001), which considered a full curing period. It should be noted however, that the trend will vary depending on the nature of the control aggregate incorporated, and as such comparison between different studies is difficult. It is likely therefore that the lack of correlation in the data captured as part of this study with the suggested theoretical trend is due to the differences between the aggregates in each of the studies represented, rather than to the hybrid nature of the concretes considered.

Further, while the incorporation of the SPFA fine material has been observed to bring about a reduction in the derived values of ultimate material strength (Section 3.2), the 100% replacement of both aggregate and sand products seems to have a much more limited influence on the resulting stiffness of the concrete (Neville, 2008). The coefficient of variation for the six samples considered as part of this non-destructive test (Figure 4(d)) was also less pronounced than that observed within the same samples undergoing testing to derive their ultimate splitting capacity (Table 4). This is because the modulus of elasticity ( $E_c$ ) is dependent on the aggregation of the SPFA material characteristics as a whole, as opposed to the failure of the weakest aggregates. The effects of fibre reinforcement on the resulting elastic 'secant' modulus of the concrete sample were also observed to be limited (3-5%) at an early 24-hour age, which is consistent with the results of similar testing conducted on concrete

samples that had achieved full strength after a curing period of 28 days (Kayali and Haque, 2003).

### 3.5 Pull-Out Failure of Lifting Anchors

Three 600x600x150mm test slab elements (Figure 1(b)) were cast for each of the type A, E and F concrete mix variations, as detailed within Section 4.3. The type E mix was selected to provide an indication of the worst-case anchorage strength that would be seen, for concretes incorporating a proportion of SPFA content relative to the control. It is asserted that this mix also represents the worst-case performance for a lifting anchor's pull out capacity in the SPFA concretes investigated and thus provides an indication of the modification factor that should be applied to the safe working loads already experimentally determined and verified for the same lifting anchors in standard concretes. Through manufacturing samples using the same complete replacement SPFA concrete mix, but which also included a content of SFR (Mix F), it was thought possible to quantify the ability of the fibre content ( $50\text{kg}/\text{m}^3$ ) to correct for the reduced pull-out capacity.

Although the European design standard (EN-1992, 2004) does not currently provide guidance with regards to the pull-out cone failure of lifting anchors in concrete elements, they do specify rules associated with the modification of allowable punching shear resistance in reinforced and unreinforced lightweight concrete elements according to the equation:

$$V_{IRd,c} = c_{IRd,c} \cdot k \cdot \eta_1 (100 \cdot \rho \cdot f_{lck})^{1/3} \quad (26)$$

where  $\eta_1 = 0.4 + (0.6\rho/2200)$  is a correction factor based on the reduced density of the lightweight concrete utilised and  $c_{IRd,c}$  and  $k$  are further design constants also modified due to the use of a lightweight concrete mix. A value of  $k=1.0$  is imposed for concretes incorporating SPFA materials as replacements for both coarse and fine materials, as opposed to normal weight concretes where  $k=2.0$ . Further, according to the Eurocodes, for Mix E  $c_{IRd,c} = 0.15$  compared to  $c_{IRd,c} = 0.18$  for mix A. Thus, for the SPFA concrete mix a reduction factor of 0.03 ( $c_{IRd,c} k \eta_1 = 0.15 \times 1.0 \times 0.18$ ) is applicable, compared to 0.09 which would be applied for mix A. Essentially therefore a safety factor of 3 is applied to allow for the reduced shear capacity of SPFA aggregate types. No account is currently taken within the design codes for such concretes incorporating steel fibres.

Nine pull-out tests were conducted in all, with each slab sample loaded through the lifting anchor, fixing and shackle arrangement (see Figure 1(c)). An average pull-out capacity of 28.3kN was obtained for the control mix samples, with a typical pull-out shear cone forming around the anchor fixing. Lower pull-out capacities of 24.2kN, 20.0kN and 21.2kN were recorded in samples cast from mix type E, averaging 21.8kN. A pull-out cone was again observed to form, although the diameter and depth of the section of concrete detached from the sample was less than that observed within the control sample, with extensive aggregate shear failure obvious. The reduced pull-out capacities suggest that a reduction factor in the region of 20-30% should be adopted by the design engineer when specifying fixings or anchors of this nature into SPFA concretes. The current European standard therefore appears to be very conservative when designing for these failures in SPFA concretes at an early age, as relevant in precasting, and more extensive testing should be undertaken to obtain a more appropriate modification factor.

A significant increase in the pull-out capacity was observed in the samples tested in which steel fibre reinforcement was included. Values of 37.8kN, 35.2kN and 33.6kN were achieved in these instances, averaging 35.6 kN which represents a 62.5% increase in the average pull-out capacity. Furthermore, the failure type was much more akin to that of a two way-spanning slab than the 'pull-out' cone observed for the previous samples (Figure 5(d)). The amount by which the pull-out capacity of the anchor was improved by the addition of the  $50 \text{ kg/m}^3$  steel fibre content is similar in magnitude to the improvement observed by Ding and Kusterle (1999) for the punching shear capacity of normal weight concrete slab elements, although these elements did incorporate a slightly higher fibre content ( $60 \text{ kg/m}^3$ ). It can therefore be concluded that the ability of steel fibre reinforcement to significantly influence the shear capacity of concrete within the early stages of strength development is similar for both normal and lightweight SPFA concrete variations. However, the derivation of a suitable modification factor, which could then be applied within the design process, in order to allow an engineer to benefit from the use of SFR content within SPFA concrete mixes, would require further research due to the variable nature of this hybrid concrete.

## 4 CONCLUSIONS

Making precast elements with lower concrete densities offers potential benefits to manufacturers in terms of lifting and transportation. An experimental investigation was therefore conducted to establish relevant fresh and early age material characteristics of SCC mixes with a partial or complete replacement of traditional gravel and sand constituents with sintered pulverised fly ash (SPFA) lightweight alternatives. Little published information is available on the early age performance of such materials, or the suitability of current design equations in relevant European standards. The following conclusions can be drawn.

1. The workability of the mix variations improved as the ratio of lightweight to normal weight aggregate was increased, with the influence of the super-plasticising agent being more significant on the lighter aggregate material. The more spherical, industrially manufactured, SPFA fine particles were also demonstrated to increase the workability of the mixes adopting a complete replacement of the heavyweight materials. However, the inclusion of a  $50 \text{ kg/m}^3$  content of steel fibre reinforcement (SFR) was found to be detrimental to the rheological characteristics of the high-flow mixes investigated, with specific fibres and dosage levels adopted impeding both the ability of the SCC mix to flow under its own self weight and also around steel reinforcement.
2. A maximum reduction of 25% in air-dried concrete density was found to be feasible through the replacement of normal weight with SPFA aggregate types, with a roughly linear relationship observed in the partial replacement mixes developed. A further 11% reduction in density was achieved through the incorporation of the SPFA fine material.
3. It was found that, whilst the introduction of this aggregate replacement led to a reduction of up to 15% in concrete strength at 28 days, the 24 hour strength only reduced by up to 4.2% for concretes with an equivalent cement content. This is because the earlier age strength is less significantly dominated by the failure of the SPFA aggregate, which is responsible for the reduced concrete strengths (relative to normal weight control mixes) following longer periods of curing.



4. Because of this, it was seen that the trends currently proposed by UK concrete research organisations for predicting the compressive strength of SPFA concrete mixes, relative to the resulting concrete density are probably not applicable for concretes following shorter periods of curing. It was also demonstrated that strength variation following 1 day of curing, for the SPFA aggregate investigated were less pronounced than those suggested in historical research (Wasserman and Bentur, 1996), with the physical and chemical treatment of the SPFA aggregates within this study therefore significant.
5. Relating to the design of precast structural elements, it was shown that the design of the normal weight concrete mix is often determined through the need to achieve high early age strength. However, this leads to an excess capacity in full concrete strength. Because similar 1 day strengths can be achieved in lightweight SCC concrete mixes, these concretes provide the precast industry with a suitable alternative mix that would have resulting strength closer to that required within the design.
6. It is also concluded that because the observed deviation within SPFA samples relating to indirect concrete tensile strength ( $f_{ct}$ ) at 24 hours was less pronounced than that seen after a full period of curing, the introduction of a beneficial modification factor may be applicable within current European design regulations (EN 1992-1, 2004) for design cases where shorter periods of strength development has occurred. Such a factor would consequentially allow for the more suitable design of precast elements against excessive early age cracking and deflection.
7. The pull-out capacities obtained for shear-head lifting anchors, cast within small scale slab samples, indicate that a 20-30% reduction factor is appropriate when designing fixings within SPFA lightweight aggregate concretes and indicates therefore that the existing European design guidance may be overly restrictive when considering cast-in anchor capacities for precast elements following short periods of curing. The inclusion of hooked steel fibres ( $50\text{kg}/\text{m}^3$ ) significantly enhanced the pull-out shear capacity of the anchors within the SPFA concrete type, with the failure mechanism changing in nature from a pull-out cone to a more two-way spanning slab element failure. It was seen that SFRC improves the 24 hour pull-out capacity of SPFA concretes to a similar extent as that observed in normal weight concretes (Ding and

Kusterle, 1999). Because of this a higher safe working load of lifting anchors could be justified in precast elements, meaning that potentially larger components could be lifted without the need for a more costly cast-in anchor.

In summary, SPFA lightweight aggregate may offer several advantages to the design and manufacture of precast structural components. The research suggests, however, that the design equations for calculating compressive and tensile strengths in the European standard may underestimate the behaviours of these concretes at early ages.

### **References**

BS EN 197-1 (2011). Cement composition specification and conformity criteria for common cements. BSI, London, UK.

BS EN 1097-6 (2000). Tests for mechanical and physical properties of aggregates determination of particle density and water absorption. BSI, London, UK.

BS EN 13055-1 (2002). Lightweight aggregates lightweight aggregates for concrete mortar and grout. BSI, London, UK.

BS EN 10080:2005 (2005). Steel for the reinforcement of concrete weldable reinforcing steel-general. BSI, London, UK.

BS EN 12350 (2009) Testing fresh concrete. BSI, London, UK.

BS EN 12390 (2009). Testing hardened concrete. BSI, London, UK.

EN 1992-1-1 (2004). Eurocode 2 design of concrete structures part 1-1 general rules and rules for buildings. CEN, Brussels, Belgium.

TR 15728 (2008) Design and use of inserts for lifting and handling of precast concrete elements. CEN, Stuttgart, Sweden.

Al-Khaiat H, Haque MN (1998) Effect of initial curing on early strength and physical properties of lightweight concrete. *Cement and Concrete Research* 28: 859-66.

Balaguru P, Ramakrishnan V (1987) Properties of lightweight fibre reinforced concrete. In *Proceedings of Fiber Reinforced Concrete Properties and Applications* (Shah SP, Batson GB (eds)). American Concrete Institute, Detroit, US, pp. 305-22

Bamforth P, Chisholm D, Gibbs J and Harrison T (2008) Properties of concrete for use in Eurocode 2, CCIP-029, The Concrete Centre, Surrey, UK.

Banfill PFG, (1994) Rheological methods for assessing the flow properties of mortar and related materials. *Construction and Building Materials* 8(1): 43-50.

Bunghey J and Madandoust R (1994) Strength variations in lightweight concrete beams, *Cement and Concrete Composites* 16: 49-55.

Clarke JL (1987) Shear strength of lightweight concrete beams: design to BS 8110, *Magazine of Concrete Research* 39(141): 205-50.

Choi YW, Kim YJ, Shin HC and Moon HY (2006) An experimental research on the fluidity and mechanical properties of high-strength lightweight self-compacting concrete. *Cement and Concrete Research* 36(9): 1595-1602.

Concrete Centre (2006) Technical guide N<sup>o</sup>8: Guide to the use of lightweight aggregate concrete in bridges. The Concrete Centre, Surrey, UK.

Daly FD (1999) Use of lightweight aggregate concrete in bridge construction: summary report PR/CE/267/98, Transport Research Laboratory, Wokingham, UK.

Ding Y and Kusterle W (1999) Comparative study of steel fibre-reinforced concrete and steel mesh-reinforced concrete at early ages in panel tests. *Cement and Concrete Research* 29: 1827-1834.

EUROLIGHTCON (2004) Economic design and construction with lightweight aggregate concrete. [www.sintef.no/static/BM/Projects/EuroLightcon](http://www.sintef.no/static/BM/Projects/EuroLightcon) (accessed 10/12/12).

Gau J, Sun W and Morino K (1997) Mechanical properties of steel fiber-reinforced high-strength lightweight concrete. *Cement and Concrete Composites* 19: 307-313.

Hassan AAA, Hossain KMA and Lachemi M (2010) Bond strength of deformed bars in large reinforced concrete members cast with industrial self-consolidating concrete mixture. *Construction and Building Materials* 24: 520-530.

Hsu LS and Hsu CTT (1994) Stress-strain behaviour of steel fibre high-strength concrete under compression. *ACI Structural Journal* 91(4): 448-57.

Kayali O, Haque MN (2003) Some characteristics of high strength fiber reinforced lightweight aggregate concrete. *Cement and Concrete Composites* 25: 207-213.

Kayali O (2008) Fly ash lightweight aggregates in high performance concrete. *Construction and Building Materials* 22: 2393-2399.

Kockal NU and Ozturan T (2011) Strength and elastic properties of structural lightweight concretes. *Materials and Design* 32: 2396-2403.

Libre NA, Shekarchi M, Mahoutian M and Soroushian P (2011) Mechanical properties of hybrid fibre reinforced lightweight aggregate concrete made with natural pumice. *Construction and Building Materials* 25: 2458-2464.

Lo TY, Tang PWC, Cui HZ and Nadeem A (2007) Comparison of workability and mechanical properties of self-compacting lightweight concrete and normal self-compacting concrete. *Material Research Innovation* 11(1): 45-50.

Lydon FD (2001) High strength lightweight concrete in bridges. In *Proceedings of Concrete 2001 Seminar*. Concrete Development Group, London, UK, pp 22-29.

Mays GC and Barnes RA (2010) Performance of lightweight aggregate concrete structures in service. *Structural Engineering* 69(20): 351-61.

Neville AM (2008) *Properties of Concrete*. fourth ed., Pearson Education Ltd., London, UK.

Sancak E, Simsek O and Appay AC (2011) A comparative study on the bond performance between re-bar and structural lightweight pumice concrete with/without admixture. *International Journal of the Physical Sciences* 6(14): 3437-3454.

Sarkar SL, Chandra S and Berntsson L (1992) Interdependence of microstructure and strength of structural lightweight aggregate concrete. *Cement and Concrete Composites* 14: 239-44.

Shimazaki M, Hatanaka A and Tanigawa Y (1994) Compressive failure and toughness of high strength concrete made with lightweight aggregate. In *Proceedings of the Japan Concrete Institute* 161: 657-662.

Tomosawa F (1996) Special HPCS II: Lightweight aggregate HPC, self-compacting HPC. In *Proceedings of Fourth International Symposium on the Utilization of High Strength/ High*

Performance Concrete (de Larrad F, Lacrix R (eds)). Laboratoire Central des Fonts et Cahusses, Paris, France, pp. 83-92.

Topcu IB and Uygunoglu T (2010) Effect of aggregate type on properties of hardened self-consolidating lightweight concrete (SCLC). *Construction and Building Materials* 24: 1286-1295.

Walraven J and Stroband J (1995) Bond tension stiffening and crack width control. In *Proceedings of International Symposium on Structural Lightweight Concrete*, Sandefjord, Norway, pp 56-64.

Wasserman R and Bentur A (1996) Interfacial interactions in lightweight aggregate concretes and their influence on the concrete strength. *Cement and Concrete Composites* 18: 67-76.

Wu Z, Zhang J and Ding Y (2009) An experimental study on the workability of self-compacting lightweight concrete. *Construction and Building Materials* 23(5): 2087-92.

Figure 1

Experimental arrangement for determining anchor pull-out capacity in small scale slab elements: (a) 2.5 tonne double head Capstan lifting anchor; (b) Cast slab element with centrally located anchor; (c) Axial loading shackle arrangement; (d) Slab and test rig section

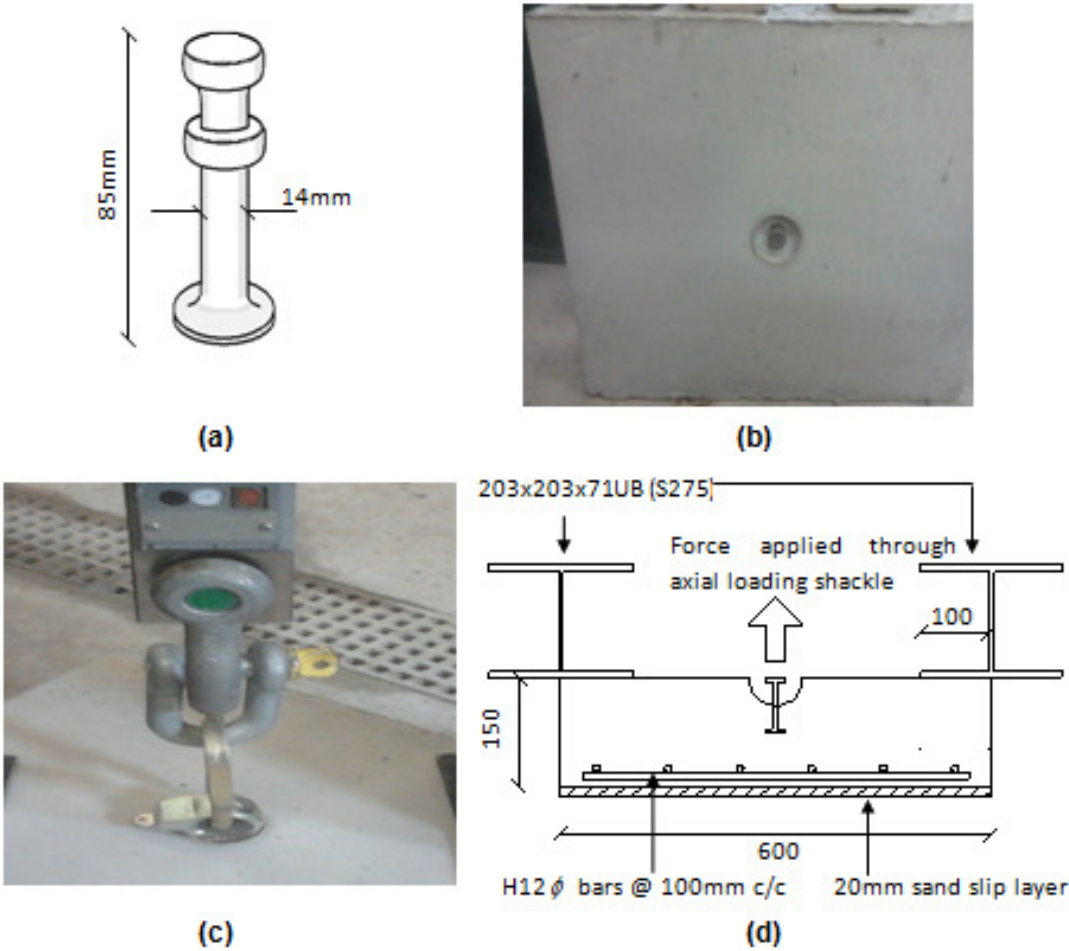

Figure 2

Workability test apparatus: (a) schematic drawing of slump flow test; (b) schematic drawing of L-box test apparatus

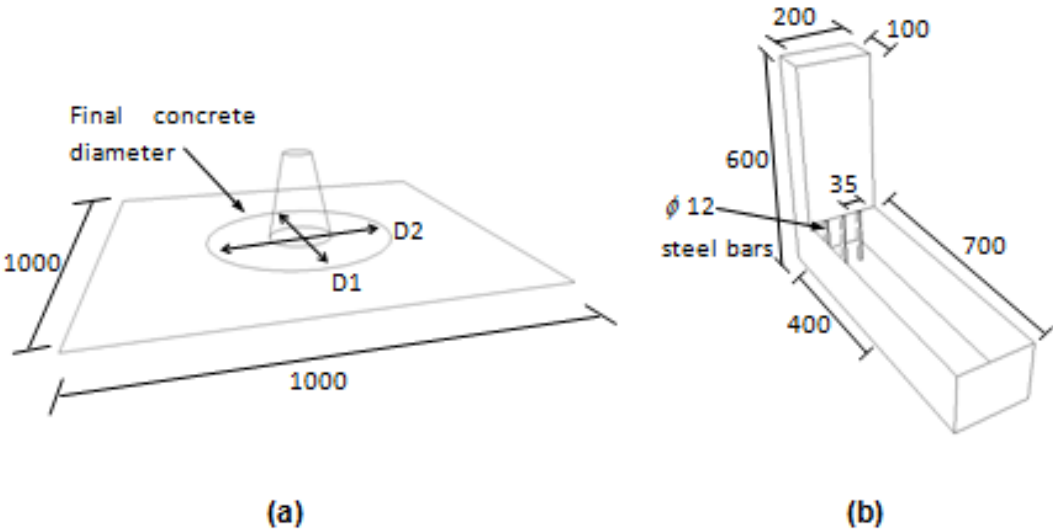

Figure 3

Relationship between  $t_{400}$  and  $t_{500}$  workability metrics for SPFA mixes developed

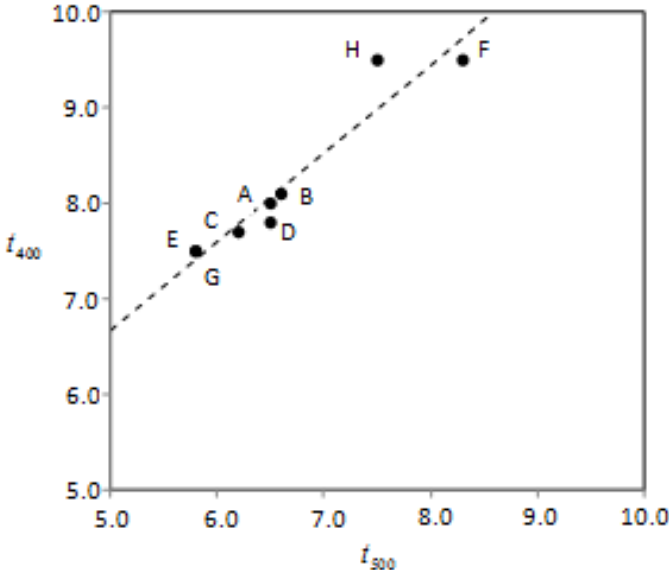
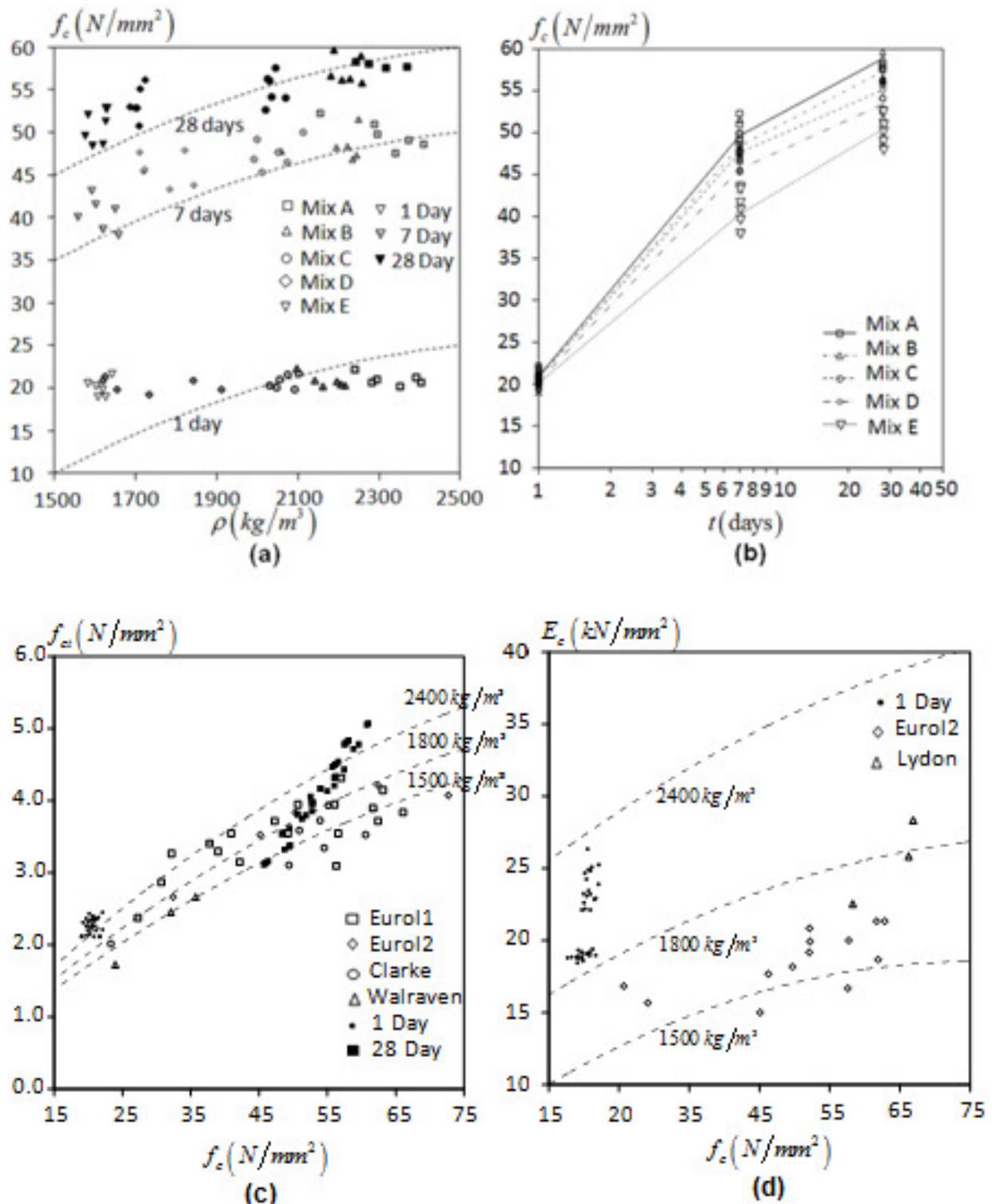

Figure 4

Material Properties for LWA Concretes Produced Using SPFA Aggregates (a); Compressive Strength ( $f_c$ ) Development Versus Density ( $\rho$ ) (b); Compressive Strength ( $f_c$ ) Development with Time (c); Compressive Strength ( $f_c$ ) against Tensile Splitting Strength ( $f_{ct}$ ) in comparison to historical studies [Eurolightcon (2004), Clarke (1987), Walraven (1995)] (d); Correlation of Compressive Strength ( $f_c$ ) with Elastic Modulus ( $E_c$ ) in comparison with past studies (Eurolightcon (2004), Lydon (2001))





**Table 1**

Chemical Properties of SPFA Lightweight Aggregate and Sand Replacement Materials

Chemical Composition	SiO <sub>2</sub> (53%); Al <sub>2</sub> O <sub>3</sub> (25%); Fe <sub>2</sub> O <sub>3</sub> (6%); CaO(4%); MgO(2.9%); SO <sub>3</sub> (0.4%); CL <sup>-</sup> (0.01%); LOI (3.1%)
0-4mm Grading (wt. %)	<0.13mm (31.2%); 0.13-0.5mm (17.1%); 0.5-2.0mm (33.3%); 2.0-3.15mm (10.6%); >3.15mm (7.8%)
4-14mm Grading (wt. %)	<0.063mm (2.4%); 0.063-4mm (1.6%); 4-6.3mm (16.6%); 6.3-10mm (66.4%) >10mm (13.0%)
0-4mm 1 h water absorption	20.2%
4-14mm 1 h water absorption	18.6%

**Table 2**

Mix Proportions

Mix Type	Mix Description	Cement (kg/m <sup>3</sup> )	0/4mm SPFA	4/14mm SPFA	Agg. Fine (kg/m <sup>3</sup> )	Agg. Coarse (kg/m <sup>3</sup> )	Steel Fibre (kg/m <sup>3</sup> )	Superpl. (litres)	w/c
A	C40/50 N/mm <sup>2</sup> SCC Control	500	-	-	860	860	-	3.5	0.35
B	25% SPFA Coarse	500	-	85	860	610	-	3.5	0.35
C	50% SPFA Coarse	500	-	215	860	430	-	3.5	0.35
D	100% SPFA Coarse	500	-	462	620	-	-	3.5	0.35
E	100% SPFA Coarse + Fine (Cem 500)	500	495	362	-	-	-	3.5	0.35
F	100% SPFA Coarse + Fine + SFR (Cem 500)	500	495	362	-	-	50	3.5	0.35
G	100% SPFA Coarse + Fine (Cem 450)	450	504	369	-	-	-	3.5	0.35
H	100% SPFA Coarse + Fine + SFR (Cem 450)	450	504	369	-	-	50	3.5	0.35

**Table 3**

## Fresh Concrete Properties

Mix Type	Slump Flow ( $D_1 \times D_2$ ) (mm)	$t_{300}(s)$	L-Box ( $h_2/h_1$ )	$t_{400}(s)$
A	650x655	6.5	0.86	8.0
B	652x652	6.6	0.83	8.1
C	651x648	6.5	0.84	7.8
D	673x668	6.2	0.86	7.7
E	690x700	5.8	0.91	7.5
F	604x607	8.3	0.84	9.5
G	696x708	5.8	0.90	7.5
H	611x605	7.5	0.82	9.5

**Table 4**

Mean Value and Coefficient of Variation (percentage in square brackets) for different Concrete Material Properties:

Mix Type	Dry Density ( $kg/m^3$ )	24 hour $f_c$ ( $N/mm^2$ )	7 Day $f_c$ ( $N/mm^2$ )	28 Day $f_c$ ( $N/mm^2$ )	24 hour $f_{st}$ ( $N/mm^2$ )	24 hour $f_{sw}$ ( $N/mm^2$ )
A	2318 [5.3%]	20.91 [3.3%]	49.67 [3.5%]	58.86 [2.7%]	2.30 [4.0%]	2.84 [3.2%]
B	2196 [5.0%]	20.73 [3.7%]	48.33 [3.5%]	57.22 [2.8%]	2.31 [4.4%]	2.81 [3.5%]
C	2048 [5.8%]	20.67 [3.9%]	47.58 [3.7%]	55.06 [3.3%]	2.26 [4.9%]	2.67 [3.6%]
D	1734 [4.7%]	20.27 [3.9%]	45.62 [4.1%]	53.38 [3.6%]	2.25 [4.8%]	2.66 [4.1%]
E	1612 [5.8%]	20.05 [5.1%]	40.24 [4.8%]	50.41 [3.7%]	2.22 [5.4%]	2.55 [4.8%]
F	1712 [9.6%]	20.38 [7.1%]	41.18 [6.8%]	51.52 [6.3%]	2.66 [7.1%]	2.99 [9.2%]
G	1568 [4.6%]	18.97 [4.6%]	37.88 [4.2%]	47.66 [3.8%]	1.98 [5.4%]	2.34 [5.3%]
H	1608 [10.1%]	19.48 [8.9%]	36.84 [8.4%]	48.36 [7.3%]	2.36 [8.8%]	2.93 [8.7%]

### 6.3 PAPER C1

Full Reference –

Robinson, G.P., Palmeri, A., Austin, S.A., 2012. **Influence of Steel Fibres, Used in Conjunction with Unconfined Rebar Configurations, on the Structural Performance of Precast Elements.** In: *Proceedings of 8<sup>th</sup> RILEM International Symposium on Fibre Reinforced Concrete-Challenges and Opportunities*, 19-21 September, Guimaraes, Portugal

Abstract –

A joint experimental and computational research program has been carried out to demonstrate the potential benefits of using Steel Fibre Reinforcement (SFR) within the design and manufacture of two key structural elements, namely slender walls and thin lintels with dapped ends, often adopted within the pre-cast concrete industry. The investigations specifically focus on the advantages of utilising SFR in conjunction with traditional bar reinforcement in an unconfined layout. This configuration allows cost savings in regards to precast manufacture and enjoys good performance in terms of durability and fire resistance, though its use is currently limited by the brittle mode of failure. The paper sets out to prove that the inclusion of SFR within the concrete matrix is capable of inducing a more ductile response in the structural members under consideration, therefore potentially making it possible to justify the adoption of such unconfined layouts in the design practice.

Keywords – Steel Fibres, Pre-cast Concrete, Unconfined, Buckling, Fibre Hinge, Strut and Tie

Paper type – Article

---

## 1 INTRODUCTION

Historical testing and research studies [1],[2] [3] have demonstrated that the adoption of single, centrally placed or minimum reinforcement configurations in RC wall elements, which are subjected to an eccentric axial load, results in a sudden and brittle failure mechanism. In addition, research undertaken to date [1] has also shown the ‘flexural cracking’ response of the slender RC wall elements to be critical in determining the resulting buckling behaviour and ultimate failure load of the panel. This is opposed to the more conventional assumption that the element’s capacity and response can be found by consideration of the component’s ultimate flexural capacity. This method however, has been shown to be suitable only for sections using a double layer of confined longitudinal reinforcement, where the longitudinal reinforcement ratio of this section ( $\rho = A_s/lt$ ) is greater than 1% [3], where  $A_s/l$  is the cross-sectional area of reinforcement per unit length of the panel and  $t$  is the thickness of the panel. The term flexural cracking is used here to describe the situation where the concrete section at the critical location cracks in flexure (and the resulting concentrated loss of stiffness, combined with the lack of influential tension steel) controls the resulting structural behaviour and ultimate stability of the panel much more than would occur with doubly reinforced panels, where  $\rho = A_s/lt \geq 1\%$  [4]. Hence, the axial capacity of the RC wall element becomes dependent on the element’s flexural stiffness up to and post cracking. Consequently, appropriate account now needs to be taken of the contribution of the concrete acting within both the tension and compression stress block as part of the design of the element. Further, this flexural cracking response has been shown to control the response and capacity of centrally reinforced panel elements adopting unconfined rebar configurations, up to a steel ratio of  $\rho = A_s/lt = 3\%$  [5].

Thus the controlling failure mechanism of the identified RC wall elements will, in part, be influenced by the formation and subsequent progression of flexural cracks in the concrete at the panel’s critical section. It follows therefore that if, as argued, the initiation and behaviour of such cracks in the concrete section can be considered to be significant when determining the structural response of such panels, the incorporation of steel fibre reinforcement should therefore be seen to influence substantially the resulting behaviour and ultimate capacity of the panel elements under consideration. This is because the use of SFR concrete mixes has

been shown to bring about a number of improvements in the mechanical performance of concrete, relating to aspects such as: a delay in micro-crack propagation to a macroscopic scale, the hindrance of macroscopic crack development and an improved structural ductility [6]. Aimed at demonstrating, as well as better understanding and designing for this predicted influence, the paper summarises the results of experimental and computational analyses for the relevant panel types and SFR concrete mixes.

From the literature reviewed as part of this investigation, few resources or research studies appear to currently exist, which aid in the design of slender panel elements, using a combination of both SFR and the traditional longitudinal reinforcement configurations proposed. Aimed at improving this current situation, the paper proposes and evaluates the possible use of a computational procedure, in which ‘lumped plasticity’ is used to predict the behaviour and buckling capacity of the resulting structural members. The method has previously been shown to provide a good correlation for slender precast panel elements, albeit for test samples adopting only a traditional unconfined reinforcement configuration and a standard (C40/50 grade) concrete mix design [3]. It is believed however, that if this design method is suitably modified to account for the SFRC material behaviour, the proposed technique could also be used to derive a design capacity for the panel elements adopting the hybrid of reinforcement types considered. The method utilises a non-linear fibre hinge at the known critical cross section of the panel, in order to simulate the buckling response of the slender walls.

The second aspect of the paper considers pre-cast lintels, supported on end projections that have been reduced in height. Such ‘dapped end’ or ‘halving joint’ details are common in precast construction because they beneficially lead to a reduction in the construction depth required. The experimental investigation undertaken therefore aims to increase the understanding of the shear behaviour and capacity of these resulting discontinuity shear or ‘D-regions’, for situations in which: a centrally placed, unconfined and welded reinforcement mesh is to be used in conjunction with varying percentages of additional steel fibre content. Additionally, the structural testing undertaken will also aid in the development and verification of an analytical Strut-and-Tie Model (STM), capable of accounting for the use of such a non-traditional reinforcement strategy.

---

## **2 CURRENT LIMITATIONS OF EXISTING DESIGN METHODS IN RELATION TO UNCONFINED AND STEEL FIBRE REINFORCING STRATEGIES**

### **2.1 Design of Eccentrically Loaded Precast RC Panels**

Both the major national codes of structural design practice reviewed (ACI-318 [7], EC2 [8]) currently devote specific sections to the design and detailing of simply supported RC wall panels, subjected to an eccentric axial load. Each of the specified design standards allows for the design of such elements through the adoption of one of two possible design methods. The first of these alternatives involves the use of simplified design equations that have been empirically (or semi-empirically) derived from a limited amount of experimental data [9]. These expressions however, allow no account to be taken in regards to either the quantity or the distribution of longitudinal reinforcement. Also, the simple design equations do not currently allow for or enable the modification of the concrete material model, required in this instance to account for, and potentially take advantage of, the modified concrete behaviour due to the presence of the steel fibres within the concrete mix. In addition, the existing empirical design equations do not currently allow for design situations in which the eccentric load application is required to fall beyond the ‘kern point’ of the section. That is, the largest off-set at which a load can be applied to a section without it developing tensile stresses. One such load case is however, investigated as part of this study in order to assess the ability of, and therefore the potential for using the proposed hybrid reinforcement configurations to resist a larger, non-standard value of load eccentricity.

One potential alternative design method however, currently available within each of the regulatory guides considered [7-8], is the consideration of the wall component as a column of an ‘equivalent’ structural width. This method, *prima facie*, appears to potentially offer a suitable design method, for the hybrid panels under consideration. This is because, it would enable the engineer to account for the necessary modification to the concrete material model, as well as being able to include for the longitudinal reinforcement quantity and its distribution. By using this method, one could also allow for a load applied at the larger eccentricity. However, the use of this method requires the buckling failure load of the panel element to be dependent upon, and thus determined through consideration of, the flexural

capacity of the component's cross section [3]. As defined within section 1, this is not true for the minimally and centrally reinforced panels that are the focus of this study. Therefore, neither of the existing design procedures currently available, appear suitable for the design of panels reinforced through a combination of minimum, centrally placed and unconfined longitudinal re-bar, with secondary reinforcement also provided by using a quantity of SFR.

## **2.1 Strut and Tie Design for D-Regions**

The strut-and-tie analytical model is an extension of the Ritter-Mörsch truss analogy, with particular application to the shear design of discontinuity regions (D-Regions) in cracked reinforced elements [10]. The model assumes that structural loads are carried through a set of compressive stress fields and interconnected tensile ties. Previous studies ([11],[12]) have demonstrated that the use of steel fibre reinforcement, in conjunction with traditional longitudinal reinforcement, significantly improves the capacity of the D-regions considered within the precast structural elements. However, the past investigations do not consider the validity of adopting an STM in their design. Hence, of particular interest as part of this study is; how a traditional STM analytical model should be modified or augmented to suitably account for the behaviour and failures observed, when adopting the hybrid reinforcement proposed, within the critical structural regions?

Another important consideration in adopting the STM methodology, as part of the development of an acceptable design for the proposed precast lintel elements, is that due to the lower-bound nature of the method, a number of potential (or compliant) models are possible. However, a poorly selected and detailed strut-and-tie model may potentially result in severe damage and cracking to the element, even under service loading [13]. Because of this, the experimental investigation and validation of any potential STM analytical model is therefore considered as an essential component in the development of a design procedure for the precast dapped end beams.

### 3 EXPERIMENTAL INVESTIGATION

#### 3.1 Test Samples and Experimental Arrangements

Eight 450mm wide, 100mm thick and 3000mm tall panel elements were cast adopting C40/50 grade concrete mix (500kg/m<sup>3</sup> CEMI, 840kg/m<sup>3</sup> Gravel<20mm, 900kg/m<sup>3</sup> Sand<4mm, 0.8% Super-plasticizer, w/c=0.36, Flow=650-700mm). Four of the samples were reinforced solely using a single, centrally placed layer of mesh reinforcement to form the unconfined reinforcement configuration illustrated in Figure 1(d). The four additional panels tested adopted an identical reinforcement configuration to that illustrated although, in these cases, an additional steel fibre content (1% by volume) was also incorporated within the specified mix design. In this way, the potential for any improved performance through the use of such a hybrid reinforcing strategy will be quantified, relative to the conventionally reinforced panels. The double hooked end type fibres used were: 50mm long, 0.75mm in diameter, had an aspect ratio of 67mm and a tensile strength greater than 1100N/mm<sup>2</sup>.

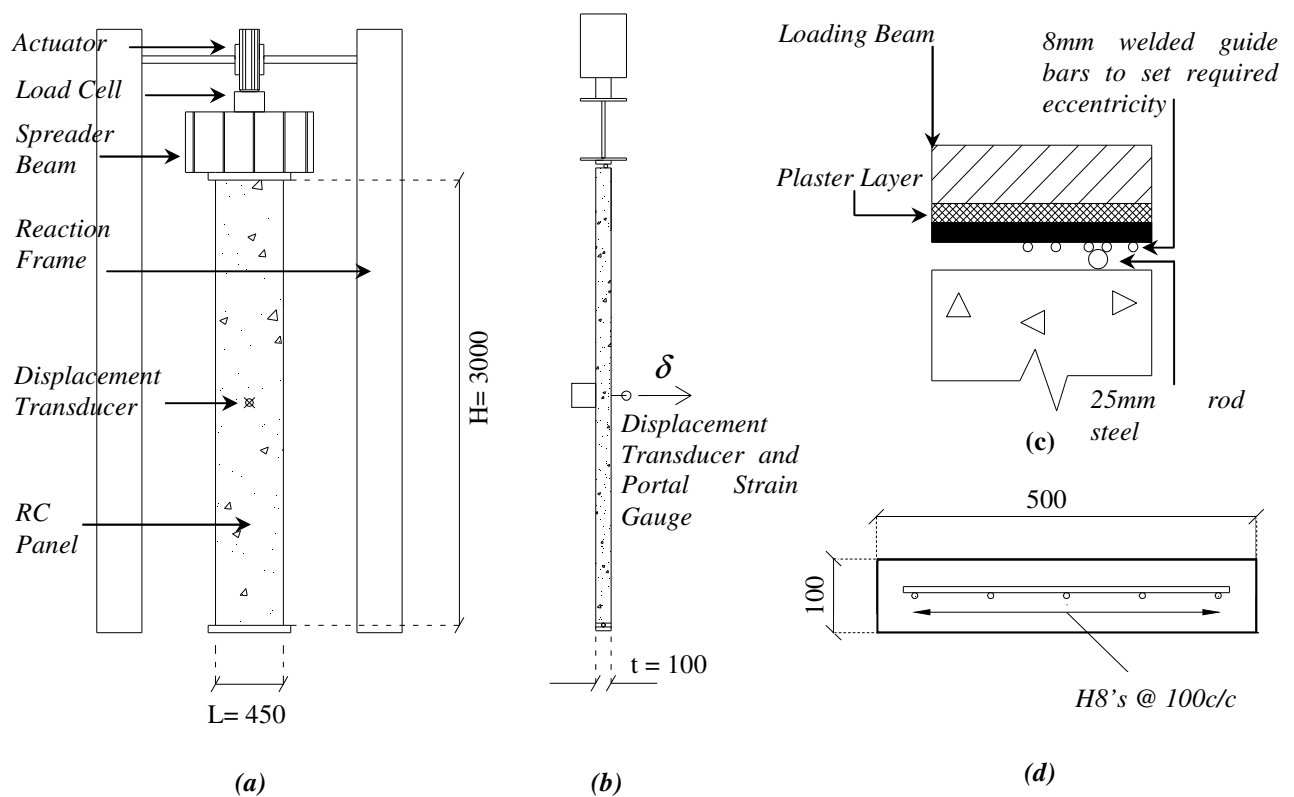

Figure 1: Experimental arrangement (a); Test Rig Elevation (b); Test Rig Section (c); Pin Joint Loading (d); Reinforcement Cross Section



The eight panel elements were then axially tested, using the experimental setup illustrated within Figures 1(a) and (b). The testing rig used for the experiments was capable of applying a load of 4000kN, with the loading beam designed in order to ensure the transmission of a uniformly distributed load across the top of each panel at eccentricities of 17mm ( $t/6$ ) and 33mm ( $t/3$ ). The smaller of the adopted eccentricities was chosen to reflect the maximum load off-set allowed for within the major international design regulations ( $t/6$ ) investigated [7-8]. This limit on load eccentricity is commonly referred to as the 'kern point' and has been widely adopted as part of a number of experimental studies into the axial capacity of one-way spanning panel elements [2-5]. Additionally, a load case involving a larger eccentricity ( $t/3$ ) has also been incorporated as part of this study, in order to investigate whether the use of SFRC in conjunction with un-confined longitudinal reinforcing steel could potentially offer an engineer the opportunity to justify the use of such panel elements for resisting such a demanding loading condition

The top and bottom hinged support conditions were each simulated by placing a 25mm high strength steel rod on a 50mm thick bearing plate (Figure 1(c)). Displacement transducers were utilised at the locations illustrated within Figure 1(b) in order to record out-of-plane displacements at the centre and top of the panel, as well as providing a means of determining the rotation at the top of the wall. Strain readings were also taken utilising a digital portal gauge at the known critical section (i.e. the mid-span of the RC wall element). This allowed the strains induced at this section to be recorded as the axial load was incrementally increased. As part of the secondary focus of the experimental study, four precast lintel elements were additionally cast and tested to failure. The geometry of the specimens tested and the weld mesh reinforcement layout adopted are illustrated within Figure 2. Because the objective of the experimental program is to study the behaviour of the D-Region of the precast lintel component, a member length of 1415mm was adopted so as to ensure that the region controlling the element's capacity was that under investigation. All reinforcing bars used in the manufacture of the samples were 16mm in diameter, with a cover of 25mm maintained throughout. The bars were MIG welded, with all anchorage forces and requirements appropriate to the resulting welds calculated in line with the relevant EC2 provisions [8].

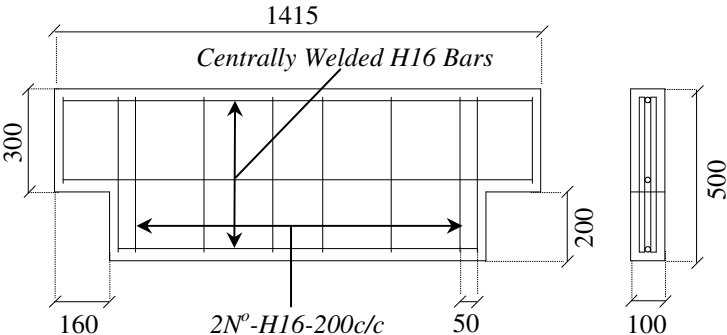

Figure 2: Welded Mesh Reinforcement Configuration

The testing of the beam samples in shear was undertaken using the experimental setup detailed within Figure 3, with a loading rate of 1 kN/s adopted. Bearing plates with sizes of 100x100x12.5mm were used at both the support and loading positions in order to suitably spread the applied load and thus ensure the appropriate strut propagation within the sample. Digital strain gauges were used to collect data in regards to the strains at the surface of the sample continuously during testing. The positioning of the gauges was designed so as to collect results both for the tensile region at the re-entrant corner and over the primary compression strut that will form the dap. The rosette pattern adopted allowed the angle of principal stress in the half-joint detail to be calculated and recorded throughout the loading of the specimen. Consequentially this will allow the collected data, through the application of Mohr’s circle, to be used to validate the geometry of the adopted Strut-and-Tie model (STM). The digital strain gauges used were 60mm in length, with Figure 3 identifying the end locations of this instrumentation.

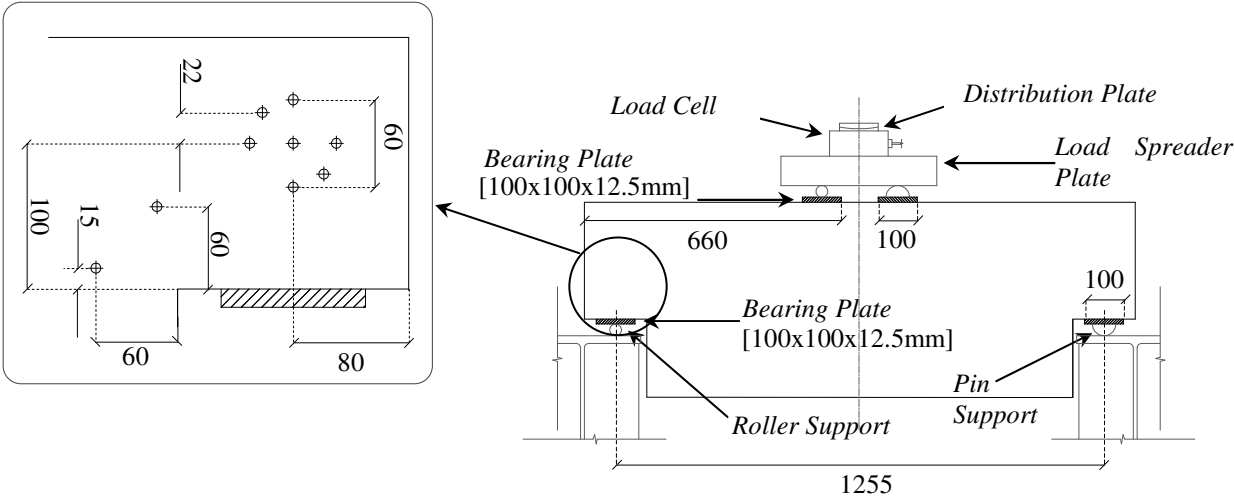

Figure 3: Lintel Testing Schematic and Demec Rosette Detail (box)

### 3.2 Experimental Findings

Table 1 summarises the experimental failure loads observed for each of the panel elements tested. In addition Figure 4(d) details the measured relationship between the applied load and the deflection of the panel at its critical section, up until buckling failure occurred. It should be noted that the loads have been normalised (in order to allow an effective comparison of panel performance), according to the expression:

$$N_c = \frac{N}{f_c L t} \quad (1)$$

Where  $N$  is the axial load applied to the panel at the set eccentricity ( $kN$ ),  $f_c$  is the average measured concrete cylinder strength for the samples ( $N/mm^2$ ), with  $L$  and  $t$  the width and thickness of the concrete wall elements respectively ( $mm$ ).

As can be seen, the inclusion of the 1% volume fraction of steel fibre reinforcement in addition to the unconfined reinforcement mesh traditionally adopted, leads to an increase in both axial load and deformation capacity of the panel. Both effects appear to be more significant within the panels, to which the load was applied at an increased eccentricity. An average increase of 12% in normalised buckling capacity was seen for panels loaded at an eccentricity of  $33mm(t/3)$ , with the lateral deflection prior to failure increasing from a minimum of 10.5mm in the traditionally reinforced panel to a maximum of 20.55mm for a panel adopting the hybrid reinforcement option considered. This increased lateral deflection could also be clearly observed for the SFRC panel elements, with a distinct bowing evident prior to the failure of the wall (Figure 4(c)). For panels loaded at an eccentricity of  $17mm(t/6)$ , a lesser average increase in normalised buckling capacity was recorded (9.8%). Lateral deflections of 17.51mm and 19.61mm were measured for panels SFR1 and SFR2 respectively compared to the minimum value of 11.02mm observed for Panel RC1.

The most significant difference in the behaviour of the two panel types investigated however, was perhaps associated with the buckling failure typologies observed for the hybrid and traditionally reinforced elements. In the instances where a centrally placed, unconfined reinforcement layout was solely adopted the observed failure was of a sudden, brittle and explosive nature Figure 4(a). In contrast for the cases when a 1% volume fraction of the

double hooked end steel fibres was incorporated, a much more acceptable (from a structural design perspective) ductile failure resulted.

Similarly, Table 2 details the failure capacities recorded for each of the six dapped-end lintel samples fabricated. For the control samples (RCL1 and RCL2) first cracking was seen to occur at the re-entrant corner, quickly followed by flexural cracking at the mid-span. As the loading was increased however, the mid-span flexural cracking was seen to propagate at a rate greater than that which was observed at the re-entrant corners. It was then observed that both the samples exhibited a significant propagation of tensile cracking along the diagonal compressive strut. This cracking next propagated upwards towards and subsequently along the beam's top face. The progression of this cracking was then observed to cause the brittle shear failure captured within Figure 5(a), with the concrete material forming the dap of the lintel, spalling away post failure to expose the welded mesh reinforcement. Interestingly, it was also observed that plastic hinges had formed within the longitudinal steel of the mesh, adjacent to the welded vertical bars. This perhaps indicates the potential failure mechanism for the sample.

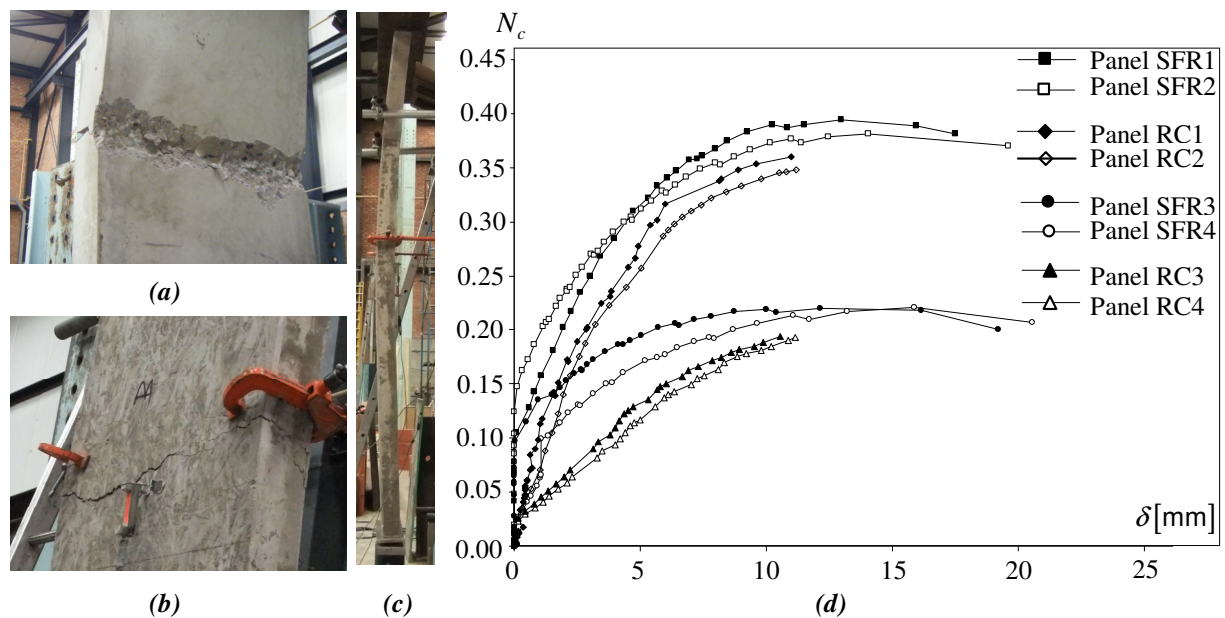

Figure 4: Eccentrically loaded panels (a); Brittle failure of traditional RC panels (b); SFRC panel section failure (c); Increased lateral deflection of SFRC panel prior to failure (d); Experimental load-deflection curves for panels with varying eccentric load and use of SFR

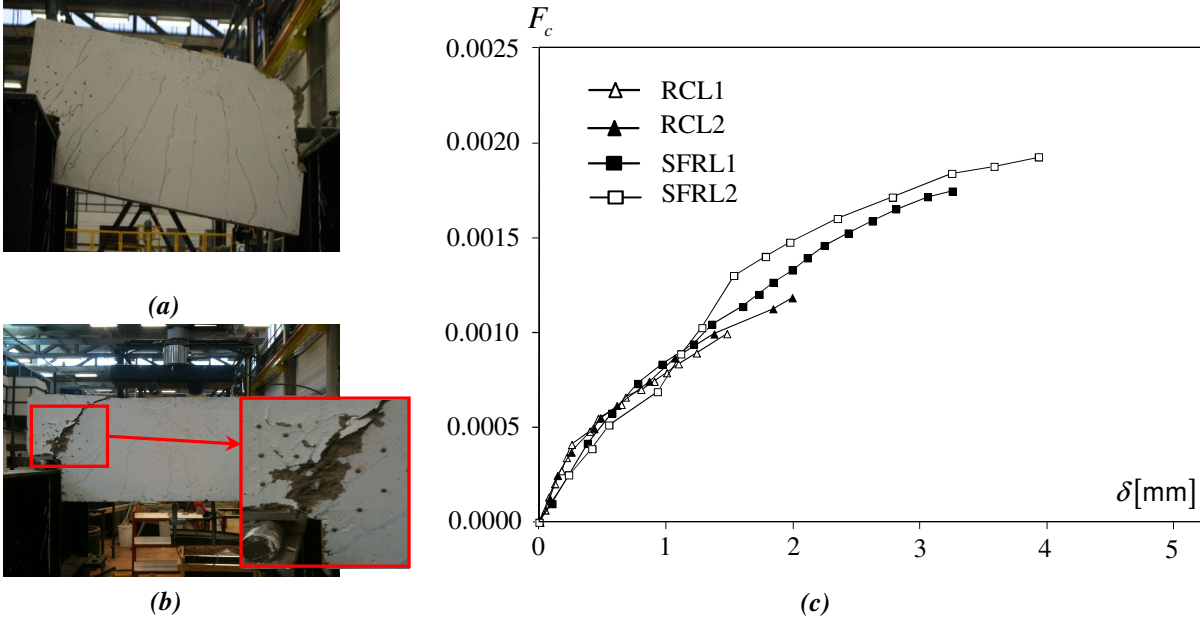

Figure 5: Brittle failure of traditional RC lintel (a); SFRC Lintel Failure (b); Experimental load-deflection curves for traditional and hybrid lintel samples (c)

Similar cracking patterns and propagation sequences were also then observed for the samples cast using a combination of a welded mesh and an additional content of steel fibre reinforcement (samples SFRL1-2). The first crack again occurred at the sample’s re-entrant corner and this was again followed by more extensive flexural cracking at the mid-span. However, a noticeably slower and less extensive crack propagation was observed for all samples adopting a percentage content of steel fibres relative those using the more traditional mix. This provides evidence therefore that the content of steel fibres within the mix were acting as expected to provide a means of crack control. In addition to slowing crack formation the fibres also significantly reduced the level of the resulting spalling observed at failure (Figure 5(b)). Also worthy of note was that the extent of flexural cracking away from the daps appeared to significantly multiply as the fibre content in the samples was increased.

Table 1: Panel buckling capacities capacities

Element Ref	$f_c (N/mm^2)$	$e(mm)$	$N_u (kN)$	
			Test	Comp
RCW1	37.28	17	597	531
RCW2	37.28	17	572	531
RCW3	38.48	33	336	302
RCW4	38.48	33	322	302
SFRW1	40.21	17	713	623
SFRW2	40.21	17	689	623
SFRW3	41.11	33	407	345
SFRW4	41.11	33	394	345

Table 2: Lintel shear

Element Ref	$f_c (N/mm^2)$	$N_u (kN)$	
		Test	STM
RCL1	61.28	190	194
RCL2	32.96	100	124
SFRL1	42.16	175	158
SFRL2	32.96	140	124

Figure 5(c) illustrates the load deflection behaviour recorded for each of the beam elements tested. Normalisation of loading values was undertaken in order to enable a comparison between each of the samples in relation to how efficiently the steel weight incorporated is being used within each of the designs considered, as well as to allow for the variations in concrete strength seen for the samples cast. The values were corrected according to the expression:

$$F_c = \frac{F}{f_c \times L_1^2} \quad (2)$$

where  $L_1$  is the span of the test lintel (Figure 3).

As would be expected, the plots of load displacement relationship for the beam elements tested (Figure 5(c)) show that all samples had a similar elastic range. However, both samples incorporating the 1% volume of steel fibre content exhibited a much greater ductility, with the maximum deflection at the point of failure almost double that of the non-fibre samples. Such a response is indicative of the successful application of steel fibre reinforcement causing a more plastic/ductile response under loading and controlling the cracking, which would have otherwise resulted in failure. An average increase of 32.1% in normalised shear capacity was also measured for the SFRC halving joints.

## 4 PROPOSED DESIGN METHODS FOR PRECAST ELEMENTS ADOPTING HYBRID STEEL FIBRE AND UNCONFINED REINFORCEMENT CONFIGURATIONS

### 4.1 Lumped Plasticity

Lumped plasticity idealisation is a widely adopted computational model, particularly utilised in earthquake engineering and robustness assessment, in order to determine the ultimate performance of a structural system by increasing step by step the load multiplier until failure (push-over or push-down analysis). It has been demonstrated within previous studies [1] [3] that it is possible to consider, as part of a computational assessment, the entire inelasticity of an RC panel element to be concentrated at the critical section for the span, with this ‘lumped plasticity’ modelled through the use of a non-linear hinge (Figure 6(a)).

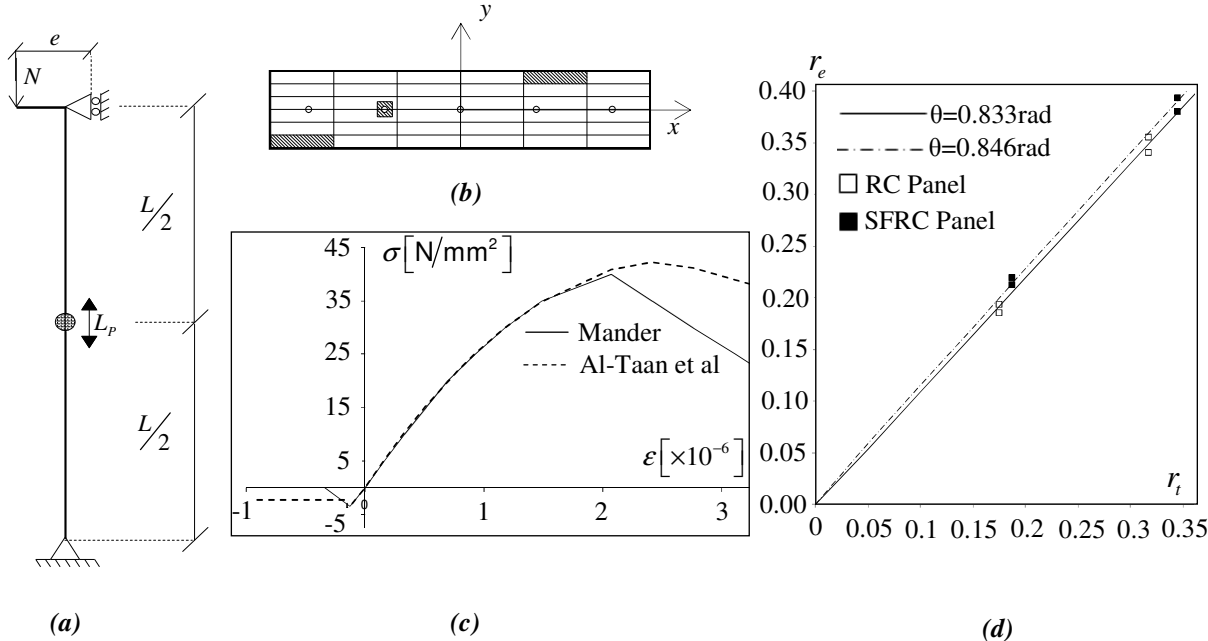

Figure 6: Lumped plasticity computational panel representation (a); Fibre hinge at critical panel section (b); Unconfined [14] and SFRC [15] material models (c); Comparison of theoretical and experimental panel capacities (d)

Such a computational model is effective for the cases considered as part of this study, because the location of the maximum moment (and thus the critical section) is known for the simply supported elements. In this representation the component’s cross section is subdivided into a number of elements or fibres, to which the appropriate material properties are then assigned

(Figure 6(b)). In this way, the non-linear moment-curvature relationships and limits of the fibre hinge can then be determined for a range of axial loads (assuming plane cross sections). As such, the arrangement illustrated can therefore be used in order to provide an effective representation of system non-linearity, and consequentially, of buckling capacity.

Importantly, because the proposed computational method allows the designer to modify for the relevant concrete material model, it can therefore facilitate the incorporation within the analysis of other concrete types, such as the fibre reinforced mix adopted as part of this study. Therefore the Mander [14] model adopted for the unconfined concrete material within the traditional RC panels was replaced by the material model suggested by Al-Ta'an and Ezzadeen [15] (Figure 6(c)) for fibre reinforced concretes adopting a 1% fibre volume fraction. Additionally however, in order to correctly quantify the rotational capacity of a concrete member, the length of the resulting plastic hinge ( $L_p$ ) that will be formed during loading and subsequent failure must also be accounted for. Accordingly, the hinge lengths were computed for both panel types from the expression proposed by Panagiotakos and Fardis [16] for unconfined RC panels and column elements subjected to monotonic loading:

$$L_p = 0.18L_s + 0.021d_b f_y \quad (3)$$

where  $L_s = H/2$  is the shear span of the member,  $d_b = t/2$  (for the panels considered as part of this study) is the effective depth of the reinforcement and  $f_y$  is the yield strength of that reinforcement. As can be seen from Table 2, the resulting computational predictions for both the traditionally reinforced panels and those adopting the hybrid reinforcing strategy show a good correlation with the actual experimental capacities seen. This relationship is also illustrated within Figure 6(d) which shows the least-squares best fit to slope  $\theta_1 = 0.833$  and  $\theta_2 = 0.846$ , for the RC and SFRC hybrid panel types respectively, to be acceptably close to the  $\theta = \pi/4$  ideal. The poorer correlation seen within the panels where the secondary fibre reinforcement was incorporated is likely due to the fact that a degree of calibration in relation to the length of fibre hinge is required. However, a greater number of data points would be required in order to inform how Eq 3 should be modified to account for the use of SFRC.



#### 4.1 Design Using Strut and Tie

To aid in the development of the proposed analytical strut-and-tie model for the beam elements considered, an elastic analysis was first undertaken in order to analyse the stress flows occurring, a method strongly advocated within existing literature [10]. A 2D finite element (FE) analysis was carried out, using shell elements due to the size of the section (100mm) in relation to the size of the shells considered. These stress flows were then used in the development of a relevant STM. Additionally the outputs of the FE model were used to verify the angle of the stresses against those obtained by experimental measurement, with the angle used for the analytical STM ( $59^\circ$ ) found to lie between the maximum measured angle of principal stress ( $52^\circ$ ) and that predicted through linear computational analysis ( $66^\circ$ ). The lower bound model developed is illustrated within Figure 7 (a) and compares well to those proposed within literature [9] for concrete elements with a similar geometry and reinforcement provision. The precedent cited however, considered the response of confined concrete without a steel fibre content.

A key assumption made when arriving at the most appropriate analytical STM, was regarding the width of the critical compressive strut formed. Although the bearing plate was sized to spread loads across the full width of the beam it was assumed that the effective width was that confined by the welded mesh configuration (Figure 2). Therefore the width of concrete considered was that within the centreline of the reinforcement bars, as this was felt to best represent the ‘pinching’ or confining point. The design model was then used to calculate the capacity of the section, with the theoretical predictions summarised as part of Table 2. Because the experimental work conducted identified that crushing of the primary compressive strut, positioned at the support bearing plate, resulted in element failure it could therefore be considered to be critical. It follows then that the size of this strut and thus the capacity of the section is then dictated by both the angle of the strut formed and the width of the bearing plate used. The remaining struts were still subsequently assessed for adequacy however, along with checks also required to ensure the tensile capacity of the reinforcement provided would not be exceeded within any of the associated ties.

Interestingly, and as can be seen from Table 2, the proposed STM overestimates the strength of the two samples adopting the welded mesh reinforcement without any additional steel fibre content by (2-24%). This is perhaps to be expected given the brittle nature of unconfined concrete and the sudden and explosive failure observed in the testing of the element. This finding perhaps indicates that unconfined concrete elements should not be designed using STM models without a further safety factor being applied to the current strut capacity equation given within EC2 [8]:

$$\sigma_{RD,max} = 0.6v'f_c \quad (4)$$

where  $\sigma_{RD,max}$  is the allowable axial stress within the compressive strut,  $f_c$  is the concrete cylinder strength and  $v' = 1 - (f_c/250)$  is a reduction factor applied for cracked compression zones within the Eurocodes. In contrast however, the STM model for samples where a 1% content of SFR, by volume was incorporated, tends to underestimate the capacity of the element by an average of 12%. This suggests that the use of standard STM design is valid for situations in which un-confined reinforcement configurations are adopted and perhaps even indicates that a beneficial factor of safety could be applied to the strut capacity expression (Eq 4) for such design cases. However, a much larger degree of testing would be required before any such conclusions or design recommendations could be provided. A potential need for such further investigation and the establishment of more appropriate correction factors is well illustrated by the comparison of actual lintel capacities to the ideal least squares correlation illustrated in Figure 7(b).

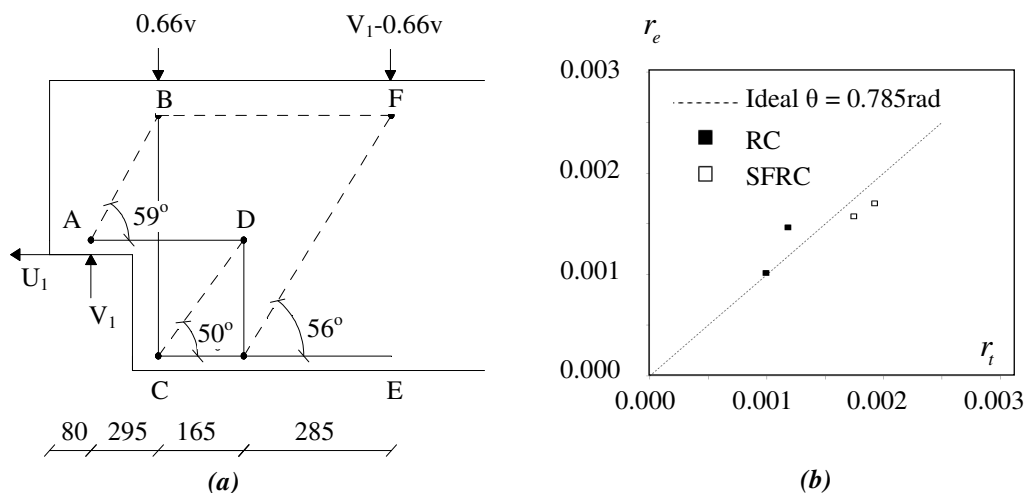

Figure 7: Proposed STM for the design of lintel members (a); Comparison of theoretical and experimental lintel capacities (b)

## 5 CONCLUSIONS AND RECOMMENDATIONS FOR FUTURE WORK

The paper demonstrates that the incorporation of Steel Fibre Reinforcement (SFR) has significant effects on the structural performance of both eccentrically loaded panels and shear discontinuity regions for precast elements adopting unconfined configurations for the traditional bar reinforcement. The paper also shows the effectiveness of design methods that could enable an engineer to justify the use of such hybrid reinforcing strategies in practice.

As far as the slender wall elements are concerned, the introduction of SFR was seen to increase both axial capacity and structural ductility for load eccentricities of  $e=t/6$  and  $e=t/3$ , with a more significant improvement in the latter case. Moreover, an improved (and more acceptable) failure mechanism was observed, when compared to the sudden, brittle failure seen in the control samples. Lumped plasticity idealisation and fibre-hinge elements were shown to provide a good correlation with the experimental data relating to the singly and centrally reinforced panels adopting both traditional and SFR concrete mix alternatives. However, the computational method was found to be less effective in presence of steel fibres as secondary reinforcement, suggesting that further testing is required in order to calibrate the length of the fibre hinge.

As far as the lintels with dapped ends are concerned, it has been similarly shown that the introduction of SFR leads to increased capacity and ductility. This is believed to be because the fibres act to control cracking at the re-entrant corner, inducing a greater degree of flexural action prior to failure. The investigations conducted have also developed and validated a suitable Strut-and-Tie Model (STM) for the design of halving joint details where an unconfined steel reinforcement layout is adopted, which however tends to overestimates the actual capacity. The findings also suggest that a modification (or safety) factor should be applied to the strut element to account for the brittle nature of the unconfined concrete without SFR. In contrast however, when a 1% volume of double-end hook SFR were introduced in the mix, the use of the STM design method could be justified, with the experimental values also indicating that a beneficial modification factor could be warranted. Also in this case, further testing would be required in order to adequately demonstrate and quantify what the value of such a beneficial factor should be.

---

**References**

- [1] G.P. Robinson, A. Palmeri and S.A. Austin, *Tension Softening Effects on the Buckling Behaviour of Slender Concrete Wall Panels*, Proc. of ISEC-6 Modern Methods and Advances in Structural Engineering and Construction, Zurich (2011)
- [2] J.H. Doh, S. Fragomeni, *Evaluation of Experimental Work on Concrete Walls in One-Way and Two-Way Action*, Aus. J. Struct. Eng, 6(1), 103-115 (2005)
- [3] G.P. Robinson, A. Palmeri, S.A. Austin *Design Methodologies for One Way Spanning Eccentrically Loaded Minimally or Centrally Reinforced Pre-Cast RC Panels*, J. of Engineering Structures, Currently Under Review (2011)
- [4] K.M. Kripanarayanan, *Interesting Aspects of the Empirical Wall Design Equation*, ACI Struct. J, 204-207 (1977)
- [5] S.U. Pillai, C.V. Parthasarathy, *Ultimate Strength and Design of Concrete Walls*, J. of Bld. and Env, Vol 12, 25-29 (1977)
- [6] H.H. Abrishami, D. Mitchell, *Influence of Steel Fibers on Tension Stiffening*, ACI Struct J, 769-776 (1997)
- [7] American Concrete Institute, *ACI 318-05 Building Code Requirements for Structural Concrete*, Farmington Hills (2005)
- [8] Comité Européen de Normalisation, *EN 1992-1-1 Eurocode 2 Design of Concrete Structures Part 1-1 General Rules for Building*, Brussels (2004)
- [9] J.K. Wight, J.G. MacGregor, *Reinforced Concrete Mechanics and Design, 5<sup>th</sup> Edition*, Pearson Education International, San Jose (2009)
- [10] J. Schlaich, K. Schafer, M. Jennewith, *Towards a Consistent Design of Structural Concrete*, PCI Journal, 32(2), 74-150 (1987)
- [11] D.R. Sahoo, S.H. Chao, *Use of Steel Fiber Reinforced Concrete for Enhanced Performance of Deep Beams with Large Openings*, Proc. of ASCE 2010 Structures Congress, 1981-1989, Orlando (2010)
- [12] Z. Fu, *Use of Fibres and Headed Bars in Dapped End Beams*, Masters Thesis, M<sup>c</sup>Gill University, Montreal (2004)
- [13] D. Kuchma, S. Yindeesuk, T. Nagle, J. Hart *Experimental Validation of Strut-and-Tie Method for Complex Regions*, ACI Structural J., 105(5), 578-589 (2008)

- [14] J.B.Mander, M.J.N Prestly, Park R *Theoretical Stress-Strain Model of Confined Concrete*, J. of Structural Engineering, 114(8), 1804-1826 (1988)
- [15] S.A. Al-Ta'an, N.A. Ezzadeen *Flexural Analysis of Reinforced Fibrous Concrete Members Using the Finite Element Method*, J. of Computers and Structures, 56(6), 1065-1072 (1995)
- [16] T.B.Panagiotakos, M.N. Fardis, *Deformations of Reinforced Concrete Members at Yielding and Ultimate*, ACI Struct. J., 98(2), 135-148 (2001)

## 6.4 PAPER C2

Full Reference –

Robinson, G.P., Palmeri, A., Austin, S.A., 2013. **Appropriateness of Current Regulatory Requirements for Ensuring the Robustness of Precast Concrete Building Typologies.** In: *Proceedings of 5<sup>th</sup> ICE International Conference on Forensic Engineering*, 16-17 April, London, UK

Abstract –

The phenomenon of progressive collapse can be likened to the failure of a house of cards where structural damage propagates beyond the locality of the initial damage and to an extent disproportional to the original cause. Insufficient consideration of the structure's potential for progressive collapse has widely been seen as responsible for some of the most high profile structural collapses of the last 60 years. The need to rigorously consider and mitigate for the risk of such collapse occurring is often seen to be more imperative within the design and detailing of pre-cast concrete structures, which is mainly due to their segmental nature of and associated inherent lack of structural continuity. Aimed at highlighting the need for a more quantitative design methodology, the paper evaluates the suitability of commonly advocated measures for ensuring structural robustness in pre-cast building typologies.

Using a non-linear 'push-down' simulation the suitability of existing tying and anchorage force provisions are evaluated, with such prescriptive detailing rules often adopted by design engineers to justify a suitable level of structural robustness. This computational assessment enabled a quantitative assessment of the performance of pre-cast framed buildings subjected to a sudden column loss event. The findings highlight a need for current design and detailing practice to take more appropriate account of the nonlinear response of components and joints incorporated within multi-storey buildings.

Keywords – Robustness, Disproportionate Collapse, Push-Down, Tying, Effective Anchorage

Paper type – Article

## 1 INTRODUCTION

Progressive collapse refers to the phenomenon where localised damage brings about wider and even total structural collapse. The failure of the Ronan Point flats in London (1968), the collapse of the

Alfred P Murrah Building in Oklahoma (1995) and the destruction of the World Trade Centre towers

(2001) are perhaps the seminal incidents that highlighted the potential vulnerability of structures to such events. In response, the major international design codes incorporated a number of regulations designed to assure that adequate attention is provided within the design, detailing and construction of buildings so that the resulting structures can be considered to have an adequate 'robustness' or insensitivity to local failure events (Starrosek, 2008). However, despite the existence and application of such rules, a number of studies and publications (Beeby, 1999) have suggested that although practising engineers inherently understand the need to prevent against disproportionate collapse they still lack: the analytical tools, assessment methodologies, appropriate metrics and explicit design guidance that would enable them to ensure the risk of disproportionate collapse is adequately considered and suitably mitigated. Starrosek (2007) actually suggests that the lack of a widely accepted quantitative method for assessing a structure's ability to resist collapse following an event means that the scope for efficient and repeatable structural design, optimisation and effective review is currently limited.

One such potential method is through the use of a non-linear 'push-down' computational assessment procedure. This method is directly analogous to 'push-over' analysis, which is often used as part of contemporary seismic design to determine the ultimate performance of a structural system. This is achieved by increasing the load multiplier in step increments until the plastic failure of the assembly can be identified and has previously been successfully adapted for use within the robustness assessment of both steel and RC building typologies (Kim 2009, Lee 2011). However, no such similar analysis appears to have been conducted for common precast building types. This is despite the fact that such buildings are often intuitively considered to be less robust than similar, alternative steel or insitu reinforced

concrete structures. Such analysis is perhaps then more imperative for buildings constructed in this way, because of the need to demonstrate that the individual structural components used will be effectively and robustly 'stitched' together.

This paper conducts a series of non-linear push down assessments to better understand the response of typical precast framed structures to a column loss event, quantifying their performance relative to existing robustness requirements. Such analysis will also allow for an assessment of the widely adopted prescriptive 'tying' and 'anchorage' rules, currently deemed sufficient for the avoidance of disproportionate collapse within many of the major international codes. Such assessment is necessary following concerns (Izzuddin 2008) that such rules and details are (in reality) unrelated to the actual actions imposed and structural performance necessary following such a damage event. Specifically, the existing provisions currently exclude any consideration of the necessary ductility demands place on the connections and structural members (Izzuddin 2008).

## **2 LIMITATIONS OF CURRENT DESIGN METHODS**

The UK, US and European (ODPM 2004, ACI 2008, CEN 2006) design regulations all contain specific provisions addressing the need to design against disproportionate collapse. All adopt similar procedures in which the buildings are classified based upon their intended use, size and the level of risk that any potential structural collapse may present to the public. This process of building classification defines the appropriate level of structural robustness that must be achieved following the design, detailing and construction processes. However, the subsequent and necessary definition of the required structural performance always appears to be: highly qualitative, aspirational and subjective in nature for each of the regulatory guidance documents.

Starrosek (2007) highlighted this fact, also suggesting that the lack of a more quantitative performance requirement limits the engineer's ability to assess, evaluate or optimise one design method or structural solution against another. Consequentially an engineer is not currently able to quantifiably demonstrate that his/her building will adequately perform in a manner deemed appropriate to its risk classification. For example the designer cannot



currently assess how much closer or further away from an acceptable robustness the design will become by adopting one structural form, transfer structure or connection detail over another.

Such limitations within the existing design codes effectively force the design engineer to instead achieve regulatory approval by demonstrating that their adopted design and detailing philosophy is in line with one of the 'approved' design strategies available. Through employing such design methods, the resulting building is adjudged (by the pertinent design codes (ODPM, ACI, CEN)) to be sufficiently robust without any need to: assess, measure or justify the resulting structural performance of the construction. This paper however, aims to assess the suitability of two of these strategies, each of which is discussed below.

### **2.1 Prescriptive Tying**

Perhaps the most commonly adopted of the available methods is where the engineer ensures that the structural elements and any resulting joints detailed are in line with the prescriptive 'tying force' provisions provided by the codes. The philosophy is based on the assumption that through the use of such details, the designer will consequentially improve the indeterminacy of the structure, localising any damage that may occur, by taking advantage of the alternative load paths established. This is accepted however, without a subsequent need to demonstrate or justify these mechanisms by explicit calculation or computational assessment. Recent studies (Izzudin 2008) have questioned this approach, querying whether the tying provisions defined suitably allow for the true structural actions and effect that such elements and joints will be required to resist following a partial building collapse.

Given the period during which they were developed (following the Ronan point collapse in 1968) and the simplicity of the resulting equations, it is unlikely the expressions developed were intended to account for the complex dynamic and non-linear effects induced in reality. The lack of any compulsory regulation requiring the engineer to demonstrate that the adopted construction details are suitably ductile to allow for the resulting large deformations induced, is perhaps the starkest indication that these design expressions do not rigorously consider the true performance requirements for buildings exposed to accidental load conditions.

Alexander (2004) also introduced that for certain structural typologies the philosophy of ensuring structural redundancy via the provision of adequate joint continuity may actually contribute to a progressive collapse event. This work argues that in the event of the loss of structural stability, excessive tying may actually have the effect of 'dragging' out or down elements above or below the region in which the member has been removed or destroyed, questioning the blanket insistence on the use of continuous vertical ties. This 'pull down' phenomenon was actually observed on an experimental concrete panel high rise block constructed and tested by the Building Research Establishment (HMSO 1968). However, no further detailed experimentation, modelling or quantification of this effect appears to have been subsequently conducted. As such, there is little understanding of which building types, layouts or details might be most susceptible to its realisation.

This paper asserts that the suitability of stipulating tying provisions without having first demonstrated that such detailing rules provide a suitable performance in relation to the likely structural actions and ductility demands for which they are included should be questioned. An assessment to check that the final building is not susceptible to any secondary 'pull-down' effects is also prudent, with the paper therefore aiming to demonstrate the suitability, or otherwise, of common 'fully tied' precast concrete framed structures in meeting these additional design requirements.

## **2.2 Effective Anchorage**

A further, code compliant (ODPM, CEN), robustness design strategy is that of demonstrating that 'effective anchorage' exists at the structural connections between elements, with such a design approach restricted to buildings classified as being of a lower risk of disproportionate collapse (i.e. 2A, 2Lower etc). This provision is again prescriptive in nature, with similar concerns to those expressed in relation to the existing tying requirements again applicable. That is the suitability of the current guidance in relation to calculating and stipulating acceptable loads that the effective anchorage details must resist. For example, the overly simplistic requirement for the connections to resist a (presumably factored) force equivalent to the dead weight of the member it supports (BSI 2010) is again unlikely to correctly allow for the true structural action, ductility requirements and dynamic effects that will be

experienced during a collapse or damage event. In a manner similar to that which currently exists for the contemporary tying expressions, little information is at this time provided into how such guidelines have been derived and more significantly in regards to their validity.

Additionally, engineers often fail to appreciate that the use of effective anchorage and prescriptive tying rules represent two distinct design approaches to ensuring a building's robustness. A prominent example of such a misunderstanding appears to be present within the latest European national guidance document for precast structures (BSI 2010). The specific clause requires all precast floor, roof and stair members to be 'effectively anchored' regardless of the building's robustness class, stating that such anchorages must be designed so that they are capable of transmitting the *"dead weight of the member to that part of the structure that contains ties"*. Such a requirement however, is incongruous and contradictory to the currently accepted approach to robustness design. For example an engineer is entitled to design a lower class structure without the inclusion of vertical ties, with the engineers also possibly having adopted one of the two alternative design strategies available to them (see Research Methodology). If either of these philosophies is instead adopted, it would then be possible that no part of the structure would have to contain vertical ties. How then could the necessary anchorage regulation be met?

### **3 RESEARCH METHODOLOGY**

The major international design codes allow the adequate robustness of buildings to be demonstrated through the use of any one of four potential design approaches. These include meeting the prescriptive 'tying force' or alternative 'anchorage' provisions discussed, with the anchorage provisions only relevant to the UK and European regulations for class 2A and 2Lower buildings respectively. Alternatively the engineer may also achieve compliance by ensuring that either the 'Notional Member Removal' or 'Key Element' provisions have instead been met.

Most pertinent to this study are the assessment methods that can be adopted as part of a notional member design. This requires the engineer to demonstrate that following the loss of any vertical load bearing member, the remaining structural components will have sufficient

'capacity' to transfer any resulting actions, through the establishment of suitable alternative load paths. The provision however is currently commonly, with some suggesting unsuitably (Izzudin 2008), applied using conventional design checks. Adopting such a simplistic approach will again fail to account for the complex nonlinear geometric and material effects induced by the occurrence of partial structural collapse. Despite this current practice however, the notional column design provision is essentially performance based and as such has been found to allow for the more appropriate consideration of the progressive collapse phenomenon (Kim 2009, Lee 2011). This is because if the correct assessment methodology is used, the engineer becomes able to assess the actual capacity of the structural system. The term 'capacity' is taken to refer to the critical property preventing structural collapse and may therefore relate to element strength, deformability, ductility, stability or stiffness.

This study asserts that because no robustness performance metric is currently defined within the design regulations, and because a building designed using any of the available design approaches can be considered to be adequately robust, it must therefore also currently be the case that a building designed using one of the possible design strategies should be equally robust to a similar building designed using an alternative strategy. As such, it should be that a building designed using the prescriptive tie or anchorage rules will be able to sustain the actions imposed on it under an assessment conducted to meet the notional column removal provisions. This therefore presents an opportunity to assess the adequacy of current tying and effective anchorage rules for ensuring the insensitivity of typical precast concrete building to a progressive collapse. This will be done through the use of a non-linear push down computational study, with such assessments having historically been shown to be suitable for robustness assessment and design against disproportional collapse

(Kim 2009, Lee 2011). This analysis will also be capable of investigating both the suitability of the joint details and the building's susceptibility to any secondary effects that may compound the advancement of a progressive collapse. It will thus allow the key concerns associated with tied and anchored buildings to be addressed and evaluated in a quantifiable manner.

## **4 NONLINEAR PUSHDOWN ANALYSIS OF MODEL STRUCTURES**

Guidance does exist (GSA 2010) with regards to conducting this type of computational progressive collapse analysis and assessment. Such analysis should be performed by instantly removing vertical load bearing structural elements and then by assessing the structure's residual ability to accommodate such damage. However, software packages that are capable of carrying out such analysis, in order to correctly account for instantaneous changes in the stiffness matrix and building geometry are rarely commercially viable, and thus available to a practising design engineer. As such the GSA (2010) guidelines also allow for alternative (yet 'equivalent'): linear static non-linear static (pseudo-dynamic) and simplified dynamic assessment procedures to be adopted within the progressive collapse assessment of buildings. These analysis methodologies are then more easily carried out using more widely available software packages.

The non-linear static analysis method defined within the GSA regulations requires a stepwise increase in regards to the amplitude of applied vertical loads, until the maximum amplified loads are reached or a collapse is observed (Marjanishvili 2006), with the computational analysis essentially becoming a vertical derivative of a seismic 'push-over' analysis. This assessment technique is utilised as part of this study, as it is capable of allowing for the non-linear material and geometrical effects currently believed to be absent from the contemporary prescriptive design techniques. Although the 'push-down' method cannot capture the instantaneous dynamic effects associated with aspects such as column loss events or debris loading for example, studies (Izzuddin 2008, Marjanishvili 2006) have shown that the application of factored 'equivalent' static load cases are capable of accounting for such actions and effects.

Interestingly, the GSA guidelines (GSA 2003) allow for and define a load controlled, non-linear static analysis, in which the load is applied to the structure in at least ten incremental steps from zero up until the total specified loading. The resistance of the structure against such loading is assessed, with the output forces, moments, shears and deformations each then compared against the relevant acceptance criteria. However, it has been shown that such load

---

controlled push-down generally involves numerous analysis re-runs, is sensitive to the chosen load steps and tolerances and is also unable to converge to a solution when the 'load factor' begins fall, i.e. when building collapse is progressing (Marjanishvili 2006). The load factor refers to a measure of performance utilised as part of similar studies considering the non-linear push-down assessment of multi-storey buildings (Kim 2009, Lee 2011, Marjanishvili 2006). The metric essentially quantifies what proportion of the load case the plastically deformed or 'collapse-arrested' structure can transmit to the foundations through the alternative load paths it can establish and is defined as:

$$\text{Load Factor} = \frac{\text{Equivalent Applied Load}}{\text{Total 'Linear Static' Load}} \quad (27)$$

In this way a load factor  $> 1.0$  represents a building that would not collapse before the required design load conditions have been exceeded and as such can be considered to be suitably robust.

## **5 DESIGN AND ANALYSIS OF STRUCTURAL MODELS**

The adopted analysis models have been designed to represent a precast framed structure with a  $7.5 \times 7.5\text{m}$  structural grid and a floor to floor height of  $3.8\text{m}$ . Models consisting of two, four and ten storeys were analysed for a 'tied' frame design. Alternative models adopting effectively anchored connections were also considered for the two and four storey structures, with the elevations for the analysed structures illustrated within Figures 1 ((a)-(c)). The precast column and beam elements are designed in accordance with the EC2 design code (CEN, 2006) for  $C40/50$  and  $f_y = 500\text{N/mm}^2$  grade concrete and reinforcement respectively. The resulting beam and column sections are depicted as part of Figure 2 ((a)-(b)).

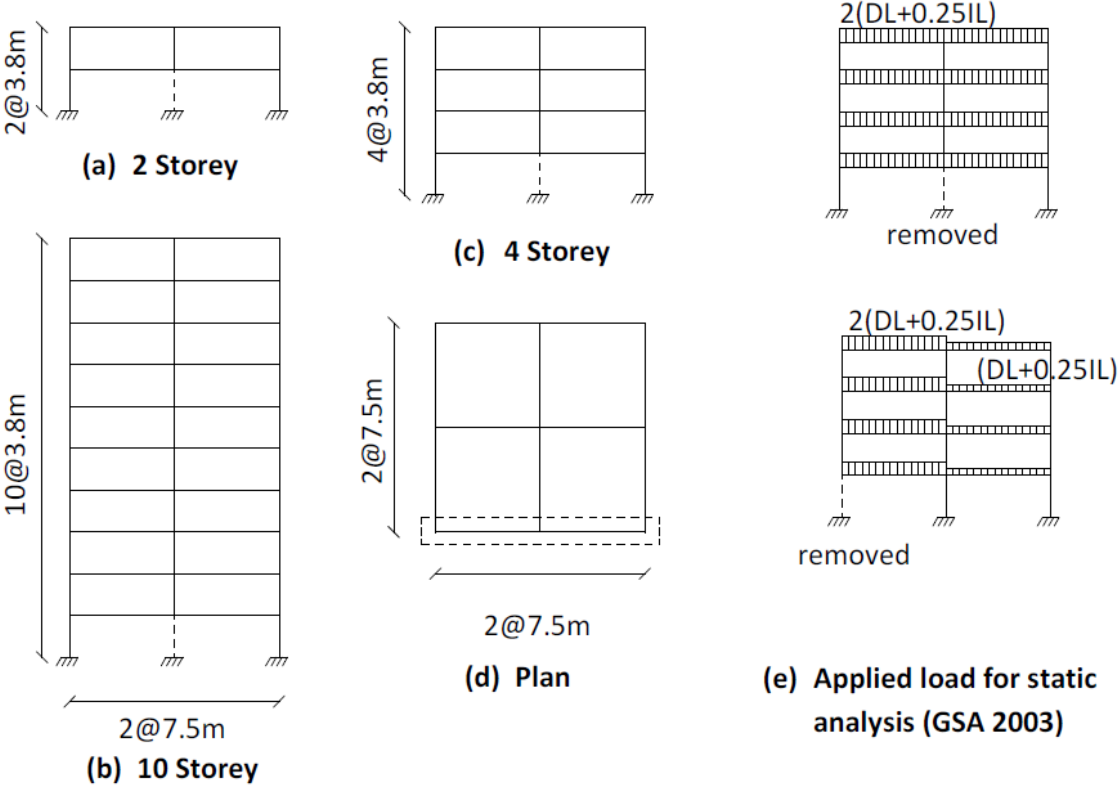

**Figure 1 Elevation, Plan View and Loading Conditions for the Analysis of Computational Structures**

A superimposed dead load of  $6\text{kN/m}^2$  and an imposed load of  $2.5\text{kN/m}^2$  were applied to each of the models analysed. In addition, a notional horizontal lateral load, equivalent to 1.5% of the characteristic weight of the structure, was also applied in order to represent the non-verticality of the precast column members. The lack of application of such a minimum level of horizontal load appears to be a significant limitation of similar previously undertaken studies (Kim 2009, Lee 2011). However, this load is important in correctly accounting for and identifying any potentially detrimental secondary geometrical effects that may occur.

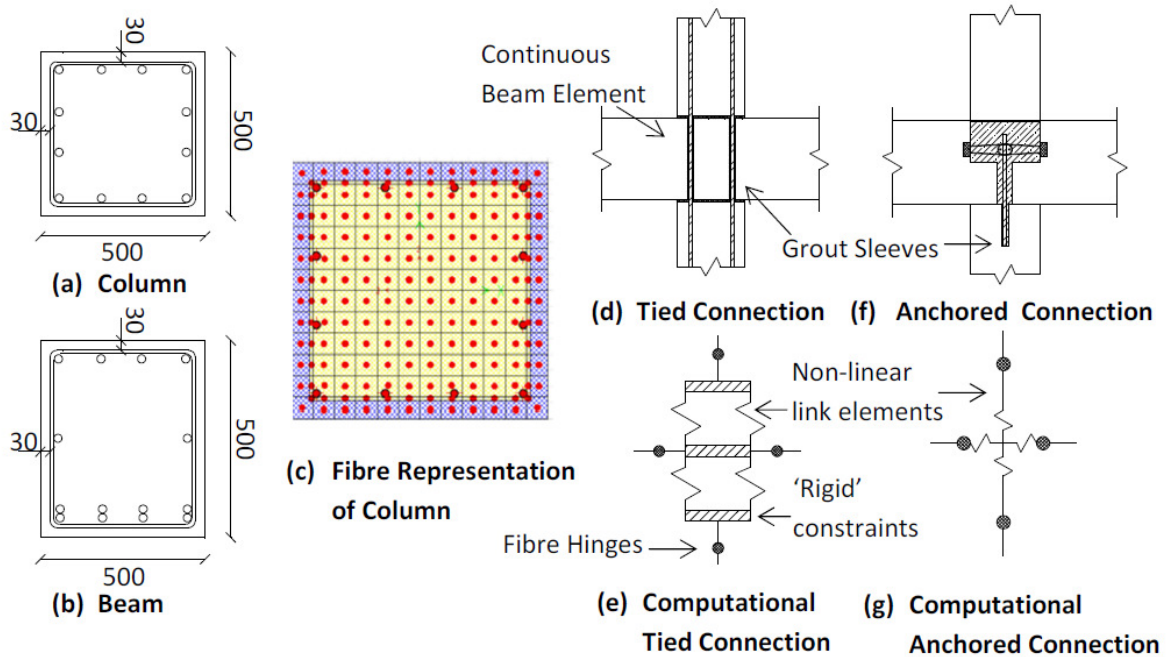

**Figure 2 Structural Sections, Connection Designs and Computational Equivalents**

Further, in order to account for the dynamic effects associated with a sudden column removal event, the recommendations given within the GSA (2010) guidelines require a dynamic amplification factor of 2 to be applied to the spans for which the column is removed. An un-amplified dead load is also applied to the remaining spans, with an imposed load reduction factor of 0.25 applied in both cases. The resulting load combinations are illustrated as part of Figure 1 (e). Because the chosen building types have a simple and repetitive layout, only two critical structural damage scenarios are considered necessary for investigation. These were the removal of central and corner column elements at the critical lower level of the structure (Figure 1 (e)).

Because of the identified limitations associated with the load-controlled push-down method currently prescribed within the GSA recommendations, the vertical push-down analysis was instead carried out through the adoption of a displacement controlled assessment. That is, the vertical displacement at the position (or node) where the column is removed was incrementally increased with the corresponding vertical load to this displacement then calculated. This allows the load factor to be similarly evaluated, although the analysis can be



more expediently run, as well as being significantly less likely to diverge, when compared to the load controlled alternative (Kim 2009).

Effective use of the proposed non-linear, static robustness assessment procedure is of course highly dependent on the adopted representation of the plastic properties of each component, as well as their connections, as part of the computational model (Inel 2006). That is, our understanding of the ultimate inelastic deformation capacities of the components detailed in terms of their geometric and mechanical characteristics should be captured as part of the assessment. The required non-linear load-deformation relationships have, in previous studies (Kim 2009, Lee 2011), been based on those values published within seismic design guidance, such as ASCE 41-06 (2007). However, these values do not account for the effect of significant variations in the axial forces applied to the components. Such forces and variation though, will be much more prominent and critical within a progressive collapse simulation than for the seismic assessments for which the values were derived. This is because such forces will significantly affect (in potentially both a beneficial and detrimental manner) the rotational behaviours and thus capacities of the elements and connections. Therefore, a much more effective method of capturing the structural behaviour of the RC elements was considered to be through the use of ‘fibre-hinge’ analytical elements. In this representation, the element’s cross-section is subdivided into a number of elementary layers or ‘fibres’ to which the appropriate material models can then be assigned (Figure 2 (c)). By dividing the structural cross section in this way it is possible to determine an effective representation of the non-linear moment-curvature relationship for the structural component in a manner that suitably accounts for the proportion of axial load applied. The non-linear load deformation characteristics derived in this way were then also validated against relevant experimentally derived values (Panagiotakis 2001). The associated structural behaviour was then incorporated within the computational models as ‘hinge’ elements that are specified at the locations where the applied lateral and gravity loads are considered to produce maximum effects. That is the plasticity of the structural components (modelled as a  $P-M_2-M_3$  hinge) is assumed to be lumped at the centre and ends of the beam and column elements.

The load deformation characteristics relating to the precast connection details were determined by consideration of the behaviour of the details illustrated within Figures 2(d) and 2(f). Such details are commonly adopted in UK structural design in order to meet tied and effective anchorage conditions respectively. For the vertical continuity tying requirements, the load that the connection is required to resist (as a tensile force), is determined by consideration of the equivalent axial compressive load that the column removed resists prior to its loss. However, this load only relates to that action which results from the application of the accidental load case and only for the load that is from the storey which would have been directly supported by the removed column. The resulting detail (Figure 2(d)) incorporates H25 reinforcing bars which are equally spaced about the centre point of the column, with the bars also fully anchored and lapped with the reinforcement within the precast column. The connection was modelled using non-linear ‘link’ elements and constraints as illustrated within Figure 2(e) in order to assess the suitability of the connection with respect to its rotational capacity.

To demonstrate the suitability of an effective anchorage connection (Figure 2(f)), it was only necessary to demonstrate that a lateral force equal to the dead weight of the horizontal member it supports can be resisted. This is a specific and explicit performance requirement for precast connections within current European design regulations (BSI 2010). All the applied loads are again factored as required, under accidental conditions by the European code (CEN 2006). For the detail considered, the reinforcing bar grouted into position is designed to act as a type of cast in steel billet, i.e. it acts in shear. However, because of the insufficient lap/anchorage of the bar it cannot be considered to have any rotational capacity. Therefore this connection type was modelled as non-linear link element, which was specified to lose load bearing capacity once the code stipulated axial limit had been reached (Figure 2(g)).

## **6 THE PERFORMANCE OF TIED AND ANCHORED PRECAST FRAMED BUILDINGS**

The response of the chosen precast building typologies to the nonlinear static push-down analyses conducted is presented within Figures 3(a) and 3(b) for the structures subjected to a column loss event at the centre and corner of the building's end bay respectively. The plots show the load factor (Eq. (1)) against the imposed deflection at the location at which the column has been removed. Because the maximum strength of structures in each case does not exceed a load factor of 1.0 none of the structural typologies considered would satisfy the recommendations of the GSA (2010) guidelines.

It was observed that for buildings of 10 storeys adopting a tied design, and for cases in which a corner column was removed, the precast framed structure 'yielded' at a load factor of around 0.58 with plastic hinge failures observed to occur initially, and as would be expected, at the point of maximum moment due to the induced cantilever. A much higher initial yield (0.75) and increased maximum strength (0.81-0.84) was observed for the structural models in which the central column was removed. Such a response should be expected because in the cases where a corner column has been removed, the push-down load is only being resisted by one, rather the two bays that act for the central column case.

Interestingly, an improved performance was seen for both the central and corner column load cases as the number of storeys was increased for the tied buildings. This appears to be because of a combination of effects. Firstly, the increased axial load appears to act so as to improve the moment rotation capacity of the plastic hinges. In addition, the taller buildings also have more structural members and the presence of more components in the building/model appears to inherently increase the number of alternative load paths which are available to resist and redistribute the induced loads.

As can be seen from Figure 3(a) a much more suitable overall building response to the column loss events was seen for the 'tied' rather than the 'anchored' building types. This is because after reaching ultimate strength a much more gradual saw toothed falling branch is seen until failure, with every instantaneous drop in strength relating directly to a plastic hinge

reaching its ultimate strain limit and the loss of residual plastic strength. In contrast, the load factor plot observed for the anchored low rise buildings was observed to be almost 'elastic' and 'brittle' in its nature. This is because framed structures resist progressive collapse essentially through the action of the vertical ties in tension and the rotational capacity/ductility of the beam to column connections. Because the anchored connections modelled only offer restraint in one constrained axial direction, they are consequentially ineffective in arresting the building collapse for the low rise structures considered.

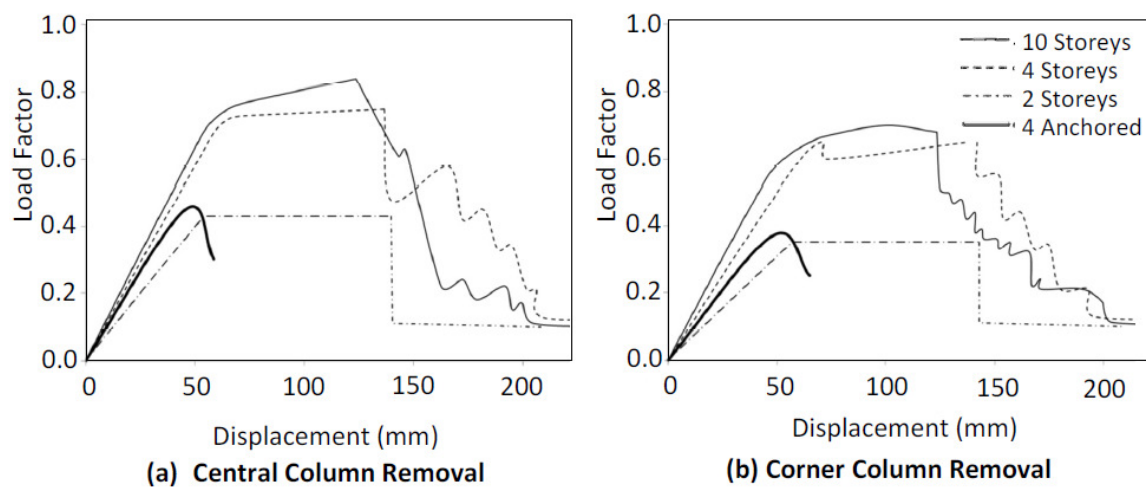

**Figure 3 Load-Displacement Relationships of Model Structures**

## 7 CONCLUSIONS AND PROPOSALS FOR FUTURE WORK

For the simplistic precast framed structures considered none were found to meet the GSA (2010) robustness performance regulations. All of the two and four storey structures investigated could also be classified as 'susceptible' to progressive collapse, according to the performance metric proposed by Marjanishvili and Agnew (2006). However, none of the buildings considered showed any indication that a secondary, detrimental 'pull down' effect due to the use of ties would induce or hasten the collapse sequence. The resulting behaviour and therefore 'performance' of the tied structures though is considered to be directly related to and significantly affected by the chosen tying detail Figure 2(d). However, a larger amount of investigation into the sensitivity of building performance to the nature of the precast tied connections to be used is required before any firm conclusions in regards to the suitability of

the current prescriptive tie design methodology and detailing rules, as they apply to precast framed structures, can be drawn.

Further, this study also provides no indication of in what manner the measured robustness of the structure will change in response to variations in: span length, storey height or plan shape. It is proposed therefore that such variables should be considered and incorporated as part of any future, similar studies, so as to further inform any necessary corrections to the existing robustness design regulations and guidance. In addition, analogous investigation of the performance of alternative precast cross wall construction typologies and the effect of utilising and suitably modelling for segmental and flexible floor diaphragms (e.g. Prestressed Hollowcore floor units) would also be of great significance to ensuring the suitable design of robust precast building typologies in the future.

## References

- Alexander, S J., (2004), "*New Approach to Disproportionate Collapse*", Proc. of The Structural Engineer, 82(23), p 14-18
- American Concrete Institute., (2008), "*Building Code Requirements for Structural Concrete and Commentary*", ACI 318-08 and 318R-08, Michigan (USA)
- American Society of Civil Engineers (ASCE)., (2007), "*Seismic Rehabilitation of Existing Buildings*", ASCE 41-06, Reston (USA)
- Beeby, A W., (1999), "*Safety of Structures and a New Approach to Robustness*", The Structural Engineer, 77(4), p 16-21
- British Standards Institution (BSI)., (2010), "*Published Document: Background Paper to the National Annexes to BS EN 1992-1 and BS EN 1992-3*", PD6687-1:2010, London (UK)
- Comitee Europeen de Normalisation., (2006), "*Euro-code 1: Actions on Structures. General Actions- Accidental Actions*", EN 1991-1-7:2006, Brussels (Belgium)
- General Services Administration (GSA)., (2010), "*Progressive Collapse Analysis and Design Guidelines for New Federal Office Buildings and Major Modernization Projects*", P100-2010, Washington (USA)
- Inel, M. Ozmen, H B., "*Effects of Plastic Hinge Properties in Non-Linear Analysis of Reinforced Concrete Buildings*", Proc of. Engineering Structures, 28(2006), p 1494-1502
- Izzuddin, B A. Vlassis, A G. Elghazouli, A.Y. Nethercot, D.A, (2008), "*Progressive Collapse of Multi- Storey Buildings Due to Sudden Column Loss-Part 1: Simplified Assessment Framework*", Proc of. Engineering Structures, 30(2008), p 1308-1318
- Kim, T. Kim, J. Park, T., (2009), "*Investigation of Progressive Collapse-Resisting Capability of Steel Moment Frames Using Push-Down Analysis*", Proc of. Journal of Performance of Constructed Facilities, 5(8), p 327-335

Lee, H. Huynh, C T. Kim, J., (2011), “*Retrofit of Structures to Prevent Progressive Collapse*”, Proc of. Modern Methods and Advances in Structural Engineering and Construction, ISEC-6, Zurich, p 327- 335

Marjanishvili, S. Agnew, E., (2006), “*Comparison of Various Procedures for Progressive Collapse Analysis*”, Proc of. Journal of Performance of Constructed Facilities, 20(4), p 365-374

Ministry of Housing (HMSO)., (1968), “*Report of the Inquiry Into the Collapse of Flats at Ronan Point*”, London (UK)

Office of the Deputy Prime Minister., (2004), “*Disproportionate Collapse*”, Part A3-Approved Documents, UK Building Regulation-Edition, London (UK)

Panagiotakis, T B. Fardis, (2001), M N., “*Deformations of Reinforced Concrete Members at Yielding and Ultimate*”, Proc of. ACI Structural Journal, 98(2) p 135-148

Starrosek, U., (2008), “*Avoiding Disproportionate Collapse of Tall Buildings*”, Structural Engineering International, 3(2008), p 238-246

Starrosek, U., (2007), “*Disproportionate Collapse: A Pragmatic Approach*”, Proc. of Structures and Buildings, 60(SB6), p 317-325

## 7 REFERENCES

Abrishami, H.H. and Mitchell D., 1997. Influence of Steel Fibers on Tension Stiffening. *ACI Structural Journal*. **94**(6): pp 769-776.

ACI Subcommittee 445-1. 2002. Examples for the Design of Structural Concrete with STMs: SP-208. American Concrete Institute. Michigan, USA.

Alexander, S.J. 2004. New Approach to Disproportionate Collapse. *The Structural Engineer*. **82**(23): pp 14-18.

Al-Khaiat, H. and Haque, M.N. 1998. Effect of Initial Curing on Early Strength and Physical Properties of Lightweight Concrete. *Cement and Concrete Research*. **28**(6): pp 859-866.

Al-Ta'an, S.A. and Ezzadeen, N.A. 1995. Flexural Analysis of Reinforced Fibrous Concrete Members Using the Finite Element Method. *Journal of Computers and Structures*. **56**(6): pp 1065-1072.

American Concrete Institute (ACI), 2008. ACI 318-08: Building Code Requirements for Structural Concrete and Commentary. Michigan, USA.

American Society of Civil Engineers (ASCE), 2007. ASCE 41-06: Seismic Rehabilitation of Existing Buildings. Reston, USA.

Argyle T.A. Palmeri, A. and Robinson G.P. 2011. Computational and Experimental Verification of Strut-and-Tie Models for Confined, Unconfined and Fibre Reinforced Concrete Beams with Dapped Ends. In: Proceedings of IStructE Model and Full Scale Testing Awards 2011, London, July, 2011.

Beeby, A.W. 1999. Safety of Structures and a New Approach to Robustness. *The Structural Engineer*. **77**(4): pp 16-21.

British Standards Institution (BSI), 2009. BS EN 12390: Testing of Hardened Concrete. London, UK.

Bryman, A. 2008. *Social Research Methods*. 2nd Edition, Oxford University Press, Oxford, UK.

Bryman, A. and Bell, E. 2007. *Business Research Methods*. 2nd Edition, Oxford University Press, Oxford, UK.

- 
- Chandrupatla, T.R. Belegundu, A.D. 2002. Introduction to Finite Elements in Engineering. 4th Edition, Pearson Education International, San Jose, USA.
- Choi, H. and Kim, J. 2011. Progressive Collapse Resisting Capacity of RC Beam-Column Sub-Assemblage. Magazine of Concrete Research. **63**(4): pp 297-310.
- Comité Européen de Normalisation (CEN), 2002. EN 1990: Euro-code 0 Basis of Structural Design. Brussels, Belgium.
- Comité Européen de Normalisation (CEN), 2004. EN 1992-1-1: Eurocode 2 Design of Concrete Structures- General Rules for Buildings. Brussels, Belgium.
- Comité Européen de Normalisation (CEN), 2006. EN 1991-1-7: Euro-code 1: Actions on Structures- General Actions- Accidental Actions. Brussels, Belgium.
- Comité Européen de Normalisation (CEN), 2008. TR 15728: Design and Use of Inserts for Lifting and Handling of Precast Concrete Elements. Stuttgart, Sweden.
- Confidential Reporting on Structural Safety (CROSS), 2010. Newsletter No 18. Available from <http://www.structural-safety.org/publications/newsletters/?page=2>. Retrieved: 28/05/2010.
- Crozier, D.A. and Sanjayan J.G., 1997. Slender Reinforced Concrete Panel Research. In: Proceedings of 18<sup>th</sup> Biennial CIA Conference on Concrete, Adelaide, May, 1997.
- De Falco, A. and Lucchesi M. 2002. Stability of Columns with No Tension Strength and Bounded Compressive Strength and Deformability. International Journal of Solids and Structures. **39**(25): pp 6191-6210.
- Doh, J.H. 2002. Experimental and Theoretical Studies of Normal and High Strength Concrete Wall Panels. Ph.D Thesis, Griffith University, Australia.
- Doh, J.H. and Fragomeni, S. 2005. Evaluation of Experimental Work on Concrete Walls in One-Way and Two-Way Action. Australian Journal of Structural Engineering. **6**(1): pp 103-115.
- Fellows, R. and Liu, L. 2005. Research Methods for Construction. 2nd Edition, Blackwell Science Ltd, Oxford, UK.



FIP Recommendations. 1999. Practical Design of Structural Concrete. FIP-Commission 3 Practical Design, MC90, Thomas Telford Publishing, London, UK.

Fragomeni, S. Mendis, A.M. Grayson, W.R. 1994. Review of Reinforced Concrete Wall Design Formulas. ACI Structural Journal. **91**(5): pp 521-529.

General Services Administration (GSA), 2010. P100-20: Progressive Collapse Analysis and Design Guidelines for New Federal Office Buildings and Major Modernization Projects. Washington, USA.

Gulvanessian, M. Calgaro, J.A. Holicky M. 2002. Designer's Guide to EN 1990 Eurocode: Basis of Structural Design. Thomas Telford Publishing, London, UK.

Hsu, L.S. and Hsu, C.T.T. 1994. Stress-Strain Behaviour of Steel Fibre High-Strength Concrete Under Compression. ACI Structural Journal **91**(4): pp 448-57.

Inel, M. and Ozmen, H.B. 2006. Effects of Plastic Hinge Properties in Non-Linear Analysis of Reinforced Concrete Buildings. Journal of Engineering Structures. **28**(2006). pp 1494-1502.

Institution of Structural Engineers (IStructE). 2010. Practical Guide to Structural Robustness and Disproportionate Collapse in Buildings. 1st Edition, Institution of Structural Engineers, London, UK.

Izzuddin, B.A. Vlassis, A.G. Elghazouli, A.Y. and Nethercot, D.A. 2008. Progressive Collapse of Multi-Storey Buildings Due to Sudden Column Loss-Part 1: Simplified Assessment Framework. Journal of Engineering Structures. **30**(2008): pp 1308-1318

Kayali, O. Haque, M.N. 2003. Some Characteristics of High Strength Fiber Reinforced Lightweight Aggregate Concrete. Journal of Cement and Concrete Composites. **25**(2): pp 207-213.

Kayali, O. 2008. Fly Ash Lightweight Aggregates in High Performance Concrete. Construction and Building Materials. **22**(12): pp 2393-2399.

Kim, T. Kim, J. and Park, T. 2009. Investigation of Progressive Collapse-Resisting Capability of Steel Moment Frames Using Push-Down Analysis. Journal of Performance of Constructed Facilities. **5**(8): pp 327-335

Kockal, N.U. and Ozturan, T. 2011. Strength and Elastic Properties of Structural Lightweight Concretes. Journal of Materials and Design. **32**(4): pp 2396-2403.

---

Knoll, K. and Vogel, T. 2005. Design for Robustness. In: Proceedings of IABSE, British Research Establishment Joint Committee on Structural Safety, Watford, November, 2005.

Kripanarayanan, K.M. 1977. Interesting Aspects of the Empirical Wall Design Equation. *ACI Structural Journal*. **74**(5): pp 204-207.

Kumar, R. 2005. *Research Methodology: A Step by Step Guide for Beginners*. 2nd Edition, Sage Publications, London, UK.

Lee, H. Huynh, C.T. and Kim, J. 2011. Retrofit of Structures to Prevent Progressive Collapse. In: Proceedings of Modern Methods and Advances in Structural Engineering and Construction (ISEC-6), Zurich, June, 2011.

Lu, W.Y. Lin, I.J. Hwang, S.J. and Lin, Y.H. 2003. Shear Strength of High-Strength Concrete Dapped-End Beams. *Journal of the Chinese Institute of Engineers*. **26**(5): pp. 671-680.

Lewis–Beck, M. 1993. *Experimental Design and Methods* Volume 3. 1st Edition, Sage Publications, London, UK.

Marjanishvili, S. and Agnew, E. 2006. Comparison of Various Procedures for Progressive Collapse Analysis. *Journal of Performance of Constructed Facilities*. **20**(4): pp 365-374.

Martin, S.L. and Godfrey, T.B. 2012. Mechanical Characterisation of Waste-Tyre Rubberised Concrete. In: Proceedings of IStructE 15<sup>th</sup> Young Researcher's Conference, London, UK, March, 2013.

Mander, J.B. Priestley, M.J.N. and Park, R. 1988. Theoretical Stress-Strain Model of Confined Concrete. *Journal of Structural Engineering*. **114**(8): pp 1804-1826.

Ministry of Housing (HMSO). 1968. Report of the Inquiry into the Collapse of Flats at Ronan Point. HMSO, London, UK.

Mays, G.C. and Barnes, R.A. 1991. Performance of Lightweight Aggregate Concrete Structures in Service. *The Structural Engineer*. **69**(20): pp 351-61.

Office of the Deputy Prime Minister (ODPM), 2004. Disproportionate Collapse Part A3-Approved Documents- UK Building Regulation-Edition. London, UK.

Naoum, S.G. 2006. *Dissertation Research and Writing for Construction Students*. 2nd Edition, Elsevier Butterworth Heinemann, Oxford, UK.

Panagiotakos, T.B. and Fardis, M.N. 2001. Deformations of Reinforced Concrete Members at Yielding and Ultimate. *ACI Structural Journal*, **98**(2): pp 135-148.

Pillai, S.U. and Parthasarathy, C.V. 1977. Ultimate Strength and Design of Concrete Walls. *Journal of Building and Environment*, **12**(1): pp 25-29.

Sanjayan, J.G. Crozier D.A. and Cheuk, J.G. 1997. Tension Softening Effects on the Buckling Behaviour of Slender Concrete Wall Panels. In: *Proceedings of 5<sup>th</sup> International Conference on Concrete Engineering and Technology*, Kuala Lumpur, Malaysia, May, 1997.

SAP. 2000. *Integrated Finite Element and Design of Structures Analysis Reference Manual*. v-14, Computers and Structures Inc, Berkley, USA.

Schmidt, T. Tyson, J. and Ganaulis, K. 2003. Full-field Dynamic Displacement and Strain Measurement Using Advanced 3D Image Correlation Photogrammetry- Part 1. *Journal of Experimental Techniques*, **27**(3): pp 47-50.

Schlaich, J. Schäfer, K. and Jennewith, M. 1987. Toward a Consistent Design of Structural Concrete. *Journal of Precast Concrete Institute-Special Report*. **32**(3): pp 1-49.

Schlaich, J. and Schäfer, K. 1991. Design and Detailing of Structural Concrete Using STMs. *The Structural Engineer*. **69**(6): pp 12-24.

Shimazaki, M., Hatanaka, S. and Tanigawa, Y. 1994. Compressive Failure and Toughness of High Strength Concrete Made with Lightweight Aggregate. *Journal of the Japan Concrete Institute*, **16**(1): pp 657-662.

Standard Association of Australia. 2010. *AS 3600-2009: Concrete Structures Amendment 1-2010*. Sydney, Aus.

Starossek, U. 2007. Disproportionate Collapse: A Pragmatic Approach. *Proceedings of the ICE- Structures and Buildings*. **160**(6): pp 317-325.

Starossek, U. and Haberland, M. 2008. Measures of Structural Robustness- Requirements and Applications, In: *Proceedings of ASCE SEI Structures Congress-Crossing Borders*, Vancouver, Canada, April, 2008.

Structherm. 2010. New Build (Precast) Solutions. <http://www.structherm.co.uk/literature.aspx>  
Retrieved: 10/04/13.

Tomosawa, F. 1996. Special HPCS II: Lightweight Aggregate Self-Compacting HPC. In: Proceedings of Fourth International Symposium on the Utilization of High Strength/ High Performance Concrete. Paris, France, July, 1996.

Robinson, G.P., Palmeri, A., Austin, S.A. 2011a. Tension Softening Effects on the Buckling Behaviour of Slender Concrete Wall Panels. In: Proceedings of ISEC-6 on Modern Methods and Advances in Structural Engineering and Construction. Zurich, June, 2011.

Robinson, G.P. Palmeri, A., Austin, S.A. 2011b. Implications of EC2 on the Design of Simply Supported Precast RC Panels Under Eccentric Axial Load. In: Proceedings of fib Symposium on Concrete Engineering for Excellence and Efficiency. Prague, June, 2011.

Wasserman, R. and Bentur, A. 1996. Interfacial Interactions in Lightweight Aggregate Concretes and their Influence on the Concrete Strength. *Cement and Concrete Composites*. **18**(1): pp 67-76.

Wight, J.K. and MacGregor, J.G. 2009. Reinforced Concrete Mechanics and Design. 5th Edition. Pearson Education International, San Jose, USA.

Wibowo, H. and Lau, D.T. 2009. Seismic Progressive Collapse: Qualitative Point of View. *Journal of Civil Engineering Dimension*. **11**(1): pp 8-14.

Wu, Z., Zhang, J. and Ding, Y. 2009. An Experimental Study on the Workability of Self-Compacting Lightweight Concrete. *Journal of Construction and Building Materials*. **23**(5): pp 2087-92.