

# Direct Analysis of Oil Additives by High-Field Asymmetric Waveform Ion Mobility Spectrometry-Mass Spectrometry Combined with Electrospray Ionization and Desorption Electrospray Ionization

Caitlyn Da Costa,<sup>†</sup> Matthew Turner,<sup>†</sup> James C. Reynolds,<sup>†</sup> Samuel Whitmarsh,<sup>‡</sup> Tom Lynch,<sup>‡</sup> and Colin S. Creaser<sup>\*,†</sup>

<sup>†</sup>Centre for Analytical Science, Department of Chemistry, Loughborough University, Leicestershire, LE11 3TU, United Kingdom

<sup>‡</sup>BP Formulated Products Technology, Whitchurch Hill, Pangbourne, Reading, RG8 7QR, United Kingdom

**ABSTRACT:** The analysis of corrosion inhibitors in the presence and absence of an oil matrix is reported using electrospray ionization (ESI) and desorption electrospray ionization (DESI), hyphenated with miniaturized high-field asymmetric waveform ion mobility spectrometry (FAIMS) and mass spectrometry (MS). The target analytes were successfully ionized in solution by ESI and directly from steel surfaces using DESI ambient ionization at levels  $\geq 0.0004\%$  w/w (4 ppm) in oil. Differences in the mass spectral profiles observed for the additive/oil mixture are attributed to differences between the ESI and DESI ionization processes. The use of FAIMS improved selectivity for ESI generated analyte ions through reduction in the chemical noise resulting from the oil matrix. DESI enabled the direct, rapid, native state interrogation of oil samples on steel surfaces without sample pretreatment, and the hyphenation of DESI with the miniaturized FAIMS enhanced the relative analyte responses of the surface-active corrosion inhibitors.

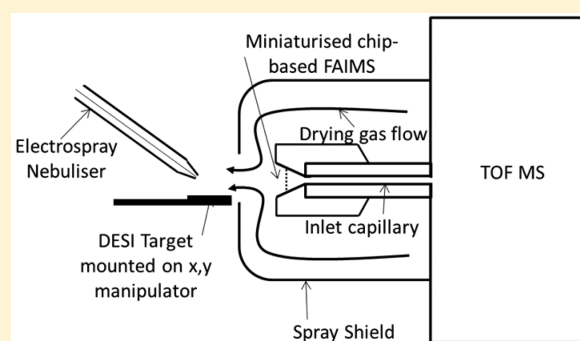

Chemical additives are blended into a wide range of chemical feedstocks and products to enhance performance and mitigate adverse properties of the fluid. Such additives include detergents and dispersants, antioxidants, and friction modifiers.<sup>1</sup> A group of additives, described as surface active compounds, act as corrosion inhibitors by binding to the metal surface forming a protective layer between the metal and the fluid within the system, reducing the rate of oxidative corrosion.<sup>1</sup> One class of corrosion inhibitors are oil-soluble quaternary amines.<sup>1,2</sup>

In the lubricating oil market, the mass spectrometric analysis of additives from surfaces can provide information regarding the age, composition, and degradation state of the formulation.<sup>3,4</sup> A wide range of atmospheric pressure ionization techniques, including atmospheric pressure photoionization,<sup>5,6</sup> matrix assisted laser desorption ionization (MALDI),<sup>7</sup> and electrospray ionization (ESI),<sup>8</sup> have been employed for analytical studies of oil samples. Direct ambient ionization techniques allow for the rapid native state interrogation of samples with minimal sample pretreatment. This can increase sample throughput and reduce the requirement for sample preparation prior to analysis. The characterization of oil samples by direct ambient ionization-mass spectrometry has been demonstrated using easy ambient sonic-spray ionization<sup>9</sup> and venturi easy ambient sonic-spray ionization.<sup>10</sup> Paper spray ionization hyphenated with miniaturized mass spectrometry has been reported for the direct quantitative analysis of quaternary ammonium corrosion inhibitors present in a pump oil matrix,

showing very low limits of detection ( $<100$  ppb).<sup>11</sup> Desorption electrospray ionization (DESI) is an ambient ionization method that uses an electrospray-generated solvent spray directed toward a target surface to desorb and ionize molecular analytes.<sup>12</sup> This enables the rapid *in situ* analysis of compounds from a sample surface with little or no sample preparation. DESI-mass spectrometry (MS) has been used in a range of applications for the analysis of molecules present on a variety of surface materials such as polymers, paper, glass, and metal.<sup>13–17</sup> We have previously reported the application of DESI-MS for the quantitative determination of an oil antioxidant additive.<sup>18</sup>

Chromatographic separation prior to MS is typically used for petrochemical analysis to simplify the data generated from complex oil samples, and liquid chromatography, combined with ESI and mass spectrometry, is a powerful method for the quantitative determination of additives in oils.<sup>19</sup> Ultrahigh resolution and accurate mass instrumentation, such as Fourier transform-ion cyclotron resonance-mass spectrometry,<sup>3,20–22</sup> are widely used for characterization studies, although the complex spectra and high levels of chemical noise resulting from the oil matrix can mask the responses of additives. Alternatively, multistage sample preparation techniques can be used to fractionate or extract the additives from the oil prior to

Received: December 3, 2015

Accepted: January 18, 2016

Published: January 18, 2016

analysis.<sup>19</sup> However, chromatographic and sample preparation procedures are time-consuming compared to direct ambient ionization techniques such as DESI. In addition, the *in situ* nature of DESI has the potential to determine the location of additives, such as the surface-active corrosion inhibitors, on tribological components to determine the additive activity and distribution.

Ion mobility spectrometry (IMS) and high-field asymmetric waveform ion mobility spectrometry (FAIMS), also known as differential mobility spectrometry, can be used to separate ions rapidly in the gas phase.<sup>23,24</sup> In drift tube IMS, ions are separated in the presence of a weak electric field on the basis of collision cross section (CCS), which is related to the size and shape of the ion. In FAIMS, ion transmission is determined by differences in ion mobility in the presence of alternating low and high electric fields, which is dependent on the CCS and chemical characteristics of the ions. Hyphenation of IMS or FAIMS with MS therefore provides a rapid postionization separation of gaseous ions by differential ion mobility and mass-to-charge ratio, making the combined technique suitable for use with ambient ionization methods such as DESI.<sup>25–27</sup> The use of IMS with MS for the analysis of oils has been reported for the study of chemically related compounds within oils, oil characterization, and petroleomics.<sup>28–30</sup> FAIMS has been applied to the analysis of a wide range of analytes including proteins,<sup>31,32</sup> biological samples,<sup>33,34</sup> and pharmaceutical impurities.<sup>35</sup> The application of FAIMS-MS to the analysis of oils has been demonstrated for the characterization of naphthenic acids and the study of crude oil mixtures.<sup>36,37</sup> The hyphenation of DESI with IMS-MS has been used for the direct analysis of native surface substrates, with little or no sample preparation, showing improved sensitivity for targeted analytes compared to DESI-MS alone. The combination of DESI with differential mobility spectrometry and MS has been reported for the analysis of pharmaceuticals and the imaging of biological tissues.<sup>38,39</sup>

In this paper, we demonstrate the hyphenation of ESI and DESI with FAIMS-MS using a miniaturized FAIMS device for the targeted analysis of surface active corrosion inhibitors in the presence of an oil matrix. The corrosion inhibitors were analyzed in solution by ESI and directly from steel surfaces using DESI ambient ionization.

## EXPERIMENTAL SECTION

**Reagents and Chemicals.** Methanol (HPLC grade) was purchased from Fisher Scientific (Loughborough, UK), and toluene (HPLC grade) was purchased from Sigma-Aldrich (Gillingham, UK). Toluene and methanol solvents are both toxic by inhalation and therefore should be handled in a well ventilated environment. The quaternary amine corrosion inhibitor standards, benzyldimethyldodecylammonium chloride (1), benzyldimethyltetradecylammonium chloride (2), and benzyldimethylhexadecylammonium chloride (3), were purchased from Sigma-Aldrich (Gillingham, UK) and were 99%, 97%, and cationic detergent grade, respectively. The structures are shown in Figure 1. A group 1 base oil was supplied by Castrol (Pangbourne, UK) for the analysis.

**Sample Preparation.** The additive standards were prepared as equimolar mixtures in 50:50 MeOH/toluene. The additives were directly infused into the ESI source at a concentration of 183 ng/mL (1), 198 ng/mL (2), and 213 ng/mL (3). For DESI analyses, the additives were present in solution at a concentration of 183  $\mu$ g/mL (1), 198  $\mu$ g/mL (2),

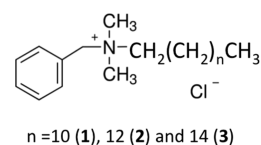

**Figure 1.** Structures of the benzyldimethylalkylammonium surface active corrosion inhibitor oil additive compounds.

and 213  $\mu$ g/mL (3), which corresponds to 1.83  $\mu$ g (1), 1.98  $\mu$ g (2), and 2.13  $\mu$ g (3) on spot (10  $\mu$ L spot).

The oil/additive mixture was prepared by making stock solutions of the corrosion inhibitor additives: 37  $\mu$ g/mL (1), 40  $\mu$ g/mL (2), and 43  $\mu$ g/mL (3) in 50:50 MeOH/toluene. The stock solutions (10  $\mu$ L) were spiked into 100 mg of group 1 base oil, and the solvent left evaporated to yield an oil/additive mixture with the additives present in the oil matrix at  $\sim 0.0004\%$  w/w (equivalent to 4 ppm), which was used for both ESI and DESI analyses. The oil/additive mixture was diluted 1/200 in 50:50 MeOH/toluene for direct infusion ESI analysis, giving a final concentration of 1.9 ng/mL (1), 2.0 ng/mL (2), 2.1 ng/mL (3), and 0.5 mg/mL group 1 base oil. For DESI analyses, the oil/additive mixture (5 mg) was deposited neat onto an earthed steel coupon (cold rolled, grade 1008 1010, polished) so that the additives were present on the surface at 19, 20, and 22 ng/spot for compounds 1, 2, and 3, respectively, corresponding to 0.33, 0.35, and 0.39 ng/mm<sup>2</sup> for a typical 57 mm<sup>2</sup> oil spot. An oil blank was prepared for DESI analysis by depositing 5 mg of unspiked oil on the metal surface.

**Instrumental Parameters.** The analysis of the corrosion inhibitor and oil samples was carried out using an Agilent 6230 time-of-flight mass spectrometer (Agilent Technologies, Santa Clara, USA) fitted with either a modified JetStream ESI source or an in-house constructed DESI source, which is described in detail below. The mass spectrometer was operated in positive ion mode. A prototype miniaturized, chip-based FAIMS device (Owlstone Limited, Cambridge, UK) was located between the spray shield and the transfer inlet capillary of the mass spectrometer as shown in Figure 2.<sup>31</sup> Nitrogen gas (99.5% purity) was used for all gas flows including the carrier gas for the FAIMS chip. The samples were introduced into the source using direct infusion (10  $\mu$ L/min) for ESI-MS and analyzed using the following experimental conditions: drying gas, 10 L/min at 100  $^{\circ}$ C; sheath gas, 12 L/min at 150  $^{\circ}$ C; nebulizer gas, 30 psig; capillary voltage, 3.5 kV; nozzle voltage, 2 kV; fragmentor voltage, 175 V.

**DESI Source Construction and Instrumental Parameters.** An in-house constructed DESI source was fitted to the inlet region of the Agilent 6230 TOF mass spectrometer as shown in Figure 2b, to enable hyphenation of DESI with FAIMS-MS. The Agilent JetStream ESI source housing was removed from the mass spectrometer, and the electrospray nebulizer was extracted. The nebulizer was then mounted in the ion source region of the instrument at an angle of  $\sim 55^{\circ}$  to the DESI target surface, so that the tip was  $\sim 5$  mm from the mass spectrometer inlet and  $\sim 2$  mm from the target surface (Figure 2b). An external power supply (Brandenburg voltage supply) provided ESI voltages in the range of 0–2500 V. The target surface was mounted on an  $x,y$  manipulator positioned under the tip of the nebulizer at the mass spectrometer inlet. Sample spots were analyzed in positive ion mode using the following experimental conditions: drying gas, 7 L/min at 150  $^{\circ}$ C; nebulizer gas, 30 psig; nebulizer voltage, 1.5 kV; capillary

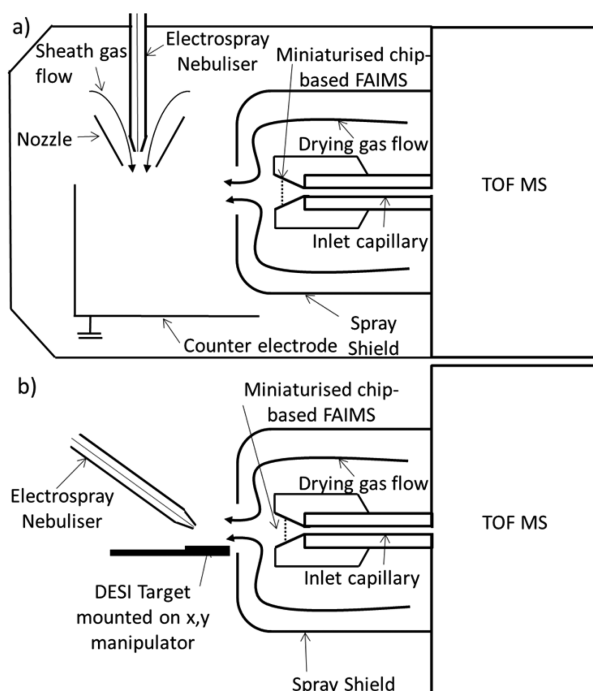

**Figure 2.** Schematic diagram of the TOF-MS interfaced with the miniaturized chip-based FAIMS using (a) the standard ESI source configuration and (b) the in-house constructed DESI source.

voltage, 3.5 kV; fragmentor voltage, 175 V; electro spray flow of 50:50 MeOH/toluene at 5  $\mu\text{L}/\text{min}$ .

**FAIMS Instrumental Parameters.** The prototype miniaturized chip-based FAIMS device (Owlstone Ltd., Cambridge), located at the mass spectrometer inlet, has been described elsewhere<sup>24,31</sup> and consists of multiple planar electrode channels, each with a 100  $\mu\text{m}$  gap and an electrode length of 700  $\mu\text{m}$ . An asymmetric waveform dispersion field (DF) was supplied to the device through the modified source housing. The DF (in the range of 190–320 Td) was applied to the FAIMS chip using an approximate low to high field ratio of 2:1 at a 27 MHz frequency. Data were acquired, smoothed, and processed using Mass Hunter Qualitative Analysis Version B 05.00.

Optimum FAIMS conditions for the selective transmission of the corrosion inhibitors were determined by conducting compensation field (CF) scans from  $-2$  to 5 Td CF at a sweep rate of 0.5 Td/s, at DFs in the range of 190–320 at 10 Td intervals. The CF voltages (DF 250 Td) for optimum transmission of the additives were determined to be 1.80 Td for ESI and 1.55 Td for DESI.

## RESULTS AND DISCUSSION

The analysis of the benzyldimethylalkylammonium surface active corrosion inhibitor oil additives (Figure 1; 1–3) was carried out using a time-of-flight mass spectrometer fitted with a miniaturized FAIMS device combined with ESI and DESI ionization sources. The additives were successfully ionized both in solution by ESI and directly from steel surfaces using DESI ambient ionization in the presence and absence of an oil matrix. The potential of FAIMS for the targeted analysis of the surface active compounds present in a complex oil matrix was evaluated without chromatographic separation.

An equimolar mixture of the additives in MeOH/toluene (50:50) was initially analyzed by ESI combined with MS, which

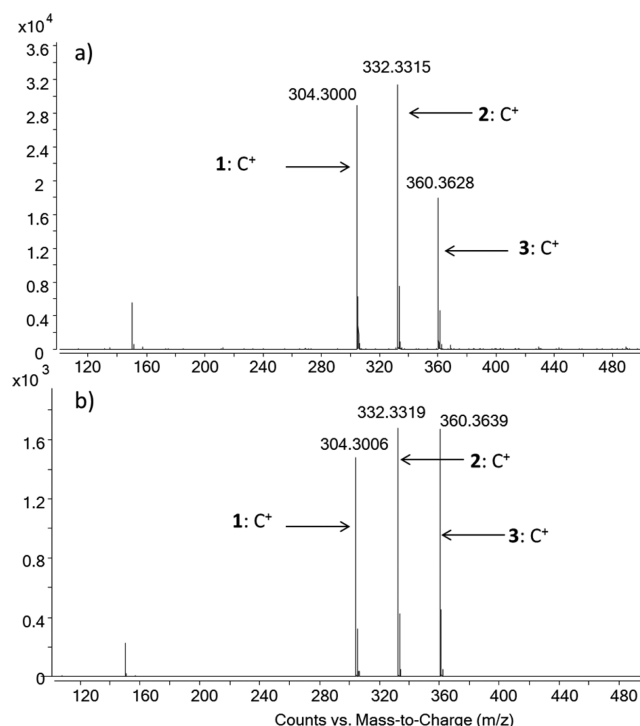
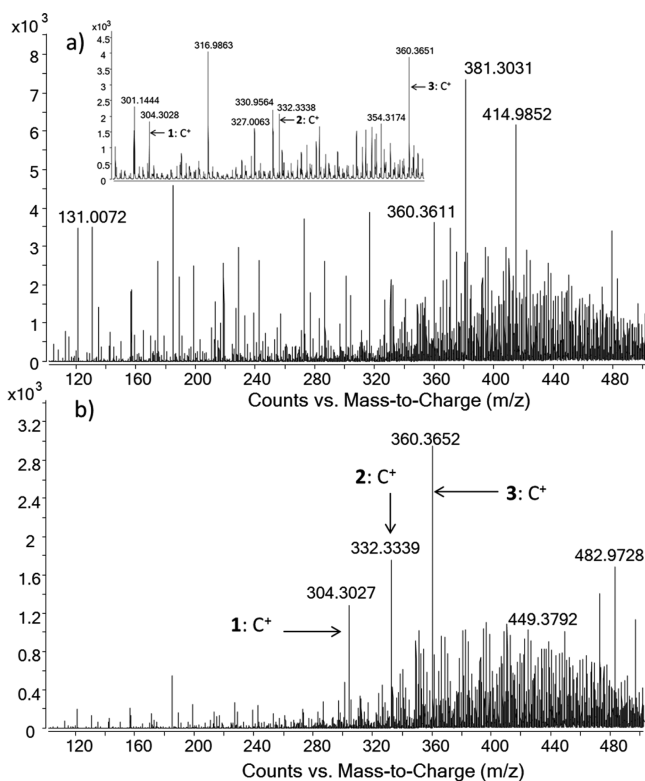

**Figure 3.** Mass spectrometry analysis of a mixture of corrosion inhibitor additives using (a) ESI (183–213 ng/mL in MeOH/toluene (50:50)) and (b) DESI (1.83–2.13  $\mu\text{g}$  on spot).

generated strong responses for the quaternary ammonium cations ( $\text{C}^+$ ) at  $m/z$  304.30 (1),  $m/z$  332.33 (2), and  $m/z$  360.36 (3), as shown in Figure 3a. The standard mixture was then spotted onto a steel surface; the solvent evaporated, and the dry spot was analyzed by DESI using an in-house constructed ion source. The resulting mass spectrum showed the same ions as the ESI, demonstrating that DESI can be used to successfully desorb and ionize these compounds from a metal surface.

**ESI-FAIMS-MS of Corrosion Inhibitors in Oil.** The corrosion inhibitors were spiked into a base oil at a concentration of 0.0004% w/w (equivalent to 4 ppm) and diluted in 50:50 MeOH/toluene (1:200) for analysis by ESI-MS and ESI-FAIMS-MS. Initial experimentation using ESI-MS was carried out to determine the additive responses without a FAIMS separation. The resulting mass spectrum (Figure 4a) shows the chemical profile resulting from the oil matrix generated by ESI. A typical mass spectral response for an oil-based sample is observed in the mass range  $m/z$  200–500. The ion at  $m/z$  360.36 is assigned to the  $\text{C}^+$  ion of the additive compound 3, but the additive ions for compounds 1 and 2 are difficult to distinguish from the chemical background resulting from the matrix using ESI-MS alone (Figure 4a inset).

The application of FAIMS ion selection to the analysis of complex mixtures has been shown to improve the relative analyte responses through the selective transmission of target ions and removal of background chemical noise.<sup>33–36</sup> The oil/additive mixture was therefore analyzed by ESI-FAIMS-MS to optimize the parameters for the FAIMS-selected transmission of the additive ions. The FAIMS transmission characteristics of the corrosion inhibitor additives were investigated by stepping the dispersion field (DF) from 190 to 320 Td (at 10 Td intervals) and scanning the compensation field (CF) from  $-2$  to 5 Td at each DF. The three additive ions had similar CF



**Figure 4.** Analysis of an oil/additive mixture with corrosion inhibitor additives 1–3 present at 4 ppm using (a) ESI-MS, showing an expanded view of the baseline in the inset and (b) ESI-FAIMS-MS (DF 250 Td; CF 1.8 Td).

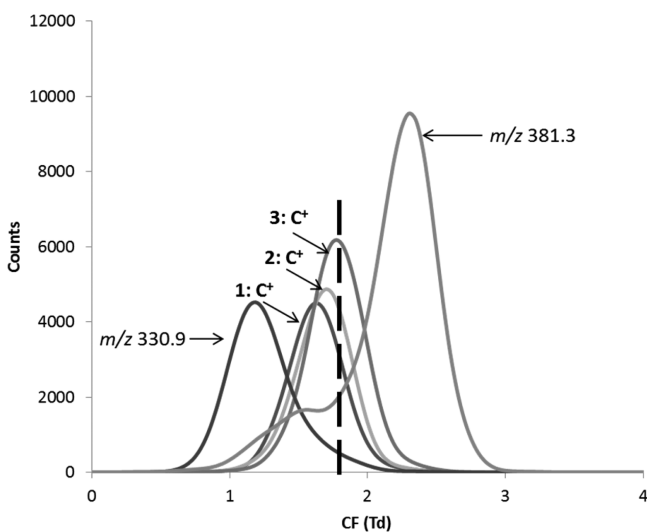

**Figure 5.** Selected ion responses for the corrosion inhibitor additives 1–3 and oil matrix ions in the CF scan spectrum at DF 250 Td.

spectra (Figure 5), with maximum transmission CFs of 1.68, 1.75, and 1.80 Td for compounds 1, 2, and 3 ions, respectively, at a DF of 250 Td. FAIMS separation is based on differences in ion mobility at low and high electric fields resulting from the interactions of ions with the FAIMS buffer gas and with water and other small neutral molecules present at trace levels in the FAIMS device, as well as other factors such as temperature, ion structure, and conformation.<sup>24</sup> The three inhibitors are all quaternary amines, which would be expected to have similar FAIMS characteristics and CFs for maximum transmission, with

the alkyl chain length making a smaller contribution to FAIMS transmission. In contrast, other compounds present in the oil with different functionality and chain length may have maximum transmission at higher or lower CFs, allowing selectivity in the transmission of the additive ions. This is illustrated for two ions from the oil matrix, at  $m/z$  331 and  $m/z$  381, also shown in the CF spectrum (Figure 5), which have different CFs for optimum transmission. This results in the filtering effect of the FAIMS-selected transmission of target ions and the suppression of matrix ion responses.

A CF of 1.80 Td was chosen as the optimum for the FAIMS-selected simultaneous transmission of all three additives. Under these conditions, the use of FAIMS resulted in a reduction in the response associated with the oil matrix and a relative enhancement in the compounds 1–3 ion responses (Figure 4b), which enabled the additive ions to be clearly observed in the mass spectrum, with the compound 3 ion as the base peak. This improved both the selectivity of the technique and also the sensitivity; for example, there is a S/N improvement of 2.6 for corrosion inhibitor 3 ion compared to ESI-MS alone. The accurate mass of the  $C^+$  ion of compound 3 ( $m/z$  360.3619) is within 3.1 ppm of the expected mass, and the accurate masses of the  $C^+$  ions of compound 1 ( $m/z$  304.2997, 2.4 ppm) and 2 (332.3309, 2.5 ppm) are also close to the expected values.

**DESI-FAIMS-MS of Corrosion Inhibitors in Oil.** The use of ESI requires that oil/additive mixtures are extracted from a surface and diluted prior to analysis. In contrast, ambient ionization techniques such as DESI allow the direct analysis of analytes on surfaces. The desorption of oil/additive mixtures directly from steel coupons by DESI-MS and DESI-FAIMS-MS was therefore investigated using an in-house constructed DESI ion source (Figure 2b). The DESI-MS analysis of the oil spiked with the corrosion inhibitors without FAIMS selection is shown in Figure 6a,b. The additive-containing oil was deposited neat onto the steel coupon for DESI analysis, to mimic oil residues on tribological surfaces. The sensitivity of DESI using the in-house constructed source was significantly lower than that observed for ESI using the standard source. The concentration of the corrosion inhibitors in the oil was the same for the DESI and the ESI analyses (0.0004% w/w), but the oil was diluted 200-fold in methanol/toluene for ESI measurements, making the DESI concentrations of the additives 200 $\times$  higher. Signal levels for DESI were  $\sim$ 20 times less, making DESI  $\sim$ 4000 times less sensitive than ESI. The DESI spectrum also did not show the characteristic oil profile observed with ESI, which may be because of the lower sensitivity and ambient nature of the DESI ionization technique. The extraction/desorption process in DESI is complex and depends on surface effects, the rate of transfer of compounds into the solvent film on the target surface, and the activity of the compounds at the liquid/air interface.<sup>14</sup> These, in turn, are determined by experimental factors including compound solubility and diffusion coefficient in the electrospray solvent, the nebulizer voltage and geometry, electrospray flow rate, and temperature, all of which will impact the observed DESI-MS response. A full understanding of the various contributions requires further work to observe the effect of DESI experimental parameters on specific compound classes present in oils.

The additive ions could not be confidently distinguished from the oil matrix by DESI-MS alone at a concentration of 0.0004% w/w (Figure 6a,b), as a consequence of the lower sensitivity for DESI compared to ESI, so the analysis was repeated using the in-house constructed DESI source

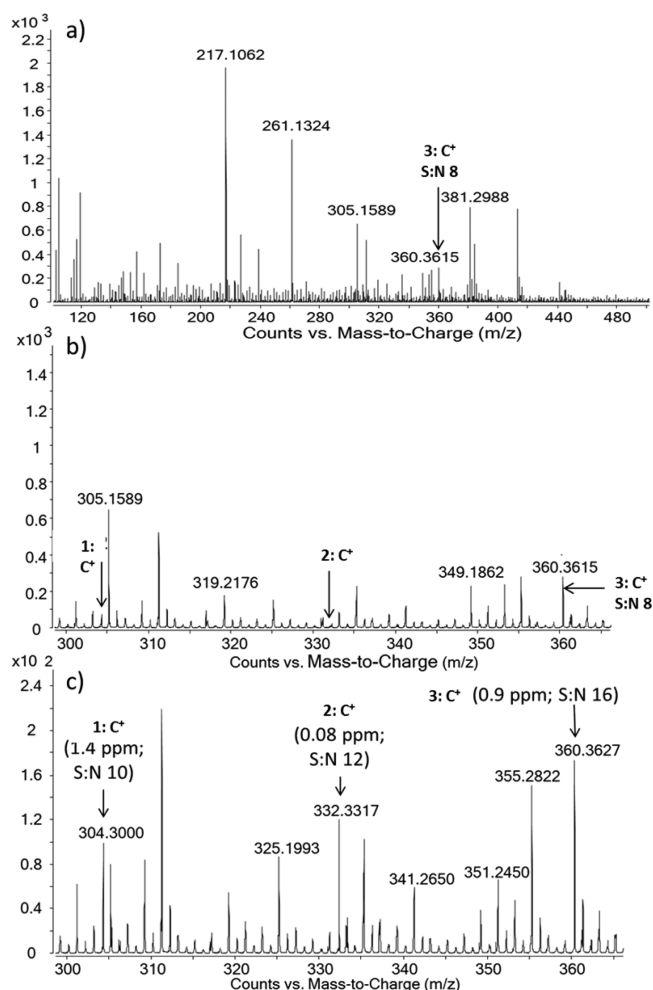

**Figure 6.** Analysis of an oil/additive mixture (5 mg oil with additives 1–3 in the range of 19–22 ng on spot) deposited on a metal surface using (a) DESI-MS in the range of  $m/z$  100–500, (b) DESI-MS (expanded view), and (c) DESI-FAIMS-MS (DF 250 Td; CF 1.55 Td).

positioned just in front of the FAIMS chip, which was located adjacent to the inlet capillary of the mass spectrometer (Figure 2b). The sample platform was held in line with the mass spectrometer inlet, with the electrospray plume directed at the sample and angled toward the inlet capillary, so that the flow of desorbed ions was directed toward the FAIMS chip. A DF of 250 Td determined in the ESI-FAIMS-MS analysis of the oil/additive mixture was used for the DESI-FAIMS-MS analysis, and a CF sweep of  $-2$  to  $5$  Td (at  $0.5$  Td/s) was carried out. Transmission of all three additives was achieved at a CF of  $1.55$  Td, and all further experimentation was carried out in static mode, with the DF and CF voltages fixed (DF 250 Td, CF  $1.55$  Td). The optimum CF for the transmission of the additives was lower for DESI ( $1.55$  Td) compared to ESI ( $1.80$  Td). This is attributed to the lower temperature of the FAIMS chip using the open DESI source, which was at ambient temperature, whereas the closed ESI source was heated by the sheath gas. The source temperature influences the FAIMS chip temperature which will affect the CF and, potentially, the DF.

Analysis of the oil/additive mixture by DESI-FAIMS-MS generated an approximately 10-fold enhancement in the additive responses relative to the oil matrix ions as a result of FAIMS-selected transmission (compound 1, S/N 10; com-

pound 2, S/N 12; compound 3, S/N 16) as shown in Figure 6c. The DESI-FAIMS-MS analysis of the unspiked base oil showed no responses for the corrosion inhibitor ions. The combination of DESI with FAIMS-MS therefore allows the additive ions, which could not be confidently identified without FAIMS selection, to be detected in the oil. The concentration of the corrosion inhibitors in the oil was  $0.0004\%$  w/w (equivalent to  $4$  ppm), which is below formulated levels ( $0.05$ – $5\%$  w/w), to reflect concentrations in an aged oil sample. The sensitivity of DESI is significantly lower than ESI, but unlike ESI where the sample must be extracted from the surface and diluted prior to analysis, DESI allows direct desorption of the neat oil and additives from tribological systems without extraction or pretreatment. The DESI-FAIMS-MS method is demonstrated to have sufficient sensitivity for the analytes of interest to be detected in the presence of the oil matrix, at concentrations more than one hundred times less than formulated levels, by direct *in situ* desorption from the metal surface.

## CONCLUDING REMARKS

This study demonstrates the application of FAIMS-MS, combined with ESI and DESI ionization, to the targeted analysis of additives present at low levels in an oil matrix, using a series of surface active corrosion inhibitors as model compounds. The analysis of oil/additive mixtures on steel surfaces is the first hyphenation of DESI with FAIMS-MS for the direct analysis of oil additives without sample preparation. FAIMS selection of target ions generated by ESI and DESI enhanced the relative response of the additives by reducing the chemical noise resulting from the oil matrix. Differences in the oil matrix profiles observed for DESI and ESI are associated with the ambient nature of DESI. FAIMS is well suited to direct ambient ionization techniques, such as DESI, where pre-separation of analytes in complex samples is not possible. The FAIMS-selected transmission of the additive ions provided a rapid postionization sample clean up method to enhance the additive responses to a quantifiable level. The approach has potential for wider application to the targeted and nontargeted analysis of oils and additives and for the imaging of tribological components to determine additive deposition and activity.

## AUTHOR INFORMATION

### Corresponding Author

\*Tel: +44 (0)1509 222552. Fax: +44 (0)1509 223925. E-mail: C.S.Creaser@lboro.ac.uk.

### Author Contributions

The manuscript was written through contributions of all authors. All authors have given approval to the final version of the manuscript.

### Notes

The authors declare no competing financial interest.

## ACKNOWLEDGMENTS

The authors would like to thank the Engineering and Physical Sciences Research Council and BP for an Industrial CASE Studentship and Kayleigh Arthur (Loughborough University) and Robert Smith (Owlstone Limited, Cambridge) for their assistance.

## REFERENCES

- (1) Mortier, R.; Orszulik, S. *Chemistry and Technology of Lubricants*, 2nd ed.; Blavkie Academic and Professional: Glasgow, 1997.

- (2) Chiang, L. Y.; Swirczewski, J. W.; Ramanarayanan, T. A.; Mumford, J. D. *Chem. Mater.* **1992**, *4*, 245–247.
- (3) Marshall, A. G.; Rodgers, R. P. *Proc. Natl. Acad. Sci. U. S. A.* **2008**, *105*, 18090–18095.
- (4) Rodgers, R. P.; McKenna, A. M. *Anal. Chem.* **2011**, *83*, 4665–4687.
- (5) Chiaberge, S.; Fiorani, T.; Savoini, A.; Bionda, A.; Ramello, S.; Pastori, M.; Cesti, P. *Fuel Process. Technol.* **2013**, *106*, 181–185.
- (6) Pereira, T. M. C.; Vanini, G.; Oliveira, E. C. S.; Cardoso, F. M. R.; Fleming, F. P.; Neto, A. C.; Lacerda, V.; Castro, E. V. R.; Vaz, B. G.; Romão, W. *Fuel* **2014**, *118*, 348–357.
- (7) Pantoja, P. A.; Mendes, M. A.; Nascimento, C. A. O. *J. Pet. Sci. Eng.* **2013**, *109*, 198–205.
- (8) Zahlse, K.; Eide, I. *Energy Fuels* **2006**, *20*, 265–270.
- (9) Corilo, Y. E.; Vaz, B. G.; Simas, R. C.; Nascimento, H. D. L.; Klitzke, C. F.; Pereira, R. C. L.; Bastos, W. L.; Santos Neto, E. V.; Rodgers, R. P.; Eberlin, M. N. *Anal. Chem.* **2010**, *82*, 3990–3996.
- (10) Haddad, R.; Regiani, T.; Klitzke, C. F.; Sanvido, G. B.; Corilo, Y. E.; Augusti, D. V.; Pasa, V. M. D.; Pereira, R. C. C.; Romão, W.; Vaz, B. G.; Augusti, R.; Eberlin, M. N. *Energy Fuels* **2012**, *26*, 3542–3547.
- (11) Jjunju, F. P. M.; Li, A.; Badu-Tawiah, A.; Wei, P.; Li, L.; Ouyang, Z.; Roqan, I. S.; Cooks, R. G. *Analyst* **2013**, *138*, 3740–3748.
- (12) Takáts, Z.; Wiseman, J. M.; Gologan, B.; Cooks, R. G. *Science* **2004**, *306*, 471–473.
- (13) Takáts, Z.; Wiseman, J. M.; Cooks, R. G. *J. Mass Spectrom.* **2005**, *40*, 1261–1275.
- (14) Cooks, R. G.; Ouyang, Z.; Takats, Z.; Wiseman, J. M. *Science* **2006**, *311*, 1566–1570.
- (15) Weston, D. J. *Analyst* **2010**, *135*, 661–668.
- (16) Harris, G. a; Galhena, A. S.; Fernández, F. M. *Anal. Chem.* **2011**, *83*, 4508–4538.
- (17) Morelato, M.; Beavis, A.; Kirkbride, P.; Roux, C. *Forensic Sci. Int.* **2013**, *226*, 10–21.
- (18) Da Costa, C.; Reynolds, J. C.; Whitmarsh, S.; Lynch, T.; Creaser, C. S. *Rapid Commun. Mass Spectrom.* **2013**, *27*, 2420–2424.
- (19) Panda, S. K.; Andersson, J. T.; Schrader, W. *Anal. Bioanal. Chem.* **2007**, *389*, 1329–1339.
- (20) Pereira, R. C. L.; Simas, R. C.; Corilo, Y. E.; Vaz, B. G.; Klitzke, C. F.; Schmidt, E. M.; Pudenzi, M. A.; Silva, R. M. C. F.; Moraes, E. T.; Bastos, W. L.; Eberlin, M. N.; Nascimento, H. D. L. *Energy Fuels* **2013**, *27*, 7208–7216.
- (21) Hughey, C. A.; Rodgers, R. P.; Marshall, A. G. *Anal. Chem.* **2002**, *74*, 4145–4149.
- (22) Klitzke, C. F.; Corilo, Y. E.; Siek, K.; Binkley, J.; Patrick, J.; Eberlin, M. N. *Energy Fuels* **2012**, *26*, 5787–5794.
- (23) Eiceman, G.; Karpaz, Z.; Hill, H. . *Ion Mobility Spectrometry*, third ed.; CRC Press: Boca Raton, FL, 2013.
- (24) Shvartsburg, A. A. *Differential Ion Mobility Spectrometry: Nonlinear Ion Transport and Fundamentals of FAIMS*; CRC Press: Boca Raton, FL, 2008.
- (25) Weston, D. J.; Bateman, R.; Wilson, I. D.; Wood, T. R.; Creaser, C. S. *Anal. Chem.* **2005**, *77*, 7572–7580.
- (26) Kaur-Atwal, G.; Weston, D. J.; Green, P. S.; Crosland, S.; Bonner, P. L. R.; Creaser, C. S. *Rapid Commun. Mass Spectrom.* **2007**, *21*, 1131–1138.
- (27) Harry, E. L.; Reynolds, J. C.; Bristow, A. W. T.; Wilson, I. D.; Creaser, C. S. *Rapid Commun. Mass Spectrom.* **2009**, *23*, 2597–2604.
- (28) Becker, C.; Qian, K.; Russell, D. H. *Anal. Chem.* **2008**, *80*, 8592–8597.
- (29) Ahmed, A.; Cho, Y. J.; No, M.-H.; Koh, J.; Tomczyk, N.; Giles, K.; Yoo, J. S.; Kim, S. *Anal. Chem.* **2011**, *83*, 77–83.
- (30) Fasciotti, M.; Lalli, P. M.; Klitzke, C. F.; Corilo, Y. E.; Pudenzi, M. a.; Pereira, R. C. L.; Bastos, W.; Daroda, R. J.; Eberlin, M. N. *Energy Fuels* **2013**, *27*, 7277–7286.
- (31) Brown, L. J.; Toutoungi, D. E.; Devenport, N. A.; Reynolds, J. C.; Kaur-Atwal, G.; Boyle, P.; Creaser, C. S. *Anal. Chem.* **2010**, *82*, 9827–9834.
- (32) Brown, L. J.; Creaser, C. S. *Curr. Anal. Chem.* **2013**, *9*, 192–198.
- (33) Purves, R. W. *Anal. Bioanal. Chem.* **2013**, *405*, 35–42.
- (34) Smith, R. W.; Toutoungi, D. E.; Reynolds, J. C.; Bristow, A. W. T.; Ray, A.; Sage, A.; Wilson, I. D.; Weston, D. J.; Boyle, B.; Creaser, C. S. *J. Chromatogr. A* **2013**, *1278*, 76–81.
- (35) Smith, R. W.; Reynolds, J. C.; Lee, S.-L.; Creaser, C. S. *Anal. Methods* **2013**, *5*, 3799–3802.
- (36) Gabryelski, W.; Froese, K. L. *Anal. Chem.* **2003**, *75*, 4612–4623.
- (37) Schrader, W.; Xuan, Y.; Gaspar, A. *Eur. Mass Spectrom.* **2014**, *20*, 43–49.
- (38) Galhena, A. S.; Harris, G. A.; Kwasnik, M.; Fernández, F. M. *Anal. Chem.* **2010**, *82*, 9159–9163.
- (39) Bennett, R. V.; Gamage, C. M.; Galhena, A. S.; Fernández, F. M. *Anal. Chem.* **2014**, *86*, 3756–3763.