



J. Serb. Chem. Soc. 78 (11) 1729–1761 (2013)
JSCS–4530

AUTHORS' REVIEW

Ion selective electrodes in environmental analysis

ALEKSANDAR RADU^{1*‡}, TANJA RADU^{2‡}, CHRISTINA MCGRAW^{3‡}, PETER DILLINGHAM⁴, SALZITSA ANASTASOVA-IVANOVA^{5‡} and DERMOT DIAMOND⁶

¹*Keele University, Birchall Centre and Environment, Physical Sciences and Mathematics (EPSAM) Research Institute, Lennard-Jones Labs, Stoke-on-Trent, ST5 2BG, United Kingdom,* ²*Loughborough University, School of Civil and Building Engineering, Loughborough, LE11 3TU, United Kingdom,* ³*Institute for Marine and Antarctic Studies (IMAS), University of Tasmania, Private Bag 129, Hobart 7005, Tasmania, Australia,* ⁴*University of New England, School of Science and Technology, Armidale, Australia,* ⁵*Queen Mary University London, School of Engineering and Mathematical Sciences, London, E1 4NS, United Kingdom and* ⁶*National Centre for Sensor Research, CLARITY Centre for Sensors Web Technologies, Dublin City University, Dublin 7, Ireland*

(Received 29 August, revised 26 September 2013)

Abstract: An overview is given dealing with the application of ion-selective electrodes (ISEs) in environmental analysis. ISEs are placed into the context of the trend of development of sensors for extensive and frequent monitoring. Discussed are the issues such as sensing platforms and their mass-production, improvement of precision, diagnostic of sensor functionality, and development of reference electrodes. Several examples of real-life application of ISEs in environmental analysis are given. The main emphasis of this article is directed towards summarizing recent results of the authors during the past several years.

Keywords: potentiometric sensors; wireless sensing networks; reference electrode; sensor precision.

CONTENTS

1. A BRIEF HISTORY OF ION SELECTIVE ELECTRODES
2. THE PLACE OF ISEs IN ENVIRONMENTAL ANALYSIS
3. SENSING PLATFORM DESIGNS AND EXAMPLES OF APPLICATION OF ION SELECTIVE ELECTRODES IN ENVIRONMENTAL ANALYSIS
 - 3.1. *Liquid-contact ISEs*

* Corresponding author. E-mail: a.radu@keele.ac.uk

‡ During the execution of parts of this work, these authors were at Dublin City University, Ireland.

doi: 10.2298/JSC130829098R

- 3.2. *Solid-contact ISEs*
- 3.3. *Screen-printed ISEs*
- 3.4. *Development of simple all-solid-contact potentiometric systems*
- 3.5. *Wireless sensing networks*
- 4. IMPROVING THE PRECISION OF ISEs
 - 4.1. *Modelling the response curve*
 - 4.2. *Calibration and precision of ISEs*
- 5. REFERENCE ELECTRODE
- 6. REDUCING THE NEED FOR CALIBRATION AND DIAGNOSTIC OF SENSOR FUNCTIONALITY
 - 6.1. *Reducing the need for calibration by producing sets of identically performing sensors*
 - 6.2. *Diagnostic of sensor functionality*
- 7. FUTURE TRENDS
 - 7.1. *Technology*
 - 7.2. *Analytical methodologies*
 - 7.3. *Materials*
- 8. CONCLUSIONS

1. BRIEF HISTORY OF ION SELECTIVE ELECTRODES

Ion-selective electrodes (ISEs) are one of the oldest classes of chemical sensors. Described for the first time by Cramer in 1906,¹ they entered into routine laboratory practise with Beckman's invention of the pH-sensitive glass electrode in 1932.^{2,3} Today, there is hardly any chemistry laboratory that does not have a pH electrode. It is estimated that the market for pH electrodes is worth nearly a billion USD annually.⁴

The golden age of ISEs started in the 1960s with the discovery that some antibiotics are capable of selective binding of particular ions. The group of Simon utilised valinomycin, monensin and nonactin to make potassium, sodium and ammonium selective electrodes, respectively.⁵⁻⁷ This was quickly followed by the realization that other compounds could be utilized and/or synthesized for the purpose of binding selected ions. The word "ionophores" was specially coined for such compounds. The 1960s and 70s were the time of exponential growth in the field of ISEs, so much so that Orion (a company that almost exclusively worked on development of new ISEs) featured "electrode of the month".^{2,3} Being responsive only to the bioavailable ion fraction, having excellent ability to discriminate ions of interest *versus* other ions, and having suitable sensitivity and quick response time, ISEs based on ionophores demonstrated sensing characteristics that were excellently suited for application in clinical analysis. The most valuable application was in the analysis of blood electrolytes, such as Na⁺, K⁺,

Ca^{2+} , Mg^{2+} , and Cl^- . It is estimated that market for ion-sensor-based analysers was worth >3 billion USD in 2011.⁸

After the initial excitement, the pace of the development in the ionophore-based sensors field slowed and by the 1990s, the common opinion was that there were no significant discoveries left to be made.⁹ Fortunately, a few groups continued to pursue further research in the field in the late 1990s and early 2000s. The thorough re-examination of past practices completely revolutionized the field when it was realized that the existence of inner membrane ion fluxes introduce significant bias in the determination of selectivity coefficients and underestimated of limits of detection (LODs).^{9–11} Previous definitions of the mechanisms of response were re-evaluated and re-defined. Consequently, selectivity and sensitivity were improved by up to 6 orders of magnitude.¹² It is noteworthy that such an unprecedented feat was achieved simply by slight alteration of the experimental protocol – no additional instrumentation was introduced. Descriptions of important factors that influenced such great advantages and the corresponding experimental protocols exceed the scope of this review and the curious reader is advised to read some of the many reviews written on these topics.^{10,11,13–16}

The achievements that led to *LODs* in part-per-billion (ppb) and part-per-trillion (ppt) levels and excellent selectivity greatly expanded the application fields of ISEs. This paper reviews the efforts that the authors invested in optimization of ISEs for environmental analysis and give few thoughts on possible future directions of development.

2. THE PLACE OF ISEs IN ENVIRONMENTAL ANALYSIS

In his *Analytical Chemistry* editorial, Prof Royce Murray analysed challenges that environmental analytical chemistry is facing. He said that “A ‘Grand Challenge’ posed for analytical chemistry is to develop a capability for sampling and monitoring air, water, and soil much more extensively and frequently than is now possible. Such goals will require improvements in sampling methodology and in techniques for remote measurements, as well as approaches that greatly lower per-sample and per-measurement costs”.¹⁷ In order to address this challenge, chemical sensors need to be simple, sensitive, and very cheap. The latter is arguably the most difficult, since there are many factors that dictate the cost of sensors. For example, from a technological perspective, ISEs need to: a) be produced on a mass-scale, b) require very simple electronic circuitry and c) require minimal power for operation. From a chemistry perspective, sensors have to: a) show great long-term stability (minimal drift over time), b) be resistant to biofouling, c) have sufficient selectivity to distinguish analyte of interest from all of the interferences in the sample and d) have sufficient accuracy and precision. These are all very significant challenges and many research groups are spending

significant amounts of time, energy and resources addressing them. As an illustration, there have been more than 1100 reviews published since 2010 on the topic of Environmental Analysis, 21 of these involving potentiometric sensors; however the avid reader is invited to read reviews by Diamond and De Marco that discuss the issues arising from the application of ISEs in environmental analysis.^{15,18}

Phenomenal improvements of detection limits re-ignited the excitement in the field of ISEs and brought tremendous amount of optimism for the expansion of the utility of ISEs. From a technique that was largely constrained to blood electrolyte analysis, improved LODs opened opportunities that were considered previously unreachable, such as environmental analysis. Table I compares Detection limits of ISEs are compared Table I with those of the most widely used instrumental techniques in elemental environmental analysis. As a reference, the last column contains EPA action levels for drinking water. Clearly, the detection limits of ISEs are very competitive with the most sensitive techniques and sufficient for the determination of drinking water quality.

TABLE I. Detection limits in ppb for selected ions obtainable using flame atomic absorption spectrometry (FAAS), graphite furnace atomic absorption spectrometry (GFAAS), inductively coupled plasma mass spectroscopy (ICPMS) and ion selective electrodes (ISE) as well as action levels for selected ions in drinking water

Method/element	FAAS	GFAAS	ICPMS	ISE	EPA
Ag	1.5	0.02	0.005	0.1 ¹⁹	50
Ca	150	0.01	0.5	0.1 ²⁰	
Cd	1.5	0.003	0.005	0.01 ²¹	10
ClO ₄ ⁻	–	–	–	3 ²²	1 ^a
Cu	1.5	0.1	0.005	0.01 ²³	1300
Cs	5	–	0.01	1 ²⁴	–
K	3	0.008	0.5	0.2 ²⁵	–
I	–	–	1	0.25 ²²	–
Na	0.3	0.02	0.05	0.7 ²⁶	–
Pb	15	0.1	0.001	0.001 ¹²	50
NH ₄ ⁺	–	–	–	0.2 ²⁵	100 ^b

^asuggested; ^bdependent on pH and *T*

In addition to competitive detection limits, ISEs carry some other great advantages regarding the analysis of trace metals in the environment. Perhaps the most significant one is their ability to sense “free” ion activity. Uptake of ions by biota and the ion toxicity is dependent on the free ion content²⁷ and ISEs are an excellent tool for monitoring the impact of trace metal inputs into the environment. Moreover, acidification of natural samples is expected to mobilize ions from their complexes thereby allowing the determination of the “total” ion concentration. Consequently, ISEs can be an extremely powerful research tool that

can allow the simultaneous monitoring of metal inputs (reflected by their total concentration) and the bioavailability of these inputs (reflected in the level of “free” metal), thereby providing environmental scientists with a monitoring dataset that is rich in chemical information.

Attractiveness of ISEs for environmental analysis also lies in the simple and inexpensive instrumentation. ISEs are used in potentiometric setup where the potential of the indicator electrode (ion selective electrode) is measured against a reference electrode under zero-current conditions. Simple and inexpensive instrumentation as well as simple measurement principles and portability make ISEs suitable for on-site, ship-board, *in situ* field analysis. Notwithstanding highly attractive examples of application of ISEs in environmental analysis (some of which will be mentioned later in this review), here a curious example of the application of ISEs in space research is mentioned. The Phoenix spacecraft landed on Mars on 25th May 2008 carrying a Wet Chemistry Laboratory (WCL) among other instrumentation. The WCL contained ISEs for Ca^{2+} , Mg^{2+} , K^+ , Na^+ , NH_4^+ , H^+ and halides, Cl^- , Br^- and I^- . While the elemental composition of the Martian surface had been measured on previous expeditions using X-ray fluorescence, soil analysis using ISEs enabled of the solution chemistry of Martian soil to be studied, which led to insight into possible biological activity, pre-biotic organic synthesis and the thermo-physical properties of any liquid solution.²⁸

Another very attractive feature of ISEs is that they are unaffected by colour and turbidity. The ISEs have been successfully utilized in direct analysis of milk and processed cheese,^{29–31} while Fig. 1 depicts an experiment utilizing ISEs for the determination of nutrients in a sample containing 10 mass % organic solid matter (unpublished data).

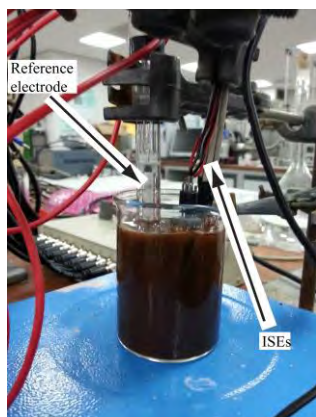

Fig. 1. ISEs in the determination of nutrients in a sample containing 10 % solid matter.

ISEs are extremely versatile chemical sensors. Today, there are more than 60 ions for which ISEs have been described.³² They are one of the very few instrumental techniques capable of the determination of both positive and negative

ions. Moreover, ISEs have the ability to detect both monatomic (Na^+ , Cl^- , Pb^{2+} , *etc.*) and polyatomic ions (SO_4^{2-} , CO_3^{2-} , ClO_4^- , *etc.*). Since both cations and anions have significant importance in the environment, the ability to utilize the same instrumental setup for both groups of analytes can significantly reduce the cost of the total analyses.

By analysing the aforementioned properties, it is clear that ISEs have many very attractive properties suitable for application in environmental analysis. Herein, the work that this group of authors undertook will be presented in order to demonstrate such applications and to address some of the issues mentioned in the opening paragraph of this section.

3. SENSING PLATFORM DESIGNS AND EXAMPLES OF APPLICATION OF ION SELECTIVE ELECTRODES IN ENVIRONMENTAL ANALYSIS

ISEs utilize extremely simple experimental setup where the potential of indicator electrode is measured against reference electrode under zero-current conditions. The potential is measured by a simple voltmeter with high input impedance. Simple electrodes and their accompanying electronic circuitry for data acquisition present an excellent basis for the development of an extremely cheap (ideally disposable) sensing system that can be deployed for *in situ* analysis. However, the current costs of commercially available ISEs (EUR 600–800 at www.sigmaaldrich.com) prohibit their integration into autonomous field-deployable sensing systems. It is therefore critical to develop methods for mass-scale production hence significantly lowering the cost per electrode.

Based on the utilized material, ISEs can be grouped into three categories:

Glass electrodes – glass was the material used to describe and develop first ISEs; however glass-based electrodes are limited to very few ions (*e.g.*, H^+ , Na^+ and K^+).²

Solid-state ISEs – based on low soluble salts of the ion of interest and while they have been actively and very successfully utilized in environmental analysis,^{15,33–35} their mechanism of response limits the number of ions for which electrodes can be developed.

Ionophore-based polymer membrane ISEs, the most versatile and the focus of many research groups, hold the most promise for expansion into environmental analysis. They can be constructed as:

- liquid-contact electrodes and
- solid-contact electrodes.

The following text discusses liquid- and solid-contact electrodes from the standpoint of the construction of the sensing platform and related issues in regards to their application in environmental analysis. The utilization of screen-printing technology for the mass-production and integration of sensors into large wireless sensing networks (WSNs) is also discussed.

3.1. Liquid-contact ISEs

In traditional ISEs, the polymeric membrane establishes the contact with the solid electrode *via* an aqueous layer (typically referred to as the inner filling solution) that contains a solution of the ion of interest. In the works of Bakker, Buhlmann and Pretsch in the late 1990s, it was realized that ion fluxes in the membrane have deterministic effect on its response.^{9,10,13} Reducing the activity of primary ion in the inner filling solution was suggested as a suitable solution for reducing the membrane fluxes. This required slight modification of the experimental setup; the single-compartment housing inner filling solution had to be split in two. The compartment at the inner solution–membrane phase boundary contained a solution of primary ions buffered to a very low activity (nano-molar or lower). This compartment was in contact with the one containing milli-molar amounts of a Cl⁻-containing solution in contact with the Ag/AgCl inner reference. A very simple solution was suggested; two pipette tips were used to hold the two compartments of the inner solution and the membrane was glued on PVC tubing attached to distal end of the bottom compartment, as shown in Fig. 2A.

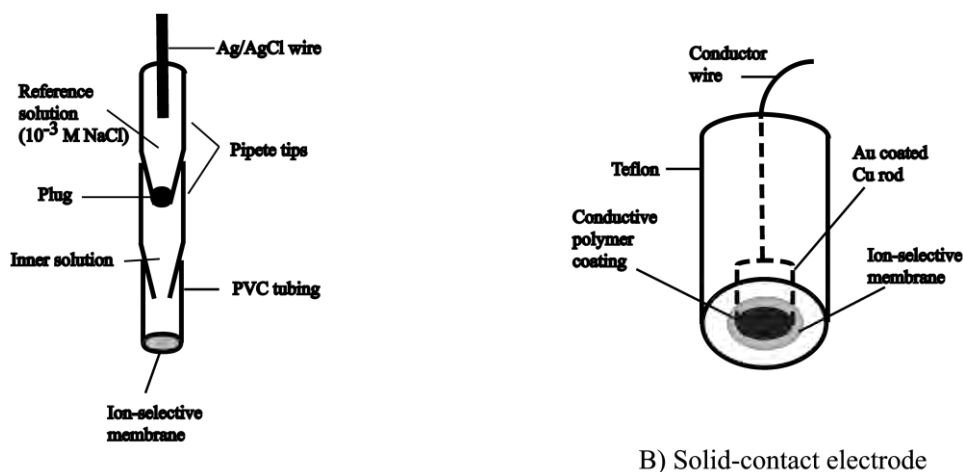

A) Liquid-contact electrode

Fig. 2. A) Construction of liquid-contact electrode. B) Construction of solid-contact electrode.

Such a construction had a two-fold impact on ISEs. By reducing the activity of the primary ions in the inner filling solution, the membrane fluxes were indeed reduced, which resulted in a drastic reduction of the *LOD*. Moreover, it demonstrated the possibility for drastic cost reduction of ISE as a sensing platform. In the seminal paper by Ceresa *et al.*, a pipette tip-based ISE was used to measure Pb²⁺ in Zurich's drinking water. The obtained results were evaluated with ICPMS and excellent correspondence between the two techniques was evidenced.³⁶ A

period of vigorous research into factors affecting the optimisation of membrane fluxes ensued. Some of the authors of this paper contributed to the general discussion by publishing a set of guidelines for the improvement of *LODs*.²⁰ In addition, the first ISE for measurement of fission products in natural water²⁴ was demonstrated. A range of Cs⁺-selective ionophores and cation exchangers were investigated in order to develop a Cs-selective electrode with a trace level *LOD*. An ion-exchange resin was utilized to buffer Cs⁺ in the inner filling solution to nano-molar levels and an *LOD* of 1 ppb was achieved. This electrode was used to demonstrate the feasibility of determination of Cs⁺ in the presence of Sr²⁺ in natural waters since these two ions are expected to pose the most significant threat to public safety in the case of detonation of a radiological dispersal device or a so-called “dirty bomb”.

3.2. Solid-contact ISEs

Very quickly after the invention of the ionophore-based ISEs, Cattrall suggested the complete removal of the inner filling solution and reported the so called “coated wire” ISE.³⁷ However, such electrodes showed significant signal instabilities and found very limited application. In the seminal paper by Fibbioli *et al.*, these instabilities were assigned to the formation of a thin water layer between the membrane and the metal electrode.³⁸ This aqueous layer behaves as a reservoir the composition of which can change upon sample changes, leading to drifting potentials. The addition of a lipophilic intermediate layer that could define redox couple and prevent the formation of water layer between the membrane and electrode was suggested and redox-active self-assembled monolayers and conductive polymers (CPs) emerged as a suitable solution.^{39,40} A period of very intensive research followed these discoveries. Consequently the selectivity, sensitivity, robustness and response time of solid-contact electrodes approached those of liquid-contact electrodes and opened the possibility for their utilization in environmental analysis.^{41–48} A schematic representation of a typical solid-contact ISE utilizing CP as an intermediate layer is depicted in Fig. 2B.

Liquid- and solid-contact electrodes were evaluated and compared for application in soil analysis.⁴⁹ This research was part of the work on development of chemical sensors for long-term *in situ* deployment for frequent monitoring of airborne dust polluted with heavy metals. Major dust blows of heavy metal-contaminated soil from the Gortmore Tailings site of an abandoned mine near Silvermines, Co., Tipperary, Ireland, were connected with cattle death in the 1980s. Later, several governmental reports showed that about 20 % of the agricultural soil samples collected near the Silvermines had levels of heavy metals up to 30 times higher than the average values for Irish soils.⁴ Therefore, there was an urgent need for high-frequency, real-time and *in situ* monitoring of heavy metals in airborne dust. Due to their properties, ISEs were suggested as detectors in the

monitoring device. However this type of application highlighted several issues, including bias at low analyte concentrations and unsuitable soil digestion techniques. The issue of utilization of the entire response curve to reduce bias will be discussed in the Section 4.2. Development of a suitable soil digestion technique was important since typical soil digestion techniques utilize very harsh and dangerous acids (*e.g.*, *aqua regia* or hydrofluoric acid). Finally, the potential of using solid-contact ISEs as simpler and cheaper solution relative to liquid-contact electrodes was evaluated. In the evaluation of digestion technique and suitability of solid-contact ISEs, atomic absorption spectroscopy (AAS) was used as the reference technique. It was established that short sonication of soil samples in 10^{-3} M HNO_3 mobilized a suitable amount of heavy metal ions for detection by ISEs. Solid-contact ISEs indeed showed satisfactory *LODs* and excellent correlation with AAS measurements was obtained.

3.3. Screen-printed ISEs

Technologies for mass-production, such as screen- and inkjet printing, have occupied an important place in sensor production.^{50–53} Development of robust solid-contact ISEs with selectivity and *LODs* almost identical to liquid-contact ones allowed progress to truly low-cost sensors *via* the utilization of such technologies. In the production of ISEs, screen-printing is typically used to produce the platform followed by the deposition of a CP and an ion selective membrane. Details of the preparation of ISEs by the screen-printed platform are given in Fig. 3.

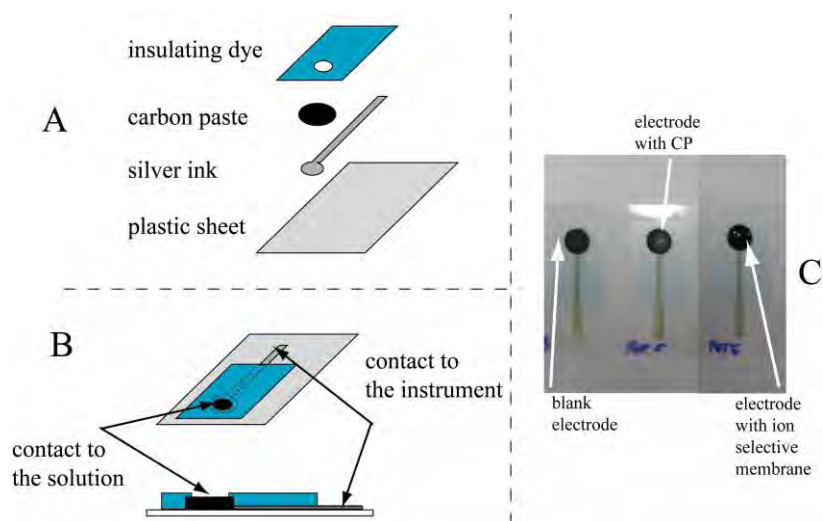

Fig. 3. A) Preparation process of a screen-printed electrode. Silver ink is printed on a plastic substrate followed by printing of carbon ink and finished by printing of an insulating layer. B) Top view and side view of the finished electrode. C) Picture of electrode (left) covered with CP (middle) and finally with an ion selective membrane (right).

Detailed characterization of such electrodes showed that their behaviour was no different to those of traditionally prepared solid-contact ISEs. They were evaluated for the analysis of Pb^{2+} in various water bodies within the city limits of Dublin, Ireland.⁵⁴ Twelve water samples were collected from the River Liffey, the Royal Canal and the Grand Canal that pass through Dublin. The sampling and sample storage was realised according to EPA recommendations.⁵⁴ The samples were acidified to pH 4 to ensure that all Pb^{2+} were present in the free, uncomplexed form. The unknown concentration of lead was determined using standard addition method and the results were evaluated using ICPMS. The obtained results are summarized in Table II.

TABLE II. Total Pb^{2+} concentration (ppb) of environmental water samples (with 95 % confidence interval) determined by ISEs using the standard addition method and ICPMS. The relative error (RE) was calculated as $RE = 100(X^{ISE} - X^{ICPMS}) / X^{ICPMS}$, where X^{ICPMS} was assumed to be the “true” value

Sample ID	Pb^{2+} (ICPMS)	Pb^{2+} (ISE)	% RE
1	0.32±0.02	0.52±0.06	-62.5
2	0.51±0.04	0.66±0.08	-29.4
3	1.67±0.08	1.65±0.09	-15.6
4	1.98±0.07	2.07±0.09	1.2
5	4.87±0.11	5.20±0.14	-4.5
6	1.23±0.08	1.65±0.09	-6.8
7	0.90±0.03	1.04±0.05	-34.1
8	2.14±0.07	2.61±0.09	22.0
9	9.68±0.25	10.1±0.1	-3.3
10	2.90±0.11	2.61±0.30	10.0
11	5.52±0.18	6.55±0.05	-18.7
12	172±12	207.20±0.14	-20.2

It is striking that the two sets of data closely correspond over the full range of samples even though for 11 out of the 12 results, the lead concentration was below 10 ppb (50 nM). While the relative error (RE) may appear high in some cases (samples 1, 2, 7 and 8 have $RE > \pm 20\%$), it should be appreciated that in every case, the lead concentration was ≤ 2 ppb, which is just at the LOD as defined by the IUPAC. As discussed in the Section 4, large RE are expected due to the bias introduced by estimating unknown concentrations using linear regression. These results have important implications in further application of ISEs in quality control of surface waters. Considering that the European Water Framework Directive recommends a concentration of 7.2 ppb for Pb^{2+} as the upper limit for surface waters, and that 10 out of 12 samples had concentrations below this limit, the ISEs can be suitable for use as detectors in very low-cost early warning systems.

3.4. Development of simple all-solid-contact potentiometric system

Development of polymer membrane-based liquid junction-free reference electrodes (please see Section 5) allowed the construction a simple all-solid-contact potentiometric system and its use in the determination of Pb^{2+} speciation in natural water.⁵⁵ Mobilization and ion speciation is dependent on pH and therefore requires pH monitoring in parallel to determination of the concentration of the ion of interest. A multi-sensor probe developed in order to house the reference electrode, polymer membrane-based pH electrode and Pb^{2+} -selective ISE is shown in Fig. 4 (top).

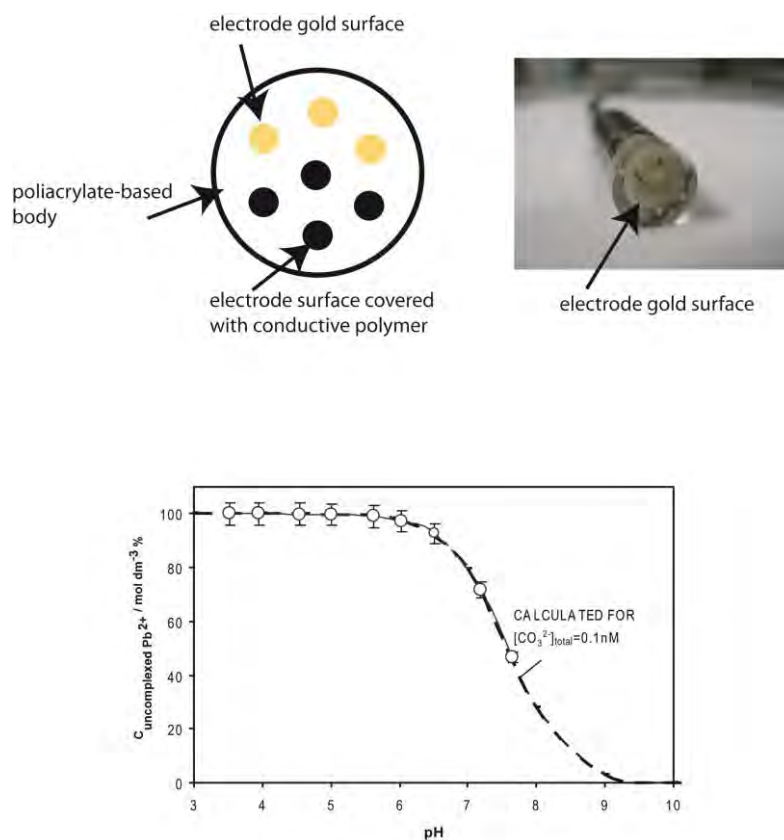

Fig. 4. Top) multi-sensor probe. Schematic representation of electrodes (left) and photo of a multi-sensor probe (right). Bottom) direct potentiometric determination of the speciation of lead in deionized water spiked with 9.1 ppb Pb^{2+} as a function of pH. Circles: experimental data. Dashed line: fraction of uncomplexed Pb^{2+} calculated based on complexation of Pb^{2+} and CO_3^{2-} as dominant complexing anion present in the sample.

All three types of electrodes (pH- and Pb^{2+} -selective and solid-contact reference electrodes) were carefully characterized according to published proce-

dures⁵⁵ and used for the measurement of pH in deionised water, rain water, tap water and samples from natural water bodies in and around the city of Dublin, Ireland. Lead-speciation analysis was performed on the simplest sample, deionised water spiked with 9.1 ppb Pb^{2+} at various pH levels. The results where full circles are experimental results obtained by calculating the fraction of uncomplexed lead based on sample pH are illustrated in Fig. 4. The dotted line represents the theoretically calculated values taking into account lead complexation with sample ions. Excellent agreement between the experimental measurements and theoretical calculations demonstrates that the sensing array consisting of solid-contact pH- and Pb^{2+} -selective ISEs coupled with solid-contact RE could be used to accurately determine lead speciation using direct potentiometric measurements.

3.5. Wireless sensing networks

Analytical instruments are becoming smaller and more automated. In parallel, wireless communication devices are getting smaller and capable of long-term operation. Some believe that the next step in the information revolution will be driven by linking cheap sensors to microprocessors.⁵⁶ Personalized medicine and point-of-care devices are an excellent example of the integration of sensors with communication devices. Another very attractive example is the integration of sensors within clothing and the concept of “wearable sensors”.^{57,58} The concept of integration of chemical sensors with communication devices into wireless sensing networks (WSNs) is highly attractive in environmental analysis. Deployment of a very large number of extremely cheap, autonomous and mutually connected devices provides the ability to harvest much more complex data, such as origin (time and location) of pollution, speed and direction of spreading.^{59–61} However, integration of chemical sensors in WSNs is proving to be extremely challenging. This is partly due to inherent difficulties associated with field deployment of autonomous chemical sensors and partly due to usability issues of current wireless hardware platforms. In fact, of the very few literature examples of wireless chemical sensor networks (WCSNs) most are focused on the design and development of a single wireless sensing node. In a very interesting example of real deployment of multi-nodal WCSN, Shepherd *et al.* deployed LED-based pH sensors for monitoring chemical plumes.⁶²

The simplicity of ISEs and their data acquisition instrumentation motivated us to develop a wireless ISE-based autonomous sensing system.⁶³ In collaboration with the engineering team from the Diamond Group, integration of these sensing systems into WSNs was explored. A block diagram for four key system elements (wireless sensing platform, base station and data harvester (PC/laptop)) and data flow interactions is depicted in Fig. 5A. pH-sensitive ISEs were selected for the simplicity of their operation. Ion selective membranes and RE were deposited on the platform that was designed with a view of integration with a

microfluidic system where Au-based contacts were prepared by sputter-coating and encased into a plastic film. The wireless sensing platform was designed to acquire three individual ISEs against a single RE. The base station worked much in the same way as the wireless sensing platform but without the conditioning circuitry. The gathering, storage and visualisation of the data on the data harvester were achieved using a purpose built control program written in the Java programming language. Figure 5B–D show a screen capture of the WISE system's front-end graphical user interface, the wireless sensing platform, and the base station.

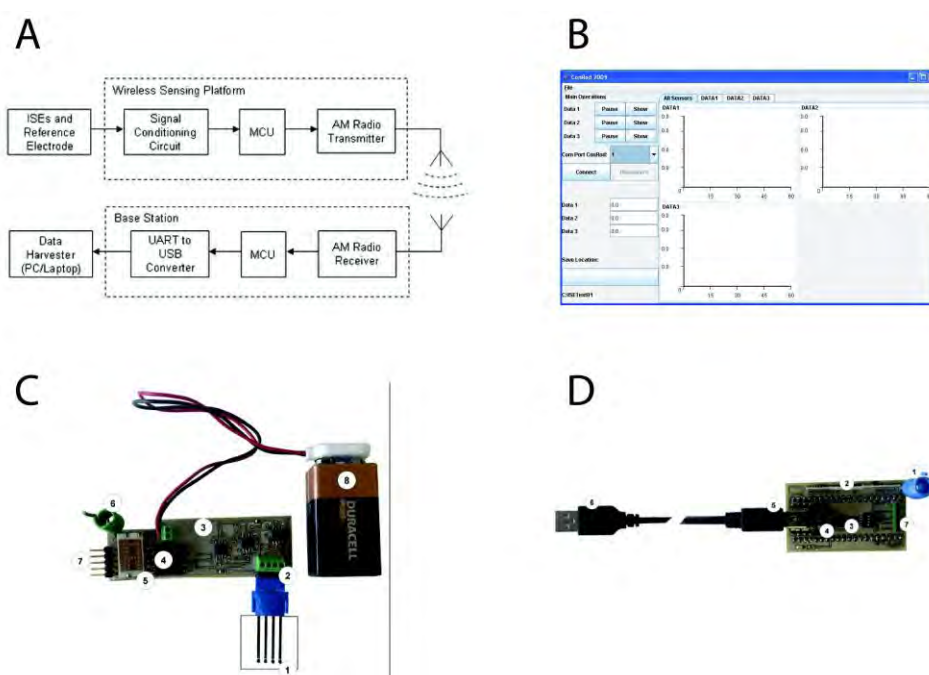

Fig. 5. A wireless ion selective electrode autonomous sensing system. A) Block diagram showing the architecture of the system and the flow of signal/data from the sensors to the data harvesting system element. B) Screen capture of the system GUI. C) PCB Implementation of the wireless sensing node. 1) screen-printed electrode, 2) terminal block interfacing the electrodes and signal conditioning board, 3) signal conditioning board, 4) interface from the signal conditioning board to the wireless transmitter, 5) wireless AM transmitter module, 6) antenna, 7) programming interface and 8) power source (PP3 9V battery). D) PCB Implementation of the base station. 1) antenna, 2) AM radio receiver, 3) PIC microcontroller, 4) USB to UART transceiver, 5) mini-B USB connection, 6) USB-A connection to PC/laptop and 7) terminal block for programming the wireless module.

Validation of the sensing system was realised by *in situ* determination of the pH of various natural water samples, including water from the Tolka River and Royal Canal flowing through the city of Dublin, Ireland. Excellent correlation of

data between WISE system and portable pH meter was achieved ($R^2 = 0.991$, $n = 8$) and the errors were low ($RE \leq 2.6\%$). These results encouraged us to develop a testing system for ISE-based WSNs. An environmental sensing chamber was developed capable of housing a model of a river with ISEs integrated on the wireless data transmission platform, as depicted in Fig. 6. The model contains a stagnant section to allow for modelling of the variation of the flow rates along the River. Sampling positions are located on strategic locations to allow for introduction of the pollutant, as well as to position sensors to enable pollution spread to be monitored. This allows monitoring of the water quality by observing the pattern of the response of the sensors (unpublished data).

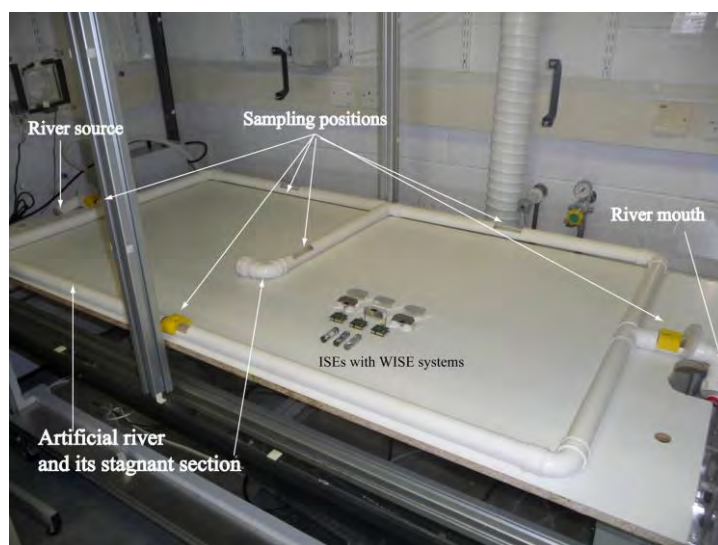

Fig. 6. Model of an artificial river developed for deployment and testing of WSNs.

4. IMPROVING THE PRECISION OF ISEs

Since the invention of ionophore-based ISEs, the characteristics of ionophores and the analytical behaviour of concomitant sensors were studied in great depth. Sets of recommendations regarding the determination of selectivity, sensitivity, calibration and nomenclature of ISEs, as critical parameters for real-life applications, were published by the IUPAC.^{64–67} However, the significant breakthroughs achieved in late 1990s and early 2000s led to an almost complete re-definition of recommendations for experimental protocols necessary for obtaining optimal selectivity and LODs.⁶⁸

As it is often the case, the opening of new research horizons highlights issues that were previously overlooked or were considered not worthy of investigation. Here, the case of the definition of *LOD* and its impact on the potential for application of ISEs in environmental analysis are considered.

The potentiometric response of ISEs, the EMF, in a solution containing mixture of ions of interest (a_I) and interfering ions (a_J) is given according to the Nikolskii–Eisenman Equation:

$$E = E^0 + \frac{RT}{z_1 F} \ln \left(a_I + \sum a_J K_{I,J}^{\text{pott}} \right) \quad (1)$$

Responses below the LOD ($a_I = 0$) have a constant value, which is ideally defined by the response of the sensor to interfering ions (a_J). $K_{I,J}^{\text{pot}}$ symbolizes the potentiometric selectivity coefficient. When the activity of the primary ions becomes sufficiently high, the term $\sum a_J K_{I,J}^{\text{pot}}$ becomes negligible and the equation is transformed into the Nernst Equation with a slope of $59.2/z_1$ mV decade⁻¹ (at 25 °C). The expected responses of ISEs are demonstrated in Fig. 7, using dotted lines to depict two extreme cases ($a_I = 0$ and $a_J = 0$).

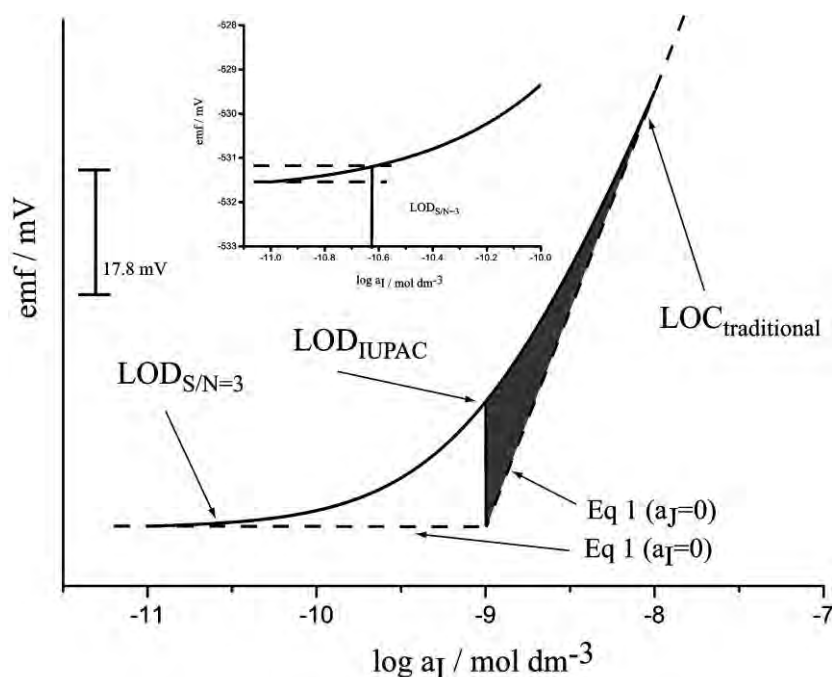

Fig. 7. Response curve of ISEs (full line) and extrapolation of the responses in the cases of $a_I = 0$ and $a_J = 0$ in Eq. (1) (dashed lines; traditional detection limit is defined as the cross-section of these two lines (LOD_{IUPAC}). Shaded area indicates the bias obtained in a determination of unknown activity if it falls in the region between LOD_{IUPAC} and $LOC_{\text{traditional}}$. Inset – illustration of the detection limit defined as signal-to-noise ratio $S/N = 3$.

The crossing-point of the two lines (10^{-9} in the figure above) is defined as the limit of detection according to IUPAC (LOD_{IUPAC}). The concentration is then estimated by the Nernst Equation above LOD_{IUPAC} . Due to the substantial

bias between the ISE response (Eq. (1)) and the Nernst Equation near LOD_{IUPAC} (shaded area of Fig. 6), ISEs have been considered useful only if the lowest expected level of target analyte is about an order of magnitude higher than the LOD . Such a value can be defined as the limit of quantification (LOC). This was quite acceptable in clinical analysis where levels of blood electrolytes are typically 2–3 orders of magnitude higher than traditionally achievable $LODs$. However, the prospect of application of ISEs in environmental analysis increased the importance of utilization of the entire response curve and required improvement of the precision of the determination at levels near the LOD . The luxury of neglecting a usable signal above the noise levels is not acceptable for *in situ* deployed devices. Therefore it is critical to work on methodologies that would utilize the entire response curve, eliminate the bias introduced by the curvilinear response range and improve the precision of analysis. If an ISE with noise ≈ 0.1 mV is considered and the general analytical chemistry definition of LOD (three times the standard deviation of noise, $LOD_{S/N=3}$) is used, then the LOD is orders of magnitude lower than LOD_{IUPAC} . Furthermore, if the bias is eliminated, then quantification can extend all the way to $LOD_{S/N=3}$.

4.1. Modelling the response curve

One solution to the problem of biased results near the LOD is utilizing theoretical models of the ISE response.^{19,69} These allow modelling of the entire response curve using experimentally available parameters, hence eliminating the bias due to the deviation from the straight line. Unfortunately, such models are limited only to liquid-contact electrodes since currently there is no suitable experimental methodology to obtain certain parameters in solid-contact electrodes. Current trends of miniaturization of ISEs and transition to solid-contact electrodes (for more details on solid- and liquid-contact electrodes please read the section Sensing Platform Designs) dictate that until such methods are developed, non-linear empirical formulas are more suitable for modelling the full response of ISEs. In our work we have used the following formula:

$$E = E^0 + \beta_1 * \log(a_1 + \beta_2) + \varepsilon \quad (2)$$

Equation (2) represents Eq. (1) where β_1 is equal to the slope parameter related to the temperature and charge of the primary ion, a_1 is the activity of the primary ion, β_2 relates to the selectivity and activity of interfering ions and the error ε is assumed to follow a normal distribution with variance σ^2 .

An added benefit of non-linear modelling of the entire response curve is the ability to obtain a revised LOD defined by the signal-to-noise ratio (*i.e.*, $LOD_{S/N=3}$). This ultimately expands the useful range of ISEs by more than two orders of magnitude (see the span from $LOD_{S/N=3}$ to $LOC_{traditional}$ in Fig. 7), while simultaneously removing the bias near the LOD . The benefits of using the entire response curve and $LOD_{S/N=3}$ vs. a traditional analysis were explored by

comparing the analysis results using data from ISEs in a soil analysis.⁴⁹ The empirical model (Eq. (2)) and $LOD_{S/N=3}$ were used to determine the level of Pb in digested soil samples. The results were then compared to results obtained using the traditional treatment (*i.e.*, using linear regression in the Nernstian range above LOD_{IUPAC}), and to reference results obtained using AAS. As expected, the results did not differ in the case of samples containing values of Pb falling in the Nernstian response range. However, in two cases, the values of the sample were in the curvilinear part of the response curve. With the linear regression treatment, results were rendered biased and/or below LOD . However, by utilizing non-linear regression the bias was removed and the results approached the reference results obtained using AAS. That is, it was possible to extend the useful range of the ISEs simply by using Eq. (2) and $LOD_{S/N=3}$ in place of the Nernstian approximation and LOD_{IUPAC} .

4.2. Calibration and precision of ISES

Unlike other analytical techniques, ISEs have an extremely large measurement range. Hitherto, the largest reported spans twelve orders of magnitude,¹² although measurement ranges spanning eight to nine are more common. Unfortunately, this benefit is offset by lower precision. The slope of $59.2/z$ mV decade⁻¹ and the noise in the region of 0.1 mV indicate that reporting results with more than two decimal places may be quite problematic. Therefore, ISEs are typically considered as a tool for routine measurements and as early warning systems.

On the other hand, typical ISE calibration protocols used in estimation of unknown activities of analytes provide only a single value for measured activities (for both calibration point and unknown sample) not estimates of measurement uncertainty. Since no estimate of uncertainty is given, these so called “point estimates” imply a level of precision that is not achieved with ISEs. With increased importance of ISEs in environmental analysis, estimates of precision become critical, especially in the analysis of samples in which the values approach regulatory limits. In this respect, methods of statistical calibration are becoming increasingly popular in the analysis of chemical data,^{70,71} including ISEs.⁷²

A very interesting approach to statistical calibration is the use of a Bayesian model for the non-linear response of ISEs.⁷³ The power of this approach is that realistic estimates of measurement uncertainty are returned and information from redundant ISEs can be used to easily improve measurement precision and to identify and discard data from failing electrodes.

Bayesian statistical analysis is based on the concept of prior knowledge or beliefs about random variables ($\Pr(A)$) being combined with a model relating data to those variables ($\Pr(B|A)$) to form updated beliefs about the variables, given the collected data ($\Pr(A|B)$). The updated beliefs are called the posterior probability distribution of event A given event B. This can be present as:

$$\Pr(A|B) \propto \Pr(B|A)\Pr(A) \quad (3)$$

In the context of ISE calibration, A represents the unknown variables (analyte concentrations and calibration parameters), while B represents the data (all calibration data and sample emf values).

A model for single or multiple ISEs being used to measure the same sample was developed and extended to include standard addition data.⁷³ Inclusion of multiple ISEs increases the overall precision of the analysis even though each ISE will have different calibration parameters and levels of precision. This is done by down-weighting poor-performing ISEs and incorporating asymmetry in calibration intervals into the final calibration interval. Inclusion of standard addition data minimizes bias due to electrode drift. The method was developed using the OpenBUGS variant (version 3.0.3) of BUGS, linked to R using the R2WinBUGS library and the code is available in Dillingham *et al.*⁷³ Moreover, additional software was developed in R (www.r-project.org) to create a user-friendly implementation of these models, and is available, along with a tutorial, at: <http://turing.une.edu.au/~pdilling/calibration.html>. The Bayesian calibration method was used to analyse levels of lead in 17 soil samples collected from the abandoned mining site near Silvermines, Co., Tipperary, Ireland. The standard technique was used to collect and store samples that were digested by sonication of 1 g of sample in 1.0×10^{-3} M nitric acid. This method of digestion was shown to be a good compromise between satisfactory detection limit, sufficient extraction of metal ions from the soil and limited effect on the ISE lifetime.⁷⁴

Results using ISEs were obtained using the standard addition method. Briefly, the calibrated electrodes were immersed in a predetermined volume of the sample. After a baseline had been recorded, an aliquot of standard Pb^{2+} solution was added and a second reading was obtained and the unknown activity of Pb^{2+} was calculated.

Figure 8 depicts estimates of Pb^{2+} in the soil samples using three individual ISEs (Fig. 8a–c) compared with the ones obtained when all three ISEs were incorporated into the multiple-ISE model (Fig. 8d).

By observing the error bars, it could be seen that long tails, asymmetry, and extreme variability in the width of calibration intervals considerably decreases in the multiple-ISEs model. Although the ISEs varied substantially in response and $LOD_{S/N=3}$, the final estimate was much more precise than the estimate from any single ISE. This shows that the final precision of the multiple ISE model was not driven by one ISE of high quality, but took advantage of information from each electrode. Fig. 8 also shows that the ISE with the lowest $LOD_{S/N=3}$ is not necessarily the best ISE to use when making single ISE measurements. Although ISE#3 has nearly an order of magnitude better estimated LOD than the other two electrodes, it was much noisier and therefore gave less precise estimates. By

combining the response of all three electrodes, the model takes advantage of the low $LOD_{S/N=3}$ of ISE#3 and the high precision of ISEs#1 and #2. It should be noted that the appropriate LOD for the multiple ISE model is unclear and the lowest $LOD_{S/N=3}$ is displayed for reference only.

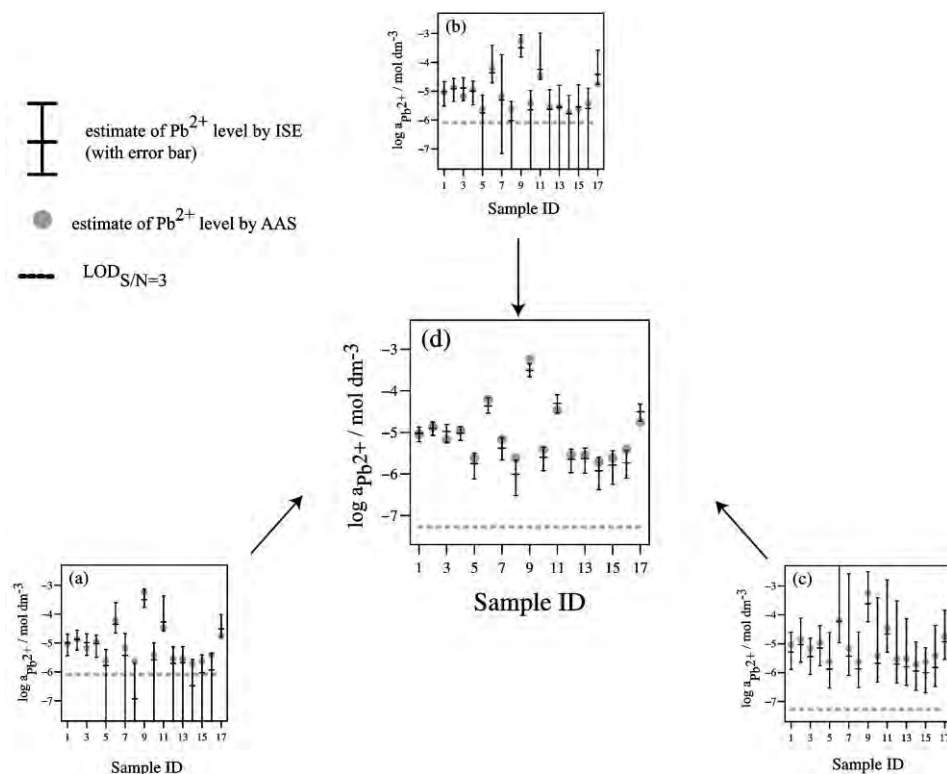

Fig. 8. Estimations of Pb^{2+} in each soil sample from individual ISEs (a–c) and the combined response (d) using standard addition. The error bars indicate 95 % confidence intervals; mid-line dashes indicate the point estimate obtained by the ISEs. The closed circles are estimates obtained using AAS. $LOD_{S/N=3}$ (dashed line) are presented for comparison.

5. REFERENCE ELECTRODE

Interestingly, while the research in the field of ISEs and their application in environmental analysis are vigorous, the pace of the transition from controlled laboratory conditions to the real-life application does not follow the amount of breakthroughs in ISEs' performance. This is partly related with the need for collaborative effort between chemists and mechanical and electronic engineers in order to develop deployable devices capable of autonomous sensing.^{61–63,75}

Another factor inhibiting progress is often the unsatisfactory robustness of reference electrodes (REs). While there are many examples of design and application of reference electrodes in deployable and/or miniaturized sensing devices,

they are often limited to a particular design and/or application. The limitations may be grouped around the mechanism of action of REs and their fabrication. In a review of REs, Bakker nicely outlines several concepts of their action mechanisms. One of the most promising is the one based on the phase boundary potential equation:

$$E_{\text{PB}} = \frac{RT}{z_1 F} \ln \left(\frac{k_1 a_1}{\gamma [I^{z_1}]} \right) \quad (4)$$

where a_1 is the activity of an ion of charge z_1 in the sample phase boundary, γ_1 , and $[I^{z_1}]$ are the activity coefficient and the concentration of the free ion I^{z_1} in the organic membrane phase boundary, and R , T , and F are the gas constant, the absolute temperature and the Faraday constant, respectively. The E_{PB} in this system is defined by the degree of partition of the lipophilic electrolyte from the membrane into the sample. In essence, the membrane is doped with a lipophilic electrolyte capable of partitioning into the sample. Since the ions of the used electrolyte are not present in the sample, the concentration of ions in the membrane and in the sample is constantly rendering the E_{PB} of the RE constant, thus enabling its use as the RE. This basic idea was used by several authors to demonstrate simple REs, for example by doping a membrane with lipophilic salts.^{76–80}

In order to achieve truly low-cost potentiometric sensor fabrication of REs, they must be simple, cost-effective, and compatible with mass-production techniques. Ideally, the fabrication of both ISEs and REs should be compatible with the existing production lines with minimal adjustments.

Our approach to development of new REs consisted of tackling both issues simultaneously.⁸¹ Encouraged by the success in the development of miniaturized platforms suitable for mass-production based on the screen-printing technology (as described in the Section 3), we were driving the development of REs that could utilize the same platform as ISEs. The aim was to fabricate both electrodes using identical platform and prepared using the same protocol. In the preparation of REs, the aim was to use a material that acts as a matrix and serves as the source of ions that could partition into the sample, thus defining E_{PB} , instead of doping the membrane with a lipophilic electrolyte. Ionic liquids (ILs) are excellent candidates for such materials. It was shown that they can behave as plasticizers,⁸² simple salt bridges and liquid-junction-free REs.^{83–85} In continuation of these ideas, we experimented on the use of a variety of ILs containing imidazolium ([Rmim] where R stands for C₂, C₄, C₆, C₈ or C₁₂ substituents at position 1), phosphonium ([P_{4 4 4 14}]⁺ or [P_{6 6 6 14}]⁺) and ammonium ([N_{1 8 8 8}]⁺) cations and the bis(trifluoromethanesulphonyl) amide [NTf₂][−] anion. The membranes were prepared by mixing an appropriate IL with PVC in the traditional mass ratio 66:33 of plasticizer. It was found that [C₂mim][NTf₂] showed the best performance as a RE. The responses of [C₂mim][NTf₂]-based RE compared to com-

mercially available Methrom Ag/AgCl double junction and solid-state (REFEX Sensors, Ltd.) reference electrodes are depicted in Fig. 8A–C. The stability of the signal was tested using three different protocols. Electrodes were tested for long-term response upon changing the concentration of the same electrolyte, the influence of larger concentration differences and mobilities of ions, and dynamic response (response occurring within seconds after the electrolyte change). The [C₂mim][NTf₂]-based RE shows remarkable stability, comparable to those of commercially available REs.

In order to demonstrate the utility of the [C₂mim][NTf₂]-based RE, it was employed in various electrochemical techniques and its performance was evaluated against the traditional Ag/AgCl double junction RE. Figure 9 depicts the application of [C₂mim][NTf₂]-based RE in potentiometry (Fig. 9D), voltammetry (Fig. 9E) and electrochemical impedance spectroscopy (Fig. 9F). Excellent stability and correspondence of the signal is obvious in all three cases.

It is noteworthy that the [C₂mim][NTf₂]-based RE was prepared on a screen-printed platform by simple drop-casting of the membrane components, as explained in the Section 3. This allows preparation of a disposable potentiometric sensing system where both electrodes (ISE and RE) are prepared using the same protocols (drop-casting membrane cocktail on the identical platform). Advances in ink-jet printing of polymers could further simplify the process and result in fully automated, mass-production of extremely low-cost, yet ultra-sensitive potentiometric sensing systems.

6. REDUCING THE NEED FOR CALIBRATION AND DIAGNOSTIC OF SENSOR FUNCTIONALITY

The need for regular calibration and the cost associated with it is the major limitation in development of fully autonomous sensing devices. There are issues from the point of view of electronic platforms (matching of hierarchies, data safety, *etc.*) as well as from a chemistry perspective (*e.g.*, cost issues mainly associated with calibration involving calibration solutions, pumps, waste, *etc.*).⁷⁵ Many different groups are exploring a wide variety of approaches to develop sensors with reduced need for calibration or completely calibration-free sensors.⁸⁶ The subject of a completely calibration-free sensor is somewhat esoteric since all sensors need calibration at least at some point. Some interesting concepts have emerged that suggest using materials the properties of which can be switched using external stimulus in the description of calibration-free sensors.^{59,87–90} However, with regards to the employment of ISEs in environmental analysis, some technological solutions for significantly reducing the need for calibration have been explored.

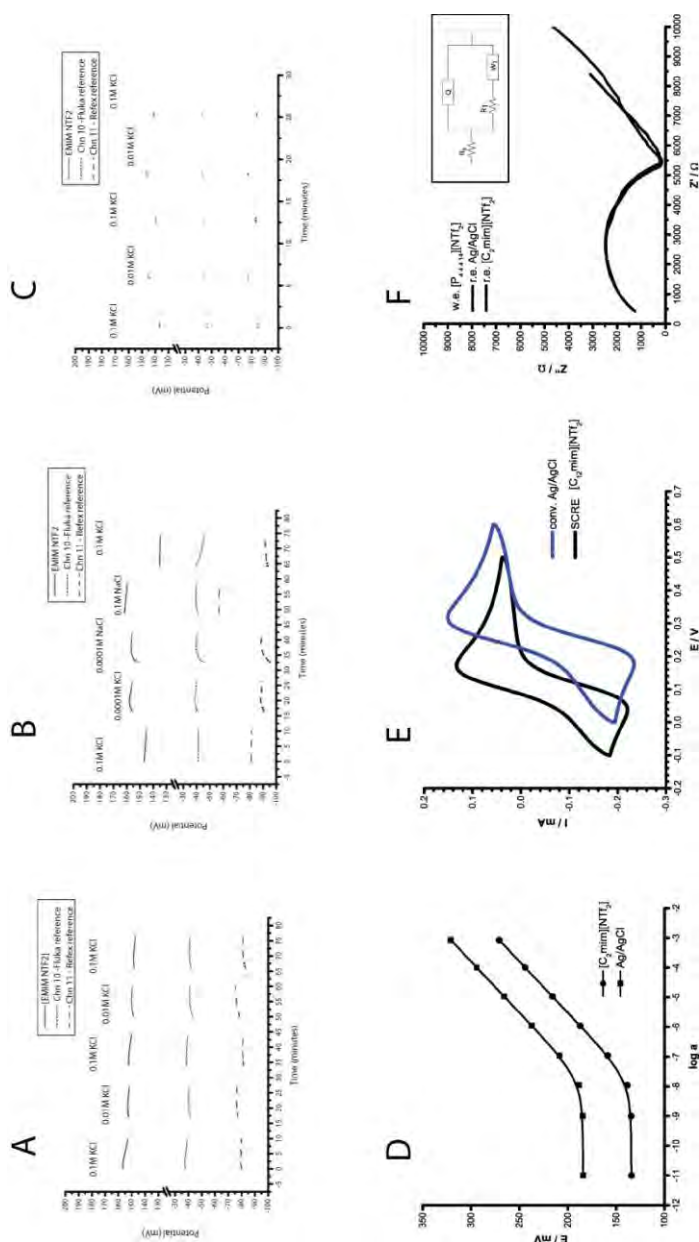

Fig. 9. Top: potentiometric responses of a [C2mim][NTf2]-based SCRE (full line) compared with responses of Methrom Ag/Ag/Cl (dashed line) and REFEX (dotted line) reference electrodes. A) Potential responses on the test for long-term response upon changing the concentration of the same electrolyte. B) Potential responses based on the influence of larger concentration differences and mobilities of ions. C) Dynamic response (response occurring within seconds after an electrolyte change). Bottom: Application of IL-based reference electrode in various electrochemical techniques and its comparison with traditional Ag/AgCl RE. D) IL-Based RE in potentiometry for the determination of Pb^{2+} . E) Cyclic voltammograms of the $Fe^{III}(CN)_6^{3-}/Fe^{II}(CN)_6^{4-}$ redox couple. F) Nyquist plot of the determination of Pb^{2+} in PVC-[P44414][NTf2] membrane recorded vs. IL-based RE (dashed line) and Ag/AgCl electrode (full line). Inset: equivalent circuitry used to fit the experimental data.

6.1. Reducing the need for calibration by producing sets of identically performing sensors

The introduction of technologies for the mass-production of sensors triggered the expectation of nearly identical response profile of all electrodes produced in the same batch. Reinforced by the fact that sensors produced on mass scale would be disposable, only one electrode from each batch would need to be calibrated, while all the others would be used only once with their response pattern corresponding to the single calibrated electrode. This approach is employed very successfully in the clinical area, in which single use disposable sensors are commonplace. However, the translation of this approach to the environmental arena remains difficult, due to the lower concentrations of the primary target ions and matrix effects, which require a more complex calibration protocol to enable the low-limit-of-detection capability of ISEs to be exploited. Unfortunately, it appears that obtaining solid-contact ISEs with reproducible standard potentials is still quite a challenge.¹⁴ The non-optimised protocol for the deposition of the intermediate layer and the ion selective membrane is one of the issues. The evolution of the reproducibility of the signal across a set of electrode with optimization of the polymer deposition process is shown in Fig. 10.

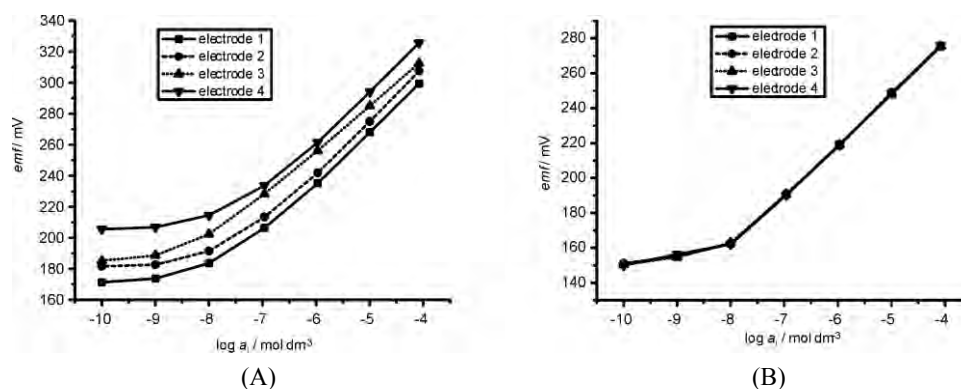

Fig. 10. Calibration curves of solid-contact ISEs. A) Without careful control of the drop-casting of conducting polymer step. B) Electrodeposited conducting polymer.

When the ISEs were produced without careful control of step of drop-casting polymers onto screen-printed electrodes, the baseline, slope and LODs are misaligned (Fig. 10A). On the other hand, careful manual deposition of intermediate layer can produce response curves that differ only in the baseline (data not shown). Finally, electrodeposition of the intermediate layer on the electrodes produced in the same batch of screen-printing results in response curves that are superimposed and with virtually no offset (Fig. 10B). These electrodes were suc-

cessfully utilized for the determination of Pb^{2+} in environmental samples, as described in the Section 3.3.

6.2. Diagnostic of sensor functionality

In another approach, the electronic signal was used to probe the performance of sensors.⁹¹ Since the response of ISEs depends on processes at sample/membrane interface, changes on the membrane surface are likely to influence the response characteristics of a device. For example, deployed sensors could be easily physically damaged due to contact with debris present in the water. Membrane components may leach and affect the bulk composition of sensing membrane. Perhaps one of the most significant factors influencing the performance of *in situ* deployed sensors is biofouling. Every year, millions of Euros are spent in active sensor maintenance and in research on combating biofouling. A common denominator of these factors is the influence they can exert on the resistance and capacitance of a membrane. Therefore, we suggested that electrochemical impedance spectroscopy (EIS) could provide important information on membrane composition and sensor functionality. We attempted to find the optimal parameters of a simple circuitry capable for the generation of an AC signal and utilize it for simple diagnostics of the functionality of a sensor and argued that the ability to very quickly and simply diagnose the functionality of ISEs without classical calibration could simplify fabrication and operation of the sensing device. Multiple sets of miniaturized, solid-contact ISEs were prepared using the screen printing technology as described elsewhere.⁵⁵ In order to mimic potential physical damage, the electrodes were punctured and cut to inflict damage to the membrane surface. For mimicking leaching of the membrane components, major membrane constituents known to be of fundamental importance for electrode response (ionophore and/or ionic sites) were intentionally excluded. Biofouling was studied by exposing electrodes to microbe-rich natural water for predestined periods. For each of the mentioned conditions, the potentiometric response was recorded together with impedance spectra analysis. The loss of potentiometric functionality was evident through the diminishing of the slope and *LOD* (Fig. 11 A–C) and could be easily related with concomitant changes in the resistance and capacitance of the membrane. By careful analysis of the impedance spectra, critical parameters could be identified for which changes in impedance could be easily related with the loss of potentiometric functionality. Specifically, it was identified that the change of impedance could be monitored at a single frequency and excitation signal. For example, Fig. 11D–F depict changes in impedance at 1 Hz with an excitation signal of 100 mV of electrodes that were subjected to severe mechanical damage, biofouling and leaching of membrane components.

The difference in time that measurable change may occur could also be an important indication of the nature of process that affects the potentiometric res-

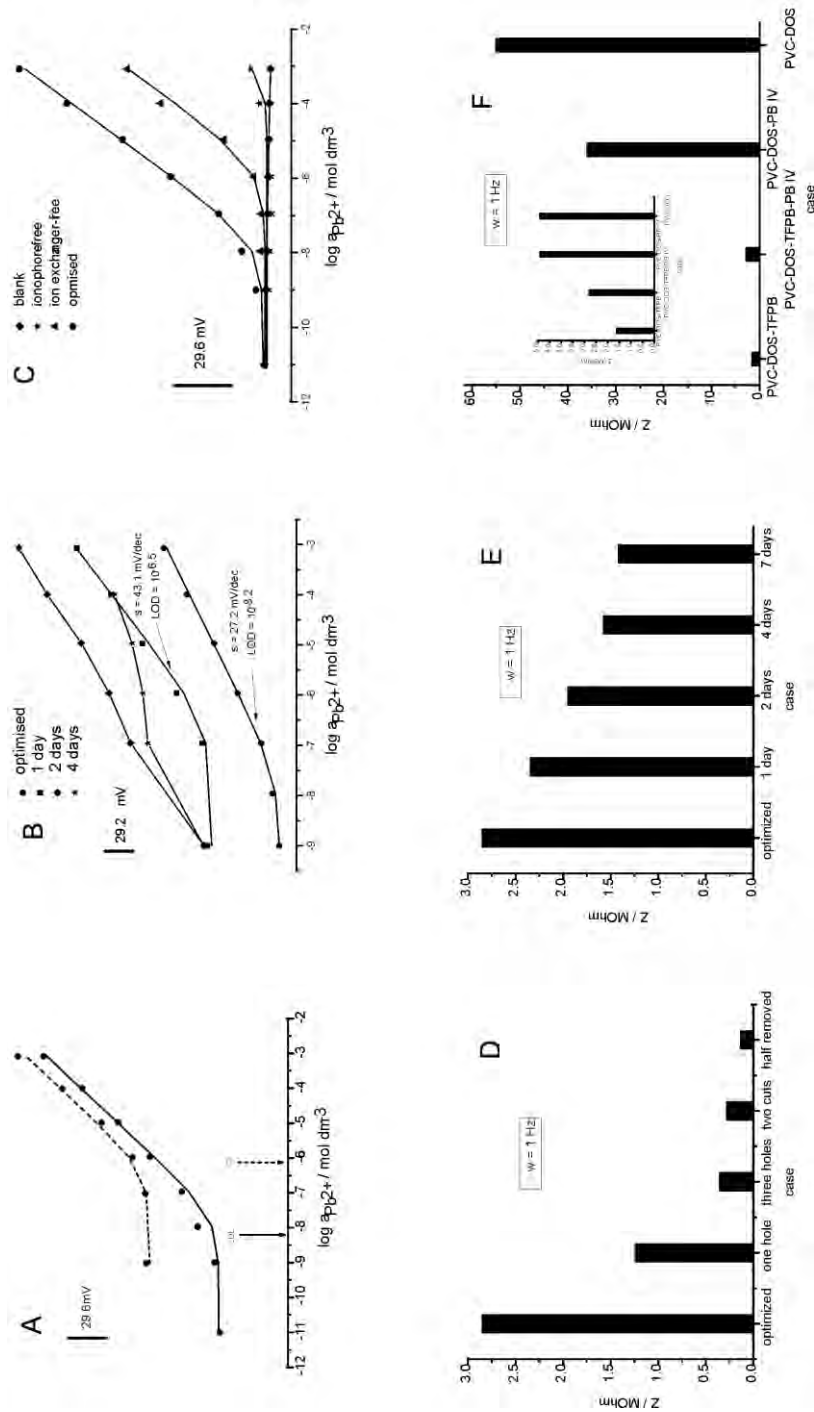

Fig. 11. Top: potentiometric response of: A) mechanically damaged ISEs, B) deterioration of the potentiometric response of ISEs due to biofouling over the course of several days and C) potentiometric responses of ISEs missing membrane components, thereby mimicking the process of their leaching. Bottom: D) impedance of mechanically damaged ISEs, E) reduction of impedance of ISEs corresponding to the loss of potentiometric response due to biofouling and F) impedance of ISEs that are missing membrane components.

ponse. A continuous and gradual change over a relatively short period (a few days) is a good indication that biofouling hampers the functionality. On the other hand, a continuous and gradual change occurring over a long time (a few months^{92,93}) indicates leaching of the membrane components. Finally, a sudden change indicates physical damage. Therefore, we argued that a microfluidic chip that integrates ISEs with a simple AC-generating circuitry using a single frequency and excitation signal could be used as a very simple diagnostic tool for the functionality of sensors. By periodically checking the impedance, the user can generate information about the functionality of the sensor system. Based on the obtained information, a built-in local intelligence could make a decision whether the systems requires calibration under the current state of the sensor. Consequently, a slight increase in sophistication could significantly reduce the size and cost of the operation and maintenance of devices.

7. FUTURE TRENDS

Since the breakthrough in lowering the *LOD* of ISEs, many serious strides were made towards real-life application of ISEs in environmental analysis. In the opinion of the authors, there will be three important avenues for further development of ISEs as environmental analytical tools. These avenues will be increasing the importance of technology, development of novel methodologies and utilization of new materials in order to achieve, low-cost and robust analytical devices.

7.1. Technology

Modern polymer membrane-based ISEs possess excellent analytical attributes in terms of selectivity and *LOD*. Interestingly, while conditioning and storage protocols are very important in achieving optimal *LODs*, guidelines for standardizing such protocols are not widely agreed.⁶⁸ Some interesting steps were taken by the group of Michalska, who realized that potential stability of ISEs prepared using two different conductive polymers (CPs) strongly depended on the storage conditions.^{94,95} On the other hand, long-term deployment and remote, real-time monitoring (*e.g.*, as part of WSNs) could be quite problematic due to fouling of the sensors with biological films, as well as the need for their calibration. It is expected that future research will involve integration of ISEs within microfluidic devices⁹⁶ capable of directing the flow of sample and calibration solutions according to the analytical needs. The effects of hydrodynamic flow showed very desirable effects in rotational disc electrode (RDE), flow injection analysis (FIA) and continuous flow analysis (CFA) in both detection limit and adsorption phenomena.^{35,97–99} Utilization of microfluidic platforms with built-in intelligence would therefore be capable of utilizing both hydrodynamic flow and automated methodologies for storage and calibration.

7.2. Analytical methodologies

Complex matrixes, extremely low activity of target analyte and the need for calibration render the application of direct potentiometry in environmental analysis quite limited. We are already witnessing the development of very interesting and exciting methodologies that could overcome these issues. Backside calibration as reported by Malon *et al.*¹⁰⁰ is a very interesting approach capable of evaluating the response of liquid-contact ISEs through a variation of in the composition of inner filling solution. Another very interesting concept for achieving chemical amplification is named switchtrodes.¹⁰¹ With this method, two polymer membrane ISEs are programmed to give kinetically controlled detection limits so as to produce a peak-shaped differential signal between the electrode pair when the activity of the sample is resonant with the intermediate activity required for switchtrode response. Since ISEs are in the super-Nernstian response mode, a switchtrode expresses chemical amplification. Like all electrochemical sensors, ISEs are excellently suited for use in “electronic tongues” where an array of carefully selected ISEs with appropriate cross-sensitivities may be used to establish response patterns that could be analysed using principal component analysis, artificial neural networks, partial least squares regression, *etc.*¹⁰²

In the authors’ opinion, a very important trend of the utilization of ISEs as detectors in a combination of techniques (analogous to hyphenated techniques) is currently being witnessed. Extremely sensitive ISEs are demonstrated as highly sensitive detectors in combination to nano-labels for immuno-analysis^{103–106} and DNA analysis.^{107,108} A very interesting approach for the elimination of the matrix effect was reported in the groups of Wang and Bakker. Highly sensitive Cd-selective electrodes were coupled with stripping voltammetry in the analysis of sea water. Accumulation of Cd from sea water using stripping voltammetry was performed prior to the release of Cd into a buffer solution where its concentration was determined using ISEs. This effectively eliminated the matrix and resulting analysis was by far more sensitive than either of the two employed techniques alone.¹⁰⁹ On the other hand, coupling ISEs with thin layer coulometry promises achievement of robust, calibration-free sensors that are highly attractive where recalibration *in situ* is difficult or undesirable.^{110–112}

7.3. Materials

Various materials had a deterministic influence on ISEs, starting from pH-sensitive glass to polymer membranes. Over the course of the development of the field of potentiometric sensors, many different materials played a very important role. For example, conducting polymers are currently a staple in the preparation of solid-contact electrodes. They serve as a lipophilic intermediate layer that enables transition from electronic-to-ionic conductivity and block the formation of water layer between ion selective membrane and metallic electrode; hence

enabling the realization of solid-contact electrodes with trace level sensitivity.¹¹³ Carbon nanotubes are increasingly finding their way into ISEs as intermediate layers due to their lipophilic and conducting properties.^{114,115}

A methyl methacrylate–decyl methacrylate (MMA–DMA) copolymer was used to produce toughened much more robust polymer membrane-based ISEs with excellent time responses and reproducibility.¹¹⁶ Moreover, new di- and tri-block copolymers introduce new dimension in improving the physico-chemical properties of ISEs.¹¹⁷ Thus, it is reasonable to expect that such copolymers will gain strong ground in future research.

Perfluorinated materials present a very interesting alternative to traditional materials used in ISEs. They are extremely hydrophobic, for example on the π^* scale of solvent polarity, water has a π^* value of 1, cyclohexane defines 0, and perfluoro-octane has a value of -0.41 .¹¹⁸ Such tremendous hydrophobicity is evidenced through exceptionally strong ion pair formation and more importantly great improvement in selectivity.^{119–123}

Another very interesting and promising class of materials are ionic liquids. They can be used as plasticizers, ion exchangers and ionophores.^{124,125} ILs demonstrate large variations in polarity and viscosity hence demonstrate significant influence on selectivity and sensitivity.¹²⁶ Moreover, the relative ease of the preparation of new ILs and their intrinsic conductivity present excellent fundamentals for modulating physico-chemical properties of the membrane, thereby opening new avenues for development and application of ISEs.

8. CONCLUSIONS

In summary, ISEs are making significant strides towards becoming a very important tool in environmental analysis. While many issues indeed exist, the energy and the pace of research addressing these issues are very promising. This conclusion indicates the importance of fundamental research in nanotechnology as a key strategy to the design, development, and engineering of sensing layers capable of addressing these critical needs.

Acknowledgments. The corresponding author gratefully acknowledges support from Keele University and Royal Society (RG120118).

ИЗВОД

ЈОН-СЕЛЕКТИВНЕ ЕЛЕКТРОДЕ У АНАЛИЗИ ЖИВОТНЕ СРЕДИНЕ

ALEKSANDAR RADU¹, TANJA RADU², CHRISTINA MCGRAW³, PETER DILLINGHAM⁴,
SALZITSA ANASTASOVA-IVANOVA⁵ и DERMOT DIAMOND⁶

¹Keele University, Birchall Centre and Environment, Physical Sciences and Mathematics (EPSAM) Research Institute, Lennard-Jones Labs, Stoke-on-Trent, ST5 2BG, United Kingdom, ²Loughborough University, School of Civil and Building Engineering, Loughborough, LE11 3TU, United Kingdom, ³Institute for Marine and Antarctic Studies (IMAS), University of Tasmania, Private Bag 129, Hobart 7005, Tasmania, Australia, ⁴University of New England, School of Science and Technology, Armidale, Australia, ⁵Queen Mary University London, School of Engineering and Mathematical Sciences, London, E1 4NS, United Kingdom и ⁶National Centre for Sensor Research, CLARITY Centre for Sensors Web Technologies, Dublin City University, Dublin 7, Ireland

Овај чланак даје преглед радова који се баве применом јон-селективних електрода (ISA) у анализи животне средине. ISA су стављене у контекст тренда за развој сензора за обимна и честа мерења. Разматране су теме као што су носачи сензора и њихове масовне производње, побољшање прецизности сензора, дијагноза њихове функционалности као и развој референтних електрода. Анализа ових тема је дата кроз примере примене ISA у анализи животне средине. Главни акценат овог чланка је стављен на сумирање резултата рада потписника овог текста у последњих неколико година.

(Примљено 29. августа, ревидирано 26 септембра 2013)

REFERENCES

1. M. Cremer, *Z. Biol.* **47** (1906) 562
2. M. S. Frant, *Analyst* **119** (1994) 2293
3. S. F. Martin, *J. Chem. Educ.* **74** (1997)
4. Final Report of the Expert Group for Silvermines County Tipperary, *Lead and Other Relevant Metals*, Office of Environmental Enforcement, EPA, 2004
5. W. K. Lutz, H. K. Wipf, W. Simon, *Helv. Chim. Acta* **53** (1970) 1741
6. L. A. R. Pioda, A. H. Wachter, R. E. Dohner, W. Simon, *Helv. Chim. Acta* **50** (1967) 1373
7. Z. Stefanac, W. Simon, *Chimia* **20** (1966) 436
8. *In-Vitro Diagnostic (IVD) Market (Applications, End-users & Types) Trends & Global Forecasts (Major & Emerging Markets – G7, Japan & BRIC) (2011–2016)*, 2012, www.marketsandmarkets.com
9. E. Bakker, E. Pretsch, *Angew. Chem. Int. Ed.* **46** (2007) 5660
10. E. Bakker, P. Buhlmann, E. Pretsch, *Electroanalysis* **11** (1999) 915
11. E. Bakker, E. Pretsch, *Advances in Potentiometry*, In *Electroanalytical Chemistry: A Series of Advances*, Vol 24, A. J. Bard, C. G. Zoski, Eds., CRC Press, Boca Raton, FL, 2011, p.p. 1–74
12. T. Sokalski, A. Ceresa, T. Zwickl, E. Pretsch, *J. Am. Chem. Soc.* **119** (1997) 11347
13. E. Bakker, P. Buhlmann, E. Pretsch, *Talanta* **63** (2004) 3
14. J. Bobacka, A. Ivaska, A. Lewenstam, *Chem. Rev.* **108** (2008) 329
15. R. De Marco, G. Clarke, B. Pejcic, *Electroanalysis* **19** (2007) 1987
16. A. Radu, D. Diamond, *Ion-selective electrodes in trace level analysis of heavy metals: potentiometry for the XXI century*, In *Comprehensive Analytical Chemistry*, D. Barcelo, Ed., Vol. 49, *Electrochemical sensor analysis*, S. Alegret, A. Merkoci, Eds., Elsevier, Oxford, 2007, p. 25

17. R. Murray, *Anal. Chem.* **82** (2010) 1569
18. C. Zuliani, D. Diamond, *Electrochim. Acta* **84** (2012) 29
19. A. Ceresa, A. Radu, S. Peper, E. Bakker, E. Pretsch, *Anal. Chem.* **74** (2002) 4027
20. A. Radu, S. Peper, E. Bakker, D. Diamond *Electroanalysis* **19** (2007) 144
21. A. C. Ion, E. Bakker, E. Pretsch, *Anal. Chim. Acta* **440** (2001) 71
22. A. Malon, A. Radu, W. Qin, Y. Qin, A. Ceresa, M. Maj-Zurawska, E. Bakker, E. Pretsch *Anal. Chem.* **75** (2003) 3865
23. Z. Szigeti, I. Bitter, K. Tóth, C. Latkoczy, D. J. Fliegel, D. Günther, E. Pretsch, *Anal. Chim. Acta* **532** (2005) 129
24. A. Radu, S. Peper, C. Gonczy, W. Runde, D. Diamond, *Electroanalysis* **18** (2006) 1379
25. W. Qin, T. Zwickl, E. Pretsch, *Anal. Chem.* **72** (2000) 3236
26. T. Vigassy, C. Huber, R. Wintringer, E. Pretsch, *Anal. Chem.* **77** (2005) 3966
27. J. Buffle, R. S. Altman, M. Filella, A. Tessier, *Geochim. Cosmochim. Acta* **54** (1990) 1535
28. M. H. Hecht, S. P. Kounaves, R. C. Quinn, S. J. West, S. M. M. Young, D. W. Ming, D. C. Catling, B. C. Clark, W. V. Boynton, J. Hoffman, L. P. DeFlores, K. Gospodinova, J. Kapit, P. H. Smith, *Science* **325** (2009) 64
29. M.-J. Lin, A. Grandison, *Int. J. Dairy Technol.* **59** (2006) 192
30. N. On-Nom, A. Grandison, M. Lewis, *J. Dairy Sci.* **93** (2010) 515
31. P. Upreti, L. Metzger, P. Bühlmann, *Talanta* **63** (2004) 139
32. P. Buehlmann, E. Pretsch, E. Bakker, *Chem. Rev.* **98** (1998) 1593
33. R. De Marco, B. Pejčić, X. D. Wang, *Lab. Rob. Autom.* **11** (1999)
34. B. Pejčić, R. D. Marco, *Electrochim. Acta* **49** (2004)
35. A. Zirino, R. De Marco, I. Rivera, B. Pejčić, *Electroanalysis* **14** (2002) 493
36. A. Ceresa, E. Bakker, B. Hattendorf, D. Guenther, E. Pretsch, *Anal. Chem.* **73** (2001) 343
37. R. W. Cattrall, H. Freiser, *Anal. Chem.* **43** (1971) 1905
38. M. Fibbioli, W. E. Morf, M. Badertscher, N. F. de Rooij, E. Pretsch, *Electroanalysis* **12** (2000) 1286
39. M. Fibbioli, K. Bandyopadhyay, S. G. Liu, L. Echegoyen, O. Enger, F. Diederich, D. Gingery, P. Buehlmann, H. Persson, U. W. Suter, E. Pretsch, *Chem. Mater.* **14** (2002) 1721
40. J. Sutter, A. Radu, S. Peper, E. Bakker, E. Pretsch, *Anal. Chim. Acta* **523** (2004) 53
41. K. Y. Chumbimuni-Torres, N. Rubinova, A. Radu, L. T. Kubota, E. Bakker, *Anal. Chem.* **78** (2006) 1318
42. C.-Z. Lai, M. Joyer, M. Fierke, N. Petkovich, A. Stein, P. Bühlmann, *J. Solid State Electrochem.* **13** (2009) 123
43. T. Lindfors, H. Aarnio, A. Ivaska, *Anal. Chem.* **79** (2007) 8571
44. A. Michalska, C. Appaih-Kusi, L. Heng, S. Walkiewicz, E. Hall, *Anal. Chem.* **76** (2004) 2031
45. A. Michalska, J. Dumańska, K. Maksymiuk, *Anal. Chem.* **75** (2003)
46. N. Rubinova, K. Chumbimuni-Torres, E. Bakker, *Sensors Actuators, B* **121** (2006) 135
47. M. Vázquez, J. Bobacka, A. Ivaska, *J. Solid State Electrochem.* **9** (2005) 865
48. M. Vázquez, J. Bobacka, M. Luostarinen, K. Rissanen, A. Lewenstam, A. Ivaska, *J. Solid State Electrochem.* **9** (2005) 312
49. C. M. McGraw, T. Radu, A. Radu, D. Diamond, *Electroanalysis* **20** (2008) 340
50. O. Dominguez Renedo, M. A. Alonso-Lomillo, M. J. Arcos, Martinez *Talanta* **73** (2007) 202
51. J. P. Hart, A. Crew, E. Crouch, K. C. Honeychurch, R. M. Pemberton, *Anal. Lett.* **37** (2004) 789

52. M. Heule, S. Vuillemin, L. J. Gauckler, *Adv. Mater.* **15** (2003) 1237
53. F. Loffredo, A. D. G. Del Mauro, G. Burrasca, V. La Ferrara, L. Quercia, E. Massera, G. Di Francia, D. D. Sala, *Sensors Actuators, B* **143** (2009) 421
54. S. Anastasova, A. Radu, G. Matzeu, C. Zuliani, U. Mattinen, J. Bobacka, D. Diamond, *Electrochim. Acta* **73** (2012).
55. S. Anastasova-Ivanova, U. Mattinen, A. Radu, J. Bobacka, A. Lewenstam, J. Migdalski, M. Danielewski, D. Diamond, *Sensors Actuators, B* **146** (2010) 199
56. M. Kaku *Visions: How Science will Revolutionize the 21st Century*, Anchor Books, New York, 1997
57. B. Schazmann, D. Morris, C. Slater, S. Beirne, C. Fay, R. Reuveny, N. Moyna, D. Diamond, *Anal. Methods* **2** (2010) 342
58. J. R. Windmiller, J. Wang, *Electroanalysis* **25** (2013) 29
59. R. Byrne, D. Diamond, *Nature Mat.* **5** (2006) 421
60. D. Diamond, *Anal. Chem.* **76** (2004) 278A
61. J. F. van Staden, R. I. Stefan-van Staden, S. C. Balasoju, *Crit. Rev. Anal. Chem.* **40** (2010) 226
62. R. Shepherd, S. Beirne, K. T. Lau, B. Corcoran, D. Diamond, *Sensors Actuators, B* **121** (2007) 142
63. C. Fay, S. Anastasova, C. Slater, S. T. Buda, R. Shepherd, B. Corcoran, N. E. O'Connor, G. G. Wallace, A. Radu, D. Diamond, *IEEE Sens. J.* **11** (2011) 2374
64. Commission on Analytical Nomenclature, *Pure Appl. Chem.* **48** (1975) 127
65. R. P. Buck, V. V. Cosofret, *Pure Appl. Chem.* **65** (1993) 1849
66. R. P. Buck, E. Lindner, *Pure Appl. Chem.* **66** (1994) 2527
67. Y. Umezawa, K. Umezawa, H. Sato, *Pure Appl. Chem.* **67** (1995) 507
68. E. Lindner, Y. Umezawa, *Pure Appl. Chem.* **80** (2008) 85
69. A. Radu, A. J. Meir, E. Bakker *Anal. Chem.* **76** (2004) 6402
70. D. B. Hibbert, N. Armstrong, *Chemom. Intell. Lab. Syst.* **97** (2009) 194
71. K. T. Lau, W. Guo, B. Kiernan, C. Slater, D. Diamond, *Sensors Actuators, B* **136** (2009) 242
72. L. T. Duarte, C. Jutten, S. Moussaoui, in *Lect. Notes Comput. Sc.*, T. Adali, C. Jutten, J. M. T. Romano, A. K. Barros, Eds., Springer, Berlin, 2009, pp. 662–669
73. P. W. Dillingham, T. Radu, D. Diamond, A. Radu, C. M. McGraw, *Electroanalysis* **24** (2012) 316
74. C. M. McGraw, T. Radu, A. Radu, D. Diamond, *Electroanalysis* **20** (2008) 340
75. D. Diamond, K. Lau, S. Brady, J. Cleary, *Talanta* **75** (2008) 606
76. T. Blaz, J. Migdalski, A. Lewenstam, *Analyst* **130** (2005) 637
77. D. Diamond, E. McEnroe, M. McCarrick, A. Lewenstam, *Electroanalysis* **6** (1994) 962
78. A. Kisiel, H. Marcisz, A. Michalska, K. Maksymiuk, *Analyst* **130** (2005) 1655
79. A. Kisiel, A. Michalska, K. Maksymiuk, E. A. H. Hall, *Electroanalysis* **20** (2008) 318
80. U. Mattinen, J. Bobacka, A. Lewenstam, *Electroanalysis* **21** (2009) 1955
81. D. Cicmil, S. Anastasova, A. Kavanagh, D. Diamond, U. Mattinen, J. Bobacka, A. Lewenstam, A. Radu, *Electroanalysis* **23** (2011) 1881
82. B. Peng, J. W. Zhu, X. J. Liu, Y. Qin, *Sensors Actuators, B* **133** (2008) 308
83. T. Kakiuchi, *Anal. Sci.* **24** (2008) 1221
84. T. Kakiuchi, T. Yoshimatsu, N. Nishi, *Anal. Chem.* **79** (2007) 7187
85. T. Yoshimatsu, T. Kakiuchi, *Anal. Sci.* **23** (2007) 1049
86. D. Diamond, S. Coyle, S. Scarmagnani, J. Hayes, *Chem. Rev.* **108** (2008) 652

87. A. Radu, A. Kavanagh, S. Scarmagnani, R. Byrne, N. Alhashimy, C. Slater, D. Diamond, in *Proceedings of PITTCON 2009 – 60th Pittsburg Conference on Analytical Chemistry and Applied Spectroscopy*, Chicago, IL, 2009
88. R. Byrne, S. Scarmagnani, A. Radu, F. Benito-Lopez, D. Diamond, (2009). *Schizophrenic Molecules and Materials with Multiple Personalities – How Materials Science could Revolutionise How we do Chemical Sensing*, MRS Proceedings, 1190, 1190-NN08-01 doi:10.1557/PROC-1190-NN08-01
89. A. Radu, R. Byrne, N. Alhashimy, M. Fusaro, S. Scarmagnani, D. Diamond, *J. Photochem. Photobiol., A* **206** (2009) 109
90. A. Radu, S. Scarmagnani, R. Byrne, C. Slater, K. T. Lau, D. Diamond, *J. Phys., D* **40** (2007) 7238
91. A. Radu, S. Anastasova-Ivanova, B. Paczosa-Bator, M. Danielewski, J. Bobacka, A. Lewenstam, D. Diamond, *Anal. Methods* **2** (2010) 1490
92. P. Buehlmann, Y. Umezawa, S. Rondinini, A. Vertova, A. Pigliucci, L. Bertesago, *Anal. Chem.* **72** (2000) 1843
93. S. Peper, Y. Qin, P. Almond, M. McKee, M. Telting-Diaz, T. Albrecht-Schmitt, E. Bakker, *Anal. Chem.* **75** (2003) 2131
94. A. Michalska, K. Pyrzyńska, K. Maksymiuk, *Anal. Chem.* **80** (2008) 3921
95. A. Michalska, M. Wojciechowski, E. Bulska, K. Maksymiuk, *Talanta* (2010)
96. B. Tossanaitada, T. Masadome, T. Imato, *Anal. Methods* **4** (2012) 4384
97. R. De Marco, R. Eriksen, A. Zirino, *Anal. Chem.* **70** (1998) 4683
98. R. DeMarco, D. J. Mackey, A. Zirino, *Electroanalysis* **9** (1997) 330
99. A. Radu, M. Telting-Diaz, E. Bakker, *Anal. Chem.* **75** (2003) 6922
100. A. Malon, E. Bakker, E. Pretsch, *Anal. Chem.* **79** (2007) 632
101. T. Vigassy, W. E. Morf, M. Badertscher, A. Ceresa, N. F. de Rooij, E. Pretsch, *Sensors Actuators, B* **76** (2001) 477
102. P. Ivarsson, Y. Kikkawa, F. Winqvist, C. Krantz-Rulcker, N. E. Hojer, K. Hayashi, K. Toko, I. Lundstrom, *Anal. Chim. Acta* **449** (2001) 59
103. K. Y. Chumbimuni-Torres, Z. Dai, N. Rubinova, Y. Xiang, E. Pretsch, J. Wang, E. Bakker, *J. Am. Chem. Soc.* **128** (2006) 13676
104. A. Numnuam, K. Y. Chumbimuni-Torres, Y. Xiang, R. Bash, P. Thavarungkul, P. Kanatharana, E. Pretsch, J. Wang, E. Bakker, *Anal. Chem.* **80** (2008) 707
105. J. Szucs, E. Pretsch, R. E. Gyurcsanyi, *Analyst* **134** (2009) 1601
106. R. Thuerer, T. Vigassy, M. Hirayama, J. Wang, E. Bakker, E. Pretsch, *Anal. Chem.* **79** (2007) 5107
107. K. Y. Chumbimuni-Torres, J. Wu, C. Clawson, M. Galik, A. Walter, G.-U. Flechsig, E. Bakker, L. Zhang, J. Wang, *Analyst* **135** (2010) 1618
108. J. Wu, K. Y. Chumbimuni-Torres, M. Galik, C. Thammakhet, D. A. Haake, J. Wang, *Anal. Chem.* **81** (2009) 10007
109. K. Y. Chumbimuni-Torres, P. Calvo-Marzal, J. Wang, E. Bakker, *Anal. Chem.* **80** (2008) 6114
110. E. Grygolowicz-Pawlak, E. Bakker, *Electrochim. Acta* **56** (2011) 10359
111. A. Shvarev, B. Neel, E. Bakker, *Anal. Chem.* **84** (2012) 8038
112. M. Sohail, R. De Marco, K. Lamb, E. Bakker, *Anal. Chim. Acta* **744** (2012) 39
113. J. Bobacka, *Electroanalysis* **18** (2006) 7
114. G. A. Crespo, S. Macho, J. Bobacka, F. X. Rius, *Anal. Chem.* **81** (2009) 676
115. Z. Mousavi, A. Teter, A. Lewenstam, M. Maj-Zurawska, A. Ivaska, J. Bobacka, *Electroanalysis* **23** (2011) 1352

116. S. Peper, A. Ceresa, Y. Qin, E. Bakker, *Anal. Chim. Acta* **500** (2003) 127
117. Y. He, P. G. Boswell, P. Buhlmann, T. P. Lodge, *J. Phys. Chem., B* **111** (2007) 4645
118. M. J. Kamlet, J. L. Abboud, R. W. Taft, *J. Am. Chem. Soc.* **99** (1977) 6027
119. P. G. Boswell, A. C. Anfang, P. Buehlmann, *J. Fluorine Chem.* **129** (2008) 961
120. P. G. Boswell, P. Buhlmann, *J. Am. Chem. Soc.* **127** (2005) 8958
121. P. G. Boswell, E. C. Lugert, J. Rabai, E. A. Amin, P. Buhlmann, *J. Am. Chem. Soc.* **127** (2005) 16976
122. C.-Z. Lai, S. S. Koseoglu, E. C. Lugert, P. G. Boswell, J. Rabai, T. P. Lodge, P. Buhlmann, *J. Am. Chem. Soc.* **131** (2009) 1598
123. C.-Z. Lai, M. E. Reardon, P. G. Boswell, P. Buehlmann, *J. Fluorine Chem.* **131** (2010) 42
124. B. Peng, J. Zhu, X. Liu, Y. Qin, *Sensors Actuators, B* **133** (2008) 308
125. J. Zhu, J. Zhai, X. Li, Y. Qin, *Sensors Actuators, B* **159** (2011) 256
126. A. Radu (unpublished data).