

Vocational Training Council

## VTC Institutional Repository

---

Staff Publications

Faculty of Science and Technology

---

2019

### Effects of beam-column depth ratio on seismic behaviour of non-seismic detailed reinforced concrete beam-column joints

Ying Liu

*Technological and Higher Education Institute of Hong Kong (THEi)*

Ho-Fai Wong

*Technological and Higher Education Institute of Hong Kong (THEi)*, ceshfw@vtc.edu.hk

Sung-Hei Luk

*Technological and Higher Education Institute of Hong Kong (THEi)*, henrylsh@vtc.edu.hk

Ching-Kit Tong

*Technological and Higher Education Institute of Hong Kong (THEi)*

Hei Lam

*Technological and Higher Education Institute of Hong Kong (THEi)*

Follow this and additional works at: <https://repository.vtc.edu.hk/thei-fac-sci-tech-sp>



Part of the [Civil Engineering Commons](#)

---

#### Recommended Citation

Liu, Y., Wong, H., Luk, S., Tong, C., & Lam, H. (2019). Effects of beam-column depth ratio on seismic behaviour of non-seismic detailed reinforced concrete beam-column joints. *The 2019 World Congress on Advances in Structural Engineering and Mechanics (ASEM19) Jeju Island, Korea, September 17 - 21, 2019*. Retrieved from <https://repository.vtc.edu.hk/thei-fac-sci-tech-sp/428>

This Conference Proceeding is brought to you for free and open access by the Faculty of Science and Technology at VTC Institutional Repository. It has been accepted for inclusion in Staff Publications by an authorized administrator of VTC Institutional Repository. For more information, please contact [wchu@vtc.edu.hk](mailto:wchu@vtc.edu.hk).

## **Effects of beam-column depth ratio on seismic behavior of non-seismic detailed reinforced concrete beam-column joints**

Ying Liu<sup>1)</sup>, \*Ho-Fai Wong<sup>2)</sup>, Sung-Hei Luk<sup>3)</sup>, Ching-Kit Tong<sup>4)</sup> and Hei Lam<sup>5)</sup>

<sup>1), 2), 3), 4), 5)</sup> *Department of Construction Technology and Engineering, Faculty of Science and Technology, THEi, Hong Kong, China*

<sup>2)</sup> [ceshfw@vtc.edu.hk](mailto:ceshfw@vtc.edu.hk)

### **ABSTRACT**

Four reinforced concrete exterior beam-column joints with open anchorage beam reinforcement, which are manufactured to simulate those in existing reinforced concrete framed buildings, are tested under reversed cyclic loads simulating earthquake excitation. The particular emphasis of this project is given to the effects of the beam-column depth ratio and the stirrup ratio in joints on the shear strength and seismic behaviour of the exterior joints without seismically designed details. The experimental results indicate that the stirrup placed in the beam-column joint cores can effectively improve the shear strength of the joint and enhance the seismic performance, and the shear strength of the joints decreases when the beam-column depth ratio increases. The experimental results are also compared with the results predicted by two non-seismic design codes (Eurocode 2 and HK code 2013) and three codes for seismic design (Eurocode 8, ACI 318-14 and NZS 3101). In general, the current non-seismic design codes and seismic design codes of practice cannot accurately predict the shear strength of the exterior joints with non-seismically designed details. It is shown that neglecting the seismic design of beam-column joints may lead to potential damage of reinforced concrete framed buildings in unexpected moderate or low seismic areas.

### **1. INTRODUCTION**

There are many existing reinforced concrete (RC) frame structures in the regions of low or moderate seismicity, such as in mid-America, the UK and Hong Kong, which are designed without considering the seismic excitation. The buildings without considering the seismic behaviour have no appropriate structural details to transmit the earthquake-induced internal forces to the ground. In post-earthquake reconnaissance, shear failure of joints led to the collapse of many RC buildings (Moehle 1991, Sezen 2003, and EERI 2001) as the beam-column joint plays an important role in transferring the internal forces between the adjacent beams and columns. Indeed, neglecting the seismic design of beam-column joints imply high sensitivity to potential earthquake risk (Kuang 2005, Lee 2009 and Choi 2017).

---

<sup>1)</sup> Research Assistant

<sup>2)</sup> Associate Professor

<sup>3)</sup> Teaching Fellow

<sup>4), 5)</sup> Graduate Student

When the RC frame buildings are subjected to earthquake load, the possible brittleness will be concentrated either in beams or the beam-column joints. The failure of RC beam-column joints is due to concrete cracking and yielding of steel bars, which affects by the detailing of transverse links in the joints and anchorage of beam and column reinforcement etc. (Scott 1992 and Hegger 2003). To avoid the sudden degradation of the strength and brittle failure of the frame structure, it is mainly necessary to maintain the integrity of the beam-column joint, because the failure of the RC joint will lead to the instability of the structure.

Therefore, a further understanding of the seismic performance of RC beam-column joints with non-seismically design details is indispensable to evaluate the overall structural response of the existing buildings without seismic effect considerations in detail. Retrofitting or strengthening should be made to enhance the shear strength and improve the seismic performance, which may finally lead to modifications in the analysis of the current design codes.

In this paper, four RC exterior beam-column joints were designed according to the Hong Kong Code of Practice (HKSUC 2013), fabricated, and tested under reversed cyclic-load. The primary intention of this project is to study the effects of the stirrup ratio in joints and the beam-column depth ratio on the seismic behaviour of non-seismic detailed RC exterior beam-column joints subjected to simulated seismic loading. Then, by comparing the experimental results with the predicted values of three seismic and two pre-seismic design codes, the effectiveness of the current codes for predicting the shear strength of beam-column joints with non-seismic detailed is evaluated.

## **2. EXPERIMENTAL PROGRAMME**

### **2.1 Specimens**

Four RC exterior beam-column joints designed according to the Hong Kong Code of Practice for Structural Use of Concrete are constructed and tested. Each having a beam of 200 mm wide framing into the column of 200 mm × 200 mm cross-section. Each column in all specimen is mainly reinforced with 4T16, but the longitudinal reinforcement of the beam is different. One beam with 200 mm × 200 mm cross-section is reinforced with an equal amount of steel bars of 3T12 at both top and bottom sides of the beam section, nevertheless, the steel bars of 3T12 in the other three beam cross-section of 200 mm × 400 mm were replaced by 3T16. Two specimens have no transverse link in beam-column joints, and the other two have 1T10 and 2T10 shear links in joint core respectively. The details of reinforcement and geometry of the specimens are shown in Fig. 1.

Table 1 shows the compressive strength of the concrete of the specimens, and the yield strength of the reinforcement,  $f_y$ , is 500 MPa. The first part of the label of the specimen in Table 1 and Fig. 1, HKOL, stands for design to HK Code with the opposed arrangement of the “L” shaped anchorage of beam reinforcement. The specimen series

is followed by numbers, which represent the depth of beam (200 mm and 400 mm), and the shear links in the joint core (1T10 and 2T10).

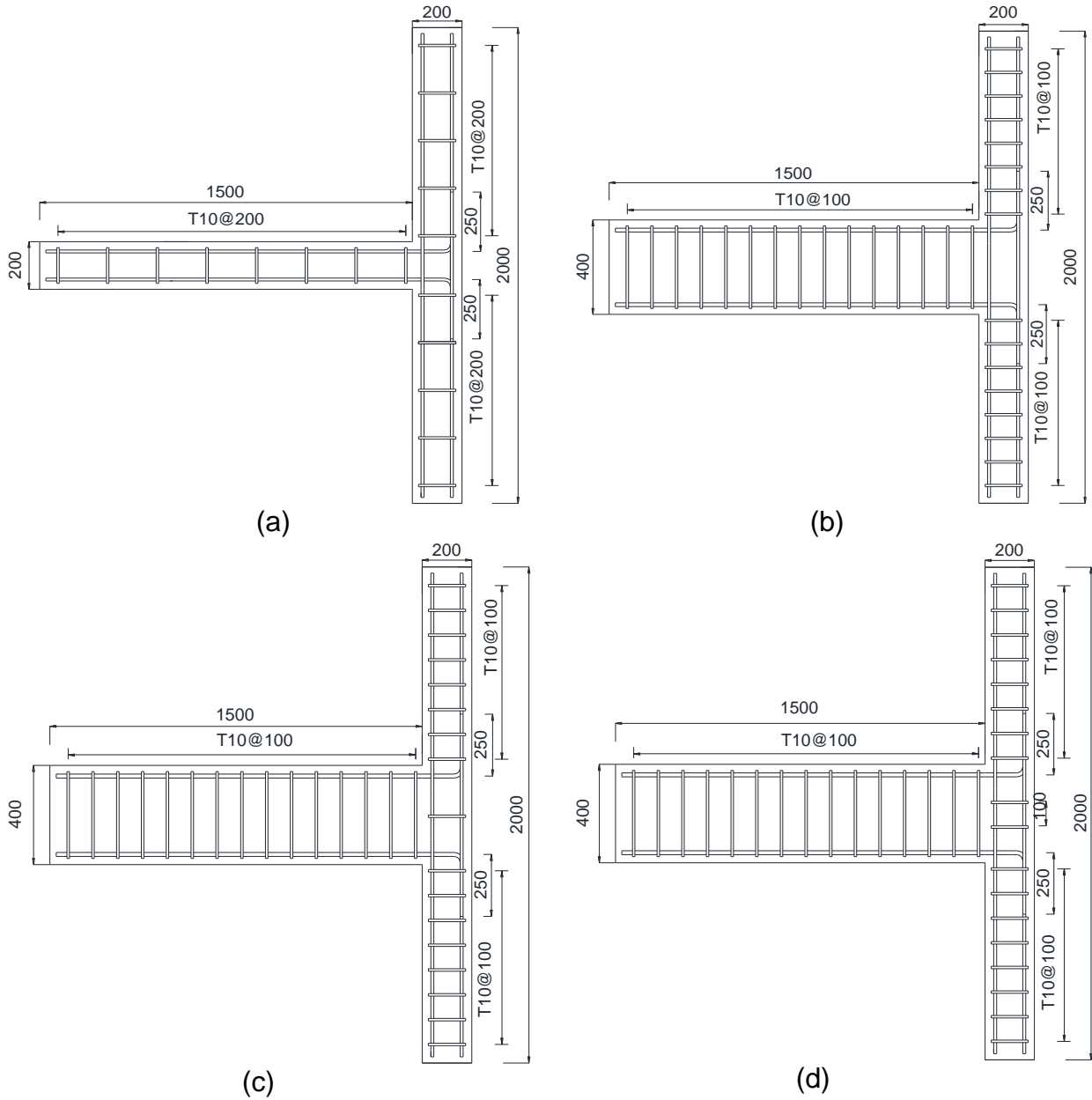

Fig. 1 Details of reinforcement and geometry of the specimens: (a) specimen HKOL-200; (b) specimen HKOL-400; (c) specimen HKOL-400-L; (d) specimen HKOL-400-LL (dimensions in mm)

Table 1 Material properties

Specimen	HKOL-200	HKOL-400	HKOL-400-L	HKOL-400-LL
Concrete compressive strength, $f_{cu}$ ( $f'_c$ ): MPa	50.1(40.1)	43.1(34.5)	38.9(31.1)	23.3(18.64)

## 2.2 Experimental set-up and procedure

To facilitate testing, the T-shaped beam-column joint is rotated 90°, so that the beam is in the vertical position and the column is in the horizontal position. The test set-up and loading system are shown in Fig.2. This set-up provides appropriate boundary conditions to simulate the actual working state of the beam-column joints in RC frame structures.

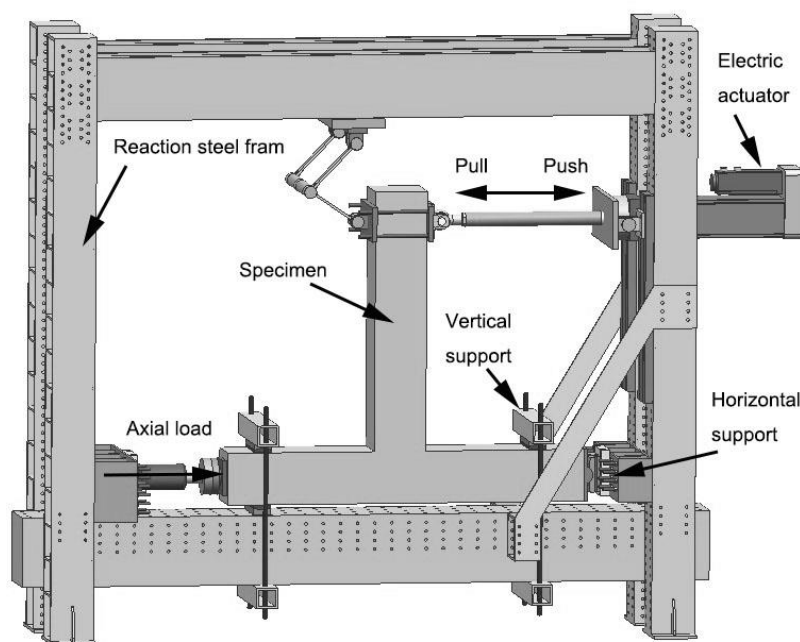

Fig. 2 Test set-up

In this test, the column is subjected to an axial load of about 10% of the column axial capacity, which is applied by a servo-controlled hydraulic jack to simulate the gravity load from upper floors. Then 300 kN electric actuator is employed to apply the reversed cyclic loading at the beam end in a displacement control mode. The electric actuator applied each target displacement in a quasi-static mode, and the lateral displacement consisting of two cycles at monotonically increasing drift levels (0.25%, 0.5%, 1.0%, 2.0%, 4.0% and 6.0%).

The reversed cyclic loading is predetermined in terms of storey drift ratios, where the storey drift ratio,  $\Delta$ , is defined in Eq. (1), and it was used until restoring force is reduced to 85% of the peak load, when the specimen was assumed to have failed.

$$\Delta = \frac{\delta}{L_b + 0.5h_c} \times 100\% \quad (1)$$

where  $\delta$  is the displacement at the level of cyclic loading;  $L_b$  and  $h_c$  are the beam length

and the depth of the column, respectively.

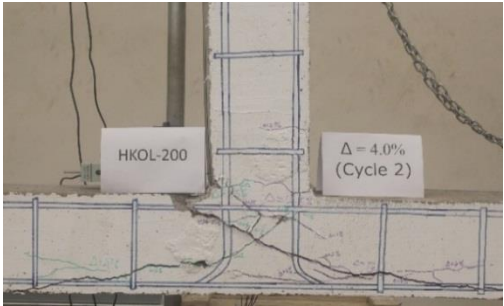
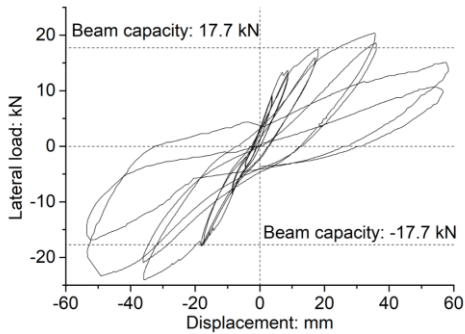

(a) HKOL-200

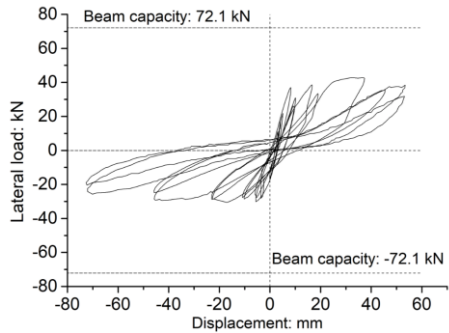

(b) HKOL-400

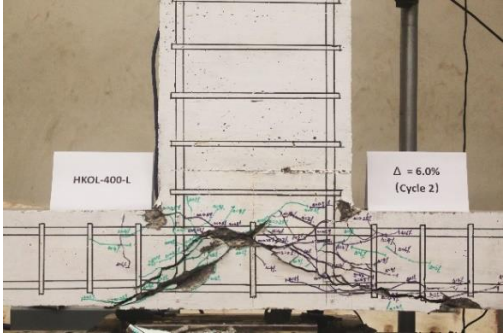
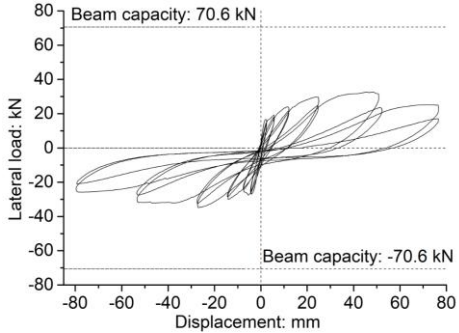

(c) HKOL-400-L

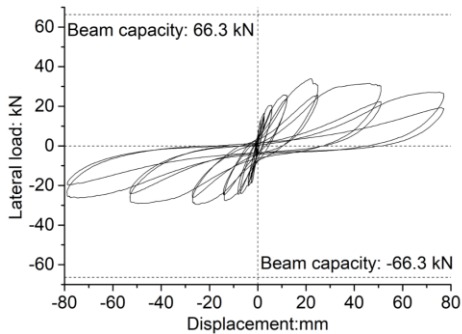

(d) HKOL-400-LL

Fig. 3 Lateral load-displacement hysteretic responses and the cracks patterns

### 3. TEST RESULTS

#### 3.1 Hysteretic behavior and damage features

Fig. 3 illustrates the hysteretic responses and the cracks patterns at failure of specimens, and the maximum test loads are presented in Table 2.

Table 2 Test results

Specimen	Maximum test load $P_{max}$ : kN	Beam capacity $P_n$	$P_{max}/P_n$	Joint shear strength: kN	Normalised shear strength	
					$v_j/\sqrt{f'_c}$	Relative value
HKOL-200	24.6	17.7	1.39	248.8	0.98	1.6
HKOL-400	42.8	72.1	0.59	144.9	0.62	1.0
HKOL-400-L	34.6	70.6	0.49	117.3	0.53	0.85
HKOL-400-LL	32.7	66.3	0.49	113.2	0.66	1.06

As shown in Fig.3, inclined cracks appear in the beam-column joint core of all specimens, and concrete flaked can be clearly observed in the joint core except for specimen HKOL-200. Besides, flexural cracks were observed at the beam end in specimen HKOL-200, as shown in Fig. 2(a), but not in the other three specimens with, which had diagonal shear cracks developed in the joint core before yielding of longitudinal beam steel bars, as shown in Fig. 3(b)-3(d). This indicates that the specimens with beam-column depth ratio of 1:2 failed in a brittle mode of joint shear failure, while the specimen HKOL-200 with beam-column depth ratio of 1:1 failed in a ductile mode.

It can be seen from Fig.3(a) and Table 2 that for specimen HKOL-200, the load-displacement loops are relatively plump, and the experimental load reaches 139% of the nominal load capacity of the beam. For the other specimens, only 49%-59.4% of the beam capacity is developed, and those hysteretic curves have obvious pinching phenomenon due to the slip effect. Compared with specimen HKOL-200, the shear transfer capacity, energy dissipation and seismic performance are reduced, which is unfavorable to seismic performance.

#### 3.2 Joint shear strength

The shear force in the RC exterior beam-column joint is determined by considering a joint as a part of the column subjected to the shear force transferred from the beam, which is calculated by the following Eq. (2) (Paulay 1992 and Kuang 2006).

$$V_j = T_b - V_{col} = \frac{PL_b}{0.9d_b} - \frac{P(L_b+0.5h_c)}{L_c} \quad (2)$$

where  $V_j$  is the shear force in the connection;  $T_b$  and  $V_{col}$  are the tensile force in steel of the beam and the shear force of the column, respectively;  $P$  is the applied lateral load at the end of beam;  $L_b$ ,  $L_c$  and  $d_b$  are the length of beam and column and the effective depth of the beam, respectively, and  $h_c$  is the depth of column.

Since the specimens have different compressive strength of concrete as well as geometry dimension of the specimens, the actual joint shear strength for each specimen should be nominalized to facilitate comparison. The calculated results were shown in Table 2.

The normalised shear stress of the three specimens in HKOL-400 series is significantly lower than the test results of the specimen HKOL-200, which is 0.98. This indicates a relatively low capability of seismic resistance and also a possible undesirable brittle failure of joints with the beam-column depth ratio of 1:2.

### 3.3 Effect of the beam-column depth ratio

For the convenience of analysis, the experiment result (Wong 2005) of specimen BS-OL, which has the beam-column depth ratio of 1.5 and similar reinforcement ratio in the beam as well as column, is used as a reference. Fig. 4 shows the variation normalized shear stress to beam-column depth ratios.

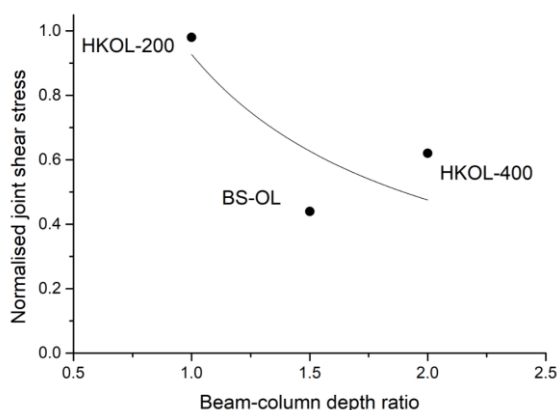

Fig. 4 Variation of joint shear stress to beam-column depth ratio

Without considering the effect of the joint stirrup, when the beam-column depth ratio is increased, the nominal shear strength of the beam-column dropped. The beam-column depth ratio is an important parameter that affects the seismic performance of beam-column joints. In current codes of practice, however, it is generally neglected.

### 3.4 Effect of stirrups in joint

To investigate the effectiveness of shear links in the joint cores on the seismic behaviour, specimens HK-OL-400, HKOL-400-L and HKOL-400-LL, which are provided 0T10, 1T10 and 2 T10 stirrups in the joint core, respectively, are compared in this paper. The variation of joint shear stress to the stirrup ratio in the joint core is shown in Fig. 5.

It is also observed from Fig. 5 that although all the three specimens failed in a



brittle joint shear failure mode, the shear strength increases as the joint core stirrup ratio increases, the improvement effect is limited.

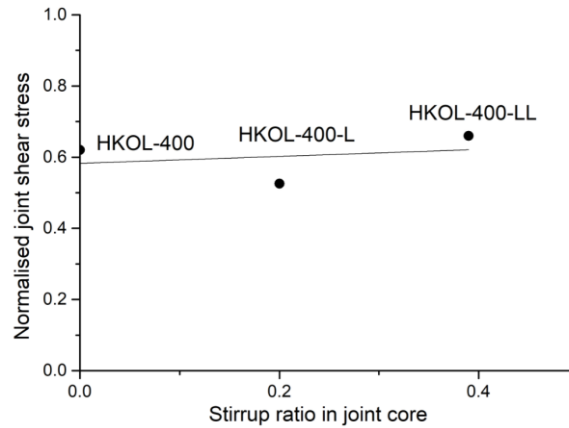

Fig. 5 Variation of joint shear stress to stirrup ratio

#### 4. COMPARISON WITH PREDICTIONS OF DESIGN CODES

The experimental results are compared with the values predicted by seismic design codes ACI 318-14 (2014), NZS 3101 (2017) and Eurocode 8 (2013), and the values predicted by two non-seismic design codes HK code (2013) and Eurocode 2 (2.14), to evaluate the validity of existing codes in predicting the shear strength of the exterior beam-column joints with non-seismic detailed under reversed cyclic loading.

##### 4.1 ACI 318-14

According to the ACI 318-14, the exterior beam-column joint shear strength for normalweight concrete is specified as Eq. (3).

$$V_j = 0.85\sqrt{f'_c}A_j \quad (3)$$

where  $f'_c$  is the cylinder strength of concrete,  $A_j$  is the effective cross-sectional area within a joint, which is computed from joint depth times effective joint width. After removing the strength reduction factor of 0.85, the shear strength of exterior joint shall be rewritten as

$$V_j = \sqrt{f'_c}A_j \quad (4)$$

##### 4.2 NZS 3101

From NZS 3101 (2017), the shear strength across a joint illustrated in Eq. (5).

$$V_j = 0.2f'_c b_j h_c \text{ or } 10b_j h_c \quad (5)$$

where  $V_j$  is the lesser. The effective width  $b_j$  is usually taken as the smaller of  $b_c$  or  $b_w + 0.5h_c$ , when  $b_c \geq b_w$ .

#### 4.3 Eurocode 8

In Eurocode 8: Part 1 for exterior beam-column joints, the diagonal compression induced in the joint by the diagonal strut mechanism shall not exceed the compressive strength of concrete, the shear strength should be satisfied the Eq. (6). And for the joints providing horizontal links, the shear strength can be calculated by Eq. (7).

$$V_j = 0.8 \times \eta f_c b_j h_{jc} \sqrt{1 - \frac{v_d}{\eta}} \quad (6)$$

$$V_j = \left[ \left( \frac{A_{sh} f_y}{b_j h_{jw}} + f_{cta} \right) (f_{cta} + v_d f_c) \right]^{0.5} \times b_j h_{jc} \quad (7)$$

where  $\eta = 0.6(1 - f_c/250)$ ;  $f_c$  is the concrete compressive strength;  $b_j$  is the effective joint width;  $h_{jc}$  is the distance between extreme layers of column reinforcement; the  $v_d$  is the normalised axial force in the column;  $A_{sh}$  is the total area of the horizontal links;  $f_{cta}$  is the tensile strength of concrete; and  $h_{jw}$  and  $h_{jc}$  are the distance between the top and the bottom reinforcement of the beam and the distance between extreme layers of column reinforcement, respectively.

#### 4.4 Hong Kong code

In Hong Kong code: Code of Practice for Structural Use of Concrete 2013, there are no seismic provisions for the analysis of shear strength of the joints. The shear strength can be calculated by

$$V_j = \frac{A_j f_y}{0.5 - \frac{C_j N}{0.8 A_c f_{cu}}} \quad (8)$$

where  $A_j$  is the area of effective horizontal joint shear reinforcement;  $C_j = 1$  if joint has beams in one direction only;  $N$  is the design axial column load; and  $A_c$  is the area of column section.

#### 4.5 Eurocode 2

In Eurocode 2: Design of concrete structures-Part 1-1: Section 6.2, the shear strength is calculated by Eq. (9).

$$V_j = [C_{R,c} k (100 \rho_1 f'_c)^{1/3} + 1.5 k_1 \sigma_{cp}] b_w d + 0.9 d f_y A_{sw} / s \quad (9)$$

where  $C_{R,c}$  is the shear strength of concrete;  $k = (1 + \sqrt{200/d}) \leq 2.0$  with  $d$  in mm;  $\rho_1$  is the tensile reinforcement ratio, and it is not greater than 0.02; the recommended value of  $k_1$  is 0.15;  $\sigma_{cp}$  is the axial stress of column due to axial loading, which is not greater than 0.2 times of concrete compressive strength;  $A_{sw}$  is cross-sectional area of the shear reinforcement and  $s$  is the spacing of links. In the calculation of this study, the

partial factor of 1.5 for concrete is not considered (Parker 1997).

#### 4.6 Comparison analysis

The experimental results of the specimens and comparison with the shear strength predicted by the different design codes are presented in Table 3.

In both design codes ACI 318-14 and NZS 3101, the prediction trend of joint shear strength is similar. For beam-column joints with insufficient transverse link in joint cores of the test specimens, the experimental results are lower than the predicted values of the codes, where the test shear strength of specimen HKOL-400-L is only 53% of the ACI 318 code prediction, but only 47% of the predicted value of NZS 3101. The predicted shear strength of Eurocode 8 is more conservative than that of joints without horizontal links but underestimates the shear strength of the other two specimen with horizontal links in joint core. The seismic design codes are shown to overestimate the shear strength and not recommended for predicting the seismic performance of beam-column joints without appropriate seismic design details.

Table 3 Experimental results and comparisons with design codes

Specimen	Experimental shear strength $V_{exp}$ : kN	Seismic design codes			Non-seismic design codes	
		$V_{exp}/V_{ACI}$	$V_{exp}/V_{Nzs}$	$V_{exp}/V_{EC8}$	$V_{exp}/V_{HK}$	$V_{exp}/V_{EC2}$
HKOL-200	248.8	0.98	0.78	0.75	-	3.32
HKOL-400	144.9	0.62	0.53	0.49	-	1.16
HKOL-400-L	117.3	0.53	0.47	1.10	0.56	0.65
HKOL-400-LL	113.2	0.66	0.76	1.22	0.27	0.41

The shear strength is considered as a combined action of shear forces in the uncracked concrete compression zone and the reinforcement in joint cores, for Eurocode 2, which has a relatively good prediction of the seismic performance of the joints, which is much better than that of the Hong Kong Code (It does not calculate the shear strength of joints without stirrups in joint cores), but gives too conservative predictions of the shear strength of the non-seismic detailed beam-column joints with low concrete compression strength.

## 5. CONCLUSION

Four non-seismically designed RC beam-column joints with different beam-column depth ratio and stirrup ratio are tested under reversed cyclic loading in this study. Based on the analysis of the test results and the comparison with the predicted values of different design codes, the following conclusions are drawn.

(a) The beam-column depth ratio has a significant effect on the shear strength and failure mode of the non-seismically designed RC exterior beam-column joints. The shear strength decreases significantly as the beam-column depth ratio increase: when the beam-column depth ratio increases from 1 to 2, the normalized shear stress is reduced by about 40% in this study, and one more needs to be noted that the failure

mode changes from ductility damage to brittle failure.

(b) The transverse links placed in the joint core can improve the ductility and enhance seismic behavior. The shear strength of the specimen HKOL-400-LL with two horizontal links is only about 10% higher than that without stirrups in the joint core, which shows the improvement of the seismic performance of joints caused by horizontal links is limited.

(c) Although 2T10 horizontal links are placed in the joint core of specimen with high beam-column depth ratio (such as 2.0), brittle shear failure of the joint observed before the beam end yielded, which was different from the ductile failure of the low beam-column depth ratio (such as 1.0), which indicates that the beam-column depth ratio has a more obvious effect on the seismic performance of the joints than the horizontal link.

(d) In general, when the effect of concrete compressive strength is ignored, the shear strength of the joints is underestimated in Eurocode 2, while other design codes are obviously overestimated. So, the current design codes are not recommended to predict the seismic performance of beam-column joints without appropriate seismic design details, and it is necessary to develop rational methods to analyze and design the RC beam-column joints with non-seismic detailed.

## 6. ACKNOWLEDGEMENT

The work described in this paper was fully supported by a grant from the Research Grants Council of the Hong Kong Special Administrative Region, China (UGC/FDS25/E08/17).

## REFERENCES

- Moehle, J. P., and Mahin, S. A. (1991), "Observations on the behavior of reinforced concrete buildings during earthquakes," *Earthquake-Resistant Concrete Structures—Inelastic Response and Design, SP-127, S. K. Ghosh, ed., American Concrete Institute*, 67-89.
- Sezen, H., Whittaker, A. S. Elwood K. J. and Mosalam, K. M. (2003), "Performance of reinforced concrete buildings during the August 17, 1999, Kocaeli, Turkey, Earthquake, and seismic design and construction practice in Turkey", *Engineering Structures*, **25**(1), 103-114.
- Earthquake Engineering Research Institute (EERI),(2001), "Chi-Chi, Taiwan, Earthquake of September 21, 1999", *Reconnaissance Report No. 2001-02, EERI*, Oakland, Calif.
- Kuang, J.S. and Wong, H.F. (2005), "Improving ductility of non-seismically designed RC columns", *Proceeding of Institution of Civil Engineer, Structures and Buildings*, **158**(1),13-20.

- Lee, J.Y., Kim, J.Y. and Oh, G.J. (2009), "Strength deterioration of reinforced concrete beam-column joints subjected to cyclic loading", *Engineering Structures*, **31**(9), 2070-2085.
- Choi, K.K., Dinh, N.H. and Kim, j.c. (2017), "Behaviour of non-seismic detailed reinforced-concrete beam-column connections", *Proceeding of Institution of Civil Engineer, Structures and Buildings*, **170**(SB7),504-520.
- Scott, R.H. (1992), "The effects of detailing on RC beam/column connection behaviour", *The Structural Engineer*, **70**(18), 318-324.
- Hegger, J., Sherif, A. and Roeser W. (2003), "Nonseismic design of beam-column joints", *ACI Structural Journal*, **100**(5), 654-664.
- Building Department (2013), *Code of Practice for Structural Use of Concrete 2013*, Building Department, Mongkok, Kowloon, Hong Kong.
- Paulay, T. and Priestley, M.J.N. (1992), *Seismic Design of Reinforced Concrete and Masonry Buildings*, Wiley, New York.
- Kuang, J.S. and Wong, H.F. (2006), "Effects of beam bar anchorage on beam-column joint behaviour", *Proceeding of Institution of Civil Engineer, Structures and Buildings*, **159**(SB2),115-124.
- Wong, H.F. (2005), *Shear Strength and Seismic Performance of Non-seismically Designed Reinforced Concrete Beam-column Joints*, HKUST, Hong Kong.
- American Concrete Institute (2014), *Building code requirements for structural concrete (ACI 318-14) and Commentary (ACI 318R-14)*, ACI, Farmington Hills, MI.
- STANDARDS NEW ZEALAND (2017), *Concrete structures standard-Amendment 1,2 and 3*, Standards New Zealand, Wellington.
- CEN (2013) *EN 1998-1:2004+A1:2013. Eurocode 8: Design of structures for earthquake resistance-Part 1: General rules, seismic actions and rules for buildings*, CEN, Brussels, Belgium.
- CEN (COMITÉEUROPÉEN DE NORMALISATION) (2014) *EN 1992-1-1:2004+a1:2014(E). Eurocode 2: Design of concrete structures-Part1-1: General rules and rules for buildings*, CEN, Brussels, Belgium.
- Parker, D.E. and Bullman, P.J.M. (1997), "Shear strength within reinforced concrete beam-column joints", *The Structural Engineer*, **75**(4), 53-57.