

Project

Dynamic Cabin Air Contamination Calculation Theory

Author: Marcel Lakies

Supervisor: Prof. Dr.-Ing. Dieter Scholz, MSME

Submitted: 2019-03-01

*Faculty of Engineering and Computer Science
Department of Automotive and Aeronautical Engineering*

DOI:

<https://doi.org/10.15488/4543>

URN:

<https://nbn-resolving.org/urn:nbn:de:gbv:18302-aero2019-03-01.015>

Associated URLs:

<https://nbn-resolving.org/html/urn:nbn:de:gbv:18302-aero2019-03-01.015>

© This work is protected by copyright

The work is licensed under a Creative Commons Attribution-NonCommercial-ShareAlike 4.0 International License: CC BY-NC-SA

<https://creativecommons.org/licenses/by-nc-sa/4.0>



Any further request may be directed to:

Prof. Dr.-Ing. Dieter Scholz, MSME

E-Mail see: <http://www.ProfScholz.de>

This work is part of:

Digital Library - Projects & Theses - Prof. Dr. Scholz

<http://library.ProfScholz.de>

Published by

Aircraft Design and Systems Group (AERO)

Department of Automotive and Aeronautical Engineering

Hamburg University of Applied Science

This report is deposited and archived:

- Deutsche Nationalbibliothek (<https://www.dnb.de>)
- Repositorium der Leibniz Universität Hannover (<https://www.repo.uni-hannover.de>)
- Internet Archive (<https://archive.org>)
Item: <https://archive.org/details/TextLakies.pdf>

This report has associated published data in Harvard Dataverse:

<https://doi.org/10.7910/DVN/O4HCUP>

Abstract

In this report an equation is derived to calculate the dynamic effect of primary and secondary aircraft cabin air contamination. The equation is applied in order to understand implications and hazards. Primary contamination is from an outside source in form of normal low level contamination or high level contamination in a failure case. Secondary contamination originates from deposited material released into the cabin by a trigger event. The dynamic effect is described as an initial value problem (IVP) of a system governed by a nonhomogeneous linear first order ordinary differential equation (ODE). More complicated excitations are treated as a sequence of IVPs. The ODE is solved from first principles. Spreadsheets are provided with sample calculations that can be adapted to user needs. The method is not limited to a particular principle of the environmental control system (ECS) or contamination substance. The report considers cabin air recirculation and several locations of contamination sources, filters, and deposit points (where contaminants can accumulate and from where they can be released). This is a level of detail so far not considered in the cabin air literature. Various primary and secondary cabin contamination scenarios are calculated with plausible input parameters taken from popular passenger aircraft. A large cabin volume, high air exchange rate, large filtered air recirculation rate, and high absorption rates at deposit points lead to low contamination concentration at given source strength. Especially high contamination concentrations would result if large deposits of contaminants are released in a short time. The accuracy of the results depends on the accuracy of the input parameters. Five different approaches to reduce the contaminant concentration in the aircraft cabin are discussed and evaluated. More effective solutions involve higher implementation efforts. The method and the spreadsheets allow predicting cabin air contamination concentrations independent of confidential industrial input parameters.

Dynamic Cabin Air Contamination Calculation Theory

Task for a project

Background

In recent years health concerns associated with contaminated cabin air in aircraft have gained public attention. These concerns were raised by crew and passengers about potential health effects causing neurotoxic symptoms. Engine oil got into focus with its additive called tricresyl phosphate (TCP), an organophosphate. TCP can enter already during normal operation in small quantities from the engine bearings through bearing seals via bleed air (taken from the engine's compressor) into the aircraft cabin. Problems are pronounced in failure cases leading to Cabin Air Contamination Events (CACE) – commonly known as fume events or smell events. Recently, also the dynamics of the contamination concentration in the cabin was discussed. If a certain amount of oil gets released at one point in time, the concentration of e.g. hydrocarbons in the cabin will initially increase and will subsequently quickly decrease again. Oil residue may also deposit in bleed ducts or cabin air ducts. Upon a trigger event these accumulated deposits could theoretically be released in a short time, which could substantially increase the concentration of various substances in the cabin.

Task

The dynamics of the concentration of cabin air contaminants should be explained with all equations well derived and with worked examples well visualized. These steps should be followed:

- Short review of the aircraft air conditioning system.
- Short review of possible air contamination sources and the types of contaminants.
- Short review of the means to reduce the contaminant concentration.
- Derivation of equations for the dynamics of the concentration of cabin air contaminants.
- Calculation of selected example scenarios.
- Discussion of results, conclusions and recommendations for further research.

The report has to be written in English based on German or international standards on report writing.

Content

	Page
List of Figures.....	7
List of Tables.....	8
List of Symbols.....	9
List of Abbreviations.....	11
1 Introduction	12
1.1 Motivation.....	12
1.2 Objectives	12
1.3 Structure of the Project	12
2 Aircraft Air Conditioning System	14
2.1 Purpose	14
2.1.1 Cabin Air Ventilation	14
2.1.2 Temperature Control.....	17
2.1.3 Pressure Control.....	18
2.2 System Architecture.....	19
2.2.1 Bleed Air System.....	19
2.2.2 No-bleed System.....	21
3 Air Contamination Sources	23
3.1 Emissions within the Cabin	23
3.2 Outside Air.....	23
3.3 Air Conditioning Process.....	24
3.4 Sinks and Surfaces of Duct System	24
4 Types of Contaminants	26
4.1 Biologic Aerosols	26
4.2 Combustion Particles	27
4.3 CO and CO ₂	27
4.4 Ozone.....	28
4.5 Volatile Organic Compounds	28
4.6 Organophosphorus Compounds	29
5 Means to Reduce Contaminant Concentration	31
5.1 Increase of Cabin Air Exchange Rate.....	31
5.2 Adding Filters	31
5.3 Cleaning of Duct System	32
5.4 Redesign of Duct System.....	32
5.5 Redesign of Bleed Air System.....	33

6	Derivation of Equations	34
6.1	Simplified Air Flow Model	34
6.2	Mathematical Approach.....	36
6.3	Solving the Differential Equation	40
6.4	Initial Value Problem.....	44
6.5	Conversion into Parts Per Million	45
6.6	Calculation of Source Strength of Secondary CACE	45
7	Calculation of Example Scenarios	48
7.1	Scenario Primary CACE.....	48
7.1.1	Basic Scenario of Primary CACE	48
7.1.2	Variation of Source Strength	53
7.1.3	Variation of Cabin Volume	55
7.1.4	Variation of Air Exchange Rate	56
7.1.5	Variation of Portion of Recirculated Air	57
7.1.6	Variation of Duct System Parameters.....	58
7.1.7	Variation of Filter Parameters	59
7.2	Scenario Secondary CACE.....	60
7.2.1	Basic Scenario of Secondary CACE.....	60
7.2.2	Variation of Event Position	64
7.2.3	Variation of Filter Parameters	66
7.2.4	Variation of Operating Time	67
7.2.5	Variation of Release Time	69
7.3	Discussion of Results.....	71
7.3.1	Analysis of Short and Long-Term Contamination Scenarios.....	71
7.3.2	Evaluation of Specific Results Obtained in Examples	72
7.3.3	General Observations with Regard to CACE	72
7.3.4	Effectiveness of Means to Reduce Contaminant Concentration	74
7.4	Spreadsheets for Calculation of Example Scenarios	77
8	Summary	79
	References	81

List of Figures

Figure 2.1	Cabin airflow pattern in an Airbus A321 aircraft (Scholz 2005).....	15
Figure 2.2	Cabin airflow pattern in a Boeing 767 aircraft (NAP 1986).....	16
Figure 2.3	Boeing 767 architecture air conditioning system 3D (Hunt 1994).....	19
Figure 2.4	Boeing 767-200 architecture air conditioning system 2D (NAP 1986).....	19
Figure 2.5	Airbus A321 architecture air conditioning system (Scholz 2005).....	20
Figure 2.6	Boeing 787 A321 architecture air conditioning system (Boeing 2005).....	21
Figure 3.1	Illustration of primary and secondary CACE (EASA 2017).....	25
Figure 3.2	Duct Sections inspected by UK Civil Aviation Authority (CAA 2004).....	25
Figure 6.1	Outer boundaries of passenger cabin volume (FAA 2008).....	34
Figure 6.2	Cabin as single box with interfaces to air con. system and environment.....	35
Figure 6.3	Air flow model with positions where secondary CACE might occur.....	46
Figure 7.1	TCP source strength of outside air at scenario P0.....	49
Figure 7.2	TCP source strength of conditioning process at scenario P0.....	50
Figure 7.3	TCP concentration in the cabin at scenario P0.....	52
Figure 7.4	First three time intervals of scenario P0.....	52
Figure 7.5	TCP source strength related to conditioning process at P0 and P1A-C.....	53
Figure 7.6	TCP concentration in the cabin at scenario P0 and variations P1A-C.....	54
Figure 7.7	TCP concentration in the cabin at scenario P0 and variation P2.....	55
Figure 7.8	TCP concentration in the cabin at scenario P0 and variations P3A and P3B.....	56
Figure 7.9	TCP concentration in the cabin at scenario P0 and variation P4.....	57
Figure 7.10	TCP concentration in the cabin at scenario P0 and variations P5A and P5B.....	58
Figure 7.11	TCP concentration in the cabin at scenario P0 and variations P6A and P6B.....	59
Figure 7.12	TCP source strength of outside air at scenario S0.....	61
Figure 7.13	TCP source strength related to secondary event at scenario S0.....	62
Figure 7.14	TCP concentration in the cabin at scenario S0.....	63
Figure 7.15	Last two time intervals of scenario S0.....	63
Figure 7.16	TCP source strengths related to secondary event at S0, S1A and S1B.....	65
Figure 7.17	TCP concentration in the cabin at scenario S0 and variations S1A and S1B.....	65
Figure 7.18	TCP concentration in the cabin at scenario S0 and variations S2A and S2B.....	66
Figure 7.19	TCP source strength secondary event at scenario S0 and variation S3.....	67
Figure 7.20	TCP concentration in the cabin at scenario S0 and variation S3.....	68
Figure 7.21	TCP source strengths related to secondary event at S0 and variations S4A-D.....	69
Figure 7.22	TCP concentration in the cabin at scenario S0 and variations S4A-D.....	70
Figure 7.23	Screenshot of worksheets used for calculation of primary CACE.....	77

List of Tables

Table 2.1	Overview air exchange rate and recirculated air (NRC 2002)	15
Table 7.1	Variable TCP source strengths at scenario P0	51
Table 7.2	Variable TCP source strengths at scenario S0	62

List of Symbols

a	Parameter introduced to shorten differential equation
b	Parameter introduced to shorten differential equation
c	Concentration of analyzed contaminant
C	Constant of integration
M	Mass of contaminant accumulated along section of duct system
p	Pressure
R	Specific gas constant
S	Contamination source strength
t	Time
T	Temperature
V	Volume
\dot{V}	Flow rate

Greek Symbols

α	Portion of the analyzed contaminant that passes a filter or duct section
β	Portion of accumulated contaminant mass that is released during event
ε	Weakening coefficient for secondary CACE
η	Filter efficiency with respect to analyzed contaminant
λ	Total air exchange rate
ρ	Density
τ	Absorption rate
θ	Portion of recirculated air

List of Subscripts

0	Initial
avg	Average
ca	Conditioned air
cab	Cabin
con	Constant
cp	Conditioning process
d	Duct
f	Filter

i	Internal
in	Mixed air
lin	Linear
oa	Outside air
op	Operation
rec	Recirculated air
rel	Release
s	Secondary

List of Abbreviations

BDP	Butyldiphenyl Phosphate
CACE	Cabin Air Contamination Event
DoCP	Di-ortho-Cresyl Phosphate
DPP	Dibutylphenyl Phosphate
EASA	European Aviation Safety Agency
ECU	Environmental Control Unit
FAA	Federal Aviation Administration
HEPA	High Efficiency Particulate
ISA	International Standard Atmosphere
IVP	Initial Value Problem
JAR	Joint Airworthiness Requirements
MoCP	Mono-ortho-Cresyl Phosphate
NAP	National Academy Press
ODE	Ordinary Differential Equation
OPC	Organophosphorus Compound
PPB	Parts Per Billion
PPM	Parts Per Million
TBP	Tri- n-Butyl Phosphate
TCP	Tricresyl Phosphate
ToCP	Tri-ortho-Cresyl Phosphate
TPP	Triphenyl Phosphate
VDI	Verein Deutscher Ingenieure
VOC	Volatile Organic Compound

1 Introduction

1.1 Motivation

In recent years health concerns raised by crew and aircraft passengers have been reported. These concerns focus mostly on the air quality in aircraft cabins and potential health effects causing neurotoxic symptoms. There is a highly controversial, often emotional debate on so called fume events associated with the release of neurotoxic substances coming from engine oils or hydraulic fluids. In this context it is sometimes referred to the Aerotoxic Syndrome describing a combination of mainly non-specific symptoms related to the exposure to certain chemicals. Various studies have been conducted on cabin air quality. However, exposure processes and the effects on the human body are still unclear. This project aims at contributing to the ongoing research activities by investigating the cabin air contamination situation out of an engineering perspective. It is focused on the factors influencing the contaminant concentration in cabin air and the way contaminants travel through the system. Aspects of this flow behavior that are considered are the position within the system where contaminants are released, their release pattern, the amount that actually enters the cabin and how long contaminants remain there before being sucked out of the cabin.

1.2 Objectives

The main objective of this report is to develop a dynamic model that describes the air flow within the air conditioning system and cabin. Based on that model an equation shall be derived and applied in order to investigate how the concentration of a chosen contaminant in cabin air changes with time under assumed circumstances. The air flow model and the associated equations shall not focus on a specific system architecture or a specific toxic substance. Instead, they are intended to be valid for various system architectures and different types of contaminants.

1.3 Structure of the Project

Chapter 2 gives an overview of the purpose and architecture of air conditioning systems installed on aircraft. All following chapters are based on the facts and background information presented in this chapter.

- Chapter 3** identifies the various contamination sources and explains how contaminants can potentially enter the cabin air.
- Chapter 4** investigates which types of contaminants exist in cabin air. It is discussed which level of exposure can potentially be harmful to passengers and crew with regard to short and long-term health effects.
- Chapter 5** identifies different means that can potentially lead to a reduction of contaminant concentration in cabin air.
- Chapter 6** describes the derivation of an equation that allows to calculate how the concentration of a chosen contaminant in cabin air changes with time. Before the equation can be applied a number of assumptions need to be made. If the input parameters are chosen accordingly, the equation can be applied to all sorts of air conditioning system designs and to almost any contaminant.
- Chapter 7** investigates example scenarios by applying the equation derived in Chapter 6. Different variations of the scenarios and system parameters are investigated in order to analyze how effective the approaches defined in Chapter 5 are when it comes to reducing the contaminant concentration in cabin air. Spreadsheets are provided that can be used as a starting point when conducting calculations of further cabin air contamination scenarios.
- Chapter 8** is a summary of this project.

2 Aircraft Air Conditioning System

2.1 Purpose

In the troposphere air temperature is not constant. It decreases with increasing altitude. At 11000 m, where the stratosphere starts, the temperature reaches - 56.5 °C. Air pressure also changes with altitude. The higher the altitude, the lower the pressure. At cruising altitude of commercial aircraft which is approximately 10000 m, the pressure amounts $\frac{1}{4}$ of the pressure at sea level. Hence, the conditions at cruising altitude with regard to air temperature and pressure are not survivable for humans. (**Scholz 2005**)

In general, the purpose of an air conditioning system installed on aircraft is to provide safe life conditions for crew and passengers and to provide passenger comfort. This objective can be broken down into three main functions: cabin air ventilation, temperature control, and pressure control.

2.1.1 Cabin Air Ventilation

Commercial aircraft are designed for high passenger densities in the cabin. In order to guarantee safety and comfort, a certain air exchange rate is required. Therefore, fresh air needs to be supplied using cabin air outlets. Certification requirements define minimum standards which need to be fulfilled. The Joint Airworthiness Requirement (JAR) 25.831 asks for a supply of 4,7 l/s fresh outside air for each crew member. However, manufacturers often provide at least 7,8 l/s outside air for each person in the cabin in order to increase passenger comfort. The air supplied to the cabin typically involves fresh outside air as well as recirculated air. In case of the Airbus A321, for example, the portion of recirculated air θ amounts 40% of the total air that enters the cabin through cabin air outlets. (**Scholz 2005**)

According to **Hunt 1994** the makeup of air in the mixing chamber of Boeing 767 aircraft is approximately 50% recirculated air and 50% outside air. Table 2.1 gives more information about the portion of recirculated air on different aircraft types. It becomes obvious that cockpits are usually not supplied with recirculated air.

Modern aircraft cabins typically provide total air exchange rates λ of 20 to 30 per hour and outside air exchange rates of 10 to 15 per hour. This is more than in other environments. Trains provide outside air exchange rates of 8 h^{-1} , hospital delivery and operating rooms 5 h^{-1} , and office buildings up to $2,5 \text{ h}^{-1}$ (**Bagshaw 2015**). However, the occupant density has to be considered when comparing these numbers. The occupant density expresses the number of passengers per square meter. Compared to other environments aircraft cabins offer relatively

high occupant densities and thus a higher air exchange rate is needed in order to ensure a certain supply of fresh air for each passenger or crew member. More detailed information about the total air exchange rate on various aircraft types is given in Table 2.1. It has to be noted that the total air exchange rate in the cockpit is usually higher than in the cabin.

Table 2.1 Overview air exchange rate and recirculated air (NRC 2002)

Aircraft Type	Total Air Exchange Rate λ in 1/h		Portion of Recirculated Air θ in %	
	Cabin	Cockpit	Cabin	Cockpit
Boeing 727-100	21,6 - 24,8	31,7 - 36,2	0	0
Boeing 737-300	21,8 - 24,8	35,0 - 40,5	34 - 47	0
Boeing 747-300	18,0 - 21,3	29,9 - 37,1	23 - 27	0
Boeing 757	29,7 - 34,3	57,6 - 61,9	48 - 55	0
Douglas MD-82	16,7 - 25,9	35,3 - 67,2	0 - 44	0
Douglas DC-10	21,6 - 23,2	77,5 - 83,8	38	0
Airbus A300-300	19,0 - 61,0	66,4 - 78,7	0	0
Airbus A310-200	20,6 - 25,4	49,1 - 64,1	37 - 53	0

The distribution of conditioned air to the cabin is defined by the duct diameters and orifices which balance the flow. The supplied air enters the cabin through fixed cabin air outlets positioned in the sidewalls or ceiling. Air is exhausted from the cabin through floor-level cabin air exhausts. Cabin air outlets and air exhausts run the length of the cabin on both sides along the sidewall. (NAP 1986)

As a result of that, a two-dimensional airflow is created. Most of the air supplied to one seat row exits the cabin at the same seat row and thus airflow in fore and aft direction is minimized. Figures 2.1 and 2.2 show the airflow patterns of an Airbus A321 and a Boeing 767 respectively.

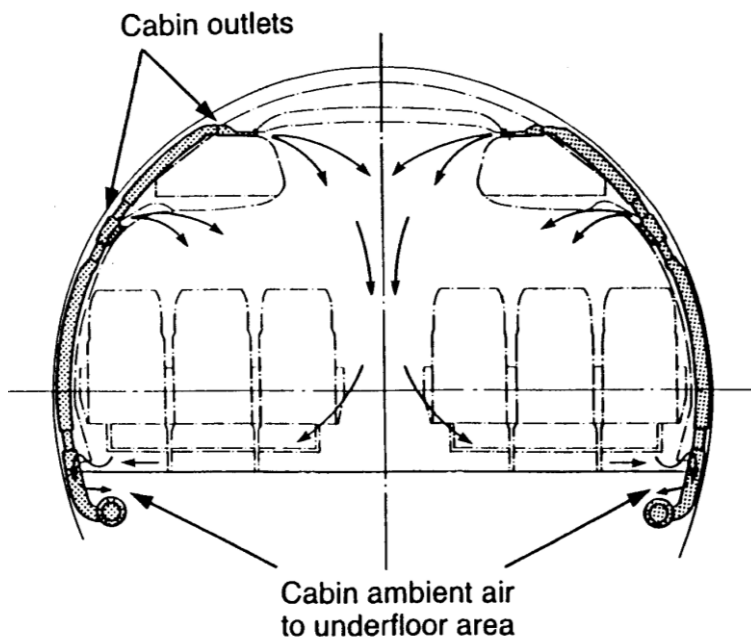

Figure 2.1 Cabin airflow pattern in an Airbus A321 aircraft (Scholz 2005)

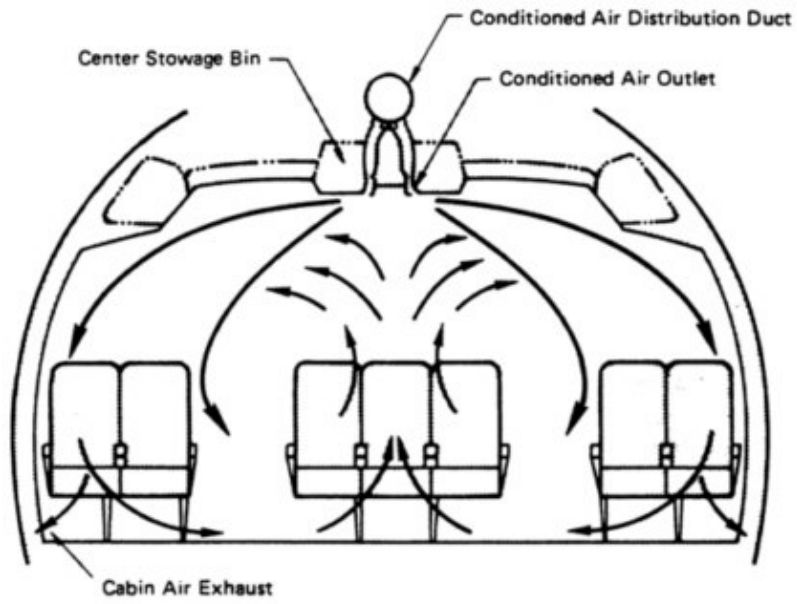

Figure 2.2 Cabin airflow pattern in a Boeing 767 aircraft (NAP 1986)

2.1.2 Temperature Control

Typically, a target temperature between 18 °C and 30 °C can be selected by the crew for each individual temperature-controlled cabin zone (Scholz 2005). Wide-body aircraft might have up to six cabin zones, whereas narrow-body aircraft often have two zones (NAP 1986). The temperature of the conditioned air supplied by the cabin air outlets depends on the cooling or heating requirements of the related cabin zone. These are determined by the chosen target temperature and the current air temperature measured in each cabin zone.

The total rate of heat flow is expressed in Watts and determines how the actual cabin temperature is changing with time. A positive total rate of heat flow causes an increase in cabin temperature, while a negative total rate of heat flow reduces the cabin temperature. If the total rate of heat flow is zero, then the cabin temperature does not change. However, maintaining the cabin temperature generally does not mean that the supplied conditioned air has the same temperature as the cabin temperature. Several internal and external factors have an influence on the total rate of heat flow. Passengers, sun radiation, and electronic devices including the In-Flight Entertainment System all cause positive rates of heat flow. The influence of passengers varies depending on the density of seats and the seat load factor in a specific cabin zone. Moreover, electric devices are not uniformly distributed throughout the cabin. The outside temperature contributes with a negative rate of heat flow when the aircraft is in cruising altitude.

When the aircraft is on the ground, positive or negative rates of heat flow can occur, depending on whether the outside temperature is higher or lower than the cabin temperature. In most operating scenarios the total rate of heat flow excluding the influence of the conditioned air is positive. In order to maintain the cabin temperature, the conditioned air entering the cabin must be cooler than the actual cabin temperature because an additional negative rate of heat flow is required to compensate the effect of the other heat sources. The higher the outside temperature, the higher the required cooling load.

Extreme heating and cooling scenarios need to be considered when it comes to designing air conditioning systems and defining the required performance. Both scenarios occur on the ground. The highest cooling load is required when the cabin temperature of an aircraft with passengers parked on a hot day shall be decreased. The highest heating load is required when the cabin temperature of an aircraft without passengers and parked outside in extreme cold weather conditions shall be increased. (Scholz 2005)

2.1.3 Pressure Control

Cabin pressurization is necessary in order to fly at high altitudes without using oxygen masks. According to the JAR 25.841 cabin altitude in pressurized cabins must not exceed 8000 ft under normal conditions. Moreover, the cabin altitude rate of climb should not exceed 2,5 m/s and the rate of descent should not exceed 1,5 m/s in order to avoid passenger discomfort. (Scholz 2005)

While the aircraft is on the ground, cabin pressure is equal to the outside pressure. Assuming that the airport is located at sea level altitude, the pressure would be 101325 Pa. While the aircraft climbs after take-off, the pressure inside the cabin is slowly reduced until the maximum cabin altitude is reached. This pressure is then kept constant during flight and increased as soon as the aircraft begins its final descent. In cruising flight, the cabin altitude of most aircraft is usually 8000 ft, whereas the Airbus A350 and Boeing 787 composite fuselages allow cabin altitudes of around 6000 ft.

The air conditioning system is indirectly involved in pressure control since it provides an approximately constant air flow into the cabin. The fully automatic cabin pressure control is achieved by modifying the air flow out of the cabin, which is done by regulated outflow valves. (Scholz 2005)

2.2 System Architecture

2.2.1 Bleed Air System

The Figures 2.3, 2.4 and 2.5 illustrate the architecture of conventional bleed air systems. Figures 2.3 and 2.4 show a Boeing 767 and Figure 2.5 shows an Airbus A321.

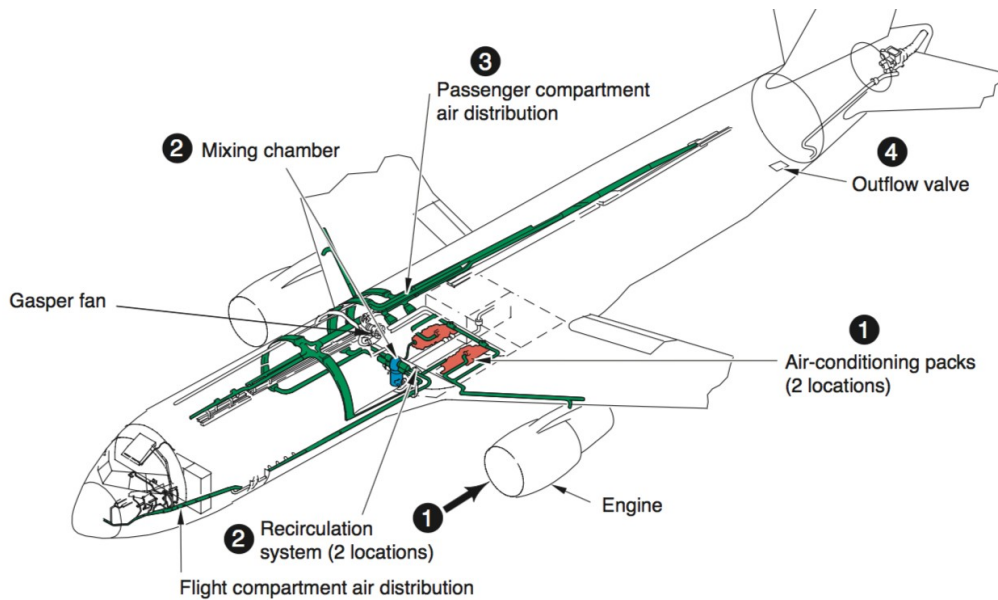

Figure 2.3 Boeing 767 architecture air conditioning system 3D (Hunt 1994)

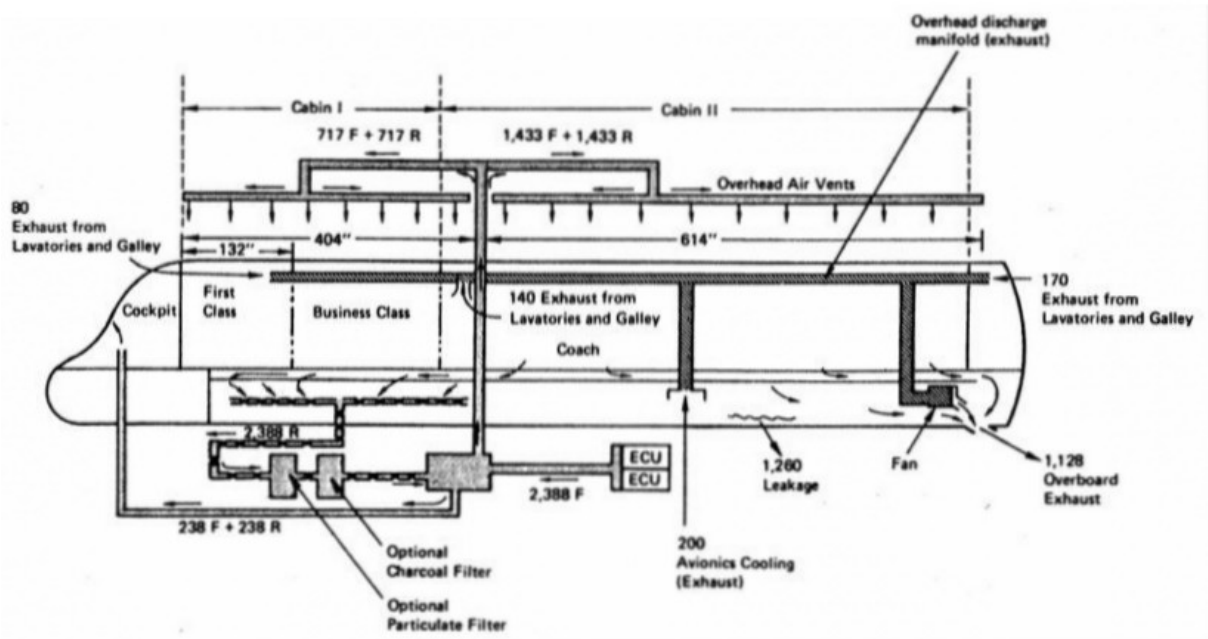

Figure 2.4 Boeing 767-200 architecture air conditioning system 2D (NAP 1986)

ECU Environmental Control Unit
 F Outside air
 R Recirculated air

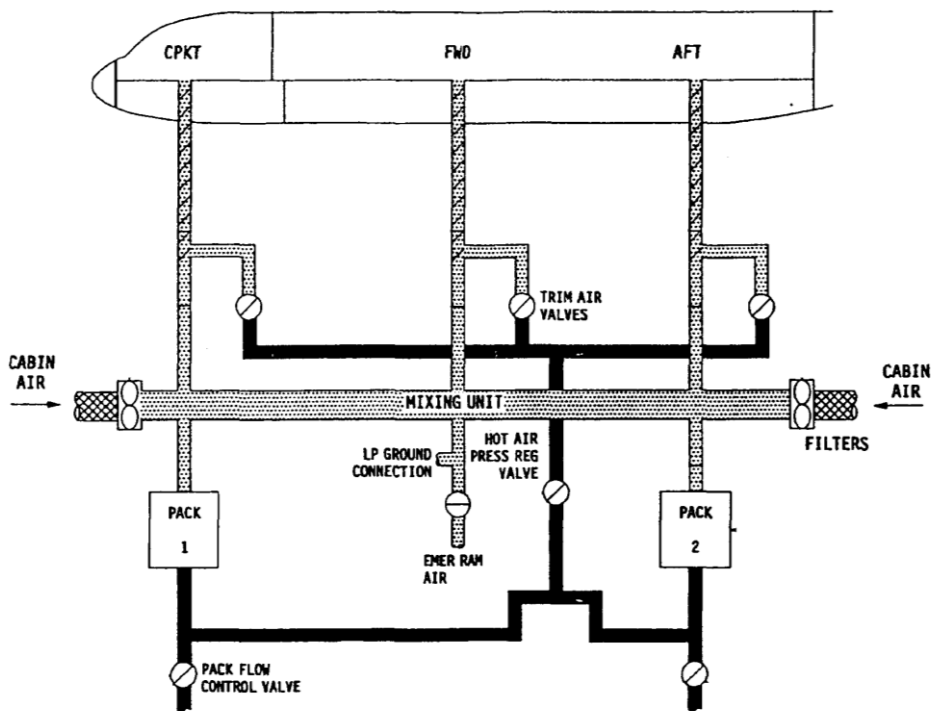

Figure 2.5 Airbus A321 architecture air conditioning system (Scholz 2005)

As shown in Figure 2.3, outside air continuously enters the aircraft engines and passes through multistage compressors where air temperature and pressure are increased. A portion of the compressed air is extracted from the intermediate compressor stage. This air is called bleed air. On its way to the cabin the bleed air enters the air conditioning pack belonging to the engine it came from. Within the packs bleed air passes through heat exchangers and is cooled down by outside air. The air then exits the packs at the required pressure and temperature for air conditioning. (NAP 1986)

Figures 2.4 and 2.5 show system architectures with three individual cabin zones including the cockpit. Each cabin zone has its own supply ducting system. As explained in Chapter 2.1.2, cabin zones might require different temperatures of the supplied conditioned air. Therefore, the temperature of the air exiting the air conditioning packs satisfies the temperature demand of the cabin zone requiring the coldest air. After the bleed air has passed through the respective air condition pack it is delivered to the mixing unit, where it is mixed with recirculated air.

Before entering the mixing unit, recirculated air is filtered using high efficiency particulate (HEPA) filters. Similar filters are installed in industrial clean rooms and critical hospital areas (Bagshaw 2015). The HEPA-type filters remove biological particles and particulates with a minimum efficiency of 94% to 99,97% (Hunt 1994). As shown in Figure 2.4, used air coming from lavatories, galleys, cargo compartment, and avionics cooling is not recirculated. It has to be noted that bleed air or mixed air typically do not pass any filter.

Air from the mixing unit is then continuously supplied to the cabin air outlets. The cabin zone with the lowest temperature demand gets the air without any further treatment. The air from the mixing unit which is supplied to cabin zones with a higher temperature demand is mixed with a certain amount of hot bleed air from the engines. The bleed air used for the purpose of attaining the individually requested zone temperature is also called trim air. The duct carrying trim air and the position of the trim air valves is shown in Figure 2.5. (Scholz 2005)

Assuming that the cabin pressure is not changed, which is the case during cruise, the same amount of air entering the cabin is also exhausted.

2.2.2 No-bleed System

As an alternative to the conventional air conditioning system architecture introduced in the previous chapter, a no-bleed air conditioning system can be installed on aircraft. The Boeing 787 is the only modern passenger aircraft which uses a no-bleed system. As shown in Figure 2.6 the system also includes two air conditioning packs. However, the air which is supplied to the packs is not bleed air from the engines. Instead, fresh outside air is brought onboard via cabin air inlets. This air is compressed by electrically driven compressors. In addition to the pressure, this procedure also increases the air temperature. Therefore, the air is then cooled down by heat exchangers using outside air in order to achieve the air temperature required for air conditioning. (Boeing 2007)

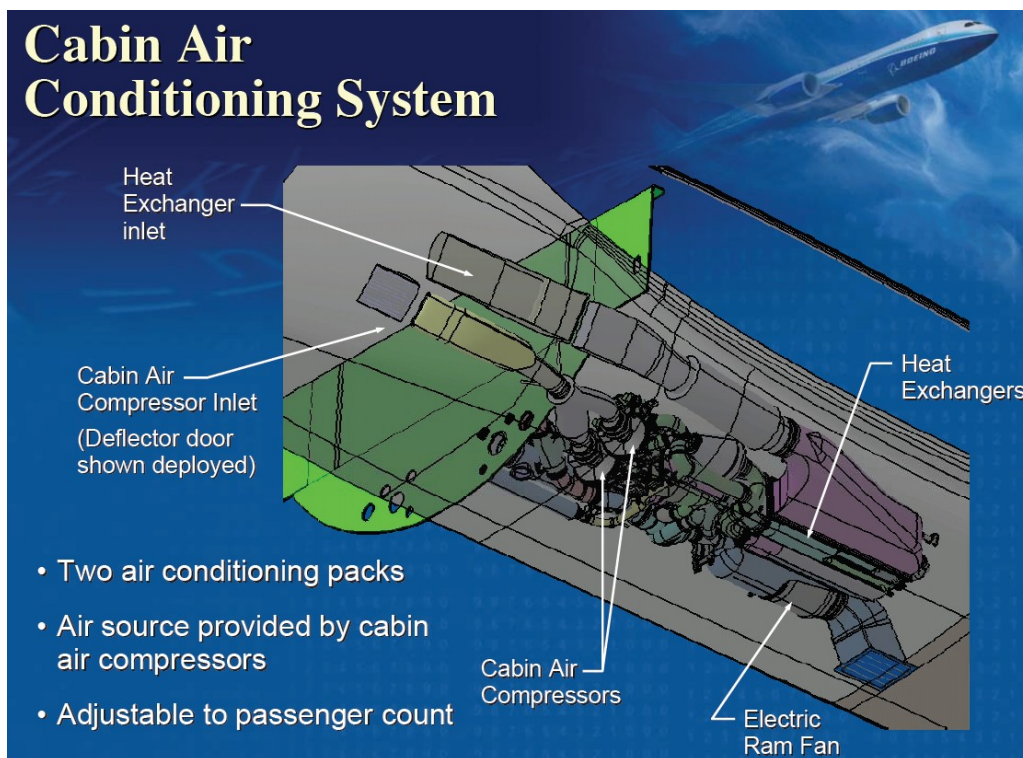

Figure 2.6 Boeing 787 architecture air conditioning system (Boeing 2005)

The components the conditioned air supplied by the packs passes through on its way to the cabin are similar to the conventional bleed air system and thus are not further explained. According to Boeing the benefits of the no-bleed electrical system architecture are reduced maintenance costs, improved reliability, as well as improved fuel consumption as a result of a more efficient secondary power extraction, usage and transfer (**Boeing 2007**).

3 Air Contamination Sources

3.1 Emissions within the Cabin

The first potential air contamination source are emissions within the cabin. On the one hand, passengers and crew can be a source of various contaminants which are spread by breathing, talking, coughing, or sneezing. On the other hand, all materials used to construct or maintain the cabin are potential contamination sources. This includes off gassing chemicals from surfaces of furnishings such as seats, curtains, or carpets, as well as pesticides and cleaning agents. (NAP 1986)

Another contamination source is the hydraulic system. On some aircraft types it vents to the interior of the aircraft. The high pressure of the system can lead to leaks and thus contaminate the cabin with hydraulic fluids. (Cannon 2016)

3.2 Outside Air

The second cabin air contamination source is outside air which enters the cabin through the air conditioning system. During flight outside air is assumed to be free of significant amounts of contaminants. However, on the ground several operations cause air contaminations and hence may affect cabin air quality.

While outside air enters the cabin during boarding, deboarding or taxiing procedures, passengers may be exposed to substances emitted by engines of ground vehicles and aircraft engines (NAP 1986). The engine exhaust during ground operations contains a significant amount of unburnt fuel because fuel burn efficiency is optimized for cruise conditions (Cannon 2016).

The maximum burden in terms of contaminated outside air is expected for aircraft which are in the last position of a queue lining up for take-off because the air sucked in for air conditioning purposes contains the cumulative exhausts of all preceding aircraft (Cannon 2016).

If the aircraft is equipped with a conventional bleed air system, a proportion of all substances sucked in by the engine ends up in the cabin. Since aircraft engines act like a suction sweeper, their intake vortices ingest everything from the ground. This includes engine oil, fuel, de-icing chemicals, any kind of surface treatment, as well as apron and runway debris. (Cannon 2016, Scholz 2017c)

3.3 Air Conditioning Process

The next cabin air contamination aspect are sources associated with the air conditioning process. In case of a conventional bleed air system it can be distinguished between the engine and the air conditioning pack as two locations where contaminants may be added to bleed air. For no-bleed air conditioning systems, it can be distinguished between the electrically driven compressor and the air conditioning pack.

Technical dysfunctions such as sealing failures can lead to the release of engine oil or hydraulic liquids into bleed air or conditioned air. Two entry scenarios have to be differentiated: permanent contaminant entry into the cabin and event triggered entry into the cabin. The event triggered contaminant entry is also known as primary cabin air contamination event. (EASA 2017)

The most prominent and controversial scenario is the occurrence of a primary cabin air contamination event (CACE) in the aircraft engine that potentially causes the contamination of bleed air. These events are also called fume events. They occur in case oil sealing leaks permit engine oil to leak into the compressor and then enter the bleed air in form of vapor or mist (NAP 1986). Little information exists about the frequency of fume events. They are assumed to occur within the range of 0,05% to 0,5% of all flights (Cannon 2016). Scholz 2017a and Scholz 2017b give further details on the technical background and explain the leaking phenomenon.

It has to be noted that no-bleed systems are not affected by the described scenario. If air bearings are used in the electrical compressor, as it is the case on the Boeing 787, it can be assumed that there is no risk of oil or hydraulic liquid contamination linked to the compressor (Cannon 2016).

3.4 Sinks and Surfaces of Duct System

The duct system carrying bleed air, conditioned air, mixed air or recirculated air offers a large surface area as well as other sinks where contaminants can be deposited on their way to the cabin. If an event triggers the release of deposited contaminants, these enter the cabin. This effect is known as a secondary CACE. Triggering events may involve physico-chemical influences on the deposit.

Figure 3.1 shows illustrations of three scenarios. Scenario A is an event free situation where contaminants are deposited. The resulting contaminant concentration in cabin air is below the limit of detection. Scenario B represents a primary CACE caused by contaminated bleed air.

Scenario C is a secondary CACE that triggers the release of deposited contaminants which then reach cabin air and lead to a contaminant concentration that is measurable. (EASA 2017)

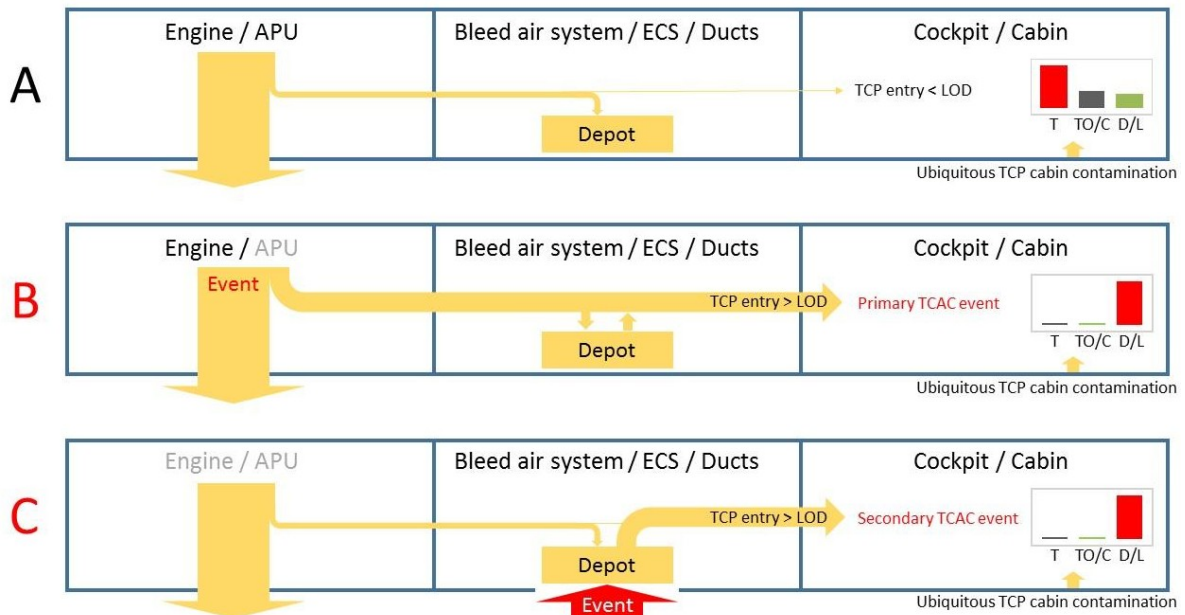

Figure 3.1 Illustration of primary and secondary CACE (EASA 2017)

The contaminants accumulating on duct sinks and surfaces can have different origins. The ducts carrying conditioned air can deposit contaminants coming from primary CACE, permanent contaminant entry, or outside air. The ducts carrying recirculated and mixed air are additionally affected by contamination sources related to cabin emissions.

It is assumed that less engine oil or oil related contaminants are released during a secondary CACE than during a primary event. Hence, secondary events may result in less severe contamination concentrations in the cabin. However, the mechanism of the spontaneous release of contaminants from deposits is still unknown. (EASA 2017)

Research carried out by the UK Civil Aviation Authority found black sooty deposit of contamination in the internal distribution ducting which was impossible to clean, shown in Figure 3.2 (CAA 2004).



Figure 3.2 Duct sections inspected by UK Civil Aviation Authority (CAA 2004)

4 Types of Contaminants

In Chapter 3 the different cabin air contamination sources have been explained. This chapter deals with the different types of contaminants that might occur in cabin air. Six different types have been identified: biologic aerosols, combustion particles, CO and CO₂, ozone, volatile organic compounds (VOC), and organophosphorus compounds (OPC). These are the contaminants that according to a literature review got the most attention in research activities on cabin air quality. It has to be noted that other types of contaminants which are not covered by this selection might exist in cabin air.

All of these different types of contaminants passengers may be exposed to can potentially be responsible for certain health problems in the long or short run. The contaminants can have point sources or be distributed more uniformly (**NAP 1986**). Thus, the location of passengers or crew members within the cabin might influence their level of exposure. Moreover, the reaction to the exposure of a certain contamination level significantly depends on the physical condition of the exposed individual. Another aspect which makes it difficult to detect, measure and attribute health effects to specific causes is the imprecise nature of many relevant symptoms (**NAP 1986**). Not only normal operating conditions need to be investigated but also unusual events or scenarios. These include the exposure of passengers and crew members with a combination of different contaminants which might interact with each other and lead to an increased health risk. These considerations show how complex it is to investigate contamination processes. Obviously, it is not sufficient to solely focus on bleed air. At this point in time still a lot of aspects are unknown, and the evaluation of this topic cannot be regarded as complete or exhaustive (**EASA 2017**).

Moreover, there are often controversies surrounding the health effect of certain contaminants and disagreement around what defines safe exposure limits or if exposure limits are justified at all. On the one hand, research on mechanisms through which different chemicals interfere with the human nervous system function cannot keep up with the speed with which new chemicals are fabricated and put out on the market (**Harrison 2016**). On the other hand, due to the reduced pressure at altitude, workplace exposure limits of toxic chemicals are not valid for aircraft in flight. For example, the recommended health limit for carbon monoxide exposure is half of the limit on sea level altitude (**Cannon 2016**).

4.1 Biologic Aerosols

Compared to other indoor environments such as apartments or offices, aircraft cabins are characterized by a higher occupant density. In the closed and ventilated cabin which is shared

by crew and passengers there is a potential risk of inhalation of airborne pollutants leading to health problems (**Wang 2008**).

The various types of biologic aerosols include for example bacteria, viruses, fungal spores, anthropod fragments, and actinomycetes. Possible sites of contamination are surfaces such as carpets and seats as well as the air conditioning system with its ducts and filters. Potential sources of biologic aerosols are passengers and crew, cargo compartment, outside air, and structural contamination of the aircraft. Outside air carries very few biologically derived particles at cruising altitude. However, a variety of fungal spores might be present in outside air while the aircraft is on the ground. Outside air usually does not contain sufficient amounts of bacteria in order to cause disease. The main source of bacterial and viruses are humans who spread these by talking, coughing and sneezing. Filtering recirculated air by removing particles larger than 3 μm reduces microbial aerosol concentrations. Aspects which influence the concentration in cabin air are the applied cabin air exchange rate, the portion of recirculated air and the filter efficiency. (**NAP 1968**)

4.2 Combustion Particles

Exhaust gases from car and aircraft traffic at airports contaminate the outside air with combustion particles. On the one hand, these particles can be sucked in by the APU or the engines while the aircraft is at the gate or taxiing. On the other hand, aircraft might cross polluted air masses while flying. This includes exhaust plumes in the low atmospheric boundary layer crossed during descent or climb as well as the exhaust plume of a preceding aircraft entered during cruise (**EASA 2017**). **VDI 2017** describes measurements of ultrafine combustion particles at the airport in Düsseldorf.

4.3 CO and CO₂

The emission source of carbon monoxide and carbon dioxide in the outside air are mainly exhaust gases from car and aircraft traffic at airports. Additionally, thermal degradation and pyrolysis of engine oils reaching hot parts of the engine can lead to various reaction products which include CO and CO₂ (**EASA 2017**). Within the cabin the predominant source of carbon dioxide are the occupants. CO₂ is the product of normal human metabolism. The carbon dioxide concentration depends on various aspects such as the cabin air exchange rate, the number of passengers and crew on board and their individual rates of carbon dioxide production which is influenced by their activity and health (**NAP 1986**).

In Germany the 8-hour time weighted average work place limits are 5000 parts per million (ppm) for CO₂ and 30 ppm for CO. During in-flight measurements performed by Fraunhofer Institute for Toxicology and Experimental Medicine the CO level has never exceeded this limit. However, CO₂ levels above 5000 ppm were found occasionally during measurements in aircraft galleys. As a result of this, dry ice stored in galleys has been identified as a potential emission source (EASA 2017).

4.4 Ozone

Ozone (O₃) is present in the atmosphere due to photochemical conversion of oxygen by solar ultraviolet radiation. A significant increase in ozone concentration occurs between the tropopause and the stratosphere which is within flight altitude of commercial aircraft. Ozone concentration increases with increasing latitude and varies with weather conditions. Thus, the level of O₃-contamination depends on both the flight level and the flight route. (NAP 1986)

Ozone is a known irritant and can be associated with different health effects. The EASA specifies that the cabin air O₃ concentration must not exceed 0,25 ppm by volume sea level equivalent at any time above flight level 320 and 0,1 ppm time-weighted average during any 3-hour interval above flight level 270 (EASA 2017).

Ozone enters the cabin with outside air through the air conditioning system. In order to reduce the O₃ concentration, outside air treatment is required. Therefore, ozone converters are used to remove a portion of the ozone from outside or bleed air before it enters the cabin. In the study described in EASA 2017, ozone concentrations above 250 parts per billion (ppb) were observed on one flight for three short periods of time, on all other flights the measured O₃-levels were remarkably low.

4.5 Volatile Organic Compounds

Volatile organic compounds are emitted from materials used to construct or maintain the cabin. These include adhesives, elastomers, lubricants, sealing compounds, coatings, cleaning agents, and pesticides. The offgassing chemicals emitted into the cabin air comprise acetone, ethanol, benzene, toluene, and n-butanol. Many of these have a serious toxicity. The level of exposure to VOCs is affected by the cabin air exchange rate, the type and amount of the offgassing products, the rate of offgassing under the given conditions, and the age of the material or product. The use of cosmetic products by passenger and in-flight meal service are

time-related emission events which also contribute to VOC contamination in the cabin. (**NAP 1986**)

In a measurement campaign involving 107 commercial flights in total 346 different VOCs were detected. Each flight about 59 VOCs were detected, of which 41% turned out to belong to the chemical group of alkenes and alkanes, 20% were aromatics, 15% esters and alcohols, 11% ketones and aldehydes, 6% halides, and 6% other VOCs (**Guan 2014a**). Risk assessment regarding possible health effects due to exposure of VOCs is complex because the specific species, concentration level, exposure time, and mixture effect of compounds need to be taken into account (**Guan 2014b**).

The measured level of VOC contamination in aircraft cabins under routine operation turns out to be similar to the one in other transportation modes or in building environments, with very few exceptions. Levels of ethanol, acetone, certain chlorinated hydrocarbons, and fuel-related contaminants are higher in aircraft cabins. (**Nagda 2003**)

4.6 Organophosphorus Compounds

Another contaminant passengers and crew can be exposed to are organophosphorus compounds. Certain OPCs are used as flame-retardants in furnishing, carpet, electronics such as entertainment devices, and plastic. Additionally, OPCs are used in commercial aircraft as anti-wear and high temperature additives in hydraulic fluids and engine oils. The use of these additives enhances the lubricant and anti-corrosion properties of the oils and fluids as well as improves their flame retardancy. Obviously, the type and concentration of the different OPCs used in a specific fluid varies depending on the purpose of the product and the manufacturer. Hydraulic fluids and engine oils often include mixtures of tricresyl phosphate (TCP), Tri-*n*-butyl phosphate (TBP), triphenyl phosphate (TPP), dibutylphenyl phosphate (DPP), and butyldiphenyl phosphate (BDP). All of these compounds are chemicals of health concern. (**EASA 2017**)

If cabin air is contaminated with hydraulic fluids or engine oils, passengers and crew potentially get exposed to OPCs. In general, these can cause sub-acute, delayed and chronic neurological, neuro-behavioral, and psychiatric syndromes. Long-term low-level exposure is also expected to cause neurotoxicity. (**Solbu 2011**)

The OPC which got the most attention in studies on cabin air quality is TCP. TCP is a toxic mixture that can cause a wide range of short or long-term neurological dysfunctions (**Bagshaw 2014**). **Michaelis 2017** and **Liyasova 2011** give an overview on symptoms which may be experienced after TCP exposure. TCP is used in engine oil with concentrations in the range of 1% to 5%.

TCP is a mixture of ten different isomers: six ortho isomers, two meta isomers, and two para isomers. In a substance labeled TCP, some or all of the ten isomers may be present. Investigations of TCP often focused on the concentration and toxicity of tri-ortho-cresyl phosphate (ToCP). However, the di-ortho and mono-ortho isomers have a higher toxicity. The di-ortho (DoCP) isomers are five times more neurotoxic than ToCP, and the mono-ortho (MoCP) isomers are ten times more neurotoxic. Taking into account the ToCP, MoCP, and DoCP portions with their respective toxicity within Mobile's engine lubricating oil, the total toxicity is by a factor of 30 000 higher compared to an analysis where only the ToCP portion is considered. (**Cannon 2016**)

Several different in-flight measurement campaigns have been carried out which observed the TCP and specifically ToCP concentrations in cabin air. Most studies conclude that the TCP or ToCP concentration is much too low in order to cause health problems. However, it has to be noted that during the flights investigated in those studies no fume event occurred. Thus, the precise level of contamination related to a fume event has never been captured (**Cannon 2016**). It can be assumed that this unknown level of contamination would be much greater than during normal operation and that the health risk would be increased significantly.

Megson 2016 has analyzed fresh and used engine oil and points out that while ToCP is not present in cabin air in a critical concentration, there might be a significant health risk from alkylated cresyl phosphates. These were identified in used oils at concentrations up to 0,69%. Since several alkylated cresyl phosphates have a similar toxicity as ToCP but have not been taken into account in many previous air quality studies, the actual risk from OPCs might have been underestimated.

5 Means to Reduce Contaminant Concentration

Five different means have been identified which potentially reduce the level of contamination in aircraft cabins. The effort needed to implement the proposed modifications varies significantly. The specific contamination sources affected by each modification also vary. In addition to internal contamination sources which are emissions within the cabin, three external contamination sources exist: outside air, air conditioning process, and sinks and surfaces of the duct system. With exception of the approach presented in Chapter 5.5, the redesign of the bleed air system, all means can be applied to both bleed and no-bleed air conditioning systems.

5.1 Increase of Cabin Air Exchange Rate

The first approach in order to reduce the contaminant concentration in the cabin is to apply an increased cabin air exchange rate. The contribution of internal contamination sources to the total level of cabin air contamination would decrease because the more frequently cabin air is exchanged, the faster the associated contaminants exit the cabin. This would cause a lower overall level of contamination in the cabin in case the mixed air is less contaminated than the cabin air.

The opposite happens to external contaminants whose source strength is proportional to the cabin air exchange rate. Assuming that the overall external source strength is higher than the internal contaminant source strength and that the ratio between fresh and recirculated air does not change, a higher cabin air exchange rate would increase the contribution of contamination related to external contamination sources and thus increase the overall level of cabin contamination. While the source strength of outside air is always proportional to the cabin air exchange rate under the given conditions, the source strength of primary and secondary CACE can also be independent of the air exchange rate. In this case, the contribution of those contamination sources is identical to the behavior of internal contamination sources.

5.2 Adding Filters

The second approach is to reduce cabin air contamination by adding filters to the system or replacing existing filters by new ones with a better efficiency regarding the type of contaminant or mix of contaminants that is aimed at. If one or more filters are installed in the recirculation path the contribution of all contamination sources to the overall contamination is reduced indirectly because the recirculated air is treated. If filters are installed in the ducts car-

rying mixed air the contribution of all external contamination sources is reduced directly and the contribution of internal sources is decreased indirectly through the recirculated air which passes these filters. In addition to the position of filters the filter efficiency regarding the contaminants which are present is crucial.

While HEPA filters which are usually installed in the recirculation path of air conditioning systems only remove biological particles and particulates, they are not designed to remove other types of contaminants. The filter manufacturer Pall offers carbon filters which are capable of removing VOCs with an efficiency of around 70%. These are already installed on parts of Lufthansa's A321 fleet and DHL's B757 cargo fleet (**Scholz 2017a**). The easiest option is to install new or additional filters in the recirculation path where HEPA filters are already in use because this duct section is directly accessible. However, installing filters in the ducts carrying mixed air would be a lot more effective with regard to reducing the overall level of contamination in cabin air.

5.3 Cleaning of Duct System

Regular cleaning of the duct system in order to remove contaminants which have accumulated in sinks and on duct surfaces would significantly mitigate the severity of secondary CACE. However, it is unclear whether it is possible to properly clean the duct system. **Cannon 2016** points out that the final narrow internal distribution ducting that reaches out to every seat row becomes impossible to clean once contaminated. In addition to the question of how the cleaning could be done and how effective this would be, it has to be noted that all other internal and external contaminant sources would not be positively affected by cleaning activities with regard to the overall cabin air contamination.

5.4 Redesign of Duct System

The next approach is a redesign of the duct system with regard to the duct surface properties. The sections of the duct system act like filters and therefore have a significant influence on the contaminant concentration in the cabin. If the ducts are modified in a way that less contaminants accumulate on their surface, this potentially mitigates the severity of secondary CACE. However, this would also mean that the impact of contaminated outside air and air contamination related to the air condition process on the overall cabin air quality is increased because more particles actually reach the cabin. If the ducts carrying recirculated air are also considered, then the contribution of internal contamination sources would indirectly be increased.

5.5 Redesign of Bleed Air System

The last approach which has been identified in order to reduce the overall cabin air contamination is a redesign of the bleed air system. On the one hand, this involves a redesign of critical components such as seals and bearings that potentially are the reason for the contamination. This can potentially lead to a reduced contaminant source strength related to the air conditioning process. However, the influence of contaminated outside air and internal emissions cannot be affected. Secondary CACE would be affected indirectly since a less powerful source strength related to the conditioning process would lead to less contaminant accumulations along the duct surfaces or other sinks.

On the other hand, a redesign towards a no-bleed system is conceivable. While this is already used on Boeing 787 aircraft, Airbus tested a no-bleed Electrical Environmental Control System developed by Liebherr Aerospace on an A320 test aircraft in 2016 (**Scholz 2017a**). If outside air does not come into contact with the engine and only air bearings are used in the air condition unit, contamination related to the conditioning process is expected to be zero. Nevertheless, the presence of contaminated outside air, internal emissions and accumulation of contaminants along duct surfaces cannot be prevented by a redesigned air conditioning system.

6 Derivation of Equations

6.1 Simplified Air Flow Model

In order to calculate the time variation in concentration of a certain contaminant in the aircraft cabin, an equation is derived. Therefore, a simplified model is introduced which describes the air flow within the air conditioning system and cabin.

The aircraft passenger cabin has a defined volume V_{cab} which depends on the aircraft model. Examples are 165,46 m³ for the Airbus A319 (**Jetcraft 2015**) and 470 m³ for the A340-600 (**EASA 2017**). Figure 6.1 illustrates the region within the fuselage cross-section that defines the outer boundaries of the cabin volume. More correctly, the total volume within the pressure seals would need to be considered "cabin volume". This also includes the cargo compartment.

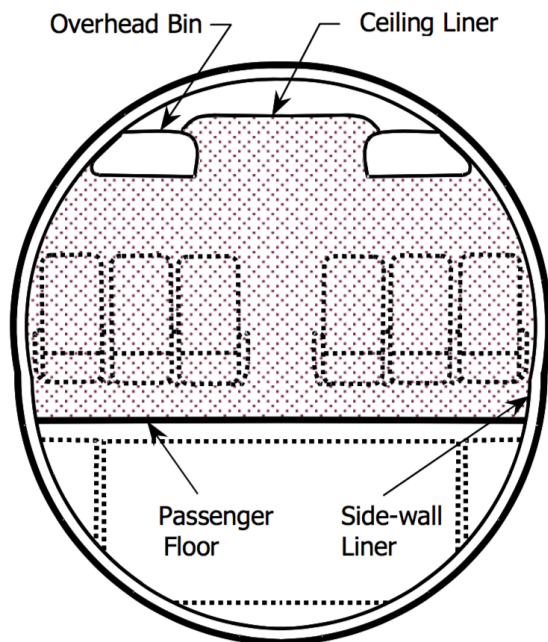

Figure 6.1 Outer boundaries of passenger cabin volume (**FAA 2008**)

The aircraft cabin with the volume V_{cab} is considered as a single box. It is assumed that the box is well mixed, i.e. the concentration of a certain contaminant is the same at every position inside the box. This approach facilitates the computation but obviously neglects the spatial distribution of the concentration of the chosen contaminant within the cabin. This has to be kept in mind when interpreting results of theoretical calculations obtained by applying the equation introduced in this chapter.

In reality, cabin air is not homogeneously mixed. Thus, the obtained concentration can be understood as an average value. Reasons for an inhomogeneous distribution of concentration are the complex geometry of interfering objects such as seats, curtains, partitions and galleys as

well as the two-dimensional type of airflow inside of the cabin. As a result of that, air exchange between individual cabin zones is hindered. Within close proximity to internal contamination sources the local concentration is expected to be higher than the overall level of concentration. Moreover, the air coming out of the cabin air outlets has a certain contaminant concentration that might differ from the average value within the cabin. If a passenger or crew member is located extremely close to an air outlet when breathing in, the exposure concentration might be higher or lower than the average concentration that has been calculated.

The derivation of an equation which describes the contaminant concentration inside the cabin over time is based on the simplified model shown in Figure 6.2.

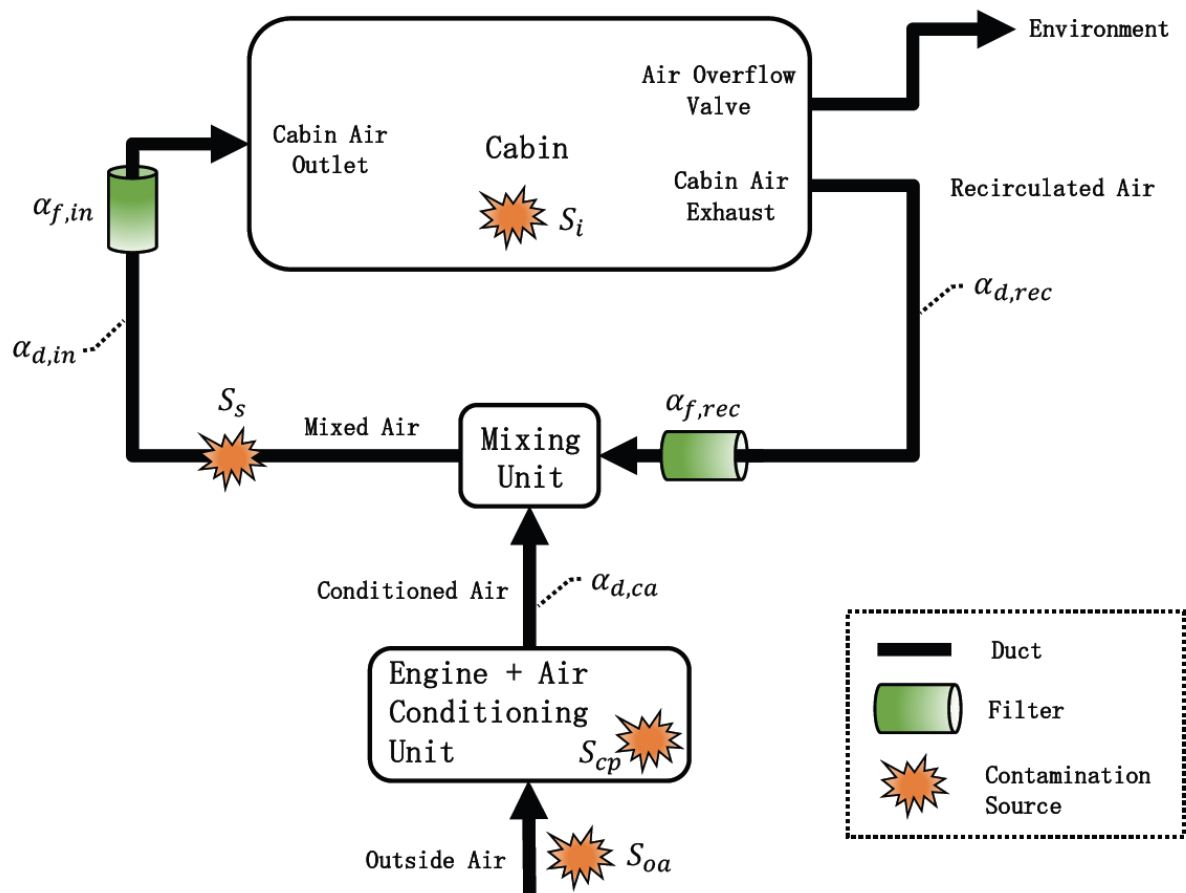

Figure 6.2 Cabin as single box with interfaces to air conditioning system and environment

The architecture of the air conditioning system in Figure 6.2 is simplified by reducing the number of ducts connecting the elements of the system. Usually aircraft air conditioning systems involve multiple air conditioning units, also called packs, which condition outside air with regard to temperature and pressure. The no-bleed system on the Boeing 787 comprises two air conditioning units and does not involve the engines. The bleed air systems on Airbus and Boeing aircraft encompass generally also comprise two air conditioning packs. Moreover, Figure 6.2 illustrates only one cabin air outlet, one air outflow valve (called "overflow valve" in Figure 6.2) and one cabin air exhaust. In reality, plenty of air outlets and air exhausts are installed throughout the cabin. Figures 2.3, 2.4 and 2.5 give an idea of the architec-

ture of the duct system. Figure 2.1 and 2.2 illustrates the position of the cabin air outlets and exhausts to the underfloor area. All four potential contamination sources identified in Chapter 3 are considered by the model and indicated with their respective source strength S . Figure 6.2 indicates the source strength S_s related to sinks and surfaces and a potential secondary CACE occurs in the duct section carrying mixed air. The source strength S_{cp} covers contamination processes while air passes the engine, bleed air passes the air conditioning unit or the bleed duct. The source strength S_{oa} covers contamination from outside.

As shown in Figure 6.2, two filter positions are assumed. One position of a filter is considered in the recirculation path. This is partial air filtration. The filter is characterized by with $\alpha_{f,rec}$. Another position of a filter is considered in the duct that carries mixed air. This is total air filtration. The filter is characterized by with $\alpha_{f,in}$. Another filter position could be in the duct for the conditioned air. Here it is also total air filtration. The parameter α determines the portion of the given contaminant which passes the filter. If α is set to one, no filter exists at the respective position. If the filter efficiency η with respect to a specific contaminant is given, α can be calculated using Equation 6.1.

$$\alpha = 1 - \eta \quad (6.1)$$

The duct system can also cause a filtering effect if a portion of the contaminants is accumulated at the duct surfaces or other sinks while passing the duct system. This effect is described by the parameters $\alpha_{d,in}$, $\alpha_{d,ca}$ and $\alpha_{d,rec}$. These accumulated contaminants are the reason for secondary CACE. The mass of the contaminants accumulated on a certain section of the duct system has a significant influence on the potential source strength related to a secondary event and can be calculated if all values for α as well as the source strengths S_i , S_{cp} and S_{oa} over a given time period are known.

6.2 Mathematical Approach

A mathematical approach to describe the change with time of the contaminant concentration inside the cabin has to be chosen. The approach is inspired by the calculations carried out in the research project **EASA 2017**. It has to be noted that the equation introduced by **EASA 2017** does not take into account cabin air recirculation, does not distinguish between different contamination sources outside versus inside of the cabin and neglects any kind of filtering or absorption effects. These aspects are all taken into account by the equation derived in this report. This approach adds complexity to the analysis of contaminant concentration within the cabin and hence requires more knowledge about certain system characteristics. However, the model of the air conditioning system introduced in this report still simplifies the

airflow into and within the cabin. Further phenomena might exist which influence the contaminant concentration but are not considered by the model developed in this report.

The rate of change of the contaminant concentration in cabin air is expressed by $(d/dt) c_{cab}$ and has the unit $\text{kg}/(\text{m}^3\text{s})$. It is influenced by the air flow into the cabin, the air flow out of the cabin, as well as emission and absorption processes within the cabin. These different contributions to $(d/dt) c_{cab}$ lead to four terms which need to be combined in order to describe the change of contaminant concentration over time.

The rate of change of the contaminant concentration in cabin air $(d/dt) c_{cab}$ is calculated by dividing the contamination source strength S_{cab} that enters the cabin by the cabin volume V_{cab} , hence

$$(d/dt) c_{cab} = S_{cab}/V_{cab} \quad (6.2a)$$

For contamination sources which are directly linked to the constantly changing concentration of the analyzed contaminant in cabin air c_{cab} , the rate of change $(d/dt) c_{cab}$ can also be calculated by multiplying the total air exchange rate λ by c_{cab} , hence

$$(d/dt) c_{cab} = \lambda \cdot c_{cab} \quad (6.2b)$$

Both Equations 6.2a and 6.2b are interchangeable because of the following two relationships that involve the flow rate \dot{V} :

$$S_{cab} = c_{cab} \cdot \dot{V} \quad (6.3a)$$

$$\lambda = \frac{\dot{V}}{V_{cab}} \quad (6.3b)$$

In the considered single box model only one air flow into the cabin is present. This is the air which enters the cabin through the cabin air outlets. The air provided by the air conditioning system can potentially be contaminated by outside air or primary and secondary CACE. Moreover, the conditioned outside air is often mixed with recirculated cabin air. The portion of recirculated air is described by the parameter θ .

While θ is assumed to be constant over the investigated time period, the different source strengths S are assumed to have either a constant or linear behavior over time. Therefore, a linear and a constant term are put together to describe the behavior of the source strengths S . Behavior of S which is parabolic, cubic or related to any higher order of t cannot be analyzed using the equation derived in this chapter.

Considering all three external contamination sources and the influence of filters and ducts as shown in Figure 6.2, the contribution of the air flow into the cabin with regard to the rate of change of the contaminant concentration in cabin air can be calculated.

Contaminants which are present in outside air or are added to the air while it is conditioned pass two sections of the duct system and one filter position before the air enters the cabin. Hence, the parameters $\alpha_{d,ca}$, $\alpha_{d,in}$ and $\alpha_{f,in}$ describing the portion of the analyzed contaminant that passes a filter or duct section need to be considered. Since the conditioned air might be mixed with recirculated air, the portion of conditioned air is described by $(1 - \theta)$.

It is assumed that contaminants released during a secondary CACE do not accumulate at duct surfaces again. The filter with the parameter $\alpha_{f,in}$ that might be installed in the duct which is passed by mixed air on its way to the cabin air outlets needs to be considered regardless of the position of the event. The filter position with the parameter $\alpha_{f,rec}$ only has to be considered in case a secondary CACE occurs in the recirculation path of the duct system. The weakening coefficient ε considers the location of the secondary CACE. If it takes place in the duct which delivers conditioned air to the mixing unit, ε is set to $1 - \theta$. If the event occurs in the duct carrying recirculated air, ε is set to $\theta \cdot \alpha_{f,rec}$. If the event takes place after the air has passed the mixing unit, the coefficient ε is set to 1.

If a recirculation path is part of the system architecture, the effect of recirculated air has to be taken into account as well. Therefore, the portion of recirculated air θ , the two passed duct sections and both filter positions have an influence on the contribution of recirculated air to the rate of change of the contaminant concentration in the cabin $(d/dt) c_{cab}$. Equation 6.4 describes the total contribution of air which enters the cabin through the cabin air outlets. For the first term that describes the influence of the source strengths related to outside air, the conditioning process and secondary CACE Equation 6.2a is used as the approach. For the second term that deals with recirculated cabin air Equation 6.2b is used as the approach.

Contribution of air flow into cabin

$$\begin{aligned} &= \frac{1}{V_{cab}} \{ (1 - \theta) \cdot (S_{oa,con} + S_{cp,con} + S_{oa,lin} \cdot t + S_{cp,lin} \cdot t) \cdot \alpha_{d,ca} \cdot \alpha_{d,in} \cdot \alpha_{f,in} \\ &+ (S_{s,con} + S_{s,lin} \cdot t) \cdot \varepsilon \cdot \alpha_{f,in} \} + c_{cab} \cdot \lambda \cdot \theta \cdot \alpha_{d,rec} \cdot \alpha_{f,rec} \cdot \alpha_{d,in} \cdot \alpha_{f,in} \end{aligned} \quad (6.4)$$

The air flow out of the cabin is assumed to be identical with the airflow into the cabin provided by the air conditioning system. Air exits the cabin through air outflow valves and in case a recirculation path is part of the system architecture also through cabin air exhausts. Since the cabin is considered as a well-mixed box, the contaminant concentration of the air flowing out of the cabin is equal to the actual overall contaminant concentration c_{cab} within the cabin at a given time t . The amount of air entering the cabin through the cabin air outlets is defined by the air exchange rate λ . Thus, the contribution of air flow out of the cabin to the overall

$(d/dt) c_{cab}$ can be expressed by Equation 6.5. It has to be noted that Equation 6.2b is used as the approach. The contribution to the rate of change of the contaminant concentration in cabin air is negative because the considered air exits the cabin.

$$\text{Contribution of air flow out of the cabin} = -\lambda \cdot c_{cab} \quad (6.5)$$

Air contamination sources that are located within the cabin are regarded as emissions. Equation 6.6 describes the contribution of the internal source strength to the overall $(d/dt) c_{cab}$. In this case Equation 6.2a is used as the approach.

$$\text{Contribution of emission processes} = \frac{1}{V_{cab}} \cdot (S_{i,con} + S_{i,lin} \cdot t) \quad (6.6)$$

The fourth aspect are absorption processes taking place within the cabin. It is assumed that the mass of absorbed contaminants is proportional to $\lambda \cdot c_{cab}$. The absorption rate τ is the constant of proportionality and describes the impact of absorption processes on the overall rate of change of the contaminant concentration. The higher the contaminant concentration c_{cab} , the stronger the sink strength and thus more kilogram of the contaminant are absorbed per second per square meter. Potential sinks within the cabin are passengers and crew as well as all surfaces.

Passengers and crew might cause some sort of filtering effect due to their constant breathing. If a certain portion of the contaminants are kept within the body, these particles are absorbed from the cabin air. This effect could be calculated if the flow rate of the air all passengers breath in as well as the difference in contaminant concentration of the air breathed in and breathed out is known. How significant this effect is depends on the specific contaminant that is analyzed. In most cases the effect might be relatively small and thus negligible.

In addition to the lungs of humans, surfaces such as carpets, curtains, seats, as well as all kinds of panels and monuments may absorb a portion of the contaminant and thereby lower the contaminant concentration in cabin air. In several research studies contaminants were found in wipe samples that were taken at various locations in aircraft cabins (**Cannon 2016**).

Equation 6.7 describes the contribution of absorption processes to $\frac{d}{dt} c_{cab}$. Equation 6.2b is used as the approach and the contribution is negative because absorption processes cause a decrease in concentration.

$$\text{Contribution of absorption processes} = -\tau \cdot \lambda \cdot c_{cab} \quad (6.7)$$

Assembly of the Equations 6.4, 6.5, 6.6 and 6.7 gives an expression for the total rate of change of the contaminant concentration in the cabin.

$$\begin{aligned} \frac{d}{dt}c_{cab} = \frac{1}{V_{cab}} \cdot \{ & S_{i,con} + S_{i,lin} \cdot t + (S_{s,con} + S_{s,lin} \cdot t) \cdot \varepsilon \cdot \alpha_{f,in} + (1 - \theta) \\ & \cdot (S_{oa,con} + S_{cp,con} + S_{oa,lin} \cdot t + S_{cp,lin} \cdot t) \cdot \alpha_{d,ca} \cdot \alpha_{d,in} \cdot \alpha_{f,in} \} + c_{cab} \cdot \lambda \\ & \cdot (\theta \cdot \alpha_{d,rec} \cdot \alpha_{f,rec} \cdot \alpha_{d,in} \cdot \alpha_{f,in} - 1 - \tau) \end{aligned} \quad (6.8)$$

It has to be noted that Equation 6.8 can be easily transformed into the equation derived in **EASA 2017** where a much simpler air flow model was used. Therefore, all α parameters describing filters need to be set to 1 and the following parameter need to be set to zero since their influence is not considered by **EASA 2017**: $\theta, \tau, S_{s,con}, S_{s,lin}, S_{cp,con}, S_{cp,lin}, S_{i,lin}, S_{oa,lin}$. The remaining $S_{i,con}$ would then represent the sum of all internal source strengths, $S_{oa,con}$ would represent the sum of all external source strengths. Rearranging Equation 6.8 gives

$$\begin{aligned} \frac{d}{dt}c_{cab} + c_{cab} \cdot \lambda \cdot (1 + \tau - \theta \cdot \alpha_{d,rec} \cdot \alpha_{f,rec} \cdot \alpha_{d,in} \cdot \alpha_{f,in}) \\ = \frac{1}{V_{cab}} \\ \cdot \{ S_{i,con} + S_{s,con} \cdot \varepsilon \cdot \alpha_{f,in} + (1 - \theta) \cdot (S_{oa,con} + S_{cp,con}) \cdot \alpha_{d,ca} \cdot \alpha_{d,in} \cdot \alpha_{f,in} \\ + t \cdot (S_{i,lin} + S_{s,lin} \cdot \varepsilon \cdot \alpha_{f,in} + (1 - \theta) \cdot (S_{oa,lin} + S_{cp,lin}) \cdot \alpha_{d,ca} \cdot \alpha_{d,in} \\ \cdot \alpha_{f,in} \} \end{aligned} \quad (6.9)$$

In order to ease further steps of calculation, the parameters a , b_1 and b_2 are introduced.

$$a = \lambda \cdot (1 + \tau - \theta \cdot \alpha_{d,rec} \cdot \alpha_{f,rec} \cdot \alpha_{d,in} \cdot \alpha_{f,in}) \quad (6.10)$$

$$b_1 = \frac{1}{V_{cab}} \{ S_{i,con} + S_{s,con} \cdot \varepsilon \cdot \alpha_{f,in} + (1 - \theta) \cdot (S_{oa,con} + S_{cp,con}) \cdot \alpha_{d,ca} \cdot \alpha_{d,in} \cdot \alpha_{f,in} \} \quad (6.11)$$

$$b_2 = \frac{1}{V_{cab}} \{ S_{i,lin} + S_{s,lin} \cdot \varepsilon \cdot \alpha_{f,in} + (1 - \theta) \cdot (S_{oa,lin} + S_{cp,lin}) \cdot \alpha_{d,ca} \cdot \alpha_{d,in} \cdot \alpha_{f,in} \} \quad (6.12)$$

Plugging a , b_1 and b_2 into Equation 6.9 simplifies to

$$\frac{d}{dt}c_{cab} + a \cdot c_{cab} = b_1 + b_2 \cdot t \quad (6.13)$$

Equation 6.13 is a linear first order ordinary differential equation (ODE) that is written in standard form. The equation only involves the function c_{cab} and first derivatives of c_{cab} . Because of that it is called first order.

6.3 Solving the Differential Equation

The next steps aim at solving Equation 6.13 for $c_{cab}(t)$. Equation 6.13 is the nonhomogeneous form of the ODE. The homogeneous form is obtained by setting the terms on the right-hand side to zero.

$$\frac{d}{dt}c_{cab} + a \cdot c_{cab} = 0 \quad (6.14)$$

The general solution of Equation 6.13 is composed of the solution of the homogeneous problem $c_{cab1}(t)$ and the solution of the nonhomogeneous problem $c_{cab2}(t)$.

$$c_{cab}(t) = c_{cab1}(t) + c_{cab2}(t) \quad (6.15)$$

First of all, the solution of the homogeneous problem is calculated. Therefore, the approach of the separation of variables is used.

$$\frac{dc_{cab}}{dt} = -a \cdot c_{cab} \Leftrightarrow \frac{dc_{cab}}{c_{cab}} = -a \cdot dt \quad (6.16)$$

Integrating both sides gives

$$\int \frac{dc_{cab}}{c_{cab}} = \int -a \cdot dt \Leftrightarrow \ln|c_{cab}| = -at + \ln|C| \quad (6.17)$$

Which simplifies to

$$\ln|c_{cab}| - \ln|C| = -at \Leftrightarrow \ln\left|\frac{c_{cab}}{C}\right| = -at \Leftrightarrow \left|\frac{c_{cab}}{C}\right| = e^{-at} \quad (6.18)$$

Multiplying by C gives the solution of the homogeneous problem.

$$c_{cab1}(t) = C \cdot e^{-at} \quad (6.19)$$

It has to be noted that C is the constant of integration and does not describe a concentration. In order to solve the nonhomogeneous problem, a product approach is used.

$$c_{cab2}(t) = k(t) \cdot h(t) \quad (6.20)$$

Differentiating with respect to t gives

$$\dot{c}_{cab2}(t) = \dot{k}(t) \cdot h(t) + k(t) \cdot \dot{h}(t) \quad (6.21)$$

Substituting the Equations 6.20 and 6.21 into Equation 6.13 gives

$$\dot{k}(t) \cdot h(t) + k(t) \cdot \dot{h}(t) + a \cdot [k(t) \cdot h(t)] = b_1 + b_2 \cdot t \quad (6.22)$$

Rearranging gives

$$\dot{k}(t) \cdot h(t) + k(t) \cdot [\dot{h}(t) + a \cdot h(t)] = b_1 + b_2 \cdot t \quad (6.23)$$

For $h(t)$ a value should be chosen which satisfies the following condition:

$$\dot{h}(t) + a \cdot h(t) = 0 \quad (6.24)$$

Substituting $C = 1$ into Equation 6.19 gives a $h(t)$ which satisfies Equation 6.24.

$$h(t) = e^{-at} \quad (6.25)$$

Now, this is plugged into Equation 6.20 in order to obtain an approach for solving the problem.

$$c_{cab2}(t) = k(t) \cdot e^{-at} \quad (6.26)$$

In the next step, Equation 6.25 is plugged into Equation 6.23.

$$\dot{k}(t) \cdot e^{-at} = b_1 + b_2 \cdot t \quad (6.27)$$

Rearranging gives

$$\dot{k}(t) = e^{at} \cdot b_1 + e^{at} \cdot b_2 \cdot t \quad (6.28)$$

Integrating both sides gives

$$k(t) = \int e^{at} \cdot b_1 dt + \int e^{at} \cdot b_2 \cdot t dt \quad (6.29)$$

The first term can be written as

$$\int e^{at} \cdot b_1 dt = \frac{b_1}{a} \cdot e^{at} \quad (6.30)$$

The second term can be written as

$$\int e^{at} \cdot b_2 \cdot t dt = b_2 \int e^{at} \cdot t dt \quad (6.31)$$

In order to solve $\int e^{at} \cdot t dt$ it is integrated by parts using the following approach:

$$\int f \cdot \dot{g} = f \cdot g - \int \dot{f} \cdot g \quad (6.32)$$

With $f = t$, $\dot{f} = 1$, $\dot{g} = e^{at}$ and $g = \frac{e^{at}}{a}$ the following expression is obtained:

$$\int e^{at} \cdot t \, dt = \frac{t \cdot e^{at}}{a} - \int \frac{t \cdot e^{at}}{a} \, dt \quad (6.33)$$

In order to solve $\int \frac{t \cdot e^{at}}{a} \, dt$ a substitution is used.

$$u = at \Leftrightarrow dt = \frac{1}{a} du \quad (6.34)$$

And consequently

$$\int \frac{t \cdot e^{at}}{a} \, dt = \frac{1}{a^2} \cdot \int e^u \, du = \frac{1}{a^2} \cdot e^u \quad (6.35)$$

After undoing the substitution, it can be written as

$$\int \frac{t \cdot e^{at}}{a} \, dt = \frac{e^{at}}{a^2} \quad (6.36)$$

Plugging Equation 6.36 into Equation 6.33 gives

$$\int e^{at} \cdot t \, dt = \frac{t \cdot e^{at}}{a} - \frac{e^{at}}{a^2} \quad (6.37)$$

Plugging Equation 6.37 into Equation 6.31 gives

$$\int e^{at} \cdot b_2 \cdot t \, dt = b_2 \cdot \left(\frac{t \cdot e^{at}}{a} - \frac{e^{at}}{a^2} \right) \quad (6.38)$$

Plugging Equations 6.30 and 6.38 into Equation 6.29 gives

$$k(t) = \frac{b_1}{a} \cdot e^{at} + \frac{b_2 \cdot t \cdot e^{at}}{a} - \frac{b_2 \cdot e^{at}}{a^2} = e^{at} \cdot \frac{b_1 + b_2 \cdot \left(t - \frac{1}{a} \right)}{a} \quad (6.39)$$

Substituting into 6.26 gives the solution of the nonhomogeneous problem.

$$c_{cab2}(t) = e^{-at} \cdot e^{at} \cdot \frac{b_1 + b_2 \cdot \left(t - \frac{1}{a} \right)}{a} = \frac{b_1 + b_2 \cdot \left(t - \frac{1}{a} \right)}{a} \quad (6.40)$$

After plugging Equations 6.40 and 6.19 into Equation 6.15, the general solution of the linear first order differential equation can be written as

$$c_{cab}(t) = C \cdot e^{-at} + \frac{b_1 + b_2 \cdot \left(t - \frac{1}{a} \right)}{a} \quad (6.41)$$

It has to be noted that the Equations 6.10, 6.11 and 6.12 describe the calculation of a , b_1 and b_2 . These parameters have to be known before $c_{cab}(t)$ can be calculated.

6.4 Initial Value Problem

Equation 6.41 represents an Initial Value Problem (IVP). The differential equation has an infinite number of solutions, one for each value of the arbitrary constant C . Exactly one initial condition in the form $c_{cab}(t_0) = c_0$ is needed in order to obtain the value of C and hence find the corresponding particular solution. Therefore, t_0 and c_0 need to be defined and plugged into the general solution to the differential equation given in Equation 6.41.

For an initial concentration c_0 at $t = 0$, substituting $c_{cab}(t)$ by c_0 and t by 0 gives

$$C = c_0 - \frac{1}{a} \cdot (b_1 - \frac{b_2}{a}) \quad (6.42)$$

The particular solution can be used to calculate the concentration of a chosen contaminate in cabin air over time as long as the parameters a , b_1 and b_2 are constant. From the moment on where one of the three parameters changes, the particular solution to the IVP does not provide exact results anymore. If the change takes place at time t_1 , then $c_{cab}(t_1)$ is the last value the obtained particular solution is valid for. In order to calculate the contaminant concentration for any t greater than t_1 a new IVP has to be applied. Therefore, t_1 is the new t_0 while the calculated $c_{cab}(t_1)$ is the new c_0 . With this information the corresponding particular solution is obtained and used for the next section, also called time interval. This new particular solution is only valid until a , b_1 or b_2 changes again. Thus, the procedure might have to be repeated a number of times when the contaminant concentration in the cabin is analyzed for a given time period.

6.5 Conversion into Parts Per Million

Every type of contaminant introduced in Chapter 4 can be analyzed by using Equation 6.41. It has to be noted that in addition to the contamination source strengths S also the portion of the contaminant that passes a filter or duct section α and absorption rate τ depend on the chosen type of contaminant. Since SI units are used the contaminant concentration in the cabin $c_{cab}(t)$ to which passengers and crew are exposed to is calculated in kg/m^3 . Concentration can also be stated in parts per million. A contaminant concentration given in kg/m^3 can be converted into ppm by using Equation 6.43.

$$c_{cab, \text{in ppm}} = c_{cab, \text{in } \frac{\text{kg}}{\text{m}^3}} \cdot \frac{1\,000\,000}{\rho_{air}} \quad (6.43)$$

The air density ρ_{air} is defined by the following relationship:

$$\rho_{air} = \frac{p}{R \cdot T} \quad (6.44)$$

Depending on the aircraft type, the maximum occurring cabin altitudes under normal operation are between 8000 ft and 6000 ft. According to the International Standard Atmosphere (ISA) this refers to a pressure p of 75300 Pa and 81200 Pa respectively. Sea level air pressure amounts 101325 Pa. When calculating the air density of dry air, a cabin temperature T of 20 °C or 293,15 K and a specific gas constant R of 287,05 J/kg·K can be assumed.

6.6 Calculation of Source Strength of Secondary CACE

Research carried out in the past has mainly focused on cabin air contamination caused by outside air, internal sources as well as primary events. As a result of this, little is known about absorption processes within the cabin or secondary CACE. While absorption processes in the cabin do not seem to have a significant influence on the contamination concentration in aircraft cabins c_{cab} , secondary CACE might have the potential to considerably increase c_{cab} .

Therefore, an equation is derived which aims at describing the process of contaminant allocation and their release triggered by an event. The approach is based on the simplified model introduced in Chapter 6.1. First of all, the parameter M needs to be calculated for the contaminant that is analyzed. M represents the mass of the contaminant that is accumulated along a certain section of the duct system within the air conditioning system.

Figure 6.3 shows the air flow model which now focuses on secondary CACE. It is distinguished between three sections of the duct system: the ducts which supply conditioned air to

the mixing unit, ducts connecting the mixing unit with the cabin, and the recirculation path. In all of these three sections a secondary event can potentially occur. The secondary source strengths are abbreviated with $S_{s,in}$, $S_{s,ca}$ and $S_{s,rec}$. As explained earlier, one section of the duct system can comprise multiple individual ducts. However, this detail is not shown in Figure 6.3.

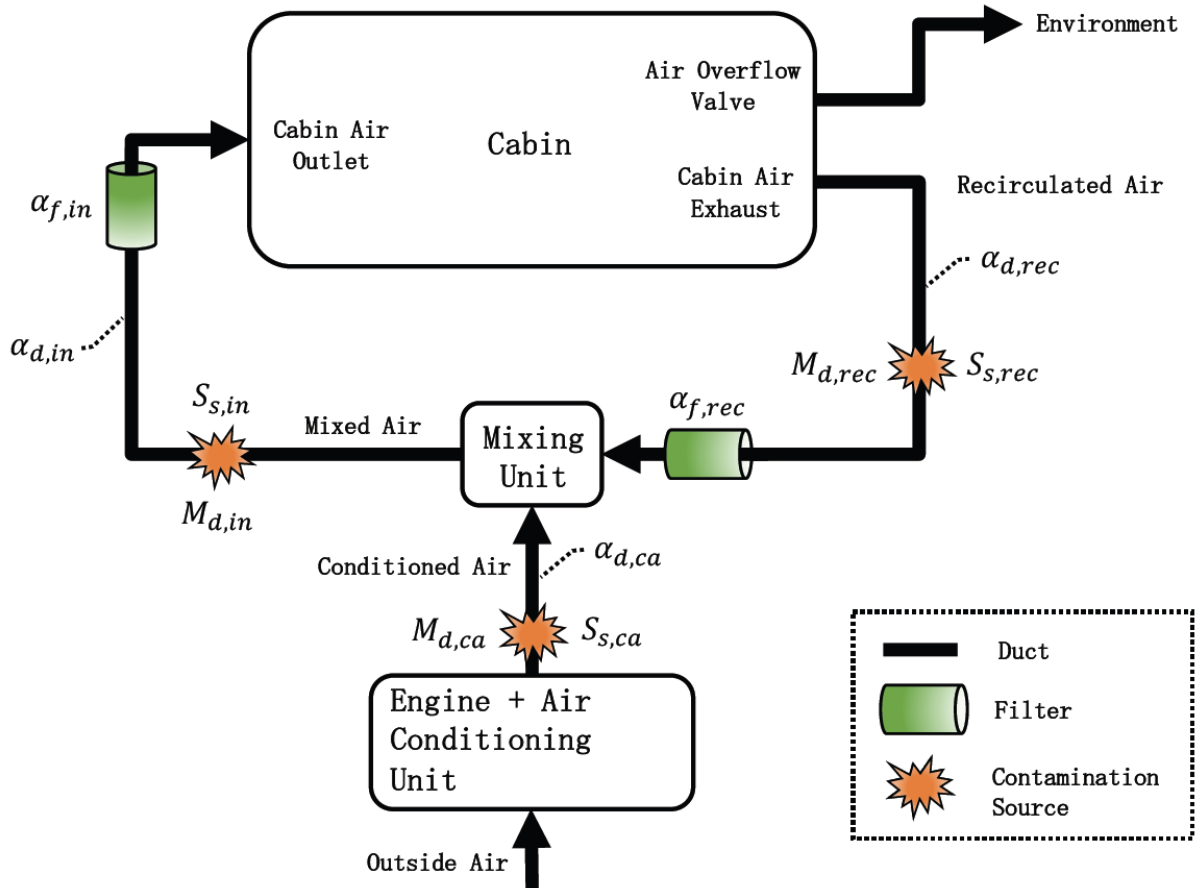

Figure 6.3 Air flow model with positions where secondary CACE might occur

With regard to the duct section that carries conditioned air the potential accumulation of contaminant mass M can be described by the following relationship.

$$M_{d,ca} = c_{ca} \cdot V_{ca} \cdot (1 - \alpha_{d,ca}) \quad (6.45)$$

The concentration of the contaminant in the conditioned air c_{ca} is multiplied by the total volume of air which passes the section of the duct system during the considered period V_{ca} and the rate of removed contaminants $(1 - \alpha_{d,ca})$. In order to obtain V_{ca} the portion of recirculated air θ , the total air exchange rate λ , the cabin volume V_{cab} and the time of operation t_{op} need to be known.

$$V_{ca} = (1 - \theta) \cdot \lambda \cdot V_{cab} \cdot t_{op} \quad (6.46)$$

The operating time t_{op} is defined as the mean time between the previous secondary event, replacement of the duct or cleaning of the duct and the incident triggering the CACE that is analyzed. The operating time only considers the time where the air conditioning system is switched on. In case the accumulated contaminants have not been removed or released completely due to cleaning activities or a previous CACE, it is assumed that the remaining mass will not be involved in future events. If the average number of flight hours per day and the number of days is known, the time of operation can easily be calculated. Substituting Equation 6.46 into Equation 6.45 gives

$$M_{d,ca} = c_{ca} \cdot (1 - \theta) \cdot \lambda \cdot V_{cab} \cdot t_{op} \cdot (1 - \alpha_{d,ca}) \quad (6.47)$$

Accordingly, the masses $M_{d,rec}$ and $M_{d,in}$ for the other two sections are calculated.

$$M_{d,rec} = c_{cab} \cdot \theta \cdot \lambda \cdot V_{cab} \cdot t_{op} \cdot (1 - \alpha_{d,rec}) \quad (6.48)$$

$$M_{d,in} = [\theta \cdot c_{cab} \cdot \alpha_{d,rec} \cdot \alpha_{f,rec} + (1 - \theta) \cdot c_{ca} \cdot \alpha_{d,ca}] \cdot \lambda \cdot V_{cab} \cdot t_{op} \cdot (1 - \alpha_{d,in}) \quad (6.49)$$

It has to be noted that for $M_{d,rec}$ a constant cabin contamination concentration c_{cab} has to be calculated separately using Equation 6.41. Therefore, all involved parameters need to be as constant as possible over time t_{op} . If this is not the case the calculation can be carried out with average values or broken down into several time intervals. That would add further complexity to the problem.

The mass $M_{d,in}$ of the contaminant that is accumulated along the duct carrying mixed air is calculated by combining the air flows of the other two sections of the duct system. Additionally, the parameter $\alpha_{f,rec}$ needs to be taken into account since the recirculated air may pass a filter before entering the mixing unit. Once M of the regarded section is known, the respective S_s can be calculated using the following relationship:

$$S_{s,avg} = \frac{M_d \cdot \beta}{t_{rel}} \quad (6.50)$$

The parameter β describes the portion of accumulated contaminant mass that is released during one individual CACE. The release duration t_{rel} defines the period of time between start and end of contaminant release. The obtained source strength represents an average value since the behavior of S_s can be both constant or linear over time t_{rel} .

7 Calculation of Example Scenarios

The application of the equations derived in Chapter 6 is demonstrated in this chapter. Two main scenarios are introduced. One involves a primary CACE occurring during climb and the other one a secondary event occurring while the aircraft is descending. Based on these main examples multiple variations are analyzed in order to demonstrate the influence of each parameter on the cabin contaminant concentration. The examples in this report are used to demonstrate how effective the various means explained in Chapter 5 are when it comes to reducing the burden of contamination sources. In the calculations presented in Chapters 7.1 and 7.2 we pretend the contaminant is TCP and start our calculation with concentration levels as they have been measured and published. It has to be pointed out that the equations introduced in Chapter 6 may be used to analyze any type of contaminant. The results are discussed in Chapter 7.3.

7.1 Scenario Primary CACE

7.1.1 Basic Scenario of Primary CACE

The scenario of a primary CACE covers the flight phases taxi, take-off, and climb. The basic scenario is called P0 and considers an aircraft with a cabin volume of 470 m^3 . That is equivalent to the cabin volume of an Airbus A340-600 aircraft. For the portion of recirculated air θ the standard value of 0,5 is chosen. For the absorption rate τ a constant value of 1% is assumed. The total air exchange rate λ is defined as 20 h^{-1} . Since all parameters need to be expressed in SI units for the calculation, this is converted to $1/180 \text{ s}^{-1}$. The parameter $\alpha_{f,in}$ is set to 1 because no filter is assumed to exist at the related position. At the end of the recirculation path right before the air enters the mixing unit a filter is installed. It is assumed that this filter has a relatively low efficiency with regard to removing the contaminant, in this case TCP. Thus, $\alpha_{f,rec}$ is set to 0,9. The same rate of unremoved contaminants is assumed for the three duct sections. Hence, $\alpha_{d,ca} = \alpha_{d,rec} = \alpha_{d,in} = 0,9$.

The internal source strength is assumed to be constant. As a result of that, the linear internal source strength $S_{i,lin}$ is zero. In order to come up with an estimation for the constant internal source strength $S_{i,con}$ existing studies are taken into account. According to **EASA 2017**, **De Boer 2015** and **De Ree 2014** TCP concentrations of around 100 ng/m^3 have been found in aircraft cabins. It is assumed that the only contamination source were internal emissions when the measurements have been carried out. This can be considered to be realistic because such concentrations were measured on many flights, including Boeing 787 aircraft in cruising altitude. Since the 787 is equipped with a no-bleed air conditioning system with air bearings and

outside air can be considered to be free of TCP during cruise, The source strength originating from outside of the cabin S_{cp} and S_{oa} must have been zero or extremely low. It is also highly unlikely that secondary CACE were involved in all measurement campaigns. Thus, Equation 6.41 is used to calculate $S_{i,con}$. All parameters correspond to the values already defined in this chapter with the exception that all source strengths S apart from $S_{i,con}$ are set to zero. For the calculation of C the initial condition $c_0 = t_0 = 0$ is chosen because a constant $S_{i,con}$ leads to a constant contaminant concentration in the cabin which is reached after a certain time. From that moment on the concentration does not depend on the time anymore and the $S_{i,con}$ which matches to a concentration of 100 ng/m^3 can easily be calculated. The result is $S_{i,con} = 1,66 \cdot 10^{-10} \text{ kg/s}$.

In the basic scenario P0 of the primary CACE example that is analyzed in this chapter more than one source strength is involved. The constant internal source strength has been discussed already. The secondary source strength is assumed to not exist while the outside air as well as conditioning process contribute to the contaminant concentration. Both depend on the time and comprise linear and constant sections as shown in Figures 7.1 and 7.2.

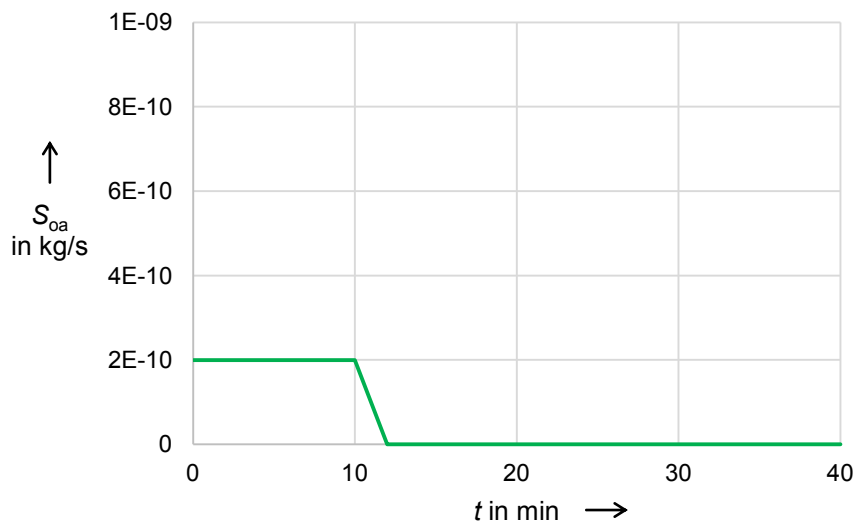

Figure 7.1 TCP source strength of outside air at scenario P0

S_{ooa} TCP source strength of outside air
 t Time

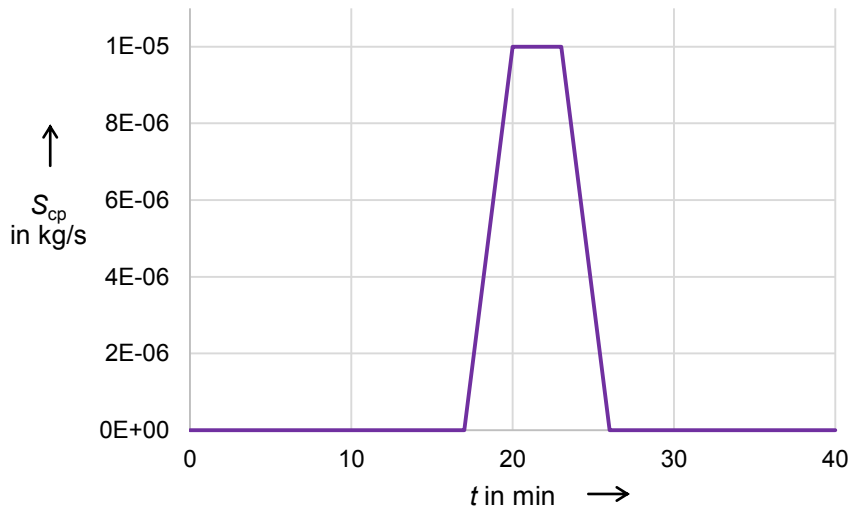

Figure 7.2 TCP source strength of conditioning process at scenario P0

S_{cp}	TCP source strength related to conditioning process
t	Time

In this example the push back happens at $t = 0$ min and the aircraft takes off at $t = 10$ min. It is assumed that the outside air is only contaminated near the airport. Once the aircraft takes off the TCP concentration in outside air drops and reaches zero after two minutes. In this scenario it is assumed that a CACE takes place seven minutes after take-off. The maximum value of $2 \cdot 10^{-10}$ kg/s for the source strength of the outside air is randomly chosen. The maximum value of $1 \cdot 10^5$ kg/s for the source strength related to the conditioning process has been used in the example calculation by **EASA 2017**. This value of S_{cp} is obtained if an engine oil leak rate of 20 g/min is assumed with a 3% content of TCP in the oil.

Since all parameters are constant in this scenario except the source strengths $S_{oa,con}$, $S_{oa,lin}$, $S_{cp,con}$ and $S_{cp,lin}$ the behavior of these four parameters determines the time intervals at which b_1 or b_2 change their values. At these points in time a new IVP comes into play which replaces the one used in the previous time interval. New time intervals start at 0 s, 600 s, 720 s, 1020 s, 1380 s, and 1560 s. For each time interval the parameters a , b_1 and b_2 are calculated. Together with the respective initial TCP concentration c_0 they are plugged into Equation 6.41 in order to calculate the contaminant concentration in cabin air c_{cab} .

The initial TCP concentration c_0 at 0 s is assumed to be $1 \cdot 10^{-10}$ kg/s. For all the other time intervals their initial TCP concentration is given by the last value of c_{cab} calculated with the equation of the previous time interval.

Based on the Figures 7.1 and 7.2 the values of $S_{oa,con}$, $S_{oa,lin}$, $S_{cp,con}$ and $S_{cp,lin}$ shall be obtained for each time interval. In general, the source strength of a constant section is described by S_{con} while the related $S_{lin}(t)$ is zero. A linear section is described by a combination of S_{con} and

$S_{lin}(t)$. In both cases S_{con} may be zero. The unit of S_{con} is kg/s while S_{lin} is expressed in kg/s². If the starting point t_n and the end point t_{n+1} of a time interval as well as the respective source strength at these points are known, linear sections can be described by the following equation:

$$S(t) = S_{con} + S_{lin} \cdot (t - t_n) = S_n + \frac{S_{n+1} - S_n}{t_{n+1} - t_n} \cdot (t - t_n) \quad (7.1)$$

Table 7.1 gives an overview of the values of the source strengths $S_{oa,con}$, $S_{oa,lin}$, $S_{cp,con}$ and $S_{cp,lin}$ used in the calculations of c_{cab} for the basic scenario of the primary CACE example. When it comes to the variations P1A, P1B, and P1C the values of S_{cp} and the duration of certain time intervals change. However, the same approach is applied in order to obtain these values. Thus, these details are not fully explained in this report.

Table 7.1 Variable TCP source strengths at scenario P0

Time interval s	min	$S_{oa,con}$ kg/s	$S_{oa,lin}$ kg/s ²	$S_{cp,con}$ kg/s	$S_{cp,lin}$ kg/s ²
0 to 600	0 to 10	2E-10	0	0	0
600 to 720	10 to 12	2E-10	-1,667E-12	0	0
720 to 1020	12 to 17	0	0	0	0
1020 to 1200	17 to 20	0	0	0	5,556E-8
1200 to 1380	20 to 23	0	0	1E-5	0
1380 to 1560	23 to 26	0	0	1E-5	- 5,556E-8
1560 to 2400	31 to 40	0	0	0	0

It is obvious that the contribution of outside air has almost no influence on the TCP concentration in the cabin since the source strength related to outside air S_{oa} is a lot smaller than the source strength related to the conditioning process S_{cp} . Figures 7.3 and 7.4 illustrate the calculated change of c_{cab} over time. Since the peaks that occur during taxi and descent have different orders of magnitude, Figure 7.4 shows the first three time intervals while Figure 7.3 shows all time intervals of the basic scenario P0.

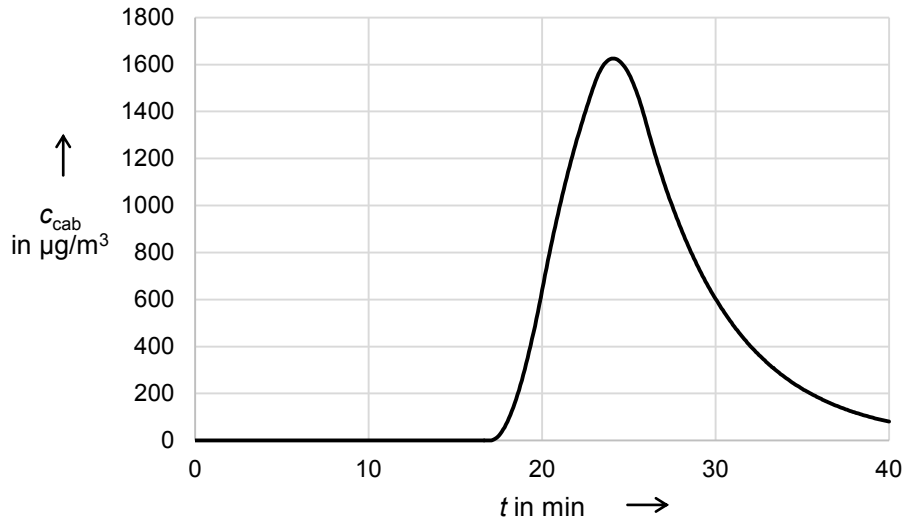

Figure 7.3 TCP concentration in the cabin at scenario P0

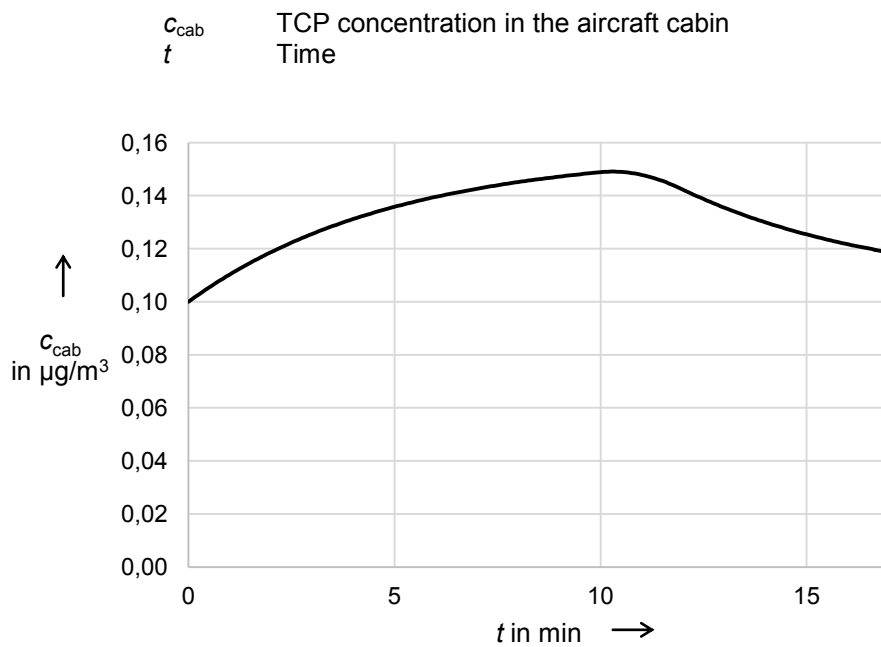

Figure 7.4 First three time intervals of scenario P0

c_{cab} TCP concentration in the aircraft cabin
t Time

7.1.2 Variation of Source Strength

The first variation of the scenario introduced in Chapter 7.1.1 is a modification of the source strength occurring in the air conditioning process which causes the primary CACE. Three modifications are investigated. **Variation P1A** doubles the initial source strength S_{cp} . All other parameters remain the same. In **variation P1B** the source strength is multiplied by 0,5 and the duration of the time interval where S_{cp} is constant is increased from three to five minutes. Thus, it now lasts from $t = 20$ min to $t = 25$ min. **Variation P1C** uses the increased interval introduced in variation P1B but has the same source strength as scenario P0. This is shown in Figure 7.5.

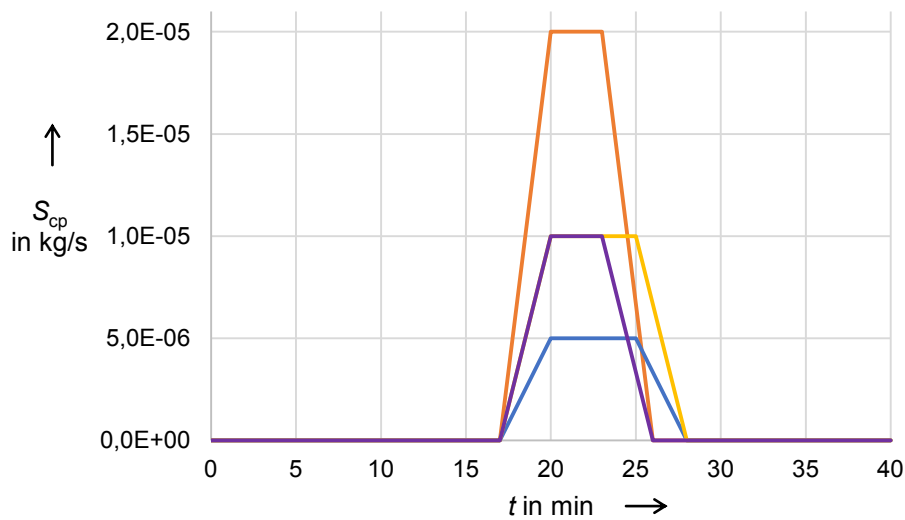

Figure 7.5 TCP source strength related to conditioning process at P0 and P1A-C

S_{cp}	TCP source strength related to conditioning process
t	Time
— (purple)	Scenario P0
— (orange)	Variation P1A
— (blue)	Variation P1B
— (yellow)	Variation P1C

Figure 7.6 shows the change of c_{cab} over time for scenario P0 from 7.1.1 as well as the three variations P1A, P1B and P1C.

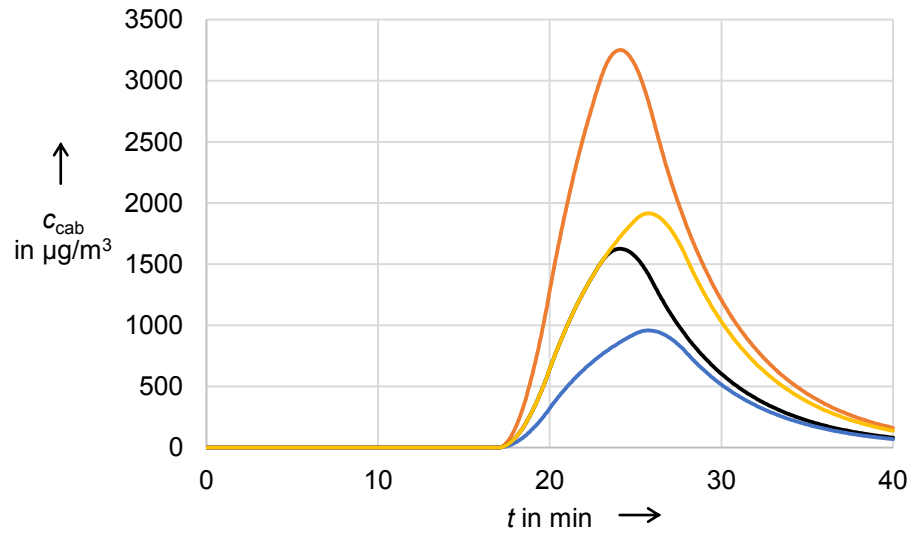

Figure 7.6 TCP concentration in the cabin at scenario P0 and variations P1A-C

c_{cab}	TCP concentration in the aircraft cabin
t	Time
— (black)	Scenario P0
— (orange)	Variation P1A
— (blue)	Variation P1B
— (yellow)	Variation P1C

7.1.3 Variation of Cabin Volume

The second **variation P2** of the scenario introduced in Chapter 7.1.1 is a modification of the cabin volume V_{cab} . It is decreased from 470 m^3 to $165,46 \text{ m}^3$ which is equivalent to the cabin volume of an Airbus A319 aircraft. All the other parameters are not changed.

Figure 7.7 illustrates the change of c_{cab} over time for scenario P0 and its variation P2.

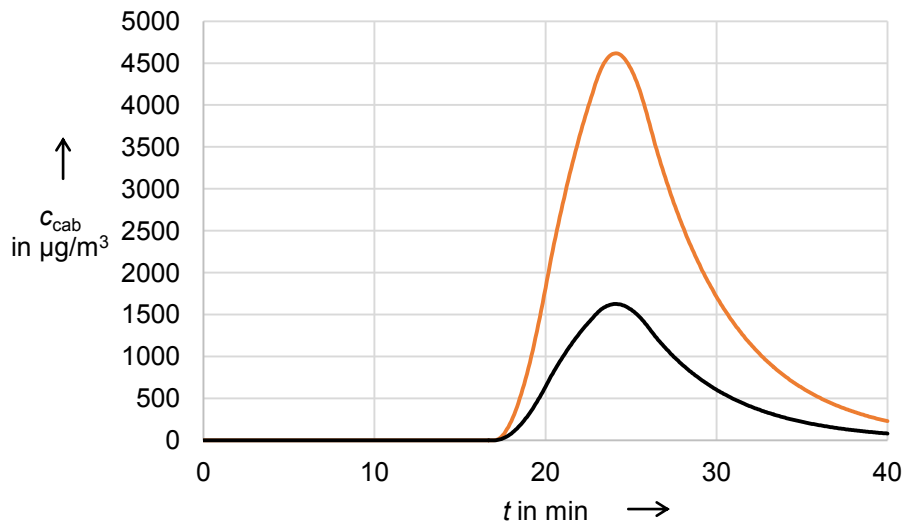

Figure 7.7 TCP concentration in the cabin at scenario P0 and variation P2

c_{cab}	TCP concentration in the aircraft cabin
t	Time
—	Scenario P0
—	Variation P2

7.1.4 Variation of Air Exchange Rate

The next variation of the basic scenario is a modification of the total air exchange rate λ . For **variation P3A** an air exchange of 25 h^{-1} is chosen and for **variation P3B** an exchange rate of 30 h^{-1} .

Figure 7.8 shows the change of c_{cab} over time for scenario P0 and its variations P3A and P3B.

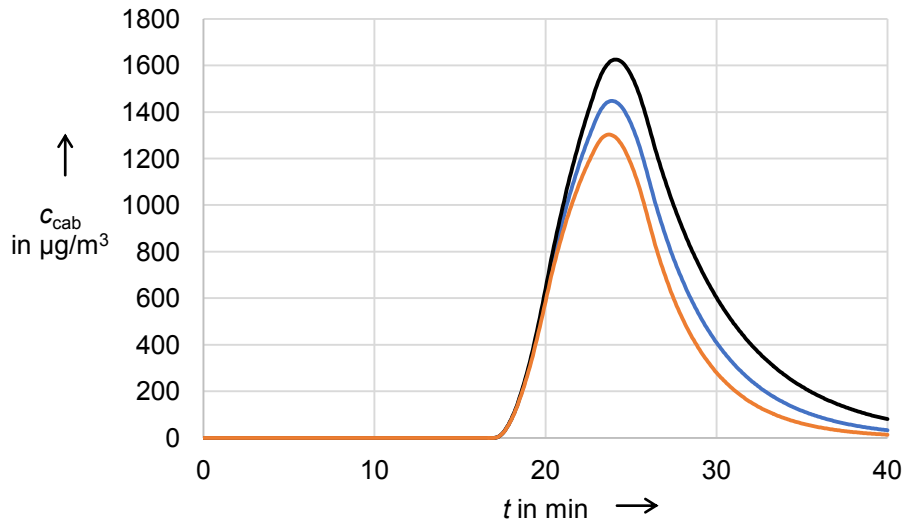

Figure 7.8 TCP concentration in the cabin at scenario P0 and variations P3A and P3B

c_{cab}	TCP concentration in the aircraft cabin
t	Time
— (black)	Scenario P0
— (blue)	Variation P3A
— (orange)	Variation P3B

7.1.5 Variation of Portion of Recirculated Air

Another parameter which is modified in order to demonstrate its influence on the TCP concentration in the cabin is the portion of recirculated air θ . In **variation P4** a value of 40% is chosen for θ .

Figure 7.9 illustrates the change of c_{cab} over time for scenario P0 and its variation P4.

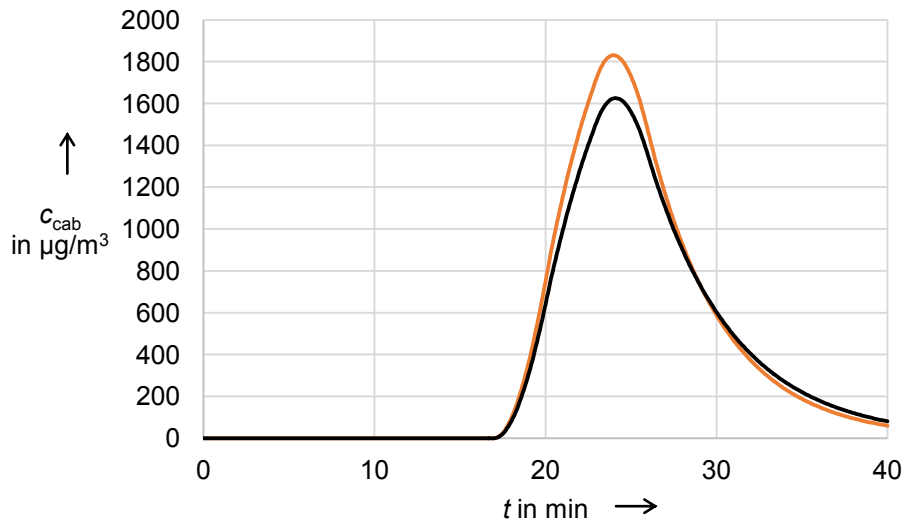

Figure 7.9 TCP concentration in the cabin at scenario P0 and variation P4

c_{cab}	TCP concentration in the aircraft cabin
t	Time
—	Scenario P0
—	Variation P4

7.1.6 Variation of Duct System Parameters

In the basic scenario P0 a value of 90% is chosen for $\alpha_{d,ca}$, $\alpha_{d,in}$ and $\alpha_{d,rec}$. For **variation P5A** a value of 70% is defined. Then, the value is increased to 98% for **variation P5B**. All the other system parameters remain the same.

Figure 7.10 shows the change of c_{cab} over time for scenario P0 and its variations P5A and P5B.

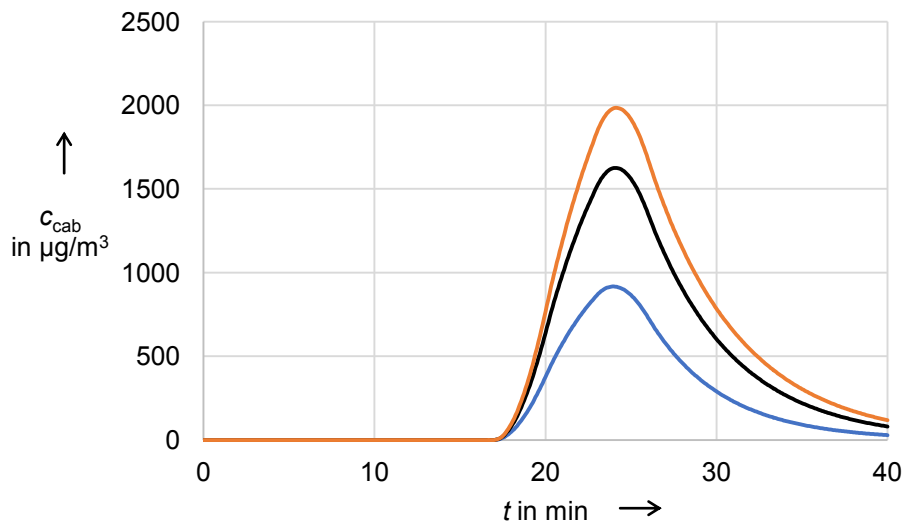

Figure 7.10 TCP concentration in the cabin at scenario P0 and variations P5A and P5B

c_{cab}	TCP concentration in the aircraft cabin
t	Time
— (black)	Scenario P0
— (blue)	Variation P5A
— (orange)	Variation P5B

7.1.7 Variation of Filter Parameters

The last variation of scenario P0 involves the filter parameters. Two modifications are investigated. **Variation P6A** improves the TCP removal efficiency of the filter in the recirculation path which changes $\alpha_{f,rec}$ to 0,4. $\alpha_{f,in}$ is not modified. Hence, $\alpha_{f,in}$ is still 1. In variation P6B a filter is installed at both positions and the removal efficiency further improved. As a result of this modification $\alpha_{f,rec}$ and $\alpha_{f,in}$ both reach a value of 0,2.

Figure 7.11 demonstrates the change of c_{cab} over time for scenario P0 and its variations P6A and P6B.

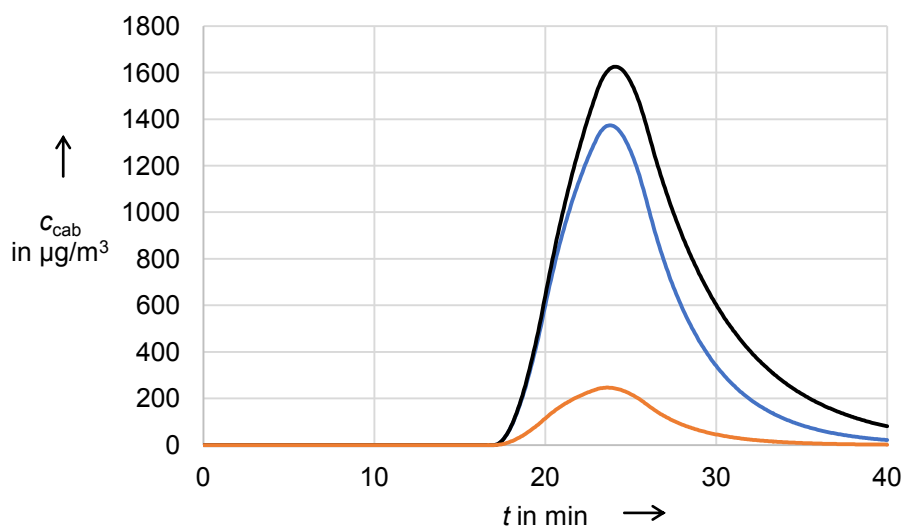

Figure 7.11 TCP concentration in the cabin at scenario P0 and variations P6A and P6B

c_{cab}	TCP concentration in the aircraft cabin
t	Time
— (black)	Scenario P0
— (blue)	Variation P6A
— (orange)	Variation P6B

7.2 Scenario Secondary CACE

7.2.1 Basic Scenario of Secondary CACE

The **second example scenario** covers the flight phases descent, landing, and taxi. The basic scenario is called S0 and considers an aircraft with a cabin volume of $165,46 \text{ m}^3$. That is equivalent to the cabin volume of an Airbus A319 aircraft. As in scenario P0, for the portion of recirculated air θ the standard value of 0,5 is chosen. For the absorption rate τ a constant value of 1% is assumed. The total air exchange rate λ is defined as $1/180 \text{ s}^{-1}$. Again, $\alpha_{f,in}$ is set to 1 because no filter exists at that position. At the end of the recirculation path a filter with the parameter $\alpha_{f,rec} = 0,9$ is installed. The rate of unremoved contaminants is also assumed to be 0,9 for the three duct sections $\alpha_{d,ca}$, $\alpha_{d,rec}$ and $\alpha_{d,in}$.

The internal source strength is assumed to be constant. It is calculated in the same way as in Chapter 7.1.1. The result of the calculation with the respective cabin volume of $165,46 \text{ m}^3$ is $S_{i,con} = 5,84 \cdot 10^{-11} \text{ kg/s}$. The source strength associated with the air conditioning process is assumed to be constant with a value of $S_{cp,con} = 1 \cdot 10^{-10} \text{ kg/s}$. In both cases no linear part exists, hence $S_{i,lin} = S_{cp,lin} = 0$.

In addition, contaminated outside air as well as a secondary CACE have a significant influence on the contaminant concentration in the cabin. Both source strengths depend on the time and comprise linear and constant sections.

In this example the aircraft lands at $t = 17 \text{ min}$ and a secondary CACE occurs at $t = 2 \text{ min}$. The investigated time period ends at $t = 33 \text{ min}$ since it is assumed that passenger deboarding starts at that time. After landing the source strength of outside air comes into play. The maximum value of $2 \cdot 10^{-10} \text{ kg/s}$ for the source strength of the outside air is identical to the previous example. The average secondary source strength is calculated using Equation 6.50. $S_{s,avg}$ needs to be calculated for the associated position. For this basic scenario S0 it is assumed that the secondary event takes place in the duct section that carries conditioned air. Thus, ε is set to $(1 - \theta) = 0,5$ and Equation 6.47 is used to calculate the mass accumulated along the duct carrying conditioned air $M_{d,ca}$. When calculating $M_{d,ca}$ the operating time t_{op} prior to the event needs to be considered. It is assumed that the time between the last secondary event, removal or cleaning of the duct and the analyzed CACE adds up to six months or 183 days. With an average of 10 flight hours per day t_{op} amounts 1830 hours. During this period of time the constant source strength associated with the air conditioning process $S_{cp,con} = 1 \cdot 10^{-10} \text{ kg/s}$ causes the accumulation of TCP in the duct system. With Equations 6.3a and 6.3b a constant TCP concentration in the conditioned air c_{ca} can be calculated.

$$c_{ca} = \frac{S_{cp,con}}{V_{cab} \cdot \lambda} = \frac{1 \cdot 10^{-10} \frac{\text{kg}}{\text{s}}}{165,46 \text{ m}^3 \cdot \frac{1}{180\text{s}}} = 1,088 \cdot 10^{-10} \frac{\text{kg}}{\text{m}^3} \quad (7.2)$$

Now, all parameters needed to solve Equation 6.47 for this scenario are known. The result is $M_{d,ca} = 3,294 \cdot 10^{-5} \text{ kg}$.

It is assumed that the event lasts one minute and that 80% of the accumulated mass is released. This means the release time t_{rel} is defined as 60 s and the released portion β as 0,8. Substituting c_{ca} , t_{rel} and β into Equation 6.50 gives $S_{s,avg,ca} = 4,392 \cdot 10^{-7} \text{ kg/s}$. It has to be noted that this is an average value. Thus, the source strength $S_{s,ca}$ does not need to be constant throughout the release period t_{rel} .

So far, all parameters except $S_{s,ca}$ and S_{oa} are defined for the scenario S0. The values of both $S_{s,ca}$ and S_{oa} depend on time and comprise linear and constant sections as shown in Figures 7.12 and 7.13. The release pattern is chosen randomly.

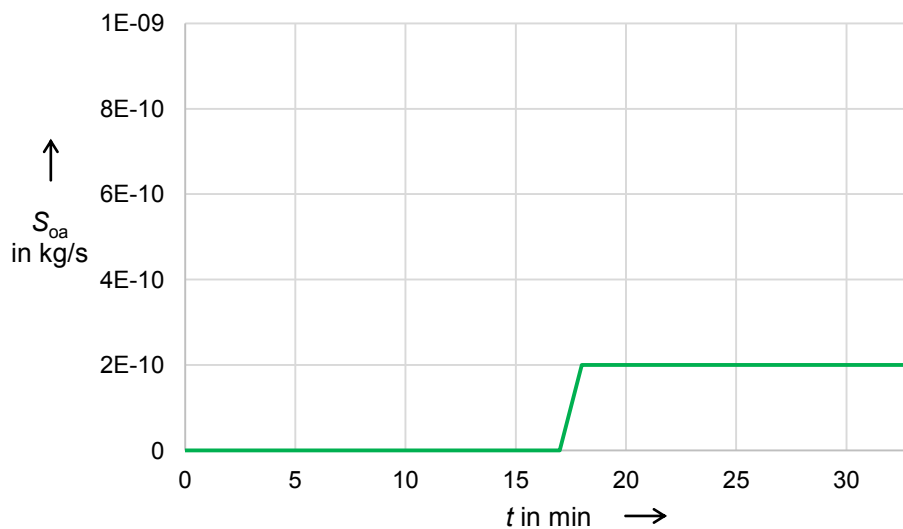

Figure 7.12 TCP source strength of outside air at scenario S0

S_{0a}	TCP source strength of outside air
t	Time

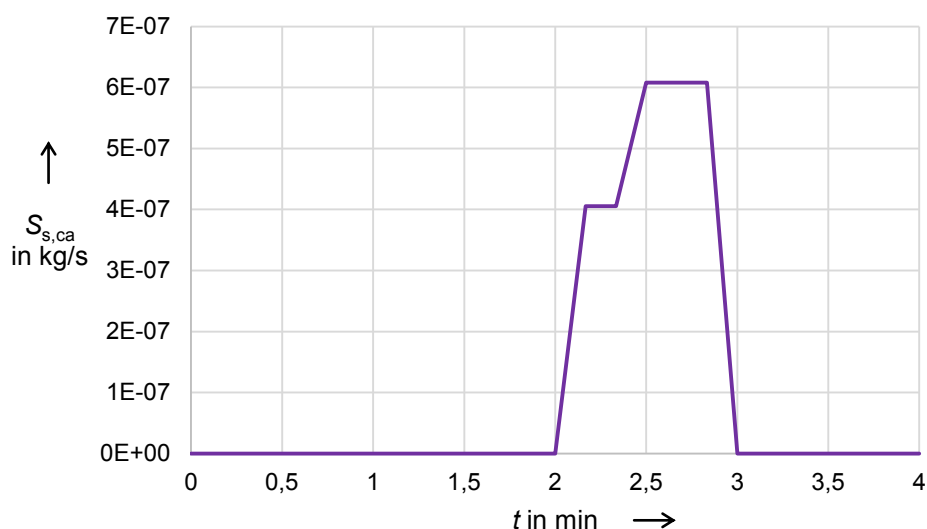

Figure 7.13 TCP source strength related to secondary event at scenario S0

$S_{s,ca}$ TCP source strength released in duct carrying conditioned air
 t Time

For clarity reasons Figure 7.13 does not cover the time period between 4 min and 33 min where $S_{s,ca}$ is zero. Since all parameters are constant in this scenario except $S_{oa,con}$, $S_{oa,lin}$, $S_{s,con}$ and $S_{s,lin}$ the behavior of these four parameters determines the time intervals. New time intervals start at 0 s, 120 s, 130 s, 140 s, 150 s, and 170 s, 180 s, 1020 and 1080 s. As in Chapter 7.1, the initial TCP concentration c_0 at 0 s is assumed to be $1 \cdot 10^{-10}$ kg/s. Figures 7.14 and 7.15 illustrate the change of c_{cab} over time.

Table 7.2 gives an overview of the values of $S_{oa,con}$, $S_{oa,lin}$, $S_{s,con}$ and $S_{s,lin}$ used in the calculations of c_{cab} for scenario S0. When it comes to the **variations of scenario S0** the values of S_{cp} and the duration of certain time intervals change in some cases. However, the same approach is applied in order to obtain these values. These details are not fully given in this report.

Table 7.2 Variable TCP source strengths at scenario S0

Time interval s	min	$S_{oa,con}$ kg/s	$S_{oa,lin}$ kg/s ²	$S_{s,con}$ kg/s	$S_{s,lin}$ kg/s ²
0 to 120	0 to 2	0	0	0	0
120 to 130	2 to 2,16	0	0	0	4,054E-8
130 to 140	2,16 to 2,33	0	0	4,054E-7	0
140 to 150	2,33 to 2,5	0	0	4,054E-7	1,01E-8
150 to 170	2,5 to 2,83	0	0	6,081E-7	0
170 to 180	2,83 to 3	0	0	6,081E-7	- 6,081E-8
180 to 1020	3 to 17	0	0	0	0
1020 to 1080	17 to 18	0	3,333E-12	0	0
1080 to 1980	18 to 31	2E-10	0	0	0

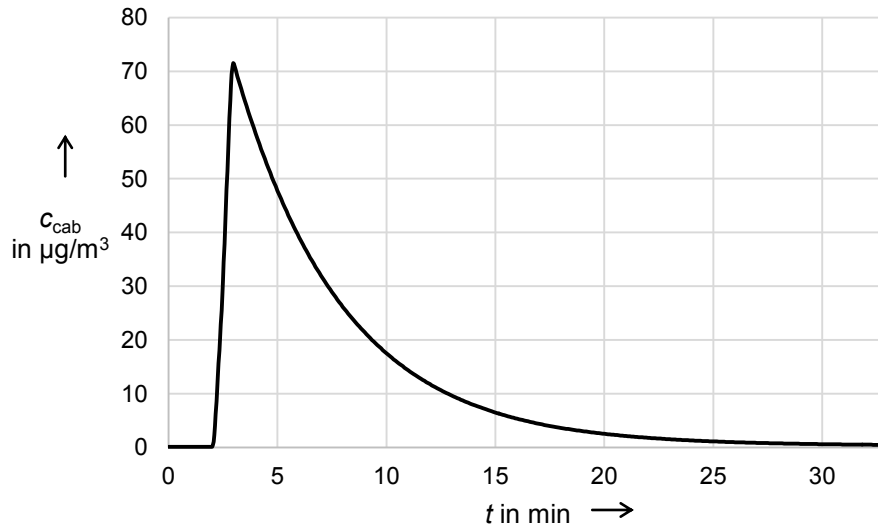

Figure 7.14 TCP concentration in the cabin at scenario S0

c_{cab} TCP concentration in the aircraft cabin
 t Time

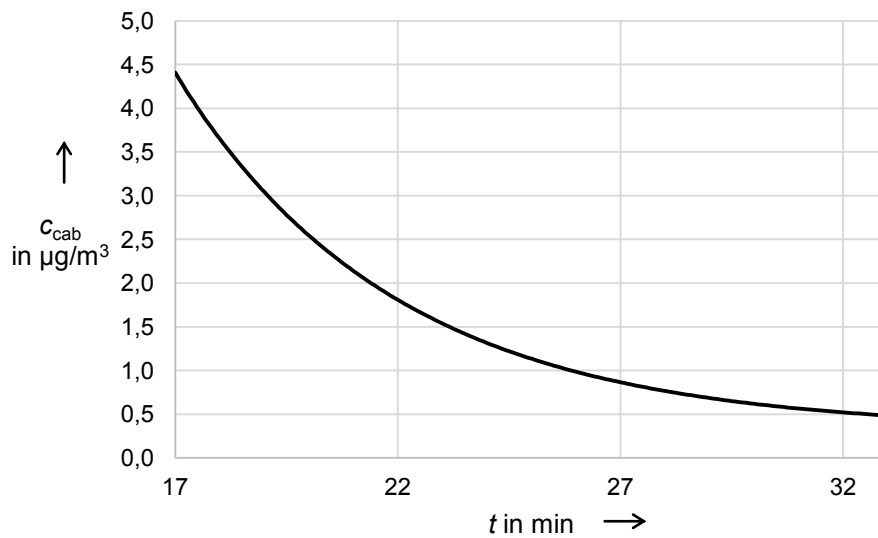

Figure 7.15 Last two time intervals of scenario S0

c_{cab} TCP concentration in the aircraft cabin
 t Time

At $t = 17$ min S_{oa} comes into play. However, its influence cannot be spotted by looking at the plots in Figures 7.14 and 7.15 because its magnitude is rather small, and the decrease of concentration caused by the secondary event is the dominating influence.

The scenario S0 introduced in this chapter is the basis for further modifications in the following Chapters 7.2.2 to 7.2.5. The parameters λ , θ and V_{cab} are not modified because their influence on c_{cab} is expected to be similar to the effects demonstrated in Chapter 7.1.

7.2.2 Variation of Event Position

The first variation of scenario P0 introduced in Chapter 7.2.1 is a modification of the position at which the CACE occurs. Two modifications are investigated. In **variation S1A** the secondary CACE takes place in the recirculation path of the duct system. In **variation S1B** the event occurs in the ducts connecting the mixing units with the cabin.

All in Chapter 7.2.1 defined parameters remain the same except $S_{s,avg}$ and ε . For variation S1A the weakening coefficient ε is defined as $\theta \cdot \alpha_{f,rec}$ and for variation S1B ε is one. Moreover, $M_{d,rec}$ is calculated for variation S1A and $M_{d,in}$ for variation S1B. This is done with the Equations 6.48 and 6.49. Both equations require knowledge about the constant TCP concentration in the cabin c_{cab} which is present during the entire operating time of the aircraft. In this context the operating time describes the elapsed time while an aircraft air conditioning system is operated, and contaminants accumulate before a secondary CACE occurs. Only the time between the analyzed secondary CACE event and the previous event, cleaning activity or duct replacement is considered.

The constant source strengths $S_{i,con} = 5,84 \cdot 10^{-11}$ kg/s and $S_{oa,con} = 1 \cdot 10^{-10}$ kg/s contribute to c_{cab} . The influence of outside air is neglected in this auxiliary calculation. Equation 6.41 is used with the initial conditions $c_0 = 0$ and $t_0 = 0$. Within a short period of time c_{cab} increases from 0 kg/m³ to a constant value of $1,778 \cdot 10^{-10}$ kg/m³. With this value of c_{cab} and all parameters that have already been defined the two masses can be obtained. The results are $M_{d,rec} = 5,384 \cdot 10^{-5}$ kg and $M_{d,in} = 7,326 \cdot 10^{-5}$ kg. Equation 6.50 then gives the average source strengths $S_{s,avg,rec} = 7,179 \cdot 10^{-7}$ kg/s and $S_{s,avg,in} = 9,768 \cdot 10^{-7}$ kg/s. The same release pattern as in scenario S0 is assumed for both variations.

Figure 7.16 shows the new values of $S_{s,rec}$ and $S_{s,in}$ over time. The name of the parameters changed due to the new event position (see Figure 6.3). As a reference, the curve that belongs to scenario S0 where the event occurs in the duct carrying conditioned air is displayed as well.

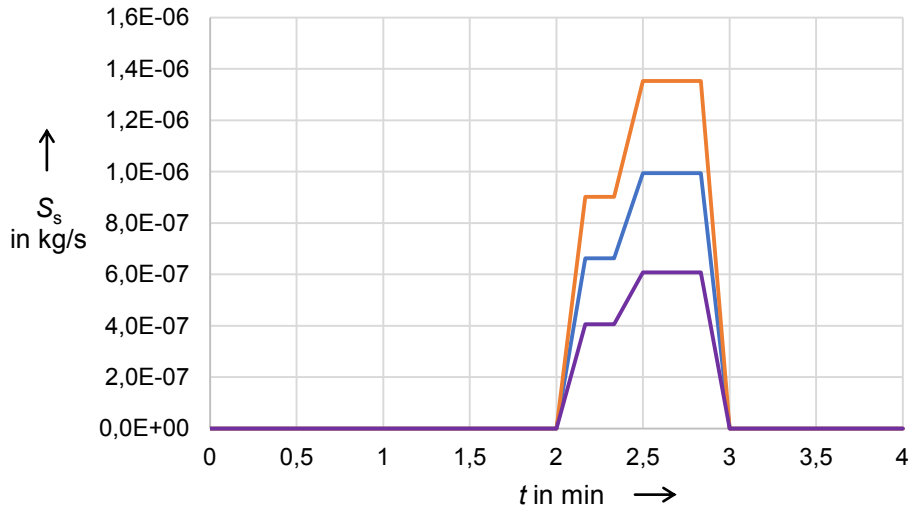

Figure 7.16 TCP source strengths related to secondary event at S0, S1A and S1B

- S_s TCP source strength released in duct system
- t Time
- Scenario S0 with S_{s,ca}
- Variation S1A with S_{s,rec}
- Variation S1B with S_{s,in}

Figure 7.17 shows the change of c_{cab} over time for scenario S0 and its variations S1A and S1B.

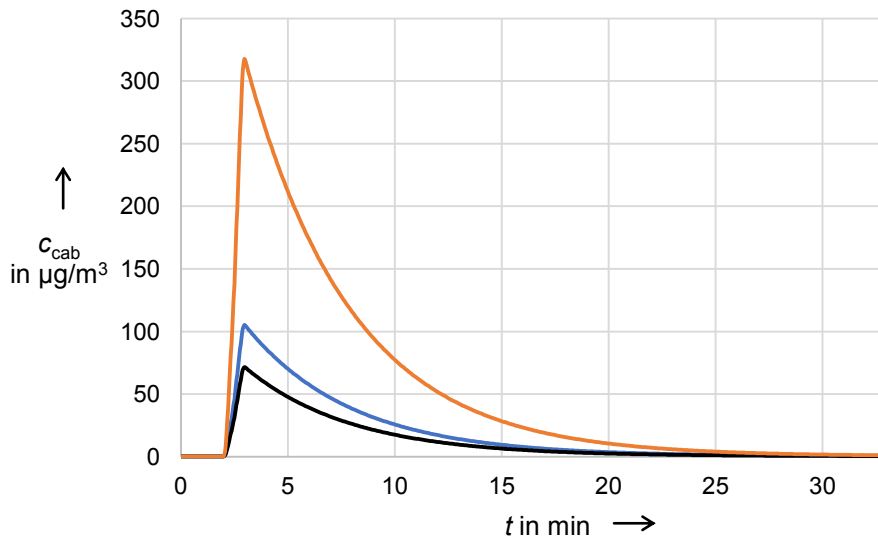

Figure 7.17 TCP concentration in the cabin at scenario S0 and variations S1A and S1B

- c_{cab} TCP concentration in the aircraft cabin
- t Time
- Scenario S0
- Variation S1A
- Variation S1B

7.2.3 Variation of Filter Parameters

The next variation of scenario S0 involves the filter parameters. Two modifications are investigated. **Variation S2A** improves the TCP removal efficiency of the filter in the recirculation path which changes $\alpha_{f,rec}$ to 0,3. $\alpha_{f,in}$ is not modified and remains one. In **variation S2B** a filter is installed at both positions and the removal efficiency further improved. As a result of this, modification $\alpha_{f,rec}$ and $\alpha_{f,in}$ both reach a value of 0,25.

Figure 7.18 shows the change of c_{cab} over time for scenario S0 and its variations S2A and S2B.

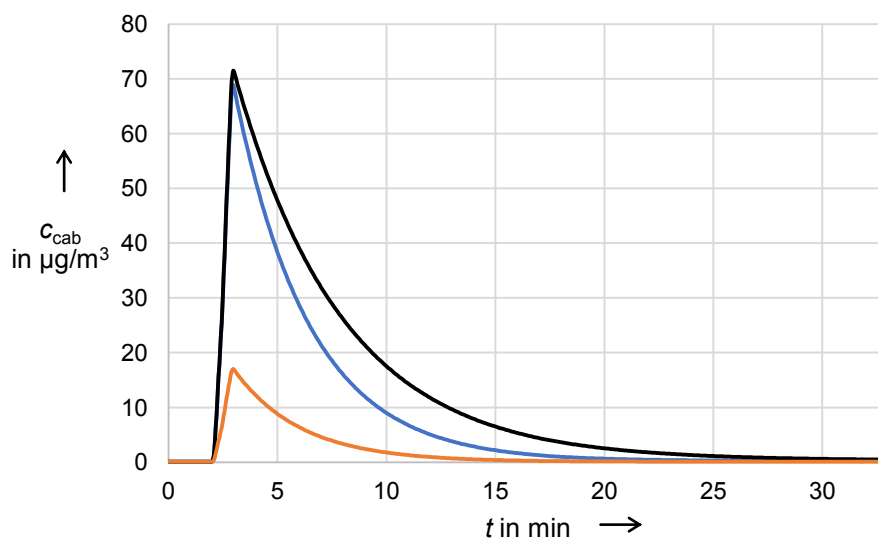

Figure 7.18 TCP concentration in the cabin at scenario S0 and variations S2A and S2B

c_{cab}	TCP concentration in the aircraft cabin
t	Time
— (black)	Scenario S0
— (blue)	Variation S2A
— (orange)	Variation S2B

7.2.4 Variation of Operating Time

Another parameter which is modified in order to demonstrate its influence on the TCP concentration in the cabin is the operating time t_{op} . In **variation S3** the initial value of t_{op} is tripled to 18 months or 549 days. The new $S_{s,avg,ca}$ is calculated using Equations 6.47 and 6.50. The result is $S_{s,avg,ca} = 1,318 \cdot 10^{-6}$ kg/s. Multiplying c_{ca} or $(1 - \alpha_{d,ca})$ by three instead of modifying t_{op} would have the same effect.

Figure 7.19 shows the new values of $S_{s,ca}$ over time. As a reference the curve that belongs to scenario S0 is displayed as well.

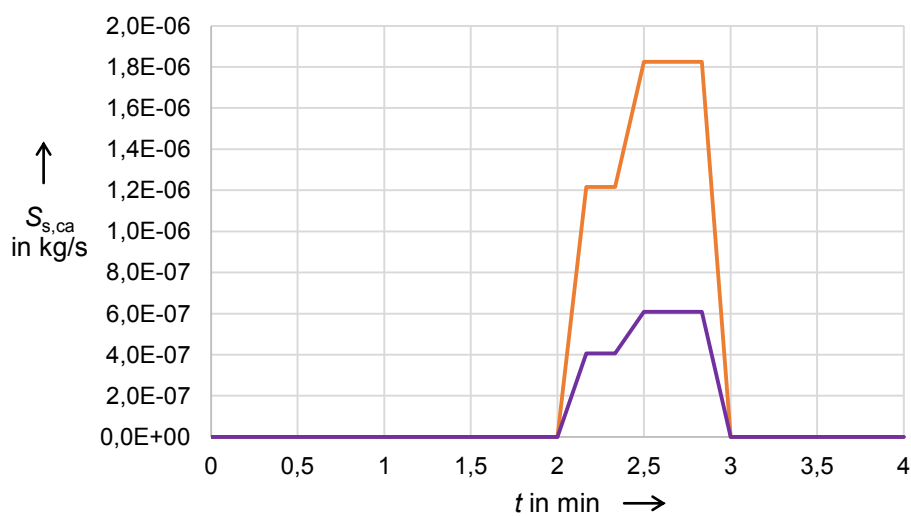

Figure 7.19 TCP source strength secondary event at scenario S0 and variation S3

$S_{s,in}$	TCP source strength released in duct carrying mixed air
t	Time
— (purple)	Scenario S0
— (orange)	Variation S3

Figure 7.20 illustrates the change of c_{cab} over time for scenario S0 and its variation S3.

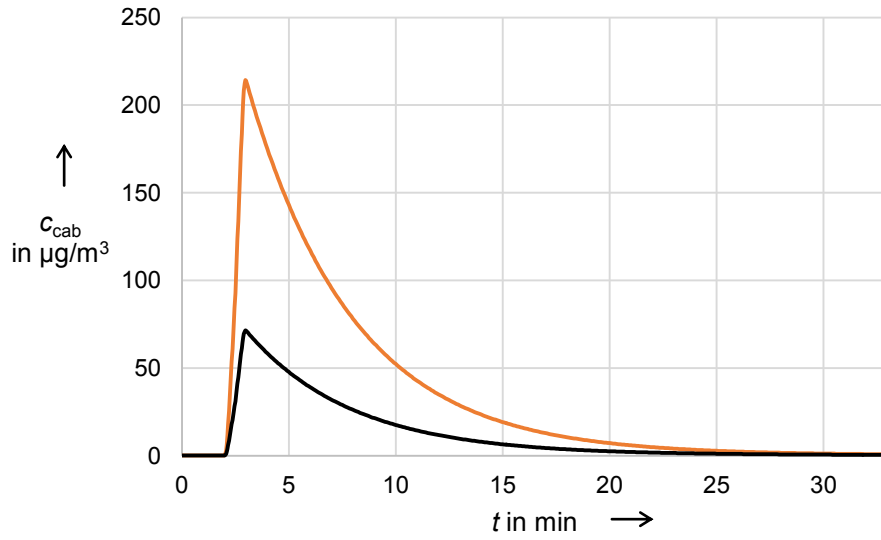

Figure 7.20 TCP concentration in the cabin at scenario S0 and variation S3

c_{cab}	TCP concentration in the aircraft cabin
t	Time
—	Scenario S0
—	Variation S3

7.2.5 Variation of Release Time

The last variation of scenario S0 involves the release time t_{rel} . The portion of accumulated contaminant mass that is released β and the accumulated mass M_d are not modified. In **variation S4A** it is decreased to 30 seconds, in **variation S4B** increased to three minutes, **variation S4C** assumes six minutes, and **variation S4D** twelve minutes. This modification has influence on $S_{s,avg,ca}$ and the lengths of the time intervals where $S_{s,ca} > 0$.

The new values for $S_{s,avg,ca}$ are calculated with Equation 6.50. The results are the following: $8,784 \cdot 10^{-7}$ kg/s for variation S4A, $1,464 \cdot 10^{-7}$ kg/s for S4B, $7,32 \cdot 10^{-8}$ kg/s for S4C and $3,66 \cdot 10^{-8}$ kg/s for S4D.

Figure 7.21 shows the new values of $S_{s,ca}$ over time. As a reference the curve that belongs to scenario S0 is displayed as well.

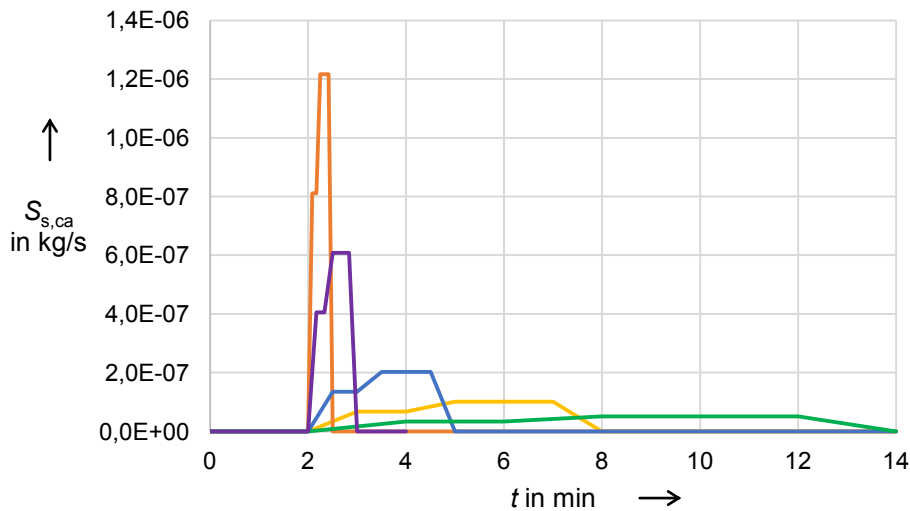

Figure 7.21 TCP source strengths related to secondary event at S0 and variations S4A-D

$S_{s,in}$	TCP source strength released in duct carrying mixed air
t	Time
— (purple)	Scenario S0
— (orange)	Variation S4A
— (blue)	Variation S4B
— (yellow)	Variation S4C
— (green)	Variation S4D

Figure 7.22 illustrates the change of c_{cab} over time for scenario S0 and its variations S4A, S4B, S4C and S4D.

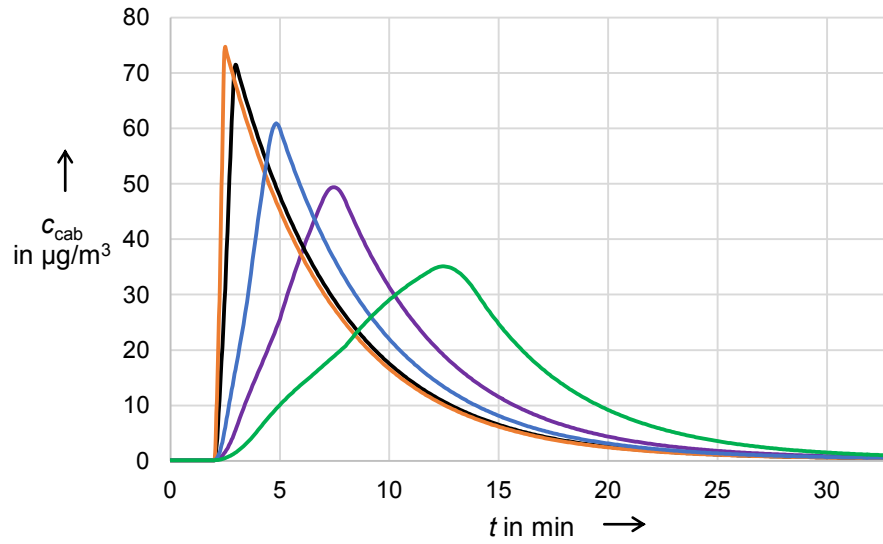

Figure 7.22 TCP concentration in the cabin at scenario S0 and variations S4A-D

c_{cab}	TCP concentration in the aircraft cabin
t	Time
— (black)	Scenario S0
— (orange)	Variation S4A
— (blue)	Variation S4B
— (purple)	Variation S4C
— (green)	Variation S4D

7.3 Discussion of Results

7.3.1 Analysis of Short and Long-Term Contamination Scenarios

The investigations carried out in this chapter focus on the analysis of primary and secondary CACE. It is found that an event causes a peak in terms of contaminant concentration in the cabin. With the assumptions that have been made in the examples the source strength related to an event is expected to be three to five orders of magnitude higher than constant source strengths such as S_i caused by internal emissions. As a result of that, the maximum value of the contaminant concentration in cabin air c_{cab} is significantly higher than the average concentration throughout one flight. This means that when a CACE occurs the related source strength is dominant and other source strengths can often be neglected since their influence on c_{cab} is very little. This effect is demonstrated in Figures 7.3 and 7.15.

When it comes to the assessment of potential health risks related to contaminated cabin air it has to be distinguished between two basic scenarios. On the one hand, the operation of aircraft where no CACE occurs has to be investigated. In this case a relatively constant level of contamination is present to which passengers and especially the crew are exposed over a long period of time.

On the other hand, there might be flights where a CACE occurs and a relatively high amount of contaminants is released over a short period of time, for example five minutes. This scenario leads to a sudden rise in contaminant concentration. As soon as the primary or secondary source strength causing this event drops, the concentration decreases. This source strength is then expected to disappear completely within a few seconds or minutes. Because of the high air exchange rate in aircraft cabins the concentration drops rapidly, and it takes only a few minutes until it reaches a level similar to the condition prior to the event. **EASA 2017** describes this phenomenon as the thinning effect. If a flight where a cabin air contamination scenario occurs is investigated with regard to a potential health risk, it is not sufficient to obtain and evaluate the average value of contaminant concentration in cabin air. The duration of such an event is significantly short compared to the duration of one flight. In the example calculations that were carried out it took between 10 and 20 minutes from the rise of the contaminant concentration in cabin air until the concentration reached a level similar to the concentration before the event occurred. If, for example, a CACE influences the concentration c_{cab} over a period of 15 minutes on a five-hour flight this would cover only 5% of the total flight time.

7.3.2 Evaluation of Specific Results Obtained in Examples

The examples focused on TCP as the contaminant that is analyzed. A maximum TCP concentration has been calculated for all scenarios. It ranges from $17 \mu\text{g}/\text{m}^3$ at variation S2B to $4600 \mu\text{g}/\text{m}^3$ at variation P2, shown in Figures 7.18 and 7.7 respectively. A combination of the scenarios P1A and P2 would lead to even higher peak values of c_{cab} .

A scenario without occurrence of a CACE has not been investigated as an independent example. However, the time intervals covering 0 to 17 min in the primary CACE examples and the time intervals covering 0 to 2 min in the secondary CACE examples represent a flight phase without any influence of an event. For the primary CACE and secondary CACE examples an average TCP concentration of respectively $0,13 \mu\text{g}/\text{m}^3$ and $0,11 \mu\text{g}/\text{m}^3$ is obtained for the phase prior to the event.

7.3.3 General Observations with Regard to CACE

Chapters 7.1 and 7.2 provide information on the TCP concentration in the cabin for specific assumptions that have been made regarding aircraft type, design of the air conditioning system and source strengths. Additionally, the examples provide insights on the general influence of parameters and design characteristics on c_{cab} that are valid for all types of contaminants. Some parameters cannot be modified or are not regarded as a beneficial option when it comes to the reduction of contaminant concentration in aircraft cabins. Other parameters can be influenced by design changes or the introduction of new operational procedures. These means were identified in Chapter 5.

First of all, the influence on c_{cab} of those parameters which are not directly linked to one of the proposed means is described. These are the cabin volume, the portion of recirculated air, the event position, and the duration of contaminant release related to an event.

Obviously, the smaller the cabin volume V_{cab} , the higher the contaminant concentration in the cabin c_{cab} . Thus, V_{cab} and c_{cab} are inversely proportional. This correlation is shown in Figure 7.7. The next parameter which is considered is the portion of recirculated air θ . Figure 7.9 shows that the lower θ , the higher c_{cab} .

As shown in Figure 7.16, the position in the duct system where a secondary event occurs influences the value of the source strength S_s . On top of that, the position determines how the air is mixed and thus directly influences the contaminant concentration in the cabin. The duration of the contaminant release is another aspect which has a significant influence on the total c_{cab} . The value of S_{cp} and the duration of contaminant release are also relevant for primary CACE.

If the source strength causing the CACE is at least three orders of magnitude higher than the sum of all other source strengths, the influence of the other source strengths on c_{cab} can be neglected. If this is the case, the source strength related to the event dominates the behavior of c_{cab} and both become directly proportional. Multiplying S_s of a secondary event or S_{cp} of a primary event by two while no other parameter is changed means that the total contamination concentration in the cabin is also doubled. This effect can be observed in Figure 7.6 when comparing scenario P0 to variation P1A. If the duration of contaminant release is increased while all other parameters remain the same, the peak becomes wider, the maximum value of c_{cab} increases, and the point in time where the maximum value of c_{cab} occurs shifts to the right. This phenomenon is demonstrated by variation P1C shown in Figure 7.6. If based on a certain scenario both the source strength causing the CACE and the release time are modified the two described effects interfere. This is shown by example P1B in Figure 7.6 and all variations shown in Figure 7.22.

The Figures 7.21 and 7.22 point out how significant the combined effect of a reduced event source strength and an increased duration of release is. Comparing variations S4A and S4D shows that the same total amount of TCP is released but the maximum value of the source strength $S_{s,ca}$ of S4A is 24 times higher than the one of variation S4D. However, the maximum value of c_{cab} is only twice as high. As a result of that, the maximum occurring value of the event source strength alone is not sufficient in order to evaluate the health risk for passengers and crew. The release pattern with its individual shape and lengths of time intervals is a crucial information which is needed as well.

Another observation is that the area under the curve in the $S-t$ diagram is directly proportional to the area under the curve in the $c_{cab}-t$ diagram. If the release pattern is modified but the area under the curve in the $S-t$ diagram remains the same, the area under the curve in the $c_{cab}-t$ diagram does not change. This effect is shown in Figures 7.21 and 7.22. Variation P1A in Figures 7.5 and 7.6 shows that if the area in the $S-t$ diagram is doubled, it is also doubled in the $c_{cab}-t$ diagram. Again, this is only the case if the source strength causing the CACE is at least three orders of magnitude higher than the sum of all other source strengths. As a result of that, the other source strengths can be neglected, and it can be assumed that c_{cab} is zero prior to the event and also after the event once the majority of contaminants have been moved overboard.

7.3.4 Effectiveness of Means to Reduce Contaminant Concentration

In Chapter 7.3.3 the parameters and design characteristics which cannot be modified or are not regarded as a beneficial option when it comes to the reduction of contaminant concentration in aircraft cabins were discussed. Now, the parameters that can be influenced by design changes or the introduction of new operational procedures are assessed in terms of applicability, effectiveness and costs. The analysis is based on the five different approaches identified in Chapter 5. The main focus is to reduce the impact of the external source strengths related to outside air, the air conditioning process, and secondary CACE in the duct system. However, some means also reduce contaminant concentrations caused by internal emissions.

As explained in Chapter 6, the introduced air flow model and the derived equations can be applied to standard bleed air systems as well as no-bleed air conditioning systems. However, the following considerations assume a bleed air system as the starting point for design modifications. A no-bleed system represents one of the solutions.

The first approach to reduce c_{cab} is to implement an increased cabin air exchange rate λ . As demonstrated in Chapter 7.1.4, the higher the air exchange rate, the lower c_{cab} related to a primary CACE. It has to be noted that an increased air exchange rate causes a higher flow velocity within the cabin. At some point the velocity might reach a level where it bothers passengers and causes discomfort. Higher flow velocities are also assumed to cause more noise when the air conditioning system is operated. In addition to that, an increased air exchange rate requires more bleed air which is taken from the engines and thus leads to higher fuel consumption. Moreover, a redesign of the air conditioning unit might be required in order to realize higher exchange rates. This would involve additional costs and might lead to bigger or heavier unit. This approach is effective in reducing the impact on c_{cab} of source strengths that are not proportional to the cabin air exchange rate. Taking into account the limitations and operational disadvantages, this approach seems less beneficial than other approaches.

The second approach to reduce c_{cab} is to add filters to the system or replace existing filters by new ones with a better efficiency regarding the type of contaminant or mix of contaminants that is investigated. As shown in Chapters 7.1.7 and 7.2.3, the more filters are installed and the higher their efficiency, the lower the contaminant concentration in the cabin. Reductions of c_{cab} of up to 85% were demonstrated. Moreover, it becomes clear that a filter in the duct carrying mixed air has more influence on the contaminant concentration in the cabin than a filter in the recirculation path. Filters in ducts carrying mixed air directly reduce contamination of external sources. Filters in duct carrying recirculated air indirectly reduce contamination caused by internal and external sources. Recurring costs involve purchasing filters and installing or removing them. The application of additional filters is expected to require relatively little redesign effort. Thus, the costs-benefit of this approach seems to be the best out of all five options.

The third approach to reduce c_{cab} is additional cleaning of the duct system. As described in Chapter 6.6, each time the duct system is cleaned properly the operating time t_{op} is reset to zero. This potentially reduces the source strength related to secondary CACE and thus reduces c_{cab} in case of an event. This is demonstrated in Chapter 7.2.4. This approach can be highly effective but development and accomplishment of the cleaning processes also involves costs and might affect aircraft availability. Cleaning activities does not influence source strengths related to internal processes, the air conditioning process, or outside air.

The next approach is a redesign of the duct system. The sections of the duct system act like filters and therefore have a significant influence on the contaminant concentration in the cabin. If the duct parameters α are decreased the filtering effect gets stronger which directly reduces external source strengths and indirectly reduces internal source strengths. However, this positive effect on c_{cab} only considers the short run. In the long run, it favors secondary CACE because unlike the installed filters which can easily be replaced, the contaminants accumulated along duct surfaces and in other sinks might get released due to some sort of triggering event. Thus, the lower the value of alpha, the more contaminant mass accumulates and the stronger the impact of S_s in case a secondary event occurs. This correlation is demonstrated in Chapter 7.1.6. If the duct sections offer a high value of α , c_{cab} without involvement of S_s increases but the risk associated with secondary events decreases. Any variation of α comes with advantages and disadvantages. Hence, this approach alone it is not regarded as an effective mean in order to reduce c_{cab} .

The last mean which has been identified in order to reduce S_{cp} is a redesign of the bleed air system. On the one hand, this involves a redesign of critical components such as seals and bearings that potentially are reasons for contamination. This would be an effective mean to reduce the contaminant concentration in the cabin caused by contaminant release in the engine or air conditioning unit. If a redesign does not lead to the desired result the introduction of additional maintenance task or reduction of check or replacement intervals might be another option. As demonstrated in Chapter 7.1.2, c_{cab} can be decreased significantly by modifying the dominant source strength. However, the influence of contaminated outside air and internal emissions cannot be affected. Secondary CACE would be affected indirectly since a less powerful S_{cp} would lead to less contaminant accumulations along the duct surfaces or other sinks.

On the other hand, a redesign towards a no-bleed system as it is installed on Boeing 787 aircraft is conceivable. If outside air does not come into contact with the engine and only air bearings are used in the air condition unit, S_{cp} is expected to be zero. The first 17 minutes of the scenarios introduced in Chapter 7.1 give an idea of a situation where S_{cp} does not exist. It has to be kept in mind that any kind of redesign activity involves high costs for design, testing, production and certification of new components. Obviously, the more components are affected, the higher the costs.

As shown above, the implementation of a no-bleed air conditioning system is the most effective mean to reduce or eliminate the source strengths related to primary and secondary CACE. While S_{cp} can theoretically be eliminated completely, S_s can be reduced significantly since the contribution of S_{cp} is extremely little or even zero. Potential secondary events can be further mitigated by designing a duct system that is characterized by high values of α . As a result of that, cleaning of the duct system would not be necessary in order to avoid the occurrence of high values of S_s . A redesign of the system architecture has no effect on the influence of internal emissions and contaminated outside air on c_{cab} . However, the source strengths S_i and S_{oa} are assumed to be less critical in terms of their contribution to the level of contaminant concentration in the cabin.

Out of all means identified, the implementation of a no-bleed air conditioning system is expected to involve the highest costs. Thus, for existing aircraft with a bleed air system it might not be the best option. Instead, the approach of implementing additional filters or using different types of filters might lead to the best cost-benefit in terms of c_{cab} reduction. This could also be combined with a duct system that is characterized by high values of α in order to reduce the accumulation of contaminants on duct surfaces and hence decrease potential secondary source strengths. The modified system with filters at both defined positions would then directly reduce all external contamination sources and indirectly mitigate the influence of internal emissions.

It has to be distinguished between retrofitting an existing aircraft and designing a new aircraft type. Even if a conventional bleed air system is chosen for the development of a new aircraft, certain costs are involved for modification, integration, test, and certification of the air conditioning system. As a result of this, the cost-benefit in terms of c_{cab} reduction might be better if a no-bleed system is implemented instead of simply adding filters to a conventional air conditioning system. In addition to non-recurring costs in the design phase, the operating costs of the system have to be taken into account as well. This would involve maintenance costs such as a replacement of the filters at a certain interval. Another important aspect is the efficiency in terms of reduced fuel burn that can potentially be improved by implementing a no-bleed electrical system architecture (**Boeing 2007**).

7.4 Spreadsheets for Calculation of Example Scenarios

Microsoft Excel has been used to carry out the calculations and create the figures showing the change in contaminant concentration over time for the example scenarios. The spreadsheets that were used are published on Harvard Dataverse. The download link can be found on page 2 of this report. The file *Example_Calculations_Primary_CACE.xlsx* is dedicated to Chapter 7.1 and the file *Example_Calculations_Secondary_CACE.xlsx* belongs to Chapter 7.2.

Figure 7.23 shows a screenshot of the worksheets used for calculation of primary CACE. Each variation of the basic primary or secondary scenario is investigated on a dedicated worksheet.

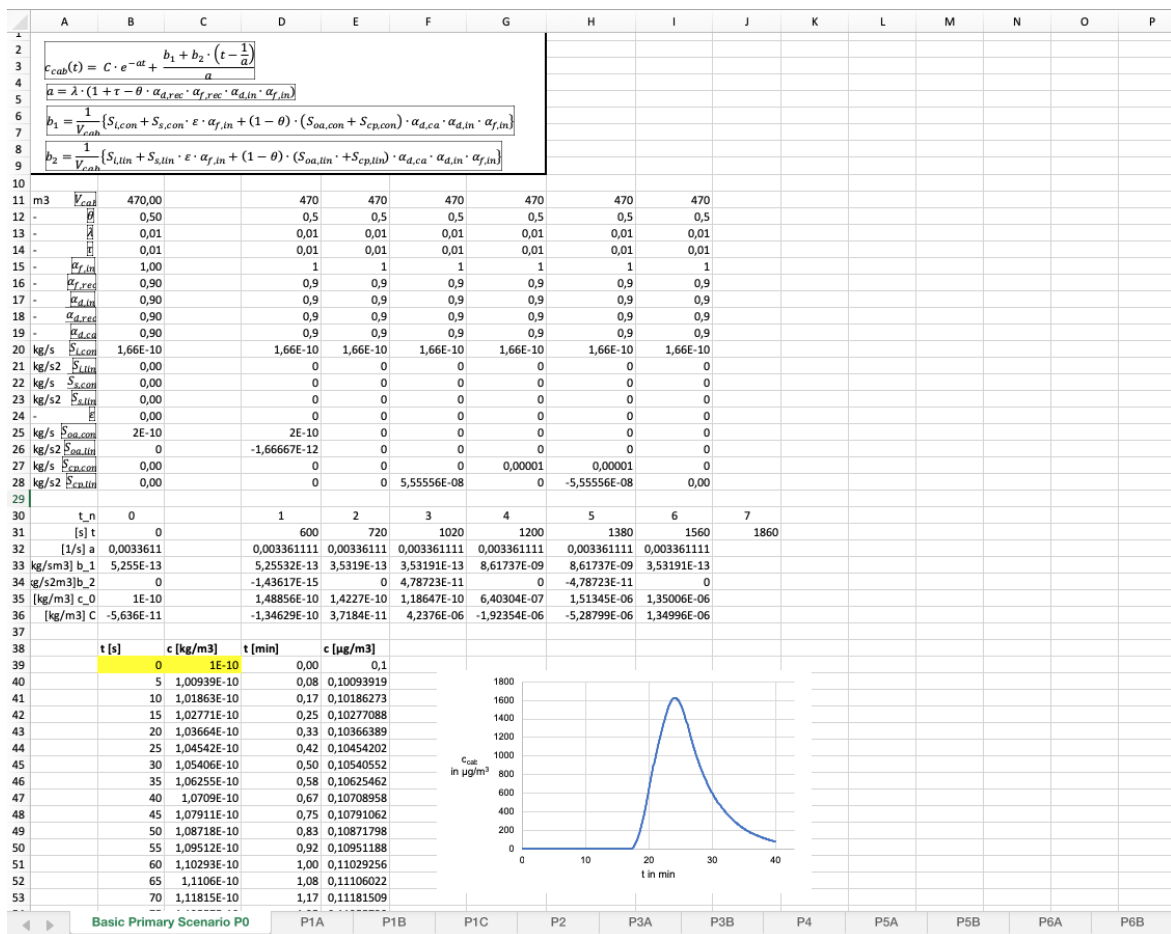

Figure 7.23 Screenshot of worksheets used for calculation of primary CACE

Reviewing the provided worksheets with the sample calculations can help to understand the applied method. Moreover, these worksheets can be used as a starting point for calculations of different contamination scenarios. Users can adapt the worksheets to their needs by changing system characteristics or even modifying the release patterns of certain source strengths. The release pattern is characterized by the number and lengths of time intervals. As explained in Chapter 6.4 each time interval or section needs to be handled as an individual IVP. This

means that the constant C needs to be recalculated using the new initial conditions of the next time interval.

If system parameters describing the air conditioning system or source strengths are modified while the release pattern remains the same, no formulas need to be changed and the worksheets immediately generate accurate results. However, if changes are made to the release pattern, the provided worksheets need to be modified accordingly. The parameter t_n shown in Figure 7.23 is used to number the time intervals consecutively. Cells that are highlighted in yellow indicate the beginning of new time interval which means that the formula for calculating the concentration needs to change at that point.

For further research activities it is recommended to investigate more contamination scenarios using the calculation method described in this report. This would contribute to getting a better understanding of the effects influencing contaminant concentration in cabin air. It is crucial to use input parameters that are as close to reality as possible since accuracy of the results depends on the accuracy of input parameters. This especially applies to critical parameters such as source strengths S and the portion of contaminants passing filters and duct sections α .

8 Summary

When it comes to investigating the causes of cabin air contamination it has to be distinguished between four different contamination sources. These are emissions within the cabin, outside air, the air conditioning process, and sinks and surfaces of the duct system. Moreover, six types of contaminants have been identified which vary in their source, concentration and health risk. While the behavior and effect on the human body of biologic aerosols, combustion particles, CO, CO₂, and O₃ are generally well understood, rather little is known about volatile organic compounds and organophosphorus compounds in aircraft cabin environment.

An air flow model has been introduced and based on that an equation has been derived that can be applied in order to investigate how the concentration of a chosen contaminant in cabin air changes with time under given conditions. Moreover, the provided method allows investigating the influence of each parameter on the overall level of contaminant concentration. If certain source strengths or system characteristics are not known they need to be estimated based on either engineering judgement or scientific measurements. As long as at least one source strength or system parameter is not constant over time, the overall level on contamination in the cabin is also not constant.

The derived equation does not focus on a specific system design or a specific toxic substance. It can be used to analyze various system architectures and different types of contaminants. Moreover, all flight phases can be investigated. Scenarios where certain parameters change rapidly are of particular interest. This is the case for primary and secondary CACE. These have been investigated by carrying out example calculations in Chapter 7.

The results demonstrate the thinning effect. If a relatively high amount of contaminants is released over a short period of time this leads to a peak in contaminant concentration passengers and crew in the aircraft cabin are exposed to. As soon as the primary or secondary source strength causing this event drops, the concentration decreases rapidly due to the high air exchange rate present in aircraft cabins.

Additionally, the calculations show that when a CACE occurs the related source strength is dominant and other source strengths can often be neglected since their influence on contaminant concentration in cabin air is very little. Another aspect that has been demonstrated is the importance of the release pattern with its individual shape and lengths of time intervals. This information is crucial since it has a massive influence on the peak contaminant concentration that occurs during a CACE.

With regard to the five different approaches (see Chapter 5) which aim at reducing the contaminant concentration in aircraft cabins, the obtained results indicate that adding filters and redesigning the bleed air system are the most promising countermeasures.

It has to be noted that the air flow model which represents the basis of the equation is a simplified approach. When interpreting results obtained by the tools developed in frame of this project, awareness of the simplifications explained in Chapter 6 is needed. However, the air flow model considers more design characteristics of aircraft air conditioning systems than existing models such as the one introduced in **EASA 2017** and thus provide results that are closer to reality.

The method can provide a good picture of how the contaminant concentration in cabin air changes with time for any given source strength scenario. These scenarios could only be assumed in this project report to show how the method works. The challenge is, to find real source strength scenarios, in order to calculate real contaminant concentrations in the cabin changing with time.

References

- Bagshaw 2014** BAGSHAW, Michael: *Health Effects of Contaminants in Aircraft Cabin Air. Version 2.7, 2014.* – URL: <https://www.asma.org/asma/media/asma/Travel-Publications/Air-contamination-health-effects-report-v2-7-Apr2014.pdf>, archived at: <http://perma.cc/E33T-SHQS>
- Bagshaw 2015** BAGSHAW, Michael: *The Cabin Environment and Aircrew Performance.* RAeS lecture in cooperation with the DGLR and VDI, HAW Hamburg, 3 December 2015. Presentation, 2015.
- Boeing 2005** NELSON, Tim: *787 Systems and Performance.* Flight Operations Engineering, Boeing Commercial Airplanes, 2005. – URL: <http://myhres.com/Boeing-787-Systems-and-Performance.pdf>, archived at: <http://perma.cc/B8RX-Y49V>
- Boeing 2007** SINNETT, Mike: *787 No-Bleed Systems: Saving Fuel and Enhancing Operational Efficiencies.* Boeing Commercial Airplanes, Aero Quarterly 04, 2007. – URL: https://www.boeing.com/commercial/aeromagazine/articles/qtr_4_07/AERO_Q407_article2.pdf, archived at: <http://perma.cc/TU26-T4H3>
- CAA 2004** CIVIL AVIATION AUTHORITY, Gatwick Airport South: *CAA Paper 2004/04: Cabin Air Quality,* 2004. – URL: https://publicapps.caa.co.uk/docs/33/CAPAP2004_04.pdf, archived at: <http://perma.cc/8AZF-VPZ5>
- Cannon 2016** CANNON, Frank: *Aircraft cabin air contamination and aerotoxic syndrome – a review of the evidence.* Collegium Basilea: Nanotechnology Perceptions, vol. 12, pp. 73-99, 2016. Available at: <http://skybrary.aero/bookshelf/books/3594.pdf>, archived at: <https://perma.cc/58DT-R2T6>
- De Boer 2015** DE BOER, Jacob; ANTELO, Angel; VAN DER VEEN, Ike; et al.: *Tricresyl phosphate and the aerotoxic syndrome of flight crew members - Current gaps in knowledge.* Chemosphere, vol. 119, pp. S58-S61, 2015. Available at: <https://doi.org/10.1016/j.chemosphere.2014.05.015>

- De Ree 2014** DE REE, Hans; VAN DEN BERG, Martin; BRAND, Teus; et al.: *Health risk assessment of exposure to TriCresyl Phosphates (TCPs) in aircraft: a commentary*. *Neurotoxicology*, vol. 45, pp. 209-215, 2014. Available at: <https://doi.org/10.1016/j.neuro.2014.08.011>
- EASA 2017** EUROPEAN AVIATION SAFETY AGENCY (EASA): *CAQ – Preliminary Cabin Air Quality Measurement Campaign*, 2017. – URL: <https://www.easa.europa.eu/document-library/research-projects/easarepresea20144>, archived at: <http://perma.cc/Z6S7-QXE5>
- FAA 2008** FEDERAL AVIATION ADMINISTRATION (FAA): *Advisory Circular 25.795-4: Passenger Cabin Smoke Protection*, 2008. – URL: https://www.faa.gov/documentLibrary/media/Advisory_Circular/AC_25_795-4.pdf, archived at: <http://perma.cc/4Q9P-JUVF>
- Guan 2014a** GUAN, Jun; GAO, Kai; WANG, Chao; et al.: *Measurements of volatile organic compounds in aircraft cabins. Part I: Methodology and detected VOC species in 107 commercial flights*. *Building and Environment*, vol. 72, pp. 154-161, 2014. Available at: <https://doi.org/10.1016/j.buildenv.2013.11.002>
- Guan 2014b** GUAN, Jun; GAO, Kai; WANG, Chao; et al.: *Measurements of volatile organic compounds in aircraft cabins. Part II: Target list, concentration levels and possible influencing factors*. *Building and Environment*, vol. 75, pp. 170-175, 2014. Available at: <https://doi.org/10.1016/j.buildenv.2014.01.023>
- Harrison 2016** HARRISON, Virginia; MACKENZIE ROSS, Sarah J.: *An emerging concern: Toxic fumes in airplane cabins*. *Cortex*, vol. 74, pp. 297-302, 2016. Available at: <https://doi.org/10.1016/j.cortex.2015.11.014>, open access available at: <http://oro.open.ac.uk/45185/8/45185.pdf>
- Hunt 1994** HUNT, Elwood; SPACE, David: *The Airplane Cabin Environment: Issues Pertaining to Flight Attendant*, 1994. Available at: <http://citeseerx.ist.psu.edu/viewdoc/summary?doi=10.1.1.304.7321>, archived at: <https://perma.cc/Z7LQ-TPZ8>

- Jetcraft 2015** JETCRAFT.COM: *AIRBUS ACJ319 Overview (1999 – Present)*, 2015. – URL: <https://www.jetcraft.com/jetstream/2015/06/airbus-acj319-overview-1999-present>, archived at: <http://perma.cc/FA7Q-5GXA>
- Liyasova 2011** LIYASOVA, Mariya; LI, Bin; SCHOPFER, Lawrence M.; et al.: *Exposure to tri-o-cresyl phosphate detected in jet airplane passengers*. *Toxicology and Applied Pharmacology*, vol. 256, no. 3, pp. 337-347, 2011. Available at: <https://doi.org/10.1016/j.taap.2011.06.016> , open access at: <https://www.ncbi.nlm.nih.gov/pmc/articles/PMC3205265/>
- Megson 2016** MEGSON, David; ORTIZ, Xavier; JOBST, Karl J.; et al.: *A comparison of fresh and used aircraft oil for the identification of toxic substances linked to aerotoxic syndrome*. *Chemosphere*, vol. 158, pp. 116-123, 2016. Available at: <https://doi.org/10.1016/j.chemosphere.2016.05.062> (Open Access)
- Michaelis 2017** MICHAELIS, Susan; BURDON, Jonathan; HOWARD, Vyvyan: *Aerotoxic Syndrome: A New Occupational Disease?*. *Public Health Panorama*, vol. 3, no. 2, pp. 198-211, 2017. – URL: http://www.euro.who.int/__data/assets/pdf_file/0019/341533/5_OriginalResearch_AerotoxicSyndrom_ENG.pdf, archived at: <http://perma.cc/AWA2-FWRR>
- Nagda 2003** NAGDA, Niren L.; RECTOR, H.E.: *A critical review of reported air concentrations of organic compounds in aircraft cabins*. *Indoor Air*, vol. 13, no. 3, pp. 292-301, 2003. Available at: <https://doi.org/10.1034/j.1600-0668.2003.00202.x>
- NAP 1986** NATIONAL ACADEMY PRESS (NAP): *The Airliner Cabin Environment: Air Quality and Safety*. Washington, D.C., 1986. – URL: <http://nap.edu/913>
- NRC 2002** NATIONAL RESEARCH COUNCIL (NRC): *The Airliner Cabin Environment and the Health of Passengers and Crew*. Washington, D.C., 2002. Available at: <https://doi.org/10.17226/10238>
- Scholz 2005** SCHOLZ, Dieter: *Aircraft Systems*. Hamburg, HAW Hamburg, Department of Automotive and Aeronautical Engineering, Lecture Notes, 2005. Available at: <http://www.profscholz.de>

- Scholz 2017a** SCHOLZ, Dieter: *Aircraft Cabin Air and Engine Oil – A Systems Engineering View*, Hamburg Aerospace Lecture Series (HALS), DGLR / RAeS / VDI / ZAL / HAW Hamburg / VC / UFO, HAW Hamburg, 27 April 2017, <https://doi.org/10.5281/zenodo.1186593>
- Scholz 2017b** SCHOLZ, Dieter: *Aircraft Cabin Air and Engine Oil – An Engineering View*. International Aircraft Cabin Air Conference 2017 (Imperial College, London, 20. September 2017). Preprint of Paper, 2017. Available at: <http://cabinair.profscholz.de>
- Scholz 2017c** SCHOLZ, Dieter: *Aircraft Cabin Air – Quality or Contamination?*. Personalversammlung Kabine (Frankfurt, 20. November 2017), Deutsche Lufthansa AG. Presentation, 2017. Available at: <http://cabinair.profscholz.de>
- Solbu 2011** SOLBU, Kasper; DAAE, Hanne L.; OLSEN, Raymond; et al.: *Organophosphates in aircraft cabin and cockpit air - Method development and measurements of contaminants*. Journal of Environmental Monitoring, vol. 13, no. 5, pp. 1393-1403, 2011. Available at: <https://doi.org/10.1039/C0EM00763C>
- VDI 2017** AHRENS, Ralph H.: *Ultrafeinstaub am Flughafen*. VDI nachrichten, No. 2, 2017. – URL: <https://www.vdi-nachrichten.com/Technik/Ultrafeinstaub-am-Flughafen>, archived at: <http://perma.cc/V2Z2-LJBF>
- Wang 2008** WANG, Xinlei; WANG, Aijun; ZHANG, Yuanhui; et al.: *Experimental study of ventilation effectiveness and air velocity distribution in an aircraft cabin mockup*. Building and Environment, vol. 43, no. 3, pp. 337-343, 2008. Available at: <https://doi.org/10.1016/j.buildenv.2006.02.024>

All online resources have been accessed on 2018-03-13 or later.