

Freeform Bioprinting of Liver Encapsulated in Alginate Hydrogels Tissue Constructs for Pharmacokinetic Study

Chang, R., Starly*, B., Sun, W.

Dept. of Mechanical Engineering, Drexel University, Philadelphia, PA 19104

Culbertson, C., Kansas State University, Manhattan, KS 66506

Holtorf, H., Gonda, S., NASA JSC, Houston, Texas 77058

Abstract

An *in vitro* model that can be realistically and inexpensively used to predict human response to various drug administration and toxic chemical exposure is needed. By fabricating a microscale 3D physiological tissue construct consisting of an array of channels and tissue-embedded chambers, one can selectively develop various biomimicking mammalian tissues for a number of pharmaceutical applications, for example, experimental pharmaceutical screening for drug efficacy and toxicity along with apprehending the disposition and metabolic profile of a candidate drug. This paper addresses issues relating to the development and implementation of a bioprinting process for freeform fabrication of a 3D cell-encapsulated hydrogel-based tissue construct, the direct integration onto a microfluidic device for pharmacokinetic study, and the underlying engineering science for the fabrication of a 3D microscale tissue chamber as well as its application in pharmacokinetic study. To this end, a prototype 3D microfluidic tissue chamber embedded with liver cells encapsulated within a hydrogel matrix construct is bioprinted as a physiological *in vitro* model for pharmacokinetic study. The developed fabrication processes are further validated and parameters optimized by assessing cell viability and liver cell phenotype, in which metabolic and synthetic liver functions are quantitated.

1. Introduction

Tissue engineering approaches exploit living cells in a variety of ways towards the goal of restoring, maintaining, or enhancing tissues and organs [1,2]. In order to engineer biological tissues *in vitro*, cultured cells are coaxed to grow on bioactive resorbable scaffolds, i.e. temporary synthetic extracellular matrices that provide the biological, chemical, and mechanical cues to guide the cell's eventual differentiation and assembly into three-dimensional (3D) tissues [3]. While regeneration of different tissues and organs are currently under heavy investigation and development, new applications of tissue engineering in designing *in vitro* physiological models to study disease pathogenesis and for pharmacokinetic study are also extremely promising [4]. One possible application of *in vitro* physiological models established from biology-based engineering analysis is in the area of pharmaceutical drug screening and new drug discovery and development. *In vitro* cell culture models with human liver cells have already shown great potential in predicting studies on drug toxicity and metabolism in the pharmaceutical industry [5,6]. For example, Zeilinger et al developed a bioreactor culture model that permits the 3D coculture of liver cells under continuous medium perfusion with decentralized mass exchange and integral oxygenation [7]. Powers and Domansky designed a microfabricated array bioreactor for perfused 3D liver culture at reported perfusate flow rates and fluid shear stress at or below the physiological shear range *in vivo*. These primary rat liver cells cultured for two weeks in the channels rearranged themselves to form tissue-like structures.

* Current address: School of Industrial Engineering, University of Oklahoma, Norman, OK 73019

Shuler et al has conceived a microscale *in vitro* system to serve as a human surrogate for drug analysis which adheres stringently to a physiologically-based pharmacokinetic (PBPK) model in which disparate organs are serially connected by channels to comprise a fluid circuit. This methodology is then used to mechanistically simulate and predict the fate of drugs or other substances *in vivo*. Therefore, one can conceive and fabricate a stamp-sized animal-on-a-chip microfluidic device which, with great fidelity, replicates an experimental drug's being broken down by the metabolizing liver, absorbed by the intestines, and held onto by fat [8-10].

The present work explores the development and study of *in vitro* three-dimensional Microfluidic Microanalytical Microorgan Device (3MD) for simulation of physiological human response to drug administrations and toxic chemical exposure. The applied solid freeform fabrication technology is a viable bioprinting freeform fabrication process for layer-by-layer extrusion of 3D cell-encapsulated hydrogel-based tissue constructs. By fabricating a 3D *in vitro* tissue analog consisting of an array of channels with tissue-embedded chambers, one can selectively biomimic different mammalian tissues for a multitude of applications, foremost among them liver tissue for clinical pharmaceutical screening of drug efficacy and toxicity. The research conducted is aimed at the achievement of high-throughput reproducible fabrication of bioprinted tissue constructs and 3D organ chambers, maintenance of structural integrity and the integration with the microfluidic platform, and enhancement of cell viability and cell phenotype retention. More specifically, the objectives are to develop a viable bioprinting process for fabrication of reproducible 3D cell-encapsulated alginate-based tissue constructs; to fabricate 3D organ chambers, i.e., bioprinted liver tissue constructs with surface-treated silicon microfluidic devices; and to study the effect of the process on cell viability and cell-specific function retention.

2. System Configuration for 3D Tissue Constructs Within Microfluidic Device

2.1 Overview

The bioprinting process is integrated with a microfluidic device to fabricate 3D tissue/organ constructs/chambers, as opposed to producing 2D cell monolayers (Figure 1). Biological studies reveal the instability cellular phenotype and reduced tissue-specific gene expression with conventional monolayer *in vitro* culture techniques [11-13]. A three-dimensional tissue model will, in contrast, foster improved retention of hepatocyte-specific function.

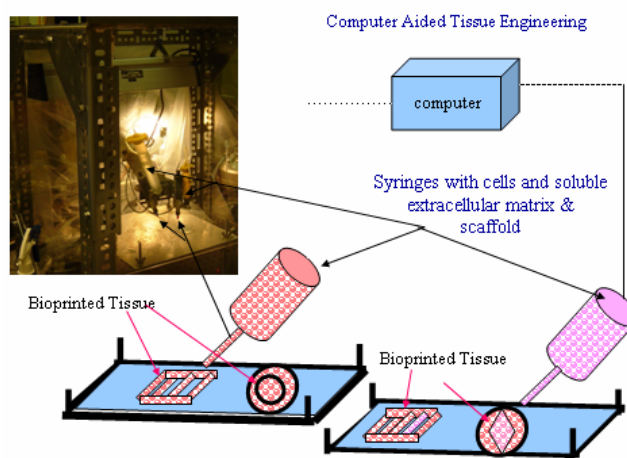

Figure 1: Overview of Bioprinting Tissue-on-a-Chip Approach

Furthermore, direct cell deposition of encapsulated cells offers tighter control over the spatial distribution of cells and doesn't rely upon cell migration to populate the scaffold, allowing one to assemble high cell density or co-culture multiple cell types within a 3-dimensional construct. This can create tissue structures that more closely resemble their *in vivo* state. Cell-cell communication either from direct contact or paracrine signaling is important for proper cellular behavior, differentiation, and proliferation, along with the concomitant extracellular matrix produced by the neighboring cells. Furthermore, optimization of process parameters (e.g. nozzle pressure, motion arm velocity, nozzle tip size etc.) and material parameters (e.g. biopolymer viscosity, crosslinking agent concentrations, etc.) have been done to achieve high-fidelity 3D structures and seamless integration onto a microfluidic tissue micro-organ chambers.

2.2 Modifications of System for Tissue-on-a-chip Application

First, mouse hepatocytes are encapsulated within alginate hydrogels and bioprinted through the system into a desired pattern within the microfluidic circuits. The other component to the microfluidic microanalytical microorgan device (3DM) system is the microfluidic device with indented chambers. The feasibility of using a standard soft-lithography technique is explored to fabricate microscale *in vitro* device with microchannels and multi-chambers to house the bioprinted tissue. The preferred material for fabrication of the microchip for housing the embedded tissue is PDMS. PDMS elastomer soft lithography is combined with the micro-molding techniques to fabricate 3D micro-fluidic chambers. The advantages of these fabricated chambers are the ease of bonding, optical properties, and permeability to gases for biological application.

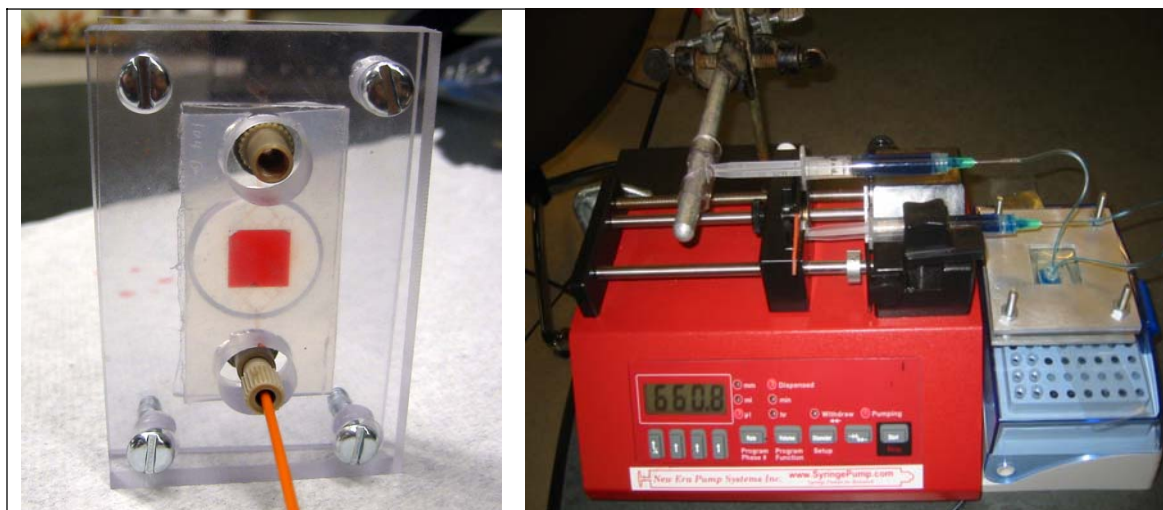

Figure 2: Setup of Bioprinted Tissue-on-a-chip for Medium/Drug Flow Study

The next step is to bioprint the the cell-encapsulated alginate constructs within a PDMS chambers. The PDMS chambers contain a 10mm x 10mm x 0.6mm (Width x Length x Height) indentation. In order to integrate the hydrophilic alginate constructs onto the PDMS substrate, UV treatment was applied to the PDMS chips to oxidize the surface methyl groups to form silanol groups along with roughening the surface. Therefore, a hydrophilic surface with good wettability and improved traction is attained. Next, the cell-encapsulated alginate construct is directly bioprinted within the tissue chamber indentation on the PDMS microchip, thus forming

an integrated 3-D tissue chamber unit. Figure 2 shows a setup of applying such tissue-on-a-chip unit for medium/drug flow study.

A schematic of medium/drug flow circulation in the mini-bioreactor is shown in Figure 3. To demonstrate effective drug metabolism in the liver chamber, a non-fluorescent prodrug is fed into the system through the inlet port, metabolized by the liver chamber, and then produces an effluent fluorescent metabolite for analysis collected at the outlet port. Results of such analysis can be used to understand the relative pharmacokinetic efficiency as well as relevancy of the tissue chambers design for human application.

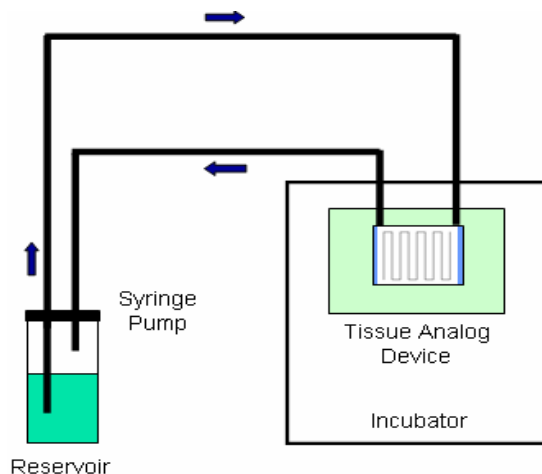

Figure 3: Schematic of Medium/Drug Flow Circuit through tissue chambers

3. Bioprinting on a Chip Pattern

3.1 Overview of existing bioprinting system

A proprietarily developed Drexel multinozzle bioprinting system is capable of depositing heterogeneous materials, cell types, and biological factors in a controlled and reproducible manner [14,15]. This bioprinting process employs solid freeform fabrication (SFF) techniques in conjunction with computer-aided modeling of heterogeneous structures to build biopolymer-based 3D cell-embedded tissue constructs. The deposition system utilizes microvalve nozzle systems that can deposit a wide range of solutions with a wide range of material and biological properties. The system configuration allows a pre-specified computer-aided design (CAD) to be converted into a layered process toolpath to extrude biopolymeric materials, cells, and other biological factors through various nozzle systems. An overview of the bioprinting system configuration is shown in Figure 4.

3.2 Fluid dynamical modeling of the bioprinting system

The bioactive fabrication process described herein involves extruding live cells admixed homogeneously with sodium alginate through the pneumatic system. In the deposition, the cells are exposed to the shear mechanical perturbations within the cell suspension that could potentially permanently kill or temporarily damage cells, thereby altering functionality (e.g., drug metabolism). Therefore, an expression for the shear stress would be helpful in quantifying

the amount of shear that cells may experience as they traverse the pneumatic-driven bioprinting nozzle system.

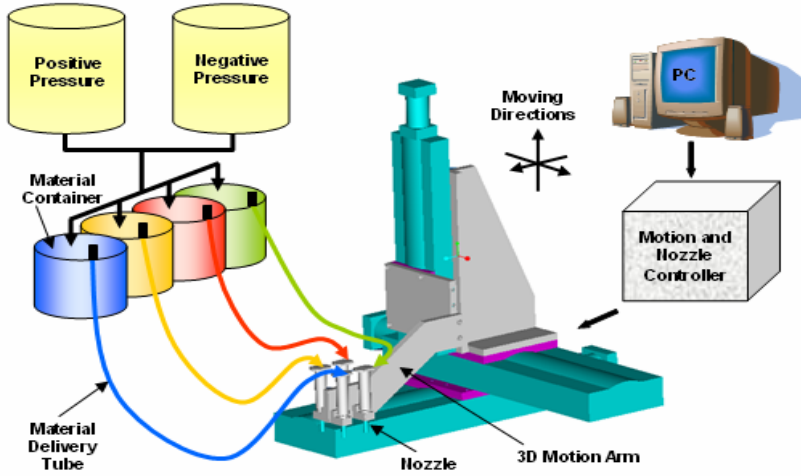

Figure 4: Overview of System Configuration of 3D Bioprinting System

Fundamental equations from fluid dynamics can be integrated into an analytical model of the mechanical forces on cells and biomaterial flowing through a nozzle tip. First of all, for flow within a specified nozzle tip, the pressure gradient in the z direction (direction of deposition) can be expressed as:

$$\frac{dp}{dz} = -\frac{1}{r} \frac{d(r\tau_{rz})}{dr} + \rho g \quad (1)$$

where τ_{rz} is the shear stress and ρ is density of cell suspension.

Hence,

$$\frac{1}{r} \frac{d(r\tau_{rz})}{dr} = \rho g - \frac{p_{out} - p_{in}}{L} \quad (2)$$

Where L is the length of the nozzle tip and p_{in} , p_{out} are pressures at nozzle entry and exit respectively.

Upon integration, Eq (2) becomes:

$$\tau_{rz} = \frac{(p_{out} + \rho g L - p_{in})r}{2L} + \frac{C}{r} \quad (3)$$

Applying boundary conditions where τ_{rz} must be finite at $r=0$, constant C becomes 0, and therefore the expression for shear stress as a function of radius is:

$$\tau_{rz} = \frac{(p_{out} + \rho gL - p_{in})r}{2L} \quad (4)$$

Further, the maximum shear stress τ_{max} in the pneumatic nozzle is represented in terms of the process parameters as shown in Equations (3.59) and (3.60):

$$\tau_{max} = K \left(\frac{Q}{\pi R^3} \right)^n \quad (5)$$

$$\tau_{max} = K \left(\frac{n}{3n+1} \right)^n \gamma_0^{n-1} \left(\frac{\partial P / \partial z}{2\eta_0} \right) R \quad (6)$$

where η is the viscosity, $\dot{\gamma}$ is the shear rate, R is the nozzle tip radius, constant K is the consistency index, and the constant n is the power law index that is equal to unity for Newtonian liquids and is less than one for non-Newtonian liquids [16].

3.3 Bioprinted 3D Tissue Construct Structural Formability

A micro-scale liver tissue analog has been designed and fabricated for studying drug metabolism and its pharmacokinetic effects on secondary organ function via direct deposition of a three dimensional heterogeneous cell-seeded hydrogel-based matrix. By integrating the bioprinting system with a CAD environment, notable feasibility and reproducibility of 3D structures has been realized within micron-order dimensional specifications and hence can be used for parametric studies (Figure 5).

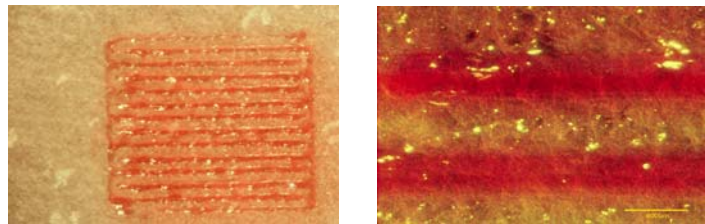

Figure 5: Bioprinted Tissue Construct Structural Formability

4. Preliminary Study of Cell Viability and Hepatocyte-Specific Function

4.1 Preliminary Study of Cell Viability

Preliminary cell viability assays were conducted to study the effect of the bioprinting process on cell survival. The aim of this study was to evaluate the cell viability ratio at Day 0 of the bioprinting system. The experimental setup for this study (Figure 6) involved 2 test samples and one control. Test 1 was the bioprinting of alginate and hepatocytes with cell medium serving as

the cross-linking agent. Test 2 was the bioprinting of alginate and hepatocytes with a CaCl_2 polymerizing cross-linker. Both the process and material parameters for Test 1 and Test 2 were held constant. The control implemented was manual pipetting of alginate and hepatocytes with cell medium as the cross-linking agent. The same cell density (175,000 cells/mL) was used in both tests and the control.

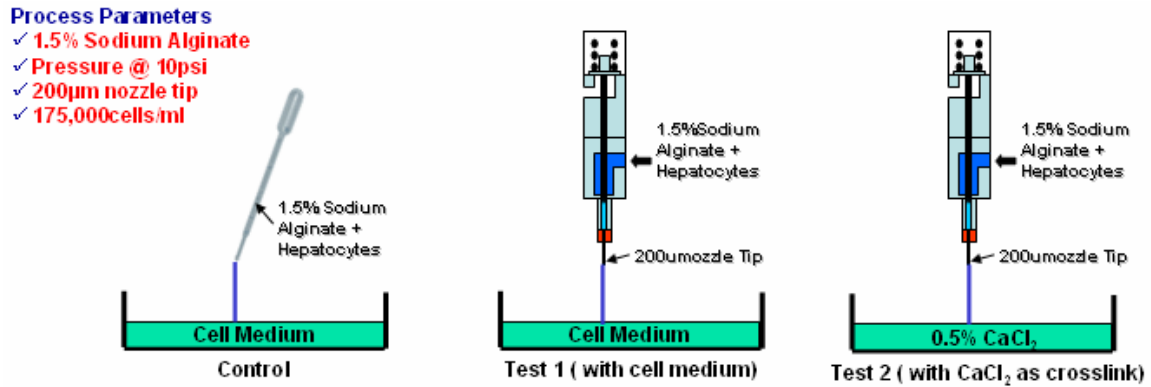
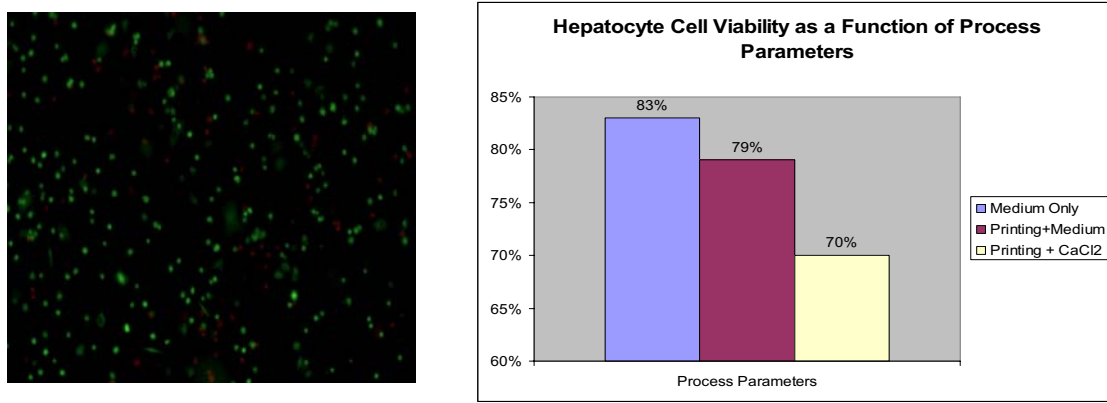

Figure 6: Post-Processing Hepatocyte Cell Viability

For this setup, qualitative and quantitative assays were carried out with Live/Dead cell assay and Alamar Blue cell assay respectively. Each data point represented samples taken at Day 0 shortly after bioprinting and subsequent cross-linking. The rationale for this setup with assay was to compare and isolate the effects of the bioprinting process and biomaterial cross-linking agent on the cell viability. Preliminary testing demonstrated good initial cell viability of post-assembly bioprinted encapsulated hepatocytes under biofriendly conditions with Live/Dead cell assays and Alamar Blue staining (Figure 8).



(a) Live-Dead Cell Assay (b) Alamar Blue Quantitative Cell Viability Assay

Figure 7: Post-Processing Hepatocyte Cell Viability

Figure 7a is a qualitative assessment at Day 0 of the cell viability with metabolically live cells denoted in green and metabolically inactive dead cells in red. Figure 7b shows the cell viability ratios at Day 0 obtained from quantitative fluorescent measurements of the two test setups and control. The control with no bioprinting and cell medium cross-linker showed 83% cell viability. Test 1 bioprinting alginate/hepatocytes with cell medium cross-linker

demonstrated a 79% cell viability. Test 2 bioprinting alginate/hepatocytes with CaCl₂ cross-linker gave a 70% cell viability. A comparison of Test 1 and control indicated a slight drop in cell viability may be attributed to the bioprinting process. Further, a comparison of Test 2 and Test 1 indicated that a larger drop in cell viability may be attributed to the substitution of a stronger cross-linker (CaCl₂) versus one with trace amounts of cross-linking ions (cell medium). Overall, the cell viability tests showed that hepatocytes were able to survive through bioprinting process with a range of 70% to 79% viability ratio depending on choice of chemical cross-linking agent.

4.2 Preliminary Result of Urea Synthesis for Hepatocyte Function

A 3-day preliminary study was performed to investigate differential hepatocyte-specific function of urea synthesis in bioprinted 3D alginate encapsulated hepatocytes and 2D hepatocyte cell monolayer. The aim of this study was to evaluate the implications of a bioprinted 3D structure on a measure of hepatocyte-specific function, namely urea synthesis. The experimental setup for this study involved one experimental test sample and one control. The experimental test sample was the bioprinting of a 3D hepatocyte/alginate tissue construct. The control used was a 2D hepatocellular monolayer with the same cell density (175,000 cells/mL) as the test sample. In Figure 8, urea synthesis is quantitatively detected with a cell-based colorimetric assay, allowing comparison of time-dependent phenotype for bioprinted cell-encapsulated hepatocytes with controls cultured as a hepatocellular monolayer. Cell medium was replenished for both the test sample and control once per day. Each data point was an average of 5 samples taken at Days 1, 2, and 3 after bioprinting.

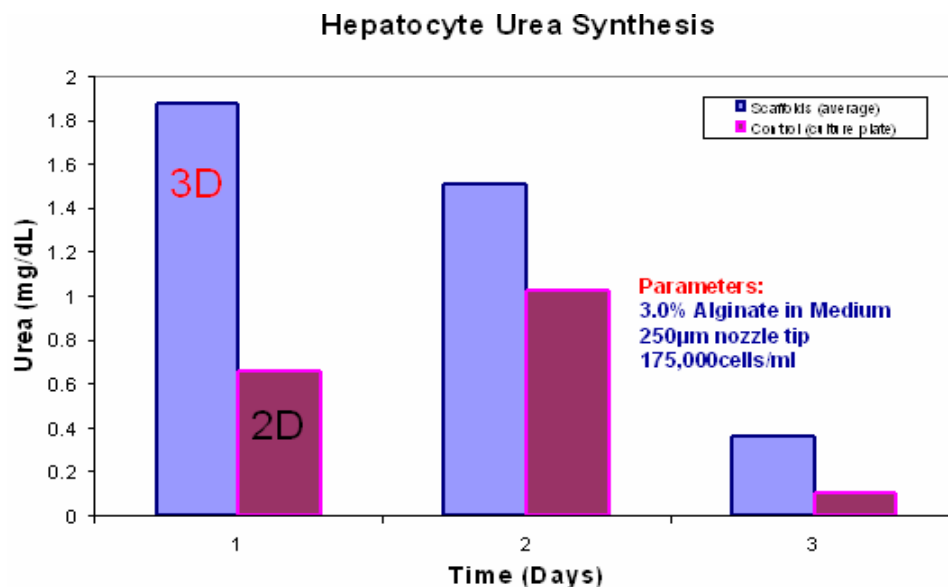

Figure 8: Results of 3-day Urea Synthesis Study of Bioprinted Alginate Tissue Constructs of Microencapsulated Hepatocytes

This data suggests that a hepatocytes encapsulated in a 3D alginate/hepatocyte tissue construct synthesizes a higher amount of urea than the same number of hepatocytes cultured as a 2D hepatocyte cell monolayer. This difference was most striking on Day 1, where the 3D tissue construct showed a marked urea concentration of 1.90mg/mL compared to a 2D hepatocyte cell

monolayer urea concentration of 0.65mg/mL. While the marked dropoff in urea synthesis at Day 3 was typical of *in vitro* culture, the 3D structure conferred an ability for increased urea production relative to the 2D monolayer case. Therefore, this demonstrated that the bioprinting process for microencapsulation of hepatocytes in 3D alginate tissue constructs was compatible with prolonged maintenance of hepatocellular specific function.

5. Discussion and Conclusions

Over the last four years, the development of integrated devices that combine cell culture and microfabrication makes the possibility of commercial applications to pharmaceutical evaluation a real possibility. The research undertaken herein rests on the premise and conviction that an *in vitro* model that can realistically and inexpensively test the response of humans and animals to various chemicals is needed. Such an *in vitro* system may serve to improve our ability to predict animal and human response to drug and chemical exposure. Process development of a proprietary bioprinting system to fabricate tissue construct for direct integration on a microfluidic chip will enable a novel creation of a tissue analog for pharmacokinetic study. Bioprinting tissue constructs with 3D architecture and microscale design features has been demonstrated for both feasibility and reproducibility. Cell viability tests showed that hepatocytes were able to survive through bioprinting process with a range of 70% to 79% viability ratio. Furthermore, biological assays for liver-specific function showed a conferred advantage of a 3D tissue construct over 2D cell monolayer for maintenance of cell-specific function. Ongoing research and study are being done to enhance feasibility of bioprinted 3-dimensional structural formation with reproducibility, integration of bioprinted tissue onto a microfluidic device with no leakage, cell viability, and maintenance of cell-specific function. By taking advantage of the unique bioprinting system capabilities, advanced research topics can be pursued in tissue engineering and its downstream applications, specifically pharmacokinetic study for drug screening and development. The potential impact of the tissue-engineered model physiological surrogate system developed herein will hinge on a deepened appreciation of the engineering and scientific basis for the fabrication as well as the relation with subsequent tissue pharmacokinetic behavior

References

1. Langer R. and Vacanti J.P., "Tissue Engineering", *Science*, 1993; 260: 920-6.
2. Lysaght M.J. and Reyes J., "The Growth of Tissue Engineering", *Tissue Engineering*, 2001; 7: 485.
3. Griffith L.G., "Polymeric Biomaterials", *Acta Materialia*, 2000; 48: 263-277.
4. Griffith L.G. and Naughton G., "Tissue Engineering--Current Challenges and Expanding Opportunities *Science*", 2002; 295: 1009-1014.
5. Powers M.J., Janigian D.M., Wack K.E., Baker C.S., Stolz D.B., and Griffith L.G., "Functional Behavior of Primary Rat Liver Cells in a Three-Dimensional Perfused Microarray Bioreactor", *Tissue Engineering*, 2002; 8: 499-513.
6. Powers M.J., Domansky K., Kaazempur-Mofrad M.R., Kalezi A., Capitano A., Upadhyaya A., Kurzawski P., Wack K.E., Stolz D.B., Kamm R., and Griffith L.G., "A Microfabricated Array Bioreactor for Perfused 3D Liver Culture", *Biotechnology and Bioengineering*, 2002; 78: 257-69.
7. Zeilinger K, Sauer I.M., Pless G., Strobel C., Rudzitis J., Wang A., Nüssler A.K., Grebe A., Mao L., Auth S.G.H., Unger J., Neuhaus P., and Gerlach J.C. "Three-dimensional

- Co-culture of Primary Human Liver Cells in Bioreactors for in vitro Drug Studies”, ATLA, 2002; 30: 525.
8. Viravaidya K., Sin A., and Shuler M.L. “Development of Microscale Cell Culture Analog to Probe Naphthalene Toxicity”, *Biotechnology Progress*, 2004; 20: 316-323.
 9. Shuler ML, Ghanem A, Quick D, Wong MC, and Miller P. “A Self-Regulating Cell Culture Analog Device to Mimic Animal and Human Toxicological Responses”, *Biotechnology and Bioengineering*, 1996; 52: 45-60.
 10. Ghanem A, Shuler ML. “Combining Cell Culture Analogue Reactor Designs and PBPK Models to Probe Mechanisms of Naphthalene Toxicity”, *Biotechnology Progress*, 2000; 16: 334-345.
 11. Knight, B, Laukaitis, C., Akhtar, N., Hotchin, N.A., Edlund, M., and Horwitz, A.F. “Visualizing Muscle Cell Migration”, *Current Biology*, 2000; 10:576-585.
 12. Roskelley, C.D., Desprez, P.Y., Bissell, M.J. “Extracellular matrix-dependent tissue-specific gene expression in mammary epithelial cells requires both physical and biochemical signal transduction”, *Proceedings National Academy of Sciences USA*, 1994; 91: 12378-12382.
 13. Mooney DJ, Sano K, Kaufmann PM, Majahod K, Schloo B, Vacanti JP, and Langer R. “Long-Term Culture of Hepatocytes Transplanted on Biodegradable Polymer Sponges” , *J. Biomed. Mater. Res.*, 1996; 37:413.
 14. Sun, W., Nam, J., Darling, A. and Khalil, S. “Method and apparatus of computer-aided tissue engineering for modeling, design and freeform fabrication of tissue scaffolds, constructs, and devices”, US Provisional Patent #: 60/520,6721 (2003); International Patent Application #: PCT/US2004/015316.
 15. Khalil, S., Name, J., Sun, W., “Multi-nozzle deposition for construction of 3D biopolymer tissue scaffolds”, *Rapid Prototyping Journal*, 2005; 11: 9-17.
 16. Khalil, S. and Sun, W., “Biopolymer Deposition for Freeform Fabrication of Hydrogel Tissue Constructs”, *J. of Materials Science and Engineering C*, in press.