

# Optimum Partitioning of a Phased-MIMO Radar Array Antenna

Ahmed Alieldin, *Student Member, IEEE*; Yi Huang, *Senior Member, IEEE*; and Walid M. Saad

**Abstract**—In a Phased-Multiple-Input-Multiple-Output (Phased-MIMO) radar the transmit antenna array is divided into multiple sub-arrays that are allowed to be overlapped. In this paper a mathematical formula for optimum partitioning scheme is derived to determine the optimum division of an array into sub-arrays and number of elements in each sub-array. The main concept of this new scheme is to place the transmit beam pattern nulls at the diversity beam pattern peak side lobes and place the diversity beam pattern nulls at the transmit beam pattern peak side lobes. This is compared with other equal and unequal schemes. It is shown that the main advantage of this optimum partitioning scheme is the improvement of the main-to-side lobe levels without reduction in beam pattern directivity. Also signal-to-noise ratio is improved using this optimum partitioning scheme.

**Index Terms**—Array antenna, coherent gain, diversity gain, optimum scheme, phased-MIMO, radar, side lobe level.

## I. INTRODUCTION

PHASED array antennas play a fundamental role in enhancing the gain, resolution and anti-jamming capability of radar systems [1]. The beam steering technique used in phased array antenna systems is the electronic beam steering. Usually, the electronic beam steering at a desired frequency is achieved by using phase shifters, power dividers and attenuators for every radiating element that forms the antenna array [2]. And the beam can be steered to the desired direction by controlling the phase shifts. It offers coherent transmit gain [3] that is useful for detecting/tracking targets and suppressing side lobe interferences from other directions [4]. The increasing demand for some emerging applications (such as 5G mobile systems) has driven the need for new and advanced antenna array technologies.

The emerging concept of multiple-input multiple-output (MIMO) radar has attracted researchers' interest [5]. Recently, two types of MIMO radar systems are being investigated: MIMO radars with widely-separated antennas and MIMO radars with collocated antennas. Both have many unique advantages, but also face many challenges [6-7]. The MIMO radar with collocated antennas, which is the point of interest in this paper, can exploit waveform diversity. This is important

as it can significantly improve system identification, target detection and parameters estimation performance when combined with adaptive arrays. It can also enhance transmit beam pattern design and use available space efficiently which is most suitable for airborne or ship-borne radars [7]. However, because the antennas are collocated, the main drawback is the loss of space diversity that is needed to mitigate the effect of target fluctuations. This problem could be solved using phased-MIMO radar [3]. But the main question is how to divide array elements into sub-arrays to achieve the optimum performance.

This paper proposes an optimum partitioning scheme for phased-MIMO radar and is organized as follows: Section II reviews related work to the proposed partitioning scheme while Section III introduces a new mathematical model for optimum partitioning of phased-MIMO arrays, the simulation results are obtained and compared with previous work. Finally, conclusions are drawn in Section IV.

## II. RELATED WORK

A new technique is proposed in [3] for MIMO radar with collocated antennas which called phased-MIMO radar. This technique enjoys the advantages of the MIMO radar (that offers the diversity processing gain) without sacrificing the main advantage of the phased-array radar (the coherent processing gain). But unfortunately, it neglected the effect of partitioning antenna elements on beam pattern parameters. In [8], a partitioning scheme for phased-MIMO array antenna was investigated but it is valid for an array which consists of an even number of elements ranging from 12 to 24, i.e. it is not a general formula. Furthermore, [9] gave a new partitioning scheme for a Hybrid Phased-MIMO Radar with Unequal Sub-arrays (HPMR-US) but with a complicated feeding structure.

In this paper, a new mathematical formula is proposed that optimizes the antenna element partitioning of phased-MIMO array antennas. This algorithm can determine the optimum number of sub-arrays within the antenna array and the number of elements in each sub-array. The proposed algorithm provides an optimum antenna element partitioning solution for phased-MIMO radar to achieve the minimum peak side lobes level (PSLL) without reduction in antenna gain. Also high output signal to interference plus noise ratio SINR is achieved

A beam can be formed by each sub-array towards a certain direction. The beam forming weight vector can be properly designed to maximize the coherent transmit processing gain.

Ahmed Alieldin and Yi Huang (corresponding author) are with the Department of Electrical Engineering and Electronics, The University of Liverpool, Liverpool, L69 3GJ, U.K. (e-mail: ahmed.alieldin@liv.ac.uk; yi.huang@liv.ac.uk)

Walid M. Saad is currently working in Egyptian Air Defense Technical Research and Development Center (e-mail: walid@sce.carleton.ca).

At the same time, different waveforms are transmitted by each sub-array. Each sub-array has a waveform  $\Phi_k$  orthogonal to other sub-array waveforms. This orthogonality offers a waveforms diversity gain. Coherent transmit gain [3] can be expressed as

$$C(\theta) = [W_1^H B_1, \dots, W_K^H B_K]^T \quad (1)$$

where  $B_k(\theta) = [b_1(\theta), b_2(\theta), \dots, b_{M_k}(\theta)]^T$  is transmit steering vector with size of  $M_k \times I$ ,  $W_k(\theta) = [w_1(\theta), w_2(\theta), \dots, w_{M_k}(\theta)]^T$  is  $M_k \times I$  beam forming vector which contains only elements corresponding to the active antennas of the  $k^{\text{th}}$  sub-array,  $b_{m_k}(\theta) = e^{-j\frac{2\pi}{\lambda}d(m_k-1)\sin(\theta)}$  is the phase shift between the signals at the 1<sup>st</sup> antenna and the  $m_k^{\text{th}}$  antenna for each sub-array due to spatial displacement,  $\theta$  is the aspect angle between target and radar boresight,  $w_{mk}$  is the complex weight of the  $m_k^{\text{th}}$  antenna,  $d$  is the displacement between two successive antennas and  $\lambda$  is the signal wave length. On the other hand, the diversity gain [3] can be expressed as

$$D(\theta) = [a_1(\theta), a_2(\theta), \dots, a_K(\theta)]^T \quad (2)$$

where  $a_k(\theta) = e^{-j\frac{2\pi}{\lambda}d(k-1)\sin(\theta)}$  is the phase shift between the signal at the 1<sup>st</sup> antenna of the array and the 1<sup>st</sup> antenna of the  $k^{\text{th}}$  sub-array due to spatial displacement. Both coherent transmit gain and diversity gain form the overall normalized overall gain as follows [3]

$$U(\theta) = (C(\theta) \odot D(\theta)) \otimes R(\theta) \quad (3)$$

where  $\odot$  is Hadamard product (element-wise product),  $\otimes$  is the Kronecker product and  $R(\theta)$  is  $S \times I$  received steering vector and  $S$  is the number of receivers. It is clear that  $U(\theta)$  is  $KS \times I$  virtual steering vector. Coherent, diversity and overall received gains depend on the number of sub-arrays  $K$ , and number of element in each sub-array  $M_k$ . Although dividing an array antenna with  $M$  elements into overlapping  $(M/2)-1$  sub-arrays with  $(M/2)+2$  elements in each sub-array provides, virtually, the maximum number of elements as mentioned in [8], this partitioning will not give the optimum beam pattern parameters. Hence, it is important to figure out the optimum partitioning values of  $K$  and  $M_k$ .

### III. NEW FORMULA FOR THE OPTIMUM PARTITIONING OF PHASED MIMO ANTENNA

In this section, a transmit array of  $M$  elements is divided into  $K$  sub-arrays which can be disjointed or overlapped, as shown in Fig. 1. Every transmit sub-array can be composed of any number of elements ranging from 1 to  $M$ . However, unlike the general phased-MIMO array discussed in the literature, in this paper we will partition the array into  $K$  sub-arrays with overlapping elements  $V$ , non-overlapping elements  $N$  in the first and last sub-arrays and non-overlapping elements  $N_l$  in the intermediate sub-arrays. The total number of element per each sub-array is

$$\begin{cases} M_k = N + V \\ N_l = N - V \end{cases} \quad (4)$$

Now let us consider an array with  $M$  elements and  $K$  sub-arrays each contains  $N$  (or  $N_l$  depending to its position) non-overlapping and  $V$  overlapping elements.  $V$  can vary from 0, i.e. no overlapping between sub-arrays which gives totally disjointed ones ( $M_k=N=N_l=M/K$ ), to  $M$  that gives a single array antenna ( $M_k=M; K=1$ ).

$K$  also can vary from  $M$  which indicates the whole antenna as one MIMO array antenna ( $M_k=N=N_l=1; V=0$ ), to 1 which refers to a single phased array antenna.

For better understanding of all the possible partitioning schemes for an array into  $K$  sub-arrays with equal  $M_k$  elements,  $M$  can be classified into  $2N$  (in both the 1<sup>st</sup> and last sub-arrays),  $(K-2)N_l$  (in the intermediate sub-arrays) and  $V(K-1)$  (total number of overlapped elements). Simply  $M$  can be expressed as

$$M = 2N + (K - 2)N_l + V(K - 1) \quad (5)$$

Substituting  $N_l$  in equation (5) with  $N-V$ , the possible partitioning values of  $K$  sub-arrays can be deduced as

$$K = \frac{M - V}{N} \quad K \text{ is an Integer} \quad (6)$$

So, there are a limited number of feasible partitioning schemes which can satisfy the condition of getting integer value of  $K$ . These partitioning schemes will be expressed in the form of  $(N, K, M_k)$ . For example, if  $M=20$ , the disjoint sub-arrays with  $V=0$  overlapping elements can be expressed as (1, 20, 1), (2, 10, 2), (4, 5, 4), (5, 4, 5), (10, 2, 10) or (20, 1, 20). Note that the first case indicates MIMO array antenna while the last case indicates a phased array antenna. For  $V=2$ , the array antenna can be divided in the form of (1, 18, 3), (2, 9, 4), (3, 6, 5), (6, 3, 8), (9, 2, 11), (18, 1, 20). Since then, we are eager to select the optimum partitioning scheme which gives optimum beam pattern parameters.

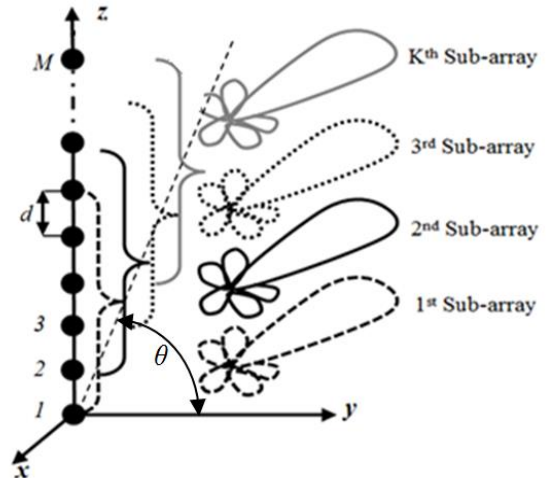

Fig. 1. Illustration of the phased-MIMO array.

We now consider an array antenna with  $M=72$ . Each two successive elements are separated by a distance of  $\lambda/2$ . Fig. 2 shows all possible partitioning values against PSLL. The infeasible partitioning schemes (which do not satisfy an integer value of  $K$  in equation (6)) are assumed to have 0 dB side lobes level. From Fig. 2, it is obvious that minimum value of PSLL occurs when

$$M_K = M - K + 1 \quad (7)$$

It is also clear that equation (6) offers a feasible physical partitioning scheme for any value of  $M$ . Substituting equations (7), (4) into (6), we have

$$\frac{M - V}{N} (N - 1) = N - 1 \quad (8)$$

From equation (8), there are 3 solutions which corresponding to cases for optimum division. Case (1):  $N=1$ ; i.e. there is only one non-overlapping element between adjacent sub-arrays ( $V=M_K-1$ ). Case (2):  $M=V+N=M_K$ ,  $K=1$  i.e. phased array antenna mode. Case (3)  $V=0$ ,  $M=N=M_K$  i.e. MIMO antenna mode. The second and third cases are neglected as they do not satisfy the phased-MIMO mode conditions so we are interested in case (1) only.

Fig. 3 illustrates the PSLL (in dB) against number of sub-arrays at  $N=1$  (Case (1)). Note that Fig. 3 is a section of Fig. 2 at the line that satisfies equation (7). Minimum PSLL (which equals to -31.22 dB) occurs at  $K=31$  and  $K=42$ . Thus, the optimum partitioning can be written in  $(N, K, M_K)$  form as  $(1, 31, 42)$  or  $(1, 42, 31)$ . Note that PSLL at  $K=1$  and  $M$  is -13.3 dB which is the PSLL for conventional phased array and MIMO antenna respectively

Fig. 4 illustrates different values of  $M$  as odd, even and multiple of 12. It can be estimated that the lowest PSLL occurs at  $(1, 27, 37)$  and  $(1, 37, 27)$  when  $M=63$  and it occurs at  $(1, 26, 37)$  and  $(1, 37, 26)$  when  $M=62$ . Finally, the lowest PSLL occurs at  $(1, 26, 35)$  and  $(1, 35, 26)$  when  $M=60$ . Note that  $K$  and  $M_K$  are reciprocal.

A general formula for Optimum Partitioning of Phased-MIMO array antenna (OPPM) can be expressed as

$$K = \left\lfloor \frac{M}{2} - \left\lfloor \frac{M-1}{12} \right\rfloor \right\rfloor \quad (9)$$

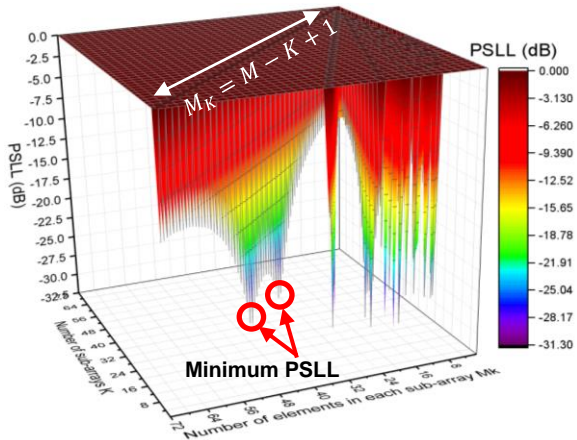

Fig. 2. PSLL for every possible partitioning of  $M=72$  Phased-MIMO array antennas

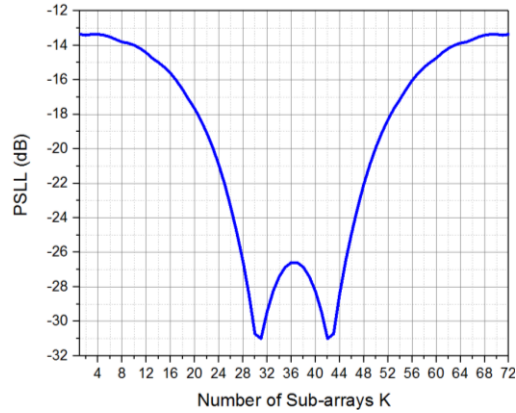

Fig. 3. PSLL against number of sub-arrays for  $M=72$

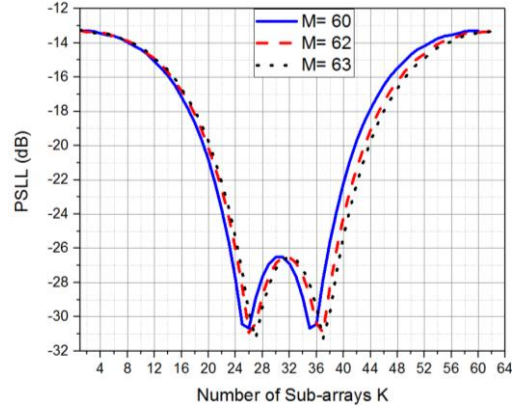

Fig. 4. PSLL against number of sub-arrays  $K$  at different values of  $M$ .

where  $\lceil X \rceil$  (ceiling  $X$ ) gets the closest upper integer value to  $X$  and  $\lfloor X \rfloor$  (floor of  $X$ ) gets the closest lower integer value to  $X$  for any real value of  $X$ .

OPPM formula given in equation (9) can be simplified for even values of  $M$ . Using properties of ceiling and floor functions, simplified OPPM formula can be expressed as

$$K = \left\lfloor \frac{5M + 1}{12} \right\rfloor \quad M: \text{even integer} \quad (10)$$

Substituting equation (10) into equation (7), simplified OPPM formula can be expressed as

$$M_K = \left\lfloor \frac{7M + 11}{12} \right\rfloor \quad M: \text{even integer} \quad (11)$$

Note that as  $K$  and  $M_K$  are reciprocal and their values can be switched, i.e. equation (10) can express the value of  $K$  when equation (11) expresses the value of  $M_K$  and vice versa.

For better understanding why equation (9) can express the OPPM, we will consider an array with  $M=40$ . According to equation (9), OPPM are  $(1, 17, 24)$  and  $(1, 24, 17)$ . Fig. 5 shows coherent, diversity and overall received beam patterns with the aid of equations (1), (2) and (3). It is clear that there are nulls in the coherent transmit beam pattern at the angles where the diversity beam pattern has its first side lobes and there are nulls in the diversity beam pattern at the angle where the coherent transmit beam pattern has its first side lobes. Placing nulls against side lobes in this way reduces the overall received beam pattern PSLL which is different from other partitioning scenarios.

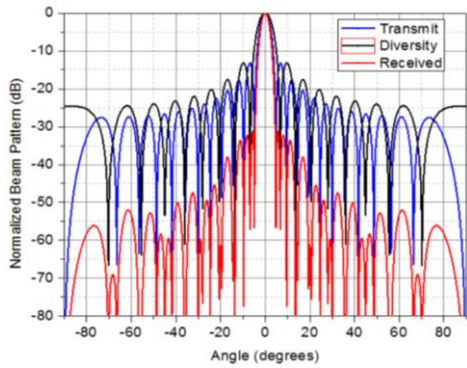

Fig. 5. Transmitted, Diversity and Received beam pattern at OPPM partitioning schemes ( $M=40$ )

For simplicity, we use the conventional transmitted/received beam forming technique and analyze the performance of the proposed OPPM in comparison with other schemes in [8] and [9]. Again using the previous example with  $M=40$ , Fig. 6 shows the received Phased-MIMO beam patterns for such an array at  $(M/2)-1$  partitioning scheme in [8], HPMR-US in [9] and proposed OPPM. It is indisputable that OPPM has the lowest PSLL without reduction in the half power beam width (antenna directivity is kept at the same level). Table 1 shows a comparison between [8], [9] and proposed OPPM in terms of PSLL and Directivity. It is clear that OPPM achieves the lowest PSLL without reduction in array directivity.

Generally, the received signal is accompanied with interference signals  $I$  and noise  $n$ . The SINR can be expressed as follows [8]

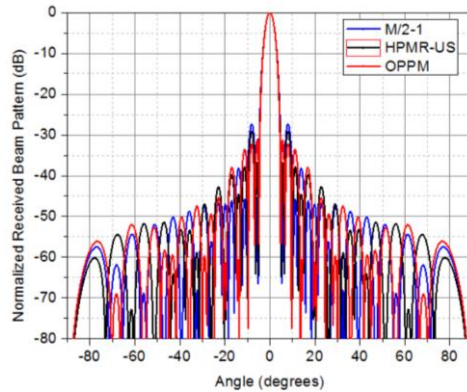

Fig. 6. Received Phased-MIMO beam patterns using  $(M/2)-1$ , HPMR-US and OPPM partitioning schemes ( $M=40$ )

TABLE I  
COMPARISON BETWEEN REFERENCE PARTITIONING SCHEMES AND PROPOSED OPPM IN PSLL AND DIRECTIVITY

M	PSLL (dB)			Directivity (dB)		
	[8]	[9]	OPPM	[8]	[9]	OPPM
10	-23.1	-26.0	<b>-26.0</b>	9.45	9.32	9.32
20	-29.9	-29.9	<b>-29.9</b>	12.2	12.2	12.2
30	-28	-30.5	<b>-31.4</b>	13.9	13.9	13.9
40	-27.3	-29.3	<b>-31.2</b>	15.	15.1	15.1
50	-27.0	-30.1	<b>-30.8</b>	16.	16	16.1
60	-26.9	-29.2	<b>-30.7</b>	16.8	16.8	16.9
70	-26.8	-28.3	<b>-31.2</b>	17.5	17.5	17.5
80	-26.8	-28.8	<b>-31.6</b>	18.	18.1	18.1
90	-26.7	-29.2	<b>-31.9</b>	18.5	18.6	18.7
100	-26.7	-28.8	<b>-31.8</b>	19	19	19.1

$$SINR = \frac{\binom{M}{K} \sigma_s^2 (M-K+1)^2 K^2 S^2}{\sum_{i=1}^I \binom{M}{K} \sigma_i^2 |U^H(\theta_s) U(\theta_i)|^2 + \sigma_n^2 (M-K+1) K S} \quad (12)$$

where  $\sigma_s$ ,  $\sigma_i$  and  $\sigma_n$  are the variances of the signal,  $i^{\text{th}}$  interference and noise respectively.  $\theta_s$  and  $\theta_i$  are the target and the  $i^{\text{th}}$  interfere angle respectively. Fig. 7 shows the output SINR against interference-to-noise ratio (INR). It is clear that OPPM has slightly higher output SINR than other partitioning schemes used in [8] and [9] when the interference signal level is lower than or comparable to the noise signal level. But when the INR goes higher, i.e. interference signal dominates; OPPM introduces much higher output SINR rather than other schemes

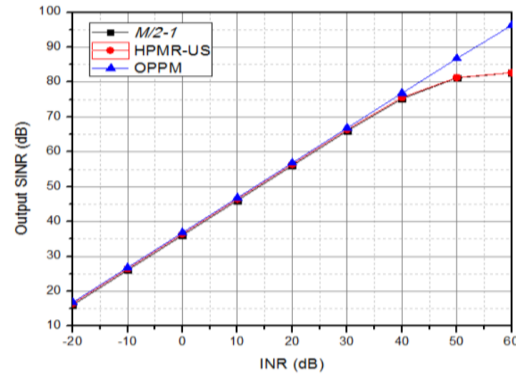

Fig. 7. Output SINR against INR at different partitioning schemes

#### IV. CONCLUSION

The paper has studied an optimum scheme for partitioning an array into a number of sub-arrays that are allowed to be overlapped. Then, some illustrative values of elements for Phased-MIMO array antenna are introduced and OPPM formula is deduced to get an optimum partitioning scheme at any number of elements. This optimum scheme improves peak side lobe level without sacrificing directivity comparing to any other division techniques. It also improves the output SINR.

#### REFERENCES

- [1] M. I. Skolnik, *Introduction to Radar Systems*, 3<sup>rd</sup> ed. New York, NY, USA: McGraw-Hill, 2001.
- [2] E. Brookner, "Phased Arrays Around the World - Progress and Future Trends," *IEEE International Symposium on Phased Array Systems and Technology, 2003*, pp. 1-8, 2003.
- [3] A. Hassanien and S. A. Vorobyov, "Phased-mimo radar: A tradeoff between phased-array and MIMO radars," *IEEE Trans. Signal Process.*, vol. 58, no. 6, pp. 3137-3151, Jun. 2010.
- [4] S. Haykin, J. Litva, and T. J. Shepherd, "Radar Array Processing". New York: Springer-Verlag, 1993
- [5] E. Fishler *et al.*, "MIMO radar: An idea whose time has come," in *Proc. IEEE Radar Conf., Philadelphia, PA, USA*, vol. 2, pp. 71-78, Apr. 2004.
- [6] A. Haimovich, R. Blum, and L. Cimini, "MIMO radar with widely separated antennas," *IEEE Signal Process. Mag.*, vol. 25, pp. 116-129, Jan. 2008.
- [7] J. Li and P. Stoica, "MIMO radar with colocated antennas," *IEEE Signal Process. Mag.*, vol. 24, no. 5, pp. 106-114, Sep. 2007.
- [8] N. El-Din Ismail, S. H. Mahmoud, A. S. Hafez and T. Reda, "A New Phased MIMO Radar Partitioning Schemes," *2014 IEEE Aerospace Conference, Big Sky, MT*, pp. 1-7, 2014.
- [9] W. Khan, I. M. Qureshi, A. Basit and M. Zubair, "Hybrid Phased MIMO Radar with Unequal Sub-arrays," in *IEEE Antennas and Wireless Propagation Letters*, vol. 14, pp. 1702-1705, 2015.